

Edition 2.4.1  
20 March 2018

# Encoding Guide for Inland ENCs

# Contents

## General

### A - Introduction

### B - General Guidance

### C - IENC Meta Information

#### C.1 Meta Features

C.1.1 Data Coverage

C.1.2 Data Quality

C.1.3 Navigation System of Marks

C.1.4 Sounding Datum

C.1.5 Vertical Datum

C.1.6 Quality of Data for Detailed Depth Information

C.1.7 Survey Reliability for Detailed Depth Information

C.1.8 Nautical Publication Information

## Geography

### D - Natural Features

#### D.1 Hydrology

D.1.1 Canal (non-navigable)

D.1.2 Rivers (non-navigable)

D.1.3 Named Water Area

D.1.4 Dredging Lake

D.1.5 Lake

#### D.2 Topography

D.2.1 Land Area

D.2.2 Land Region

D.2.3 Natural Dunes or Ridges

D.2.4 Rock Wall

D.2.5 Shoreline

#### D.3 Vegetation

D.3.1 Vegetation

### E - Cultural Features

#### E.1 Settlements, Buildings, Political Boundaries

E.1.1 Built-up Areas

E.1.2 Buildings of Navigational Significance

E.1.3 International Boundaries & National Limits (Administration Area)

## E.2 Airfields, Railways, Roads

E.2.1 Airport

E.2.2 Railway

E.2.3 Road

E.2.4 Runway

## E.3 Other Cultural Features

E.3.1 Silo / Storage Tank

E.3.2 Embankment

## **F - Landmarks**

### F.1 Landmarks

F.1.1 Conspicuous Landmark

## **G - Ports, Waterways**

### G.1 Bridges, Tunnels, Overhead Obstructions

G.1.1 Bascule Bridge

G.1.2 Bridges with Bridge Arches

G.1.3 Fixed Bridge

G.1.4 Lift Bridge

G.1.5 Suspension Bridge

G.1.6 Swing Bridge

G.1.7 Tunnel

G.1.8 Overhead Cable

G.1.9 Overhead Pipe

G.1.10 Pylons, Piers, and Bridge, Cable, Pipeline Support

G.1.11 Foot Bridge / Catwalk

G.1.12 Retractable (Draw) Bridge

### G.2 Hydraulic Structures in General

G.2.1 Dyke / Levee

G.2.2 Fence / Floodwall

G.2.3 Groin

G.2.4 Ground Sill

G.2.5 Revetment

G.2.6 Revetment (Concrete Mattress) (Refer to G.2.5 Revetment)

G.2.7 Training Wall

### G.3 Installations

G.3.1 Boat Ramp

G.3.2 Bunker / Fueling Station

G.3.3 Conveyor

- G.3.4 Crane
- G.3.5 Dock / Wharf
- G.3.6 Dry Dock
- G.3.7 Floating Dock
- G.3.8 Fender
- G.3.9 Harbor Area
- G.3.10 Harbor Basin
- G.3.11 Landing Stage, Pontoon
- G.3.12 Mooring Facility
- G.3.13 Federal Mooring Facility
- G.3.14 Permanently Moored Vessel or Facility
- G.3.15 Port Area
- G.3.16 Free Port Area
- G.3.17 Refuse Dump
- G.3.18 Slipway
- G.3.19 Terminal
- G.3.20 Vehicle Transfer Location
- G.3.21 Landing Steps, Ladders
- G.3.22 Production / Storage Area
- G.3.23 Ice Breaker
- G.3.24 Pile or Post
- G.3.25 Water Intake Structure
- G.3.26 Power Supply Station

#### G.4 Locks, Barrages, Exceptional Navigational Structures

- G.4.1 Arrival Point
- G.4.2 Dam / Barrier
- G.4.3 Lock Basin
- G.4.4 Lock Basin Part
- G.4.5 Lock Gate
- G.4.6 Lock Name
- G.4.7 Lock Wall
- G.4.8 Exceptional Navigational Structure
- G.4.9 Opening Barrage

## Hydrography

### H - Currents

- H.1 Currents
  - H.1.1 Current
  - H.1.2 Water Turbulence

## **I - Depths**

### I.1 Depths in Fairways and Areas

- I.1.1 Detailed Depth - referenced to one water level
- I.1.2 Detailed Depth - water level model
- I.1.3 Dredged Area
- I.1.4 Fairway
- I.1.5 Fairway Depth / Project Depth
- I.1.6 Low / High Water Range (Drying Height)
- I.1.7 Shallow Depth
- I.1.8 Soundings
- I.1.9 Unsurveyed Area

### I.2 Depth Contours

- I.2.1 Depth Contour

### I.3 Depth References

- I.3.1 Depth Indicator
- I.3.2 High Water Mark
- I.3.3 Vertical Clearance Indicator
- I.3.4 Waterway Gauge
- I.3.5 Waterway Profile

## **J - Rocks, Wrecks, Obstructions and Nature of Riverbed**

### J.1 Rocks

- J.1.1 Rocks

### J.2 Wrecks

- J.2.1 Wrecks

### J.3 Obstructions

- J.3.1 Obstruction
- J.3.2 Oil Barrier

### J.4 Nature of Riverbed

- J.4.1 Nature of Bottom

## **K - Offshore Installations**

### K.1 Submarine Cables

- K.1.1 Submarine Cable
- K.1.2 Submarine Cable Area

### K.2 Submarine Pipelines

- K.2.1 Submarine Pipeline
- K.2.2 Submarine Pipeline Area

## **L - Tracks, Routes**

### L.1 Tracks

- L.1.1 Navigation Line
- L.1.2 Sailing Line / Recommended Track
- L.1.3 Two-way Route Part
- L.1.4 Waterway Axis
- L.1.5 Traffic Separation Zone

### L.2 Ferries

- L.2.1 Cable Ferry
- L.2.2 Free Moving Ferry
- L.2.3 Swinging Wire Ferry

### L.3 Supplemental Navigation References

- L.3.1 CEMT Classification, ISRS Location Code
- L.3.2 Distance Mark Along Waterway Axis
- L.3.3 Distance Mark Ashore

## **M - Areas, Limits**

### M.1 Anchorage Areas and Berths

- M.1.1 Anchorage Area
- M.1.2 Anchorage Berth
- M.1.3 Berth without Transshipment / Fleeting Areas
- M.1.4 Transshipment Berth

### M.2 Restricted Areas

- M.2.1 Restricted Area

### M.3 Caution Areas

- M.3.1 Caution Area

### M.4 Miscellaneous Areas / Limits

- M.4.1 Communication Area
- M.4.2 River Surveillance Area
- M.4.3 Section of Limited Depth
- M.4.4 Section of Limited Width
- M.4.5 Turning Basin
- M.4.6 Dumping Ground
- M.4.7 Marine Farm/Culture

## **Aids and Services**

### **N - Lights**

#### N.1 Light Structures

- N.1.1 Bridge Light
- N.1.2 Minor Light
- N.1.3 Leading Light
- N.1.4 Directional Light
- N.1.5 Sector Light

## **O - Buoys, Beacons and Daymarks, Notice Marks**

### O.1 Buoys

- O.1.1 Buoy at Bifurcation of Channel
- O.1.2 Buoy at Bridge Pillar
- O.1.3 Buoy Marking Danger Point
- O.1.4 Cardinal Buoy
- O.1.5 Lateral Buoy
- O.1.6 Safe Water Buoy
- O.1.7 Stalling Buoy
- O.1.8 Swinging Axial Buoy
- O.1.9 Swinging Lateral Buoy
- O.1.10 Isolated Danger Buoy
- O.1.11 Virtual AIS Aids to Navigation

### O.2 Beacons & Daymarks

- O.2.1 Day Mark
- O.2.2 Landmark Beacon
- O.2.3 Radar Beacon, RACON
- O.2.4 Spring Flood Beacon
- O.2.5 Isolated Danger Beacon
- O.2.6 Change Bank
- O.2.7 Continue Along Bank
- O.2.8 Touch and Go

### O.3 Notice Marks

- O.3.1 Notice Marks
- O.3.2 Notice Marks on Bridges
- O.3.3 Wreck Pontoon

### O.4 IALA Maritime Buoyage System

- O.4.1 Special Purpose Buoy IALA

## **P - Fog Signals**

### P.1 Fog Signal

- P.1.1 Fog Signal

## **Q - Radar, Radio, Electronic Positioning**

## Q.1 Radar

### Q.1.1 Radar Station

## Q.2 Radio

### Q.2.1 Radio Calling-in Point

## **R - Services**

### R.1 Check Points

#### R.1.1 Check Point

### R.2 Signal Stations

#### R.2.1 Traffic Signal Station - Bridge Passage

#### R.2.2 Traffic Signal Station - Lock

#### R.2.3 Traffic Signal Station - Oncoming Traffic Indicator

#### R.2.4 Traffic Signal Station - Port Entry and Departure

### R.3 Rescue Stations

#### R.3.1 Rescue Station

### R.4 Sensors

#### R.4.1 Sensor

## **S - Small Craft Facilities**

### S.1 Marinas and Other Facilities

#### S.1.1 Harbor Facilities

#### S.1.2 Marina

#### S.1.3 Small Craft Facility

## **T - Time and Behaviour**

### T.1 Schedules

#### T.1.1 Time Schedule (general)

## **U - Legal ECDIS**

### U.1 Maximum Dimensions, Speed

#### U.1.1 Maximum Permitted Ship Dimensions

#### U.1.2 Maximum Permitted Vessel Speed

## **Alphabetical Indices**

### **V - Abbreviations**

### **W - Naming Conventions**

### **X - References**

### **Y - Regions**

### **Z - Record of Changes**



## **Annexes**

**AA - Notice Marks (CEVNI)**

**AB - Notice Marks (Russian Inland Waterway Regulations)**

**AC - Notice Marks (Brazilian Two Sides System)**

**AD - Notice Marks (Brazilian Side Independent System)**

**AE - Notice Marks (Brazilian Paraguay-Parana Waterway)**

**AF - XML Definition**

## A. Introduction

### Background

Based on the findings of the European transport R&D project *INDRIS* (Inland Navigation Demonstrator for River Information Services) and the German project *ARGO* in 2001, both the Danube and the Rhine Commissions adopted an Inland Electronic Chart Display and Information Systems (ECDIS) standard for Electronic Navigational Chart (ENC) data and system requirements for the Rhine and the Danube Rivers. In 2001, the Economic Commission for Europe of the United Nations (UN ECE) adopted the Inland ECDIS Standard as a recommendation for the European inland waterway system (CCNR 2002).

In the USA, following a 1999 recommendation by the National Transportation Safety Board, the U.S. Army Corps of Engineers (USACE) initiated a program to facilitate the production and implementation of Inland ENCs on major river and inland waterway systems in the United States.

While there are some differences between the North American and European inland waterways, there are far more similarities. A North American - European Inland ENC Workshop was held in 2003 in conjunction with a Conference on River Information Services (RIS) organized by the European R&D-project *COMPRIS* (Consortium Operational Management Platform River Information Services). In addition to informing participants on the status of standards development and projects being conducted, a key objective was to discuss the benefits of harmonizing Inland ENC data standards between Europe and North America.

The North American - European Inland ENC Harmonization Group (IEHG) was formed in 2003 to facilitate the development of international standards for Inland ENC data. The IEHG is comprised of representatives from government, industry and academia. European participants take part on behalf of the European Inland ECDIS Expert Group. The North American participants are members of the North American Inland ENC Ad Hoc working group that was formed in 2002. The IEHG meets once per year. However, most of the work is accomplished via e-mail correspondence and the website <http://ienc.openecd.org>.

The goal of the IEHG is to agree upon specifications for Inland ENCs that are suitable for all known inland ENC data requirements for safe and efficient navigation for European and North American inland waterways. However, it is intended that this standard meets the basic needs for Inland ENC applications, worldwide. As such, the Inland ENC standard is flexible enough to accommodate additional inland waterway requirements in other regions of the world.

In September 2005, the Ministry of Transport of the Russian Federation became a member of the IEHG. In 2007, Brazil through its national Hydrographic Service, the Directorate of Hydrography and Navigation (DHN), joined the IEHG as the first South American country. In October 2009, the Waterborne Transportation Institute of the Ministry of Transport, Peoples Republic of China became the first member of the IEHG from the Asian region.

IEHG also works closely with the International Hydrographic Organization (IHO). At the ECDIS stakeholders' forum in 2007, IHO confirmed that compatibility with Inland ENC standards is allowed by the standards that are certified for maritime ECDIS applications. On 14 April 2009, IEHG became recognized as a Non-Governmental International Organization (NGIO) of IHO. In addition, at the 4th Extraordinary International Hydrographic Conference on 4 June 2009, IHO adopted a resolution to cooperate with the IEHG.

As an NGIO, IEHG supports, advises and provides input to IHO regarding Inland ENC matters. Specifically, IEHG attends:

- Hydrographic Services and Standards Committee (HSSC)
- Transfer Standard Maintenance and Application Development (TSMAD) WG

### Inland Electronic Navigational Chart Defined

Inland Electronic Navigational Chart (IENC) means: *the database, standardized as to content, structure and format, for use with inland electronic chart display and / or information systems operated onboard of vessels transiting inland waterways. An IENC is issued by or on the authority of a competent government agency, and conforms to standards [initially] developed by the International Hydrographic Organization (IHO) and [refined by] the Inland ENC Harmonization Group. An IENC contains all the chart information necessary for safe navigation on inland waterways and may contain supplementary information in addition to that contained in the paper chart (e.g. sailing directions, machine-readable operating schedules, etc.) which may be considered necessary for safe navigation and voyage planning.*

## IENC Standards

The framework for Inland ENC standards includes:

1. Use of **IHO S-57** (Edition 3.1), including:
  - 'Maritime' ENC Product Specification (Appendix B1)
  - Object Catalogue (Appendix A)
  - Use of Object Catalogue (Appendix B.1, Annex A)
2. A minimum **Inland ENC Product Specification** that includes mandatory requirements for safety-of-navigation on inland waterways, worldwide.
3. An **Inland ENC Encoding Guide** that provides guidance on recommended object classes, attributes, and attribute values for encoding IENC data.
4. Inland ENC **Feature Catalogue**.
5. Establishment of an **Inland ENC Register** for additional real-world, IENC features, attributes, and enumerations that are not already contained in IHO S-57 Edition 3.1 Object Catalogue.
6. Use of the **ienc.openecdis.org** as a means of communication, and as an interim means to register additional Inland ENC object classes, attributes, and attributes values.
7. Align with the **IHO S-100** Universal Hydrographic Data Model. In particular, this includes the Inland ENC Register as part of the overall S-100 Geospatial Information Registry.

As of February 2011, the current versions of IENC-related standards are:

IENC Product Specification, Ed. 2.3 (February 2011)  
Feature Catalogue, Ed. 2.3 (February 2011)  
**IENC Encoding Guide, Ed. 2.3.0 (February 2011)**

Two other Inland IENC-related standards that are not maintained by IEHG, but are used in Europe include:

Inland ECDIS Standard, Ed. 2.2  
IENC Presentation Library, Ed. 2.2

[Note: Both are under revision and will be posted on the IEHG website when available].

Copies of all IENC-related standards available at: <http://ienc.openecdis.org>.

## IENC Encoding Guide

The IENC Encoding Guide provides detailed guidance on what is required to produce a consistent, uniform Inland ENC.

For all object classes, attributes, and attribute values that are used in conjunction with an IENC, the IENC Encoding Guide:

1. Provides a basis for its creation
2. Describes its relationship to the real-world entity
3. Provides criteria for its proper use
4. Gives specific encoding examples
5. Provides real-world and graphic examples of IENC information (portrayal)

### Minimum Contents of an IENC

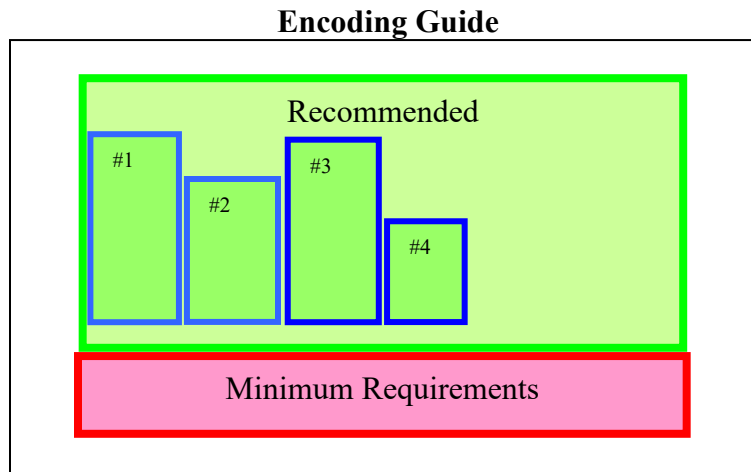
At a **Minimum**, the following objects shall be included in an IENC, if they exist:

1. Bank of waterway
2. Shoreline construction (e.g., groin, training wall)
3. Any facility that is considered a hazard to navigation
4. Contours of locks and dams (i.e., footprint area)
5. Boundaries of the navigation channel (if defined)
6. Isolated dangers in the navigation channel that are either:
  - a) under water (obstructions)
  - b) above water level (e.g., bridges, overhead cables)
7. Official Aids-to-Navigation (e.g. buoys, beacons, lights, notice marks)
8. Waterway axis with kilometres/hectometres

In addition to these minimum requirements, the Encoding Guide contains **recommended** objects, attributes and attribute values that are suitable for any Inland ENC application, worldwide. Each country or region can decide which of these recommended objects, attributes and attribute values are necessary to meet their requirements. For example, in Europe and the USA, there are different requirements for River Information Services (RIS). (See

diagram below for reference.)

When the competent authorities in Europe define the “navigable water” for their individual waterways they should take into account water areas which can be used at mean water level by vessels with a hull length of 20m or more that are typically used on these waterways. Water areas on which navigation is prohibited are not “navigable water”. If an object which is minimum content when it is situated in navigable water is situated outside of the navigable water, it is recommended to encode it.



#1 = additional requirements of river system for region 1  
#2 = additional requirements of river system for region 2  
#3, #4, etc.

### Changes to the IENC Encoding Guide

The IENC Encoding Guide is a living document that can be modified, as needed, to accommodate future Inland ENC requirements and development, worldwide. As such, two basic procedures have been established for making changes to the document.

#### **Procedure A:** Proposals for copied and new object classes, attributes and attribute values

Proposals for copied and new object classes, attributes and attribute values need a formal decision by IEHG according to the following steps:

1. Prior to submitting a proposal, it is necessary to check whether an existing S-57 object, attribute or attribute value can be used. If a new object, attribute or attribute value is needed, the proposed acronym should be registered on the IEHG/S-100 Register to ensure that there is no duplication of acronyms.
2. Publication of the proposal, including the necessary changes in the Encoding Guide, should be posted on the IEHG Discussion Forum. [<http://operations.usace.army.mil/nav/IEHG/start.cfm?Option=Login>].
3. Discussion and decision at a meeting of the IEHG.

#### **Procedure B:** Proposals for all the other changes and amendments

Proposals for other types of changes and amendments (e.g., additional pictures, coding instructions, or object coding using already existing object classes, attributes and attribute values) are decided upon using the following steps:

1. Posting of the proposal (using the proposal form) on the IEHG discussion forum on the OEF by a member of the IEHG. [<http://operations.usace.army.mil/nav/IEHG/start.cfm?Option=Login>].
2. If there are recommendations on how to improve the proposal, the amended proposal is regarded as a new one.
3. If there is no veto within six (6) weeks, the amendment is considered adopted. It then:
  - a. Is included in the working version of the Encoding Guide that is available on the OEF

- b. Can be used by everyone
  - c. Will be included in the next official edition of the Encoding Guide
4. If there is a veto, the proposal will be further discussed and decided upon at the next meeting of the IEHG.

Decisions of the IEHG in accordance with Procedure A may result in issuing a new edition of the Encoding Guide and Product Specification for Inland ENC's (e.g., Edition 2.2.0 → Edition 2.3.0). Decision in accordance with Procedure B do not require new edition of the IENC Production Specification, and will be considered version to an existing Edition (Edition 2.2.0 → 2.2.1). The current edition as well as the latest version will both be available at <http://ienc.openecdis.org>, together with a history of changes.



### A. Features & Attributes: Mandatory, Conditional, Optional

Each feature class and attribute class in the harmonization guide has been classified for encoding purposes as mandatory, conditional or optional.

- Mandatory (M) features or attributes must be encoded. For attributes, if the value is not known, it must be coded as UNKNOWN.
- Conditional (C) features or attributes are mandatory (must be encoded) if defined conditions are met (e.g. if a feature has multiple colours, a colour pattern must be encoded). If the defined conditions are not met, the features or attributes are Optional (O).
- Optional (O) features or attributes should be encoded if the value is known.

### B. Attribute Classes Associated With All Geo Object Classes

The following attribute classes can be associated with all geo object classes in an IENC:

#### **SORIND**

US: The source indicator is a mandatory attribute and must be coded for all objects in the IENC. All objects in the Encoding Guide state that SORIND is Conditional (C); the condition that must be met is that it is a US produced chart.

The format is: 2 character country code, 2 character authority code, 5 character source code, identifier (no restriction on number of characters).

- Examples:
  - For navigation features reference an authority such as the USCG Mississippi River System Light List, Volume 5: (US,U3,MS\_LL,2004\_Edition\_No.808)
  - For hydrographic features reference appropriate survey: (US,U3,SURVY,2001\_Hydro\_Survey)
  - For other features reference appropriate survey data: (US,U3,SURVY,1999\_Aerial\_Survey)

EU: The source indicator must only be coded for an object in an IENC when the source is different from the producer of the IENC and the producer wants to exclude liability.

The format is: 2 character country code, other codes (no restriction on number of characters). All other coding is at the decision of the local authority.

BR: SORIND is an optional attribute which may be used for an object in an IENC when the source is different from the producer of the IENC.

The format is: 2 character country code, description of the responsible authority (no restriction on number of characters).

#### **SORDAT**

The production date of the source of the data (e.g. the date of measurement). The source date should be coded for those objects in an IENC, which are changing regularly, for example depth information.

The format is yearmonthday (YYYYMMDD).

- Example:
  - SORDAT coding for a feature with of source date of September 30, 2004 is 20040930

US: SORDAT is a mandatory attribute and must be coded for all objects in the IENC. SORDAT should be set to the release date of the chart if the actual source dates of the data unavailable.

EU: SORDAT for other objects it might be set to "unknown".

BR: SORDAT is optional.

**OBJNAM**

Use to code feature's name (do not include information on characteristics of feature). Name must be in Title Case. Use abbreviations where possible. Use short names only to avoid clutter in the display. OBJNAM shall be entered in local language using Basic Latin Unicode characters, e.g. Baarlerbruecke, Volkeraksluis or Wien.

**NOBJNM**

Whenever OBJNAM is used, it is also possible to use NOBJNM. NOBJNM may be used for names in the National Language, for example, Cyrillic characters.

**INFORM**

Use to code navigationally significant information about the feature that cannot be coded by attributes. INFORM should always be in English.

**NINFOM**

Whenever INFORM is used, it is also possible to use NINFOM. INFORM should always be in English, whereas NINFOM may be used for the National Language, for example, Cyrillic characters.

**TXTDSC**

Use to link textual descriptions or feature information in an ASCII file. For object names within the TXTDSC file, the same rules as for the attribute OBJNAM are applicable. Free text within the TXTDSC file should be provided in English language.

Note that filename must be in UPPER CASE.

US: Format is AARRMMXNN.EXT where:

AA = 2-character Producer Code

RR = 2-character river code

MMM = 3-digit river mile or river km, 000-999

X = tenth of river mile/km; preceding decimal point implied; use zero if river mile/km known only to the nearest mile.

NN = 01-99; unique identifier for text file at the particular river mile/km.

For example, if three TXTDSC files exist at the same river mile/km, 01, 02, and 03 would be used.

EXT = 3-character file extension for Hypertext Metafile (HTM), ASCII text (TXT), or Standardized External XML file with communication information.

EU: The ISRS Location Code can be used for the file name, e.g. DEXXX03900000005023.XML.

**NTXTDS**

Use to link textual descriptions or feature information in the national language (if the national language is not English) in an ASCII file. For object names within the NTXTDS file, the same rules as for the attribute NOBJNM are applicable. Free text within the NTXTDS file should be provided in the national language.

Note that filename must be in UPPER CASE.

EU: The two letter language code can be added to the file name, e.g. DEXXX03900000005023DE.XML

**PICREP**

Use to link imagery related to feature. Note that the filename must be in UPPER CASE. Image should be 640 x 480 pixels in resolution.

Format is AARRMMXNN.EXT, where:

AA = 2-character Producer Code

RR = 2-character river code

MMM = 3-digit river mile or river km, 000-999

X = tenth of river mile/km; preceding decimal point implied; use zero if river mile/km known only to the nearest mile.

NN = 01-99; unique identifier for image file at the particular river mile/km.

For example, if three PICREP files exist at the same river mile/km, 01, 02, and 03 would be used.

EXT = 3-character file extension for the image file format; most commonly TIFF (TIF) or JPEG (JPG) formats.

## C. Scale Minimum

The values for the scale minimum mentioned in the encoding guide are recommendations for European and N. American waterways. The chart producer might deviate from these values in order to improve the chart display in special situations, for example on very small or very large waterways. The value of SCAMIN has to be set to a scale value smaller than or equal to the compilation scale of the data for the area.

## D. Numeric Precision

Numeric attributes indicating meters (e.g., depth contours and structure heights) should reflect the accuracy of the number. For example, a bridge height of thirty-five meters, accurate to one meter, would be 35, not 35.0. No more than two decimal places should be used. Real values without safety margins should be used. The S-57 standard only supports depth contour resolutions to 0.1 meter.

## E. Feature Naming and Text Display

US: Any important navigation notes that should always be shown on the IENC should be encoded as LNDRGN (P) on land or SEAARE (P) objects in the water.

EU: Use the appropriate object to display information (e.g. comare).

## F. Assigning Approximate Positions

To assign an approximate position ('PA') for charted features, the attribute Quality of Position [QUAPOS = 4 (approximate)] is assigned to the appropriate spatial object (point or line). It is not assigned to the feature object (e.g. WRECKS object), but to the spatial reference for the feature object. When correctly coded, the electronic chart system will display 'PA' adjacent to the feature object.

## G. Navigational Purpose

The following types of Navigational Purpose ("usage") are available:

Subfield	Navigational purpose	Definition for intended use
1	Overview:	For route planning and oceanic crossing.
2	General:	For navigating oceans, approaching coasts and route planning.
3	Coastal:	For navigating along the coastline, either inshore or offshore.
4	Approach:	Navigating the approaches to ports or mayor channels or through intricate or congested waters.
5	Harbour:	Navigating within ports, harbours, bays, rivers and canals, for anchorages.
6	Berthing:	Detailed data to aid berthing.
7	<b>River:</b>	<b>Navigating the inland waterways (skin cell).</b>
8	<b>River harbour:</b>	<b>Navigating within ports and harbours on inland waterways (skin cell).</b>
9	<b>River berthing:</b>	<b>Detailed data to aid berthing maneuvering in inland navigation (skin cell).</b>
A	<b>Overlay:</b>	<b>Overlay cell to be displayed in conjunction with skin cells</b>

The Navigational Purposes 1 to 8 may be used by authorities as well as private bodies. Navigational Purpose 9 may only be used by private bodies. Overlay cells may be used by authorities as well as private bodies.

Within overlapping cells with the same navigational purpose skin-of-the-earth objects of the same object class must not overlap.

The letter "A" at the third position of the file name indicates that the cell is displayed as overlay over other cells



within a range of usages. Overlay cells may not contain skin-of-the-earth objects. The range of usages of overlay cells is indicated in the Data Set Identification Field of the header of the overlay cell (see S57, Part 3, Data Structure, ch. 7.3.1.1). The 8th bit of the intended usage subfield (INTU) has to be set, if a range is used and the other seven bits describe the range (e.g. 25 means a range from usage 2 to usage 5).

## H. UN Location Code

The attribute 'unlocd' should be used to encode the UN Location Code (<http://www.unece.org/cefact/locode/service/main.htm>) or, in Europe, the Inland Ship Reporting Standard (ISRS) Location Code; which is used to establish a standardized relation to other River Information Services.

UN country code (2 digits),

UN Location code (3 digits, "XXX" if not available),

Fairway section number (5 alphanumerical digits, to be determined by the national authority; a side branch should have its own section number, when there are special restrictions, e.g. bridges),

Object Reference Code (5 alphanumerical digits, "00000" if not available),

Fairway section hectometre (5 numerical digits, hectometre at the center of the area or "00000" if not available).

If the ISRS Location Code is not available, the code of the Noordersoft RIS-Index may be used.

## I. Legal ECDIS (refers to Section U)

Category attributes for ship types, ship formations and cargo type are available. These categories are used to describe for which type of ship, convoy, or cargo the particular regulation is valid. There are two ways of describing which categories are affected by the rule:

1. explicit selection
2. implicit selection

The attributes for explicit type selection are used to explicitly select the types from the given list. The attributes for implicit type selection are used to select those types that are not affected.

It is up to the encoder if the explicit attribute or its implicit version is used. However, it is **not allowed** to use both attributes when defining the category of a law content object.

One would make use of implicit type selection if for example the respective regulation states which types are excluded from the regulation rather than explicitly listing those types that are affected.

Example: "recreational crafts are excluded from a speed limit."

## J. DATSTA, DATEND, PERSTA and PEREND

For objects, which are installed for a specific time, the date start and date end should be encoded using the DATSTA and DATEND attributes. In case of periodic installation (for example in the summer time each year) the attributes periodic start PERSTA and periodic end PEREND should be used.

The attributes should be encoded using 4 digits for the calendar year (CCYY), 2 digits for the month (MM) (e.g. April = 04) and 2 digits for the day (DD), according to ISO 8601: 1988.

Format is: CCYYMMDD (mandatory), for example: 19960822 for 22 August 1996.

These attributes may not be used for Group I feature classes.

## K. Collection Features Extending Beyond Cell Boundaries

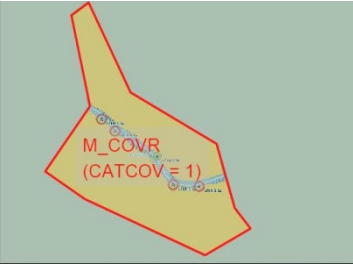
If a collection feature extends beyond a cell boundary (i.e. the features that make up the collection are spread over multiple cells), the collection feature should be repeated in each cell that contains one or more component features. However, only the features that exist in the cell that contains the instance of the collection feature can be referenced by that collection feature. If this technique is used, each instance of the original collection feature must have the same feature identifier (LNAM). It is up to the application (e.g. the Inland ECDIS or ECS) that uses the cells to rebuild the complete collection feature based on the unique feature identifier.

# C - IENC Meta Information

## C.1 Meta Features

### C.1.1 Data Coverage (M)

A geographical area that describes the coverage and extent of the spatial objects. (S-57 Standard)


Graphics	Encoding Instructions	Object Encoding
<p><i>IENC Symbolization</i></p> 	<p>A) All spatial objects in an IENC must be covered by a M_COVR, CATCOV=1 (coverage available) area object.</p> <p>B) US &amp; RU: The use of CATCOV=2 (no coverage available) is required</p> <p>C) EU: The use of CATCOV=2 is optional</p>	<p><b>Object Encoding</b></p> <p><b>Object Class = M_COVR(A)</b></p> <p>(M) CATCOV = [1 (coverage available), 2 (no coverage available)]</p> <p>(C) SORDAT = [YYYYMMDD]</p> <p>(C) SORIND = (Refer to Section B, General Guidance)</p>

# C - IENC Meta Information

## C.1 Meta Features

### C.1.2 Data Quality (C)

An area within which a uniform assessment of the quality of the data exists. (S-57 Standard)

Graphics	Encoding Instructions	Object Encoding
<p><i>IENC Symbolization (for CATZOC=6)</i></p> 	<ul style="list-style-type: none"> <li>A) The M_QUAL polygons should only cover those areas that contain IENC data.</li> <li>B) EU: M_QUAL is not used.</li> <li>C) US: Refer to ZOC table below for a description of categories.</li> <li>D) RU: Currently all IENCs are coded with CATZOC=1</li> </ul>	<p><b><u>Object Encoding</u></b></p> <p><b>Object Class = M_QUAL(A)</b></p> <p>(O) CATZOC = [1 (zone of confidence A1), 2 (zone of confidence A2), 3 (zone of confidence B), 4 (zone of confidence C), 5 (zone of confidence D), 6 (zone of confidence U (data not assessed))]</p> <p>(C) SORDAT = [YYYYMMDD]</p> <p>(C) SORIND = (Refer to Section B, General Guidance)</p>

## Zone of Confidence (ZOC) Table

1	2	3		4	5
ZOC <sup>1</sup>	Position Accuracy <sup>5</sup>	Depth Accuracy <sup>3</sup>		Seafloor Coverage	Typical Survey Characteristics <sup>5</sup>
A1	∇ 5 m	a = 0.5 b = 1		Full seafloor ensonification or sweep. All significant seafloor features detected <sup>4</sup> and depths measured.	Controlled, systematic high accuracy Survey on WGS 84 datum; using DGPS or a minimum three lines of position (LOP) with multibeam, channel or mechanical sweep system.
		Depth (m)	Accuracy (m)		
		10 30 100 1000	∇ 0.6 ∇ 0.8 ∇ 1.5 ∇ 10.5		
A2	∇ 20 m	a = 1.0 b = 2		Full seafloor ensonification or sweep. All significant seafloor features detected <sup>4</sup> and depths measured.	Controlled, systematic survey to standard accuracy; using modern survey echosounder with sonar or mechanical sweep.
		Depth (m)	Accuracy (m)		
		10 30 100 1000	∇ 1.2 ∇ 1.6 ∇ 3.0 ∇ 21.0		
B	∇ 50 m	a = 1.0 b = 2		Full seafloor coverage not achieved; uncharted features, hazardous to surface navigation are not expected but may exist.	Controlled, systematic survey to standard accuracy.
		Depth (m)	Accuracy (m)		
		10 30 100 1000	∇ 1.2 ∇ 1.6 ∇ 3.0 ∇ 21.0		
C	∇ 500 m	a = 2.0 b = 5		Full seafloor coverage not achieved, depth anomalies may be expected.	Low accuracy survey or data collected on an opportunity basis such as soundings on passage.
		Depth (m)	Accuracy (m)		
		10 30 100 1000	∇ 2.5 ∇ 3.5 ∇ 7.0 ∇ 52.0		
D	worse than ZOC C	worse than ZOC C		Full seafloor coverage not achieved, large depth anomalies may be expected.	Poor quality data or data that cannot be quality assessed due to lack of information.

Note: The CATZOC attribute definitions are currently the subject of review and the results of this review will be promulgated as soon as possible in the S-57 Corrections Document.

Remarks:

**To decide on a ZOC Category, all conditions outlined in columns 2 to 4 of the tables must be met.**

Footnote numbers quoted in the table have the following meanings:

- <sup>1</sup> The allocation of a ZOC indicates that particular data meets minimum criteria for position and depth accuracy and seafloor coverage defined in this Table. Data may be further qualified by Object Class Quality of Data (M\_QUAL) sub-attributes as follows:
- a. Positional Accuracy (POSACC) and Sounding Accuracy (SOUACC) may be used to indicate that a higher position or depth accuracy has been achieved than defined in this Table (e.g. a survey where full seafloor coverage was not achieved could not be classified higher than ZOC B; however, if the positional accuracy was, for instance, 15 metres, the sub-attribute POSACC could be used to indicate this).
  - b. Swept areas where the clearance depth is accurately known but the actual seabed depth is not accurately known may be accorded a higher ZOC (i.e. A1 or A2) providing positional and depth accuracies of the swept depth meets the criteria in this Table. In this instance, Depth Range Value 1 (DRVAL1) may be used to specify the swept depth. The position accuracy criteria apply to the boundaries of swept areas.
  - c. SURSTA, SUREND and TECOU may be used to indicate the start and end dates of the survey and the technique of sounding measurement.

<sup>2</sup> Position Accuracy of depicted soundings at 95% CI (2.45 sigma) with respect to the given datum. It is the cumulative error and includes survey, transformation and digitizing errors, etc. Position accuracy need not be rigorously computed for ZOCs B, C, and D but may be estimated based on type of equipment, calibration regime, historical accuracy, etc.

<sup>3</sup> Depth accuracy of depicted soundings =  $a + (B\%d) / 100$  at 95% CI (2.00 sigma), where d = depth in metres at the critical depth. Depth accuracy need not be rigorously computed for ZOCs B, C and D but may be estimated based on type of equipment, calibration regime, historical accuracy, etc.

<sup>4</sup> Significant seafloor features are defined as those rising above depicted depths by more than:

	<u>Depth</u>	<u>Significant Feature</u>
a.	<10 metres	>0.1% depth,
b.	10 to 30 metres	>1.0 metre,
c.	>30 metres	>(0.1% depth) minus 2.0 metres

<sup>5</sup> Controlled, systematic (high accuracy) survey (ZOC A1, A2, and B) – a survey comprising planned survey lines on a geodetic datum that can be transformed to WGS 84.

Position fixing (ZOC A1) must be strong with at least three high quality Lines of Position (LOP) or Differential GPS.

Modern survey echosounder – a high precision surveying depth measuring equipment, generally including all survey echosounders designed post 1970.

# C - IENC Meta Information

## C.1 Meta Features

### C.1.3 Navigation System of Marks (M)

An area within which a specific system of navigational marks applies and/or a common direction of buoyage. (S-57 Standard)

Graphics	Encoding Instructions	Object Encoding
	<p>A) The m_nsys polygons should only cover those areas that contain IENC data.</p> <p>B) m_nsys areas may not overlap.</p> <p>C) US: All inland waterways in the United States use IALA B.</p> <p>D) EU: In areas with mixed systems (IALA-A and CEVNI) code marsys according to majority of marks and code individual deviant marks at object level to the appropriate system.</p> <p>E) RU: All inland waterways in Russia use marsys = 12 (Russian inland waterway regulations).</p> <p>F) BR: There are two systems in Brazilian national inland waterways: marsys = 13 (Brazilian national inland waterway regulations - two sides) and marsys = 14 (Brazilian national inland waterway regulations - side independent). In areas with mixed systems (IALA B and one above) use marsys = 2 (IALA B) and code individual deviant marks to the appropriate system (marsys = 13 or 14).</p> <p>G) BR: Paraguai-Parana International Waterway: In Brazilian extent, use marsys= 2 (IALA B) and code Brazilian complementary aids with marsys = 15 (Paraguai-Parana waterway - Brazilian complementary aids).</p>	<p><b>Object Encoding</b></p> <p><b>Object Class = m_nsys(A)</b></p> <p>(M) marsys = [1 (IALA A), 2 (IALA B), 9 (no system), 10 (other system), 11 (CEVNI), 12 (Russian inland waterway regulations), 13 (Brazilian national inland waterway regulations - two sides), 14 (Brazilian national inland waterway regulations - side independent), 15 (Paraguay-Parana waterway - Brazilian complementary aids)]</p> <p>(C) SORDAT = [YYYYMMDD]</p> <p>(C) SORIND = (Refer to Section B, General Guidance)</p>

## C - IENC Meta Information

### C.1 Meta Features

#### C.1.4 Sounding Datum (O)

A geographical area of uniform sounding datum. (S-57 Standard)

Graphics	Encoding Instructions	Object Encoding
	<p>A) If the sounding datum is different than the value given in the SDAT subfield of the "Data set parameter" [DSPM] field for some part of the data set, it must be encoded as meta object 'm_sdat'.</p> <p>B) The areas covered by these meta objects must be mutually exclusive.</p> <p>C) Depth contours and depth areas going across areas which have different values of vertical datum, must be divided into several objects at the border of these areas.</p> <p>D) The sounding datum must be constant over large areas. It applies to the attributes VALSOU, DRVAL1, DRVAL2 and VALDCO.</p>	<p><b>Object Encoding</b></p> <p><b>Object Class = m_sdat(A)</b></p> <p>(M) verdat = [12 (Mean lower low water), 31 (Local low water reference level), 32 (Local high water reference level), 33 (Local mean water reference level), 34 (Equivalent height of water (German GIW)), 35 (Highest Shipping Height of Water (German HSW)), 36 (Reference low water level according to Danube Commission), 37 (Highest shipping height of water according to Danube Commission), 38 (Dutch river low water reference level (OLR)), 39 (Russian project water level), 40 (Russian normal backwater level), 41 (Ohio River Datum), 42 (Approximate LAT), 43 (Dutch High Water Reference Level (MHW))]</p> <p>(C) SORDAT = [YYYYMMDD]</p> <p>(C) SORIND = (Refer to Section B, General Guidance)</p>



## C - IENC Meta Information

### C.1 Meta Features

#### C.1.5 Vertical Datum (O)

A geographical area of uniform vertical datum. (S-57 Standard)

Graphics	Encoding Instructions	Object Encoding
	<p>A) If the vertical datum is different to the value given in the VDAT subfield of the “Data set parameter” [DSPM] field for some part of the data set, it must be encoded as meta object 'm_vdat'.</p> <p>B) The areas covered by these meta objects must be mutually exclusive.</p> <p>C) Height contours, going across areas, that have different values of vertical datum, must be divided into several objects at the border of these areas.</p> <p>D) The vertical datum must be constant over large areas. It applies to the attributes ELEVAT, HEIGHT, VERCCL, VERCLR and VERCOP.</p>	<p><b>Object Encoding</b></p> <p><b>Object Class = m_vdat(A)</b></p> <p>(M) verdat = [12 (Mean lower low water), 31 (Local low water reference level), 32 (Local high water reference level), 33 (Local mean water reference level), 34 (Equivalent height of water (German GIW)), 35 (Highest Shipping Height of Water (German HSW)), 36 (Reference low water level according to Danube Commission), 37 (Highest shipping height of water according to Danube Commission), 38 (Dutch river low water reference level (OLR)), 39 (Russian project water level), 40 (Russian normal backwater level), 41 (Ohio River Datum), 42 (Approximate LAT), 43 (Dutch High Water Reference Level (MHW))]</p> <p>(C) SORDAT = [YYYYMMDD]</p> <p>(C) SORIND = (Refer to Section B, General Guidance)</p>

## C - IENC Meta Information

### C.1 Meta Features

#### C.1.6 Quality of Data for Detailed Depth Information (O)

An area within which a uniform assessment of the quality of the data exists.  
Distinction: accuracy of data; Survey reliability (S-57 Standard)

Graphics	Encoding Instructions	Object Encoding
	<p>A) The quality of data for soundings is only given in those areas where detailed depth information is provided. The area object shares the geometry with those areas.</p> <p>B) TECSOU has to be used to give the technique of the sounding measurement.</p> <p>C) SOUACC should be used to give information about the accuracy of the sounding data.</p> <p>D) POSACC should be used to give information about the accuracy of a position.</p>	<p><b>Object Encoding</b></p> <p><b>Object Class = M_QUAL(A)</b></p> <p>(M) TECSOU = [1 (found by echo-sounder), 2 (found by side-scan-sonar), 3 (found by multi-beam), 4 (found by diver), 5 (found by lead-line), 6 (swept by wire-drag), 7 (found by laser), 8 (swept by vertical acoustic system), 9 (found by electromagnetic sensor), 10 (photogrammetry), 11 (satellite imagery), 12 (found by levelling), 13 (swept by side-scan-sonar), 14 (computer generated)]</p> <p>(O) SOUACC = [x.xx] The best estimate of the accuracy of the sounding data. Minimum value: 0; Resolution: 0.1 m</p> <p>(O) POSACC = [xxx.x] (metres), The best estimate of the accuracy of a position. Minimum value: 0; Resolution: 0.1 m</p> <p>(C) SORDAT = [YYYYMMDD]</p> <p>(C) SORIND = (Refer to Section B, General Guidance)</p>

# C - IENC Meta Information

## C.1 Meta Features

### C.1.7 Survey Reliability for Detailed Depth Information (O)

An area within which a uniform assessment of the reliability of source survey information exists.  
Distinction: accuracy of data; quality of data (S-57 Standard)

Graphics	Encoding Instructions	Object Encoding
	<p>A) The survey reliability for soundings is only given in those areas where detailed depth information is provided. The area object shares the geometry with those areas.</p> <p>B) The quality of sounding must not be encoded using QUASOU on the depth geo object, unless it is different to the value of QUASOU encoded on M_SREL.</p> <p>C) QUASOU = 1 (depth known) has to be used if the depth is known and shown via depth areas.</p> <p>D) QUASOU = 2 (depth unknown) is used as an object attribute only in combination with depth areas (not with M_SREL!) for those areas in the river, which are too shallow for being surveyed by surveying boats and hence no detailed data is available (see I.1.9 Unsurveyed Area).</p> <p>E) QUASOU = 8 (value reported (not surveyed)) shall be used as an object attribute only in combination with depth areas (not with M_SREL) especially in cases when parts of the navigable water area are not surveyed but may be deep enough for navigation due to reports from other organisations than the waterways administration (see I.1.9 Unsurveyed Area).</p> <p>F) QUASOU = 10 (maintained depth) or QUASOU = 11 (depth not regularly maintained) should be used as an object attribute only in combination with DEPARE – Fairway Depth (not with M_SREL) to indicate the maintenance (see I.1.5 Fairway Depth / Project Depth).</p> <p>G) QUAPOS = 10 (precisely known) has to be used if the positioning during the survey is done by differential GPS signals.</p> <p>H) SURATH has to be used to give</p>	<p><b>Object Encoding</b></p> <p><b>Object Class = M_SREL(L,A)</b></p> <p>(M) QUASOU = [1 (depth known), 2 (depth unknown), 8 (value reported (not surveyed)), 10 (maintained depth), 11 (not regularly maintained)]</p> <p>(C) QUAPOS = [10 (precisely known)]</p> <p>(M) SURATH = (Name of the surveying authority: e.g., "Wasser- und Schifffahrtsamt Bingen")</p> <p>(M) SUREND = [CCYYMMDD (full date), CCYYMM (no specific day required)]</p> <p>(M) SURSTA = [CCYYMMDD (full date), CCYYMM (no specific day required)]</p> <p>(C) SURTYP = [2 (controlled survey)]</p> <p>(C) SORDAT = [YYYYMMDD]</p> <p>(C) SORIND = (Refer to Section B, General Guidance)</p>

	<p>name of the surveying authority.</p> <p>I) SUREND and SURSTA have to be used to encode the period of the survey.</p> <p>J) Quotation: "If the attributes SOUACC and TECSOU are required, they must be encoded on either the meta object M_QUAL or on individual geo objects (e.g., SOUNDG)." (see C.1.6 Quality of Data)</p> <p>K) SURTYP = 2 (controlled survey) has to be used if a thorough survey has been done, usually conducted with reference to guidelines (a quality assured survey).</p>	
--	--	--

## C - IENC Meta Information

### C.1 Meta Features

#### C.1.8 Nautical Publication Information (O)

Used to relate additional nautical information or publications to the data

Graphics	Encoding Instructions	Object Encoding
	<p>A) US &amp; RU: The M_NPUB polygons should only cover those areas that contain IENC data.</p> <p>B) US: TXTDSC shall be used to relate all information pertinent to the chart as printed in Section VII of the US Coast Guard's Local Notice to Mariners (LNM). Format of TXTDSC name should be U3UM819NP1.TXT where U3 = Agency, UM819 = River Cell, NP = Nautical Publication (NP), 1 = NP number.</p>	<p><b><u>Object Encoding</u></b></p> <p><b>Object Class = M_NPUB(A)</b></p> <p>(M) TXTDSC = (Refer to letter B)</p> <p>(C) SORDAT = [YYYYMMDD]</p> <p>(C) SORIND = (Refer to Section B, General Guidance)</p>

## D - Natural Features

### D.1 Hydrology

#### D.1.1 Canal (non-navigable) (O)

These are artificial tributaries of the main waterway.


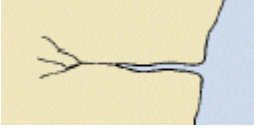
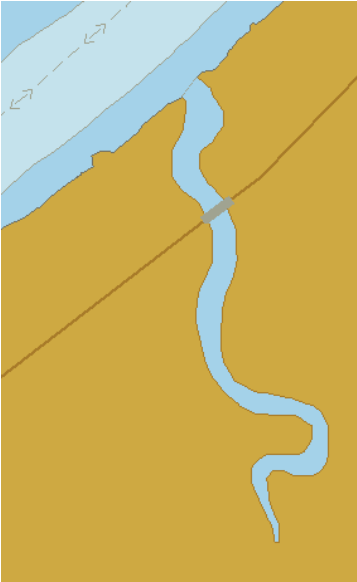
Graphics	Encoding Instructions	Object Encoding
	<p>A) CANALS of type area should be coded on LNDARE objects.</p> <p>B) A CANALS object may not share the same geospatial position and geometry as a SEAARE object.</p> <p>C) Canals that can be used for navigation by e.g. pleasure craft should be encoded as DEPARE, depare or UNSARE.</p>	<p><b><u>Object Encoding</u></b></p> <p><b>Object Class = CANALS(L,A)</b></p> <p>(O) OBJNAM = [Canal name]</p> <p>(O) NOBJNM = (Refer to Section B, General Guidance)</p> <p>(M) SCAMIN = [45000]</p> <p>(C) SORDAT = [YYYYMMDD]</p> <p>(C) SORIND = (Refer to Section B, General Guidance)</p>

# D - Natural Features

## D.1 Hydrology

### D.1.2 Rivers (non-navigable) (O)

Mainly free flowing water courses that are typically tributaries of the main waterway.



Graphics	Encoding Instructions	Object Encoding
<p><i>Real World</i></p>  <p><i>Chart Symbol</i></p>  <p><i>IENC Symbolization</i></p> 	<p>A) RIVERS of type area should be coded on LNDARE objects.</p> <p>B) Area features should not extend into line features as the river narrows; end where area designation ends.</p> <p>C) Rivers that can be used for navigation by e.g. pleasure craft should be encoded as DEPARE, depare or UNSARE.</p>	<p><b>Object Encoding</b></p> <p><b>Object Class = RIVERS(L,A)</b></p> <p>(O) OBJNAM = [River Name]</p> <p>(O) NOBJNM = (Refer to Section B, General Guidance)</p> <p>(M) SCAMIN = [EU: 45000; US: 60000]</p> <p>(C) SORDAT = [YYYYMMDD]</p> <p>(C) SORIND = (Refer to Section B, General Guidance)</p>

# D - Natural Features

## D.1 Hydrology

### D.1.3 Named Water Area (O)

A geographically defined part of navigable waters. It may be specified within its limits by its proper name.

Graphics	Encoding Instructions	Object Encoding
<p><i>Chart Symbol</i></p>  <p><i>IENC Symbolization</i></p> 	<p>A) For river or canal names, place the point object at or near confluences where a label is needed to distinguish adjoining waterways.</p> <p>B) An area object may be used if its usage will aid in reducing clutter.</p> <p>C) SEAARE area is mandatory only at confluences of two waterways up to 2 kilometres from the confluence.</p> <p>D) Use SEAARE (P) to display the name only at the location where the point was placed. A point object should be used if the point is always on the display when it is relevant. Use SEAARE (A) if display of name is desired along water area's entire expanse.</p>	<p><b>Object Encoding</b></p> <p><b>Object Class = SEAARE(P,A)</b></p> <p>(M) OBJNAM = [Water Area Name]</p> <p>(O) NOBJNM = (Refer to Section B, General Guidance)</p> <p>(O) CATSEA = [5 (bay), 12 (narrows), 13 (shoal), 51 (canal), 52 (lake), 53 (river), 54 (reach), 57 (chute), 58 (backwater/slough), 59 (bend)]</p> <p>(M) SCAMIN = [EU: 45000; US: 60000]</p> <p>(C) SORDAT = [YYYYMMDD]</p> <p>(C) SORIND = (Refer to Section B, General Guidance)</p>





# D - Natural Features

## D.1 Hydrology

### D.1.4 Dredging Lake (O)

A body of water mostly surrounded by land, from which sand or gravel is dredged.



Graphics	Encoding Instructions	Object Encoding
<p><i>Real World</i></p>  <p><i>IENC Symbolization</i></p> 	<p>A) Lakes that are navigable at compilation scale should be covered by a DEPARE (see I.1.1, Detailed Depth - ref. to one water level) or 'depare' (see I.1.2, Detailed Depth - water level model)</p> <p>B) Dredging lakes connected to the waterway should be covered by a DEPARE or 'depare' with an appropriate QUASOU coding.</p> <p>C) If water depth is not surveyed, but only known from experience by visiting vessels, QUASOU = 2 or 8 should be used (see also I.1.9, Unsurveyed Area).</p> <p>D) Lakes that are not navigable at compilation scale have to be encoded as LAKARE (see D.1.5)</p>	<p><b>Object Encoding</b></p> <p><b>Object Class = DEPARE(A)</b></p> <p>(M) DRVAL1 = [x.xx] (metres), e.g., 2.74 or UNKNOWN</p> <p>(M) DRVAL2 = Maximum known depth of depth area: [xx.xx] (metres) or UNKNOWN</p> <p>(C) QUASOU = [2 (depth unknown), 8 (value reported (not surveyed))]</p> <p>(C) SORDAT = [YYYYMMDD]</p> <p>(C) SORIND = (Refer to Section B, General Guidance)</p> <p><b>Object Encoding</b></p> <p><b>Object Class = depare(A)</b></p> <p>(M) DRVAL1 = [x.xx] (metres), e.g., 2.74 or UNKNOWN</p> <p>(M) DRVAL2 = Maximum known depth of depth area: [xx.xx] (metres) or UNKNOWN</p> <p>(C) eleva1 = Maximum elevation 1 of a depth area: [xx.x] (metres) or UNKNOWN</p> <p>(C) eleva2 = Minimum elevation 2 of a depth area: [xx.x] (metres) or UNKNOWN</p> <p>(M) wtwdis = [xxxx.xxx] (units defined in hunits), e.g., 2451.732</p> <p>(M) hunits = [3 (kilometres), 4 (hectometres), 5 (statute miles), 6 (nautical miles)]</p> <p>(C) SORDAT = [YYYYMMDD]</p> <p>(C) SORIND = (Refer to Section B, General Guidance)</p>

# D - Natural Features

## D.1 Hydrology

### D.1.5 Lake (O)

A large body of water entirely surrounded by land. (IHO Dictionary, S-32, 5th Edition, 2629)

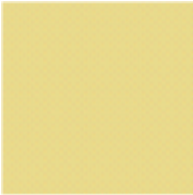
Graphics	Encoding Instructions	Object Encoding
<p><i>Chart Symbol</i></p>  <p><i>IENC Symbolization</i></p> 	<p>A) Lakes not navigable at compilation scale are encoded by LAKARE on LNDARE object(s).</p> <p>B) Lakes that are navigable at compilation scale should be encoded by a DEPARE (see I.1.1 - Detailed Depth - ref. to one water level) or 'depare' (see I.1.2 - Detailed Depth - water level model)</p> <p>C) For dredging lakes connected to the waterway see D.1.4 - Dredging Lake</p>	<p><b>Object Encoding</b></p> <p><b>Object Class = LAKARE(A)</b></p> <p>(O) OBJNAM = [Lake Name]</p> <p>(O) NOBJNM = (Refer to Section B, General Guidance)</p> <p>(M) SCAMIN = [EU: 90000; US: 300000]</p> <p>(C) SORDAT = [YYYYMMDD]</p> <p>(C) SORIND = (Refer to Section B, General Guidance)</p>

# D - Natural Features

## D.2 Topography

### D.2.1 Land Area (M)

The solid portion of the Earth's surface, as opposed to navigable river and water. (IHO Dictionary, S-32, 5th Edition, 2635)



Graphics	Encoding Instructions	Object Encoding
<p><i>IENC Symbolization</i></p> 	<p>A) A Group I (SOTE) object.</p> <p>B) US: Encode the land area up to the defined 1000 meter buffer zone or the distance within the radar zone for IENC charts.</p> <p>C) Line and Point objects may only be used in small-scale charts.</p>	<p><b><u>Object Encoding</u></b></p> <p><b>Object Class</b> = LNDARE(P,L,A)</p> <p>(O) OBJNAM = "Land Area Name"</p> <p>(O) NOBJNM = (Refer to Section B, General Guidance)</p> <p>(C) SORDAT = [YYYYMMDD]</p> <p>(C) SORIND = (Refer to Section B, General Guidance)</p>

# D - Natural Features

## D.2 Topography

### D.2.2 Land Region (O)

Land Areas adjacent to the waterway that are significant for navigation reference.


Graphics	Encoding Instructions	Object Encoding
<p><i>Chart Symbol</i></p>  <p><i>IENC Symbolization</i></p> 	<ul style="list-style-type: none"> <li>A) Landings, islands, points, bends, and any land location that should have a label readily displayed for users of the IENC.</li> <li>B) US: Use state and county abbreviations in OBJNAM, where applicable.</li> <li>C) US: Preferred naming will include State abbreviation on towns and cities.</li> <li>D) LNDARE has to be coded underneath Land Region</li> <li>E) Use LNDRGN (P) to display the name only at the location where the point was placed. Use LNDRGN (A) if display of name is desired along water area's entire expanse.</li> </ul>	<p><b>Object Encoding</b></p> <p><b>Object Class = LNDRGN(P,A)</b></p> <p>(M) OBJNAM = [location name]</p> <p>(O) NOBJNM = (Refer to Section B, General Guidance)</p> <p>(O) CATLND = [2 (marsh), 9 (agricultural land), 11 (parkland), 12 (swamp)]</p> <p>(M) SCAMIN = [EU: 45000; US: 60000]</p> <p>(C) SORDAT = [YYYYMMDD]</p> <p>(C) SORIND = (Refer to Section B, General Guidance)</p>

# D - Natural Features

## D.2 Topography

### D.2.3 Natural Dunes or Ridges (O)

Natural dunes or ridges, roughly paralleling the waterway, to keep flood waters within the river course.

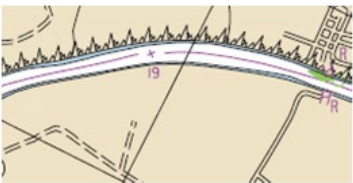

Graphics	Encoding Instructions	Object Encoding
<p><i>Real World</i></p> <div data-bbox="102 527 277 653" style="border: 1px solid red; padding: 2px; color: red; text-align: center;"> <i>Image to be included at a later date</i> </div> <p><i>Chart Symbol</i></p> <div data-bbox="102 762 277 888" style="border: 1px solid red; padding: 2px; color: red; text-align: center;"> <i>Image to be included at a later date</i> </div> <p><i>IENC Symbolization</i></p> 	<p>A) Natural dunes must be encoded as a SLOGRD</p> <p>B) When the SLOGRD is of type area, it must have a LNDARE underneath.</p> <p>C) At large scale, the crown (the topline of the dune) may be encoded as a SLOTOP with CATSLO = 2 (embankment).</p>	<p><b><u>Object Encoding</u></b></p> <p><b>Object Class = SLOGRD(L,A)</b></p> <p>(M) CATSLO = [3 (dune)]</p> <p>(O) NATSUR = [1 (mud), 2 (clay), 3 (silt), 4 (sand), 5 (stone), 6 (gravel), 7 (pebbles), 8 (cobbles), 9 (rock), 11 (lava), 14 (coral), 17 (shells), 18 (boulder)]</p> <p>(M) SCAMIN = [22000]</p> <p>(C) SORDAT = [YYYYMMDD]</p> <p>(C) SORIND = (Refer to Section B, General Guidance)</p> <p><b><u>Object Encoding</u></b></p> <p><b>Object Class = SLOTOP(L)</b></p> <p>(M) CATSLO = [2 (embankment)]</p> <p>(O) NATSUR = [1 (mud), 2 (clay), 3 (silt), 4 (sand), 5 (stone), 6 (gravel), 7 (pebbles), 8 (cobbles), 9 (rock), 11 (lava), 14 (coral), 17 (shells), 18 (boulder)]</p> <p>(M) SCAMIN = [22000]</p> <p>(C) SORDAT = [YYYYMMDD]</p> <p>(C) SORIND = (Refer to Section B, General Guidance)</p>

# D - Natural Features

## D.2 Topography

### D.2.4 Rock Wall (O)

The delineation of a natural rock wall that could be a hazard to navigation.


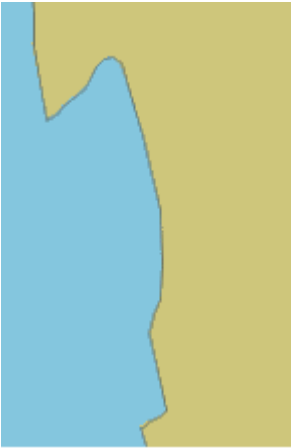
Graphics	Encoding Instructions	Object Encoding
<p><i>Real World</i></p> <div data-bbox="99 525 276 651" style="border: 1px solid red; padding: 5px; color: red; text-align: center;"> <i>Image to be included at a later date</i> </div> <p><i>Chart Symbol</i></p>  <p><i>IENC Symbolization</i></p> 	<p>A) US: Delineate extent of rock wall 12m inland from COALNE using SLOTOP, CATSLO = 6 (cliff).</p> <p>B) US: Use CTNARE to buffer between waterline into depth area. CTNARE should be a minimum of 12m.</p> <p>C) EU: If a rock wall is in navigable water and is a hazard to navigation, a caution area (CTNARE) shall be added.</p>	<p><b>Object Encoding</b></p> <p><b>Object Class = SLOTOP(L)</b></p> <p>(M) CATSLO = [6 (cliff)]</p> <p>(O) NATSUR = [1 (mud), 2 (clay), 3 (silt), 4 (sand), 5 (stone), 6 (gravel), 7 (pebbles), 8 (cobbles), 9 (rock), 11 (lava), 14 (coral), 17 (shells), 18 (boulder)]</p> <p>(M) SCAMIN = [EU: 22000; US: 60000]</p> <p>(C) SORDAT = [YYYYMMDD]</p> <p>(C) SORIND = (Refer to Section B, General Guidance)</p> <p><b>Object Encoding</b></p> <p><b>Object Class = CTNARE(A)</b></p> <p>(M) INFORM = "Natural Rock Wall"</p> <p>(O) NINFOM = (Refer to Section B, General Guidance)</p> <p>(M) SCAMIN = [EU: 22000; US: 60000]</p> <p>(C) SORDAT = [YYYYMMDD]</p> <p>(C) SORIND = (Refer to Section B, General Guidance)</p>

# D - Natural Features

## D.2 Topography

### D.2.5 Shoreline (M)

The line where shore and water meet. Although the terminology of coasts and shores is rather confused, shoreline and coastline are generally used as synonyms. (IHO Dictionary, S-32, 5th Edition, 858,4695)



Graphics	Encoding Instructions	Object Encoding
<p><i>Chart Symbol</i></p>  <p><i>IENC Symbolization</i></p> 	<p>A) EU: Shoreline should be extracted from data collected at mean water conditions, if possible.</p> <p>B) US: Shoreline is project specific: in pool areas, project pool is used; in open water areas, shoreline should be extracted at low water conditions.</p>	<p><b>Object Encoding</b></p> <p><b>Object Class = COALNE(L)</b></p> <p>(O) CATCOA = [1 (steep coast), 2 (flat coast), 3 (sandy shore), 4 (stony shore), 5 (shingly shore), 6 (glacier (seaward end)), 7 (mangrove), 8 (marshy shore), 9 (coral reef), 10 (ice coast), 11 (shelly shore)]</p> <p>(M) SCAMIN = [EU: 45000; US: 300000]</p> <p>(C) SORDAT = [YYYYMMDD]</p> <p>(C) SORIND = (Refer to Section B, General Guidance)</p>

# D - Natural Features

## D.3 Vegetation

### D.3.1 Vegetation (C)

Collections of, or individual plants. (S-57 standard)

Graphics	Encoding Instructions	Object Encoding
<p><i>Real World</i></p>  <p><i>IENC Symbolization</i></p> 	<p>A) Vegetation areas and trees shall only be used on a limited level, mostly in case they are visual conspicuous to the skippers.</p> <p>B) In case trees or woods block visibility of objects, which are of relevance for navigation, they shall be encoded.</p> <p>C) In case large areas of reed exist and significantly mask a coastline or canal entrance, CATVEG = 11 (reed) shall be encoded.</p>	<p><b>Object Encoding</b></p> <p><b>Object Class = VEGATN(P,A)</b></p> <p>(M) CATVEG = [6 (wood in general (inc mixed wood)), 11 (reed), 13 (tree in general)]</p> <p>(O) CONVIS = [1 (visually conspicuous), 2 (not visually conspicuous)]</p> <p>(M) SCAMIN = [EU: 12000; US: 18750]</p> <p>(C) SORDAT = [YYYYMMDD]</p> <p>(C) SORIND = (Refer to Section B, General Guidance)</p>






# E - Cultural Features

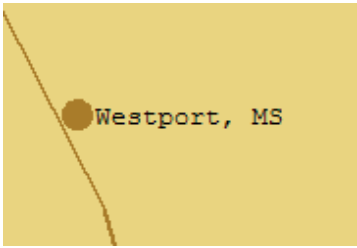
## E.1 Settlements, Buildings, Political Boundaries

### E.1.1 Built-up Areas (O)

An area containing a concentration of buildings and the supporting road or rail infrastructure (S-57 Standard)

Graphics	Encoding Instructions	Object Encoding
<p><i>Real World</i></p>  <p><i>Chart Symbol</i></p>  <p><i>IENC Symbolization (area)</i></p> 	<p>A) EU: Outline of BUAARE using area feature should be real built-up areas; only in case no detailed data is available (e.g., from flight surveys or satellite pictures) the political bounds can be used.</p> <p>B) US: Outline of BUAARE should be the political bounds.</p> <p>C) CATBUA may be encoded according to the following definitions based on inhabitants:            Urban area (more than 100.000)            City (20.000 – 100.000)            Town (5.000 – 20.000)            Village (100 - 5000)            Settlement (few houses/farms)</p> <p>D) BUAARE should be represented as point object for towns and small communities where the limits are not known. Points should be oriented on the highest buildings (e.g., church towers) or the town centres.</p> <p>E) Built-up areas that use the riverbank as a limit must share the same geometry.</p> <p>F) US: Use name and state abbreviation, e.g., Westport, MS for OBJNAM.</p>	<p><b>Object Encoding</b></p> <p><b>Object Class = BUAARE(P,A)</b></p> <p>(O) OBJNAM = [urban or settlement name]</p> <p>(O) NOBJNM = (Refer to Section B, General Guidance)</p> <p>(O) CATBUA = [1 (urban area), 2 (settlement), 3 (village), 4 (town), 5 (city)]</p> <p>(O) CONDTN = [1 (under construction), 2 (ruined), 3 (under reclamation), 5 (planned construction)]</p> <p>(M) SCAMIN = [EU: 90000 (except: 700000 for CATBUA1 and 180000 for CATBUA5); US: 75000]</p> <p>(C) SORDAT = [YYYYMMDD]</p> <p>(C) SORIND = (Refer to Section B, General Guidance)</p>

*IENC Symbolization (point)*


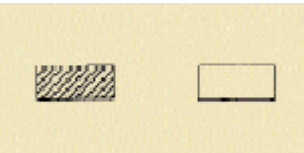



# E - Cultural Features

## E.1 Settlements, Buildings, Political Boundaries

### E.1.2 Buildings of Navigational Significance (O)

Buildings with a special function, which may be of interest for the skipper.

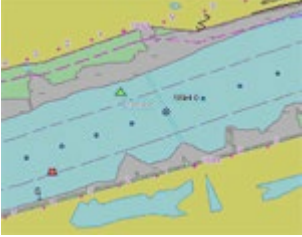
Graphics	Encoding Instructions	Object Encoding
<p><i>Real World</i></p>  <p><i>Chart Symbol</i></p>  <p><i>IENC Symbolization</i></p> 	<p>A) Fortified structures shall be encoded as landmarks (LNDMRK), if they can be seen from the water.</p> <p>B) Collect areas of buildings that are not individually navigationally significant as Built-up Areas (BUAARE) by collecting an area around the outer edges of the outermost buildings or street patterns.</p> <p>C) Buildings that are visible from the water and that may be used as landmarks shall be collected as LNDMRK if possible.</p> <p>D) Buildings or structures with specialized functions must be attributed with the appropriate FUNCTN value.</p> <p>E) Buildings that can be encoded as 'hrbfac' (see S.1.1) should not be encoded as BUISGL.</p> <p>F) Buildings that extend into water should be encoded as Dock/Wharf (SLCONS) with appropriate CATSLC attribute. Then the building should be placed on that dock.</p>	<p><b>Object Encoding</b></p> <p><b>Object Class = BUISGL(P,A)</b></p> <p>(O) OBJNAM = [name and/or operator/owner]</p> <p>(O) NOBJNM = (Refer to Section B, General Guidance)</p> <p>(C) FUNCTN = [2 (harbour-master's office), 3 (custom office), 4 (health office), 5 (hospital), 6 (post office), 7 (hotel), 8 (railway station), 9 (police station), 10 (water-police station), 11 (pilot office), 12 (pilot lookout), 13 (bank office), 14 (headquarters for district control), 15 (transit shed/warehouse), 16 (factory), 17 (power station), 18 (administrative), 19 (educational facility), 20 (church), 21 (chapel), 22 (temple), 23 (pagoda), 24 (shinto shrine), 25 (buddhist temple), 26 (mosque), 27 (marabout), 28 (lookout), 29 (communication), 30 (television), 31 (radio), 32 (radar), 33 (light support), 34 (microwave), 35 (cooling), 36 (observation), 37 (time ball), 38 (clock), 39 (control), 40 (airship mooring), 41 (stadium), 42 (bus station)]</p> <p>(C) CONVIS = [1 (visually conspicuous), 2 (not visually conspicuous)]</p> <p>(O) CONDTN = [1 (under construction), 2 (ruined), 3 (under reclamation), 4 (wingless), 5 (planned construction)]</p> <p>(M) SCAMIN = [US: 18750; EU: 22000 (except: 45000 for FUNCT20-CONVIS2, 45000 for FUNCT33-CONVIS2, 90000 for FUNCTN20-CONVIS1, 90000 for FUNCTN33-CONVIS1)]</p> <p>(C) SORDAT = [YYYYMMDD]</p> <p>(C) SORIND = (Refer to Section B, General Guidance)</p>

# E - Cultural Features

## E.1 Settlements, Buildings, Political Boundaries

### E.1.3 International Boundaries & National Limits (Administration Area) (O)

A defined and named administrative area (e.g. country, state, district)


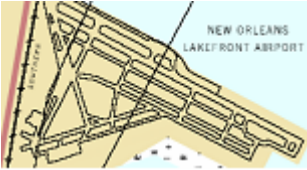
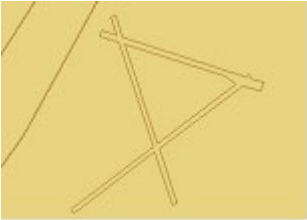
Graphics	Encoding Instructions	Object Encoding
<p><i>IENC Symbolization (only visible in display mode "other")</i></p> 	<p>A) Use ADMARE object class, if the information about the applicable jurisdiction is important for navigation.</p> <p>B) The nationality is encoded by a 2 character-code following ISO 3166 (Refer to Annex A to S-57 Appendix A)</p>	<p><b>Object Encoding</b></p> <p><b>Object Class = ADMARE(A)</b></p> <p>(M) JRSDTN = [1 (international), 2 (national), 3 (national sub-division)]</p> <p>(M) NATION = [xx] (Refer to letter B)</p> <p>(M) OBJNAM = [name of the administrative area]</p> <p>(O) NOBJNM = (Refer to Section B, General Guidance)</p> <p>(O) CONDTN = [3 (under reclamation)]</p> <p>(M) SCAMIN = [90000]</p> <p>(C) SORDAT = [YYYYMMDD]</p> <p>(C) SORIND = (Refer to Section B, General Guidance)</p>

# E - Cultural Features

## E.2 Airfields, Railways, Roads

### E.2.1 Airport (C)

An area containing at least one runway, used for landing, take-off, and movement of aircraft. (S-57 Standard)



Graphics	Encoding Instructions	Object Encoding
<p><i>Real World</i></p>  <p><i>Chart Symbol</i></p>  <p><i>IENC Symbolization</i></p> 	<p>A) Code outline of runways. Include taxiways and tarmacs, if the information is available.</p> <p>B) Coding as a point is subject to data availability or subject to the scale of the chart.</p> <p>C) Runways where lights can be seen from passing vessels shall be encoded.</p> <p>D) If an airfield consists of several component objects (AIRARE), C_ASSO could be used to associate them.</p>	<p><b>Object Encoding</b></p> <p><b>Object Class = AIRARE(P,A)</b></p> <p>(O) CATAIR = [1 (military aeroplane airport), 2 (civil aeroplane airport), 4 (civil heliport), 6 (small planes airfield)]</p> <p>(O) OBJNAM = [(Name) + "Airport" or (Name) + "Airfield"]</p> <p>(O) NOBJNM = (Refer to Section B, General Guidance)</p> <p>(O) CONDTN = [1 (under construction), 2 (ruined), 3 (under reclamation), 5 (planned construction)]</p> <p>(M) SCAMIN = [45000]</p> <p>(C) SORDAT = [YYYYMMDD]</p> <p>(C) SORIND = (Refer to Section B, General Guidance)</p>

# E - Cultural Features

## E.2 Airfields, Railways, Roads

### E.2.2 Railway (C)

A rail or set of parallel rails on which a train or tram runs. (Digital Geographic Information Working Group, Oct.87)

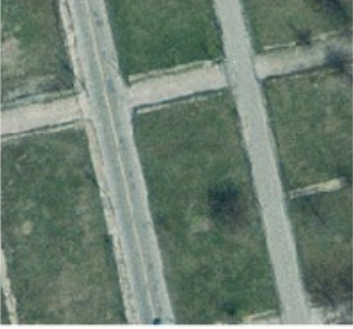
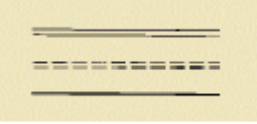

Graphics	Encoding Instructions	Object Encoding
<p><i>Chart Symbol</i></p>  <p><i>IENC Symbolization</i></p> 	<p>A) Switching yards and groups of spur lines should be coded as LNDRGN (A) objects. If appropriate, code INFORM = Switching yard.</p> <p>B) It is recommended that minimal RAILWY objects be collected in a BUAARE.</p> <p>C) Switching yards may be defined by the external rail lines defining the yard with the LNDRGN placed within.</p> <p>D) Include railroads where vessels can see the train lights and traffic control lights from the water.</p>	<p><b>Object Encoding</b></p> <p><b>Object Class = RAILWY(L)</b></p> <p>(O) OBJNAM = [Railroad Name]</p> <p>(O) NOBJNM = (Refer to Section B, General Guidance)</p> <p>(C) INFORM = (Refer to letter A)</p> <p>(C) NINFOM = (Refer to Section B, General Guidance)</p> <p>(O) CONDTN = [1 (under construction), 2 (ruined), 3 (under reclamation), 5 (planned construction)]</p> <p>(M) SCAMIN = [EU: 45000; US: 15000]</p> <p>(C) SORDAT = [YYYYMMDD]</p> <p>(C) SORIND = (Refer to Section B, General Guidance)</p>

# E - Cultural Features

## E.2 Airfields, Railways, Roads

### E.2.3 Road (C)

A road is an open way for the passage of vehicles. (United States Geological Survey, Jan.89)




Graphics	Encoding Instructions	Object Encoding
<p><i>Real World</i></p>  <p><i>Chart Symbol</i></p>  <p><i>IENC Symbolization</i></p> 	<ul style="list-style-type: none"> <li>A) Only interstates, highways, major roads and roads providing access to the river should be collected.</li> <li>B) In BUAAREs, with exception to roads providing access to the waterfront, ROADWYs should be restricted to a set of routes representative of the urban layout.</li> <li>C) Roads should be collected to the limits of the IENC buffer.</li> <li>D) Unless the feature represents an access route useful to vessels, ROADWY features need not have complete or accurate topology.</li> <li>E) Road fragments clipped by the IENC Buffer Zone should be removed.</li> <li>F) Roads should be encoded as linear objects but may also be encoded as areas.</li> <li>G) Include roads where vessels can see the vehicle lights and traffic control lights from the water.</li> </ul>	<p><b>Object Encoding</b></p> <p><b>Object Class = ROADWY(L,A)</b></p> <p>(M) CATROD = [1 (motorway), 2 (major road), 3 (minor road), 4 (track/path)]</p> <p>(O) OBJNAM = [highway, interstate, road name]</p> <p>(O) NOBJNM = (Refer to Section B, General Guidance)</p> <p>(O) NATCON = [4 (hard surfaced), 5 (unsurfaced)]</p> <p>(O) CONDTN = [1 (under construction), 2 (ruined), 3 (under reclamation), 5 (planned construction)]</p> <p>(M) SCAMIN = [EU: 45000; US: 15000]</p> <p>(C) SORDAT = [YYYYMMDD]</p> <p>(C) SORIND = (Refer to Section B, General Guidance)</p>

# E - Cultural Features

## E.2 Airfields, Railways, Roads

### E.2.4 Runway (O)

A defined rectangular area, on a land aerodrome, prepared for the landing and take-off run of aircraft along its length. A site on which helicopters may land and take off. (S-57 Standard)

Graphics	Encoding Instructions	Object Encoding
<p><i>Real World</i></p>  <p><i>Chart Symbol</i></p>  <p><i>IENC Symbolization</i></p> 	<p>A) Coding as point or line is subject to data availability or subject to the scale of the chart.</p> <p>B) Runways where lights can be seen from passing vessels should be encoded.</p>	<p><b>Object Encoding</b></p> <p><b>Object Class = RUNWAY(P,L,A)</b></p> <p>(O) CATRUN = [1 (aeroplane runway), 2 (helicopter landing pad)]</p> <p>(O) CONVIS = [1 (visually conspicuous), 2 (not visually conspicuous)]</p> <p>(O) NATCON = [4 (hard surface), 5 (unsurfaced)]</p> <p>(O) OBJNAM = [Runway name]</p> <p>(O) NOBJNM = (Refer to Section B, General Guidance)</p> <p>(M) SCAMIN = 45000</p> <p>(C) SORDAT = [YYYYMMDD]</p> <p>(C) SORIND = (Refer to Section B, General Guidance)</p>






# E - Cultural Features

## E.3 Other Cultural Features

### E.3.1 Silo / Storage Tank (O)

An enclosed container, used for storage (Digital Geographic Information Working Group, Oct.87)


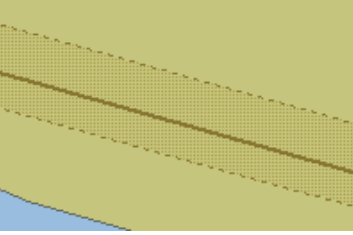
Graphics	Encoding Instructions	Object Encoding
<p><i>Real World</i></p>  <p><i>Chart Symbol</i></p>  <p><i>IENC Symbolization</i></p> 	<p>A) Outline silo or tank with circle, square, or rectangle.</p> <p>B) Groups of silos or tanks should be aggregated into a single polygon of built-up area, with an INFORM to identify the feature as a group.</p> <p>C) Water Towers should be encoded as SILTNK, CATSIL = 4 (water tower), PRODC T = 3 (water).</p>	<p><b>Object Encoding</b></p> <p><b>Object Class</b> = SILTNK(P,A)</p> <p>(O) PRODC T = [1 (oil), 2 (gas), 3 (water), 7 (chemicals), 22 (grain)]</p> <p>(O) CATSIL = [1 (silo in general), 2 (tank in general), 3 (grain elevator), 4 (water tower)]</p> <p>(O) OBJNAM = [Facility Owner]</p> <p>(O) NOBJNM = (Refer to Section B, General Guidance)</p> <p>(C) INFORM = ["Tank Farm/Multiple Structures"]</p> <p>(O) NINFOM = (Refer to Section B, General Guidance)</p> <p>(O) CONDTN = [1 (under construction), 2 (ruined), 3 (under reclamation), 5 (planned construction)]</p> <p>(M) SCAMIN = [EU: 22000; US: 30000]</p> <p>(C) SORDAT = [YYYYMMDD]</p> <p>(C) SORIND = (Refer to Section B, General Guidance)</p>

# E - Cultural Features

## E.3 Other Cultural Features

### E.3.2 Embankment (O)

An artificial elevation constructed from earth, stone, etc. carrying a road, railway or similar or serving to dam water.




Graphics	Encoding Instructions	Object Encoding
<p><i>Real World</i></p>  <p><i>IENC Symbolization</i></p> 	<p>A) SLOGRD of type area should be delineated at the toe of the embankment</p> <p>B) When the SLOGRD is of type area, it must have a LNDARE underneath.</p>	<p><b>Object Encoding</b></p> <p><b>Object Class = SLOGRD(L,A)</b></p> <p>(M) CATSLO = [2 (embankment)]</p> <p>(O) NATSUR = [1 (mud), 2 (clay), 3 (silt), 4 (sand), 5 (stone), 6 (gravel), 7 (pebbles), 8 (cobbles), 9 (rock), 11 (lava), 14 (coral), 17 (shells), 18 (boulder)]</p> <p>(O) CONDTN = [1 (under construction), 2 (ruined), 3 (under reclamation), 5 (planned construction)]</p> <p>(M) SCAMIN = 22000</p> <p>(C) SORDAT = [YYYYMMDD]</p> <p>(C) SORIND = (Refer to Section B, General Guidance)</p>

# F - Landmarks

## F.1 Landmarks

### F.1.1 Conspicuous Landmark (O)

A prominent object at a fixed location which can be used in determining a location or a direction (adapted from IHO Dictionary, S-32, 5th Edition, 2643).


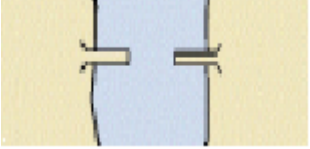

Graphics	Encoding Instructions	Object Encoding
<p><i>Real World</i></p>  <p><i>IENC Symbolization (point)</i></p>  <p><i>IENC Symbolization (area)</i></p> 	<p>A) Only visually conspicuous landmarks shall be encoded as landmarks. As a result the mandatory attribute CONVIS shall always be 1 (visually conspicuous).</p> <p>B) Castles, churches, chapels and transmitters can be encoded as CATLMK = 17 (tower), but then the type must be further made clear within the object name.</p> <p>C) If the landmark serves as a navigational light support, FUNCTN = 33 (light support), it must be encoded with a LIGHTS object (see N).</p> <p>D) If the landmark has a navigational function it has to be encoded as a building of navigational significance (see E.1.2).</p>	<p><b>Object Encoding</b></p> <p><b>Object Class = LNDMRK(P,A)</b></p> <p>(M) CONVIS = [1 (visually conspicuous)]</p> <p>(M) CATLMK = [1 (cairn), 2 (cemetery), 3 (chimney), 4 (dish aerial), 5 (flagstaff (flagpole)), 6 (flare stack), 7 (mast), 8 (wind sock), 9 (monument), 10 (column (pillar)), 11 (memorial plaque), 12 (obelisk), 13 (statue), 14 (cross), 15 (dome), 16 (radar scanner), 17 (tower), 18 (windmill), 19 (windmotor), 20 (spire/minaret), 21 (large rock or boulder on land)]</p> <p>(O) OBJNAM = [name and/or operator/owner]</p> <p>(O) NOBJNM = (Refer to Section B, General Guidance)</p> <p>(C) FUNCTN = [33 (light support)]</p> <p>(O) CONDTN = [1 (under construction), 2 (ruined), 3 (under reclamation), 4 (wingless), 5 (planned construction)]</p> <p>(M) SCAMIN = [EU: use 22000 for a point object (except 45000 for CONVIS1) and 45000 for line objects; US: 60000]</p> <p>(C) SORDAT = [YYYYMMDD]</p> <p>(C) SORIND = (Refer to Section B, General Guidance)</p>

# G - Ports, Waterways

## G.1 Bridges, Tunnels, Overhead Obstructions

### G.1.1 Bascule Bridge (M)

A counterpoise bridge rotated in a vertical plane about an axis at one or both ends. Also called a balance. (IHO Dictionary, S-32, 5th Edition, 545)

Graphics	Encoding Instructions	Object Encoding
<p><i>Real World</i></p>  <p><i>Chart Symbol</i></p>  <p><i>IENC Symbolization</i></p> 	<p>A) Pylons shall be encoded as PYLONS (refer to G.1.10 – Pylons, Piers and Bridge, Cable, Pipeline Support)</p> <p>B) The portions of the bridge that approach the movable span from either shore are to be collected as fixed bridges (separate objects). Only that portion of the bridge that is actually movable is to be collected as a movable bridge.</p> <p>C) Create separate bridge objects for spans over navigable channel when attributes of navigable spans are different (e.g. vertical clearance, horizontal clearance).</p> <p>D) US: If separate spans are required, each span's INFORM should indicate whether it is the "Primary Navigation Span", "Secondary Navigation Span", or "Not to be used for Navigation"</p> <p>E) Bridge approaches (over the bankline) should be encoded.</p> <p>F) Include PICREP, with pictures of bridge when open, and closed, if available. US: PICREP is mandatory EU: PICREP is optional</p> <p>G) Roads and railways on bridges shall not be encoded.</p> <p>H) Place LIGHTS at appropriate position on bridge object and piers bounding navigable channel.</p> <p>I) All objects of a bridge which belong to one bridge must be combined to one aggregation area (C_AGGR), e.g. - pylons - notice marks - bridge lights - buoys at bridge pillar</p>	<p><b>Object Encoding</b></p> <p><b>Object Class</b> = bridge(A)</p> <p>(M) CATBRG = [5 (bascule bridge)]</p> <p>(C) HORCLR = [xx.x] (metres), e.g., 34.2</p> <p>(C) VERCOP = [xx.x] (metres), e.g., 23.4</p> <p>(C) VERCCL = [xx.x] (metres), e.g., 13.2 - over navigable waters</p> <p>(C) verdat = [12 (Mean lower low water), 31 (Local low water reference level), 32 (Local high water reference level), 33 (Local mean water reference level), 34 (Equivalent height of water (German GIW)), 35 (Highest Shipping Height of Water (German HSW)), 36 (Reference low water level according to Danube Commission), 37 (Highest shipping height of water according to Danube Commission), 38 (Dutch river low water reference level (OLR)), 39 (Russian project water level), 40 (Russian normal backwater level), 41 (Ohio River Datum), 42 (Approximate LAT), 43 (Dutch High Water Reference Level (MHW))]</p> <p>(C) unlocd = [ISRS Location Code]</p> <p>(M) wtwdis = [xxxx.xxx] (units defined in hunits), e.g., 2451.732</p> <p>(M) hunits = [3 (kilometres), 4 (hectometres), 5 (statute miles), 6 (nautical miles)]</p> <p>(C) OBJNAM = (Refer to letter J)</p> <p>(C) NOBJNM = (Refer to Section B, General Guidance)</p> <p>(C) INFORM = (Refer to letter D)</p> <p>(O) NINFOM = (Refer to Section B, General Guidance)</p> <p>(C) PICREP = (Refer to Section B, General Guidance)</p> <p>(O) CONDTN = [1 (under construction), 2 (ruined), 3 (under reclamation), 5 (planned construction)]</p> <p>(C) refgag = (Refer to letter R)</p> <p>(M) SCAMIN = [EU: 90000; US: 300000]</p> <p>(C) SORDAT = [YYYYMMDD]</p>


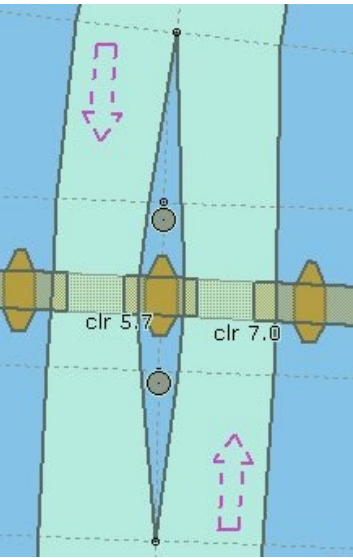
	<ul style="list-style-type: none"> <li>- two way route parts</li> <li>- communication area</li> <li>- fenders</li> <li>- ice breakers</li> <li>- vertical clearance indicators</li> <li>- signal stations</li> <li>- radio call-in points</li> </ul> <p>J) For bridges that consist of only one feature the object name of the bridge is assigned to the bridge object. For bridges with a C_AGGR object the object name has to be assigned to the respective C_AGGR object and not to the bridge object.</p> <p>K) The ISRS Location Code of a bridge is assigned to each single bridge object of the entire bridge (refer to General Guidance section H)</p> <p>L) Use 'verdat' only if vertical datum differs:</p> <ul style="list-style-type: none"> <li>- from DSPM VDAT subfield and</li> <li>- from Meta object 'm_vdat' attribute</li> </ul> <p>M) If a structured external XML-file with more detailed communication information is available, the reference to the file has to be entered in the TXTDSC attribute.</p> <p>N) For Notice marks on bridges see O.3.2</p> <p>O) For time schedule (general) see T.1.1</p> <p>P) HORCLR and VERCLR must be encoded for all navigable spans of bridges.</p> <p>Q) If there is no vertical clearance indicator at a bridge, but there is a gauge which can be used to calculate the vertical clearance of the bridge depending on the water level, it should be encoded in accordance with I.3.4.</p> <p>R) EU: If there is a gauge which can be used to calculate the vertical clearance of the bridge, the ISRS Location Code of the gauge shall be encoded in the attribute REFGAG.</p>	<p>(C) SORIND = (Refer to Section B, General Guidance)</p> <p><b>Object Encoding</b></p> <p><b>Object Class = C_AGGR()</b></p> <p>(M) OBJNAM = [name and/or operator/owner]</p> <p>(O) NOBJNM = (Refer to Section B, General Guidance)</p> <p>(O) TXTDSC = (Refer to letter M)</p> <p>(C) unlocd = [ISRS Location Code]</p> <p>(C) SORIND = (Refer to Section B, General Guidance)</p> <p>(C) SORDAT = [YYYYMMDD]</p>
--	--	---

# G - Ports, Waterways

## G.1 Bridges, Tunnels, Overhead Obstructions

### G.1.2 Bridges with Bridge Arches (M)

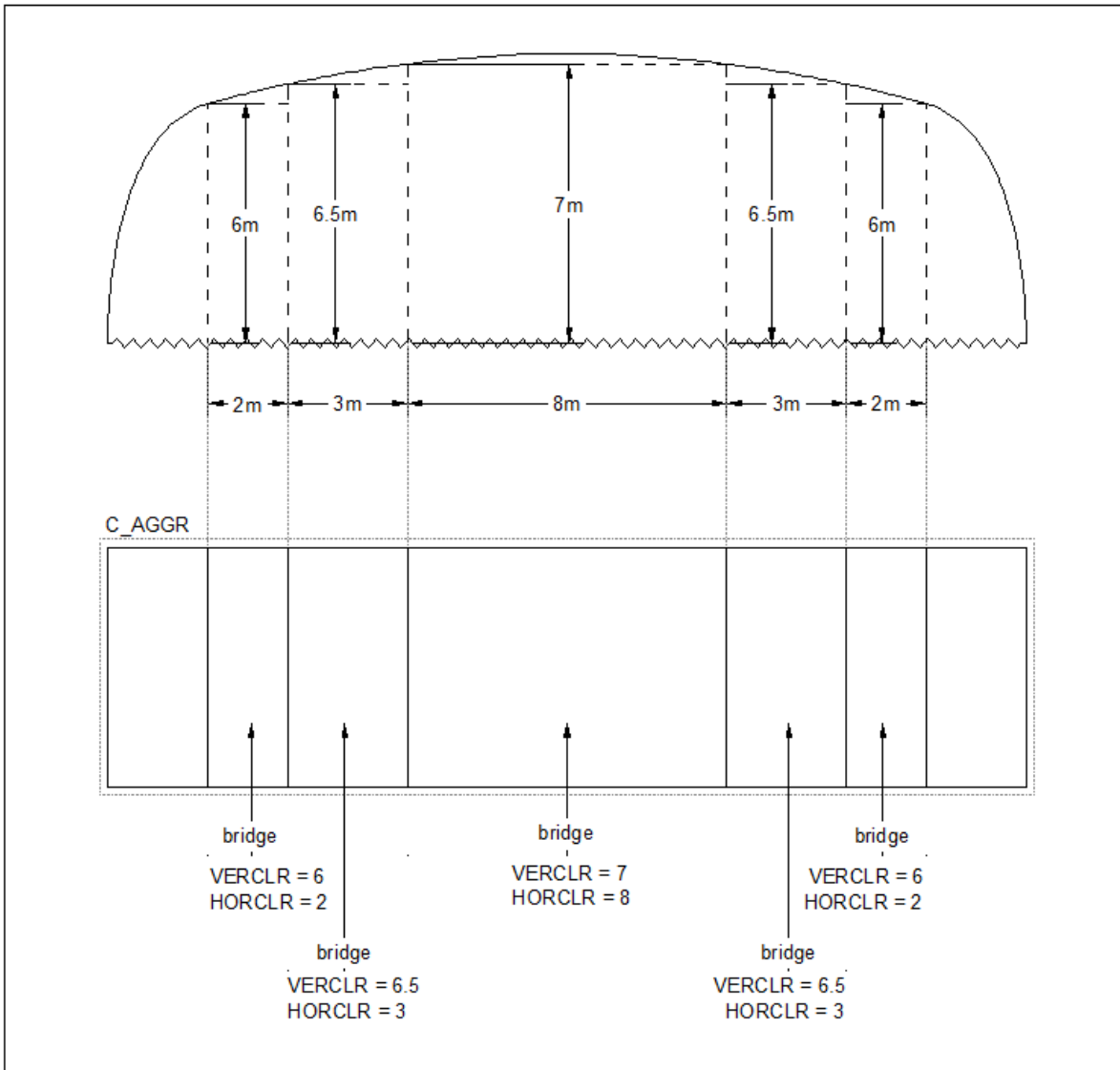
A Bridge which has bridge arches rather than straight construction.

Graphics	Encoding Instructions	Object Encoding
<p><i>Real World</i></p>  <p><i>IENC Symbolization</i></p> 	<p>A) Pylons shall be encoded as PYLONS (refer to G.1.10 – Pylons, Piers and Bridge, Cable, Pipeline Support)</p> <p>B) The following instructions are only necessary if the available space according to the beam and air-draft of the vessel shall be indicated.</p> <p>This is only possible if the arch of the bridge can be separated into different single pieces with known vertical clearances or if the arc is mathematically known.</p> <p>-Create several bridge objects with CATBRG = 13 (bridge arch) for one bridge arch.</p> <p>-The number of the bridge objects depends on the resolution of the different vertical clearances which shall be provided. The width of the element with the biggest vertical clearance should not be less than the typical width of vessels (12m for European waterways of CEMT class IVa and above).</p> <p>-The areas must not overlap.</p> <p>-All of the bridge object of one arch which are situated within the allowed passage must be aggregated by a c_brga object.</p> <p>C) Create separate bridge respectively c_brga objects for spans over navigable channel when attributes of navigable spans are different (e.g. vertical clearance, horizontal clearance).</p> <p>D) Bridge approaches (over the bankline) should be encoded.</p> <p>E) Use PICREP if available.</p> <p>F) Roads and railways on bridges shall not be encoded.</p> <p>G) Place LIGHTS on navigable span and piers bounding navigable span.</p> <p>H) All objects of a bridge which belong</p>	<p><b>Object Encoding</b></p> <p><b>Object Class = bridge(A)</b></p> <p>(M) CATBRG = [1 (fixed bridge), 13 (bridge arch)]</p> <p>(C) HORCLR = [xx.x] (metres), e.g., 34.2</p> <p>(C) VERCLR = [xx.xx] (metres), e.g., 13.27</p> <p>(C) verdat = [12 (Mean lower low water), 31 (Local low water reference level), 32 (Local high water reference level), 33 (Local mean water reference level), 34 (Equivalent height of water (German GIW)), 35 (Highest Shipping Height of Water (German HSW)), 36 (Reference low water level according to Danube Commission), 37 (Highest shipping height of water according to Danube Commission), 38 (Dutch river low water reference level (OLR)), 39 (Russian project water level), 40 (Russian normal backwater level), 41 (Ohio River Datum), 42 (Approximate LAT), 43 (Dutch High Water Reference Level (MHW))]</p> <p>(C) PICREP = (Refer to Section B, General Guidance)</p> <p>(C) unlocd = [ISRS Location Code]</p> <p>(M) wtwdis = [xxxx.xxx] (units defined in hunits), e.g., 2451.732</p> <p>(M) hunits = [3 (kilometres), 4 (hectometres), 5 (statute miles), 6 (nautical miles)]</p> <p>(C) OBJNAM = (Refer to letter I)</p> <p>(C) NOBJNM = (Refer to Section B, General Guidance)</p> <p>(O) CONDTN = [1 (under construction), 2 (ruined), 3 (under reclamation), 5 (planned construction)]</p> <p>(C) refgag = (Refer to letter P)</p> <p>(M) SCAMIN = [EU: 90000; US: 300000]</p> <p>(C) SORDAT = [YYYYMMDD]</p> <p>(C) SORIND = (Refer to Section B, General Guidance)</p> <p><b>Object Encoding</b></p> <p><b>Object Class = C_AGGR()</b></p>

	<p>to one bridge must be combined to one aggregation area (C_AGGR), e.g.</p> <ul style="list-style-type: none"> <li>- pylons</li> <li>- notice marks</li> <li>- bridge lights</li> <li>- buoys at bridge pillar</li> <li>- two way route parts</li> <li>- communication area</li> <li>- fenders</li> <li>- ice breakers</li> <li>- vertical clearance indicators</li> <li>- signal stations</li> <li>- radio call-in points</li> </ul> <p>'c_brga' objects must NOT be included in the C_AGGR.</p> <p>I) For bridges that consist of only one feature the object name of the bridge is assigned to the bridge object. For bridges with a C_AGGR object the object name has to be assigned to the respective C_AGGR object and not to the bridge object.</p> <p>J) The ISRS Location Code of a bridge is assigned to each single bridge object of the entire bridge (refer to General Guidance section H)</p> <p>K) Use 'verdat' only if vertical datum differs:</p> <ul style="list-style-type: none"> <li>- from DSPM VDAT subfield and</li> <li>- from Meta object 'm_vdat' attribute</li> </ul> <p>L) If a structured external XML-file with more detailed communication information is available, the reference to the file has to be entered in the TXTDSC attribute.</p> <p>M) For Notice marks on bridges see O.3.2</p> <p>N) HORCLR and VERCLR must be encoded for all navigable spans of bridges.</p> <p>O) If there is no vertical clearance indicator at a bridge, but there is a gauge which can be used to calculate the vertical clearance of the bridge depending on the water level, it should be encoded in accordance with I.3.4.</p> <p>P) EU: If there is a gauge which can be used to calculate the vertical</p>	<p>(M) OBJNAM = [name and/or operator/owner]</p> <p>(O) NOBJNM = (Refer to Section B, General Guidance)</p> <p>(O) TXTDSC = (Refer to letter L)</p> <p>(C) unlocd = [ISRS Location Code]</p> <p>(C) SORDAT = [YYYYMMDD]</p> <p>(C) SORIND = (Refer to Section B, General Guidance)</p> <p><b><u>Object Encoding</u></b></p> <p><b>Object Class = c_brga()</b></p> <p>(O) OBJNAM = [name and/or operator/owner]</p> <p>(O) NOBJNM = (Refer to Section B, General Guidance)</p> <p>(O) PICREP = (Refer to Section B, General Guidance)</p>
--	---	--

clearance of the bridge, the ISRS  
Location Code of the gauge shall be  
encoded in the attribute REFGAG.

### Bridge Encoding Diagram




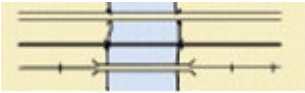
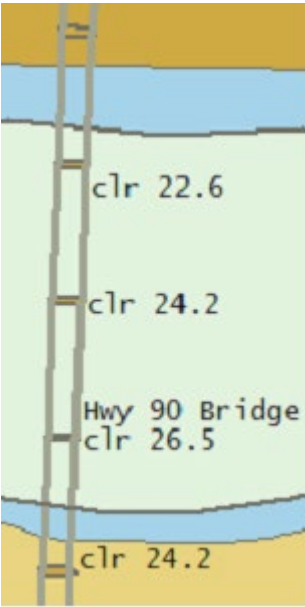


# G - Ports, Waterways

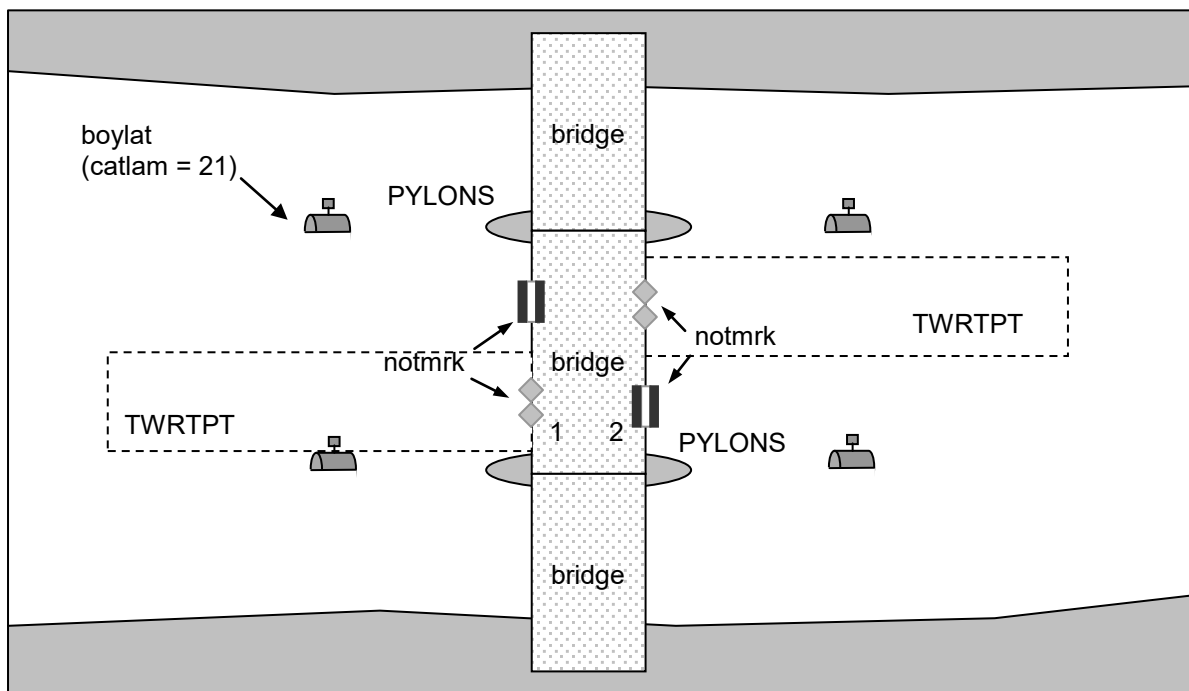
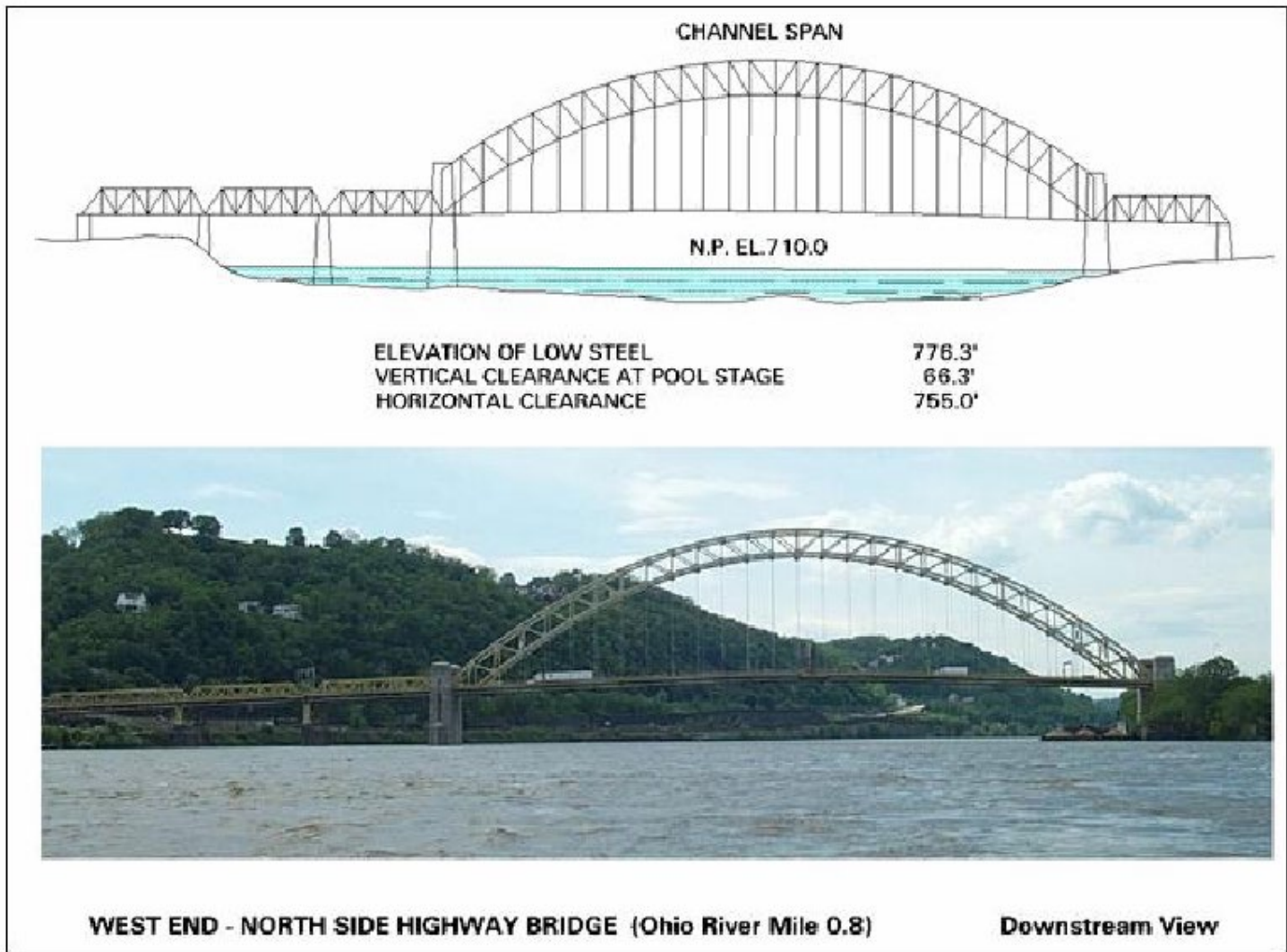
## G.1 Bridges, Tunnels, Overhead Obstructions

### G.1.3 Fixed Bridge (M)

A bridge having permanent horizontal and vertical alignment. (McGraw-Hill Dictionary of Scientific and Technical Terms, 3rd Edition, 1984)

Graphics	Encoding Instructions	Object Encoding
<p><i>Real World</i></p>  <p><i>Chart Symbol</i></p>  <p><i>IENC Symbolization</i></p> 	<p>A) Pylons shall be encoded as PYLONS (refer to G.1.10 – Pylons, Piers and Bridge, Cable, Pipeline Support)</p> <p>B) Create separate bridge objects for spans over navigable channel when attributes of navigable spans are different (e.g. vertical clearance, horizontal clearance).</p> <p>C) US: If separate spans are required, each span's INFORM should indicate whether it is the "Primary Navigation Span", "Secondary Navigation Span", or "Not to be used for Navigation."</p> <p>D) Bridge approaches (over the bankline) should be encoded.</p> <p>E) Use PICREP (sample shown below) representation of profile view with vertical clearance shown. US: PICREP is mandatory EU: PICREP is optional</p> <p>F) Roads and railways on bridges shall not be encoded.</p> <p>G) Place LIGHTS on navigable span and piers bounding navigable span.</p> <p>H) All objects of a bridge which belong to one bridge must be combined to one aggregation area (C_AGGR), e.g.</p> <ul style="list-style-type: none"> <li>- pylons</li> <li>- notice marks</li> <li>- bridge lights</li> <li>- buoys at bridge pillar</li> <li>- two way route parts</li> <li>- communication area</li> <li>- fenders</li> <li>- ice breakers</li> <li>- vertical clearance indicators</li> <li>- signal stations</li> </ul>	<p><b>Object Encoding</b></p> <p><b>Object Class = bridge(A)</b></p> <p>(M) CATBRG = [1 (fixed bridge)]</p> <p>(C) HORCLR = [xx.x] (metres), e.g., 34.2</p> <p>(C) VERCLR = [xx.xx] (metres), e.g., 13.27</p> <p>(C) verdat = [12 (Mean lower low water), 31 (Local low water reference level), 32 (Local high water reference level), 33 (Local mean water reference level), 34 (Equivalent height of water (German GIW)), 35 (Highest Shipping Height of Water (German HSW)), 36 (Reference low water level according to Danube Commission), 37 (Highest shipping height of water according to Danube Commission), 38 (Dutch river low water reference level (OLR)), 39 (Russian project water level), 40 (Russian normal backwater level), 41 (Ohio River Datum), 42 (Approximate LAT), 43 (Dutch High Water Reference Level (MHW))]</p> <p>(C) PICREP = (Refer to Section B, General Guidance)</p> <p>(C) unlocd = [ISRS Location Code]</p> <p>(M) wtwdis = [xxxx.xxx] (units defined in hunits), e.g., 2451.732</p> <p>(M) hunits = [3 (kilometres), 4 (hectometres), 5 (statute miles), 6 (nautical miles)]</p> <p>(C) INFORM = (Refer to letter C)</p> <p>(O) NINFOM = (Refer to Section B, General Guidance)</p> <p>(C) OBJNAM = (Refer to letter I)</p> <p>(C) NOBJNM = (Refer to Section B, General Guidance)</p> <p>(O) CONDTN = [1 (under construction), 2 (ruined), 3 (under reclamation), 5 (planned construction)]</p> <p>(C) refgag = (Refer to letter P)</p> <p>(M) SCAMIN = [EU: 90000; US: 300000]</p> <p>(C) SORIND = (Refer to Section B, General Guidance)</p> <p>(C) SORDAT = [YYYYMMDD]</p>

	<p>- radio call-in points</p> <p>I) For bridges that consist of only one feature the object name of the bridge is assigned to the bridge object. For bridges with a C_AGGR object the object name has to be assigned to the respective C_AGGR object and not to the bridge object.</p> <p>J) The ISRS Location Code of a bridge is assigned to each single bridge object of the entire bridge (refer to General Guidance section H)</p> <p>K) Use 'verdat' only if vertical datum differs:</p> <ul style="list-style-type: none"> <li>- from DSPM VDAT subfield and</li> <li>- from Meta object 'm_vdat' attribute</li> </ul> <p>L) If a structured external XML-file with more detailed communication information is available, the reference to the file has to be entered in the TXTDSC attribute.</p> <p>M) For Notice marks on bridges see O.3.2</p> <p>N) HORCLR and VERCLR must be encoded for all navigable spans of bridges.</p> <p>O) If there is no vertical clearance indicator at a bridge, but there is a gauge which can be used to calculate the vertical clearance of the bridge depending on the water level, it should be encoded in accordance with I.3.4.</p> <p>P) EU: If there is a gauge which can be used to calculate the vertical clearance of the bridge, the ISRS Location Code of the gauge shall be encoded in the attribute REFGAG.</p>	<p><b>Object Encoding</b></p> <p><b>Object Class = C_AGGR()</b></p> <p>(M) OBJNAM = [name and/or operator/owner]</p> <p>(C) NOBJNM = (Refer to Section B, General Guidance)</p> <p>(O) TXTDSC = (Refer to letter L)</p> <p>(C) unlocd = [ISRS Location Code]</p> <p>(C) SORDAT = [YYYYMMDD]</p> <p>(C) SORIND = (Refer to Section B, General Guidance)</p>
--	---	--




# G - Ports, Waterways

## G.1 Bridges, Tunnels, Overhead Obstructions

### G.1.4 Lift Bridge (M)

A movable bridge (or span thereof) which is capable of being lifted vertically to allow vessels to pass beneath. (adapted from IHO Dictionary, S-32, 5th Edition, 547)

Graphics	Encoding Instructions	Object Encoding
<p><i>Real World</i></p>  <p><i>Chart Symbol</i></p>  <p><i>IENC Symbolization</i></p> 	<p>A) Pylons shall be encoded as PYLONS (refer to G.1.10 – Pylons, Piers and Bridge, Cable, Pipeline Support)</p> <p>B) The portions of the bridge that approach the movable span from either shore are to be collected as fixed bridges (separate objects). Only that portion of the bridge that is actually movable is to be collected as a movable bridge.</p> <p>C) Create separate bridge objects for spans over navigable channel when attributes of navigable spans are different (e.g. vertical clearance, horizontal clearance).</p> <p>D) US: If separate spans are required, each span's INFORM should indicate whether it is the "Primary Navigation Span", "Secondary Navigation Span", or "Not to be used for Navigation."</p> <p>E) Bridge approaches (over the bankline) should be encoded.</p> <p>F) Include PICREP, with pictures of bridge when open and closed, if available. US: PICREP is mandatory. EU: PICREP is optional.</p> <p>G) Roads and railways on bridges shall not be encoded.</p> <p>H) All objects of a bridge which belong to one bridge must be combined to one aggregation area (C_AGGR), e.g.</p> <ul style="list-style-type: none"> <li>- pylons</li> <li>- notice marks</li> <li>- bridge lights</li> <li>- buoys at bridge pillar</li> <li>- two way route parts</li> <li>- communication area</li> <li>- fenders</li> </ul>	<p><b>Object Encoding</b></p> <p><b>Object Class</b> = bridge(A)</p> <p>(M) CATBRG = [4 (lifting bridge)]</p> <p>(C) HORCLR = [xx.x] (metres), e.g., 34.2</p> <p>(C) VERCOP = [xx.x] (metres), e.g., 23.4</p> <p>(C) VERCCL = [xx.x] (metres), e.g., 13.2 - over navigable waters</p> <p>(C) verdat = [12 (Mean lower low water), 31 (Local low water reference level), 32 (Local high water reference level), 33 (Local mean water reference level), 34 (Equivalent height of water (German GIW)), 35 (Highest Shipping Height of Water (German HSW)), 36 (Reference low water level according to Danube Commission), 37 (Highest shipping height of water according to Danube Commission), 38 (Dutch river low water reference level (OLR)), 39 (Russian project water level), 40 (Russian normal backwater level), 41 (Ohio River Datum), 42 (Approximate LAT), 43 (Dutch High Water Reference Level (MHW))]</p> <p>(C) unlocd = [ISRS Location Code]</p> <p>(M) wtwdis = [xxxx.xxx] (units defined in hunits), e.g., 2451.732</p> <p>(M) hunits = [3 (kilometres), 4 (hectometres), 5 (statute miles), 6 (nautical miles)]</p> <p>(C) INFORM = (Refer to letter D)</p> <p>(O) NINFOM = (Refer to Section B, General Guidance)</p> <p>(C) PICREP = (Refer to Section B, General Guidance)</p> <p>(C) OBJNAM = (Refer to letter I)</p> <p>(C) NOBJNM = (Refer to Section B, General Guidance)</p> <p>(O) CONDTN = [1 (under construction), 2 (ruined), 3 (under reclamation), 5 (planned construction)]</p> <p>(C) refgag = (Refer to letter Q)</p> <p>(M) SCAMIN = [EU: 90000; US: 300000]</p> <p>(C) SORDAT = [YYYYMMDD]</p>


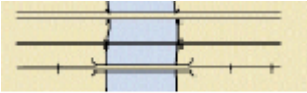
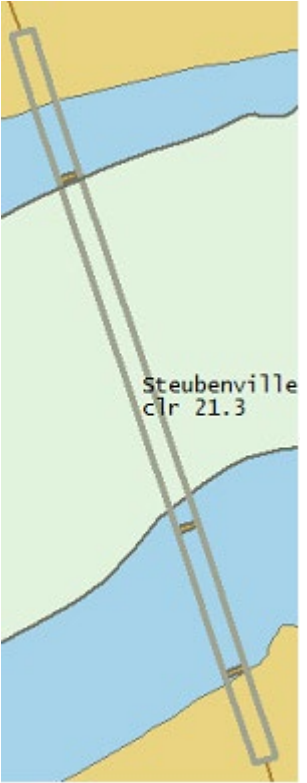
	<ul style="list-style-type: none"> <li>- ice breakers</li> <li>- vertical clearance indicators</li> <li>- signal stations</li> <li>- radio call-in points</li> </ul> <p>I) For bridges that consist of only one feature the object name of the bridge is assigned to the bridge object. For bridges with a C_AGGR object the object name has to be assigned to the respective C_AGGR object and not to the bridge object.</p> <p>J) The ISRS Location Code of a bridge is assigned to each single bridge object of the entire bridge (refer to General Guidance section H)</p> <p>K) Use 'verdat' only if vertical datum differs:</p> <ul style="list-style-type: none"> <li>- from DSPM VDAT subfield and</li> <li>- from Meta object 'm_vdat' attribute</li> </ul> <p>L) If a structured external XML-file with more detailed communication information is available, the reference to the file has to be entered in the TXTDSC attribute.</p> <p>M) For Notice marks on bridges see O.3.2</p> <p>N) For time schedule (general) see T.1.1</p> <p>O) HORCLR and VERCLR must be encoded for all navigable spans of bridges.</p> <p>P) If there is no vertical clearance indicator at a bridge, but there is a gauge which can be used to calculate the vertical clearance of the bridge depending on the water level, it should be encoded in accordance with I.3.4.</p> <p>Q) EU: If there is a gauge which can be used to calculate the vertical clearance of the bridge, the ISRS Location Code of the gauge shall be encoded in the attribute REFGAG.</p>	<p>(C) SORIND = (Refer to Section B, General Guidance)</p> <p><b>Object Encoding</b></p> <p><b>Object Class = C_AGGR()</b></p> <p>(M) OBJNAM = [name and/or operator/owner]</p> <p>(C) NOBJNM = (Refer to Section B, General Guidance)</p> <p>(O) TXTDSC = (Refer to letter L)</p> <p>(C) unlocd = [ISRS Location Code]</p> <p>(C) SORDAT = [YYYYMMDD]</p> <p>(C) SORIND = (Refer to Section B, General Guidance)</p>
--	--	---

# G - Ports, Waterways

## G.1 Bridges, Tunnels, Overhead Obstructions

### G.1.5 Suspension Bridge (M)

A fixed bridge consisting of either a roadway or a truss suspended from two or more cables which pass over towers and are anchored by backstays to a firm foundation. (McGraw-Hill Encyclopaedia of Science and Technology, 7th Edition, 1992)


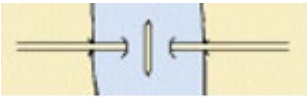
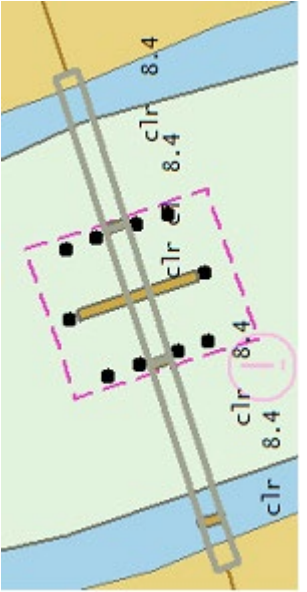
Graphics	Encoding Instructions	Object Encoding
<p><i>Real World</i></p>  <p><i>Chart Symbol</i></p>  <p><i>IENC Symbolization</i></p> 	<p>A) Pylons shall be encoded as PYLONS (refer to G.1.10 – Pylons, Piers and Bridge, Cable, Pipeline Support)</p> <p>B) Create separate bridge objects for spans over navigable channel when attributes of navigable spans are different (e.g. vertical clearance, horizontal clearance).</p> <p>C) US: If separate spans are required, each span's INFORM should indicate whether it is the "Primary Navigation Span", "Secondary Navigation Span", or "Not to be used for Navigation."</p> <p>D) Bridge approaches (over the bankline) should be encoded.</p> <p>E) Use PICREP (sample shown below) representation of profile view with vertical clearance shown. US: PICREP is mandatory EU: PICREP is optional</p> <p>F) Roads and railways on bridges shall not be encoded.</p> <p>G) Place LIGHTS on navigable span and piers bounding navigable span.</p> <p>H) All objects of a bridge which belong to one bridge must be combined to one aggregation area (C_AGGR), e.g.</p> <ul style="list-style-type: none"> <li>- pylons</li> <li>- notice marks</li> <li>- bridge lights</li> <li>- buoys at bridge pillar</li> <li>- two way route parts</li> <li>- communication area</li> <li>- fenders</li> <li>- ice breakers</li> <li>- vertical clearance indicators</li> <li>- signal stations</li> </ul>	<p><b>Object Encoding</b></p> <p><b>Object Class = bridge(A)</b></p> <p>(M) CATBRG = [12 (suspension bridge)]</p> <p>(C) HORCLR = [xx.x] (metres), e.g., 34.2</p> <p>(C) VERCLR = [xx.xx] (metres), e.g., 13.27</p> <p>(C) verdat = [12 (Mean lower low water), 31 (Local low water reference level), 32 (Local high water reference level), 33 (Local mean water reference level), 34 (Equivalent height of water (German GIW)), 35 (Highest Shipping Height of Water (German HSW)), 36 (Reference low water level according to Danube Commission), 37 (Highest shipping height of water according to Danube Commission), 38 (Dutch river low water reference level (OLR)), 39 (Russian project water level), 40 (Russian normal backwater level), 41 (Ohio River Datum), 42 (Approximate LAT), 43 (Dutch High Water Reference Level (MHW))]</p> <p>(C) unlocd = [ISRS Location Code]</p> <p>(M) wtwdis = [xxxx.xxx] (units defined in hunits), e.g., 2451.732</p> <p>(M) hunits = [3 (kilometres), 4 (hectometres), 5 (statute miles), 6 (nautical miles)]</p> <p>(C) INFORM = (Refer to letter C)</p> <p>(O) NINFOM = (Refer to Section B, General Guidance)</p> <p>(C) PICREP = (Refer to Section B, General Guidance)</p> <p>(O) CONDTN = [1 (under construction), 2 (ruined), 3 (under reclamation), 5 (planned construction)]</p> <p>(C) refgag = (Refer to letter P)</p> <p>(M) SCAMIN = [EU: 90000; US: 300000]</p> <p>(C) SORDAT = [YYYYMMDD]</p> <p>(C) SORIND = (Refer to Section B, General Guidance)</p> <p><b>Object Encoding</b></p> <p><b>Object Class = C_AGGR()</b></p> <p>(M) OBJNAM = [name and/or operator/owner]</p>

	<p>- radio call-in points</p> <p>I) For bridges that consist of only one feature the object name of the bridge is assigned to the bridge object. For bridges with a C_AGGR object the object name has to be assigned to the respective C_AGGR object and not to the bridge object.</p> <p>J) The ISRS Location Code of a bridge is assigned to each single bridge object of the entire bridge (refer to General Guidance section H)</p> <p>K) Use 'verdat' only if vertical datum differs:</p> <ul style="list-style-type: none"> <li>- from DSPM VDAT subfield and</li> <li>- from Meta object 'm_vdat' attribute</li> </ul> <p>L) If a structured external XML-file with more detailed communication information is available, the reference to the file has to be entered in the TXTDSC attribute.</p> <p>M) For Notice marks on bridges see O.3.2</p> <p>N) HORCLR and VERCLR must be encoded for all navigable spans of bridges.</p> <p>O) If there is no vertical clearance indicator at a bridge, but there is a gauge which can be used to calculate the vertical clearance of the bridge depending on the water level, it should be encoded in accordance with I.3.4.</p> <p>P) EU: If there is a gauge which can be used to calculate the vertical clearance of the bridge, the ISRS Location Code of the gauge shall be encoded in the attribute REFGAG.</p>	<p>(C) NOBJNM = (Refer to Section B, General Guidance)</p> <p>(O) TXTDSC = (Refer to letter L)</p> <p>(C) unlocd = [ISRS Location Code]</p> <p>(C) SORDAT = [YYYYMMDD]</p> <p>(C) SORIND = (Refer to Section B, General Guidance)</p>
--	---	---

## G.1 Bridges, Tunnels, Overhead Obstructions

### G.1.6 Swing Bridge (M)

A movable bridge (or span thereof) that rotates in a horizontal plane about a vertical pivot to allow the passage of vessels.  
(adapted from McGraw-Hill Encyclopedia of Science and Technology, 7th Edition, 1992)

Graphics	Encoding Instructions	Object Encoding
<p><i>Real World</i></p>  <p><i>Chart Symbol</i></p>  <p><i>IENC Symbolization</i></p> 	<p>A) Pylons shall be encoded as PYLONS (refer to G.1.10 – Pylons, Piers and Bridge, Cable, Pipeline Support)</p> <p>B) The portions of the bridge that approach the movable span from either shore are to be collected as fixed bridges (separate objects). Only that portion of the bridge that is actually movable is to be collected as a movable bridge.</p> <p>C) Create separate bridge objects for spans over navigable channel when attributes of navigable spans are different (e.g., vertical clearance, horizontal clearance).</p> <p>D) US: If separate spans are required, each span's INFORM should indicate whether it is the "Primary Navigation Span", "Secondary Navigation Span", or "Not to be used for Navigation."</p> <p>E) Bridge approaches (over the bankline) should be encoded.</p> <p>F) Include PICREP, with pictures of bridge when open and closed, if available. US: PICREP is mandatory. EU: PICREP is optional.</p> <p>G) Roads and railways on bridges shall not be encoded.</p> <p>H) US &amp; EU: Add a CTNARE object (INFORM = Swing Area) around the swing area that is showing the actual swing area of the swinging bridge span.</p> <p>I) Place LIGHTS at appropriate position on bridge object and piers bounding the navigable channel.</p> <p>J) All objects of a bridge which belong to one bridge must be combined to one aggregation area (C_AGGR), e.g. - pylons</p>	<p><b>Object Encoding</b></p> <p><b>Object Class</b> = bridge(A)</p> <p>(M) CATBRG = [3 (swing bridge)]</p> <p>(C) HORCLR = [xx.x] (metres), e.g., 34.2</p> <p>(C) VERCLR = [xx.xx] (metres), e.g., 13.27</p> <p>(C) verdat = [12 (Mean lower low water), 31 (Local low water reference level), 32 (Local high water reference level), 33 (Local mean water reference level), 34 (Equivalent height of water (German GIW)), 35 (Highest Shipping Height of Water (German HSW)), 36 (Reference low water level according to Danube Commission), 37 (Highest shipping height of water according to Danube Commission), 38 (Dutch river low water reference level (OLR)), 39 (Russian project water level), 40 (Russian normal backwater level), 41 (Ohio River Datum), 42 (Approximate LAT), 43 (Dutch High Water Reference Level (MHW))]</p> <p>(C) unlocd = [ISRS Location Code]</p> <p>(M) wtwdis = [xxxx.xxx] (units defined in hunits), e.g., 2451.732</p> <p>(M) hunits = [3 (kilometres), 4 (hectometres), 5 (statute miles), 6 (nautical miles)]</p> <p>(C) INFORM = (Refer to letter D)</p> <p>(O) NINFOM = (Refer to Section B, General Guidance)</p> <p>(C) PICREP = (Refer to Section B, General Guidance)</p> <p>(C) OBJNAM = (Refer to letter I)</p> <p>(C) NOBJNM = (Refer to Section B, General Guidance)</p> <p>(O) CONDTN = [1 (under construction), 2 (ruined), 3 (under reclamation), 5 (planned construction)]</p> <p>(C) refgag = (Refer to letter S)</p> <p>(M) SCAMIN = [EU: 90000; US: 300000]</p> <p>(C) SORDAT = [YYYYMMDD]</p> <p>(C) SORIND = (Refer to Section B, General Guidance)</p>





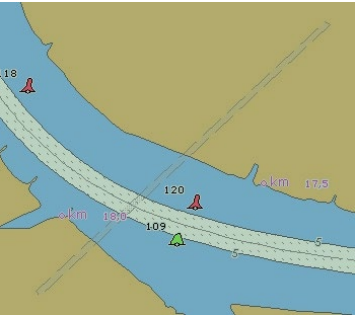
	<ul style="list-style-type: none"> <li>- notice marks</li> <li>- bridge lights</li> <li>- buoys at bridge pillar</li> <li>- two way route parts</li> <li>- communication area</li> <li>- fenders</li> <li>- ice breakers</li> <li>- vertical clearance indicators</li> <li>- signal stations</li> <li>- radio call-in points</li> </ul> <p>K) For bridges that consist of only one feature the object name of the bridge is assigned to the bridge object. For bridges with a C_AGGR object the object name has to be assigned to the respective C_AGGR object and not to the bridge object.</p> <p>L) The ISRS Location Code of a bridge is assigned to each single bridge object of the entire bridge (refer to General Guidance section H)</p> <p>M) Use 'verdat' only if vertical datum differs:</p> <ul style="list-style-type: none"> <li>- from DSPM VDAT subfield and</li> <li>- from Meta object 'm_vdat' attribute</li> </ul> <p>N) If a structured external XML-file with more detailed communication information is available, the reference to the file has to be entered in the TXTDSC attribute.</p> <p>O) For Notice marks on bridges see O.3.2</p> <p>P) For time schedule (general) see T.1.1</p> <p>Q) HORCLR and VERCLR must be encoded for all navigable spans of bridges.</p> <p>R) If there is no vertical clearance indicator at a bridge, but there is a gauge which can be used to calculate the vertical clearance of the bridge depending on the water level, it should be encoded in accordance with I.3.4.</p> <p>S) EU: If there is a gauge which can be used to calculate the vertical clearance of the bridge, the ISRS Location Code of the gauge shall be encoded in the attribute REFGAG.</p>	<p><b><u>Object Encoding</u></b></p> <p><b>Object Class = C_AGGR()</b></p> <p>(M) OBJNAM = [name and/or operator/owner]</p> <p>(C) NOBJNM = (Refer to Section B, General Guidance)</p> <p>(O) TXTDSC = (Refer to letter N)</p> <p>(C) unlocd = [ISRS Location Code]</p> <p>(C) SORDAT = [YYYYMMDD]</p> <p>(C) SORIND = (Refer to Section B, General Guidance)</p> <p><b><u>Object Encoding</u></b></p> <p><b>Object Class = CTNARE(A)</b></p> <p>(M) INFORM = ["Swing Area"]</p> <p>(O) NINFOM = (Refer to Section B, General Guidance)</p> <p>(M) SCAMIN = [60000]</p> <p>(C) SORDAT = [YYYYMMDD]</p> <p>(C) SORIND = (Refer to Section B, General Guidance)</p>
--	---	---

# G - Ports, Waterways

## G.1 Bridges, Tunnels, Overhead Obstructions

### G.1.7 Tunnel (C)

A passage that is open to the atmosphere at both ends, buried under the sea bed or laid over the sea floor or bored under the ground or through mountains. (S-57 Standard)

Graphics	Encoding Instructions	Object Encoding
<p><i>Real World</i></p>  <p><i>Chart Symbol</i></p>  <p><i>IENC Symbolization</i></p> 	<p>A) If there is a waterway navigable at compilation scale, inside the tunnel, this waterway is encoded as a navigable canal with DEPART or DRGARE. There is no LNDARE in the area covering the tunnel.</p> <p>B) If there is a waterway which is not navigable at compilation scale, inside the tunnel, this waterway is encoded as a CANALS. The LNDARE covers the tunnel. The attributes HORCLR and VERCLR are not encoded.</p> <p>C) If there is no waterway in the tunnel (but a railway, a road...) only the TUNNEL should be encoded (not the railway or the road), covered by a LNDARE, DEPART or DRGARE as appropriate. The attributes HORCLR and VERCLR are not encoded.</p> <p>D) If a structured external XML-file with more detailed communication information is available, the reference to the file has to be entered in the TXTDSC attribute.</p> <p>E) If the navigable tunnel has a special time schedule or special operating hours apply, the object can be combined with a time schedule. For this purpose please refer to the time schedule (general) object 'tisdge' see T.1.1</p> <p>F) TUNNEL shall be encoded if:</p> <ul style="list-style-type: none"> <li>- anchoring is prohibited over the tunnel or</li> <li>- the tunnel is navigable i.,e. has a DEPART or DRGARE</li> </ul> <p>G) All objects of a tunnel which belong to one tunnel must be combined to one aggregation area (C_AGGR), if a navigable waterway passes through the tunnel, e.g.</p> <ul style="list-style-type: none"> <li>- notice marks</li> <li>- communication area</li> </ul>	<p><b>Object Encoding</b></p> <p><b>Object Class = TUNNEL(L,A)</b></p> <p>(O) BURDEP = [xx.x ] (metres), e.g., 2.5</p> <p>(C) HORCLR = [xx.x] (metres), e.g., 34.2</p> <p>(C) VERCLR = [xx.xx] (metres), e.g., 13.27</p> <p>(O) OBJNAM = [name and/or operator/owner]</p> <p>(O) NOBJNM = (Refer to Section B, General Guidance)</p> <p>(O) unlocd = [ISRS Location Code]</p> <p>(O) TXTDSC = (Refer to letter D)</p> <p>(O) CONDTN = [1 (under construction), 2 (ruined), 3 (under reclamation), 5 (planned construction)]</p> <p>(M) SCAMIN = [EU: 22000; US: 45000]</p> <p>(C) SORDAT = [YYYYMMDD]</p> <p>(C) SORIND = (Refer to Section B, General Guidance)</p> <p><b>Object Encoding</b></p> <p><b>Object Class = C_AGGR()</b></p> <p>(M) OBJNAM = [name and/or operator/owner]</p> <p>(O) NOBJNM = (Refer to Section B, General Guidance)</p> <p>(O) TXTDSC = (Refer to letter D)</p> <p>(C) unlocd = [ISRS Location Code]</p> <p>(C) SORDAT = [YYYYMMDD]</p> <p>(C) SORIND = (Refer to Section B, General Guidance)</p>


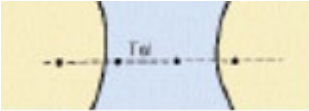

	<ul style="list-style-type: none"><li>- restricted area</li><li>- fenders</li><li>- vertical clearance indicators</li><li>- depth indicators</li><li>- signal stations</li><li>- radio call-in points</li><li>- overhead cables and pipelines</li></ul>	
--	---	--

# G - Ports, Waterways

## G.1 Bridges, Tunnels, Overhead Obstructions

### G.1.8 Overhead Cable (M)

An overhead cable is an assembly of wires or fibres, or a wire rope or chain, which is supported by structures such as poles or pylons and passing over or nearby navigable waters. (Hydrographic Service, Royal Australian Navy).

Graphics	Encoding Instructions	Object Encoding
<p><i>Real World</i></p>  <p><i>Chart Symbol</i></p>  <p><i>IENC Symbolization</i></p> 	<p>A) The value given as the vertical clearance (VERCLR) shall be provided in metres and indicate the vertical distance between the lowest point of the cable (over the navigable part of the waterway) and a defined high water level (e.g. highest shipping height of water) if available.</p> <p>B) If there are multiple cables in the same area, represent only the lowest hanging cable.</p> <p>C) Only if the vertical clearance refers to a vertical datum, which differs from the one given in the DSPM VDAT subfield or in the meta object 'm_vdat', 'cblohd' in combination with verdat shall be used.</p> <p>D) Cable supports (PYLONS, CATPYL = 1 or 2) closest to the landside of the bank line and those within the water must be coded.</p> <p>E) OBJNAM should only be used if the name is relevant for navigation; otherwise use INFORM</p> <p>F) If there is no vertical clearance indicator at a bridge, but there is a gauge which can be used to calculate the vertical clearance of the bridge depending on the water level, it should be encoded in accordance with I.3.4.</p> <p>G) If an overhead cable is connected to a bridge this feature could be aggregated to a bridge by a C_AGGR object.</p> <p>H) EU: If there is a gauge which can be used to calculate the vertical clearance of the bridge, the ISRS Location Code of the gauge shall be encoded in the attribute REFAG.</p>	<p><b>Object Encoding</b></p> <p><b>Object Class</b> = cblohd(L)</p> <p>(M) VERCLR = [xx.x] (metres), e.g., 13.2</p> <p>(M) catchl = [1 (power line), 3 (transmission line), 4 (telephone), 5 (telegraph), 6 (mooring cable/chain), 7 (ferry cable)]</p> <p>(O) verdat = [12 (Mean lower low water), 31 (Local low water reference level), 32 (Local high water reference level), 33 (Local mean water reference level), 34 (Equivalent height of water (German GIW)), 35 (Highest Shipping Height of Water (German HSW)), 36 (Reference low water level according to Danube Commission), 37 (Highest shipping height of water according to Danube Commission), 38 (Dutch river low water reference level (OLR)), 39 (Russian project water level), 40 (Russian normal backwater level), 41 (Ohio River Datum), 42 (Approximate LAT), 43 (Dutch High Water Reference Level (MHW))]</p> <p>(O) wtwdis = [xxxx.xxx] (units defined in hunits), e.g., 2451.732</p> <p>(O) hunits = [3 (kilometres), 4 (hectometres), 5 (statute miles), 6 (nautical miles)]</p> <p>(O) OBJNAM = [name and/or operator/owner] (if relevant for navigation)</p> <p>(O) NOBJNM = (Refer to Section B, General Guidance)</p> <p>(O) INFORM = [name and/or operator/owner] (if relevant in case of accidents)</p> <p>(O) NINFOM = (Refer to Section B, General Guidance)</p> <p>(C) unlocd = [ISRS Location Code]</p> <p>(O) CONDTN = [1 (under construction), 2 (ruined), 3 (under reclamation), 5 (planned construction)]</p> <p>(C) refgag = (Refer to letter H)</p> <p>(M) SCAMIN = [EU: 45000; US: 90000]</p> <p>(C) SORDAT = [YYYYMMDD]</p> <p>(C) SORIND = (Refer to Section B, General Guidance)</p>


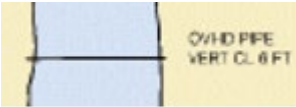

# G - Ports, Waterways

## G.1 Bridges, Tunnels, Overhead Obstructions

### G.1.9 Overhead Pipe (C)

A pipeline is a string of interconnected pipes used for the transport of matter, nowadays mainly oil or gas. (IHO Dictionary, S-32, 5th Edition, 3857)

An overhead pipeline is a pipeline supported by pylons and passing over or nearby navigable waters. (S-57 Standard)

Graphics	Encoding Instructions	Object Encoding
<p><i>Real World</i></p>  <p><i>Chart Symbol</i></p>  <p><i>IENC Symbolization</i></p> 	<p>A) Pipeline supports (PYLONS) closest to the land side of the bankline and those within the water must be coded.</p> <p>B) Pipelines should extend over COALNE onto land a short distance.</p> <p>C) An overhead pipeline over navigable water has to be encoded unless it is on a bridge, does not affect VERCLR and PRODCAT is not 1 (oil), 2 (gas) or 7 (chemicals).</p> <p>D) Overhead pipelines and cables may have significant towers that should be captured as "tower" [LNDMRK/CATLMK=17(tower)].</p> <p>E) Lights on the towers should be encoded.</p> <p>F) The value given as the vertical clearance (VERCLR) shall be provided in metres and indicate the vertical distance between the lowest point of the cable (over the navigable part of the waterway) and a defined high water level (e.g. highest shipping height of water) if available.</p> <p>G) The vertical clearances must refer to either the vertical datum given in the DSPM VDAT subfield or to the vertical datum given in the meta object 'm_vdat' if it is not the same as in the DSPM VDAT subfield.</p> <p>H) OBJNAM should only be used if the name is relevant for navigation; otherwise use INFORM.</p> <p>I) If there is no vertical clearance indicator at a bridge, but there is a gauge which can be used to calculate the vertical clearance of the bridge depending on the water level, it should be encoded in accordance with I.3.4.</p> <p>J) This feature could be aggregated to a bridge by a C_AGGR object.</p>	<p><b>Object Encoding</b></p> <p><b>Object Class</b> = pipohd(L)</p> <p>(M) CATPIP = [2 (outfall pipe), 3 (intake pipe), 4 (sewer), 6 (supply pipe)]</p> <p>(M) PRODCAT = [1 (oil), 2 (gas), 3 (water), 7 (chemicals), 8 (drinking water)]</p> <p>(M) VERCLR = [xx.xx] (metres), e.g., 13.27</p> <p>(O) verdat = [12 (Mean lower low water), 31 (Local low water reference level), 32 (Local high water reference level), 33 (Local mean water reference level), 34 (Equivalent height of water (German GIW)), 35 (Highest Shipping Height of Water (German HSW)), 36 (Reference low water level according to Danube Commission), 37 (Highest shipping height of water according to Danube Commission), 38 (Dutch river low water reference level (OLR)), 39 (Russian project water level), 40 (Russian normal backwater level), 41 (Ohio River Datum), 42 (Approximate LAT), 43 (Dutch High Water Reference Level (MHW))]</p> <p>(O) wtwdis = [xxxx.xxx] (units defined in hunits), e.g., 2451.732</p> <p>(O) hunits = [3 (kilometres), 4 (hectometres), 5 (statute miles), 6 (nautical miles)]</p> <p>(O) OBJNAM = [name and/or operator/owner] (if relevant for navigation)</p> <p>(O) NOBJNM = (Refer to Section B, General Guidance)</p> <p>(O) INFORM = [name and/or operator/owner] (if relevant in case of accidents)</p> <p>(O) NINFOM = (Refer to Section B, General Guidance)</p> <p>(C) unocd = [ISRS Location Code]</p> <p>(O) CONDTN = [1 (under construction), 2 (ruined), 3 (under reclamation), 5 (planned construction)]</p> <p>(C) refgag = (Refer to letter K)</p> <p>(M) SCAMIN = [EU: 22000; US: 90000]</p> <p>(C) SORDAT = [YYYYMMDD]</p>


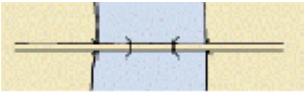

	K) EU: If there is a gauge which can be used to calculate the vertical clearance of the bridge, the ISRS Location Code of the gauge shall be encoded in the attribute REFGAG.	(C) SORIND = (Refer to Section B, General Guidance)
--	---	---

# G - Ports, Waterways

## G.1 Bridges, Tunnels, Overhead Obstructions

### G.1.10 Pylons, Piers, and Bridge, Cable, Pipeline Support (C)

A vertical construction consisting, for example, of a steel framework or pre-stressed concrete to carry cables, pipelines or bridges. (S-57 Standard)

Graphics	Encoding Instructions	Object Encoding
<p><i>Real World</i></p>  <p><i>Chart Symbol (bridge with piers)</i></p>  <p><i>IENC Symbolization (point)</i></p> 	<p>A) Use PYLONS (P) objects to code supports for overhead cables and pipelines (CATPYL=1,2,3).</p> <p>B) PYLON (A) must have a LNDARE underneath</p> <p>C) Pylons and bridge piers in the water and the bridge piers on land closest to the water must be encoded.</p> <p>D) For suspension bridges use CATPYL = 4 (bridge pylon) For all other bridges use CATPYL = 5 (bridge pier)</p> <p>E) This feature could be aggregated to a bridge or an overhead cable or pipeline by a C_AGGR object.</p>	<p><b>Object Encoding</b></p> <p><b>Object Class = PYLONS(P,A)</b></p> <p>(M) CATPYL = [1 (power transmission pylon/pole), 2 (telephone/telegraph pylon/pole), 3 (aerial cableway/sky pylon), 4 (bridge pylon/tower), 5 (bridge pier)]</p> <p>(M) WATLEV = [2 (always dry)]</p> <p>(O) CONDTN = [1 (under construction), 2 (ruined), 3 (under reclamation), 5 (planned construction)]</p> <p>(M) SCAMIN = [EU: 22000; US: 30000]</p> <p>(C) SORDAT = [YYYYMMDD]</p> <p>(C) SORIND = (Refer to Section B, General Guidance)</p>

*IENC Symbolization (area)*







# G - Ports, Waterways

## G.1 Bridges, Tunnels, Overhead Obstructions

### G.1.11 Foot Bridge / Catwalk (M)

A bridge structure used only for pedestrian traffic, commonly found crossing navigable waterways, but also found along waterways over non-navigable water.

Graphics	Encoding Instructions	Object Encoding
<p><i>Real World (Foot Bridge over navigable water)</i></p> 	<p>A) Pylons shall be encoded as PYLONS (refer to G.1.10 – Pylons, Piers and Bridge, Cable, Pipeline Support)</p> <p>B) Create separate bridge objects for spans over navigable channel when attributes of navigable spans are different (e.g. vertical clearance, horizontal clearance).</p> <p>C) US: If separate spans are required, each span's INFORM should indicate whether it is the "Primary Navigation Span", "Secondary Navigation Span" or "Not to be used for Navigation".</p> <p>D) Bridge approaches (over the bankline) should be encoded.</p> <p>E) Place LIGHTS, if applicable, on navigable span and piers bounding the navigable span.</p> <p>F) VERCLR, HORCLR, VERCCL and/or VERCOP, 'wtwdis' and 'hunits' must be encoded for foot bridges and catwalks over navigable water.</p> <p>G) VERCLR should not be encoded for foot-bridges and catwalks over non-navigable water.</p> <p>H) All objects of a bridge which belong to one bridge must be combined to one aggregation area (C_AGGR), e.g.</p> <ul style="list-style-type: none"> <li>- pylons</li> <li>- notice marks</li> <li>- bridge lights</li> <li>- buoys at bridge pillar</li> <li>- two way route parts</li> <li>- communication area</li> <li>- fenders</li> <li>- ice breakers</li> <li>- vertical clearance indicators</li> </ul>	<p><b>Object Encoding</b></p> <p><b>Object Class = bridge(A)</b></p> <p>(M) CATBRG = [9 (footbridge)]</p> <p>(C) HORCLR = [xx.x] (metres), e.g., 34.2</p> <p>(C) VERCLR = [xx.xx] (metres), e.g., 13.27</p> <p>(C) VERCCL = [xx.x] (metres), e.g., 13.2</p> <p>(C) VERCOP = [xx.x] (metres), e.g., 23.4</p> <p>(C) verdat = [12 (Mean lower low water), 31 (Local low water reference level), 32 (Local high water reference level), 33 (Local mean water reference level), 34 (Equivalent height of water (German GIW)), 35 (Highest Shipping Height of Water (German HSW)), 36 (Reference low water level according to Danube Commission), 37 (Highest shipping height of water according to Danube Commission), 38 (Dutch river low water reference level (OLR)), 39 (Russian project water level), 40 (Russian normal backwater level), 41 (Ohio River Datum), 42 (Approximate LAT), 43 (Dutch High Water Reference Level (MHW))]</p> <p>(C) unlocd = [ISRS Location Code]</p> <p>(C) wtwdis = [xxxx.xxx] (units defined in hunits), e.g., 2451.732</p> <p>(C) hunits = [3 (kilometres), 4 (hectometres), 5 (statute miles), 6 (nautical miles)]</p> <p>(C) PICREP = (Refer to Section B, General Guidance)</p> <p>(O) CONDTN = [1 (under construction), 2 (ruined), 3 (under reclamation), 5 (planned construction)]</p> <p>(C) refgag = (Refer to letter N)</p> <p>(M) SCAMIN = [90000]</p> <p>(C) SORDAT = [YYYYMMDD]</p> <p>(C) SORIND = (Refer to Section B, General Guidance)</p> <p><b>Object Encoding</b></p> <p><b>Object Class = C_AGGR()</b></p> <p>(M) OBJNAM = [name and/or operator/owner]</p>
<p><i>Real World (Catwalk over non-navigable water)</i></p> 		




	<ul style="list-style-type: none"> <li>- signal stations</li> <li>- radio call-in points</li> </ul> <p>I) For bridges that consist of only one feature the object name of the bridge is assigned to the bridge object. For bridges with a C_AGGR object the object name has to be assigned to the respective C_AGGR object and not to the bridge object.</p> <p>J) Use 'verdat' only if vertical datum differs:</p> <ul style="list-style-type: none"> <li>- From DSPM VDAT subfield and</li> <li>- From Meta object 'm_vdat' attribute</li> </ul> <p>K) If a structured external XML-file with more detailed communication information is available, the reference to the file has to be entered in the TXTDSC attribute.</p> <p>L) For Notice marks on bridges see O.3.2</p> <p>M) If there is no vertical clearance indicator at a bridge, but there is a gauge which can be used to calculate the vertical clearance of the bridge depending on the water level, it should be encoded in accordance with I.3.4.</p> <p>N) EU: If there is a gauge which can be used to calculate the vertical clearance of the bridge, the ISRS Location Code of the gauge shall be encoded in the attribute REFGAG.</p>	<p>(O) NOBJNM = (Refer to Section B, General Guidance)</p> <p>(O) TXTDSC = (Refer to letter K)</p> <p>(C) unlocd = [ISRS Location Code]</p> <p>(C) SORDAT = [YYYYMMDD]</p> <p>(C) SORIND = (Refer to Section B, General Guidance)</p>
--	--	---

# G - Ports, Waterways

## G.1 Bridges, Tunnels, Overhead Obstructions

### G.1.12 Retractable (Draw) Bridge (O)

A retractable bridge is a type of movable bridge in which the deck can be rolled or slid backwards to open a gap for crossing traffic, usually a ship on a waterway. This type is sometimes referred to as a thrust bridge. The bridge deck of a thrust bridge is retracted to one side and is related to the type S57 CATBRG 7 : Drawbridge

Graphics	Encoding Instructions	Object Encoding
<p><i>Real World</i></p>  <p><i>Real World</i></p>  <p><i>Chart Symbol</i></p> 	<p>A) Pylons shall be encoded as PYLONS (refer to G.1.10 – Pylons, Piers and Bridge, Cable, Pipeline Support)</p> <p>B) The portions of the bridge that approach the movable span from either shore are to be collected as fixed bridges (separate objects). Only that portion of the bridge that is actually movable is to be collected as a movable bridge.</p> <p>C) Create separate bridge objects for spans over navigable channel when attributes of navigable spans are different (e.g. vertical clearance, horizontal clearance).</p> <p>D) US: If separate spans are required, each span's INFORM should indicate whether it is the "Primary Navigation Span", "Secondary Navigation Span", or "Not to be used for Navigation"</p> <p>E) Bridge approaches (over the bankline) should be encoded.</p> <p>F) Include PICREP, with pictures of bridge when open, and closed, if available. US: PICREP is mandatory EU: PICREP is optional</p> <p>G) Roads and railways on bridges shall not be encoded.</p> <p>H) Place LIGHTS at appropriate position on bridge object and piers bounding navigable channel.</p> <p>I) All objects of a bridge which belong to one bridge must be combined to one aggregation area (C_AGGR), e.g. - pylons - notice marks - bridge lights - buoys at bridge pillar</p>	<p><b>Object Encoding</b></p> <p><b>Object Class = bridge(A)</b></p> <p>(M) CATBRG = [7 (draw bridge)]</p> <p>(C) HORCLR = [xx.x] (metres), e.g., 34.2</p> <p>(C) VERCOP = [xx.x] (metres), e.g., 23.4</p> <p>(C) VERCCL = [xx.x] (metres), e.g., 13.2</p> <p>(C) verdat = [12 (Mean lower low water), 31 (Local low water reference level), 32 (Local high water reference level), 33 (Local mean water reference level), 34 (Equivalent height of water (German GIW)), 35 (Highest Shipping Height of Water (German HSW)), 36 (Reference low water level according to Danube Commission), 37 (Highest shipping height of water according to Danube Commission), 38 (Dutch river low water reference level (OLR)), 39 (Russian project water level), 40 (Russian normal backwater level), 41 (Ohio River Datum), 42 (Approximate LAT), 43 (Dutch High Water Reference Level (MHW))]</p> <p>(C) unlocd = [ISRS Location Code]</p> <p>(M) wtwdis = [xxxx.xxx] (units defined in hunits), e.g., 2451.732</p> <p>(M) hunits = [3 (kilometres), 4 (hectometres), 5 (statute miles), 6 (nautical miles)]</p> <p>(C) OBJNAM = (Refer to letter J)</p> <p>(O) NOBJNM = (Refer to Section B, General Guidance)</p> <p>(C) INFORM = (Refer to letter D)</p> <p>(O) NINFOM = (Refer to Section B, General Guidance)</p> <p>(O) PICREP = (Refer to Section B, General Guidance)</p> <p>(O) CONDTN = [1 (under construction), 2 (ruined), 3 (under reclamation), 5 (planned construction)]</p> <p>(M) SCAMIN = [EU: 90000; US: 30000]</p> <p>(C) SORDAT = [YYYYMMDD]</p> <p>(C) SORIND = (Refer to Section B, General</p>



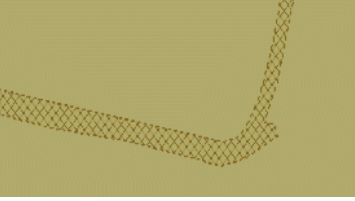
	<ul style="list-style-type: none"> <li>- two way route parts</li> <li>- communication area</li> <li>- fenders</li> <li>- ice breakers</li> <li>- vertical clearance indicators</li> <li>- signal stations</li> <li>- radio call-in points</li> </ul> <p>J) For bridges that consist of only one feature the object name of the bridge is assigned to the bridge object. For bridges with a C_AGGR object the object name has to be assigned to the respective C_AGGR object and not to the bridge object.</p> <p>K) The ISRS Location Code of a bridge is assigned to each single bridge object of the entire bridge (refer to General Guidance section H)</p> <p>L) Use 'verdat' only if vertical datum differs:</p> <ul style="list-style-type: none"> <li>- from DSPM VDAT subfield and</li> <li>- from Meta object 'm_vdat' attribute</li> </ul> <p>M) If a structured external XML-file with more detailed communication information is available, the reference to the file has to be entered in the TXTDSC attribute.</p> <p>N) For Notice marks on bridges see O.3.2</p> <p>O) For time schedule (general) see T.1.1.</p> <p>P) HORCLR and VERCLR must be encoded for all navigable spans of bridges.</p> <p>Q) If there is no vertical clearance indicator at a bridge, but there is a gauge which can be used to calculate the vertical clearance of the bridge depending on the water level, it should be encoded in accordance with I.3.4.</p>	<p>Guidance)</p> <p><b>Object Encoding</b></p> <p><b>Object Class = C_AGGR()</b></p> <p>(M) OBJNAM = [name and/or operator/owner]</p> <p>(O) NOBJNM = (Refer to Section B, General Guidance)</p> <p>(C) TXTDSC = (Refer to letter M)</p> <p>(C) unlocd = [ISRS Location Code]</p> <p>(C) SORDAT = [YYYYMMDD]</p> <p>(C) SORIND = (Refer to Section B, General Guidance)</p>
--	--	---

# G - Ports, Waterways

## G.2 Hydraulic Structures in General

### G.2.1 Dyke / Levee (O)

Artificial earthen embankment, roughly paralleling the waterway, to keep flood waters within the river course.





Graphics	Encoding Instructions	Object Encoding
<p><i>Real World</i></p>  <p><i>Chart Symbol</i></p>  <p><i>IENC Symbolization</i></p> 	<p>A) When a dyke is coincident with the coastline, it must be encoded as a DYKCON and in addition a SLCONS of type line, without CATSLC, along its seaward border.</p> <p>B) When the DYKCON is of type area, it must have a LNDARE underneath.</p> <p>C) At large scale, the dyke crown (the topline of the dyke) may be encoded as a SLOTOP with CATSLO = 2 (embankment).</p> <p>D) The altitude / elevation of the highest point of a dyke above the vertical reference level may be encoded by the attribute HEIGHT</p> <p>E) US: For OBJNAM use name of levee or levee district.</p>	<p><b>Object Encoding</b></p> <p><b>Object Class = DYKCON(L,A)</b></p> <p>(O) HEIGHT = [xxx.x] metres, e.g., 27.4</p> <p>(C) OBJNAM = (Refer to letter E)</p> <p>(O) NOBJNM = (Refer to Section B, General Guidance)</p> <p>(O) INFORM = ["Levee or European dyke"]</p> <p>(O) NINFOM = (Refer to Section B, General Guidance)</p> <p>(O) CONDTN = [1 (under construction), 2 (ruined), 3 (under reclamation), 5 (planned construction)]</p> <p>(M) SCAMIN = [22000]</p> <p>(C) SORDAT = [YYYYMMDD]</p> <p>(C) SORIND = (Refer to Section B, General Guidance)</p> <p><b>Object Encoding</b></p> <p><b>Object Class = SLOTOP(L)</b></p> <p>(M) CATSLO = [2 (embankment)]</p> <p>(O) NATSUR = [1 (mud), 2 (clay), 3 (silt), 4 (sand), 5 (stone), 6 (gravel), 7 (pebbles), 8 (cobbles), 9 (rock), 11 (lava), 14 (coral), 17 (shells), 18 (boulder)]</p> <p>(O) CONDTN = [1 (under construction), 2 (ruined), 3 (under reclamation), 5 (planned construction)]</p> <p>(M) SCAMIN = [22000]</p> <p>(C) SORDAT = [YYYYMMDD]</p> <p>(C) SORIND = (Refer to Section B, General Guidance)</p>

# G - Ports, Waterways

## G.2 Hydraulic Structures in General

### G.2.2 Fence / Floodwall (O)

A natural or man-made barrier used as an enclosure or boundary or for protection, including floodwalls.


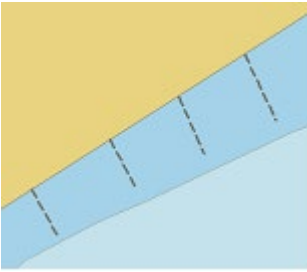
Graphics	Encoding Instructions	Object Encoding
<p><i>Real World</i></p>  <p><i>Real World</i></p>  <p><i>Chart Symbol</i></p>  <p><i>IENC Symbolization</i></p> 	<p>A) Fences, which are highly relevant for calamity abatement or for the access to navigation facilities, might be encoded.</p> <p>B) Floodwalls can be encoded as FNCLNE, CATFNC = 4 (wall), INFORM = floodwall</p> <p>C) If a structured external XML-file with more detailed communication information regarding access to the fenced area is available, the reference to the file has to be entered in the TXTDSC attribute.</p> <p>D) If the fence or flood gate has a special time schedule or special operating hours apply, the object can be combined with a time schedule. For this purpose please refer to the time schedule object 'tisdge' see T.1.1</p> <p>E) US: For OBJNAM use name of floodwall (e.g., Southwest Jefferson County floodwall)</p>	<p><b>Object Encoding</b></p> <p><b>Object Class = FNCLNE(L)</b></p> <p>(M) CATFNC = [1 (fence), 4 (wall)]</p> <p>(O) TXTDSC = (Refer to letter C)</p> <p>(O) OBJNAM = (Refer to letter E)</p> <p>(O) NOBJNM = (Refer to Section B, General Guidance)</p> <p>(O) INFORM = (Refer to letter B)</p> <p>(O) NINFOM = (Refer to Section B, General Guidance)</p> <p>(O) CONDTN = [1 (under construction), 2 (ruined), 3 (under reclamation), 5 (planned construction)]</p> <p>(M) SCAMIN = [EU: 12000; US: 18750]</p> <p>(C) SORDAT = [YYYYMMDD]</p> <p>(C) SORIND = (Refer to Section B, General Guidance)</p>

# G - Ports, Waterways

## G.2 Hydraulic Structures in General

### G.2.3 Groin (C)

A low artificial wall-like structure of durable material extending from the land to seaward for a particular purpose, such as to prevent coast erosion (adapted from IHO Dictionary, S-32, 5th Edition, 2525 and IHO Chart Specifications, M-4)

Graphics	Encoding Instructions	Object Encoding
<p><i>Chart Symbol</i></p>  <p><i>IENC Symbolization</i></p> 	<p>A) If a line feature is used it should denote the centerline of the structure.</p> <p>B) If large-scale information is available dykes/groines may be encoded as area objects. In that case 'slcons' above the high water (US) / mean water (Europe) line must also be encoded with LNDARE (as an area) and the intertidal 'slcons' must also be encoded with DEPARE (as an area).</p> <p>C) Multiple NATCONs can be used, if appropriate.</p> <p>D) If 'slcons' is encoded as an area, the border with the shore may optionally be masked.</p> <p>E) US: Groins (groynes) and dykes are considered synonymous. Use OBJNAM (M) = "Groin" or "Dyke"</p> <p>F) Groins shall be encoded when in or bordering to navigable water.</p>	<p><b>Object Encoding</b></p> <p><b>Object Class</b> = slcons(L,A)</p> <p>(M) catslc = [2 (groyne (groin))]</p> <p>(O) NATCON = [1 (masonry), 2 (concreted), 3 (loose boulders), 4 (hard surfaced), 5 (unsurfaced), 6 (wooden), 7 (metal), 8 (glass reinforced plastic (GRP))]</p> <p>(C) watlev = [1 (partly submerged at high water), 2 (always dry), 3 (always under water/submerged), 4 (covers and uncovers), 8 (above mean water level), 9 (below mean water level)]</p> <p>(C) OBJNAM = [EU: name and/or operator/owner; US refer to letter E]</p> <p>(O) NOBJNM = (Refer to Section B, General Guidance)</p> <p>(O) CONDTN = [1 (under construction), 2 (ruined), 3 (under reclamation), 5 (planned construction)]</p> <p>(M) SCAMIN = [EU: 45000 for line objects or 22000 for area objects; US: 45000]</p> <p>(C) SORDAT = [YYYYMMDD]</p> <p>(C) SORIND = (Refer to Section B, General Guidance)</p>

# G - Ports, Waterways

## G.2 Hydraulic Structures in General

### G.2.4 Ground Sill (C)

A natural or artificial small elevation in the river bed, which is due to sedimentation of till. DIN 4054: regulation structure built on the ground of a waterway that is higher than the ground itself.





Graphics	Encoding Instructions	Object Encoding
	<p>A) If a line feature is used it should denote the centerline of the structure.</p> <p>B) If large-scale information is available ground sills may be encoded as area objects. SLCONS must also be encoded with DEPARE (as an area).</p> <p>C) Multiple NATCONs can be used, if appropriate.</p> <p>D) If SLCONS is encoded as an area, the border with the shore may optionally be masked.</p> <p>E) Ground sills shall be encoded if in navigable water and relevant when using an anchor, e.g. for maneuvering or emergencies.</p>	<p><b>Object Encoding</b></p> <p><b>Object Class = SLCONS(L,A)</b></p> <p>(M) CATSLC = [2 (groynes (groin))]</p> <p>(O) NATCON = [1 (masonry), 2 (concreted), 3 (loose boulders), 4 (hard surfaced), 5 (unsurfaced), 6 (wooden), 7 (metal), 8 (glass reinforced plastic (GRP))]</p> <p>(M) WATLEV = [3 (always under water/submerged)]</p> <p>(O) OBJNAM = [name and/or operator/owner]</p> <p>(O) NOBJNM = (Refer to Section B, General Guidance)</p> <p>(O) INFORM = "ground sill"</p> <p>(O) NINFOM = (Refer to Section B, General Guidance)</p> <p>(O) CONDTN = [1 (under construction), 2 (ruined), 3 (under reclamation), 5 (planned construction)]</p> <p>(M) SCAMIN = [45000 for line objects or 22000 for area objects]</p> <p>(C) SORDAT = [YYYYMMDD]</p> <p>(C) SORIND = (Refer to Section B, General Guidance)</p>



## G.2 Hydraulic Structures in General

### G.2.5 Revetment (O)

Facing of concrete blocks linked together, stone, masonry or broken rock placed along the edge of a stream, river or canal to stabilize the bank and to protect it from the erosive action of the stream.

Graphics	Encoding Instructions	Object Encoding
<p><i>Real World (Revetment)</i></p>  <p><i>Real World (Rip rap)</i></p>  <p><i>Chart Symbol</i></p>  <p><i>IENC Symbolization</i></p> 	<p>A) Delineate outline of known structure. If area limits are unknown, delineate line feature along the shoreline for the length of the structure.</p> <p>B) Revetment areas are generally available in very large scale and detailed vector data. For IENC purposes, revetment areas should be slightly generalized to reduce detail, but generalized larger into the channel in the context of safety.</p> <p>C) For loose stone / rip rap, use catslc = 8 (rip rap) with NATCON = 3 (loose boulders).</p> <p>D) For concrete mattresses, use catslc= 9 (revetment) with NATCON = 2 (concreted).</p> <p>E) Where anchoring or using spuds is prohibited, encode RESARE for sections of the revetment within the waterway.</p>	<p><b>Object Encoding</b></p> <p><b>Object Class</b> = slcons(L,A)</p> <p>(M) catslc = [8 (rip rap), 9 (revetment)]</p> <p>(O) NATCON = [1 (masonry), 2 (concreted), 3 (loose boulders)]</p> <p>(O) OBJNAM = [Name]</p> <p>(O) NOBJNM = (Refer to Section B, General Guidance)</p> <p>(O) watlev = [1 (partly submerged at high water), 2 (always dry), 3 (always under water/submerged), 4 (covers and uncovers), 8 (above mean water level), 9 (below mean water level)]</p> <p>(O) CONDTN = [1 (under construction), 2 (ruined), 3 (under reclamation), 5 (planned construction)]</p> <p>(M) SCAMIN = [EU: 45000; US: 30000]</p> <p>(C) SORDAT = [YYYYMMDD]</p> <p>(C) SORIND = (Refer to Section B, General Guidance)</p> <p><b>Object Encoding</b></p> <p><b>Object Class</b> = RESARE(A)</p> <p>(M) RESTRN = [1 (anchoring prohibited), 38 (use of spuds prohibited)]</p> <p>(M) SCAMIN = [EU: 45000; US: 75000]</p> <p>(C) SORDAT = [YYYYMMDD]</p> <p>(C) SORIND = (Refer to Section B, General Guidance)</p>

## G - Ports, Waterways

### G.2 Hydraulic Structures in General

#### G.2.6 Revetment (Concrete Mattress) (Refer to G.2.5 Revetment) (O)

See G.2.5 Revetment

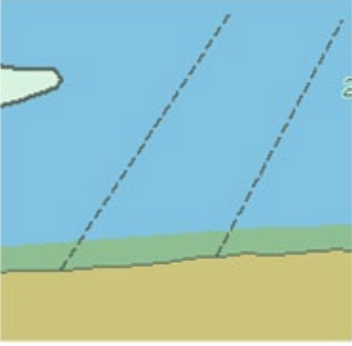
Graphics	Encoding Instructions	Object Encoding

# G - Ports, Waterways

## G.2 Hydraulic Structures in General

### G.2.7 Training Wall (C)

A wall or bank, often submerged, built to direct or confine the flow of a river or tidal current, or to promote a scour action.  
(Adapted from IHO Dictionary, S-32, 5th Edition, 5586 and IHO Chart Specifications, M-4).


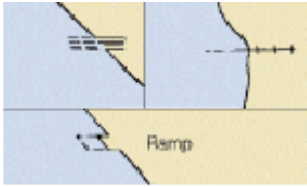
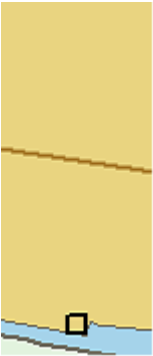
Graphics	Encoding Instructions	Object Encoding
<p><i>IENC Symbolization</i></p> 	<p>A) If a line feature is used it should denote the centerline of the structure.</p> <p>B) If large-scale information is available training wall may be encoded as area objects. In that case 'slcons' above the high water (US) / mean water (Europe) line must also be encoded with LNDARE (as an area) and the inter-tidal 'slcons' must also be encoded with DEPARE (as an area).</p> <p>C) Multiple NATCONs can be used, if appropriate.</p> <p>D) If 'slcons' is encoded as an area, the border with the shore may optionally be masked.</p> <p>E) Inter-tidal or submerged artificial rock walls such as training walls, that are not attached to the shoreline are to be encoded in the following manner: catslc = 7 (training wall) with watlev = 3 (always under water/submerged) or watlev = 4 (covers and uncovers).</p> <p>F) US: Bendway weir: An upstream-angled low-elevation stone sill, built at an elevation low enough to allow normal river traffic to pass over unimpeded, designed to control and redirect currents and velocities throughout a bend of a river. OBJNAM (M) = "Bendway Weir"</p> <p>G) US: For Navigation Weirs see G.4.2 (Dam/Barrier)</p> <p>H) Training walls shall be encoded if in or bordering to navigable water.</p>	<p><b>Object Encoding</b></p> <p><b>Object Class = slcons(L,A)</b></p> <p>(M) catslc = [7 (training wall)]</p> <p>(O) NATCON = [1 (masonry), 2 (concreted), 3 (loose boulders), 4 (hard surfaced), 5 (unsurfaced), 6 (wooden), 7 (metal), 8 (glass reinforced plastic (GRP))]</p> <p>(C) watlev = [1 (partly submerged at high water), 2 (always dry), 3 (always under water/submerged), 4 (covers and uncovers), 8 (above mean water level), 9 (below mean water level)]</p> <p>(C) OBJNAM = [EU: name and/or operator/owner; US: refer to letter F]</p> <p>(O) NOBJNM = (Refer to Section B, General Guidance)</p> <p>(O) CONDTN = [1 (under construction), 2 (ruined), 3 (under reclamation), 5 (planned construction)]</p> <p>(M) SCAMIN = [EU: 45000 for line objects or 22000 for area objects; US: 45000]</p> <p>(C) SORDAT = [YYYYMMDD]</p> <p>(C) SORIND = (Refer to Section B, General Guidance)</p> <p><b>Object Encoding</b></p> <p><b>Object Class = DEPARE(A)</b></p> <p>(M) DRVAL1 = [unknown]</p> <p>(M) DRVAL2 = [xx.x]</p> <p>(C) SORDAT = [YYYYMMDD]</p> <p>(C) SORIND = (Refer to Section B, General Guidance)</p>

# G - Ports, Waterways

## G.3 Installations

### G.3.1 Boat Ramp (C)

A sloping structure that can either be used, as a landing place, at variable water levels, for small vessels, landing ships, or a ferry boats. (Adapted from IHO Dictionary, S-32, 5th Edition, 4209)


Graphics	Encoding Instructions	Object Encoding
<p><i>Real World</i></p>  <p><i>Chart Symbol</i></p>  <p><i>IENC Symbolization</i></p> 	<p>A) The boat ramp should be positioned just above the waterline to be clearly seen by the mariner.</p> <p>B) US: Use STATUS 8 (private) or 14 (public) to indicate ownership, if known.</p> <p>C) Refer to LNDRGN for boat ramps that are not functional but are common landmarks or locations for reference.</p> <p>D) Boat ramps shall be encoded when they extend into navigable water.</p>	<p><b>Object Encoding</b></p> <p><b>Object Class</b> = SLCONS(P,A)</p> <p>(M) CATSLC = [12 (ramp)]</p> <p>(O) NATCON = [1 (masonry), 2 (concreted), 3 (loose boulders), 4 (hard surfaced), 5 (unsurfaced), 6 (wooden), 7 (metal)]</p> <p>(M) WATLEV = [2 (always dry), 4 (covers and uncovers)]</p> <p>(O) OBJNAM = [Name + "Boat Ramp"]</p> <p>(O) NOBJNM = (Refer to Section B, General Guidance)</p> <p>(O) CONDTN = [1 (under construction), 2 (ruined), 3 (under reclamation), 5 (planned construction)]</p> <p>(M) SCAMIN = [EU: 8000; US: 30000]</p> <p>(C) SORDAT = [YYYYMMDD]</p> <p>(C) SORIND = (Refer to Section B, General Guidance)</p> <p>(C) STATUS = (Refer to letter B)</p>

# G - Ports, Waterways

## G.3 Installations

### G.3.2 Bunker / Fueling Station (O)

A station, at which a vessel is able to bunker fuel, water or ballast (Inland ECDIS Standard)


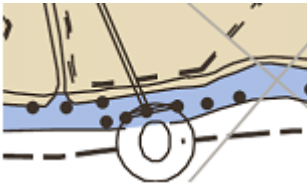
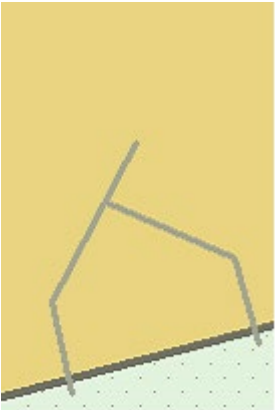
Graphics	Encoding Instructions	Object Encoding
<p><i>IENC Symbolization</i></p> 	<p>A) Use INFORM attribute just in case important information, which is not already encoded, has to be provided to skippers.</p> <p>B) The attribute “Category of bunker vessel” (catbun) is of LIST type and hence more than one value may be chosen.</p> <p>C) If the bunker/fuelling station has a special time schedule or special operating hours apply, the object can be combined with a time schedule. For this purpose please refer to the time schedule (general) object 'tisdge' (T.1.1)</p> <p>D) If a structured external XML-file with more detailed communication information is available, the reference to the file has to be entered in the TXTDSC attribute.</p> <p>E) The object can be used as area object, for example when the station is on a pontoon. In that case the pontoon has only to be coded separately, if no depth data is available underneath.</p> <p>F) If the ISRS Location Code is available it has to be encoded (refer to General Guidance section H).</p>	<p><b>Object Encoding</b></p> <p><b>Object Class = bunsta(P,A)</b></p> <p>(O) catbun = [1 (diesel oil), 2 (water), 3 (ballast), 4 (power)]</p> <p>(O) OBJNAM = [name and/or operator/owner]</p> <p>(O) NOBJNM = (Refer to Section B, General Guidance)</p> <p>(M) bunves = [1 (bunker vessel available), 2 (no bunker vessel available)]</p> <p>(O) TXTDSC = (Refer to letter D)</p> <p>(C) unlocd = [ISRS Location Code]</p> <p>(O) CONDTN = [1 (under construction), 2 (ruined), 3 (under reclamation), 5 (planned construction)]</p> <p>(M) SCAMIN = [22000]</p> <p>(C) SORDAT = [YYYYMMDD]</p> <p>(C) SORIND = (Refer to Section B, General Guidance)</p>

# G - Ports, Waterways

## G.3 Installations

### G.3.3 Conveyor (C)

A mechanical apparatus for moving bulk material or people from place to place (as by a moving belt or chain of receptacles); usually extends from a land-based facility over the shoreline to a dock, wharf, or mooring facility. (Adapted from S-57 Standard)

Graphics	Encoding Instructions	Object Encoding
<p><i>Real World</i></p>  <p><i>Chart Symbol</i></p>  <p><i>IENC Symbolization</i></p> 	<p>A) Place line feature from land-based facility to fixed structure in water at which product loads or offloads.</p> <p>B) Supporting structures (e.g., pylons, piers) should be coded when in the water.</p> <p>C) If the vertical clearance is referred to an inland waterway specific reference level, the object 'convyr' shall be used.</p> <p>D) If a conveyor extends over navigable water it has to be encoded.</p>	<p><b>Object Encoding</b></p> <p><b>Object Class = CONVYR(L,A)</b></p> <p>(M) CATCON = [2 (belt conveyor)]</p> <p>(O) PRODCY = [4 (stone), 5 (coal), 6 (ore), 7 (chemicals), 14 (sand), 15 (timber), 17 (scrap metal), 21 (cement), 22 (grain)]</p> <p>(O) OBJNAM = [Facility Name]</p> <p>(O) NOBJNM = (Refer to Section B, General Guidance)</p> <p>(O) VERCLR = [xx.xx] (metres), e.g., 13.27</p> <p>(O) CONDTN = [1 (under construction), 2 (ruined), 3 (under reclamation), 5 (planned construction)]</p> <p>(M) SCAMIN = [EU: 22000; US: 30000]</p> <p>(C) SORDAT = [YYYYMMDD]</p> <p>(C) SORIND = (Refer to Section B, General Guidance)</p> <p><b>Object Encoding</b></p> <p><b>Object Class = convyr(L,A)</b></p> <p>(M) CATCON = [2 (belt conveyor)]</p> <p>(O) PRODCY = [4 (stone), 5 (coal), 6 (ore), 7 (chemicals), 14 (sand), 15 (timber), 17 (scrap metal), 21 (cement), 22 (grain)]</p> <p>(O) OBJNAM = [Facility Name]</p> <p>(O) NOBJNM = (Refer to Section B, General Guidance)</p> <p>(O) VERCLR = [xx.xx] (metres), e.g., 13.27</p> <p>(O) verdat = [12 (Mean lower low water), 31 (Local low water reference level), 32 (Local high water reference level), 33 (Local mean water reference level), 34 (Equivalent height of water (German GIW)), 35 (Highest Shipping Height of Water (German HSW)), 36 (Reference low water level according to Danube Commission), 37 (Highest shipping height of water according to Danube Commission), 38 (Dutch river low water reference level (OLR)), 39 (Russian project water level), 40 (Russian normal backwater level), 41 (Ohio River Datum), 42</p>


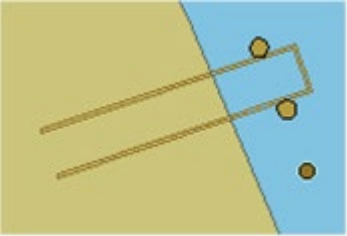
		<p>(Approximate LAT), 43 (Dutch High Water Reference Level (MHW))]</p> <p>(O) CONDTN = [1 (under construction), 2 (ruined), 3 (under reclamation), 5 (planned construction)]</p> <p>(M) SCAMIN = [EU: 22000; US: 30000]</p> <p>(C) SORDAT = [YYYYMMDD]</p> <p>(C) SORIND = (Refer to Section B, General Guidance)</p>
--	--	---

# G - Ports, Waterways

## G.3 Installations

### G.3.4 Crane (C)

A machine for lifting, shifting and lowering objects or materials by means of a swinging boom or with a lifting apparatus supported on an overhead track. (Digital Geographic Information Working Group, Oct.87)

Graphics	Encoding Instructions	Object Encoding
<p><i>Real World</i></p>  <p><i>IENC Symbolization</i></p> 	<p>A) For Area features, delineate the perimeter of the crane.</p> <p>B) If the vertical clearance is referred to an inland waterway specific reference level, the object 'cranes' shall be used.</p> <p>C) If a crane extends over navigable water it has to be encoded.</p>	<p><b>Object Encoding</b></p> <p><b>Object Class = CRANES(P,A)</b></p> <p>(M) CATCRN = [2 (container crane/gantry), 3 (sheerlegs), 4 (travelling crane), 5 (A-frame)]</p> <p>(O) OBJNAM = [name of owner]</p> <p>(O) NOBJNM = (Refer to Section B, General Guidance)</p> <p>(O) VERCLR = [xx.xx] (metres), e.g., 13.27</p> <p>(O) CONDTN = [1 (under construction), 2 (ruined), 3 (under reclamation), 5 (planned construction)]</p> <p>(M) SCAMIN = [EU: 22000; US: 30000]</p> <p>(C) SORDAT = [YYYYMMDD]</p> <p>(C) SORIND = (Refer to Section B, General Guidance)</p> <p><b>Object Encoding</b></p> <p><b>Object Class = cranes(P,A)</b></p> <p>(M) CATCRN = [2 (container crane/gantry), 3 (sheerlegs), 4 (travelling crane), 5 (A-frame)]</p> <p>(O) OBJNAM = [name of owner]</p> <p>(O) NOBJNM = (Refer to Section B, General Guidance)</p> <p>(O) VERCLR = [xx.xx] (metres), e.g., 13.27</p> <p>(O) verdat = [12 (Mean lower low water), 31 (Local low water reference level), 32 (Local high water reference level), 33 (Local mean water reference level), 34 (Equivalent height of water (German GIW)), 35 (Highest Shipping Height of Water (German HSW)), 36 (Reference low water level according to Danube Commission), 37 (Highest shipping height of water according to Danube Commission), 38 (Dutch river low water reference level (OLR)), 39 (Russian project water level), 40 (Russian normal backwater level), 41 (Ohio River Datum), 42 (Approximate LAT), 43 (Dutch High Water Reference Level (MHW))]</p> <p>(O) CONDTN = [1 (under construction), 2 (ruined), 3 (under reclamation), 5 (planned construction)]</p>





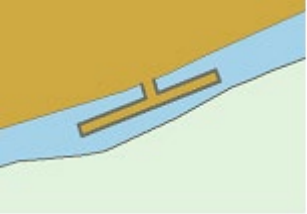

		<p>(M) SCAMIN = [EU: 22000; US: 30000] (C) SORDAT = [YYYYMMDD] (C) SORIND = (Refer to Section B, General Guidance)</p>
--	--	--

# G - Ports, Waterways

## G.3 Installations

### G.3.5 Dock / Wharf (C)

Platform or structure in the water where materials are loaded, unloaded and/or services are provided.

Graphics	Encoding Instructions	Object Encoding
<p><i>Real World</i></p>  <p><i>Chart Symbol</i></p>  <p><i>IENC Symbolization ((Line))</i></p>  <p><i>IENC Symbolization ((Point))</i></p> 	<p>A) Land facilities should be represented with buildings (BUISGL) and storage tank (SILTNK) feature objects.</p> <p>B) Multiple NATCON values can be used, if applicable.</p> <p>C) Docks and wharfs that are bordering to or located in navigable water must be encoded.</p>	<p><b>Object Encoding</b></p> <p><b>Object Class = SLCONS(P,L,A)</b></p> <p>(M) CATSLC = [4 (pier (jetty)), 5 (promenade pier), 6 (wharf (quay)), 15 (solid face wharf), 16 (open face wharf)]</p> <p>(O) NATCON = [1 (masonry), 2 (concreted), 3 (loose boulders), 4 (hard surfaced), 5 (unsurfaced), 6 (wooden), 7 (metal), 8 (glass reinforced plastic (GRP)), 9 (painted)]</p> <p>(M) WATLEV = [1 (partly submerged at high water), 2 (always dry), 4 (covers and uncovers)]</p> <p>(O) OBJNAM = [name]</p> <p>(O) NOBJNM = (Refer to Section B, General Guidance)</p> <p>(O) CONDTN = [1 (under construction), 2 (ruined), 3 (under reclamation), 5 (planned construction)]</p> <p>(M) SCAMIN = [45000 for line, 22000 for area or 8000 for point objects]</p> <p>(C) SORDAT = [YYYYMMDD]</p> <p>(C) SORIND = (Refer to Section B, General Guidance)</p>

*IENC Symbolization ((Area))*


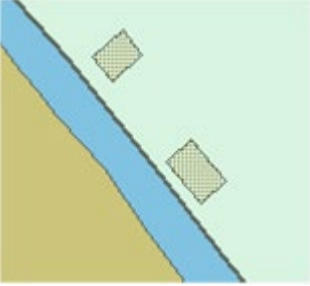


# G - Ports, Waterways

## G.3 Installations

### G.3.6 Dry Dock (O)

An artificial basin fitted with a gate or caisson, into which vessels can be floated and the water pumped out to expose the vessel's bottom. Also called graving dock. (IHO Dictionary, S-32, 5th Edition, 1426)


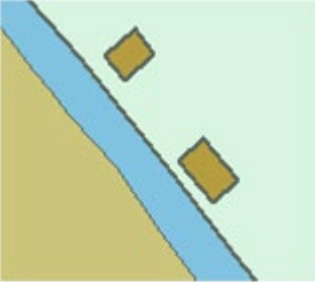
Graphics	Encoding Instructions	Object Encoding
<p><i>Real World</i></p>  <p><i>IENC Symbolization</i></p> 	<p>A) Encode outline of entire structure.</p> <p>B) If a structured external XML-file with more detailed communication information is available, the reference to the file has to be entered in the TXTDSC attribute.</p>	<p><b>Object Encoding</b></p> <p><b>Object Class = DRYDOC(A)</b></p> <p>(O) OBJNAM = [name and/or operator/owner]</p> <p>(O) NOBJNM = (Refer to Section B, General Guidance)</p> <p>(O) HORLEN = [xxx.x] (metres), e.g., 133.22</p> <p>(O) HORWID = [xxx.x] (metres), e.g., 133.22</p> <p>(O) HORCLR = [xx.x] (metres), e.g., 34.2</p> <p>(O) DRVAL1 = [xx.x] (meters), e.g. 4.5</p> <p>(O) TXTDSC = (Refer to letter B)</p> <p>(O) CONDTN = [1 (under construction), 2 (ruined), 3 (under reclamation), 5 (planned construction)]</p> <p>(M) SCAMIN = [EU: 12000; US: 18750]</p> <p>(C) SORDAT = [YYYYMMDD]</p> <p>(C) SORIND = (Refer to Section B, General Guidance)</p>

# G - Ports, Waterways

## G.3 Installations

### G.3.7 Floating Dock (C)

A form of dry dock consisting of a floating structure of one or more sections which can be partly submerged by controlled flooding to receive a vessel, then raised by pumping out the water so that the vessel's bottom can be exposed. (IHO Dictionary, S-32, 5th Edition, 1427)

Graphics	Encoding Instructions	Object Encoding
<p><i>Real World</i></p>  <p><i>IENC Symbolization</i></p> 	<p>A) The lower case letter object 'flodoc' shall be used if depth data is available underneath the floating dock (e.g. by multi beam sounding). If the water depth in the floating dock is referred to an inland waterway reference level, or if the available length and/or width of the dock is different from the physical length/width of the chamber, a depth area has to be coded underneath. In other cases FLODOC shall be used for encoding.</p> <p>B) While FLODOC is a Group I object, 'flodoc' is a Group II object.</p> <p>C) If the floating dock has a special time schedule or special operating hours apply, the object can be combined with a time schedule. For this purpose please refer to the time schedule (general) object 'tisdge' T.1.1.</p> <p>D) If a structured external XML-file with more detailed communication information is available, the reference to the file has to be entered in the TXTDSC attribute.</p> <p>E) Floating docks that are permanently moored at a fixed location must be encoded.</p>	<p><b>Object Encoding</b></p> <p><b>Object Class = flodoc(A)</b></p> <p>(O) OBJNAM = [name and/or operator/owner]</p> <p>(O) NOBJNM = (Refer to Section B, General Guidance)</p> <p>(O) HORLEN = [xxx.x] (metres), e.g., 133.22</p> <p>(O) HORWID = [xxx.x] (metres), e.g., 133.22</p> <p>(O) HORCLR = [xx.x] (metres), e.g., 34.2</p> <p>(C) horcll = [xxx.x] (metres), e.g., 136.12</p> <p>(C) horclw = [xxx.x] (metres), e.g., 25.17</p> <p>(O) DRVAL1 = [xx.x] (metres), e.g. 4.5</p> <p>(O) verdat = [12 (Mean lower low water), 31 (Local low water reference level), 32 (Local high water reference level), 33 (Local mean water reference level), 34 (Equivalent height of water (German GIW)), 35 (Highest Shipping Height of Water (German HSW)), 36 (Reference low water level according to Danube Commission), 37 (Highest shipping height of water according to Danube Commission), 38 (Dutch river low water reference level (OLR)), 39 (Russian project water level), 40 (Russian normal backwater level), 41 (Ohio River Datum), 42 (Approximate LAT), 43 (Dutch High Water Reference Level (MHW))]</p> <p>(O) TXTDSC = (Refer to letter D)</p> <p>(O) CONDTN = [1 (under construction), 2 (ruined), 3 (under reclamation), 5 (planned construction)]</p> <p>(M) SCAMIN = [22000]</p> <p>(M) SORDAT = [YYYYMMDD]</p> <p>(C) SORIND = (Refer to Section B, General Guidance)</p> <p><b>Object Encoding</b></p> <p><b>Object Class = FLODOC(A)</b></p> <p>(O) OBJNAM = [name and/or operato/owner]</p> <p>(O) NOBJNM = (Refer to Section B, General Guidance)</p>


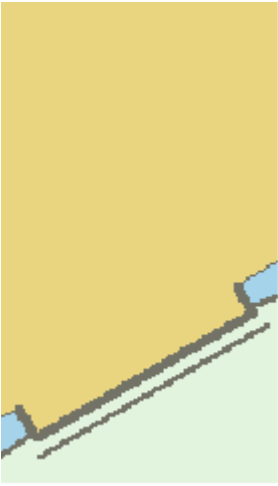
		<p>(O) HORLEN = [xxx.x] (metres), e.g., 133.22</p> <p>(O) HORWID = [xxx.x] (metres), e.g., 133.22</p> <p>(O) HORCLR = [xx.x] (metres), e.g., 34.2</p> <p>(O) DRVAL1 = [x.xx] (metres), e.g., 2.74 or UNKNOWN</p> <p>(O) TXTDSC = (Refer to letter D)</p> <p>(O) CONDTN = [1 (under construction), 2 (ruined), 3 (under reclamation), 5 (planned construction)]</p> <p>(C) SORDAT = [YYYYMMDD]</p> <p>(C) SORIND = (Refer to Section B, General Guidance)</p>
--	--	--

# G - Ports, Waterways

## G.3 Installations

### G.3.8 Fender (C)

A protective structure designed to cushion the impact of a vessel and prevent damage. (S-57 Standard)



Graphics	Encoding Instructions	Object Encoding
<p><i>Real World</i></p>  <p><i>IENC Symbolization</i></p> 	<p>A) Place line feature to accurately reflect the edge facing vessel traffic.</p> <p>B) Fenders need not have depictions of structural pylons behind the fender.</p> <p>C) More than one value may be selected for NATCON.</p> <p>D) For fending constructions like cells in waterway used to protect bridge piers, use CATSLC = 14 (fender); if the structure is greater than 3m in diameter, use an area feature. A LNDARE object must be encoded underneath, if fender is not floating and WATLEV=2.</p> <p>Use point feature for smaller objects.</p> <p>E) Fenders of type point or line must be encoded if the whole object would not be depicted on the chart display otherwise.</p> <p>F) This feature could be aggregated to a lock or a bridge by a C_AGGR object.</p>	<p><b>Object Encoding</b></p> <p><b>Object Class = SLCONS(P,L,A)</b></p> <p>(M) CATSLC = [14 (fender)]</p> <p>(O) NATCON = [1 (masonry), 2 (concreted), 3 (loose boulders), 4 (hard surfaced), 5 (unsurfaced), 6 (wooden), 7 (metal), 8 (glass reinforced plastic (GRP))]</p> <p>(M) WATLEV = [2 (always dry)]</p> <p>(O) CONDTN = [1 (under construction), 2 (ruined), 3 (under reclamation), 5 (planned construction)]</p> <p>(M) SCAMIN = [EU: 22000; US: 30000]</p> <p>(C) SORDAT = [YYYYMMDD]</p> <p>(C) SORIND = (Refer to Section B, General Guidance)</p>

# G - Ports, Waterways

## G.3 Installations

### G.3.9 Harbor Area (C)

The area of water and land with the works necessary for its formation, protection and maintenance.

Graphics	Encoding Instructions	Object Encoding
<p><i>Real World</i></p>  <p><i>IENC Symbolization</i></p> 	<p>A) A harbor area covers the harbor but also the area of land which supplies the harbor installations.</p> <p>B) If a structured external XML-file with more detailed communication information is available, the reference to the file has to be entered in the TXTDSC attribute.</p> <p>C) If the ISRS Location Code is available it has to be encoded (refer to General Guidance section H).</p> <p>D) For yacht harbor / marina, see S.1.2</p> <p>E) EU: Harbour Areas must be encoded.</p>	<p><b>Object Encoding</b></p> <p><b>Object Class = hrbare(A)</b></p> <p>(O) cathbr = [1 (custom harbour), 2 (port of refuge), 4 (fishing harbour), 5 (private harbour)]</p> <p>(M) OBJNAM = [Name of harbor]</p> <p>(O) NOBJNM = (Refer to Section B, General Guidance)</p> <p>(O) TXTDSC = (Refer to letter B)</p> <p>(C) unlocd = [ISRS Location Code]</p> <p>(O) CONDTN = [1 (under construction), 2 (ruined), 3 (under reclamation), 5 (planned construction)]</p> <p>(M) SCAMIN = [22000]</p> <p>(C) SORDAT = [YYYYMMDD]</p> <p>(C) SORIND = (Refer to Section B, General Guidance)</p>





# G - Ports, Waterways

## G.3 Installations


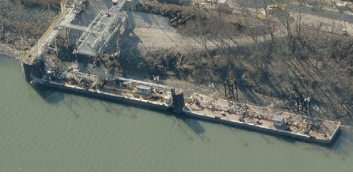

### G.3.10 Harbor Basin (C)

An enclosed area of water surrounded by quay walls constructed to provide means for the transfer of cargo from and to ships.

Graphics	Encoding Instructions	Object Encoding
<p><i>Real World</i></p>  <p><i>IENC Symbolization (with dredged area in the harbour basin)</i></p> 	<p>A) A harbor basin is bordered by shoreline constructions and the entrance to the basin.</p> <p>B) If the ISRS Location Code is available it has to be encoded (refer to General Guidance section H).</p> <p>C) EU: Harbour Basins must be encoded.</p>	<p><b>Object Encoding</b></p> <p><b>Object Class = hrbsn(A)</b></p> <p>(O) HORLEN = [xxx.x] (metres), e.g., 133.22</p> <p>(O) HORWID = [xxx.x] (metres), e.g., 133.22</p> <p>(O) OBJNAM = [name and/or operator/owner]</p> <p>(O) NOBJNM = (Refer to Section B, General Guidance)</p> <p>(C) unlocd = [ISRS Location Code]</p> <p>(O) CONDTN = [1 (under construction), 2 (ruined), 3 (under reclamation), 5 (planned construction)]</p> <p>(M) SCAMIN = [12000]</p> <p>(C) SORDAT = [YYYYMMDD]</p> <p>(C) SORIND = (Refer to Section B, General Guidance)</p>

### G.3.11 Landing Stage, Pontoon (C)

A floating structure, usually rectangular in shape which serves as landing, pier head or bridge support. (IHO dictionary, S-32, 5th edition, 3947)



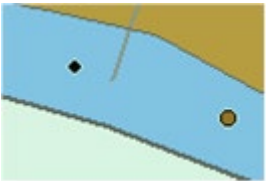
Graphics	Encoding Instructions	Object Encoding
<p><i>Real World</i></p>  <p><i>Real World</i></p>  <p><i>IENC Symbolization</i></p> 	<p>A) Place shape in location, orientation, and dimensions of the Real world object.</p> <p>B) The lower case letter object 'pontoon' shall only be used in case depth data is available underneath the pontoon (e.g., by multi beam sounding) or the ISRS Location Code (unlocd) can be provided. In this case a depth area has to be encoded underneath. In other cases PONTON shall be used for encoding.</p> <p>C) While PONTON is a Group I object, 'pontoon' is a Group II object.</p> <p>D) pontoons whose size is not sufficient to create an area object must be encoded as point SLCONS – CATSLC=4 (pier/jetty). This also applies in case the real dimensions are not known and only a point object can be encoded.</p> <p>E) If the landing stage or pontoon has a special time schedule or special operating hours apply, the object can be combined with a time schedule. For this purpose please refer to the time schedule (general) object 'tisdge' (T.1.1).</p> <p>F) If a structured external XML-file with more detailed communication information is available, the reference to the file has to be entered in the TXTDSC attribute.</p> <p>G) If the ISRS Location Code is available it has to be encoded (refer to General Guidance section H).</p> <p>H) A landing stage and pontoon shall be encoded if a hazard to navigation or when passing vessels are required to reduce speed.</p> <p>I) US &amp; EU: 'pontoon' shall be used for docks made of barges or docks which are floating.</p>	<p><b><u>Object Encoding</u></b></p> <p><b>Object Class = PONTON(A)</b></p> <p>(O) OBJNAM = [name and/or name of operator/owner]</p> <p>(O) NOBJNM = (Refer to Section B, General Guidance)</p> <p>(O) TXTDSC = (Refer to letter F)</p> <p>(O) CONDTN = [1 (under construction), 2 (ruined), 3 (under reclamation), 5 (planned construction)]</p> <p>(C) SORDAT = [YYYYMMDD]</p> <p>(C) SORIND = (Refer to Section B, General Guidance)</p> <p><b><u>Object Encoding</u></b></p> <p><b>Object Class = pontoon(A)</b></p> <p>(O) OBJNAM = [name and/or operator/owner]</p> <p>(O) NOBJNM = (Refer to Section B, General Guidance)</p> <p>(O) TXTDSC = (Refer to letter F)</p> <p>(C) unlocd = [ISRS Location Code]</p> <p>(O) CONDTN = [1 (under construction), 2 (ruined), 3 (under reclamation), 5 (planned construction)]</p> <p>(M) SCAMIN = [EU: 12000; US: 30000]</p> <p>(C) SORDAT = [YYYYMMDD]</p> <p>(C) SORIND = (Refer to Section B, General Guidance)</p>

# G - Ports, Waterways

## G.3 Installations

### G.3.12 Mooring Facility (C)

The equipment or structure used to secure a vessel (adapted from IHO Dictionary, S-32, 5th Edition, 3322)



Graphics	Encoding Instructions	Object Encoding
<p><i>Real World (Mooring Cell)</i></p>  <p><i>Real World (US: Dolphin)</i></p>  <p><i>IENC Symbolization (Point cell (left); dolphin (right))</i></p> 	<p>A) Area feature should be used for structures greater than 3 metres in diameter.</p> <p>B) Use LNDARE beneath feature if not floating and code WATLEV=2 for MORFAC object.</p> <p>C) US: Use CATMOR=5 (post/pile) for mooring cells.</p> <p>D) Place OBJNAM, if known, on each buoy/pile.</p> <p>E) In an instance when a barge has been sunk near the shoreline and dolphins permanently attached to it, code each dolphin as a MORFAC (P), CATMOR=1.</p> <p>F) If individual bollards are encoded, CATMOR = 3 (bollard) shall be used.</p> <p>G) In the event that a MORFAC (A) is used, it is also allowed to encode an additional MORFAC (P) to help aid in the display for planning purposes. The MORFAC (P) should be placed inside the MORFAC (A) on the side closest to the navigation channel.</p> <p>H) Mooring buoys (CATMOR = 7 ) may be placed on land if they are normally on land (LNDARE) and are only found in the water during high water conditions.</p> <p>I) Mooring facilities that are located in navigable water must be encoded.</p>	<p><b>Object Encoding</b></p> <p><b>Object Class = MORFAC(P,L,A)</b></p> <p>(M) CATMOR = [1 (dolphin), 3 (bollard), 4 (tie-up wall), 5 (post or pile), 7 (mooring buoy)]</p> <p>(O) NATCON = [1 (masonry), 2 (concreted), 3 (loose boulders), 4 (hard surfaced), 5 (unsurfaced), 6 (wooden), 7 (metal), 8 (glass reinforced plastic (GRP))]</p> <p>(O) OBJNAM = ["Facility Name"]</p> <p>(O) NOBJNM = (Refer to Section B, General Guidance)</p> <p>(O) WATLEV = [2 (always dry)]</p> <p>(O) CONDTN = [1 (under construction), 2 (ruined), 3 (under reclamation), 5 (planned construction)]</p> <p>(M) SCAMIN = [EU: 22000; US: 30000; for individual bollards: 4000]</p> <p>(C) SORDAT = [YYYYMMDD]</p> <p>(C) SORIND = (Refer to Section B, General Guidance)</p>

# G - Ports, Waterways

## G.3 Installations



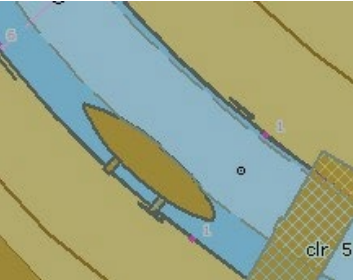
### G.3.13 Federal Mooring Facility (O)

A device designated and maintained by a federal authority for tie-ups and a guaranteed depth year round.

Graphics	Encoding Instructions	Object Encoding
<p><i>Chart Symbol</i></p>  <p><i>IENC Symbolization</i></p> 	<ul style="list-style-type: none"> <li>A) Code MORFAC as stated in G.3.12 Mooring Facility</li> <li>B) Create SEAARE (P) with OBJNAM = "Federal Mooring Cell(s) / Buoy(s) / Block(s)"</li> <li>C) Only one SEAARE should be located at each MORFAC or set of MORFACs</li> </ul>	<p><b><u>Object Encoding</u></b></p> <p><b>Object Class = SEAARE(P)</b></p> <p>(M) OBJNAM = ["Name" + (River Mile)], e.g. Federal Mooring Buoys (172.4)]</p> <p>(O) NOBJNM = (Refer to Section B, General Guidance)</p> <p>(M) SCAMIN = [EU: 22000; US: 60000]</p> <p>(C) SORDAT = [YYYYMMDD]</p> <p>(C) SORIND = (Refer to Section B, General Guidance)</p>

### G.3.14 Permanently Moored Vessel or Facility (C)

A permanently moored ship (S-57 standard)


Graphics	Encoding Instructions	Object Encoding
<p><i>Real World</i></p>  <p><i>Chart Symbol</i></p>  <p><i>IENC Symbolization</i></p> 	<p>A) Place shape in location, orientation, and dimensions of the Real world object.</p> <p>B) The lower case letter object 'hulkes' shall only be used in case depth data is available underneath the hulk (e.g., by multi-beam sounding), it is a casino boat, or the ISRS Location Code (unlocd) can be provided. In this case a depth area has to be encoded underneath. In other cases HULKES shall be used for encoding.</p> <p>C) While HULKES is a Group I object, 'hulkes' is a Group II object.</p> <p>D) If the vessel or facility has a special time schedule or special operating hours apply, the object can be combined with a time schedule. For this purpose refer to the time schedule (general) object 'tisdge' T.1.1.</p> <p>E) If a structured external XML-file with more detailed communication information is available, the reference to the file has to be entered in the TXTDSC attribute.</p> <p>F) If the ISRS Location Code is available it has to be encoded (refer to General Guidance section H).</p> <p>G) Permanently moored vessels or facilities that are located in navigable water must be encoded.</p>	<p><b><u>Object Encoding</u></b></p> <p><b>Object Class = HULKES(A)</b></p> <p>(M) CATHLK = [1 (floating restaurant), 2 (historic ship), 3 (museum), 4 (accommodation), 5 (floating breakwater)]</p> <p>(O) OBJNAM = [facility name]</p> <p>(O) NOBJNM = (Refer to Section B, General Guidance)</p> <p>(O) TXTDSC = (Refer to letter E)</p> <p>(O) CONDTN = [1 (under construction), 2 (ruined), 3 (under reclamation), 5 (planned construction)]</p> <p>(C) SORDAT = [YYYYMMDD]</p> <p>(C) SORIND = (Refer to Section B, General Guidance)</p> <p><b><u>Object Encoding</u></b></p> <p><b>Object Class = hulkes(A)</b></p> <p>(O) cathlk = [1 (floating restaurant), 2 (historic ship), 3 (museum), 4 (accommodation), 5 (floating breakwater), 6 (casino boat)]</p> <p>(O) OBJNAM = [facility name]</p> <p>(O) NOBJNM = (Refer to Section B, General Guidance)</p> <p>(O) TXTDSC = (Refer to letter E)</p> <p>(C) unlocd = [ISRS Location Code]</p> <p>(O) CONDTN = [1 (under construction), 2 (ruined), 3 (under reclamation), 5 (planned construction)]</p> <p>(M) SCAMIN = [EU: 22000; US: 30000]</p> <p>(C) SORDAT = [YYYYMMDD]</p> <p>(C) SORIND = (Refer to Section B, General Guidance)</p>

# G - Ports, Waterways

## G.3 Installations

### G.3.15 Port Area (C)

Apart from harbors, a port includes a city or borough with accommodations and facilities for landing passengers and goods and some amount of overseas trade. A port may possess a harbor but a harbor is not necessarily a port.


Graphics	Encoding Instructions	Object Encoding
<p><i>Real World</i></p> 	<ul style="list-style-type: none"> <li>A) The port area covers the entire area of a city's harbor areas, harbor basins, terminals and harbor facilities.</li> <li>B) Normally it applies only to big international ports.</li> <li>C) A port may possess a harbor but a harbor is not necessarily a port.</li> <li>D) If a structured external XML-file with more detailed communication information is available, the reference to the file has to be entered in the TXTDSC attribute.</li> <li>E) If the ISRS Location Code is available it has to be encoded (refer to General Guidance section H).</li> <li>F) EU: Port Areas must be encoded.</li> </ul>	<p><b><u>Object Encoding</u></b></p> <p><b>Object Class = prtare(A)</b></p> <p>(O) OBJNAM = [name and/or operator/owner]</p> <p>(O) NOBJNM = (Refer to Section B, General Guidance)</p> <p>(C) unlocd = [ISRS Location Code]</p> <p>(O) TXTDSC = (Refer to letter D)</p> <p>(O) CONDTN = [1 (under construction), 2 (ruined), 3 (under reclamation), 5 (planned construction)]</p> <p>(M) SCAMIN = [45000]</p> <p>(C) SORDAT = [YYYYMMDD]</p> <p>(C) SORIND = (Refer to Section B, General Guidance)</p>

# G - Ports, Waterways

## G.3 Installations

### G.3.16 Free Port Area (O)

A port where certain import and export duties are waived (unless goods pass into the country) to facilitate reshipment to other countries. The area covers the water and the land area.


Graphics	Encoding Instructions	Object Encoding
<p><i>IENC Symbolization</i></p> 	<p>A) If a structured external XML-file with more detailed communication information is available, the reference to the file has to be entered in the TXTDSC attribute.</p>	<p><b>Object Encoding</b></p> <p><b>Object Class = FRPARE(A)</b></p> <p>(O) OBJNAM = [name and/or operator/owner]</p> <p>(O) NOBJNM = (Refer to Section B, General Guidance)</p> <p>(C) TXTDSC = (Refer to letter A)</p> <p>(O) CONDTN = [1 (under construction), 2 (ruined), 3 (under reclamation), 5 (planned construction)]</p> <p>(M) SCAMIN = [90000]</p> <p>(C) SORDAT = [YYYYMMDD]</p> <p>(C) SORIND = (Refer to Section B, General Guidance)</p>

# G - Ports, Waterways

## G.3 Installations

### G.3.17 Refuse Dump (O)

At a refuse dump the vessels are able to unload their refuse like waste oil or black water (Inland ECDIS standard)

Graphics	Encoding Instructions	Object Encoding
<p><i>IENC Symbolization</i></p> 	<p>A) Use INFORM attribute just in case important information, which is not already encoded, has to be provided to skippers.</p> <p>B) The attribute “Category of refuse dump” (refdmp) is of LIST type and hence more than one value may be chosen.</p> <p>C) If the refuse dump has a special time schedule or special operating hours apply, the object can be combined with a time schedule. For this purpose please refer to the time schedule (general) object ‘tisdge’ (T.1.1).</p> <p>D) If a structured external XML-file with more detailed communication information is available, the reference to the file has to be entered in the TXTDSC attribute.</p> <p>E) If the ISRS Location Code is available it has to be encoded (refer to General Guidance section H).</p>	<p><b>Object Encoding</b></p> <p><b>Object Class = refdmp(P)</b></p> <p>(O) catrfd = [1 (cargo residue/slop), 2 (waste oil), 3 (grey/black water), 4 (domestic refuse)]</p> <p>(O) OBJNAM = [name and/or operator/owner]</p> <p>(O) NOBJNM = (Refer to Section B, General Guidance)</p> <p>(C) unlocd = [ISRS Location Code]</p> <p>(O) TXTDSC = (Refer to letter D)</p> <p>(O) CONDTN = [1 (under construction), 2 (ruined), 3 (under reclamation), 5 (planned construction)]</p> <p>(M) SCAMIN = [22000]</p> <p>(C) SORDAT = [YYYYMMDD]</p> <p>(C) SORIND = (Refer to Section B, General Guidance)</p>


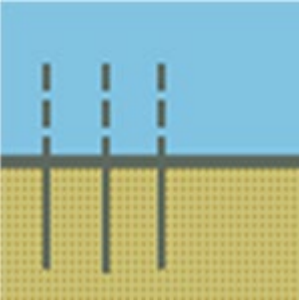


# G - Ports, Waterways

## G.3 Installations

### G.3.18 Slipway (C)

The prepared and usually reinforced inclined surface with installations to launch or lift vessels out of the water in relation to ship construction, repair or maintenance.




Graphics	Encoding Instructions	Object Encoding
<p><i>Real World</i></p>  <p><i>IENC Symbolization</i></p> 	<p>A) The outside edge of the slipway, both on land and in water, should be depicted as closely to its exact location as possible</p> <p>B) Slipways that extend into navigable water must be encoded.</p>	<p><b>Object Encoding</b></p> <p><b>Object Class = SLCONS(A)</b></p> <p>(M) CATSLC = [13 (slipway)]</p> <p>(O) OBJNAM = [name of facility or owner]</p> <p>(O) NOBJNM = (Refer to Section B, General Guidance)</p> <p>(O) CONDTN = [1 (under construction), 2 (ruined), 3 (under reclamation), 5 (planned construction)]</p> <p>(M) SCAMIN = [EU: 8000; US: 45000]</p> <p>(C) SORDAT = [YYYYMMDD]</p> <p>(C) SORIND = (Refer to Section B, General Guidance)</p>

# G - Ports, Waterways

## G.3 Installations

### G.3.19 Terminal (C)

A terminal covers that area on shore that provides buildings and constructions for the transfer of cargo or passengers from and to ships.



Graphics	Encoding Instructions	Object Encoding
<p><i>Real World (container)</i></p>  <p><i>Real World (bulk)</i></p>  <p><i>IENC Symbolization</i></p> 	<p>A) Terminals are not encoded as 'hrbfac' but as 'termnl'.</p> <p>B) A terminal covers the landside area in which all the transshipping facilities and warehouses are located.</p> <p>C) If a structured external XML-file with more detailed communication information is available, the reference to the file has to be entered in the TXTDSC attribute.</p> <p>D) If the terminal has a special time schedule or special operating hours apply, the object can be combined with a time schedule. For this purpose please refer to the time schedule (general) object 'tisdge' see T.1.1</p> <p>E) If the ISRS Location Code is available it has to be encoded (refer to General Guidance section H).</p> <p>F) EU: Terminals must be encoded. If the borderline of the area is not known, the terminal has to be encoded at least as a point object.</p>	<p><b>Object Encoding</b></p> <p><b>Object Class</b> = termnl(P,A)</p> <p>(M) cathaf = [1 (RoRo-terminal), 3 (ferry terminal), 7 (tanker terminal), 8 (passenger terminal), 10 (container terminal), 11 (bulk terminal)]</p> <p>(O) TXTDSC = (Refer to letter C)</p> <p>(O) trshgd = [1 (containers), 2 (bulk goods), 3 (oil), 4 (fuel), 5 (chemicals), 6 (liquid goods), 7 (explosive goods), 8 (fish), 9 (cars), 10 (general cargo)]</p> <p>(O) OBJNAM = [name and/or operator/owner]</p> <p>(O) NOBJNM = (Refer to Section B, General Guidance)</p> <p>(C) unlocd = [ISRS Location Code]</p> <p>(O) CONDTN = [1 (under construction), 2 (ruined), 3 (under reclamation), 5 (planned construction)]</p> <p>(M) SCAMIN = [EU: 12000; US: 18750]</p> <p>(C) SORDAT = [YYYYMMDD]</p> <p>(C) SORIND = (Refer to Section B, General Guidance)</p>

# G - Ports, Waterways

## G.3 Installations

### G.3.20 Vehicle Transfer Location (O)

A place where vehicles can be loaded or unloaded from the inland vessel with onboard or onshore facilities.


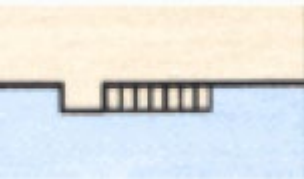
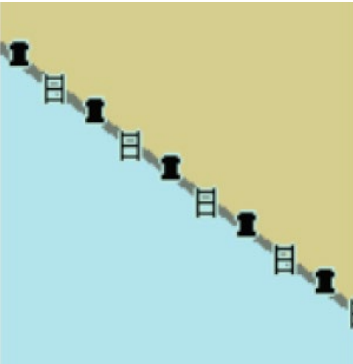
Graphics	Encoding Instructions	Object Encoding
<p><i>Real World</i></p>  <p><i>IENC Symbolization</i></p> 	<p>A) If a structured external XML-file with more detailed communication information is available, the reference to the file has to be entered in the TXTDSC attribute.</p> <p>B) If the vehicle transport location has a special time schedule or special operating hours apply, the object can be combined with a time schedule. For this purpose please refer to the time schedule (general) object 'tisdge' (T.1.1)</p> <p>C) If the ISRS Location Code is available it has to be encoded (refer to General Guidance section H).</p>	<p><b>Object Encoding</b></p> <p><b>Object Class</b> = vehtrf(P,A)</p> <p>(M) catvtr = [1 (official), 2 (private), 3 (suitable for car cranes), 4 (suitable for car planks), 5 (permission required), 6 (locked gate)]</p> <p>(O) TXTDSC = (Refer to letter A)</p> <p>(M) HEIGHT = [xxx.x] metres, e.g., 27.4</p> <p>(O) verdat = [12 (Mean lower low water), 31 (Local low water reference level), 32 (Local high water reference level), 33 (Local mean water reference level), 34 (Equivalent height of water (German GIW)), 35 (Highest Shipping Height of Water (German HSW)), 36 (Reference low water level according to Danube Commission), 37 (Highest shipping height of water according to Danube Commission), 38 (Dutch river low water reference level (OLR)), 39 (Russian project water level), 40 (Russian normal backwater level), 41 (Ohio River Datum), 42 (Approximate LAT), 43 (Dutch High Water Reference Level (MHW))]</p> <p>(C) unlocd = [ISRS Location Code]</p> <p>(O) CONDTN = [1 (under construction), 2 (ruined), 3 (under reclamation), 5 (planned construction)]</p> <p>(M) SCAMIN = [45000]</p> <p>(C) SORDAT = [YYYYMMDD]</p> <p>(C) SORIND = (Refer to Section B, General Guidance)</p>

# G - Ports, Waterways

## G.3 Installations

### G.3.21 Landing Steps, Ladders (O)

Steps at the shoreline as the connection between land and water on different levels. Ladders in quays, jetties, dolphins, etc. to facilitate embarking and disembarking or reaching bollards.



Graphics	Encoding Instructions	Object Encoding
<p><i>Real World</i></p>  <p><i>Chart Symbol</i></p>  <p><i>IENC Symbolization</i></p> 	<p>A) Supporting structures (e.g., pylons, piers) should be coded when in the water.</p>	<p><b>Object Encoding</b></p> <p><b>Object Class = SLCONS(P,A)</b></p> <p>(M) CATSLC = [11 (landing steps)]</p> <p>(O) CONDTN = [1 (under construction), 2 (ruined), 3 (under reclamation), 5 (planned construction)]</p> <p>(M) SCAMIN = [4000]</p> <p>(C) SORDAT = [YYYYMMDD]</p> <p>(C) SORIND = (Refer to Section B, General Guidance)</p>

# G - Ports, Waterways

## G.3 Installations

### G.3.22 Production / Storage Area (O)

An area on land for the exploitation or storage of natural resources. (S-57 Standard)



Graphics	Encoding Instructions	Object Encoding
<p><i>Real World</i></p>  <p><i>IENC Symbolization</i></p> 	<p>A) Only production and storage areas that are connected to transshipment installations and areas that are visually conspicuous should be encoded.</p> <p>B) If a structured external XML-file with more detailed communication information is available, the reference to the file has to be entered in the TXTDSC attribute.</p>	<p><b>Object Encoding</b></p> <p><b>Object Class = PRDARE(A)</b></p> <p>(O) CATPRA = [1 (quarry), 2 (mine), 3 (stockpile), 4 (power station area), 5 (refinery area), 6 (timber yard), 7 (factory area), 8 (tank farm), 9 (wind farm), 10 (slag heap/spoil heap)]</p> <p>(O) PRODCAT = [1 (oil), 2 (gas), 4 (stone), 5 (coal), 6 (ore), 7 (chemicals), 14 (sand), 15 (timber), 17 (scrap metal), 21 (cement), 22 (grain)]</p> <p>(O) CONVIS = [1 (visually conspicuous), 2 (not visually conspicuous)]</p> <p>(O) OBJNAM = [name and/or operator/owner]</p> <p>(O) NOBJNM = (Refer to Section B, General Guidance)</p> <p>(O) STATUS = [2 (occasional), 12 (illuminated), 16 (watched), 17 (un-watched)]</p> <p>(O) TXTDSC = (Refer to letter B)</p> <p>(O) CONDTN = [1 (under construction), 2 (ruined), 3 (under reclamation), 5 (planned construction)]</p> <p>(M) SCAMIN = [12000]</p> <p>(C) SORDAT = [YYYYMMDD]</p> <p>(C) SORIND = (Refer to Section B, General Guidance)</p>

# G - Ports, Waterways

## G.3 Installations

### G.3.23 Ice Breaker (M)

An often wedge-like structure used for protecting a bridge pier, dock, facility, etc. from floating ice or other debris.


Graphics	Encoding Instructions	Object Encoding
<p><i>Real World</i></p>  <p><i>Real World (Aerial View)</i></p> 	<p>A) A LNDARE must be encoded beneath an ice breaker.</p> <p>B) Place OBJNAM, if known, on each ice breaker.</p> <p>C) Ice Breakers in navigable water shall be encoded. At least the first Ice Breakers on shore in the high water river bed should also be encoded if they are relevant for navigation.</p> <p>D) This feature could be aggregated to a bridge or cable or pipeline support by a C_AGGR object.</p>	<p><b>Object Encoding</b></p> <p><b>Object Class</b> = slcons(A)</p> <p>(M) catslc = [19 (ice breaker)]</p> <p>(O) NATCON = [1 (masonry), 2 (concreted), 3 (loose boulders), 4 (hard surfaced), 5 (unsurfaced), 6 (wooden), 7 (metal), 8 (glass reinforced plastic (GRP))]</p> <p>(O) OBJNAM = ["Facility Name"]</p> <p>(O) NOBJNM = (Refer to Section B, General Guidance)</p> <p>(O) watlev = [1 (partly submerged at high water), 2 (always dry), 3 (always under water/submerged), 4 (covers and uncovers), 8 (above mean water level), 9 (below mean water level)]</p> <p>(O) CONDTN = [1 (under construction), 2 (ruined), 3 (under reclamation), 5 (planned construction)]</p> <p>(M) SCAMIN = [EU: 45000; US: 60000]</p> <p>(C) SORDAT = [YYYYMMDD]</p> <p>(C) SORIND = (Refer to Section B, General Guidance)</p>

# G - Ports, Waterways

## G.3 Installations

### G.3.24 Pile or Post (C)

A long heavy timber or section of steel, wood, concrete, etc., forced into the earth which may serve as a support, as for a pier, or a free standing pole within a marine environment. (Adapted from IHO Dictionary, S-32, 5th Edition, 3840).



Graphics	Encoding Instructions	Object Encoding
<p><i>Real World</i></p> 	<p>A) A pile is encoded as MORFAC with CATMOR = 5 when it has been identified as a mooring post (see G.3.12), otherwise it is encoded as PILPNT.</p> <p>B) Stumps of piles that are dangerous to navigation are encoded as OBSTRN with CATOBS = 1 (see J.3.1).</p> <p>C) Piles or posts that are situated in the fairway or have a navigational function (e.g. leading post, post as a marker) have to be encoded.</p> <p>D) If the pile or post has a big diameter it should be encoded as a SLCONS area in accordance with G.3.8.</p> <p>E) The OBJNAM attribute is mandatory for objects of the PILPNT class if the object is a Master Object for a Leading Light, Directional Light or Sector Light. In other situations the attribute is optional for the PILPNT object class</p>	<p><b>Object Encoding</b></p> <p><b>Object Class = PILPNT(P)</b></p> <p>(C) OBJNAM = (Refer to letter E)</p> <p>(O) NOBJNM = (Refer to Section B, General Guidance)</p> <p>(O) CONDTN = [1 (under construction), 2 (ruined), 3 (under reclamation), 5 (planned construction)]</p> <p>(M) SCAMIN = [EU: 22000; US: 30000]</p> <p>(C) SORDAT = [YYYYMMDD]</p> <p>(C) SORIND = (Refer to Section B, General Guidance)</p>

# G - Ports, Waterways

## G.3 Installations

### G.3.25 Water Intake Structure (O)




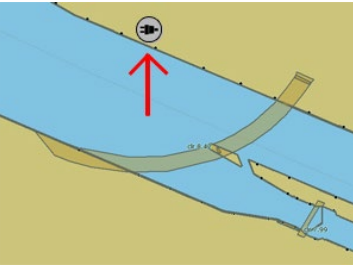
Water intake structures divert water from a river or channel for the purposes of water supply, hydroelectric power and irrigation.

Graphics	Encoding Instructions	Object Encoding
<p><i>Real World</i></p>  <p><i>Real World</i></p> 	<p>A) Multiple NATCON values can be used, if applicable.</p> <p>B) Place OBJNAM, if known, on each water intake structure.</p>	<p><b>Object Encoding</b></p> <p><b>Object Class</b> = slcons(A)</p> <p>(M) catslc = [20 (water intake structure)]</p> <p>(O) NATCON = [1 (masonry), 2 (concreted), 3 (loose boulder), 4 (hard surfaced), 5 (unsurfaced), 6 (wooden), 7 (metal)]</p> <p>(O) OBJNAM = [Facility Name]</p> <p>(O) NOBJNM = (Refer to Section B, General Guidance)</p> <p>(O) WATLEV = [1 (partly submerged at high water), 2 (always dry)]</p> <p>(M) SCAMIN = [EU: 22000, US: 45000]</p> <p>(C) SORDAT = [YYYYMMDD]</p> <p>(C) SORIND = (Refer to Section B, General Guidance)</p>



### G.3.26 Power Supply Station (O)

A station, at which a vessel is able to obtain electric power supply (Inland ECDIS Standard)



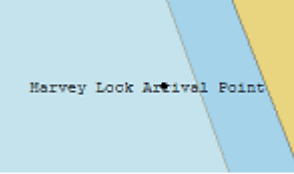
Graphics	Encoding Instructions	Object Encoding
<p><i>Real World</i></p> 	<p>A) Use INFORM attribute just in case important information, which is not already encoded, has to be provided to skippers.</p> <p>B) The attribute “Category of bunker vessel” (catbun) is of LIST type and hence more than one value may be chosen, if a bunker station (G.3.2) is at the same location.</p> <p>C) If the power supply station has a special time schedule or special operating hours apply, the object can be combined with a time schedule. For this purpose please refer to the time schedule (general) object 'tisdge' (T.1.1)</p> <p>D) If a structured external XML-file with more detailed communication information is available, the reference to the file has to be entered in the TXTDSC attribute.</p> <p>E) If the ISRS Location Code is available it has to be encoded (refer to General Guidance section H).</p>	<p><b>Object Encoding</b></p> <p><b>Object Class</b> = bunsta(P)</p> <p>(M) catbun = [4 (power)]</p> <p>(O) OBJNAM = [name and/or operator/owner]</p> <p>(O) NOBJNM = (Refer to Section B, General Guidance)</p> <p>(M) catvol = [1 (230V), 2 (400V)]</p> <p>(M) catfrq = [1 (50Hz), 2 (60Hz)]</p> <p>(M) amoamp = [xxx] (amps), e.g. 300</p> <p>(O) allcon = [allowed consumption], e.g. 2 hours or 1000 kWh</p> <p>(O) catplg = [type of plug], e.g. CEE, Powerlock, etc.</p> <p>(O) shrnum = [xx] (number of connections), e.g. 4</p> <p>(O) TXTDSC = (Refer to letter D)</p> <p>(C) unlocd = [ISRS Location Code]</p> <p>(O) CONDTN = [1 (under construction), 2 (ruined), 3 (under reclamation), 5 (planned construction)]</p> <p>(M) SCAMIN = [22000]</p> <p>(C) SORDAT = [YYYYMMDD]</p> <p>(C) SORIND = (Refer to Section B, General Guidance)</p>
<p><i>Real World</i></p> 		
<p><i>Real World</i></p> 		
<p><i>IENC Symbolization</i></p> 		

# G - Ports, Waterways

## G.4 Locks, Barrages, Exceptional Navigational Structures

### G.4.1 Arrival Point (O)

Arrival point location commonly associated with vessel queues at locks.




Graphics	Encoding Instructions	Object Encoding
<p><i>Real World</i></p>  <p><i>Chart Symbol</i></p>  <p><i>IENC Symbolization</i></p> 	<p>A) If a physical marker exists on land or on a MORFAC (A), designating the location the Arrival Point, a LNDRGN shall be used.</p> <p>B) If no structure exists or if physical marker designating the location of the Arrival Point is on a PILPNT or MORFAC (P), a SEAARE shall be used.</p>	<p><b><u>For Arrival Points on Land</u></b></p> <p><b>Object Class = LNDRGN(P,A)</b></p> <p>(M) OBJNAM = [Facility/Lock Name + "Arrival Point"]</p> <p>(O) NOBJNM = (Refer to Section B, General Guidance)</p> <p>(O) INFORM = Check-in information, such as: Call-in Frequency, Phone Number, and Lock Name</p> <p>(O) NINFOM = (Refer to Section B, General Guidance)</p> <p>(M) TXTDSC = Check-in procedures and current lock conditions, planned closures, and operating schedules.</p> <p>(O) CONDTN = [1 (under construction), 2 (ruined), 3 (under reclamation), 5 (planned construction)]</p> <p>(M) SCAMIN = [45000]</p> <p>(C) SORDAT = [YYYYMMDD]</p> <p>(C) SORIND = (Refer to Section B, General Guidance)</p> <p><b><u>For Arrival Points on Water</u></b></p> <p><b>Object Class = SEAARE(P)</b></p> <p>(M) OBJNAM = [Facility/Lock Name + "Arrival Point"]</p> <p>(O) NOBJNM = (Refer to Section B, General Guidance)</p> <p>(O) INFORM = Check-in information, such as: Call-in Frequency, Phone Number, and Lock Name</p> <p>(O) NINFOM = (Refer to Section B, General Guidance)</p> <p>(M) TXTDSC = Check-in procedures and current lock conditions, planned closures, and operating schedules.</p> <p>(O) CONDTN = [1 (under construction), 2 (ruined), 3 (under reclamation), 5 (planned construction)]</p> <p>(M) SCAMIN = [45000]</p>

		(C) SORDAT = [YYYYMMDD] (C) SORIND = (Refer to Section B, General Guidance)
--	--	--

## G.4 Locks, Barrages, Exceptional Navigational Structures

### G.4.2 Dam / Barrier (O)


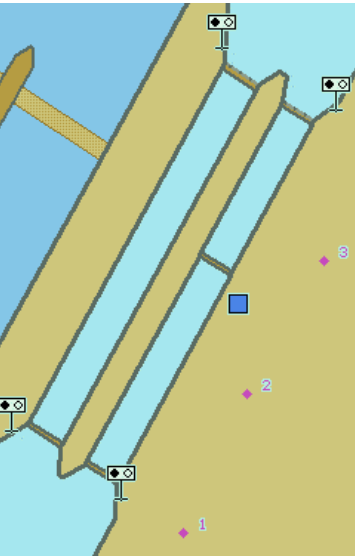
A barrier to check or confine anything in motion; particularly one constructed to hold back water and raise its level to form a reservoir, or to prevent flooding. (IHO Dictionary, S-32, 5th Edition, 1196)

Graphics	Encoding Instructions	Object Encoding
<p><i>Real World</i></p>  <p><i>Chart Symbol</i></p>  <p><i>IENC Symbolization</i></p> 	<p>A) Overlay the feature on LNDARE object.</p> <p>B) If appropriate, place RESARE around dam, extending on both sides of the dam the length of the lock guidewall or the area that is marked by buoys.</p> <p>C) Use OBJNAM option according to most commonly accepted name.</p> <p>D) US: Navigation Weir - a low dam built across a river to raise its level or divert its flow; constructed at an elevation low enough to allow river traffic to pass over it unimpeded during certain times of year. CATDAM = 1 (weir) with appropriate NATCON.</p> <p>E) US: INFORM = "All waters immediately above and below the dam are designated as restricted areas."</p> <p>F) EU &amp; RU: If there are buoys or notice marks to mark the extent of the area, they have to be encoded.</p> <p>G) For openings in a barrier that are navigable at certain water levels see G.4.9 Opening Barrage.</p> <p>H) All objects which belong to a dam / barrier must be combined into one aggregation area (C_AGGR).</p> <p>I) The object name of a barrage is assigned to the respective C_AGGR object using OBJNAM.</p> <p>J) If a structured external XML-file with more detailed communication information is available, the reference to the file has to be entered in the TXTDSC attribute.</p>	<p><b><u>Object Encoding</u></b></p> <p><b>Object Class = DAMCON(L,A)</b></p> <p>(M) CATDAM = [1 (weir), 2 (dam)]</p> <p>(O) NATCON = [1 (masonry), 2 (concreted), 3 (loose boulders), 6 (wooden), 7 (metal)]</p> <p>(O) CONDTN = [1 (under construction), 2 (ruined), 3 (under reclamation), 5 (planned construction)]</p> <p>(M) SCAMIN = [EU: 22000; US: 45000]</p> <p>(C) SORDAT = [YYYYMMDD]</p> <p>(C) SORIND = (Refer to Section B, General Guidance)</p> <p><b><u>Object Encoding</u></b></p> <p><b>Object Class = C_AGGR()</b></p> <p>(M) OBJNAM = [name and/or operator/owner]</p> <p>(O) NOBJNM = (Refer to Section B, General Guidance)</p> <p>(C) unlocd = [ISRS Location Code]</p> <p>(O) TXTDSC = (Refer to letter J)</p> <p>(C) SORDAT = [YYYYMMDD]</p> <p>(C) SORIND = (Refer to Section B, General Guidance)</p> <p><b><u>Please refer to letter B</u></b></p> <p><b>Object Class = RESARE(A)</b></p> <p>(M) CATREA = [12 (navigational aid safety zone)]</p> <p>(M) RESTRN = [7 (entry prohibited), 8 (entry restricted)]</p> <p>(C) INFORM = (Refer to letter E)</p> <p>(M) SCAMIN = [EU: 22000; US: 75000]</p> <p>(C) SORDAT = [YYYYMMDD]</p> <p>(C) SORIND = (Refer to Section B, General Guidance)</p>

## G.4 Locks, Barrages, Exceptional Navigational Structures

### G.4.3 Lock Basin (M)

A lock basin is a wet dock in a waterway, permitting a ship to pass from one level to another. (adapted from IHO Dictionary, S-32, 5th Edition, 2881)

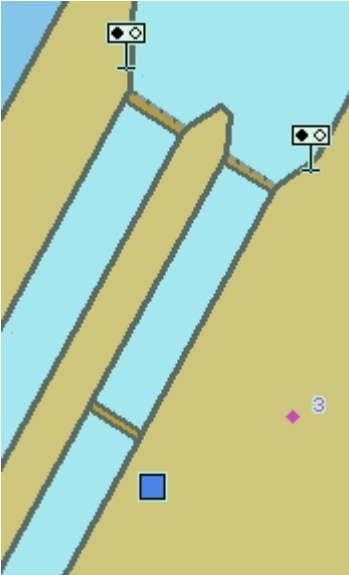
Graphics	Encoding Instructions	Object Encoding
<p><i>Real World</i></p>  <p><i>IENC Symbolization</i></p> 	<p>A) The object class 'lokbsn' must be covered by a DEPARE.</p> <p>B) If the usable horizontal clearance of length and width are distances which are provided by the competent authority for safe navigation, they must be encoded with 'horccl' and 'horclw'.</p> <p>C) The minimum physical length and width given by the building itself must be encoded with HORLEN and HORWID</p> <p>D) All objects of one lock must be combined to one aggregation area (C_AGGR), e.g.</p> <ul style="list-style-type: none"> <li>- lock walls</li> <li>- notice marks</li> <li>- two way route parts</li> <li>- communication area</li> <li>- lock basin</li> <li>- lock basin parts</li> <li>- lock gates</li> <li>- bridges</li> <li>- lock name</li> <li>- fenders</li> <li>- ice breakers</li> <li>- vertical clearance indicators</li> <li>- signal stations</li> <li>- radio call-in points</li> <li>- overhead cables and pipelines</li> </ul> <p>E) The ISRS Location Code of a lock is assigned to each single lokbsn object (refer to General Guidance section H)</p> <p>F) If the lock basin has a special time schedule or special operating hours apply, the object can be combined with a time schedule. For this purpose please refer to the time schedule (general) object 'tisdge'</p>	<p><b>Object Encoding</b></p> <p><b>Object Class = lokbsn(A)</b></p> <p>(M) horccl = [xxx.xx] (metres), e.g., 136.12</p> <p>(M) horclw = [xxx.xx] (metres), e.g. 25.17</p> <p>(O) HORLEN = [xxx.xx] (metres), e.g. 133.22</p> <p>(O) HORWID = [xxx.xx] (metres), e.g. 133.22</p> <p>(C) unlocd = [ISRS Location Code]</p> <p>(O) TXTDSC = (Refer to letter G)</p> <p>(O) OBJNAM = [Lock chamber name]</p> <p>(O) NOBJNM = (Refer to Section B, General Guidance)</p> <p>(O) CONDTN = [1 (under construction), 2 (ruined), 3 (under reclamation), 5 (planned construction)]</p> <p>(M) SCAMIN = [EU: 12000; US: 30000]</p> <p>(C) SORDAT = [YYYYMMDD]</p> <p>(C) SORIND = (Refer to Section B, General Guidance)</p> <p><b>Object Encoding</b></p> <p><b>Object Class = C_AGGR()</b></p> <p>(M) OBJNAM = [name and/or operator/owner]</p> <p>(O) NOBJNM = (Refer to Section B, General Guidance)</p> <p>(O) TXTDSC = (Refer to letter G)</p> <p>(C) unlocd = [ISRS Location Code]</p> <p>(C) SORDAT = [YYYYMMDD]</p> <p>(C) SORIND = (Refer to Section B, General Guidance)</p>

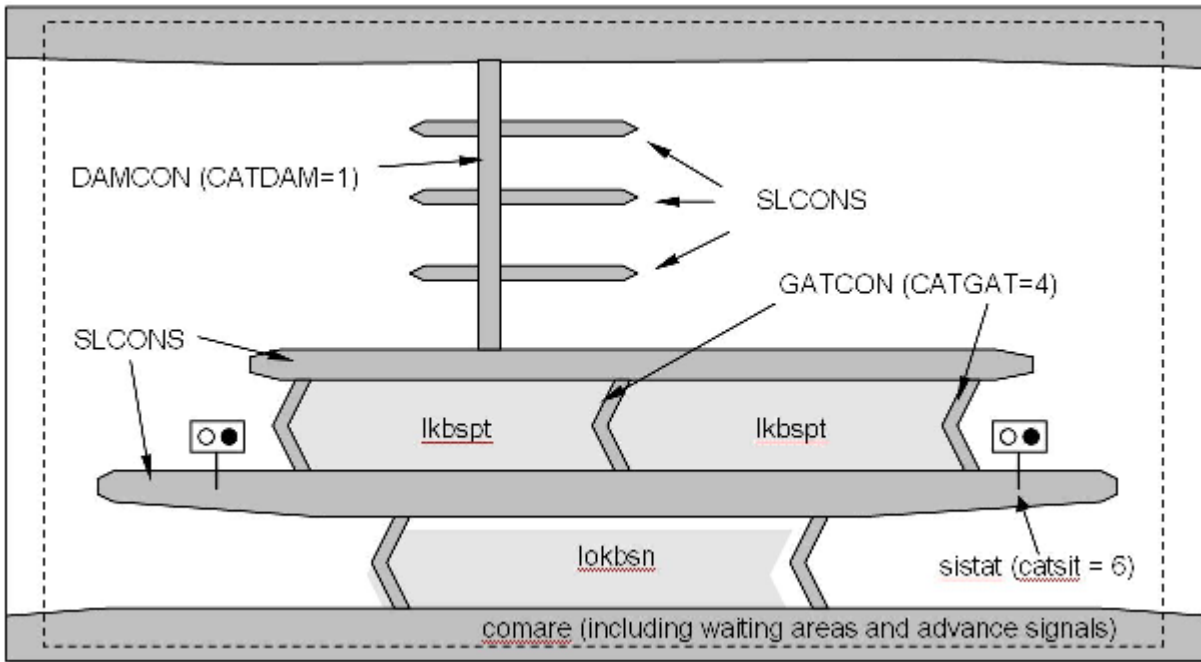
	<p>(T.1.1)</p> <p>G) If a structured external XML-file with more detailed communication information is available, the reference to the file has to be entered in the TXTDSC attribute.</p>	
--	--	--

## G.4 Locks, Barrages, Exceptional Navigational Structures

### G.4.4 Lock Basin Part (O)

A lock basin is divided into several lock basin parts, if this lock basin has one ground level but several gates.

Graphics	Encoding Instructions	Object Encoding
<p><i>IENC Symbolization</i></p> 	<p>A) If a lock basin has more than two gates and the ground level is the same, different lock basin parts must be created.</p> <p>B) The object class 'lkbspt' must be covered by a DEPARE.</p> <p>C) The usable horizontal clearance of length and width are distances which are provided by the competent authority for safe navigation and must be encoded with 'horccl' and 'horclw'.</p> <p>D) The physical length and width given by the building itself must be encoded with HORLEN and HORWID</p> <p>E) All objects which belong to one lock must be combined to one aggregation object (C_AGGR).</p> <p>F) The ISRS Location Code of a lock is assigned to each single 'lkbspt' and 'lokbsn' object of the entire lock (refer to General Guidance section H).</p> <p>G) If the lock basin part has a special time schedule or special operating hours apply, the object can be combined with a time schedule. For this purpose please refer to the time schedule (general) object 'tisdge' (T.1.1)</p> <p>H) If a structured external XML-file with more detailed communication information is available, the reference to the file has to be entered in the TXTDSC attribute.</p>	<p><b>Object Encoding</b></p> <p><b>Object Class = lkbspt(A)</b></p> <p>(M) horccl = [xxx.xx] (metres), e.g., 136.12</p> <p>(M) horclw = [xxx.xx] (metres), e.g. 25.17</p> <p>(O) HORLEN = [xxx.xx] (metres), e.g. 133.22</p> <p>(O) HORWID = [xxx.xx] (metres), e.g. 133.22</p> <p>(C) unlocd = [ISRS Location Code]</p> <p>(O) OBJNAM = [Lock Chamber Name]</p> <p>(O) NOBJNM = (Refer to Section B, General Guidance)</p> <p>(O) TXTDSC = (Refer to letter H)</p> <p>(O) CONDTN = [1 (under construction), 2 (ruined), 3 (under reclamation), 5 (planned construction)]</p> <p>(M) SCAMIN = [EU: 12000; US: 30000]</p> <p>(C) SORDAT = [YYYYMMDD]</p> <p>(C) SORIND = (Refer to Section B, General Guidance)</p> <p><b>Object Encoding</b></p> <p><b>Object Class = C_AGGR()</b></p> <p>(M) OBJNAM = [name and/or operator/owner]</p> <p>(O) NOBJNM = (Refer to Section B, General Guidance)</p> <p>(O) TXTDSC = (Refer to letter H)</p> <p>(C) unlocd = [ISRS Location Code]</p> <p>(C) SORDAT = [YYYYMMDD]</p> <p>(C) SORIND = (Refer to Section B, General Guidance)</p>



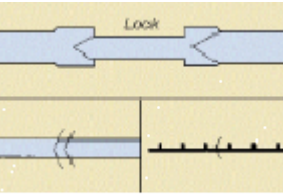





## G.4 Locks, Barrages, Exceptional Navigational Structures

### G.4.5 Lock Gate (M)

Structure swung, drawn, or raised/lowered to hold or release water in a lock.

Graphics	Encoding Instructions	Object Encoding
<p><i>Real World</i></p>  <p><i>Real World (EU: lift door limiting air draught of vessel)</i></p>  <p><i>Chart Symbol</i></p>  <p><i>IENC Symbolization</i></p> 	<p>A) All lock gates must be encoded.</p> <p>B) Linear GATCON features should follow the edge of DEPARE that defines the lock chamber. Area GATCON features have to be placed on a depth area.</p> <p>C) EU: Use gatcon with attribute 'verdat' only if vertical datum differs:                      -from DSPM VDAT subfield and                      -from Meta object 'm_verdat' attribute and specific for inland navigation or in case of a lifting lock door that restricts the air draught</p> <p>D) VERCLR has to be encoded in case of a lifting lock door that restricts the air draught of passing vessels.</p> <p>E) A bridge over a lock door needs to be encoded separately with a bridge object (see G.1)</p> <p>F) 'wtwdis' and 'hunits' shall be encoded if the attribute VERCLR is used.</p> <p>G) This feature could be aggregated to a lock basin by a C_AGGR object.</p>	<p><b>Object Encoding</b></p> <p><b>Object Class = GATCON(L,A)</b></p> <p>(M) CATGAT = [4 (lock gate)]</p> <p>(M) HORCLR = [xx.x] (metres), e.g., 34.2</p> <p>(C) VERCLR = [xx.xx] (metres), e.g., 13.27</p> <p>(O) CONDTN = [1 (under construction), 2 (ruined), 3 (under reclamation), 5 (planned construction)]</p> <p>(M) SCAMIN = [22000]</p> <p>(C) SORDAT = [YYYYMMDD]</p> <p>(C) SORIND = (Refer to Section B, General Guidance)</p> <p><b>Object Encoding</b></p> <p><b>Object Class = gatcon(L,A)</b></p> <p>(M) CATGAT = [4 (lock gate)]</p> <p>(M) HORCLR = [xx.x] (metres), e.g., 34.2</p> <p>(O) VERCLR = [xx.xx] (metres), e.g., 13.27</p> <p>(O) verdat = [12 (Mean lower low water), 31 (Local low water reference level), 32 (Local high water reference level), 33 (Local mean water reference level), 34 (Equivalent height of water (German GIW)), 35 (Highest Shipping Height of Water (German HSW)), 36 (Reference low water level according to Danube Commission), 37 (Highest shipping height of water according to Danube Commission), 38 (Dutch river low water reference level (OLR)), 39 (Russian project water level), 40 (Russian normal backwater level), 41 (Ohio River Datum), 42 (Approximate LAT), 43 (Dutch High Water Reference Level (MHW))]</p> <p>(C) wtwdis = (Refer to letter F)</p> <p>(C) hunits = (Refer to letter F)</p> <p>(O) CONDTN = [1 (under construction), 2 (ruined), 3 (under reclamation), 5 (planned construction)]</p> <p>(M) SCAMIN = [22000]</p> <p>(C) SORDAT = [YYYYMMDD]</p> <p>(C) SORIND = (Refer to Section B, General</p>


		Guidance)
--	--	-----------

# G - Ports, Waterways

## G.4 Locks, Barrages, Exceptional Navigational Structures

### G.4.6 Lock Name (O)

The commonly known name of the lock facility.


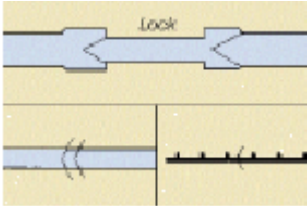
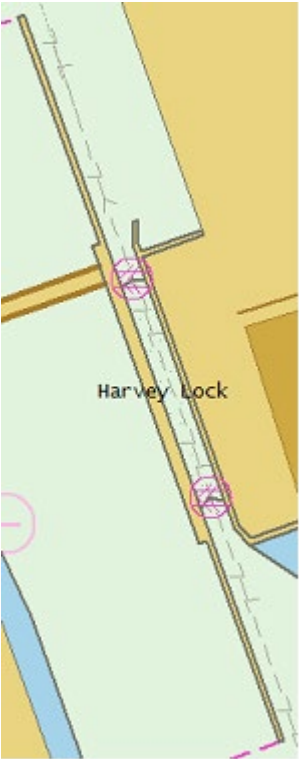
Graphics	Encoding Instructions	Object Encoding
<p><i>IENC Symbolization</i></p>  <p>The image shows a map segment with a green background. A yellow diagonal line represents a lock or dam. The text 'Carnelton Locks and Dam' is overlaid on the map. There are some faint numbers '1' and '2' near the line.</p>	<p>A) US &amp; RU: The SEAARE object must overlay the DEPARE object representing lock chamber. OBJNAM shall be the commonly known name of the Lock or Lock &amp; Dam.</p> <p>B) EU: The name should be encoded in the 'comare' object (M.4.1)</p> <p>C) This feature must be aggregated to a lock by a C_AGGR object.</p>	<p><b><u>Object Encoding</u></b></p> <p><b>Object Class = SEAARE(A)</b></p> <p>(M) OBJNAM = (Refer to letter A)</p> <p>(O) NOBJNM = (Refer to Section B, General Guidance)</p> <p>(O) CONDTN = [1 (under construction), 2 (ruined), 3 (under reclamation), 5 (planned construction)]</p> <p>(M) SCAMIN = [RU: 45000; US: 60000]</p> <p>(C) SORDAT = [YYYYMMDD]</p> <p>(C) SORIND = (Refer to Section B, General Guidance)</p>

# G - Ports, Waterways

## G.4 Locks, Barrages, Exceptional Navigational Structures

### G.4.7 Lock Wall (M)




Permanent structure bounding a lock and including guide walls.

Graphics	Encoding Instructions	Object Encoding
<p><i>Real World</i></p>  <p><i>Chart Symbol</i></p>  <p><i>IENC Symbolization</i></p> 	<p>A) The slcons object must be coincident with a LNDARE object.</p> <p>B) Multiple NATCON can be used, as in different materials for the lock wall and guide wall.</p> <p>C) This feature must be aggregated to a lock by a C_AGGR object.</p>	<p><b>Object Encoding</b></p> <p><b>Object Class</b> = slcons(L,A)</p> <p>(M) catslc = [18 (lock/guide wall)]</p> <p>(O) NATCON = [1 (masonry), 2 (concreted), 3 (loose boulders), 6 (wooden), 7 (metal)]</p> <p>(O) CONDTN = [1 (under construction), 2 (ruined), 3 (under reclamation), 5 (planned construction)]</p> <p>(M) SCAMIN = [EU: 22000; US: 45000]</p> <p>(C) SORDAT = [YYYYMMDD]</p> <p>(C) SORIND = (Refer to Section B, General Guidance)</p>

## G.4 Locks, Barrages, Exceptional Navigational Structures

### G.4.8 Exceptional Navigational Structure (M)

An exceptional navigational construction such as an aqueduct, lift-lock, etc.




Graphics	Encoding Instructions	Object Encoding
<p><i>Real World (Lift Lock)</i></p> 	<p>A) DRVAL1 represents the minimum operating depth of the structure.</p> <p>B) The exceptional structure does not carry information about the vertical clearance underneath. If the exceptional structure crosses navigable water (e.g., aqueduct) a bridge object must be encoded to provide the vertical clearance underneath.</p>	<p><b>Object Encoding</b></p> <p><b>Object Class = excnst(P,A)</b></p> <p>(M) DRVAL1 = [x.xx] (metres), e.g., 2.74 or UNKNOWN</p> <p>(M) catexs = [1 (Lift-Lock), 2 (Aqueduct), 3 (Sloping plane lock), 4 (Water slope lock (Pente d'Eau))]</p>
<p><i>Real World (Aqueduct)</i></p> 	<p>C) Use 'verdat' only if vertical datum differs:</p> <ul style="list-style-type: none"> <li>- from DSPM SDAT subfield and</li> <li>- from Meta object 'm_sdat' attribute</li> </ul> <p>D) Note:</p> <p>The vertical datum is the reference of the minimum operation depth of the exceptional structure.</p>	<p>(C) verdat = [12 (Mean lower low water), 31 (Local low water reference level), 32 (Local high water reference level), 33 (Local mean water reference level), 34 (Equivalent height of water (German GIW)), 35 (Highest Shipping Height of Water (German HSW)), 36 (Reference low water level according to Danube Commission), 37 (Highest shipping height of water according to Danube Commission), 38 (Dutch river low water reference level (OLR)), 39 (Russian project water level), 40 (Russian normal backwater level), 41 (Ohio River Datum), 42 (Approximate LAT), 43 (Dutch High Water Reference Level (MHW))]</p>
<p><i>IENC Symbolization</i></p> 	<p>E) If the exceptional navigational structure has a special time schedule or special operating hours apply, the object can be combined with a time schedule. For this purpose please refer to the time schedule (general) object 'tisdge' T.1.1.</p> <p>F) Restricted vertical clearance within the lock chamber should be encoded by the respective objects (e.g., GATCON, bridge, cblohd)</p> <p>G) If the ISRS Location Code is available it shall be encoded (refer to General Guidance section H).</p> <p>H) For Notice marks on aqueducts see O.3.2</p> <p>I) All objects which belong to an Exceptional Navigational Structure must be combined into one aggregation area (C_AGGR).</p> <p>J) The object name of an Exceptional Navigational Structure is assigned to the respective C_AGGR object using OBJNAM.</p>	<p>(C) unlocd = (Refer to letter G)</p> <p>(M) wtwdis = [xxxx.xxx] (units defined in hunits), e.g., 2451.732</p> <p>(M) hunits = [3 (kilometres), 4 (hectometres), 5 (statute miles), 6 (nautical miles)]</p> <p>(O) CONDTN = [1 (under construction), 2 (ruined), 3 (under reclamation), 5 (planned construction)]</p> <p>(M) SCAMIN = [EU: 90000; US: 300000]</p> <p>(C) SORDAT = [YYYYMMDD]</p> <p>(C) SORIND = (Refer to Section B, General Guidance)</p> <p><b>Object Encoding</b></p> <p><b>Object Class = C_AGGR()</b></p> <p>(M) OBJNAM = [name and/or operator/owner]</p> <p>(O) NOBJNM = (Refer to Section B, General Guidance)</p> <p>(C) unlocd = [ISRS Location Code]</p> <p>(O) TXTDSC = (Refer to letter L)</p>

	K) If a structured external XML-file with more detailed communication information is available, the reference to the file has to be entered in the TXTDSC attribute.	(C) SORDAT = [YYYYMMDD] (C) SORIND = (Refer to Section B, General Guidance)
--	--	--

## G.4 Locks, Barrages, Exceptional Navigational Structures

### G.4.9 Opening Barrage (C)

An opening gate used to control and protect against flood water or to regulate the water level.

Graphics	Encoding Instructions	Object Encoding
<p><i>Real World (Aerial View)</i></p>  <p><i>Real World (Skipper's View)</i></p>  <p><i>Chart Symbol</i></p> 	<p>A) For non-navigable parts of a flood barrage use DAMCON, for parts of a barrier/ flood barrage that are navigable at certain water levels use GATCON or gatcon (see instruction D)</p> <p>B) DAMCON area objects have to be placed on a LNDARE object.</p> <p>C) Linear GATCON features should follow the edge of a DEPARE object. Area GATCON features have to be placed on a depth area.</p> <p>D) Encode attribute 'verdat' only if vertical datum differs:</p> <ul style="list-style-type: none"> <li>- from DSPM VDAT subfield and</li> <li>- from Meta object 'm_vdat' attribute and specific for inland navigation or in case of a lifting barrage gate that restricts the air draught.</li> </ul> <p>E) VERCLR has to be encoded in case of a lifting barrage gate or gate-frame that restricts the air draught of passing vessels.</p> <p>F) A bridge over a barrier/ flood barrage needs to be encoded separately with a bridge object (see G.1)</p> <p>G) 'wtwdis' and 'hunits' shall be encoded if the attribute VERCLR is used.</p> <p>H) All objects of one Opening Barrage must be combined to one aggregation area (C_AGGR), e.g.</p> <ul style="list-style-type: none"> <li>- notice marks</li> <li>- two way route parts</li> <li>- communication area</li> <li>- fenders</li> <li>- ice breakers</li> <li>- vertical clearance indicators</li> <li>- signal stations</li> <li>- radio call-in points</li> </ul>	<p><b><u>Object Encoding</u></b></p> <p><b>Object Class = DAMCON(L,A)</b></p> <p>(M) CATDAM = [3 (flood barrage)]</p> <p>(O) NATCON = [1 (masonry), 2 (concreted), 3 (loose boulders), 4 (hard surfaced), 5 (unsurfaced), 6 (wooden), 7 (metal), 8 (glass reinforced plastic (GRP))]</p> <p>(O) CONDTN = [1 (under construction), 2 (ruined), 3 (under reclamation), 5 (planned construction)]</p> <p>(M) SCAMIN = [EU: 90000; US: 45000]</p> <p>(C) SORDAT = [YYYYMMDD]</p> <p>(C) SORIND = (Refer to Section B, General Guidance)</p> <p><b><u>Object Encoding</u></b></p> <p><b>Object Class = GATCON(L,A)</b></p> <p>(M) CATGAT = [2 (flood barrage gate)]</p> <p>(M) HORCLR = [xx.x] (metres), e.g., 34.2</p> <p>(C) VERCLR = [xx.xx] (metres) (Refer to letter E)</p> <p>(O) OBJNAM = [Name]</p> <p>(O) NOBJNM = (Refer to Section B, General Guidance)</p> <p>(O) CONDTN = [1 (under construction), 2 (ruined), 3 (under reclamation), 5 (planned construction)]</p> <p>(M) SCAMIN = [90000]</p> <p>(C) SORDAT = [YYYYMMDD]</p> <p>(C) SORIND = (Refer to Section B, General Guidance)</p> <p><b><u>Object Encoding</u></b></p> <p><b>Object Class = gatcon(L,A)</b></p> <p>(M) CATGAT = [2 (flood barrage gate)]</p> <p>(M) HORCLR = [xx.x] (metres), e.g., 34.2</p> <p>(C) VERCLR = [xx.xx] (metres) (Refer to letter E)</p> <p>(O) verdat = [12 (Mean lower low water), 31 (Local low water reference level), 32 (Local</p>

	<p>- overhead cables and pipelines</p> <p>I) The object name of a barrage is assigned to the respective C_AGGR object using OBJNAM.</p> <p>J) If a structured external XML-file with more detailed communication information is available, the reference to the file has to be entered in the TXTDSC attribute.</p> <p>K) Opening barrages shall be encoded if they are located in navigable water.</p> <p>L) EU: Use 'gatcon' to encode opening barrages that are in navigable water.</p>	<p>high water reference level), 33 (Local mean water reference level), 34 (Equivalent height of water (German GIW)), 35 (Highest Shipping Height of Water (German HSW)), 36 (Reference low water level according to Danube Commission), 37 (Highest shipping height of water according to Danube Commission), 38 (Dutch river low water reference level (OLR)), 39 (Russian project water level), 40 (Russian normal backwater level), 41 (Ohio River Datum), 42 (Approximate LAT), 43 (Dutch High Water Reference Level (MHW))]</p> <p>(C) wtwdis = (Refer to letter G)</p> <p>(C) hunits = (Refer to letter G)</p> <p>(C) unlocd = [ISRS Location Code]</p> <p>(O) CONDTN = [1 (under construction), 2 (ruined), 3 (under reclamation), 5 (planned construction)]</p> <p>(M) SCAMIN = [90000]</p> <p>(C) SORDAT = [YYYYMMDD]</p> <p>(C) SORIND = (Refer to Section B, General Guidance)</p> <p><b><u>Object Encoding</u></b></p> <p><b>Object Class = C_AGGR()</b></p> <p>(M) OBJNAM = [name and/or operator/owner]</p> <p>(O) NOBJNM = (Refer to Section B, General Guidance)</p> <p>(C) unlocd = [ISRS Location Code]</p> <p>(O) TXTDSC = (Refer to letter K)</p> <p>(C) SORDAT = [YYYYMMDD]</p> <p>(C) SORIND = (Refer to Section B, General Guidance)</p>
--	--	---





# H - Currents

## H.1 Currents

### H.1.1 Current (O)

Current is preferably indicated at high and low water conditions to aid with planning, navigation and maneuvering.


Graphics	Encoding Instructions	Object Encoding
<p><i>Real World</i></p>  <p><i>IENC Symbolization</i></p> 	<p>A) Code current as an area when information applies to a larger portion of water and provide average current values (xx.x km/h) for and name of the water level(s) for which information is available.</p> <p>B) Code 'curent' as a point object if information is based on local measurements.</p> <p>C) Provide direction of impact if 'curent' is coded as area object. Provide ORIENT value (360°) if 'curent' is coded as point object.</p> <p>D) Provide values for current velocity in km/h:</p> <ul style="list-style-type: none"> <li>• 'curvhw': current velocity at high water level</li> <li>• 'curvlw': current velocity at low water level</li> <li>• 'curvmw': current velocity at mean water level</li> <li>• 'curvow': current velocity at other water level</li> </ul> <p>E) State names of water levels for which current value is provided including version identification, for example year of issue or period:</p> <ul style="list-style-type: none"> <li>• 'hignam': name of relevant high water level</li> <li>• 'lownam': name of relevant low water level</li> <li>• 'meanam': name of relevant mean water level</li> <li>• 'othnam': name of other locally relevant water level</li> </ul>	<p><b>Object Encoding</b></p> <p><b>Object Class</b> = curent(P,A)</p> <p>(C) curvhw = [xx.x]</p> <p>(C) curvlw = [xx.x]</p> <p>(C) curvmw = [xx.x]</p> <p>(C) curvow = [xx.x]</p> <p>(C) dirimp = [1 (upstream), 2 (downstream), 3 (to the left bank), 4 (to the right bank)]</p> <p>(C) hignam = Name of water level, which is used for the attribute higwat (value at relevant high water level) including version identification, for example year of issue or period, e.g., HSW 96</p> <p>(C) lownam = Name of water level, which is used for the attribute lowwat (value at relevant low water level) including version identification, for example year of issue or period, e.g., RNW 96</p> <p>(C) meanam = Name of water level, which is used for the attribute meawat (value at relevant mean water level) including version identification, for example year of issue or period, e.g., HSW 96</p> <p>(C) othnam = (name of water level, which is used for the attribute othwat (value at other locally relevant water level) including version identification, for example year of issue or period) (e.g., HQ100-96)</p> <p>(C) ORIENT = [xxx or (UNKNOWN)] (degree (°)), e.g., 110</p> <p>(M) SCAMIN = [18000]</p> <p>(C) SORDAT = [YYYYMMDD]</p> <p>(C) SORIND = (Refer to Section B, General Guidance)</p>

# H - Currents

## H.1 Currents

### H.1.2 Water Turbulence (O)

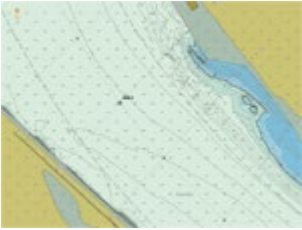
The disturbance of water caused by the interaction of any combination of waves, currents, tidal streams, wind, shoal patches and obstructions.

Graphics	Encoding Instructions	Object Encoding
<p><i>IENC Symbolization</i></p> 	<p>A) Water power supplies are producing water turbulences under water at a place where the vessels enter the locks.</p>	<p><b>Object Encoding</b></p> <p><b>Object Class</b> = WATTUR(P,A)</p> <p>(M) CATWAT = [6 (under water turbulence)]</p> <p>(O) OBJNAM = [Name of object]</p> <p>(O) NOBJNM = (Refer to Section B, General Guidance)</p> <p>(M) SCAMIN = [22000]</p> <p>(C) SORDAT = [YYYYMMDD]</p> <p>(C) SORIND = (Refer to Section B, General Guidance)</p>

## I.1 Depths in Fairways and Areas

### I.1.1 Detailed Depth - referenced to one water level (C)

Detailed depth information (area) – referred to one reference water level only : Water area within the waterway whose detailed depth information is within a defined range of values that refer to only one vertical datum, the reference water level.

Graphics	Encoding Instructions	Object Encoding
<p><i>IENC Symbolization</i></p> 	<p>A) The reference water level is only provided in the cell header (field: DSPM, subfield SDAT) or in 'm_sdat' plus 'verdat', if applicable (e.g., within a cell where two rivers with different reference water levels meet). verdat on individual objects related to depth is prohibited.</p> <p>B) If the area is bounded by two or more depth contours: DRVAL2 takes the value of the deepest depth contour bounding the area. DRVAL1 takes the value of the shallowest depth contour bounding the area.</p> <p>C) If the shallowest depth of an unsurveyed area near the shore is defined by the river bank and the position of the riverbank is not exactly known, DRVAL1 = height of the riverbank above sounding/vertical datum, normally it is "unknown". DRVAL2 takes the value of the deepest depth contour bounding the area. QUASOU has to be encoded (see C.1.7 and I.1.9).</p> <p>D) If the shallowest depth of an unsurveyed area near the shore is defined by the river bank and the position of the river bank is exactly known, DRVAL1 = "0". DRVAL2 takes the value of the deepest depth contour bounding the area. Drying areas have to be encoded according to I.1.6 (low/high water range) QUASOU has to be encoded (see C.1.7 and I.1.9).</p> <p>E) If the area is bounded by only one depth contour and it is a hole: DRVAL1 takes the value of the depth contour shown. DRVAL2 takes the value of the deepest sounding within the depth contour if this is known. If one doesn't know how deep the hole reaches (which is normal) DRVAL2 is "unknown".</p> <p>F) If the area is bounded by only one depth contour and it is a peak:</p>	<p><b>Object Encoding</b></p> <p><b>Object Class = DEPARE(A)</b></p> <p>(M) DRVAL1 = [x.xx] (metres), e.g., 2.74 or UNKNOWN</p> <p>(M) DRVAL2 = Maximum known depth of depth area: [xx.xx] (metres) or UNKNOWN</p> <p>(C) QUASOU = [2 (depth unknown), 8 (value reported (not surveyed))]</p> <p>(C) SORDAT = [YYYYMMDD]</p> <p>(C) SORIND = (Refer to Section B, General Guidance)</p>


	<p>DRVAL2 takes the value of the depth contour shown. DRVAL1 takes the value of the shoalest sounding within the depth contour if this is known. If one doesn't know how high the peak reaches DRVAL1 is "unknown".</p> <p>G) Shallow depth areas with a diameter less than 10 m have to be encoded additionally as underwater rock, wreck or obstruction (see J.1.1 Rocks, J.2.1 Wrecks or J.3.1 Obstructions).</p> <p>H) All navigable water bodies shall be covered by either DEPARE, depare, DRGARE or UNSARE (Group 1) objects using one of the options mentioned in I.1.1 to I.1.9.</p>	
--	---	--

## I.1 Depths in Fairways and Areas

### I.1.2 Detailed Depth - water level model (C)

Detailed depth information (area) – a water level model that is applied to depth areas

A water area within the waterway in which detailed depth information is known within a defined range of values referenced to a vertical datum (the reference water level). The actual water level is provided by a water level model.

Graphics	Encoding Instructions	Object Encoding
<p><i>IENC Symbolization</i></p> 	<p>A) The following encoding instructions must only be followed if a water level model shall be applied to the depth areas.</p> <p>B) The reference water level is only provided in the cell header (field: DSPM, subfield SDAT) or in 'm_sdat' plus 'verdat', if applicable (e.g. within a cell where two rivers with different reference water levels meet). 'verdat' on individual objects related to depth is prohibited.</p> <p>C) Cut the depth areas at defined waterway profiles in order to be able to assign a waterway distance to the depth area.</p> <p>D) If the area is bounded by two or more depth contours: DRVAL2 takes the value of the deepest depth contour bounding the area. DRVAL1 takes the value of the shallowest depth contour bounding the area.</p> <p>E) If the shallowest depth of an unsurveyed area near the shore is defined by the river bank and the position of the riverbank is not exactly known, DRVAL1 = height of the riverbank above sounding/vertical datum, normally it is "unknown". DRVAL2 takes the value of the deepest depth contour bounding the area. QUASOU has to be encoded (see C.1.7 and I.1.9).</p> <p>F) If the shallowest depth of an unsurveyed area near the shore is defined by the river bank and the position of the river bank is exactly known, DRVAL1 = "0". DRVAL2 takes the value of the deepest depth contour bounding the area. Drying areas have to be encoded according to I.1.6 (low/high water range). QUASOU has to be encoded (see C.1.7 and I.1.9).</p>	<p><b><u>Object Encoding</u></b></p> <p><b>Object Class = depare(A)</b></p> <p>(M) DRVAL1 = [x.xx] (metres), e.g., 2.74 or UNKNOWN</p> <p>(M) DRVAL2 = Maximum known depth of depth area: [xx.xx] (metres) or UNKNOWN</p> <p>(C) eleva1 = Maximum elevation 1 of a depth area: [xx.x] (metres) or UNKNOWN</p> <p>(C) eleva2 = Minimum elevation 2 of a depth area: [xx.x] (metres) or UNKNOWN</p> <p>(M) wtwdis = [xxxx.x] (units defined in hunits), e.g., 2451.7</p> <p>(M) hunits = [3 (kilometres), 4 (hectometres), 5 (statute miles), 6 (nautical miles)]</p> <p>(C) QUASOU = [2 (depth unknown), 8 (value reported (not surveyed))]</p> <p>(C) SORDAT = [YYYYMMDD]</p> <p>(C) SORIND = (Refer to Section B, General Guidance)</p>

- G) If the area is bounded by only one depth contour and it is a hole: DRVAL1 takes the value of the depth contour shown. DRVAL2 takes the value of the deepest sounding within the depth contour if this is known. If one doesn't know how deep the hole reaches (which is normal) DRVAL2 is "unknown".
- H) If the area is bounded by only one depth contour and it is a peak: DRVAL2 takes the value of the depth contour shown. DRVAL1 takes the value of the shoalest sounding within the depth contour if this is known. If one doesn't know how high the peak reaches DRVAL1 is "unknown".
- I) Add the object attribute 'eleva1' which is corresponding to DRVAL1, if it is needed for the water level model. 'eleva1' is used to define the maximum elevation of the bottom of a river referred to a gravitational reference level (reflev).
- J) Add the object attribute 'eleva2' which is corresponding to DRVAL2, if it is needed for the water level model. 'eleva2' is used to define the minimum elevation of the bottom of a river referred to a gravitational reference level (reflev).
- K) Add the object attribute 'wtwdis' with the value of the waterway distance of the downstream situated waterway profile. Do this in order to calculate the values for 'eleva1' and 'eleva2' automatically out of DRVAL1 and DRVAL2 (which are referred to the reference water level whose height above the gravitational reference level (reflev) is stored in the object attribute HEIGHT of the downstream situated object 'wtwprf'). (See waterway profile I.3.5)
- L) If the actual water level, that is provided by a water level model, is also referred to the same gravitational reference level, one can link the depth areas with the actual water level using 'eleva1' and 'eleva2'.
- M) Shallow depth areas with a diameter less than 10 m have to be encoded additionally as underwater rock, wreck or obstruction (see J.1.1 Rocks, J.2.1 Wrecks or J.3.1 Obstructions).


	N) All navigable water bodies shall be covered by either DEPARE, depare, DRGARE or UNSARE (Group 1) objects using one of the options mentioned in I.1.1 to I.1.9.	
--	---	--

# I - Depths

## I.1 Depths in Fairways and Areas

### I.1.3 Dredged Area (C)

An area of the bottom of a body of water that has been deepened by dredging. (IHO Dictionary, S-32, 5th Edition, 1462)

Graphics	Encoding Instructions	Object Encoding
<p><i>IENC Symbolization</i></p> 	<p>A) All navigable water bodies shall be covered by either DEPARE, depare, DRGARE or UNSARE (Group 1) objects using one of the options mentioned in I.1.1 to I.1.9.</p>	<p><b>Object Encoding</b></p> <p><b>Object Class = DRGARE(A)</b></p> <p>(M) DRVAL1 = [x.xx] (metres), e.g., 2.74 or UNKNOWN</p> <p>(C) SORDAT = [YYYYMMDD]</p> <p>(C) SORIND = (Refer to Section B, General Guidance)</p>





## I.1 Depths in Fairways and Areas

### I.1.4 Fairway (C)

Part of the navigable waterway area where a certain water depth within a certain width is available for the continuous navigation.

That part of a river, harbor and so on, where the main navigable channel for vessels of larger size lies. It is also the usual course followed by vessels entering or leaving harbors, called „ship channel“.


(International Maritime Dictionary, 2nd Ed.)

Graphics	Encoding Instructions	Object Encoding
<p><i>IENC Symbolization</i></p>  <p><i>IENC Symbolization</i></p> 	<ul style="list-style-type: none"> <li>A) The fairway has to be encoded if there is one.</li> <li>B) A publication is only allowed if the competent authority has verified its location.</li> <li>C) The fairway must be covered by depth areas.</li> <li>D) DRVAL1 of the FAIRWY object class should not be used, because 'verdat' is not available, instead depth areas shall be used in addition to FAIRWY (refer to I.1.5 Fairway Depth / Project Depth)</li> <li>E) If no detailed bathymetry is available, the fairway shares the geometry of a depth area with DRVAL1 = official water depth in metres issued by the competent authority (DRVAL2 = "unknown"); please refer to I.1.5 Fairway Depth/Project Depth</li> <li>F) If no detailed bathymetry is available, on each side of the fairway there must be a depth area between the shoreline and the boundary of the fairway with DRVAL1 = 0 or "unknown" and DRVAL2 = official water depth in metres issued by the competent authority; please refer to I.1.5 Fairway Depth/Project Depth)</li> <li>G) If there is a fairway separation with a one-way regulation a two-way route part (refer to L.1.3 - Two-way Route Part) has to be encoded.</li> </ul>	<p><b><u>Object Encoding</u></b></p> <p><b>Object Class = FAIRWY(A)</b></p> <p>(M) SCAMIN = [90000]</p> <p>(C) SORDAT = [YYYYMMDD]</p> <p>(C) SORIND = (Refer to Section B, General Guidance)</p>

## I.1 Depths in Fairways and Areas

### I.1.5 Fairway Depth / Project Depth (C)

Area within the waterway that is delimited by the boundaries of the navigable channel and denotes the designated area with an official water depth for the continuous navigation. It depends on the legal status of the navigable channel if this depth is maintained regularly or not.

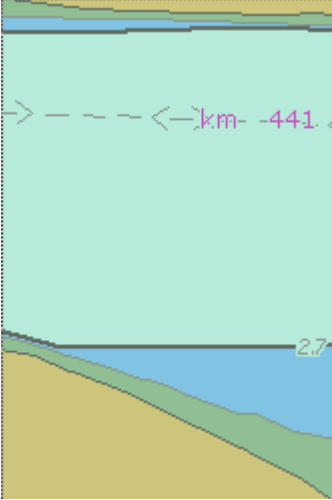
Graphics	Encoding Instructions	Object Encoding
<p><i>IENC Symbolization</i></p> 	<p>A) This coding method for depth is only a minimum requirement for displaying the official water depth of the fairway that is available for the continuous navigation. If more detailed depth information is available use I.1.1 "Detailed Depth – ref. to one reference water level" or I.1.2 "Det. Depth - water level model".</p> <p>B) The depth area shares the geometry of the fairway with value 1 of the depth range (DRVAL1) = official water depth in metres issued by the competent authority. The value 2 of the depth range (DRVAL2) has to be set to "unknown".</p> <p>C) US: DRVAL1 = 2.7 (equivalent to typical project depths for vast majority of shallow draft projects) and DRVAL2 = "Unknown" if value is not known.</p> <p>D) US: A Shallow Depth area or unsurveyed area must form the boundary between the Project Depth and the land, unless DEPARE is within the lock chamber.</p> <p>E) EU: On each side of the fairway there must be a depth area between the shoreline and the boundary of the fairway with DRVAL1 = "unknown" and DRVAL2 = official water depth in metres issued by the competent authority.</p> <p>F) The reference water level is only provided in the cell header (field: DSPM, subfield SDAT) or in m_sdat plus verdat, if applicable (e.g., within a cell where two rivers with different reference water levels meet). verdat on individual objects related to depth is prohibited.</p> <p>G) EU: QUASOU = 10 (maintained depth) or QUASOU = 11 (depth not regularly maintained) should be</p>	<p><b><u>Object Encoding</u></b></p> <p><b>Object Class = DEPARE(A)</b></p> <p>(M) DRVAL1 = [x.xx] (metres), e.g., 2.74 or UNKNOWN</p> <p>(M) DRVAL2 = Maximum known depth of depth area: [xx.xx] (metres) or UNKNOWN</p> <p>(C) QUASOU = (Refer to letter G)</p> <p>(C) SORDAT = [YYYYMMDD]</p> <p>(C) SORIND = (Refer to Section B, General Guidance)</p>

	<p>used to indicate the reliability of the depth information due to the legal status of the fairway.</p> <p>H) All navigable water bodies shall be covered by either DEPARE, depare, DRGARE or UNSARE (Group 1) objects using one of the options mentioned in I.1.1 to I.1.9.</p>	
--	---	--

## I.1 Depths in Fairways and Areas

### I.1.6 Low / High Water Range (Drying Height) (C)


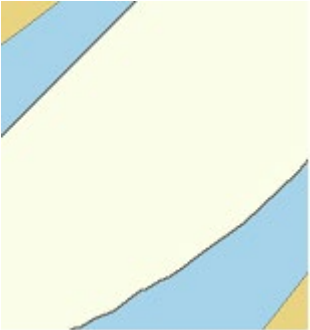
Area denoting the range between low and high water conditions (often referred to as 'drying height'). The feature applies only to open rivers.

Graphics	Encoding Instructions	Object Encoding
<p><i>IENC Symbolization (shown in green)</i></p> 	<ul style="list-style-type: none"> <li>A) Area should border the shoreline and top bank.</li> <li>B) In case of tidal influence, use -H, where -H is height of tide</li> <li>C) US: INFORM is mandatory</li> <li>D) All navigable water bodies shall be covered by either DEPARE, depare, DRGARE or UNSARE (Group 1) objects using one of the options mentioned in I.1.1 to I.1.9.</li> </ul>	<p><b>Object Encoding</b></p> <p><b>Object Class = DEPARE(A)</b></p> <p>(M) DRVAL1 = UNKNOWN or -H</p> <p>(M) DRVAL2 = 0.0</p> <p>(C) INFORM = ["Range between low and high water conditions"]</p> <p>(C) SORDAT = [YYYYMMDD]</p> <p>(C) SORIND = (Refer to Section B, General Guidance)</p>

## I.1 Depths in Fairways and Areas

### I.1.7 Shallow Depth (C)


Area within the waterway bounded by zero depth and the project depth.

Graphics	Encoding Instructions	Object Encoding
<p><i>Chart Symbol</i></p>  <p><i>IENC Symbolization</i></p> 	<p>A) US: Encode the depth area between the shoreline (COALNE) and the project depth area (see Fairway Depth / Project Depth - I.1.5); DRVAL1 = 0 and DRVAL2 = 2.7</p> <p>B) All navigable water bodies shall be covered by either DEPARE, depare, DRGARE or UNSARE (Group 1) objects using one of the options mentioned in I.1.1 to I.1.9.</p>	<p><b>Object Encoding</b></p> <p><b>Object Class = DEPARE(A)</b></p> <p>(M) DRVAL1 = 0.0 (metres)</p> <p>(M) DRVAL2 = Maximum known depth of depth area: [xx.xx] (metres) or UNKNOWN</p> <p>(C) SORDAT = [YYYYMMDD]</p> <p>(C) SORIND = (Refer to Section B, General Guidance)</p>

## I.1 Depths in Fairways and Areas

### I.1.8 Soundings (O)

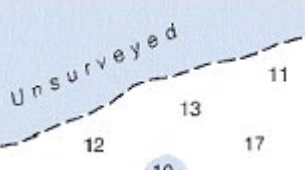

A measured water depth or spot that has been reduced to a vertical datum. (S-57 standard)

Graphics	Encoding Instructions	Object Encoding
<p><i>IENC Symbolization</i></p> 	<p>A) Spot soundings should be used sparingly in IENC, especially on rivers and canals. On rivers and canals only in rare cases where such information is of vital interest to skippers and no other encoding seems to be possible (like e.g. wrecks or obstructions to navigation) soundings may be used. This might be in case of isolated rocks below low water level.</p> <p>B) Spot soundings shall always be referred to the same water level as the surrounding depth information.</p> <p>C) The value of the sounding is encoded in the 3-D Coordinate field of the Spatial Record Structure (see S-57 Part 3).</p>	<p><b><u>Object Encoding</u></b></p> <p><b>Object Class = SOUNDG(P)</b></p> <p>(M) SCAMIN = [compilation scale multiplied by 2]</p> <p>(C) SORDAT = [YYYYMMDD]</p> <p>(C) SORIND = (Refer to Section B, General Guidance)</p>

## I.1 Depths in Fairways and Areas

### I.1.9 Unsurveyed Area (C)

An area for which no bathymetric survey information is available. (S-57standard)


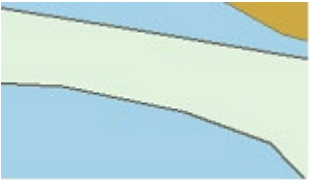
Graphics	Encoding Instructions	Object Encoding
<p><i>Chart Symbol</i></p>  <p><i>IENC Symbolization</i></p> 	<p>A) Those areas in the river which cannot be surveyed, for example, due to depths too shallow for surveying boats and hence no depth data is available, shall be coded by UNSARE. This shall only be done for areas below the specific water level to which the depth of the river is referred. For areas above this specific water level, DEPARE - DRVAL2 = 0 shall be used (refer to I.1.6).</p> <p>B) Especially in case parts of the navigable water area are not surveyed but may be deep enough for navigation, DEPARE with QUASOU = 2 (depth unknown) or 8 (value reported (not surveyed)) shall be used in order to show that ships may navigate in these areas as well. This may imply especially for sidearms or private marinas.</p> <p>C) All navigable water bodies shall be covered by either DEPARE, depare, DRGARE or UNSARE (Group 1) objects using one of the options mentioned in I.1.1 to I.1.9.</p>	<p><b>Object Encoding</b></p> <p><b>Object Class = UNSARE(A)</b></p> <p>(C) QUASOU = (Refer to letter B)</p> <p>(C) SORDAT = [YYYYMMDD]</p> <p>(C) SORIND = (Refer to Section B, General Guidance)</p> <p><b>Object Encoding</b></p> <p><b>Object Class = DEPARE(A)</b></p> <p>(M) DRVAL1 = ["0"]</p> <p>(M) DRVAL2 = ["Unknown" or [x.x] (metres), e.g. 2.7]</p> <p>(C) QUASOU = (Refer to letter B)</p> <p>(C) SORDAT = [YYYYMMDD]</p> <p>(C) SORIND = (Refer to Section B, General Guidance)</p>

# I - Depths

## I.2 Depth Contours

### I.2.1 Depth Contour (O)

Line of constant depth denoting the depth between Shallow Depth and Fairway / Project Depth.

Graphics	Encoding Instructions	Object Encoding
<p data-bbox="90 474 245 506"><i>Chart Symbol</i></p>  <p data-bbox="90 684 315 716"><i>IENC Symbolization</i></p> 	<p data-bbox="472 474 943 642">A) US: USACE shall show a single depth contour for project depth (typically 2.74 (9')). A zero (0) depth contour shall also be used if a Low / High Water Range (Drying Height) exists (refer to I.1.6).</p>	<p data-bbox="976 474 1179 506"><b><u>Object Encoding</u></b></p> <p data-bbox="976 516 1292 548"><b>Object Class = DEPCNT(L)</b></p> <p data-bbox="976 558 1446 590">(M) VALDCO = [xx.xx] (metres), e.g., 2.74</p> <p data-bbox="976 600 1414 632">(M) SCAMIN = [EU: 12000; US: 18750]</p> <p data-bbox="976 642 1308 674">(C) SORDAT = [YYYYMMDD]</p> <p data-bbox="976 684 1463 758">(C) SORIND = (Refer to Section B, General Guidance)</p>




## I.3 Depth References

### I.3.1 Depth Indicator (C)

Device that shows the real water depth between the actual water level and the bottom of the waterway or isolated dangers under water (e.g., ground sill).

The manner in which the device indicates this can either be analog (e.g., by a water level staff / pole - one can read the real water depth directly at the water level) or digital (e.g. by a display).


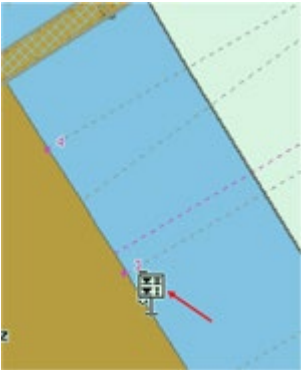
Distinction: external indicator of a gauge, also if the indicator is not directly located at the gauge – this is not the same as a depth indicator (values at gauges are always referred to the zero point of the gauge).

Graphics	Encoding Instructions	Object Encoding
<p><i>Real World</i></p> 	<p>A) INFORM can be used to give unformatted text as additional information. For formatted text in an external file, TXTDSC has to be used.</p> <p>B) EU: Depth indicators must be encoded.</p> <p>C) This feature could be aggregated to a lock, for example, by a C_AGGR object.</p> <p>D) A remote display of a depth indicator has to be encoded in the same way. The name of the related depth indicator has to be encoded as OBJNAM. The value of waterway distance of the related depth indicator can be provided in INFORM. The remote display has to be connected to the related sistaw with C_AGGR.</p>	<p><b>Object Encoding</b></p> <p><b>Object Class = sistaw(P)</b></p> <p>(M) catsiw = [18 (depth indication)]</p> <p>(C) OBJNAM = [name of depth indicator or related depth indicator]</p> <p>(O) NOBJNM = (Refer to Section B, General Guidance)</p> <p>(O) INFORM = [additional information, e.g. "referenced to ground still"]</p> <p>(O) NINFOM = (Refer to Section B, General Guidance)</p> <p>(C) TXTDSC = (Refer to letter A)</p> <p>(O) CONDTN = [1 (under construction), 2 (ruined), 3 (under reclamation), 5 (planned construction)]</p> <p>(M) SCAMIN = [EU: 22000; US: 45000]</p> <p>(C) SORDAT = [YYYYMMDD]</p> <p>(C) SORIND = (Refer to Section B, General Guidance)</p>

## I.3 Depth References

### I.3.2 High Water Mark (C)

Device that shows if official high water levels are reached. This can be indicated either by analog (e.g., by signs like a staff gauge) or digital (e.g., by a display).



Graphics	Encoding Instructions	Object Encoding
<p><i>Real World</i></p>  <p><i>IENC Symbolization</i></p> 	<p>A) INFORM can be used to give unformatted text as additional information. For formatted text in an external file, TXTDSC has to be used.</p> <p>B) EU: High Water Marks must be encoded.</p>	<p><b>Object Encoding</b></p> <p><b>Object Class</b> = sistaw(P)</p> <p>(M) catsiw = [15 (high water mark)]</p> <p>(O) INFORM = [additional information, e.g., "I=460cm at gauge Kaub"]</p> <p>(O) NINFOM = (Refer to Section B, General Guidance)</p> <p>(C) TXTDSC = (Refer to letter A)</p> <p>(O) CONDTN = [1 (under construction), 2 (ruined), 3 (under reclamation), 5 (planned construction)]</p> <p>(M) SCAMIN = [EU: 22000; US: 45000]</p> <p>(C) SORDAT = [YYYYMMDD]</p> <p>(C) SORIND = (Refer to Section B, General Guidance)</p>

## I.3 Depth References

### I.3.3 Vertical Clearance Indicator (C)

Device that shows the vertical clearance between the actual water level and isolated dangers above water level, such as bridges, overhead cables etc.


This can be indicated either by analog (e.g., by fixed upside down scales on pylons of bridges - one can read the clearance directly at the water level) or digital (e.g., by a display).

Graphics	Encoding Instructions	Object Encoding
<p><i>Real World</i></p>  <p><i>IENC Symbolization</i></p> 	<p>A) INFORM can be used to give unformatted text as additional information. For formatted text in an external file, TXTDSC has to be used.</p> <p>B) EU: Vertical Clearance Indicators must be encoded.</p> <p>C) This feature must be aggregated to a bridge, an overhead cable or overhead pipeline, etc. by a C_AGGR object.</p>	<p><b>Object Encoding</b></p> <p><b>Object Class = sistaw(P)</b></p> <p>(M) catsiw = [16 (vertical clearance indication)]</p> <p>(C) TXTDSC = (Refer to letter A)</p> <p>(O) CONDTN = [1 (under construction), 2 (ruined), 3 (under reclamation), 5 (planned construction)]</p> <p>(M) SCAMIN = [EU: 22000; US: 45000]</p> <p>(C) SORDAT = [YYYYMMDD]</p> <p>(C) SORIND = (Refer to Section B, General Guidance)</p>

## I.3 Depth References

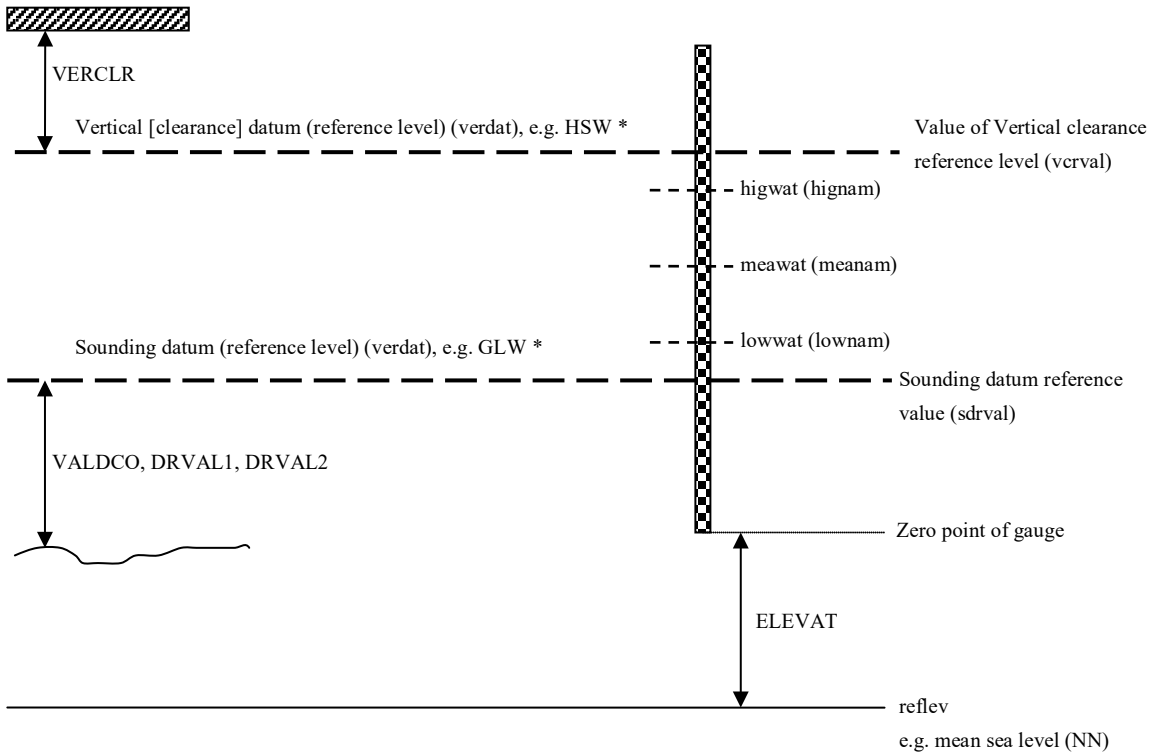
### I.3.4 Waterway Gauge (C)

A waterway gauge is an instrument for measuring water levels. Waterway gauges provide the actual water level information to calculate actual depths and vertical clearances, taking into account the sloped nature of river water surfaces.

Graphics	Encoding Instructions	Object Encoding
<p>Chart Symbol (USACE Gauge)</p> 	<p>A) The waterway gauge may be encoded as a point object at the location of the real world entity.</p> <p>Preferably the gauge should be encoded as an area object covering its complete area of applicability (to be decided by the chart producer if this area covers only the fairway or the complete riverbed).</p> <p>B) The name of the gauge shall be encoded by OBJNAM. As the name the term known by the skippers shall be chosen. In case an additional name in e.g., Cyrillic letters is well known this name may be encoded in the NINFOM attribute.</p> <p>C) If the ISRS Location Code is available it has to be encoded (refer to General Guidance section H).</p> <p>D) Category of the gauge may be encoded by using the 'catgag' attribute.</p> <p>E) The river km or mile of the location of the gauge shall be encoded by using the 'wtwdis' attribute.</p> <p>F) The zero point of the gauge is defined by the attributes ELEVAT (indicating the units above the locally used gravitational level) and 'reflev', indicating the used gravitational level itself (also refer to the picture below).</p> <p>G) When a gauge is encoded as a point object (mainly in case a water level model is available), the area of applicability may be provided by a specific distance of impact down and up stream using the attributes 'disipd' (downstream) and 'disipu' (upstream). 'disipd' and 'disipu' should be used for both point and area objects.</p> <p>H) Reference to specific defined water levels shall be enabled.</p>	<p><b>Object Encoding</b></p> <p><b>Object Class</b> = wtwgag(P,A)</p> <p>(C) OBJNAM = [name of gauge]</p> <p>(O) NOBJNM = (Refer to Section B, General Guidance)</p> <p>(C) unlocd = [ISRS Location Code]</p> <p>(O) catgag = [1 (water level staff / pole), 2 (recording water level gauge), 3 (recording water level gauge with remote access), 4 (recording water level gauge with external indicator), 5 (recording water level gauge with remote access and remote indicator)]</p> <p>(O) wtwdis = [xxxx.xxx] (units defined in hunits), e.g., 2451.732</p> <p>(O) hunits = [3 (kilometres), 4 (hectometres), 5 (statute miles), 6 (nautical miles)]</p> <p>(O) ELEVAT = [xxx.xx] (metres), e.g., 159.87</p> <p>(C) verdat = [12 (Mean lower low water), 31 (Local low water reference level), 32 (Local high water reference level), 33 (Local mean water reference level), 34 (Equivalent height of water (German GIW)), 35 (Highest Shipping Height of Water (German HSW)), 36 (Reference low water level according to Danube Commission), 37 (Highest shipping height of water according to Danube Commission), 38 (Dutch river low water reference level (OLR)), 39 (Russian project water level), 40 (Russian normal backwater level), 41 (Ohio River Datum), 42 (Approximate LAT), 43 (Dutch High Water Reference Level (MHW))]</p> <p>(O) reflev = [1 (Baltic datum), 2 (Adriatic level), 3 (Amsterdam Ordnance Datum (NAP)), 4 (Mean Sea Level), 5 (Other datum), 6 (National Geodetic Vertical Datum - NGVD29), 7 (North American Vertical Datum - NAVD88), 8 (Mean sea level 1912), 9 (Mean sea level 1929), 10 (Tweede Algemene Waterpassing (TAW))]</p> <p>(O) disipd = [distance of impact, downstream: unit defined in the cell header, e.g., metre (m), resolution: 1m]</p> <p>(O) disipu = [distance of impact, upstream:</p>

	<p>1. For high water levels:</p> <ul style="list-style-type: none"> <li>- 'higwat' to indicate the defined high water level (e.g. 567 cm)</li> <li>- 'hignam' to indicate the specific high water level including the year of publication or a period indication (e.g., HSW96)</li> </ul> <p>2. For mean water levels:</p> <ul style="list-style-type: none"> <li>- 'meawat' to indicate the mean water level (value and units)</li> <li>- 'meanam' to indicate the specific mean water level including the year of publication or a period indication (name and year)</li> </ul> <p>3. For low water levels:</p> <ul style="list-style-type: none"> <li>- 'lowwat' to indicate the low water level (value and units)</li> <li>- 'lownam' to indicate the specific low water level including the year of publication or a period indication (name and year)</li> </ul> <p>In the event that there is another specific and important water level, this may be encoded by using the attributes 'othwat' and 'othnam'.</p> <p>I) In order to enable IENC based applications to calculate clearances and depths automatically the following information is used: Vertical clearances at bridges shall always be referred to a specific water level. This level shall be indicated within the 'vcrllev' attribute (preferably according to the list of 'verdat' values. This water level should be the same as indicated in 'hignam'.</p> <p>J) The same way as in the last point shall be followed for providing information on the reference water level for depth information. In this case the attribute 'sdrlev' may be used and should be equal to 'lownam' in most cases.</p> <p>K) EU: Waterway gauges that are relevant and useable for navigation must be encoded.</p> <p>L) This feature could be aggregated to a bridge or a lock, etc. by a C_AGGR object.</p> <p>M) A remote display of gauge has to be encoded in the same way. The name of the related gauge has to be encoded as OBJNAM. The wtwdis has to be encoded with the location of the related gauge. The remote</p>	<p>unit defined in the cell header, e.g., metre (m), resolution: 1m]</p> <p>(O) higwat = [xxx.xxx] (metres), e.g., 4.78</p> <p>(O) hignam = Name of water level, which is used for the attribute higwat (value at relevant high water level) including version identification, for example year of issue or period, e.g., HSW 96</p> <p>(O) lowwat = [xxx.xxx] (metres), e.g., 4.78</p> <p>(O) lownam = Name of water level, which is used for the attribute lowwat (value at relevant low water level) including version identification, for example year of issue or period, e.g., RNW 96</p> <p>(O) meawat = [xxx.xxx] (metres), e.g., 2.46</p> <p>(O) meanam = Name of water level, which is used for the attribute meawat (value at relevant mean water level) including version identification, for example year of issue or period, e.g., HSW 96</p> <p>(O) othwat = [xxx.xxx] (metres), e.g., 0.567</p> <p>(O) othnam = (name of water level, which is used for the attribute othwat (value at other locally relevant water level) including version identification, for example year of issue or period) (e.g., HQ100-96)</p> <p>(O) sdrlev = (name of reference level to which depth are referred (from verdat list) plus version indication), e.g. GIW 2002</p> <p>(O) vcrllev = Name of reference level to which vertical clearances are referred (from verdat list) plus version indication, e.g., HSW 2002</p> <p>(O) CONDTN = [1 (under construction), 2 (ruined), 3 (under reclamation), 5 (planned construction)]</p> <p>(M) SCAMIN = [EU: 22000; US: 45000]</p> <p>(C) SORDAT = [YYYYMMDD]</p> <p>(C) SORIND = (Refer to Section B, General Guidance)</p>
--	--	---

	display has to be connected to the related wtwgag with C_AGGR.	
--	--	--




- \* The sounding or vertical datum (reference level) are defined either in
- in the cell header (valid for all objects in the cell)
  - at the meta objects m\_sdat or m\_vdat, if another value than in cell header
  - at the object itself (attribute verdat), if another value than in cell header or meta object.

## I.3 Depth References

### I.3.5 Waterway Profile (C)

A waterway profile is an imaginary (i.e., physically non-existent) line across the waterway.


Graphics	Encoding Instructions	Object Encoding
<p><i>IENC Symbolization</i></p> 	<p>A) If waterway profiles are used on a waterway, the spacing of the waterway profiles depends on the local slope of the water level. The most common spacing is every one hundred metres. Preferably the location of waterway profiles coincides with distance marks ashore.</p> <p>B) HEIGHT refers to the reference level within the attribute 'reflev'.</p> <p>C) If detailed depths for water level model are provided waterway profiles must be encoded in order to be able to assign a waterway distance to the depth area (See I.1.2 Detailed Depth - water level model).</p>	<p><b>Object Encoding</b></p> <p><b>Object Class</b> = wtwprf(L)</p> <p>(M) wtwdis = [xxxx.xxx] (units defined in hunits), e.g., 2451.732</p> <p>(M) hunits = [3 (kilometres), 5 (statute miles), 6 (nautical miles)]</p> <p>(C) HEIGHT = [xxx.x] metres, e.g., 27.4</p> <p>(C) verdat = [12 (Mean lower low water), 31 (Local low water reference level), 32 (Local high water reference level), 33 (Local mean water reference level), 34 (Equivalent height of water (German GIW)), 35 (Highest Shipping Height of Water (German HSW)), 36 (Reference low water level according to Danube Commission), 37 (Highest shipping height of water according to Danube Commission), 38 (Dutch river low water reference level (OLR)), 39 (Russian project water level), 40 (Russian normal backwater level), 41 (Ohio River Datum), 42 (Approximate LAT), 43 (Dutch High Water Reference Level (MHW))]</p> <p>(C) reflev = [1 (Baltic datum), 2 (Adriatic level), 3 (Amsterdam Ordnance Datum (NAP)), 4 (Mean Sea Level), 5 (Other datum), 6 (National Geodetic Vertical Datum - NGVD29), 7 (North American Vertical Datum - NAVD88), 8 (Mean sea level 1912), 9 (Mean sea level 1929), 10 (Tweede Algemene Waterpassing (TAW))]</p> <p>(M) SCAMIN = [EU: 12000; US: 18750]</p> <p>(C) SORDAT = [YYYYMMDD]</p> <p>(C) SORIND = (Refer to Section B, General Guidance)</p>

# J - Rocks, Wrecks, Obstructions and Nature of Riverbed

## J.1 Rocks

### J.1.1 Rocks (C)

A concreted mass of stony material or coral that dries, is awash or is below the water surface.

Graphics	Encoding Instructions	Object Encoding
<p><i>IENC Symbolization</i></p> 	<p>A) In case the top end of the rock is vertically referred only to the mean water level of the waterway, 'uwtrroc' with 'watlev' has to be used.</p> <p>B) A drying height is indicated by a negative value within the attribute VALSOU. If this value is not known VALSOU=unknown shall be encoded.</p> <p>C) Groups of rocks can be encoded as obstruction area (see J.3.1)</p> <p>D) An UWTRROC or uwtrroc object may not share the same geospatial position with a SOUNDG object.</p> <p>E) Rocks and groups of rocks which are a hazard to navigation shall be encoded if the depth of the underwater rock is otherwise not displayed.</p> <p>F) If the depth of the underwater rock is less than the minimum depth of the surrounding depth area EXPSSOU has to be encoded.</p>	<p><b>Object Encoding</b></p> <p><b>Object Class = UWTRROC(P,A)</b></p> <p>(M) WATLEV = [1 (partly submerged at high water), 2 (always dry), 3 (always under water/submerged), 4 (covers and uncovers), 5 (awash)]</p> <p>(M) VALSOU = [+/- xx.x] (metres), e.g., -00.3 or unknown</p> <p>(O) NATSUR = [5 (stone), 9 (rock), 11 (lava), 14 (coral), 18 (boulder)]</p> <p>(C) EXPSSOU = (Refer to letter F)</p> <p>(O) QUASOU = [2 (depth unknown), 8 (value reported (not surveyed))]</p> <p>(M) SCAMIN = [22000; US: 18750]</p> <p>(C) SORDAT = [YYYYMMDD]</p> <p>(C) SORIND = (Refer to Section B, General Guidance)</p> <p><b>Object Encoding</b></p> <p><b>Object Class = uwtrroc(P,A)</b></p> <p>(M) watlev = [1 (partly submerged at high water), 2 (always dry), 3 (always under water/submerged), 4 (covers and uncovers), 8 (above mean water level), 9 (below mean water level)]</p> <p>(M) VALSOU = [+/- xx.x] (metres), e.g., -00.3 or unknown</p> <p>(C) EXPSSOU = (Refer to letter F)</p> <p>(O) NATSUR = [5 (stone), 9 (rock), 11 (lava), 14 (coral), 18 (boulder)]</p> <p>(M) SCAMIN = [EU: 22000; US: 18750]</p> <p>(C) SORDAT = [YYYYMMDD]</p> <p>(C) SORIND = (Refer to Section B, General Guidance)</p>






# J - Rocks, Wrecks, Obstructions and Nature of Riverbed

## J.2 Wrecks

### J.2.1 Wrecks (C)

The ruined remains of a stranded or sunken vessel that has been rendered useless. (IHO Dictionary, S-32, 5th Edition, 6027)

Graphics	Encoding Instructions	Object Encoding
<p><i>Real World</i></p>  <p><i>Chart Symbol</i></p>  <p><i>IENC Symbolization</i></p> 	<p>A) Any wreck in navigable water in- or outside the channel known to exist and confirmed through reliable means, shall be encoded.</p> <p>B) Wrecks are removed only upon confirmation from reliable means that the wreck does not exist at or near the charted position.</p> <p>C) The true or actual location is not needed for removal of the erroneous location.</p> <p>D) Use VALSOU only in case WATLEV = 3 and indicate the depth of the top end of the wreck referred to the same water level the surrounding depth information is also referred to.</p> <p>E) Where a WRECKS area includes other WRECKS point objects, the encoded values of the attributes QUASOU, TECSOU, VALSOU and WATLEV for the area object have to be identical to the values for the shallowest point object.</p> <p>F) If the depth of the wreck is less than the minimum depth of the surrounding depth area EXPSOU has to be encoded.</p>	<p><b>Object Encoding</b></p> <p><b>Object Class = WRECKS(P,A)</b></p> <p>(M) CATWRK = [1 (non-dangerous wreck), 2 (dangerous wreck), 3 (distributed remains of wreck), 4 (wreck showing mast/masts), 5 (wreck showing any portion of hull or superstructure)]</p> <p>(O) WATLEV = [1 (partly submerged at high water), 2 (always dry), 3 (always under water/submerged), 4 (covers and uncovers), 5 (awash)]</p> <p>(C) VALSOU = [xx.x or (UNKNOWN)] (metres), e.g., 00.3</p> <p>(O) QUASOU = [2 (depth unknown), 8 (value reported (not surveyed))]</p> <p>(O) TECSOU = [1 (found by echo-sounder), 2 (found by side-scan-sonar), 3 (found by multi-beam), 4 (found by diver), 5 (found by lead-line), 6 (swept by wire-drag), 7 (found by laser), 8 (swept by vertical acoustic system), 9 (found by electromagnetic sensor), 10 (photogrammetry), 11 (satellite imagery), 12 (found by levelling), 13 (swept by side-scan-sonar), 14 (computer generated)]</p> <p>(C) EXPSOU = (Refer to letter F)</p> <p>(O) STATUS = [12 (illuminated), 16 (watched), 17 (un-watched), 18 (existence doubtful)]</p> <p>(M) SCAMIN = [EU: 22000; US: 45000]</p> <p>(C) SORDAT = [YYYYMMDD]</p> <p>(C) SORIND = (Refer to Section B, General Guidance)</p>


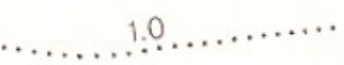
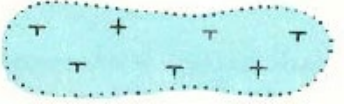
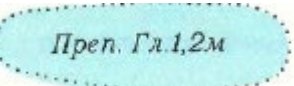
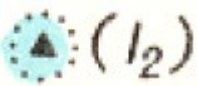



# J - Rocks, Wrecks, Obstructions and Nature of Riverbed

## J.3 Obstructions

### J.3.1 Obstruction (M)

In marine navigation, anything that hinders or prevents movement, particularly anything that endangers or prevents passage of a vessel. The term is usually used to refer to an isolated danger to navigation... (IHO Dictionary, S-32, 5th Edition, 3503)

Examples of obstructions include: snags, stumps, wellheads, diffusers, cribs, fish havens, foul areas, foul grounds, booms, ice booms and ground tackle.

Graphics	Encoding Instructions	Object Encoding
<p>Chart Symbol (ad A)</p> 	<p>A) Bank and shoal at a small scale are encoded as a point object class OBSTRN. Depth above the bank relative to the project water level is encoded by attribute VALSOU (Value of sounding).</p>	<p><b>Object Encoding</b>  <b>Object Class</b> = OBSTRN(P,L,A)  (O) CATOBS = [1 (snag/stump), 2 (wellhead), 3 (diffuser), 4 (crib), 5 (fish haven), 6 (foul area), 7 (foul ground), 8 (ice boom), 9 (ground tackle), 10 (boom), 11 (fishing net)]</p>
<p>Chart Symbol (ad B)</p> 	<p>B) Limits of obstruction are encoded as a spatial object (edge). The obstruction itself is encoded as a point object class OBSTRN with attribute CATOBS (Category of obstruction) set to corresponding value.</p>	<p>(C) NATSUR = (Refer to letter C)  (O) NATCON = [1 (masonry), 2 (concreted), 3 (loose boulders), 4 (hard surfaced), 6 (wooden), 7 (metal), 8 (GRP)]</p>
<p>Chart Symbol (ad C)</p> 	<p>C) Group of rocks is encoded as an area object class OBSTRN with attribute NATSUR = 9 (rocky).</p>	<p>(C) VALSOU = [x.xx m] (metres)  (C) EXPSOU = (Refer to letter P)</p>
<p>Chart Symbol (ad D)</p> 	<p>D) Underwater obstruction at a large scale is encoded as an area object class OBSTRN with attribute CATOBS set to corresponding value. Depth above the obstruction relative to the project water level is encoded by attribute VALSOU.</p>	<p>(C) WATLEV = [1 (partly submerged at high water), 2 (always dry), 3 (always under water/submerged), 4 (covers and uncovers), 5 (awash)]  (M) SCAMIN = [EU: 22000; US: 30000]</p>
<p>Chart Symbol (ad E)</p> 	<p>E) Underwater obstruction at a small scale is encoded as a point object class OBSTRN with attribute CATOBS set to corresponding value. Depth above the obstruction relative to the project water level is encoded by attribute VALSOU.</p>	<p>(C) SORDAT = [YYYYMMDD]  (C) SORIND = (Refer to Section B, General Guidance)</p>
<p>Chart Symbol (ad F)</p> 	<p>F) Pile under-water is encoded as a point object class OBSTRN with attribute CATOBS set to 1 (snag) and attribute WATLEV (Water level effect) set to 3 (always under water).</p>	
<p>Chart Symbol (ad G)</p> 	<p>G) Crib obstruction above-water is encoded as a point object class OBSTRN with attribute CATOBS set to 4 (crib) and attribute WATLEV (Water level effect) set to 2 (always dry).</p>	
<p>Chart Symbol (ad H)</p> 	<p>H) Pile obstruction above-water is encoded as a point object class</p>	

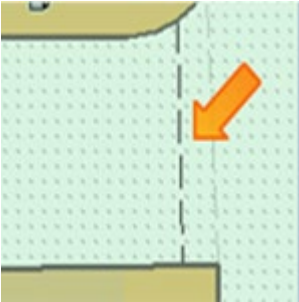
<p>Chart Symbol (ad I)</p>  <p>Chart Symbol (ad J)</p>  <p>IENC Symbolization</p> 	<p>OBSTRN with attribute CATOBS set to 1 (snag) and attribute WATLEV (Water level effect) set to 2 (always dry).</p> <p>I) Crib obstruction under-water is encoded as a point object class OBSTRN with attribute CATOBS set to 4 (crib) and attribute WATLEV (Water level effect) set to 3 (always under water).</p> <p>J) Pile obstruction under-water is encoded as a point object class OBSTRN with attribute CATOBS set to 1 (snag) and attribute WATLEV (Water level effect) set to 3 (always under water).</p> <p>K) Snags, stumps, wellheads, diffusers, fish havens, foul areas, foul grounds, booms, ice booms and ground tackle should be encoded as obstruction (OBSTRN), if they endanger or prevent the passage of vessels.</p> <p>L) Diffusers are encoded as OBSTRN with CATOBS = 3 (diffuser).</p> <p>M) If the nature of a dangerous underwater object, dangerous underwater area, or floating object is not explicitly known, it must be encoded as an OBSTRN.</p> <p>N) Where an OBSTRN area includes other OBSTRN point objects, the encoded values of the attributes VALSOU and WATLEV for the area object have to be identical to the values for the shallowest point object.</p> <p>O) Fishing net obstruction above-water is encoded as a line or area object class OBSTRN with attribute CATOBS set to 11 (fishing net) and attribute WATLEV (Water level effect) set to 2 (always dry).</p> <p>P) If the depth of the obstruction is less than the minimum depth of the surrounding depth area EXPSOU has to be encoded.</p>	
--	--	--

# J - Rocks, Wrecks, Obstructions and Nature of Riverbed

## J.3 Obstructions

### J.3.2 Oil Barrier (M)

A construction to dam oil flow on water. (S-57standard)


Graphics	Encoding Instructions	Object Encoding
<p><i>IENC Symbolization</i></p> 		<p><b><u>Object Encoding</u></b></p> <p><b>Object Class = OILBAR(L)</b></p> <p>(O) CATOLB = [1 (oil retention (high pressure pipe)), 2 (floating oil barrier)]</p> <p>(M) SCAMIN = [EU: 8000; US: 12000]</p> <p>(C) SORDAT = [YYYYMMDD]</p> <p>(C) SORIND = (Refer to Section B, General Guidance)</p>

# J - Rocks, Wrecks, Obstructions and Nature of Riverbed

## J.4 Nature of Riverbed

### J.4.1 Nature of Bottom (O)

The nature of bottom includes the material of which it is composed and its physical characteristics. Also called character (or characteristics) of the bottom, or quality of the bottom. (S-57 Standard)


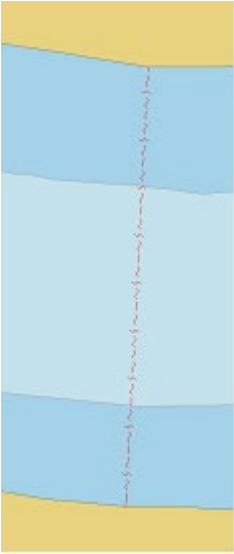
Graphics	Encoding Instructions	Object Encoding
<p><i>Chart Symbol</i></p> 	<p>A) Coding as point, line or area is subject to data availability or subject to the scale of the chart.</p>	<p><b>Object Encoding</b></p> <p><b>Object Class = SBDARE(P,L,A)</b></p> <p>(M) NATQUA = [1 (Fine), 2 (Medium), 3 (Coarse), 4 (Broken)]</p> <p>(O) NATSUR = [1 (mud), 2 (clay), 3 (silt), 4 (sand), 5 (stone), 6 (gravel), 7 (pebbles), 8 (cobbles), 9 (rock), 18 (boulder)]</p> <p>(M) SCAMIN = [45000]</p> <p>(C) SORDAT = [YYYYMMDD]</p> <p>(C) SORIND = (Refer to Section B, General Guidance)</p>

# K - Offshore Installations

## K.1 Submarine Cables

### K.1.1 Submarine Cable (C)

An assembly of wires or fibres, or a wire rope or chain which has been laid underwater or buried beneath the seabed  
(Hydrographic Service, Royal Australian Navy)

Graphics	Encoding Instructions	Object Encoding
<p><i>Chart Symbol</i></p>  <p><i>IENC Symbolization</i></p> 	<p>A) Only cables or cable areas where anchoring is prohibited need to be encoded.</p> <p>B) Cable features should be encoded just inside the bankline to minimize clutter.</p> <p>C) If there are multiple cables in the same area, do not code as cable, submarine (CBLSUB), but as a CBLARE (see K.1.2 Submarine Cable Area)</p> <p>D) EU: If there is an anchoring prohibited notice mark this should be encoded by an anchoring prohibited 'notmrk' object (see O.3.1).</p> <p>E) EU: If there is a notice mark indicating the presence of a submarine cable this may be encoded by an anchoring prohibited 'notmrk' object (see O.3.1). If such a notice mark is positioned in the waterway, it must be encoded.</p> <p>F) US: Create CTNARE object buffering the cable 20 metres upstream and downstream of the cable.</p> <p>G) Use STATUS = 18 (existence doubtful) in the case where the existence of the feature cannot be confirmed.</p>	<p><b>Object Encoding</b></p> <p><b>Object Class = CBLSUB(L)</b></p> <p>(O) CATCBL = [1 (power line), 3 (transmission line), 4 (telephone), 5 (telegraph), 6 (mooring cable/chain)]</p> <p>(O) OBJNAM = [owner name]</p> <p>(O) NOBJNM = (Refer to Section B, General Guidance)</p> <p>(C) STATUS = (Refer to letter G)</p> <p>(O) CONDTN = [1 (under construction), 2 (ruined), 3 (under reclamation), 5 (planned construction)]</p> <p>(M) SCAMIN = [EU: 22000; US: 60000]</p> <p>(C) SORDAT = [YYYYMMDD]</p> <p>(C) SORIND = (Refer to Section B, General Guidance)</p> <p><b>Coding notice mark</b></p> <p><b>Object Class = notmrk(P)</b></p> <p>(M) catnmk = [8 (no anchoring or trailing of anchors, cables or chains)]</p> <p>(M) fnctnm = [1 (prohibition mark)]</p> <p>(O) dirimp = [1 (upstream), 2 (downstream), 3 (to the left bank), 4 (to the right bank)]</p> <p>(O) disipd = [xxxx] (metres), e.g., 2120</p> <p>(O) disipu = [xxxx] (metres), e.g., 1730</p> <p>(O) addmrk = [1 (top (board)), 2 (bottom (board)), 3 (right (triangle to the right)), 4 (left (triangle to the left)), 5 (bottom (triangle to the bottom))]</p> <p>(O) marsys = [1 (IALA A), 2 (IALA B), 9 (no system), 10 (other system), 11 (CEVNI), 12 (Russian inland waterway regulations), 13 (Brazilian national inland waterway regulations - two sides), 14 (Brazilian national inland waterway regulations - side independent), 15 (Paraguay-Parana waterway - Brazilian complementary aids)]</p> <p>(O) STATUS = [8 (private), 12 (illuminated), 14 (public)]</p> <p>(O) INFORM = [text of additional marks in</p>

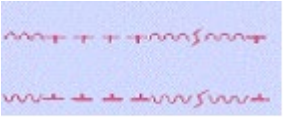
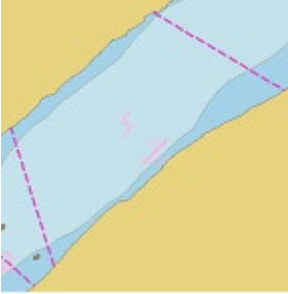
		<p>English]</p> <p>(O) NINFOM = (Refer to Section B, General Guidance)</p> <p>(O) CONDTN = [1 (under construction), 2 (ruined), 3 (under reclamation), 5 (planned construction)]</p> <p>(M) SCAMIN = [22000]</p> <p>(C) SORDAT = [YYYYMMDD]</p> <p>(C) SORIND = (Refer to Section B, General Guidance)</p> <p><b><u>Object Encoding</u></b></p> <p><b>Object Class</b> = CTNARE(A)</p> <p>(M) INFORM = ["Cable buffer zone"]</p> <p>(M) SCAMIN = [EU: 22000; US: 60000]</p> <p>(C) SORDAT = [YYYYMMDD]</p> <p>(C) SORIND = (Refer to Section B, General Guidance)</p>
--	--	---

# K - Offshore Installations

## K.1 Submarine Cables

### K.1.2 Submarine Cable Area (C)

An area which contains one or more submarine cables. (S-57 Standard)

Graphics	Encoding Instructions	Object Encoding
<p><i>Chart Symbol</i></p>  <p><i>IENC Symbolization</i></p> 	<p>A) Only cables or cable areas where anchoring is prohibited need to be encoded.</p> <p>B) CBLARE should generally be used if; <math>dFCLC/NC &lt; 50</math>, where <math>dFCLC</math> is distance between first cable and last cable in designated area, and <math>NC</math> is the number of cables; cartographic judgment should still be applied for final analysis.</p> <p>Cable areas should be used, unless very precise single cable data is available. Symbology should never be used due to the unreliability of the cable location.</p> <p>C) Do not use both Cable and Cable Area to represent the same feature.</p> <p>D) If various types of cables exist in the area, include description in TXTDSC. If at least one of the cables is a powerline, CATCBL = 1 has to be used.</p> <p>E) US: Extend CBLARE 20 metres beyond first and last cable; farther if uncertainty is greater.</p> <p>F) EU: In case there is an anchoring prohibited notice mark this should be encoded by an anchoring prohibited 'notmrk' object (see O.3.1).</p> <p>G) EU: In case there is a notice mark indicating the presence of a submarine cable, this may be encoded by an anchoring prohibited 'notmrk' object (see O.3.1). If such a notice mark is positioned in the waterway it must be encoded.</p> <p>H) Use STATUS = 18 (existence doubtful) in the case where the existence of the feature cannot be confirmed.</p> <p>I) EU: If the authority has extended the application of the prohibition of anchoring to the use of telescopic piles (spuds) in accordance with Article 7.03 of CEVNI rev. 5, restrn</p>	<p><b>Object Encoding</b></p> <p><b>Object Class = CBLARE(A)</b></p> <p>(O) CATCBL = [1 (power line), 3 (transmission line), 4 (telephone), 5 (telegraph), 6 (mooring cable/chain)]</p> <p>(M) RESTRN = [1 (anchoring prohibited), 38 (use of spuds prohibited)]</p> <p>(O) OBJNAM = [owner name]</p> <p>(O) NOBJNM = (Refer to Section B, General Guidance)</p> <p>(C) STATUS = (Refer to letter H)</p> <p>(O) CONDTN = [1 (under construction), 2 (ruined), 3 (under reclamation), 5 (planned construction)]</p> <p>(M) SCAMIN = [EU: 22000; US: 60000]</p> <p>(C) SORDAT = [YYYYMMDD]</p> <p>(C) SORIND = (Refer to Section B, General Guidance)</p> <p><b>Object Encoding</b></p> <p><b>Object Class = notmrk(P)</b></p> <p>(M) catnmk = [8 (no anchoring or trailing of anchors, cables or chains)]</p> <p>(M) fnctnm = [1 (prohibition mark)]</p> <p>(O) dirimp = [1 (upstream), 2 (downstream), 3 (to the left bank), 4 (to the right bank)]</p> <p>(O) disipd = [xxxx] (metres), e.g., 2120</p> <p>(O) disipu = [xxxx] (metres), e.g., 1730</p> <p>(O) addmrk = [1 (top (board)), 2 (bottom (board)), 3 (right (triangle to the right)), 4 (left (triangle to the left)), 5 (bottom (triangle to the bottom))]</p> <p>(O) marsys = [1 (IALA A), 2 (IALA B), 9 (no system), 10 (other system), 11 (CEVNI), 12 (Russian inland waterway regulations), 13 (Brazilian national inland waterway regulations - two sides), 14 (Brazilian national inland waterway regulations - side independent), 15 (Paraguay-Parana waterway - Brazilian complementary aids)]</p> <p>(O) STATUS = [8 (private), 12 (illuminated),</p>



	<p>=38 (use of spuds prohibited) must be encoded.</p>	<p>14 (public]  (O) INFORM = [text of additional marks in English]  (O) NINFOM = (Refer to Section B, General Guidance)  (O) CONDTN = [1 (under construction), 2 (ruined), 3 (under reclamation), 5 (planned construction)]  (M) SCAMIN = [22000]  (C) SORDAT = [YYYYMMDD]  (C) SORIND = (Refer to Section B, General Guidance)</p>
--	---	---




# K - Offshore Installations

## K.2 Submarine Pipelines

### K.2.1 Submarine Pipeline (C)

A pipeline is a string of interconnected pipes used for the transport of matter, nowadays mainly oil or gas. (IHO Dictionary, S-32, 5th Edition, 3857)

A submarine or land pipeline is a pipeline lying on or buried under the seabed or the land. (S-57 Standard)

Graphics	Encoding Instructions	Object Encoding
<p><i>Real World</i></p>  <p><i>Chart Symbol</i></p>  <p><i>IENC Symbolization</i></p> 	<p>A) Pipeline features should be collected just inside the bankline to minimize clutter.</p> <p>B) Only pipelines or pipeline areas where anchoring is prohibited need to be encoded.</p> <p>C) See PIPARE for multiple pipelines.</p> <p>D) EU: In case there is an anchoring prohibited notice mark this should be encoded by an anchoring prohibited 'notmrk' object (see O.3.1).</p> <p>E) EU: In case there is a notice mark indicating the presence of a submarine pipeline this may be encoded by an anchoring prohibited 'notmrk' object (see O.3.1). If such a notice mark is positioned in the waterway it must be encoded.</p> <p>F) US: Create CTNARE object buffering the pipeline 20 metres upstream and downstream of the pipeline</p> <p>G) US: For water intakes, place point PIPSOL object near intake location if actual pipe (line) location is unknown. Place 20 metre diameter CTNARE around PIPSOL (P).</p> <p>H) Use STATUS = 18 (existence doubtful) in the case where the existence of the feature cannot be confirmed.</p>	<p><b>Object Encoding</b></p> <p><b>Object Class = PIPSOL(P,L)</b></p> <p>(O) CATPIP = [2 (outfall pipe), 3 (intake pipe), 4 (sewer), 6 (supply pipe)]</p> <p>(O) PRODCAT = [1 (oil), 2 (gas), 3 (water), 7 (chemicals), 8 (drinking water)]</p> <p>(O) OBJNAM = [owner name]</p> <p>(O) NOBJNM = (Refer to Section B, General Guidance)</p> <p>(C) STATUS = (Refer to letter H)</p> <p>(O) CONDTN = [1 (under construction), 2 (ruined), 3 (under reclamation), 5 (planned construction)]</p> <p>(M) SCAMIN = [EU: 22000; US: 60000]</p> <p>(C) SORDAT = [YYYYMMDD]</p> <p>(C) SORIND = (Refer to Section B, General Guidance)</p> <p><b>Object Encoding</b></p> <p><b>Object Class = notmrk(P)</b></p> <p>(M) catnmk = [8 (no anchoring or trailing of anchors, cables or chains)]</p> <p>(M) fnctnm = [1 (prohibition mark)]</p> <p>(O) dirimp = [1 (upstream), 2 (downstream), 3 (to the left bank), 4 (to the right bank)]</p> <p>(O) disipd = [xxxx] (metres), e.g., 2120</p> <p>(O) disipu = [xxxx] (metres), e.g., 1730</p> <p>(O) addmrk = [1 (top (board)), 2 (bottom (board)), 3 (right (triangle to the right)), 4 (left (triangle to the left)), 5 (bottom (triangle to the bottom))]</p> <p>(O) marsys = [1 (IALA A), 2 (IALA B), 9 (no system), 10 (other system), 11 (CEVNI), 12 (Russian inland waterway regulations), 13 (Brazilian national inland waterway regulations - two sides), 14 (Brazilian national inland waterway regulations - side independent), 15 (Paraguay-Parana waterway - Brazilian complementary aids)]</p> <p>(O) STATUS = [8 (private), 12 (illuminated),</p>



		<p>14 (public)]</p> <p>(O) INFORM = [text of additional marks in English]</p> <p>(O) NINFOM = (Refer to Section B, General Guidance)</p> <p>(O) CONDTN = [1 (under construction), 2 (ruined), 3 (under reclamation), 5 (planned construction)]</p> <p>(M) SCAMIN = [22000]</p> <p>(C) SORDAT = [YYYYMMDD]</p> <p>(C) SORIND = (Refer to Section B, General Guidance)</p> <p><b><u>Object Encoding</u></b></p> <p><b>Object Class = CTNARE(A)</b></p> <p>(M) INFORM = ["Pipeline buffer zone"]</p> <p>(M) SCAMIN = [EU: 22000; US: 60000]</p> <p>(C) SORDAT = [YYYYMMDD]</p> <p>(C) SORIND = (Refer to Section B, General Guidance)</p>
--	--	--

# K - Offshore Installations

## K.2 Submarine Pipelines

### K.2.2 Submarine Pipeline Area (C)

An area containing one or more pipelines. (S-57 Standard)

Graphics	Encoding Instructions	Object Encoding
<p><i>Chart Symbol</i></p>  <p><i>IENC Symbolization</i></p> 	<p>A) Only pipelines or pipeline areas where anchoring is prohibited need to be encoded.</p> <p>B) PIPARE generally should be used if; <math>dFPLP/NP &lt; 50</math>, where dFPLP is distance between first pipe and last pipe in designated area, and NP is the number of pipes; cartographic judgment still should be applied for final analysis.</p> <p>C) Extend PIPARE 20 metres beyond first and last pipe; farther if uncertainty is greater.</p> <p>D) Use multiple values for CATPIP if various types are in the PIPARE.</p> <p>E) EU: In case there is an anchoring prohibited notice mark this should be encoded by an anchoring prohibited 'notmrk' object (see O.3.1).</p> <p>F) EU: In case there is a notice mark indicating the presence of a submarine pipeline this may be encoded by an anchoring prohibited 'notmrk' object (see O.3.1). If such a notice mark is positioned in the waterway it must be encoded.</p> <p>G) Use STATUS = 18 (existence doubtful) in the case where the existence of the feature cannot be confirmed.</p> <p>H) EU: If the authority has extended the application of the prohibition of anchoring to the use of telescopic piles (spuds) in accordance with Article 7.03 of CEVNI rev. 5, restrn =38 (use of spuds prohibited) must be encoded.</p>	<p><b>Object Encoding</b></p> <p><b>Object Class = PIPARE(A)</b></p> <p>(O) CATPIP = [2 (outfall pipe), 3 (intake pipe), 4 (sewer), 6 (supply pipe)]</p> <p>(O) PRODC T = [1 (oil), 2 (gas), 3 (water), 7 (chemicals), 8 (drinking water)]</p> <p>(M) RESTRN = [1 (anchoring prohibited), 38 (use of spuds prohibited)]</p> <p>(O) OBJNAM = [owner name]</p> <p>(O) NOBJNM = (Refer to Section B, General Guidance)</p> <p>(C) STATUS = (Refer to letter G)</p> <p>(O) CONDTN = [1 (under construction), 2 (ruined), 3 (under reclamation), 5 (planned construction)]</p> <p>(M) SCAMIN = [EU: 22000; US: 60000]</p> <p>(C) SORDAT = [YYYYMMDD]</p> <p>(C) SORIND = (Refer to Section B, General Guidance)</p> <p><b>Coding notice mark</b></p> <p><b>Object Class = notmrk(P)</b></p> <p>(M) catnmk = [8 (no anchoring or trailing of anchors, cables or chains)]</p> <p>(M) fnctnm = [1 (prohibition mark)]</p> <p>(O) dirimp = [1 (upstream), 2 (downstream), 3 (to the left bank), 4 (to the right bank)]</p> <p>(O) disipd = [xxxx] (metres), e.g., 2120</p> <p>(O) disipu = [xxxx] (metres), e.g., 1730</p> <p>(O) addmrk = [1 (top (board)), 2 (bottom (board)), 3 (right (triangle to the right)), 4 (left (triangle to the left)), 5 (bottom (triangle to the bottom))]</p> <p>(O) marsys = [1 (IALA A), 2 (IALA B), 9 (no system), 10 (other system), 11 (CEVNI), 12 (Russian inland waterway regulations), 13 (Brazilian national inland waterway regulations - two sides), 14 (Brazilian national inland waterway regulations - side independent), 15 (Paraguay-Parana waterway)]</p>


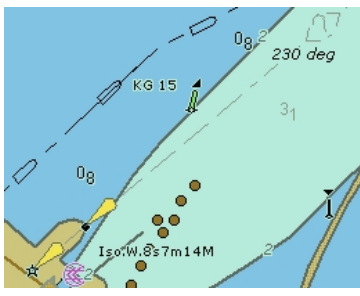
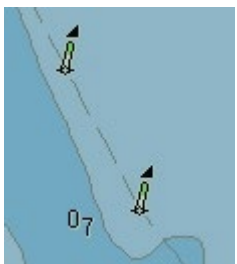
		<p>- Brazilian complementary aids]]</p> <p>(O) STATUS = [8 (private), 12 (illuminated), 14 (public)]</p> <p>(O) INFORM = [text of additional marks in English]</p> <p>(O) NINFOM = (Refer to Section B, General Guidance)</p> <p>(O) CONDTN = [1 (under construction), 2 (ruined), 3 (under reclamation), 5 (planned construction)]</p> <p>(M) SCAMIN = [22000]</p> <p>(C) SORDAT = [YYYYMMDD]</p> <p>(C) SORIND = (Refer to Section B, General Guidance)</p>
--	--	---

# L - Tracks, Routes

## L.1 Tracks

### L.1.1 Navigation Line (O)

A navigation line either defines a recommended track or marks the boundary between a safe and a dangerous area.

Graphics	Encoding Instructions	Object Encoding
<p><i>Chart Symbol</i></p>  <p><i>IENC Symbolization</i></p>  <p><i>IENC Symbolization</i></p> 	<p>A) A navigation line is usually defined by two (leading) lights or beacons or a directional light.</p> <p>B) The extent of the navigation line depends on the visibility of the navigational aid(s).</p> <p>C) The recommended track (L.1.2) is that portion of a 'navigation line' that a ship should use for navigation.</p> <p>D) ORIENT is the direction from the waterside towards the lights or beacons.</p>	<p><b>Object Encoding</b></p> <p><b>Object Class = NAVLNE(L)</b></p> <p>(M) CATNAV = [1 (clearing line), 2 (transit line), 3 (leading line bearing a recommended track)]</p> <p>(M) ORIENT = [xxx or (UNKNOWN)] (degree (°)), e.g., 110</p> <p>(M) SCAMIN = [EU: 22000; US: 45000]</p> <p>(C) SORDAT = [YYYYMMDD]</p> <p>(C) SORIND = (Refer to Section B, General Guidance)</p>

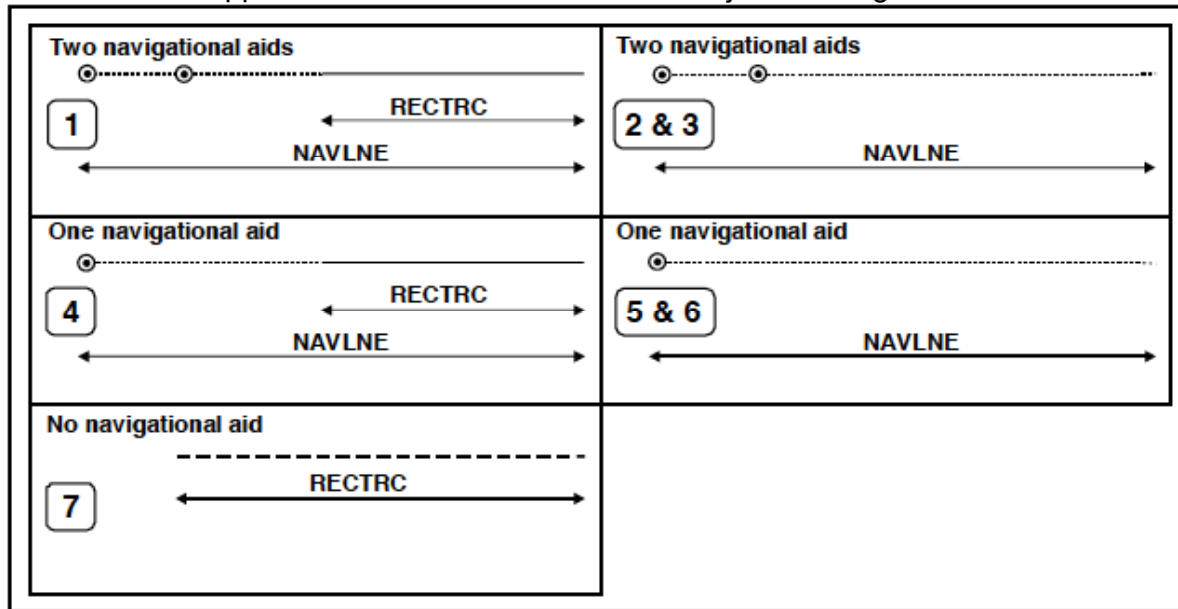




Figure 15		NAVLNE	RECTRC	Navigational aids
1	Recommended track on a leading line	CATNAV = 3	CATTRK = 1	at least 2
2	Clearing line on marks in line	CATNAV = 1	none	at least 2
3	Transit line on marks in line	CATNAV = 2	none	at least 2
4	Recommended track on a bearing	CATNAV = 3	CATTRK = 1	1
5	Clearing line on a bearing	CATNAV = 1	none	1
6	Transit line on a bearing	CATNAV = 2	none	1
7	Recommended track not based on fixed marks	none	CATTRK = 2	none

# L - Tracks, Routes

## L.1 Tracks

### L.1.2 Sailing Line / Recommended Track (C)


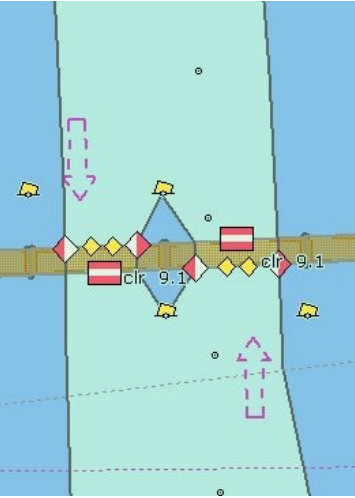
Recommended sailing route for all or certain vessels.

Graphics	Encoding Instructions	Object Encoding
<p><i>Chart Symbol</i></p>  <p><i>IENC Symbolization</i></p> 	<p>A) Line should follow known safe and optimal route used by commercial vessels. If no such route is known, the deepest area within the channel, current patterns, and any obstructions to navigation should be considered.</p> <p>B) The recommended track is that portion of a 'navigation line' that a ship should use for navigation.</p> <p>C) ORIENT is the direction from the waterside towards the lights or beacons.</p> <p>D) US: CATTRK always = 2 (not based on a system of fixed marks) ORIENT always = "Unknown"</p> <p>E) US: A second sailing line should be used only if needed for routing through an alternate lock, or around a lock, if warranted. Primary and secondary sailing line must be distinguished with INFORM attribute, and use of SEAARE object for labeling.</p> <p>F) US: Sailing line must be within Depth Area or Lock Chamber.</p> <p>G) EU: If a recommended track exists, it must be encoded.</p>	<p><b>Object Encoding</b></p> <p><b>Object Class = RECTRC(L)</b></p> <p>(M) CATTRK = [1 (based on a system of fixed marks), 2 (not based on a system of fixed marks)]</p> <p>(M) ORIENT = [xxx or (UNKNOWN)] (degree (°)), e.g., 110</p> <p>(M) TRAFIC = [1 (inbound), 2 (outbound), 3 (one-way), 4 (two-way)]</p> <p>(C) INFORM = (Refer to letter E)</p> <p>(M) SCAMIN = [45000]</p> <p>(C) SORDAT = [YYYYMMDD]</p> <p>(C) SORIND = (Refer to Section B, General Guidance)</p> <p><b>Conditional - Please refer to F</b></p> <p><b>Object Class = SEAARE(P)</b></p> <p>(M) OBJNAM = ["Primary Sailing Line" or "Secondary Sailing Line"]</p> <p>(O) NOBJNM = (Refer to Section B, General Guidance)</p> <p>(M) SCAMIN = [45000]</p> <p>(C) SORDAT = [YYYYMMDD]</p> <p>(C) SORIND = (Refer to Section B, General Guidance)</p>

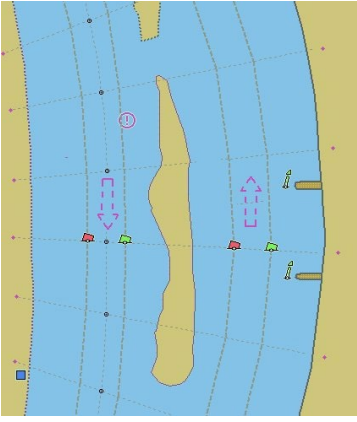


### L.1.3 Two-way Route Part (O)

A two-way route part is either for the entire area, or a part of an area where the traffic flow is restricted to one-way.

Graphics	Encoding Instructions	Object Encoding
<p><i>IENC Symbolization</i></p>  <p><i>IENC Symbolization</i></p> 	<p>A) Two way route parts will generally be two-way but some may be restricted to one-way traffic flow.</p> <p>B) In a two-way route with one-way sections, separate area objects should be made for parts with TRAFIC = 3 (one-way)</p> <p>C) In one-way sections the attribute ORIENT must indicate the true direction of traffic flow, not its reciprocal. In two-way sections ORIENT may indicate either direction.</p> <p>D) The two-way route parts in front and behind of a bridge must be at least 200m long.</p> <p>E) To avoid the symbolization of the boundary of a two-way route part at the borderline between two cells, the edge may be masked.</p> <p>F) This feature could be aggregated to a bridge by a C_AGGR object.</p>	<p><b>Object Encoding</b></p> <p><b>Object Class = TWRTPT(A)</b></p> <p>(M) ORIENT = [xxx.xx (degrees), e.g. 246.7 for an orientation of 246.7 degrees]</p> <p>(M) TRAFIC = [3 (one-way), 4 (two-way)]</p> <p>(M) SCAMIN = [EU: 12000; US: 18750]</p> <p>(C) SORDAT = [YYYYMMDD]</p> <p>(C) SORIND = (Refer to Section B, General Guidance)</p>

*IENC Symbolization*




# L - Tracks, Routes

## L.1 Tracks

### L.1.4 Waterway Axis (C)

The waterway axis can be defined by e.g.:

1. the middle line of a fairway,
2. the middle line of a waterway (the waterway covers the entire area of a river or a canal)

Graphics	Encoding Instructions	Object Encoding
<p><i>IENC Symbolization</i></p> 	<p>A) EU: The waterway axis must be encoded if an Inland ENC is intended to be used for navigation mode.</p> <p>B) If a fairway exists, the middle line of the fairway shall be used to define the waterway axis.</p> <p>C) For an update of an existing Inland ENC, if possible, the waterway axis (wtwaxs) should be based on the middle line of a fairway rather than the middle line of a waterway. (For EU Member States: The replacement of an axis can be done in connection with the fulfilment of the minimum requirements set out in article 4 of the European RIS Directive.)</p> <p>D) Ideally, the waterway axis should be a continuous line that marks, at every position, the middle line of a fairway. If this is not feasible, the axis can be built as a lineal connection between points that show the middle line of the fairway every 100 metres (= 1/10 kilometre) or 1/10 mile, 1/10 sea mile etc.</p> <p>E) For distance marks along the waterway axis see L.3.2.</p> <p>F) In case of two different systems of waterway distances in one area, one of them has to be selected for the waterway axis.</p>	<p><b><u>Object Encoding</u></b></p> <p><b>Object Class = wtwaxs(L)</b></p> <p>(O) catccl = [1 (0 small vessels and pleasure craft), 2 (I peniche), 3 (II campine barge), 4 (III Dortmund-Ems barge), 5 (IV Rhine-Herne barge), 6 (Va Large Rhine barge; 1-barge push-tow unit), 7 (Vb 2-barge push-tow unit; long formation), 8 (VIa 2-barge push-tow unit; wide formation), 9 (VIb 4-barge push-tow unit), 10 (VIc 6-barge push-tow unit), 11 (No CEMT class), 12 (VII 9-barge push-tow unit)]</p> <p>(M) OBJNAM = [name of public waterway / or part of a waterway]</p> <p>(O) NOBJNM = [content of OBJNAM in national language]</p> <p>(M) SCAMIN = [EU: 22000; US: 45000]</p> <p>(C) SORDAT = [YYYYMMDD]</p> <p>(C) SORIND = (Refer to Section B, General Guidance)</p>

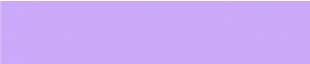
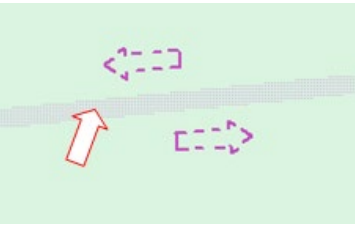
# L - Tracks, Routes

## L.1 Tracks

### L.1.5 Traffic Separation Zone (C)

A traffic separation scheme is a scheme which aims to reduce the risk of collision in congested and/or converging areas by separating traffic moving in opposite, or nearly opposite, directions. (IHO Dictionary, S-32, 5th Edition, 5585)

A traffic separation zone is a zone separating the lanes in which ships are proceeding in opposite or nearly opposite directions; or separating traffic lanes designated for particular classes of ships proceeding in the same direction (IMO Ships Routing, 6th Edition).



Graphics	Encoding Instructions	Object Encoding
<p><i>Chart Symbol</i></p>  <p><i>IENC Symbolization</i></p> 	<p>A) If a structured external XML-file with more detailed communication information is available, the reference to the file has to be entered in the TXTDSC attribute.</p> <p>B) Use STATUS if any of the conditions apply.</p> <p>C) EU: Traffic Separation Zones must be encoded.</p>	<p><b>Object Encoding</b></p> <p><b>Object Class = TSEZNE(A)</b></p> <p>(M) CATTSS = [1 (IMO - adopted), 2 (not IMO - adopted)]</p> <p>(O) DATSTA = (Refer to Section J, DATSTA, DATEND, PERSTA and PEREND)</p> <p>(O) DATEND = (Refer to Section J, DATSTA, DATEND, PERSTA and PEREND)</p> <p>(C) STATUS = [3 (recommended), 9 (mandatory)]</p> <p>(C) TXTDSC = (Refer to letter A)</p> <p>(M) SCAMIN = [EU: 260000]</p> <p>(C) SORDAT = [YYYYMMDD]</p> <p>(C) SORIND = (Refer to Section B, General Guidance)</p>

# L - Tracks, Routes

## L.2 Ferries

### L.2.1 Cable Ferry (M)

A route in a body of water where a ferry crosses from one shoreline to another. In this specific case a ferry that follows a fixed route guided by a cable (adapted from IHO Specifications , M-4). (Digital Geographic Information Working Group, Oct.87)  
 Cable ferries (either assisted by propulsion or not) are fixed to a cable. This cable is crossing the river either above or below water surface

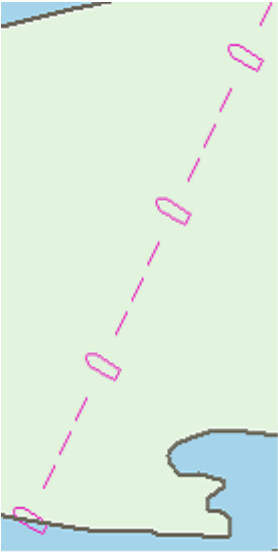
Graphics	Encoding Instructions	Object Encoding
<p><i>Real World</i></p>  <p><i>IENC Symbolization</i></p> 	<p>A) Code the route that connects the docks or mooring facilities used by the ferry.</p> <p>B) The route should be the path officially permitted by the relevant authority. If no such official designation, use the route typically used by the ferry vessel(s).</p> <p>C) Use STATUS if any of the conditions apply.</p> <p>D) A ferry may use a high water route and low water route. Label in INFORM as "Used for Low Water" and "Used for High Water"</p> <p>E) If the ferry is connected to a leading cable, which crosses the fairway above the water surface, this cable shall be encoded as an overhead cable.</p> <p>F) If the ferry has a special time schedule or special operating hours apply, the object can be combined with a time schedule. For this purpose please refer to the time schedule (general) object 'tisdge' see T.1.1</p> <p>G) If a structured external XML-file with more detailed communication information is available, the reference to the file has to be entered in the TXTDSC attribute.</p>	<p><b>Object Encoding</b></p> <p><b>Object Class = FERYRT(L)</b></p> <p>(M) CATFRY = [2 (cable ferry)]</p> <p>(O) OBJNAM = [name of ferry]</p> <p>(O) NOBJNM = (Refer to Section B, General Guidance)</p> <p>(O) INFORM = (Refer to letter D)</p> <p>(O) NINFOM = (Refer to Section B, General Guidance)</p> <p>(C) STATUS = [2 (occasional), 4 (not in use)]</p> <p>(O) TXTDSC = (Refer to letter G)</p> <p>(M) SCAMIN = [EU: 45000; US: 60000]</p> <p>(C) SORDAT = [YYYYMMDD]</p> <p>(C) SORIND = (Refer to Section B, General Guidance)</p>

# L - Tracks, Routes

## L.2 Ferries

### L.2.2 Free Moving Ferry (C)

A route in a body of water where a ferry crosses from one shoreline to another. In this specific case a ferry which may have routes that vary with weather, tide and traffic. (adapted from M-4) (Digital Geographic Information Working Group, Oct.87)


Graphics	Encoding Instructions	Object Encoding
<p><i>Chart Symbol</i></p> <div data-bbox="103 527 319 686" style="border: 1px solid red; padding: 5px; color: red; text-align: center;"> <b>Image to be included at a later date</b> </div> <p><i>IENC Symbolization</i></p> 	<ul style="list-style-type: none"> <li>A) Code the route that connects the docks or mooring facilities used by the ferry.</li> <li>B) The route should be the path officially permitted by the relevant authority. If no such official designation exists, use the route typically used by the ferry vessel(s).</li> <li>C) Use STATUS if any of the conditions apply.</li> <li>D) A ferry may use a high water route and low water route. Label in INFORM as "Used for Low Water" and "Used for High Water"</li> <li>E) If the ferry has a special time schedule or special operating hours apply, the object can be combined with a time schedule. For this purpose refer to the time schedule (general) object 'tisdge' see T.1.1</li> <li>F) If a structured external XML-file with more detailed communication information is available, the reference to the file has to be entered in the TXTDSC attribute.</li> <li>G) If an officially designated route exists and a free moving ferry is crossing the waterway and not following the traffic flow it must be encoded.</li> </ul>	<p><b>Object Encoding</b></p> <p><b>Object Class = FERYRT(L)</b></p> <p>(M) CATFRY = [1 ('free-moving' ferry)]</p> <p>(O) OBJNAM = [name of ferry]</p> <p>(O) NOBJNM = (Refer to Section B, General Guidance)</p> <p>(O) INFORM = (Refer to letter D)</p> <p>(O) NINFOM = (Refer to Section B, General Guidance)</p> <p>(C) STATUS = [2 (occasional), 4 (not in use)]</p> <p>(O) TXTDSC = (Refer to letter F)</p> <p>(M) SCAMIN = [EU: 45000; US: 60000]</p> <p>(C) SORDAT = [YYYYMMDD]</p> <p>(C) SORIND = (Refer to Section B, General Guidance)</p>

# L - Tracks, Routes

## L.2 Ferries

### L.2.3 Swinging Wire Ferry (M)

A route in a body of water where a ferry crosses from one shoreline to another. A "Swinging Wire Ferry" is connected to a fixed point (e.g., an anchor in the middle of the waterway) and swings around this point from shore to shore via a cable to an anchor. The cable runs more or less parallel to the current. (Digital Geographic Information Working Group, Oct.87)

Graphics	Encoding Instructions	Object Encoding
<p><i>Real World</i></p> 	<p>A) Code the route that connects the docks or mooring facilities used by the ferry.</p> <p>B) The route should be the path officially permitted by the relevant authority. If no such official designation exists, use the route typically used by the ferry vessel(s).</p> <p>C) Use special purpose mark with CATSPM =37 (ferry crossing mark) to encode the supporting pontoons.</p> <p>D) Use STATUS if any of the conditions apply.</p> <p>E) A ferry may use a high water route and low water route. Label in INFORM as "Used for Low Water" and "Used for High Water"</p> <p>F) If the ferry has a special time schedule or special operating hours apply, the object can be combined with a time schedule. For this purpose please refer to the time schedule (general) object 'tisdge' see T.1.1</p> <p>G) If a structured external XML-file with more detailed communication information is available, the reference to the file has to be entered in the TXTDSC attribute.</p> <p>H) For the cable between the ferry and the fixed point (e.g. anchor, mast) use a CBLARE (not a CBLSUB or cblohd), as the position of the cable changes during the ride.</p>	<p><b>Object Encoding</b></p> <p><b>Object Class = feryrt(L)</b></p> <p>(M) catfry = [4 (swinging wire ferry)]</p> <p>(O) OBJNAM = [name of ferry]</p> <p>(O) NOBJNM = (Refer to Section B, General Guidance)</p> <p>(O) INFORM = (Refer to letter E)</p> <p>(O) NINFOM = (Refer to Section B, General Guidance)</p> <p>(C) STATUS = [2 (occasional), 4 (not in use)]</p> <p>(O) TXTDSC = (Refer to letter G)</p> <p>(M) SCAMIN = [EU: 45000; US: 60000]</p> <p>(C) SORDAT = [YYYYMMDD]</p> <p>(C) SORIND = (Refer to Section B, General Guidance)</p> <p><b>Object Encoding</b></p> <p><b>Object Class = BOYSPP(P)</b></p> <p>(O) BOYSHP = [1 (conical (nun, ogival)), 2 (can (cylindrical)), 3 (spherical), 4 (pillar), 5 (spar (spindle)), 6 (barrel (tun))]</p> <p>(O) OBJNAM = [name of ferry]</p> <p>(O) NOBJNM = (Refer to Section B, General Guidance)</p> <p>(M) CATSPM = [37 (ferry crossing mark)]</p> <p>(O) COLOUR = [1 (white), 2 (black), 3 (red), 4 (green), 5 (blue), 6 (yellow), 7 (grey), 8 (brown), 9 (amber), 10 (violet), 11 (orange), 12 (magenta), 13 (pink)]</p> <p>(O) CONRAD = [3 (radar conspicuous (has radar reflector))]</p> <p>(M) SCAMIN = [EU: 22000; US: 45000]</p> <p>(C) SORDAT = [YYYYMMDD]</p> <p>(C) SORIND = (Refer to Section B, General Guidance)</p> <p><b>Object Encoding</b></p> <p><b>Object Class = CBLARE(A)</b></p> <p>(M) CATCBL = [6 (mooring cable / chain) or</p>

		<p>"Unknown"]</p> <p>(O) OBJNAM = [Ferry name]</p> <p>(O) NOBJNM = (Refer to Section B, General Guidance)</p> <p>(M) SCAMIN = [EU: 22000; US: 60000]</p> <p>(C) SORDAT = [YYYYMMDD]</p> <p>(C) SORIND = (Refer to Section B, General Guidance)</p>
--	--	--



# L - Tracks, Routes

## L.3 Supplemental Navigation References

### L.3.1 CEMT Classification, ISRS Location Code (O)


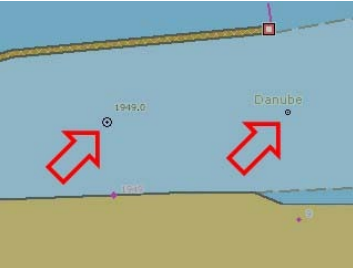
Classification of the waterway according to CEMT; local International Ship Reporting System code.

Graphics	Encoding Instructions	Object Encoding
	<p>A) 'dirimp', the orientation of the official distance numbering, is upstream if the official distance numbering increases towards the origin of a river and downstream if the numbering decreases towards the origin of a river. Otherwise, e.g., in case of a canal, downstream is in the direction of the general water flow or to be decided arbitrarily</p> <p>B) If the ISRS Location Code is available, it has to be encoded (refer to general guidance section H).</p>	<p><b>Object Encoding</b></p> <p><b>Object Class = wtware(A)</b></p> <p>(M) catccl = [1 (0 small vessels and pleasure craft), 2 (I peniche), 3 (II campine barge), 4 (III Dortmund-Ems barge), 5 (IV Rhine-Herne barge), 6 (Va Large Rhine barge; 1-barge push-tow unit), 7 (Vb 2-barge push-tow unit; long formation), 8 (VIa 2-barge push-tow unit; wide formation), 9 (VIb 4-barge push-tow unit), 10 (VIc 6-barge push-tow unit), 11 (No CEMT class), 12 (VII 9-barge push-town unit)]</p> <p>(M) dirimp = [1 (upstream), 2 (downstream), 3 (to the left bank), 4 (to the right bank)]</p> <p>(C) unlocd = [ISRS Location Code]</p> <p>(M) SCAMIN = [45000]</p> <p>(C) SORDAT = [YYYYMMDD]</p> <p>(C) SORIND = (Refer to Section B, General Guidance)</p>

## L.3 Supplemental Navigation References

### L.3.2 Distance Mark Along Waterway Axis (C)




A distance mark indicates the distance measured from an origin and consists of a distinct location without special installation, used to serve as a reference along the waterway. (Adapted from S-57 Standard).

Graphics	Encoding Instructions	Object Encoding
<p><i>Real World</i></p>  <p><i>IENC Symbolization</i></p> 	<ul style="list-style-type: none"> <li>A) EU: Preferably the waterway axis shall be the middle line between the border lines of the navigable channel rather than the middle line between the riverbanks.</li> <li>B) Encode the referenced unit of measure using the 'hunits' attribute</li> <li>C) The point has to be a connected node.</li> <li>D) If the ISRS Location Code is available it has to be encoded (refer to General Guidance section H).</li> <li>E) Negative values of wtwdis are allowed.</li> <li>F) EU: Distance Marks along the Waterway Axis must be encoded.</li> </ul>	<p><b>Object Encoding</b></p> <p><b>Object Class =</b> disarm(P)</p> <p>(M) CATDIS = [1 (distance mark not physically installed)]</p> <p>(M) wtwdis = [xxxx.x (value of unit according to hunit)]</p> <p>(C) unlocd = [ISRS Location Code]</p> <p>(M) hunits = [3 (kilometres), 4 (hectometres), 5 (statute miles), 6 (nautical miles)]</p> <p>(M) SCAMIN = [EU: 8000; US: 120000]</p> <p>(C) SORDAT = [YYYYMMDD]</p> <p>(C) SORIND = (Refer to Section B, General Guidance)</p>

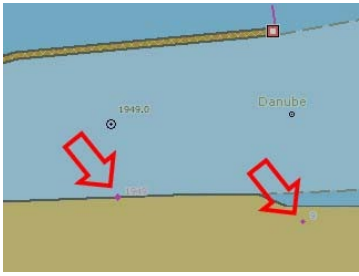
## L.3 Supplemental Navigation References

### L.3.3 Distance Mark Ashore (O)

A distance mark indicates the distance measured from an origin and consists of a distinct location without special installation, used to serve as a reference along the waterway. (Adapted from S-57 Standard). Due to natural or historic changes in the waterway, the distance can deviate from real distance to the origin.

Graphics	Encoding Instructions	Object Encoding
<p><i>Real World</i></p> 	<p>A) Distance marks ashore may be either stones or signs, from the encoding point of view this is no difference.</p> <p>B) EU: For hectometre distance marks, use 'hunits' = 4 (hectometres) For kilometre distance marks, use 'hunits' = 3 (kilometres), e.g., 1147 for km or 4 for hm</p> <p>C) Negative values of wtwdis are allowed.</p>	<p><b>Object Encoding</b></p> <p><b>Object Class</b> = disarm(P)</p> <p>(M) CATDIS = [1 (distance mark not physically installed), 2 (visible mark, pole), 3 (visible mark, board), 4 (visible mark, unknown shape)]</p> <p>(M) hunits = [3 (kilometres), 4 (hectometres), 5 (statute miles), 6 (nautical miles)]</p> <p>(M) wtwdis = [xxxx.x (value of unit according to hunit)]</p> <p>(M) SCAMIN = [22000 (except: 8000 for hunits=4)]</p> <p>(C) SORDAT = [YYYYMMDD]</p> <p>(C) SORIND = (Refer to Section B, General Guidance)</p>
<p><i>Real World</i></p> 		
<p><i>Real World</i></p> 		

*IENC Symbolization*

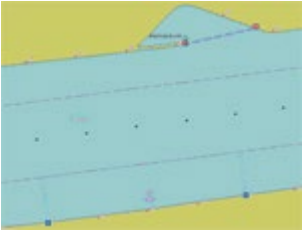


# M - Areas, Limits

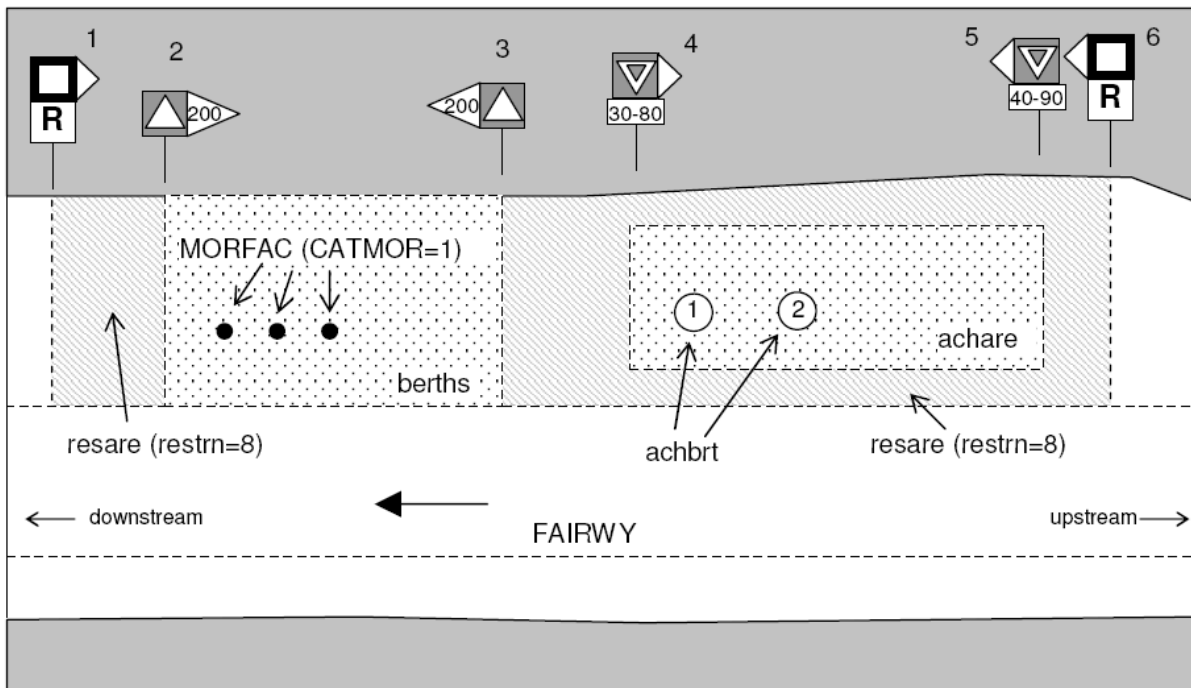
## M.1 Anchorage Areas and Berths

### M.1.1 Anchorage Area (C)

An area in which vessels anchor or may anchor. (IHO Dictionary, S-32, 5th Edition, 130)

Graphics	Encoding Instructions	Object Encoding
<p><i>IENC Symbolization</i></p> 	<p>A) For anchorage berth see M.1.2 For berth without transshipment see M.1.3</p> <p>B) For individual recommended anchorages without defined limits, the associated spatial object is a point with 'catach' = 1 and STATUS = 3.</p> <p>C) Where an anchorage may only be used for a limited period the duration should be indicated in INFORM. If there is a time schedule referring to special dates or times, use time schedule (general) object 'tisdge' (see T.1.1).</p> <p>D) To encode an anchorage, objects such as 'achare', 'achbrt', MORFAC, resare and navigational aids like 'notmrk' may be associated using a collection object C_ASSO.</p> <p>E) EU: The linear extent of 'achare' object is defined by markers or notice marks (CEVNI signs E.5 – E.5.15 or E.6) on the bank.</p> <p>F) If the name of the anchorage is important for navigation and should be displayed without the use of the pick report, use SEAARE object additional.</p> <p>G) If a structured external XML-file with more detailed communication information is available, the reference to the file has to be entered in the TXTDSC attribute.</p> <p>H) The class of dangerous goods in accordance with ADN and CEVNI: 1 (one blue light/cone, CEVNI signs E.5.5, E.5.9, E.5.13), 2 (two blue lights/cones, CEVNI signs E.5.6, E.5.10, E.5.14), 3 (three blue lights/cones, CEVNI signs E.5.7, E.5.11, E.5.15), 4 (no blue lights/cones, CEVNI signs E.5.4, E.5.8, E.5.12). Dangerous goods in accordance with inland waterway regulations of the Russian Federation: 5 (one red light/cone)</p>	<p><b>Object Encoding</b></p> <p><b>Object Class = achare(P,A)</b></p> <p>(O) catach = [1 (unrestricted anchorage), 2 (deep water anchorage), 3 (tanker anchorage), 4 (explosives anchorage), 5 (quarantine anchorage), 6 (sea-plane anchorage), 7 (small craft anchorage), 9 (anchorage for periods up to 24 hours), 10 (anchorage for pushing-navigation vessels), 11 (anchorage for other vessels than pushing-navigation vessels), 12 (anchorage for dry cargo vessels), 13 (anchorage for rafts)]</p> <p>(O) clsdng = [1 (one blue light / cone), 2 (two blue lights / cones), 3 (three blue lights / cones), 4 (no blue light / cone), 5 (one red light / red cone top down)]</p> <p>(O) TXTDSC = (Refer to letter G)</p> <p>(O) OBJNAM = [name or number designation to the anchorage area]</p> <p>(O) NOBJNM = (Refer to Section B, General Guidance)</p> <p>(O) restrn = [2 (anchoring restricted), 8 (entry restricted), 13 (no wake), 27 (speed restricted), 32 (berthing restricted), 38 (use of spuds prohibited)]</p> <p>(O) NATSUR = [1 (mud), 2 (clay), 3 (silt), 4 (sand), 5 (stone), 6 (gravel), 7 (pebbles), 8 (cobbles), 9 (rock), 11 (lava), 14 (coral), 17 (shells), 18 (boulder)]</p> <p>(O) STATUS = [3 (recommended), 8 (private), 12 (illuminated), 14 (public), 16 (watched), 17 (un-watched)]</p> <p>(C) unlocd = [ISRS Location Code]</p> <p>(O) INFORM = [additional information, e.g., limited duration of use, restrictions of the number, the kind or size of vessels]</p> <p>(O) NINFOM = (Refer to Section B, General Guidance)</p> <p>(M) SCAMIN = [EU: 22000 for areas, 12000 for points; US: 45000]</p> <p>(C) SORDAT = [YYYYMMDD]</p> <p>(C) SORIND = (Refer to Section B, General Guidance)</p>

	<p>top down).</p> <p>I) If the ISRS Location Code is available, it has to be encoded (please refer to general guidance section H).</p> <p>J) EU: Anchorage areas must be encoded.</p> <p>K) EU: If the authority has extended the application of the prohibition of anchoring to the use of telescopic piles (spuds) in accordance with Article 7.03 of CEVNI rev. 5, restrn =38 (use of spuds prohibited) must be encoded.</p>	<p><b>Conditional (Refer to letter F)</b></p> <p><b>Object Class = SEAARE(A)</b></p> <p>(M) OBJNAM = [name or number designation of the anchorage area]</p> <p>(O) NOBJNM = (Refer to Section B, General Guidance)</p> <p>(M) SCAMIN = [45000 or use SCAMIN formula to calculate value]</p> <p>(C) SORDAT = [YYYYMMDD]</p> <p>(C) SORIND = (Refer to Section B, General Guidance)</p>
--	---	---




# M - Areas, Limits

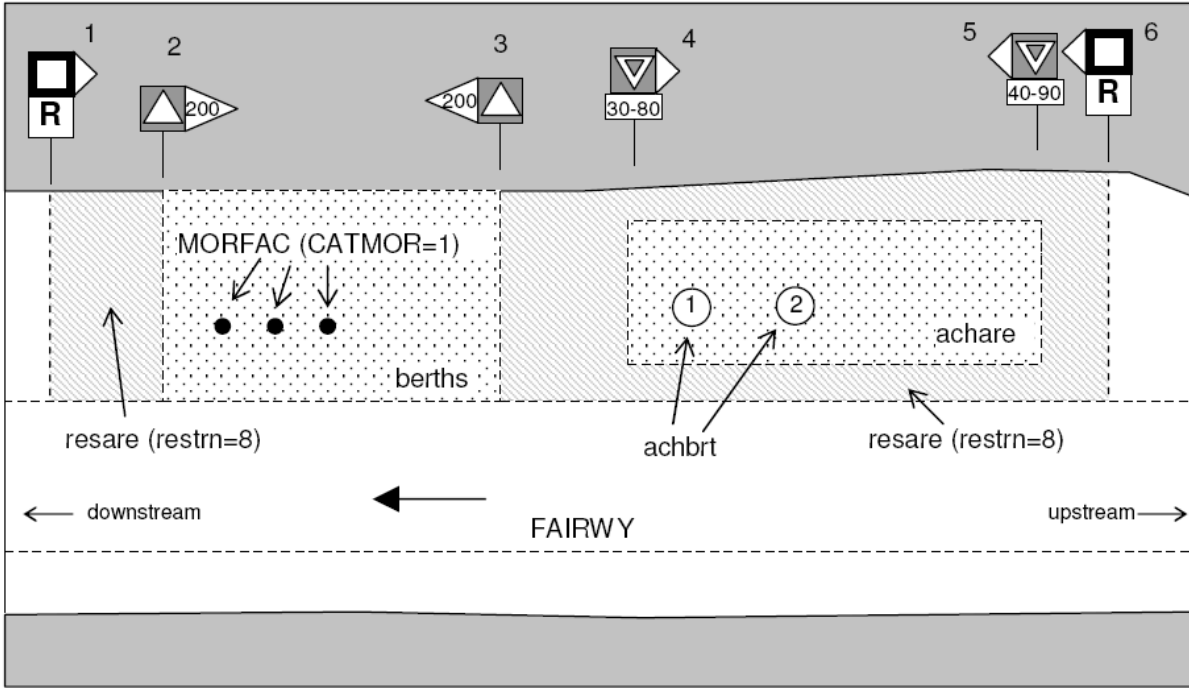
## M.1 Anchorage Areas and Berths

### M.1.2 Anchorage Berth (C)

A designated area of water where a single vessel, convoy, sea plane, etc. may anchor.

Graphics	Encoding Instructions	Object Encoding
<p><i>IENC Symbolization</i></p> 	<p>A) If the anchor berth is defined by the centre point and a swinging circle, the associated spatial object is a point.</p> <p>B) Where an anchor berth may only be used for a limited period the duration should be indicated in INFORM. If there is a time schedule referring to special dates or times, use time schedule (general) object 'tisdge' (see T.1.1).</p> <p>C) To encode an anchor berth, objects such as 'achare', 'achbrt', MORFAC, 'resare' and navigational aids like 'notmrk' may be associated using a collection object C_ASSO.</p> <p>D) If the width of 'achbrt' is not defined by notice marks, it should be 110' / 33,55 m (approximately three barge widths).</p> <p>E) If a structured external XML-file with more detailed communication information is available, the reference to the file has to be entered in the TXTDSC attribute.</p> <p>F) EU: The linear extent of 'achbrt' object is defined by markers or notice marks (CEVNI signs E.5 – E.5.15 or E.6) on the bank.</p> <p>G) The class of dangerous goods in accordance with ADN and CEVNI: 1 (one blue light/cone, CEVNI signs E.5.5, E.5.9, E.5.13), 2 (two blue lights/cones, CEVNI signs E.5.6, E.5.10, E.5.14), 3 (three blue lights/cones, CEVNI signs E.5.7, E.5.11, E.5.15), 4 (no blue lights/cones, CEVNI signs E.5.4, E.5.8, E.5.12). Dangerous goods in accordance with inland waterway regulations of the Russian Federation: 5 (one red light / cone top down).</p> <p>H) If the ISRS Location Code is available, it has to be encoded (refer to general guidance section H).</p>	<p><b>Object Encoding</b></p> <p><b>Object Class = achbrt(P,A)</b></p> <p>(O) catach = [1 (unrestricted anchorage), 2 (deep water anchorage), 3 (tanker anchorage), 4 (explosives anchorage), 5 (quarantine anchorage), 6 (sea-plane anchorage), 7 (small craft anchorage), 9 (anchorage for periods up to 24 hours), 10 (anchorage for pushing-navigation vessels), 11 (anchorage for other vessels than pushing-navigation vessels), 12 (anchorage for dry cargo vessels), 13 (anchorage for rafts)]</p> <p>(O) clsdng = [1 (one blue light / cone), 2 (two blue lights / cones), 3 (three blue lights / cones), 4 (no blue light / cone), 5 (one red light / red cone top down)]</p> <p>(O) TXTDSC = (Refer to letter E)</p> <p>(O) OBJNAM = [name or number designation of the anchorage area]</p> <p>(O) NOBJNM = (Refer to Section B, General Guidance)</p> <p>(O) restrn = [2 (anchoring restricted), 8 (entry restricted), 13 (no wake), 27 (speed restricted), 32 (berthing restricted), 38 (use of spuds prohibited)]</p> <p>(O) NATSUR = [1 (mud), 2 (clay), 3 (silt), 4 (sand), 5 (stone), 6 (gravel), 7 (pebbles), 8 (cobbles), 9 (rock), 11 (lava), 14 (coral), 17 (shells), 18 (boulder)]</p> <p>(O) STATUS = [3 (recommended), 8 (private), 12 (illuminated), 14 (public), 16 (watched), 17 (un-watched)]</p> <p>(C) unlocd = [ISRS Location Code]</p> <p>(O) INFORM = [additional information, e.g. limited duration of use, restrictions of the kind or the size of vessels]</p> <p>(O) NINFOM = (Refer to Section B, General Guidance)</p> <p>(M) SCAMIN = [EU: 22000 for areas, 12000 for points; US: 45000]</p> <p>(C) SORDAT = [YYYYMMDD]</p> <p>(C) SORIND = (Refer to Section B, General Guidance)</p>

	<p>I) EU: Anchorage berths must be encoded.</p> <p>J) EU: If the authority has extended the application of the prohibition of anchoring to the use of telescopic piles (spuds) in accordance with Article 7.03 of CEVNI rev. 5, restrn =38 (use of spuds prohibited) must be encoded.</p>	
--	---	--




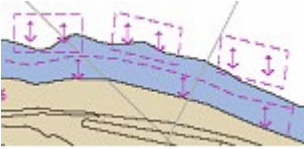



# M - Areas, Limits

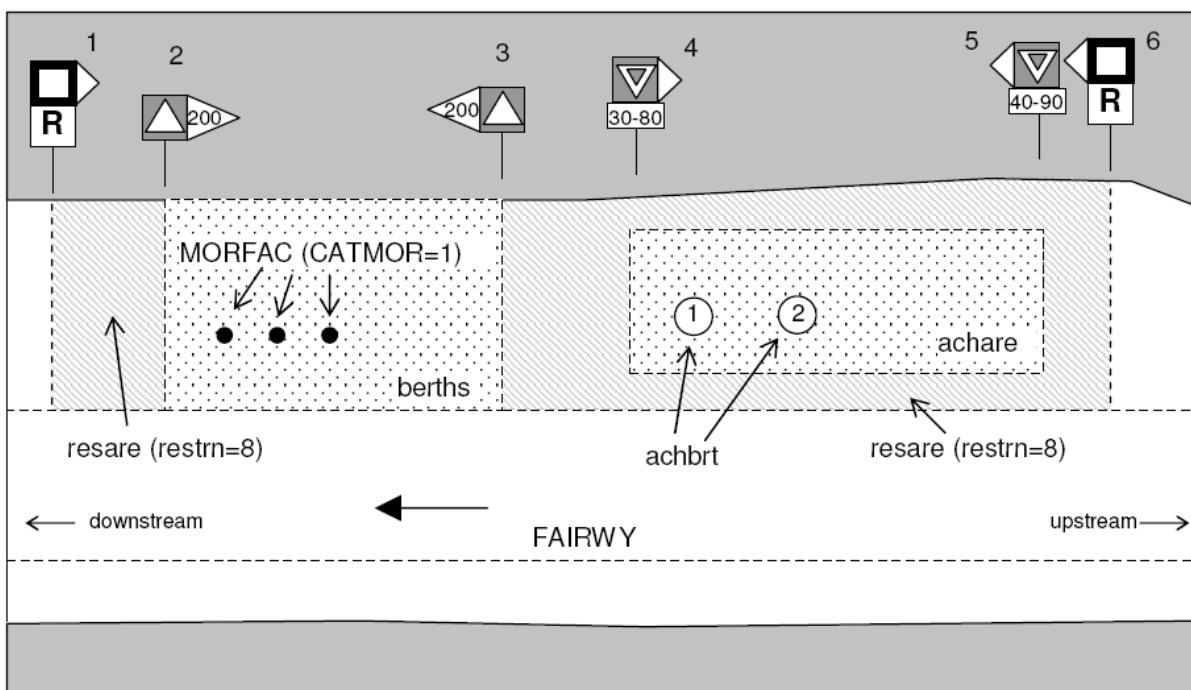
## M.1 Anchorage Areas and Berths

### M.1.3 Berth without Transshipment / Fleeting Areas (M)

A designated named or numbered place at the bank of the river or in a harbour basin for the mooring of vessels without transshipment of cargo.

Graphics	Encoding Instructions	Object Encoding
<p><i>Real World (Fleeting Area)</i></p>  <p><i>Chart Symbol (Fleeting Area)</i></p>  <p><i>IENC Symbolization</i></p> 	<p>A) For anchorage area see M.1.1 For anchorage berth see M.1.2</p> <p>B) US: - First Class Landing: An area providing tie-ups and at least 9 feet of water depth during low water level</p> <p>- Second Class Landing: An area providing tie-ups and at least 9 feet of water depth during normal pool level</p> <p>Mandatory attributes:</p> <p>'catbrt' = 7 (first class landing) or 8 (second class landing)</p> <p>OBJNAM = "First Class Landing" or "Second Class Landing" in both 'berths' and SEAARE.</p> <p>C) US: Fleeting Areas: Area in waterway designated for temporary barge mooring. Mandatory attribute: 'catbrt' = 6 (fleeting area)</p> <p>D) Where a berth may only be used for a limited period the duration should be indicated in INFORM. If the berth has special operating hours, the berths object can be combined with a time schedule (general) 'tisdge' object (T.1.1)</p> <p>E) To encode a berth, objects such as 'berths', MORFAC, 'resare' and navigational aids like 'notmrk' may be associated using a collection object C_ASSO.</p> <p>F) The linear extent of berths object is defined by markers or notice marks (CEVNI signs E.5 – E.5.15, E.6, E.7 or E.7.1) on the bank.</p> <p>G) Within port areas it is allowed to encode berthes as line objects.</p> <p>H) Land facilities should be represented with buildings (BUIISGL) and storage tank (SILTANK) or harbor facility ('hrbfac') feature objects.</p> <p>I) The berth encodes the named place</p>	<p><b>Object Encoding</b></p> <p><b>Object Class = berths(P,L,A)</b></p> <p>(C) catbrt = [3 (overnight accommodation), 4 (berth for pushing-navigation vessels), 5 (berth for other vessels than pushing-navigation vessels), 6 (fleeting area), 7 (first class landing), 8 (second class landing)]</p> <p>(O) clsdng = [1 (one blue light / cone), 2 (two blue lights / cones), 3 (three blue lights / cones), 4 (no blue light / cone), 5 (one red light / red cone top down)]</p> <p>(O) TXTDSC = (Refer to letter L)</p> <p>(O) DRVAL1 = [The minimum (shoalest) value; unit defined in the cell header, e.g., metres]</p> <p>(C) QUASOU = (Refer to letter P)</p> <p>(C) SOUACC = (Refer to letter P)</p> <p>(C) verdat = (Refer to letter P)</p> <p>(O) OBJNAM = [name or number designation of the berth]</p> <p>(O) NOBJNM = (Refer to Section B, General Guidance)</p> <p>(O) STATUS = [3 (recommended), 8 (private), 12 (illuminated), 14 (public), 16 (watched), 17 (un-watched)]</p> <p>(C) unlocd = (Refer to letter O)</p> <p>(O) INFORM = [additional information, e.g., limited duration of use, restrictions of the number, the kind or the size of vessels]</p> <p>(O) NINFOM = (Refer to Section B, General Guidance)</p> <p>(M) SCAMIN = [EU: 22000 for areas, 12000 for points; US: 45000]</p> <p>(C) SORDAT = [YYYYMMDD]</p> <p>(C) SORIND = (Refer to Section B, General Guidance)</p> <p><b>Object Encoding</b></p> <p><b>Object Class = SLCONS(L,A)</b></p> <p>(M) CATSLC = [4 (pier (jetty)), 5 (promenade pier), 6 (wharf (quay)), 15 (solid face wharf),</p>

	<p>at a wharf. The wharf itself is encoded as a shoreline construction</p> <p>J) For SLCON Multiple NATCON values can be used, if applicable.</p> <p>K) Use CATSLC as follows:</p> <ul style="list-style-type: none"> <li>•4, Pier: facility is primarily a structure generally extending perpendicular from shoreline into water.</li> <li>•6, Wharf: facility is primarily a structure parallel to shoreline; use if details of 15 or 16 no known.</li> <li>•15, Solid face wharf: Facility consisting of a solid wall such that water can not circulate underneath.</li> <li>•16, Open face wharf: Facility supported on piles or other structures that allow free circulation of water under the wharf.</li> </ul> <p>L) If a structured external XML-file with more detailed communication information is available, the reference to the file has to be entered in the TXTDSC attribute.</p> <p>M) If the width of achare is not defined by notice marks, consider using 110/33.55m (approximately three barge widths).</p> <p>O) EU: 'unlocd' mandatory</p> <p>P) If the DRVAL1 attribute is used, QUASOU, SOUACC and verdat should also be provided.</p>	<p>16 (open face wharf)]</p> <p>(O) NATCON = [1 (masonry), 2 (concreted), 3 (loose boulders), 4 (hard surfaced), 5 (unsurfaced), 6 (wooden), 7 (metal), 8 (glass reinforced plastic (GRP))]</p> <p>(M) WATLEV = [1 (partly submerged at high water), 2 (always dry)]</p> <p>(M) SCAMIN = [45000 for line objects and 22000 for area objects]</p> <p>(C) SORDAT = [YYYYMMDD]</p> <p>(C) SORIND = (Refer to Section B, General Guidance)</p>
--	--	--



# M - Areas, Limits

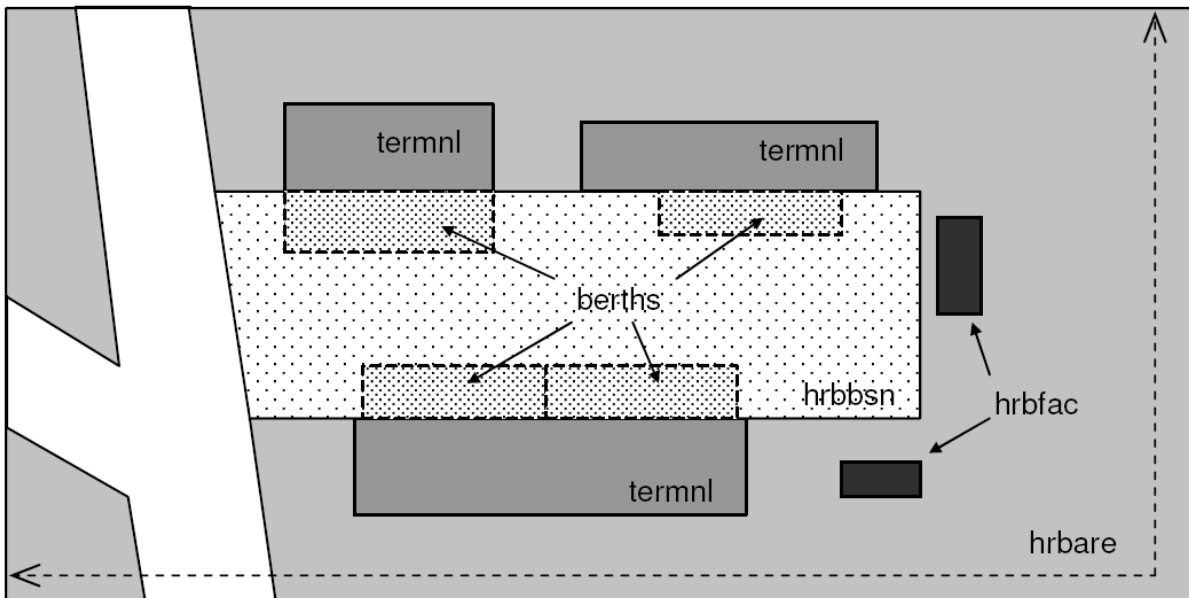
## M.1 Anchorage Areas and Berths

### M.1.4 Transshipment Berth (M)

A designated named or numbered place at the bank of the river or in a harbour basin for the mooring of vessels and transshipment

Graphics	Encoding Instructions	Object Encoding
<p><i>Real World</i></p>  <p><i>IENC Symbolization</i></p> 	<p>A) For berths without transshipment see M.1.3</p> <p>B) Where a berth may only be used for a limited period the duration should be indicated in INFORM. If there is a time schedule referring to special dates or times, use time schedule (general) object 'tisdge' (see T.1.1).</p> <p>C) To encode a berth, objects such as 'berths', MORFAC, 'resare' and navigational aids like 'notmrk' may be associated using a collection object C_ASSO.</p> <p>D) The linear extent of berths object is defined by markers or notice marks (CEVNI signs E.5 – E.5.15, E.6, E.7 or E.7.1) on the bank.</p> <p>E) If the width of a berth is not defined by notice marks, consider using 110' / 33,55 m (approximately three barge widths).</p> <p>F) Within port areas it is allowed to encode berths as line objects.</p> <p>G) Land facilities should be represented with buildings (BUISGL) and storage tank (SILTnk) or harbor facility (hrbfac) feature objects.</p> <p>H) The berth encodes the named place at a wharf. The wharf itself is encoded as a shoreline construction</p> <p>I) For SLCON Multiple NATCON values can be used, if applicable.</p> <p>J) Use CATSLC as follows:</p> <ul style="list-style-type: none"> <li>• 4, Pier: facility is primarily a structure generally extending perpendicular from shoreline into water.</li> <li>• 6, Wharf: facility is primarily a structure parallel to shoreline; use if details of 15 or 16 no known.</li> <li>• 15, Solid face wharf: Facility consisting of a solid wall such that water can not circulate underneath.</li> </ul>	<p><b>Object Encoding</b></p> <p><b>Object Class = berths(P,L,A)</b></p> <p>(O) catbrt = [1 (loading), 2 (unloading), 4 (berth for pushing-navigation vessels), 5 (berth for other vessels than pushing-navigation vessels), 9 (berth for passenger vessels)]</p> <p>(O) clsdng = [1 (one blue light / cone), 2 (two blue lights / cones), 3 (three blue lights / cones), 4 (no blue light / cone), 5 (one red light / red cone top down)]</p> <p>(O) TXTDSC = (Refer to letter K)</p> <p>(O) DRVAL1 = [The minimum (shoalest) value; unit defined in the cell header, e.g., metres]</p> <p>(C) QUASOU = (Refer to letter N)</p> <p>(C) SOUACC = (Refer to letter N)</p> <p>(C) verdat = (Refer to letter N)</p> <p>(O) OBJNAM = [name or number designation of the berth]</p> <p>(O) NOBJNM = (Refer to Section B, General Guidance)</p> <p>(O) STATUS = [3 (recommended), 8 (private), 12 (illuminated), 14 (public), 16 (watched), 17 (un-watched)]</p> <p>(O) trshgd = [1 (containers), 2 (bulk goods), 3 (oil), 4 (fuel), 5 (chemicals), 6 (liquid goods), 7 (explosive goods), 8 (fish), 9 (cars), 10 (general cargo)]</p> <p>(C) unlocd = [ISRS Location Code]</p> <p>(O) INFORM = [additional information, e.g., limited duration of use, restrictions of the number, the kind or the size of vessels]</p> <p>(O) NINFOM = (Refer to Section B, General Guidance)</p> <p>(M) SCAMIN = [EU: 22000 for areas, 12000 for points; US: 45000]</p> <p>(C) SORDAT = [YYYYMMDD]</p> <p>(C) SORIND = (Refer to Section B, General Guidance)</p> <p><b>Object Encoding</b></p>

	<ul style="list-style-type: none"> <li>• 16, Open face wharf: Facility supported on piles or other structures that allow free circulation of water under the wharf.</li> </ul> <p>K) If a structured external XML-file with more detailed communication information is available, the reference to the file has to be entered in the TXTDSC attribute.</p> <p>L) If the ISRS Location Code is available, it has to be encoded (refer to General Guidance section H).</p> <p>M) The class of dangerous goods in accordance with ADN and CEVNI: 1 (one blue light / cone, CEVNI signs E.5.5, E.5.9, E.5.13), 2 (two blue lights / cones, CEVNI signs E.5.6, E.5.10, E.5.14), 3 (three blue lights / cones, CEVNI signs E.5.7, E.5.11, E.5.15), 4 (no blue lights / cones, CEVNI signs E.5.4, E.5.8, E.5.12). Dangerous goods in accordance with inland waterway regulations of the Russian Federation: 5 (one red light/cone top down).</p> <p>N) If the DRVAL1 attribute is used, QUASOU, SOUACC and verdat should also be provided</p>	<p><b>Object Class = SLCONS(L,A)</b></p> <p>(M) CATSLC = [4 (pier (jetty)), 5 (promenade pier), 6 (wharf (quay)), 15 (solid face wharf), 16 (open face wharf)]</p> <p>(O) NATCON = [1 (masonry), 2 (concreted), 3 (loose boulders), 4 (hard surfaced), 5 (unsurfaced), 6 (wooden), 7 (metal), 8 (glass reinforced plastic (GRP))]</p> <p>(M) WATLEV = [1 (partly submerged at high water), 2 (always dry)]</p> <p>(M) SCAMIN = [45000 (A), 22000 (L) or use SCAMIN formula to calculate value]</p> <p>(C) SORDAT = [YYYYMMDD]</p> <p>(C) SORIND = (Refer to Section B, General Guidance)</p>
--	--	--

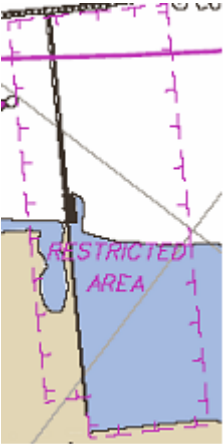
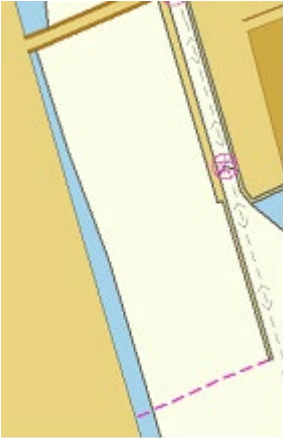


# M - Areas, Limits

## M.2 Restricted Areas

### M.2.1 Restricted Area (C)

Area designated by the competent authority in which entry is prohibited or restricted to certain vessels, or certain transit rules apply. Restricted areas typically surround dams; see G.4.2 Dams.


Graphics	Encoding Instructions	Object Encoding
<p><i>Chart Symbol</i></p>  <p><i>IENC Symbolization</i></p> 	<p>A) Outline restricted area. The shoreline can be part of it, but may not be overlapped.</p> <p>B) EU: Restricted areas that are or could be defined by the CEVNI signs A.1 to A.9, B.6, C.1, C.3, C.5 (see annex "notice_marks.xls) shall be encoded.</p> <p>C) EU: To encode a restricted area that is defined by notice marks, the object 'resare' and the objects 'notmrk' may be associated using a collection object C_ASSO.</p> <p>D) If a restriction is more complicated see U.1 (legal ECDIS)</p> <p>E) The object class should not be used for restrictions that apply to whole waterways or large sections of waterways. For instance, If one restricted area covers a waterway, smaller restricted areas with more important information for the safety of navigation may not be noticed by the user. Especially restricted fairway depth and restricted fairway width should only be used for small areas of up to 1 km.</p> <p>F) EU: CATREA = 26 (waterskiing area) may only be used, if navigation is not allowed in the area. Water skiing areas marked by CEVNI signs E.17, where navigation is allowed, should be encoded as CTNARE, like areas for water bikes or sail boards.</p> <p>G) For areas of limited width or limited depth see M.4.3 and M.4.4.</p> <p>H) EU: If the authority has extended the application of the prohibition of anchoring to the use of telescopic piles (spuds) in accordance with Article 7.03 of CEVNI rev. 5, restrn =38 (use of spuds prohibited) must be encoded.</p>	<p><b>Object Encoding</b></p> <p><b>Object Class = resare(A)</b></p> <p>(M) restrn = [1 (anchoring prohibited), 2 (anchoring restricted), 7 (entry prohibited), 8 (entry restricted), 13 (no wake), 14 (area to be avoided), 27 (speed restricted), 28 (overtaking prohibited), 29 (overtaking of convoys by convoys prohibited), 30 (passing or overtaking prohibited), 31 (berthing prohibited), 32 (berthing restricted), 33 (making fast prohibited), 34 (making fast restricted), 35 (turning prohibited), 36 (restricted fairway depth), 37 (restricted fairway width), 38 (use of spuds prohibited)]</p> <p>(O) CATREA = [4 (nature reserve), 5 (bird sanctuary), 9 (military area), 12 (navigational aid safety zone), 19 (waiting area), 22 (fish sanctuary), 23 (ecological reserve), 25 (swinging area)]</p> <p>(O) NATSUR = [1 (mud), 2 (clay), 3 (silt), 4 (sand), 5 (stone), 6 (gravel), 7 (pebbles), 8 (cobbles), 9 (rock), 11 (lava), 14 (coral), 17 (shells), 18 (boulder)]</p> <p>(C) INFORM = [if restrn = 2, 8, 32, 34: brief description of restriction; if over 10 words, use TXTDSC; if restrn = 27: maximum speed limit with unit]</p> <p>(O) NINFOM = (Refer to Section B, General Guidance)</p> <p>(M) SCAMIN = [EU: 22000; US: 75000]</p> <p>(C) SORDAT = [YYYYMMDD]</p> <p>(C) SORIND = (Refer to Section B, General Guidance)</p>

## M - Areas, Limits

### M.3 Caution Areas

#### M.3.1 Caution Area (C)

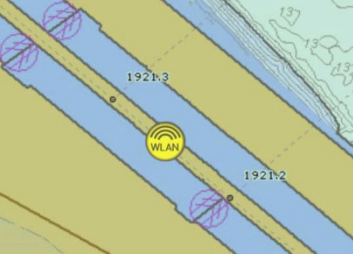
Generally, an area where the skipper has to be made aware of circumstances influencing the safety of navigation.

Graphics	Encoding Instructions	Object Encoding
<p><i>IENC Symbolization</i></p> 	<p>A) To be used on a limited basis only for short sections and in case of real importance for safety of navigation.</p> <p>B) Areas signposted by notice marks (areas for water scooters, high speed motorboats and slipping of boats) the object CTNARE shall also be used. Refer to the list of notice marks in the annex.</p> <p>C) Names of the sections shall be those, that are generally known by the skippers. In case no specific name is known the name of the closest town or land region should be used.</p> <p>D) EU: To encode a caution area, which is defined by notice marks, the object CTNARE and the objects 'notmrk' may be associated using a collection object C_ASSO.</p>	<p><b>Object Encoding</b></p> <p><b>Object Class = CTNARE(P,A)</b></p> <p>(O) OBJNAM = [name of section or closest town]</p> <p>(O) NOBJNM = (Refer to Section B, General Guidance)</p> <p>(M) INFORM = [short description of the impact on the skipper in English language]</p> <p>(O) NINFOM = (Refer to Section B, General Guidance)</p> <p>(M) SCAMIN = [EU: 22000; US: 60000]</p> <p>(C) SORDAT = [YYYYMMDD]</p> <p>(C) SORIND = (Refer to Section B, General Guidance)</p>

## M.4 Miscellaneous Areas / Limits

### M.4.1 Communication Area (C)

An area, in which a vessel has to report or may request information

Graphics	Encoding Instructions	Object Encoding
<p><i>IENC Symbolization (No IENC symbolization (only in pick report))</i></p> 	<ul style="list-style-type: none"> <li>A) EU: A communication area can be defined by notice marks (CEVNI signs B.11 or E.23, see O.3.1) or by regulations. Communication areas at locks should include the waiting areas and advance signals. The communication area at bridges should cover about 1 to 1,5 km on both sides of the bridge, depending on the normal radar range.</li> <li>B) Use 'comare' object class.</li> <li>C) If there is a reporting duty at a specific point/line use 'rdocal' object class. (Refer to Q.2.1)</li> <li>D) The purpose of communication area should be given in the 'catcom' attribute.</li> <li>E) The channel number assigned to a specific radio frequency, frequencies or frequency band has to be indicated in the COMCHA attribute.</li> <li>F) EU: The STATUS attribute should be used to indicate whether communication is recommended (CEVNI sign E.23) or mandatory (CEVNI sign B.11).</li> <li>G) Detailed communication information (postal address, phone, fax, e-mail etc.) should also be encoded in the respective object class.</li> <li>H) To encode a communication area, objects such as locks (lokbsn), bridges (bridge), customs (BUISGL, chkpnt), harbours (hrbare, prtare, hrbbsn), berths (berths) and notice marks (notmrk), may be associated using a collection object C_ASSO.</li> <li>I) If a structured external XML-file with more detailed communication information is available, the reference to the file has to be entered in TXTDSC. If some other means of communication is used for time-critical navigation-related communication, this should be mentioned in the remarks of the</li> </ul>	<p><b>Object Encoding</b></p> <p><b>Object Class = comare(A)</b></p> <p>(O) catcom = [1 (VTS centre), 2 (VTS sector), 3 (IVS point), 4 (MIB), 5 (lock), 6 (bridge), 7 (custom), 8 (harbour), 9 (WLAN area)]</p> <p>(M) COMCHA = [[XXXX];[XXXX];...]</p> <p>(O) OBJNAM = [name of the communication area], e.g. "lock xy"</p> <p>(O) NOBJNM = (Refer to Section B, General Guidance)</p> <p>(O) STATUS = [3 (recommended), 8 (private), 9 (mandatory), 14 (public)]</p> <p>(O) TXTDSC = (Refer to letter I)</p> <p>(M) SCAMIN = [EU: 45000; US: 60000]</p> <p>(C) SORDAT = [YYYYMMDD]</p> <p>(C) SORIND = (Refer to Section B, General Guidance)</p>

	<p>XML-file.</p> <p>J) Communication Areas must be encoded.</p> <p>K) For areas where Wireless Networks are available free of charge catcom 9 = WLAN area should be used. COMCHA shall be coded as unknown. The network name (SSID = Service Set Identifier) shall be coded within OBJNAM, whereas INFORM can be used to provide additional information as intended coverage, encryption, available services, etc.</p>	
--	--	--

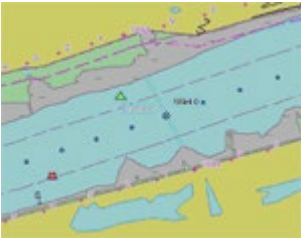


# M - Areas, Limits

## M.4 Miscellaneous Areas / Limits

### M.4.2 River Surveillance Area (O)

A defined and named administrative area of a river surveillance

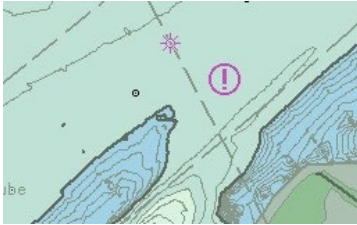
Graphics	Encoding Instructions	Object Encoding
<p><i>IENC Symbolization</i></p> 	<p>A) Use ADMARE object class, if the information about the competent river surveillance is important for navigation.</p> <p>B) If a structured external XML-file with detailed communication information is available, the reference to the file has to be entered here.</p>	<p><b><u>Object Encoding</u></b></p> <p><b>Object Class = ADMARE(A)</b></p> <p>(M) JRSDTN = [1 (international), 2 (national), 3 (national sub-division)]</p> <p>(M) NATION = (Nationality is encoded by a 2 character-code following ISO 3166 (refer to Annex A to S-57 Appendix A))</p> <p>(M) OBJNAM = [name of the river surveillance]</p> <p>(O) NOBJNM = (Refer to Section B, General Guidance)</p> <p>(O) INFORM = [communication information]</p> <p>(O) NINFOM = (Refer to Section B, General Guidance)</p> <p>(O) TXTDSC = (Refer to letter B)</p> <p>(M) SCAMIN = [90000]</p> <p>(C) SORDAT = [YYYYMMDD]</p> <p>(C) SORIND = (Refer to Section B, General Guidance)</p>

# M - Areas, Limits

## M.4 Miscellaneous Areas / Limits

### M.4.3 Section of Limited Depth (O)

Generally, a short section of a waterway with limited depth and well known to skippers as of high relevance for safety, also by shipping companies as the reference for the planning of the draught of vessels.

Graphics	Encoding Instructions	Object Encoding
<p><i>IENC Symbolization</i></p> 	<p>A) To be used on a limited basis only for short sections.</p> <p>B) Names of the sections shall be those, which are generally known by the skippers. In case no specific name is known the name of the closest town or land region should be used.</p> <p>C) EU: To encode a limited depth area, that is defined by notice marks, the object 'resare' and the object 'notmrk' may be associated using a collection object C_ASSO.</p> <p>D) If it is not sure that the bottom of the river is stable, INFORM shall equal, "water depth may change rapidly".</p>	<p><b><u>Object Encoding</u></b></p> <p><b>Object Class = resare(A)</b></p> <p>(M) restrn = [36 (restricted fairway depth)]</p> <p>(O) OBJNAM = ["Shallow water area" + name of section or closest town]</p> <p>(O) NOBJNM = (Refer to Section B, General Guidance)</p> <p>(O) NATSUR = [1 (mud), 2 (clay), 3 (silt), 4 (sand), 5 (stone), 6 (gravel), 7 (pebbles), 8 (cobbles), 9 (rock), 11 (lava), 14 (coral), 17 (shells), 18 (boulder)]</p> <p>(C) INFORM = (Refer to letter D)</p> <p>(O) NINFOM = (Refer to Section B, General Guidance)</p> <p>(M) SCAMIN = [EU: 22000; US: 75000]</p> <p>(C) SORDAT = [YYYYMMDD]</p> <p>(C) SORIND = (Refer to Section B, General Guidance)</p>

## M - Areas, Limits

### M.4 Miscellaneous Areas / Limits

#### M.4.4 Section of Limited Width (O)

Generally, a short section of a waterway with limited width and well known to skippers.


Graphics	Encoding Instructions	Object Encoding
	<p>A) To be used on a limited basis only for short sections.</p> <p>B) Names of the sections shall be those, which are generally known by the skippers. In case no specific name is known the name of the closest town or land region should be used.</p> <p>C) EU: To encode a limited width area, which is defined by notice marks, the object 'resare' and the object 'notmrk' may be associated using a collection object C_ASSO.</p>	<p><b>Object Encoding</b></p> <p><b>Object Class</b> = resare(A)</p> <p>(M) restrn = [37 (restricted fairway width)]</p> <p>(O) OBJNAM = ["Constricted section" + name of section or closest town]</p> <p>(O) NOBJNM = (Refer to Section B, General Guidance)</p> <p>(O) NATSUR = [1 (mud), 2 (clay), 3 (silt), 4 (sand), 5 (stone), 6 (gravel), 7 (pebbles), 8 (cobble), 9 (rock), 11 (lava), 14 (coral), 17 (shells), 18 (boulder)]</p> <p>(M) INFORM = [Section of high navigational importance due to limited width of fairway]</p> <p>(O) NINFOM = (Refer to Section B, General Guidance)</p> <p>(M) SCAMIN = [EU: 22000; US: 75000]</p> <p>(C) SORDAT = [YYYYMMDD]</p> <p>(C) SORIND = (Refer to Section B, General Guidance)</p>

# M - Areas, Limits

## M.4 Miscellaneous Areas / Limits

### M.4.5 Turning Basin (C)

An area of water or enlargement of a channel used for turning vessels. Indicated by CEVNI sign E.8


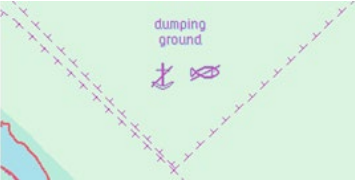
Graphics	Encoding Instructions	Object Encoding
<p><i>IENC Symbolization</i></p>  <p>The image shows a map segment with a turning basin. The basin is a light blue area bounded by a dashed line. A pink circle with a 'G' inside is located within the basin. The surrounding area is light green and yellow. The word 'Dredge' is visible at the bottom right of the map.</p>	<ul style="list-style-type: none"> <li>A) Use 'trnbsn' object class</li> <li>B) To encode a turning basin, which is defined by notice marks, the object 'trnbsn' and the object 'notmrk' may be associated using a collection object C_ASSO.</li> <li>C) If the ISRS Location Code is available it has to be encoded (refer to General Guidance section H).</li> <li>D) EU: Turning Basins must be encoded.</li> </ul>	<p><b>Object Encoding</b></p> <p><b>Object Class</b> = trnbsn(P,A)</p> <p>(O) HORCLR = [The width of the basin, which is available for safe navigation. This may, or may not, be the same as the total physical width of the basin.]</p> <p>(O) OBJNAM = [name of the tuning basin]</p> <p>(O) NOBJNM = (Refer to Section B, General Guidance)</p> <p>(C) unlocd = [ISRS Location Code]</p> <p>(M) SCAMIN = [EU: 22000; US: 75000]</p> <p>(C) SORDAT = [YYYYMMDD]</p> <p>(C) SORIND = (Refer to Section B, General Guidance)</p>

# M - Areas, Limits

## M.4 Miscellaneous Areas / Limits

### M.4.6 Dumping Ground (C)

An area where dredged material or other potentially more harmful material, e.g. explosives, chemical waste, is deliberately deposited. (Derived from IHO Chart Specifications, M-4)



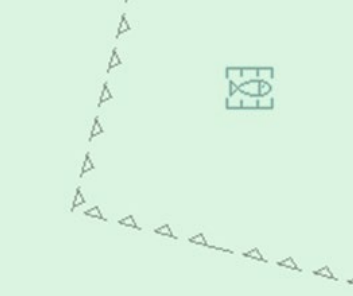
Graphics	Encoding Instructions	Object Encoding
<p><i>Chart Symbol</i></p>  <p><i>IENC Symbolization</i></p> 	<p>A) Use RESTRN if any of the conditions apply.</p> <p>B) Dumping grounds in navigable waters shall be encoded if any one of the listed restrictions applies.</p>	<p><b><u>Object Encoding</u></b></p> <p><b>Object Class = DMPGRD(A)</b></p> <p>(M) CATDPG = [2 (chemical waste dumping ground), 4 (explosives dumping ground), 5 (spoil ground)]</p> <p>(O) OBJNAM = [Name]</p> <p>(O) NOBJNM = (Refer to Section B, General Guidance)</p> <p>(C) RESTRN = [1 (anchoring prohibited), 3 (fishing prohibited), 5 (trawling prohibited), 7 (entry prohibited), 8 (entry restricted), 24 (dragging prohibited)]</p> <p>(M) SCAMIN = [EU: 260000]</p> <p>(C) SORDAT = [YYYYMMDD]</p> <p>(C) SORIND = (Refer to Section B, General Guidance)</p>

# M - Areas, Limits

## M.4 Miscellaneous Areas / Limits

### M.4.7 Marine Farm/Culture (C)



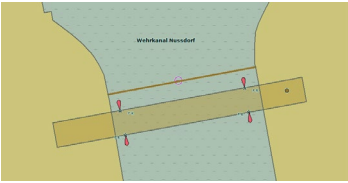
An assemblage of cages, nets, rafts and floats or posts where fish, including shellfish, are artificially cultivated. Also called fish farm. (IHO Dictionary, S-32, 5th Edition, 1811)

Graphics	Encoding Instructions	Object Encoding
<p><i>Real World</i></p>  <p><i>Chart Symbol</i></p>  <p><i>IENC Symbolization</i></p> 	<p>A) EXPSOU, VALSOU and WATLEV must be encoded for all MARCUL objects if they are under water.</p> <p>B) If VALSOU is provided SOUACC and verdat should also be provided.</p> <p>C) Use STATUS if any of the conditions apply.</p> <p>D) Marine Farms/Cultures in navigable waters shall be encoded.</p>	<p><b>Object Encoding</b></p> <p><b>Object Class = MARCUL(P,L,A)</b></p> <p>(M) CATMFA = [1 (crustaceans), 2 (oysters/mussels), 3 (fish), 4 (seaweed)]</p> <p>(O) DATSTA = (Refer to Section J, DATSTA, DATEND, PERSTA and PEREND)</p> <p>(O) DATEND = (Refer to Section J, DATSTA, DATEND, PERSTA and PEREND)</p> <p>(O) PERSTA = (Refer to Section J, DATSTA, DATEND, PERSTA and PEREND)</p> <p>(O) PEREND = (Refer to Section J, DATSTA, DATEND, PERSTA and PEREND)</p> <p>(C) EXPSOU = [1 (within the range of depth of the surrounding depth area), 2 (shoaler than the range of depth of the surrounding depth area), 3 (deeper than the range of depth of the surrounding depth area)]</p> <p>(C) VALSOU = [sxxxxx.xx] (s: sign, negative values only)</p> <p>(O) QUASOU = [1 (depth known), 2 (depth unknown), 3 (doubtful sounding), 4 (unreliable sounding), 6 (least depth known), 7 (least depth unknown, safe clearance at depth shown), 8 (value reported (not surveyed)), 9 (value reported (not confirmed))]</p> <p>(C) SOUACC = [xx.x]</p> <p>(C) STATUS = [2 (occasional), 4 (not in use)]</p> <p>(C) WATLEV = [1 (partly submerged at high water), 2 (always dry), 3 (always under water/submerged), 4 (covers and uncovers), 5 (awash), 7 (floating)]</p> <p>(O) OBJNAM = [Name]</p> <p>(O) NOBJNM = (Refer to Section B, General Guidance)</p> <p>(M) SCAMIN = [260000]</p> <p>(C) SORDAT = [YYYYMMDD]</p> <p>(C) SORIND = (Refer to Section B, General Guidance)</p>

## N.1 Light Structures

### N.1.1 Bridge Light (C)

A navigation light positioned on a bridge span or support pier.

Graphics	Encoding Instructions	Object Encoding
<p><i>Real World</i></p>  <p><i>Chart Symbol</i></p>  <p><i>IENC Symbolization</i></p> 	<p>A) EU: If the lights are CEVNI signs A.1, D.1 and D.2, which are combined with the corresponding notice marks for day time (see N.3.2), they do not need to be encoded as LIGHTS. But, if they are important for the safety of navigation, they should be indicated (e.g., to prevent confusion with other lights).</p> <p>B) US: Name of the light should be placed in the INFORM field, e.g. "Bridge Name" + (River Mile)</p> <p>C) Place the LIGHTS object on navigable span and piers bounding navigable span. No master object is required.</p> <p>D) If there are multiple lights in the same position, make one LIGHTS object and use MLTYLT to define the number of lights represented.</p> <p>E) Use one LIGHTS feature to represent upper and lower deck lights, unless the two lights are used for navigation alignment.</p> <p>F) EU: The exhibition condition of light EXCLIT is defined as follows:</p> <ol style="list-style-type: none"> <li>1. light shown without change of character: a light shown throughout the 24 hours without change of character.</li> <li>2. daytime light: a light that is only exhibited by day.</li> <li>3. fog light: a light that is exhibited in fog or conditions of reduced visibility.</li> <li>4. night light: a light that is only exhibited at night.</li> </ol> <p>G) The light characteristic LITCHR is defined as follows:</p> <ol style="list-style-type: none"> <li>1. fixed: a signal light that shows continuously, in any given direction, with constant luminous intensity and colour</li> </ol>	<p><b>Object Encoding</b></p> <p><b>Object Class = LIGHTS(P)</b></p> <p>(M) COLOUR = [1 (white), 3 (red), 4 (green), 6 (yellow)]</p> <p>(C) EXCLIT = [1 (light shown without change of character), 2 (daytime light), 3 (fog light), 4 (night light)]</p> <p>(M) LITCHR = [1 (fixed), 2 (flashing), 3 (long-flashing), 4 (quick-flashing), 5 (very quick-flashing), 6 (ultra quick flashing), 7 (isophased), 8 (occulting), 9 (interrupted quick-flashing), 10 (interrupted very quick-flashing), 11 (interrupted ultra quick-flashing), 12 (morse), 13 (fixed/flash), 14 (flash/long-flash), 15 (occulting/flash), 16 (fixed/long-flash), 17 (occulting alternating), 18 (long-flash alternating), 19 (flash alternating), 20 (group alternating), 25 (very quick-flash plus long-flash), 26 (very quick-flash plus long-flash), 27 (ultra quick-flash plus long-flash), 28 (alternating), 29 (fixed and alternating flashing)]</p> <p>(C) SIGPER = [xx.xx] (e.g. signal period of 12 seconds, coded as 12)</p> <p>(C) INFORM = (Refer to letter B)</p> <p>(C) MLTYLT = Integer number of lights, minimum 2.</p> <p>(C) SIGGRP = [(x),(x)...], e.g., (), (2), (2+1)</p> <p>(C) SIGSEQ = [L.LL + (E.EE)] (seconds)</p> <p>(M) ORIENT = [xxx or (UNKNOWN)] (degree (°)), e.g., 110</p> <p>(O) CONDTN = [1 (under construction), 2 (ruined), 3 (under reclamation), 5 (planned construction)]</p> <p>(O) HEIGHT = [xxx.x] metres, e.g., 27.4</p> <p>(O) VALNMR = [xx.x]</p> <p>(M) SCAMIN = [EU: 8000; US: 60000]</p> <p>(C) SORDAT = [YYYYMMDD]</p> <p>(C) SORIND = (Refer to Section B, General Guidance)</p>

2. flashing: a rhythmic light in which the total duration of light in a period is clearly shorter than the total duration of darkness and all the appearances of light are of equal duration

3. long-flashing: a flashing light in which a single flash of not less than two seconds duration is regularly repeated

4. quick-flashing: a light exhibiting without interruption very rapid regular alternations of light and darkness

5. very quick flashing: a flashing light in which flashes are repeated at a rate of not less than 80 flashes per minute but less than 160 flashes per minute

6. ultra quick flashing: a flashing light in which flashes are repeated at a rate of not less than 160 flashes per minute

7. isophased: a light with all durations of light and darkness equal

8. occulting: a rhythmic light in which the total duration of light in a period is clearly longer than the total duration of darkness and all the eclipses are of equal duration

9. interrupted quick flashing: a quick light in which the sequence of flashes is interrupted by regularly repeated eclipses of constant and long duration

10. interrupted very quick flashing: a light in which the very rapid alterations of light and darkness are interrupted at regular intervals by eclipses of long duration

11. interrupted ultra quick flashing: a light in which the ultra quick flashes (160 or more per minute) are interrupted at regular intervals by eclipses of long duration

12. morse: a rhythmic light in which appearances of light of two clearly different durations are grouped to represent a character or characters in the Morse code

28. alternating: a signal light that shows, in any given direction, two or more colours in a regularly repeated sequence with a regular periodicity

H) The signal period SIGPER is the time occupied by an entire cycle of





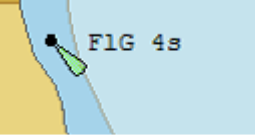
	<p>intervals of light and eclipse.</p> <p>I) The signal group SIGGRP is the number of signals, and the combination of signals or the morse character(s) within one period of full sequence. The signal group of a light is encoded using brackets to separate the individual groups. A group of signals may be a single number, a chain of numbers separated by "+", a sequence of up to 4 letters or a letter and a number. A fixed light has no signal group. Where no specific signal group is given for one of the light characteristics, this should be shown by an empty pair of brackets.</p> <p>J) The sequence of times occupied by intervals of light and eclipse is encoded in SIGSEQ. Example: "00.8+(02.2)+00.8+(05.2)" encodes a signal sequence with two intervals of light and two intervals of eclipse.</p> <p>K) This feature must be aggregated to a bridge by a C_AGGR object.</p>	
--	--	--

# N - Lights

## N.1 Light Structures

### N.1.2 Minor Light (C)

A navigation light that is supported on a structure, which cannot be depicted using the encoding in Sections O.1 or O.2. As a 'minor' light, its name does not need to be displayed.

Graphics	Encoding Instructions	Object Encoding
<p><i>Real World</i></p>  <p><i>Chart Symbol</i></p>  <p><i>IENC Symbolization</i></p> 	<p>A) PILPNT, MORFAC or LNDMRK must be defined as the master object with LIGHTS as the slave object. If the supporting structure is not known, PILPNT must be used.</p> <p>B) OBJNAM should be placed on the supporting structure (master object) and not on the LIGHTS.</p> <p>C) When no specific signal group is provided, use SIGGRP=().</p> <p>D) If there are multiple lights in the same position, make one LIGHTS object and use MLTYLT to define the number of lights represented.</p> <p>E) EU: The exhibition condition of light EXCLIT is defined as follows:</p> <ol style="list-style-type: none"> <li>1. light shown without change of character: a light shown throughout the 24 hours without change of character.</li> <li>2. daytime light: a light that is only exhibited by day.</li> <li>3. fog light: a light that is exhibited in fog or conditions of reduced visibility.</li> <li>4. night light: a light which is only exhibited at night.</li> </ol> <p>F) US: STATUS = 8 (private)</p> <p>G) US: Western River Rules, RED will always be a double flash SIGGRP (2), and Green will always be a single flash.</p> <p>H) The light characteristic LITCHR is defined as follows:</p> <ol style="list-style-type: none"> <li>1. fixed: a signal light that shows continuously, in any given direction, with constant luminous intensity and colour</li> <li>2. flashing: a rhythmic light in which the total duration of light in a period is clearly shorter than the total duration of darkness, and all the appearances of light are of equal</li> </ol>	<p><b>Coding of Structure Object</b></p> <p><b>Object Class = PILPNT(P)</b></p> <p>(O) OBJNAM = ["Name" +(River Mile), e.g. Blackburn Island Lt.(284.4)]</p> <p>(O) NOBJNM = (Refer to Section B, General Guidance)</p> <p>(O) CONDTN = [1 (under construction), 2 (ruined), 3 (under reclamation), 5 (planned construction)]</p> <p>(M) SCAMIN = [EU: 22000; US: 60000]</p> <p>(C) SORDAT = [YYYYMMDD]</p> <p>(C) SORIND = (Refer to Section B, General Guidance)</p> <p><b>Coding of Equipment Object</b></p> <p><b>Object Class = LIGHTS(P)</b></p> <p>(M) COLOUR = [1 (white), 3 (red), 4 (green), 6 (yellow)]</p> <p>(C) EXCLIT = [1 (light shown without change of character), 2 (daytime light), 3 (fog light), 4 (night light)]</p> <p>(M) LITCHR = [1 (fixed), 2 (flashing), 3 (long-flashing), 4 (quick-flashing), 5 (very quick-flashing), 6 (ultra quick flashing), 7 (isophased), 8 (occulting), 9 (interrupted quick-flashing), 10 (interrupted very quick-flashing), 11 (interrupted ultra quick-flashing), 12 (morse), 13 (fixed/flash), 14 (flash/long-flash), 15 (occulting/flash), 16 (fixed/long-flash), 17 (occulting alternating), 18 (long-flash alternating), 19 (flash alternating), 20 (group alternating), 25 (very quick-flash plus long-flash), 26 (very quick-flash plus long-flash), 27 (ultra quick-flash plus long-flash), 28 (alternating), 29 (fixed and alternating flashing)]</p> <p>(C) CATLIT = (Refer to letters N or O)</p> <p>(C) SIGPER = [xx.xx] (e.g. signal period of 12 seconds, coded as 12)</p> <p>(C) SIGGRP = [(x),(x)...], e.g., (), (2), (2+1)</p> <p>(C) SIGSEQ = [L.LL + (E.EE)] (seconds)</p> <p>(O) INFORM = [descending bank, structure_up, structure_down (e.g. LDB)]</p>

duration

3. long-flashing: a flashing light in which a single flash of not less than two seconds duration is regularly repeated

4. quick-flashing: a light exhibiting without interruption very rapid regular alternations of light and darkness

5. very quick flashing: a flashing light in which flashes are repeated at a rate of not less than 80 flashes per minute but less than 160 flashes per minute

6. ultra quick flashing: a flashing light in which flashes are repeated at a rate of not less than 160 flashes per minute

7. isophased: a light with all durations of light and darkness equal

8. occulting: a rhythmic light in which the total duration of light in a period is clearly longer than the total duration of darkness and all the eclipses are of equal duration

9. interrupted quick flashing: a quick light in which the sequence of flashes is interrupted by regularly repeated eclipses of constant and long duration

10. interrupted very quick flashing: a light in which the very rapid alterations of light and darkness are interrupted at regular intervals by eclipses of long duration

11. interrupted ultra quick flashing: a light in which the ultra quick flashes (160 or more per minute) are interrupted at regular intervals by eclipses of long duration

12. morse: a rhythmic light in which appearances of light of two clearly different durations are grouped to represent a character or characters in the Morse code

28. alternating: a signal light that shows, in any given direction, two or more colours in a regularly repeated sequence with a regular periodicity

I) The signal period SIGPER is the time occupied by an entire cycle of intervals of light and eclipse.

J) The signal group SIGGRP is the number of signals, the combination of signals or the morse character(s)

(C) MLTYLT = Integer number of lights, minimum 2.

(O) HEIGHT = [xxx.x] metres, e.g., 27.4

(O) VALNMR = [xx.x]

(C) STATUS = (Refer to letter F)

(O) CONDTN = [1 (under construction), 2 (ruined), 3 (under reclamation), 5 (planned construction)]

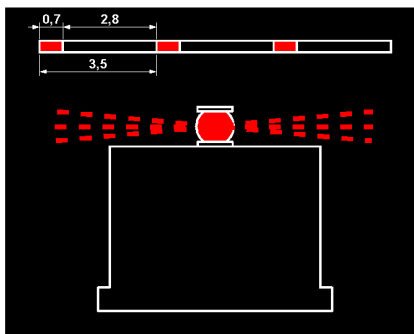
(M) SCAMIN = [EU: 22000; US: 60000]

(C) SORDAT = [YYYYMMDD]

(C) SORIND = (Refer to Section B, General Guidance)

within one period of full sequence.  
The signal group of a light is encoded using brackets to separate the individual groups. A group of signals may be a single number, a chain of numbers separated by "+", a sequence of up to 4 letters or a letter and a number. A fixed light has no signal group. Where no specific signal group is given for one of the light characteristics, this should be shown by an empty pair of brackets.




- K) The sequence of times occupied by intervals of light and eclipse is encoded in SIGSEQ. Example: "00.8+(02.2)+00.8+(05.2)" encodes a signal sequence with two intervals of light and two intervals of eclipse.
- L) Example of encoding: red night light on a buoy (see illustration): LIGHTS (COLOUR 3, EXCLIT 4, LITCHR 4, SIGPER 3.5, SIGGRP ( ), SIGSEQ 0.7+(2.8), STATUS 14, SCAMIN 22000)
- M) Official aids to navigation shall be encoded.
- N) US: For airport runway lights, encode CATLIT = 5 (aero light). Encode EXCLIT = 4 (night light) if appropriate
- O) For an air obstruction light which may also be used as a navigational reference, encode CATLIT = 6 (air obstruction light)



## N.1 Light Structures

### N.1.3 Leading Light (C)

A light associated with other lights so as to form a leading line to be followed. (adapted from IHO Dictionary, S-32, 5th Edition, 2794).

Graphics	Encoding Instructions	Object Encoding
<p><i>Real World</i></p>  <p><i>Chart Symbol</i></p>  <p><i>IENC Symbolization</i></p> 	<p>A) Leading lights are encoded as a collection object M_AGGR (Aggregation) consisting of the front and rear lights, which are encoded separately.</p> <p>B) PILPNT, MORFAC or LNDMRK must be defined as the master object with LIGHTS as the slave object. If the supporting structure is not known, PILPNT must be used.</p> <p>C) OBJNAM should be placed on the supporting structure (master object) and not on the LIGHTS.</p> <p>D) The attribute ORIENT is not used for leading lights, except for directional lights.</p> <p>E) If there are multiple lights in the same position, make one LIGHTS object and use MLTYLT to define the number of lights represented.</p> <p>The sector in which the leading light is visible from seaward is encoded as a LIGHTS with CATLIT =</p> <p>4,12 - front leading light</p> <p>4,13 - rear leading light</p> <p>4,14 - lower leading light</p> <p>4,15 - upper leading light</p> <p>F) EU: The exhibition condition of light EXCLIT is defined as follows:</p> <ol style="list-style-type: none"> <li>1. light shown without change of character: a light shown throughout the 24 hours without change of character.</li> <li>2. daytime light: a light that is only exhibited by day.</li> <li>3. fog light: a light that is exhibited in fog or conditions of reduced visibility.</li> <li>4. night light: a light that is only exhibited at night.</li> </ol> <p>G) The light characteristic LITCHR is defined as follows:</p>	<p><b>Coding of Master Object</b></p> <p><b>Object Class = PILPNT(P)</b></p> <p>(M) OBJNAM = ["Name" + (River Mile), e.g. Blackburn Island Lt. (284.4)]</p> <p>(O) NOBJNM = (Refer to Section B, General Guidance)</p> <p>(O) CONDTN = [1 (under construction), 2 (ruined), 3 (under reclamation), 5 (planned construction)]</p> <p>(M) SCAMIN = [EU: 22000; US: 60000]</p> <p>(C) SORDAT = [YYYYMMDD]</p> <p>(C) SORIND = (Refer to Section B, General Guidance)</p> <p><b>Coding of Equipment Object</b></p> <p><b>Object Class = LIGHTS(P)</b></p> <p>(M) CATLIT = [1 (directional function), 4 (leading light), 5 (aero light), 6 (air obstruction light), 12 (front), 13 (rear), 14 (lower), 15 (upper)]</p> <p>(M) COLOUR = [1 (white), 3 (red), 4 (green), 6 (yellow)]</p> <p>(M) EXCLIT = [1 (light shown without change of character), 2 (daytime light), 3 (fog light), 4 (night light)]</p> <p>(M) LITCHR = [1 (fixed), 2 (flashing), 3 (long-flashing), 4 (quick-flashing), 5 (very quick-flashing), 6 (ultra quick flashing), 7 (isophased), 8 (occulting), 9 (interrupted quick-flashing), 10 (interrupted very quick-flashing), 11 (interrupted ultra quick-flashing), 12 (morse), 13 (fixed/flash), 14 (flash/long-flash), 15 (occulting/flash), 16 (fixed/long-flash), 17 (occulting alternating), 18 (long-flash alternating), 19 (flash alternating), 20 (group alternating), 25 (very quick-flash plus long-flash), 26 (very quick-flash plus long-flash), 27 (ultra quick-flash plus long-flash), 28 (alternating), 29 (fixed and alternating flashing)]</p> <p>(C) ORIENT = [xxx.xx]</p> <p>(C) SIGPER = [xx.xx] (e.g. signal period of 12 seconds coded as "12")</p>

1. fixed: a signal light that shows continuously, in any given direction, with constant luminous intensity and colour

2. flashing: a rhythmic light in which the total duration of light in a period is clearly shorter than the total duration of darkness and all the appearances of light are of equal duration

3. long-flashing: a flashing light in which a single flash of not less than two seconds duration is regularly repeated

4. quick-flashing: a light exhibiting without interruption very rapid regular alternations of light and darkness

5. very quick flashing: a flashing light in which flashes are repeated at a rate of not less than 80 flashes per minute but less than 160 flashes per minute

6. ultra quick flashing: a flashing light in which flashes are repeated at a rate of not less than 160 flashes per minute

7. isophased: a light with all durations of light and darkness equal

8. occulting: a rhythmic light in which the total duration of light in a period is clearly longer than the total duration of darkness and all the eclipses are of equal duration

9. interrupted quick flashing: a quick light in which the sequence of flashes is interrupted by regularly repeated eclipses of constant and long duration

10. interrupted very quick flashing: a light in which the very rapid alterations of light and darkness are interrupted at regular intervals by eclipses of long duration

11. interrupted ultra quick flashing: a light in which the ultra quick flashes (160 or more per minute) are interrupted at regular intervals by eclipses of long duration

12. morse: a rhythmic light in which appearances of light of two clearly different durations are grouped to represent a character or characters in the Morse code

28. alternating: a signal light that shows, in any given direction, two or

(C) SIGGRP = [(x),(x)...], e.g., (), (2), (2+1)

(C) SIGSEQ = [L.LL + (E.EE)] (seconds)

(O) HEIGHT = [xxx.x] metres, e.g., 27.4

(O) VALNMR = [xx.x]

(C) INFORM = US: descending bank (e.g. LDB for left descending bank)

(C) MLTYLT = Integer number of lights, minimum 2.

(O) STATUS = [8 (private), 14 (public)]

(O) CONDTN = [1 (under construction), 2 (ruined), 3 (under reclamation), 5 (planned construction)]

(M) SCAMIN = [EU: 22000; US: 60000]

(C) SORDAT = [YYYYMMDD]

(C) SORIND = (Refer to Section B, General Guidance)

#### **Object Encoding**

**Object Class = NAVLNE(L)**

(M) CATNAV = [1 (clearing line), 2 (transit line), 3 (leading line bearing a recommended track)]

(M) ORIENT = [xxx or (UNKNOWN)] (degree (°)), e.g., 110

(M) SCAMIN = [EU: 22000; US: 60000]

(C) SORDAT = [YYYYMMDD]

(C) SORIND = (Refer to Section B, General Guidance)

#### **Object Encoding**

**Object Class = RECTRC(L)**

(M) CATTRK = [1 (based on a system of fixed marks)]

(O) DRVAL1 = [sxx.x] (s: sign, negative values only)

(O) DRVAL2 = [xx.x]

(M) ORIENT = [xx.x]

(M) TRAFIC = [1 (inbound), 2 (outbound), 3 (one-way), 4 (two-way)]

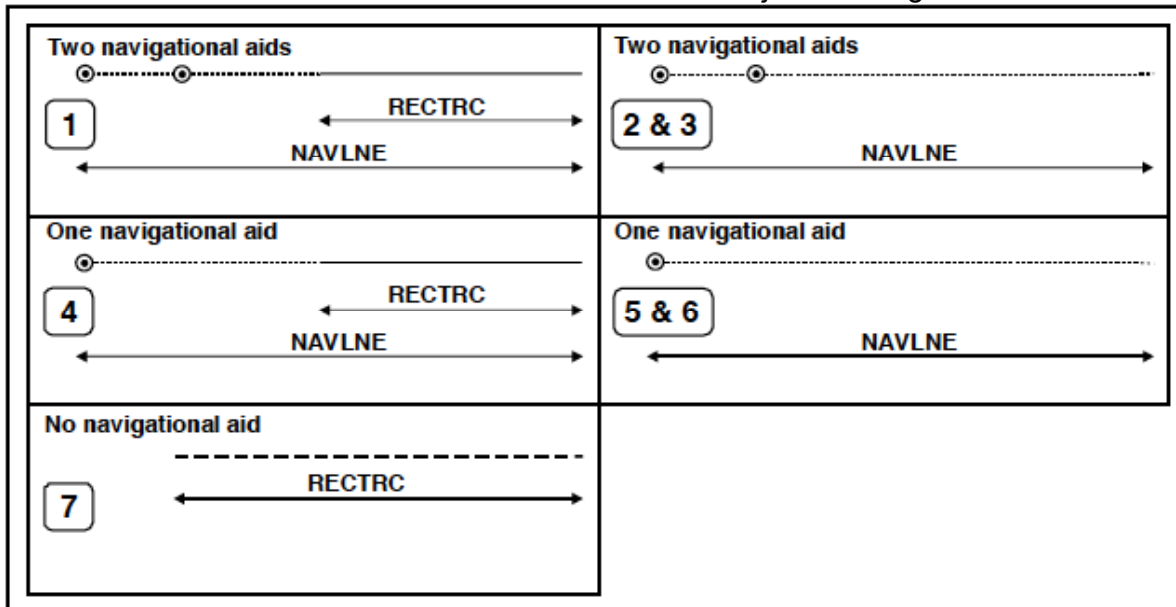
(M) SCAMIN = [EU: 22000; US: 60000]

(C) SORDAT = [YYYYMMDD]

(C) SORIND = (Refer to Section B, General Guidance)

more colours in a regularly repeated sequence with a regular periodicity

- H) The signal period SIGPER is the time occupied by an entire cycle of intervals of light and eclipse.
- I) The signal group SIGGRP is the number of signals, the combination of signals or the morse character(s) within one period of full sequence. The signal group of a light is encoded using brackets to separate the individual groups. A group of signals may be a single number, a chain of numbers separated by "+", a sequence of up to 4 letters or a letter and a number. A fixed light has no signal group. Where no specific signal group is given for one of the light characteristics, this should be shown by an empty pair of brackets.
- J) The sequence of times occupied by intervals of light and eclipse is encoded in SIGSEQ. Example: "00.8+(02.2)+00.8+(05.2)" encodes a signal sequence with two intervals of light and two intervals of eclipse.
- K) Navigation line of the leading line is encoded as a line object class NAVLNE (Navigation line) with attribute ORIENT (Orientation) set to the direction of the navigation line and attribute CATNAV set to 3 (leading line bearing a recommended track). The running part of the leading line is encoded as a line object class RECTRC (Recommended track) with attribute ORIENT (Orientation) set to the direction of the recommended track. The line objects RECTRC and NAVLNE are also components of the meta object C\_AGGR.
- L) The extent of the navigation line depends on the visibility of the navigational aid(s).
- M) The recommended track is that portion of a 'navigation line' that a ship should use for navigation.
- N) ORIENT is the direction from the waterside towards the lights or beacons.
- O) Official aids to navigation shall be encoded.







## N.1 Light Structures

### N.1.4 Directional Light (C)

A light illuminating a sector of very narrow angle and intended to mark a direction to follow. (IHO Dictionary, S-32, 5th Edition, 2778)

Graphics	Encoding Instructions	Object Encoding
<p><i>Chart Symbol</i></p>  <p><i>IENC Symbolization</i></p> 	<p>A) PILPNT, MORFAC or LNDMRK must be defined as the master object with LIGHTS as the slave object. If the supporting structure is not known, PILPNT must be used.</p> <p>B) OBJNAM should be placed on the supporting structure (master object) and not on the LIGHTS.</p> <p>C) If there are multiple lights in the same position, make one LIGHTS object and use MLTYLT to define the number of lights represented.</p> <p>D) EU: The exhibition condition of light EXCLIT is defined as follows:</p> <ol style="list-style-type: none"> <li>light shown without change of character: a light shown throughout the 24 hours without change of character.</li> <li>daytime light: a light that is only exhibited by day.</li> <li>fog light: a light that is exhibited in fog or conditions of reduced visibility.</li> <li>night light: a light that is only exhibited at night.</li> </ol> <p>E) The light characteristic LITCHR is defined as follows:</p> <ol style="list-style-type: none"> <li>fixed: a signal light that shows continuously, in any given direction, with constant luminous intensity and colour</li> <li>flashing: a rhythmic light in which the total duration of light in a period is clearly shorter than the total duration of darkness and all the appearances of light are of equal duration</li> <li>long-flashing: a flashing light in which a single flash of not less than two seconds duration is regularly repeated</li> <li>quick-flashing: a light exhibiting without interruption very rapid regular alternations of light and</li> </ol>	<p><b>Coding of Master Object</b></p> <p><b>Object Class = PILPNT(P)</b></p> <p>(M) OBJNAM = ["Name" + (River Mile), e.g. Blackburn Island Lt. (284.4)]</p> <p>(O) NOBJNM = (Refer to Section B, General Guidance)</p> <p>(O) CONDTN = [1 (under construction), 2 (ruined), 3 (under reclamation), 5 (planned construction)]</p> <p>(M) SCAMIN = [EU: 22000; US: 60000]</p> <p>(C) SORDAT = [YYYYMMDD]</p> <p>(C) SORIND = (Refer to Section B, General Guidance)</p> <p><b>Coding of Equipment Object</b></p> <p><b>Object Class = LIGHTS(P)</b></p> <p>(M) CATLIT = [1 (directional function)]</p> <p>(M) COLOUR = [1 (white), 3 (red), 4 (green), 6 (yellow)]</p> <p>(M) EXCLIT = [1 (light shown without change of character), 2 (daytime light), 3 (fog light), 4 (night light)]</p> <p>(M) LITCHR = [1 (fixed), 2 (flashing), 3 (long-flashing), 4 (quick-flashing), 5 (very quick-flashing), 6 (ultra quick flashing), 7 (isophased), 8 (occulting), 9 (interrupted quick-flashing), 10 (interrupted very quick-flashing), 11 (interrupted ultra quick-flashing), 12 (morse), 13 (fixed/flash), 14 (flash/long-flash), 15 (occulting/flash), 16 (fixed/long-flash), 17 (occulting alternating), 18 (long-flash alternating), 19 (flash alternating), 20 (group alternating), 25 (very quick-flash plus long-flash), 26 (very quick-flash plus long-flash), 27 (ultra quick-flash plus long-flash), 28 (alternating), 29 (fixed and alternating flashing)]</p> <p>(C) LITVIS = [4 (intensified)]</p> <p>(C) ORIENT = [xxx.xx]</p> <p>(C) SIGPER = [xx.xx] (e.g. signal period of 12 seconds coded as "12")</p> <p>(C) SIGGRP = [(x),(x)...], e.g., (), (2), (2+1)</p>

darkness

5. very quick flashing: a flashing light in which flashes are repeated at a rate of not less than 80 flashes per minute but less than 160 flashes per minute

6. ultra quick flashing: a flashing light in which flashes are repeated at a rate of not less than 160 flashes per minute

7. isophased: a light with all durations of light and darkness equal

8. occulting: a rhythmic light in which the total duration of light in a period is clearly longer than the total duration of darkness and all the eclipses are of equal duration

9. interrupted quick flashing: a quick light in which the sequence of flashes is interrupted by regularly repeated eclipses of constant and long duration

10. interrupted very quick flashing: a light in which the very rapid alterations of light and darkness are interrupted at regular intervals by eclipses of long duration

11. interrupted ultra quick flashing: a light in which the ultra quick flashes (160 or more per minute) are interrupted at regular intervals by eclipses of long duration

12. morse: a rhythmic light in which appearances of light of two clearly different durations are grouped to represent a character or characters in the Morse code

28. alternating: a signal light that shows, in any given direction, two or more colours in a regularly repeated sequence with a regular periodicity

F) The signal period SIGPER is the time occupied by an entire cycle of intervals of light and eclipse.

G) The signal group SIGGRP is the number of signals, the combination of signals or the morse character(s) within one period of full sequence. The signal group of a light is encoded using brackets to separate the individual groups. A group of signals may be a single number, a chain of numbers separated by "+", a sequence of up to 4 letters or a letter and a number. A fixed light has no signal group. Where no specific signal group is given for

(C) SIGSEQ = [L.LL + (E.EE)] (seconds)

(C) INFORM = US: descending bank (e.g. LDB for left descending bank)

(C) MLTYLT = Integer number of lights, minimum 2.

(O) HEIGHT = [xxx.x] metres, e.g., 27.4

(O) VALNMR = [xx.x]

(O) STATUS = [8 (private), 14 (public)]

(O) CONDTN = [1 (under construction), 2 (ruined), 3 (under reclamation), 5 (planned construction)]

(M) SCAMIN = [EU: 22000; US: 60000]

(C) SORDAT = [YYYYMMDD]

(C) SORIND = (Refer to Section B, General Guidance)

**Object Encoding**

**Object Class = NAVLNE(L)**

(M) CATNAV = [1 (clearing line), 2 (transit line), 3 (leading line bearing a recommended track)]

(M) ORIENT = [xxx or (UNKNOWN)] (degree (°)), e.g., 110

(M) SCAMIN = [EU: 22000; US: 60000]

(C) SORDAT = [YYYYMMDD]

(C) SORIND = (Refer to Section B, General Guidance)

**Object Encoding**

**Object Class = RECTRC(L)**

(M) CATTRK = [1 (based on a system of fixed marks)]

(O) DRVAL1 = [sxx.x] (s: sign, negative values only)

(O) DRVAL2 = [xx.x]

(M) ORIENT = [xx.x]

(M) TRAFIC = [1 (inbound), 2 (outbound), 3 (one-way), 4 (two-way)]

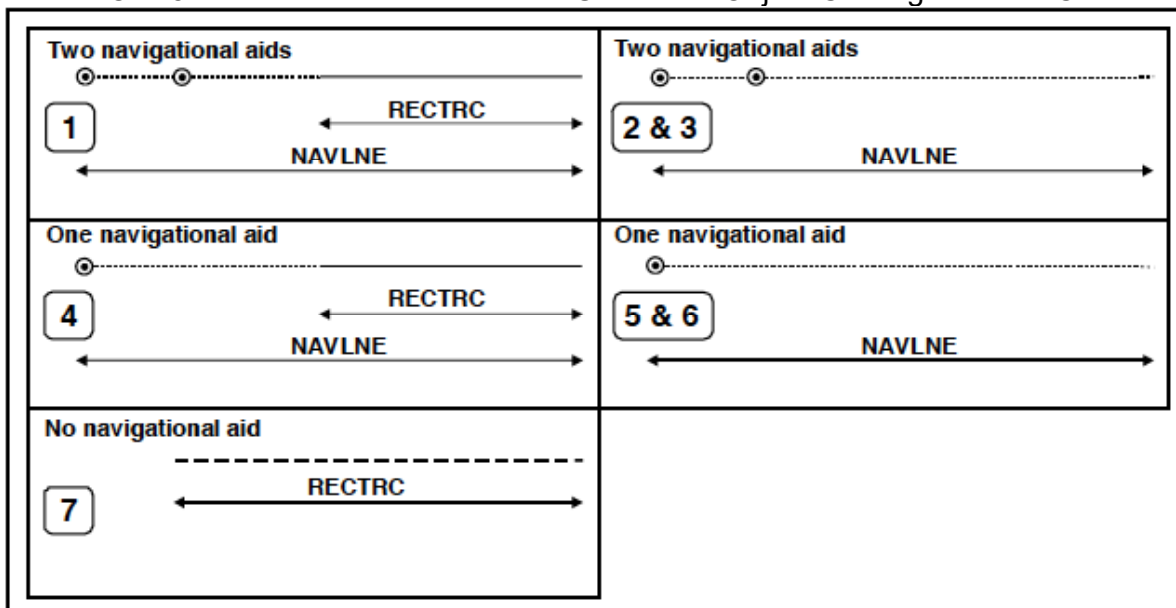
(M) SCAMIN = [EU: 22000; US: 60000]

(C) SORDAT = [YYYYMMDD]

(C) SORIND = (Refer to Section B, General Guidance)

	<p>one of the light characteristics, this should be shown by an empty pair of brackets.</p> <p>H) The sequence of times occupied by intervals of light and eclipse is encoded in SIGSEQ. Example: "00.8+(02.2)+00.8+(05.2)" encodes a signal sequence with two intervals of light and two intervals of eclipse.</p> <p>I) Navigation line of the leading line is encoded as a line object class NAVLNE (Navigation line) with attribute ORIENT (Orientation) set to the direction of the navigation line and attribute CATNAV set to 3 (leading line bearing a recommended track). The running part of the leading line is encoded as a line object class RECTRC (Recommended track) with attribute ORIENT (Orientation) set to the direction of the recommended track. The line objects RECTRC and NAVLNE are also components of the meta object M_AGGR.</p> <p>J) The extent of the navigation line depends on the visibility of the navigational aid(s).</p> <p>K) The recommended track is that portion of a 'navigation line' that a ship should use for navigation.</p> <p>L) ORIENT is the direction from the waterside towards the lights or beacons.</p> <p>M) Official aids to navigation shall be encoded.</p>	
--	---	--


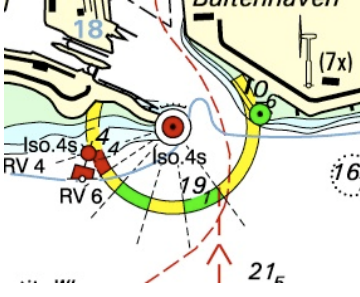

From IHO S-57 APPENDIX B.1 Annex A - Use of the Object Catalogue for ENC



## N.1 Light Structures

### N.1.5 Sector Light (C)

A sector light consists of a single light whose total luminous beam is divided into sectors of different colours to provide a warning or a leading line to mariners. (IALA Aids to Navigation Manual – IALA NAVGUIDE 3 Edition 5 2006)

Graphics	Encoding Instructions	Object Encoding
<p><i>Real World</i></p>  <p><i>Chart Symbol</i></p>  <p><i>IENC Symbolization</i></p> 	<p>A) PILPNT, MORFAC or LNDMRK must be defined as the master object with LIGHTS as the slave object. If the supporting structure is not known, PILPNT must be used.</p> <p>B) Each sector in which the light is visible from the waterway is encoded with one object LIGHTS</p> <p>C) No object is created to encode a sector where no light is transmitted.</p> <p>D) Limits of sectors are encoded with the attributes SECTR1 and SECTR2.</p> <p>E) SECTR1 specifies the first limit of the sector. The order of SECTR1 and SECTR2 is clockwise around the central object (e.g. a light).</p> <p>F) OBJNAM should be placed on the supporting structure (master object) and not on the LIGHTS.</p> <p>G) EU: The exhibition condition of light EXCLIT is defined as follows:</p> <ol style="list-style-type: none"> <li>1. light shown without change of character: a light shown throughout the 24 hours without change of character.</li> <li>2. daytime light: a light that is only exhibited by day.</li> <li>3. fog light: a light that is exhibited in fog or conditions of reduced visibility.</li> <li>4. night light: a light that is only exhibited at night.</li> </ol> <p>H) The light characteristic LITCHR is defined as follows:</p> <ol style="list-style-type: none"> <li>1. fixed: a signal light that shows continuously, in any given direction, with constant luminous intensity and colour</li> <li>2. flashing: a rhythmic light in which the total duration of light in a period is clearly shorter than the total duration of darkness and all the appearances of light are of equal</li> </ol>	<p><b>Coding of Master Object</b></p> <p><b>Object Class = PILPNT(P)</b></p> <p>(M) OBJNAM = ["Name" + (River Mile), e.g. Blackburn Island Lt. (284.4)]</p> <p>(O) NOBJNM = (Refer to Section B, General Guidance)</p> <p>(O) CONDTN = [1 (under construction), 2 (ruined), 3 (under reclamation), 5 (planned construction)]</p> <p>(M) SCAMIN = [EU: 22000; US: 60000]</p> <p>(C) SORDAT = [YYYYMMDD]</p> <p>(C) SORIND = (Refer to Section B, General Guidance)</p> <p><b>Coding of Equipment Object</b></p> <p><b>Object Class = LIGHTS(P)</b></p> <p>(M) COLOUR = [1 (white), 3 (red), 4 (green), 6 (yellow)]</p> <p>(M) EXCLIT = [1 (light shown without change of character), 2 (daytime light), 3 (fog light), 4 (night light)]</p> <p>(M) LITCHR = [1 (fixed), 2 (flashing), 3 (long-flashing), 4 (quick-flashing), 5 (very quick-flashing), 6 (ultra quick flashing), 7 (isophased), 8 (occulting), 9 (interrupted quick-flashing), 10 (interrupted very quick-flashing), 11 (interrupted ultra quick-flashing), 12 (morse), 13 (fixed/flash), 14 (flash/long-flash), 15 (occulting/flash), 16 (fixed/long-flash), 17 (occulting alternating), 18 (long-flash alternating), 19 (flash alternating), 20 (group alternating), 25 (very quick-flash plus long-flash), 26 (very quick-flash plus long-flash), 27 (ultra quick-flash plus long-flash), 28 (alternating), 29 (fixed and alternating flashing)]</p> <p>(M) SECTR1 = [xxx.xx]</p> <p>(M) SECTR2 = [xxx.xx]</p> <p>(C) SIGPER = [xx.xx] (e.g. signal period of 12 seconds coded as "12")</p> <p>(C) SIGGRP = [(x),(x)..], e.g., (1), (2), (2+1)</p> <p>(C) SIGSEQ = [L.LL + (E.EE)] (seconds)</p>

duration

3. long-flashing: a flashing light in which a single flash of not less than two seconds duration is regularly repeated

4. quick-flashing: a light exhibiting without interruption very rapid regular alternations of light and darkness

5. very quick flashing: a flashing light in which flashes are repeated at a rate of not less than 80 flashes per minute but less than 160 flashes per minute

6. ultra quick flashing: a flashing light in which flashes are repeated at a rate of not less than 160 flashes per minute

7. isophased: a light with all durations of light and darkness equal

8. occulting: a rhythmic light in which the total duration of light in a period is clearly longer than the total duration of darkness and all the eclipses are of equal duration

9. interrupted quick flashing: a quick light in which the sequence of flashes is interrupted by regularly repeated eclipses of constant and long duration

10. interrupted very quick flashing: a light in which the very rapid alterations of light and darkness are interrupted at regular intervals by eclipses of long duration

11. interrupted ultra quick flashing: a light in which the ultra quick flashes (160 or more per minute) are interrupted at regular intervals by eclipses of long duration

12. morse: a rhythmic light in which appearances of light of two clearly different durations are grouped to represent a character or characters in the Morse code

28. alternating: a signal light that shows, in any given direction, two or more colours in a regularly repeated sequence with a regular periodicity

I) The signal period SIGPER is the time occupied by an entire cycle of intervals of light and eclipse.

J) The signal group SIGGRP is the number of signals, the combination of signals or the morse character(s)

(O) HEIGHT = [xxx.x] metres, e.g., 27.4

(O) VALNMR = [xx.x]

(C) INFORM = US: descending bank (e.g. LDB for left descending bank)

(O) STATUS = [8 (private), 14 (public)]

(O) CONDTN = [1 (under construction), 2 (ruined), 3 (under reclamation), 5 (planned construction)]

(M) SCAMIN = [EU: 22000; US: 60000]

(C) SORDAT = [YYYYMMDD]

(C) SORIND = (Refer to Section B, General Guidance)

within one period of full sequence. The signal group of a light is encoded using brackets to separate the individual groups. A group of signals may be a single number, a chain of numbers separated by "+", a sequence of up to 4 letters or a letter and a number. A fixed light has no signal group. Where no specific signal group is given for one of the light characteristics, this should be shown by an empty pair of brackets.

K) The sequence of times occupied by intervals of light and eclipse is encoded in SIGSEQ. Example: "00.8+(02.2)+00.8+(05.2)" encodes a signal sequence with two intervals of light and two intervals of eclipse.

L) Official aids to navigation shall be encoded.

M) If it is required to encode an oscillating light sector, it should be done using a Light Sectored feature, with iterations of the complex attribute light sector as follows:

For light sectors in the IALA A system that are alternating and oscillate increasingly from white to green (to starboard) and red (to port) with increasing deviation from the track defined by the directional light:

light sector: light characteristic = 28 (Alternating); colour = 1,3 (White, Red); sector limit; information (text) = White phase decreases as bearing to light increases

light sector: light characteristic = 28 (Alternating); colour = 1,4 (White, Green); sector limit; information (text) = White phase increases as bearing to light increases

For lights in the IALA B system that are alternating and oscillate increasingly from white to red (to starboard) and green (to port) with increasing deviation from the track defined by the directional light; transpose the colours red and green in the above encoding.

For lights in the IALA A system that are occulting green (to starboard) and red (to port) which oscillate with increasing period of eclipse to isophased or flashing

with increasing deviation from the track defined by the directional light:

light sector: light characteristic = 8 (Occulting); colour = 3 (Red); sector limit; information (text) = Light phase decreases as bearing to light increases

light sector: light characteristic = 8 (Occulting); colour = 4 (Green); sector limit; information (text) = Light phase increases as bearing to light increases

For lights in the IALA B system that are occulting red (to starboard) and green (to port) which oscillate with increasing period of eclipse to isophased or flashing with increasing deviation from the track defined by the directional light; transpose the colours red and green in the above encoding.

Oscillating lights which are not IALA should be encoded similar to the above. For instance, where a light contains white sectors that are occulting and oscillate with increasing period of eclipse to isophased or flashing with increasing deviation from the track defined by the directional light:

For the sector to port of the track defined by the directional light: light sector: light characteristic = 8 (Occulting); colour = 1 (White); sector limit; information (text) = Light phase decreases as bearing to light increases

For the sector to starboard of the track defined by the directional light: light sector: light characteristic = 8 (Occulting); colour = 1 (White); sector limit; information (text) = Light phase increases as bearing to light increases





All other light sectors must be encoded using additional iterations of light sector, with sub-attributes (including light characteristic) populated in accordance with the characteristics of the sector, or using the feature Light Directional

# O - Buoys, Beacons and Daymarks, Notice Marks

## O.1 Buoys

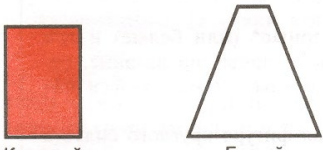
### O.1.1 Buoy at Bifurcation of Channel (M)

A buoy at a fairway junction may indicate by its top mark on which side it is preferable to pass (main channel).

Graphics	Encoding Instructions	Object Encoding
<p><i>Real World</i></p>  <p><i>Chart Symbol</i></p>  <p><i>Chart Symbol (single mark)</i></p>  <p><i>Chart Symbol (double marks)</i></p> 	<p>A) In the event there is a light on the day mark, the BOYSPP object should be designated as the master and coded with the OBJNAM of the LIGHTS object.</p> <p>B) EU: The designator as it appears on the buoy, if it can be read from a passing vessel, should be encoded in the attribute OBJNAM. Administrative information on the buoys that is not relevant for navigation should be encoded in the attribute NOBJNM. It is not repeated for each slave object.</p> <p>C) EU: If a buoy is according to IALA with preference of channel, object class: BOYLAT, CATLAM = 3 or 4 shall be used.</p> <p>D) EU: Coding of the CATLAM attribute is mandatory.</p> <p>In case TOPMAR is added: the buoy has to be encoded as master and TOPMAR as slave TOPSHP = 3 (sphere) and COLOUR/COLPAT see buoy; and/or TOPSHP = 1 (cone, up) if CATLAM = 3 or TOPSHP = 5 (cylinder, can) if CATLAM= 4</p> <p>If buoy according to IALA with preference of channel, BOYLAT, CATLAM = 3 or 4</p> <p>E) IALA: If there is no preference to pass BOYSPP with (M) CATSPM = 54 (channel separation mark) is used</p> <p>F) EU: If a buoy is according to CEVNI, object class: 'boylat', 'catlam' = 3, 4 or 8 shall be used.</p> <p>catlam/COLOUR attributes must be used in the following combinations: 10 (bifurcation of channel) / 3,4,3,4 (red / green)</p>	<p><b>Coding of Structure Object</b></p> <p><b>Object Class = BOYLAT(P)</b> (M) CATLAM = [3 (preferred channel to starboard lateral mark), 4 (preferred channel to port lateral mark)] (M) BOYSHP = [1 (conical (nun, ogival)), 2 (can (cylindrical)), 3 (spherical), 4 (pillar), 5 (spar (spindle))] (M) COLOUR = [1 (white), 3 (red), 4 (green)] (C) OBJNAM = (Refer to letter B) (C) NOBJNM = (Refer to letter B) (C) MARSYS = [1 (IALA A), 2 (IALA B)] (C) INFORM = (Refer to letter I) (M) SCAMIN = [EU: 22000; US: 60000] (C) SORDAT = [YYYYMMDD] (C) SORIND = (Refer to Section B, General Guidance)</p> <p><b>Alternative (see coding instruction E)</b></p> <p><b>Object Class = BOYSPP(P)</b> (M) BOYSHP = [1 (conical (nun, ogival)), 3 (spherical), 4 (pillar), 5 (spar (spindle))] (M) CATSPM = [54 (channel separation mark)] (M) COLOUR = [1 (white), 2 (black), 3 (red), 4 (green)] (M) COLPAT = [1 (horizontal stripes), 2 (vertical stripes)] (C) MARSYS = [1 (IALA A), 2 (IALA B)] (O) CONRAD = [3 (radar conspicuous (has radar reflector))] (C) OBJNAM = (Refer to letter B) (O) NOBJNM = (Refer to letter B) (M) SCAMIN = [EU: 22000; US: 60000] (C) SORDAT = [YYYYMMDD] (C) SORIND = (Refer to Section B, General Guidance)</p> <p><b>alternative (see coding instruction F)</b></p>



**Chart Symbol (double marks)**



**IENC Symbolization**



- G) EU: If not under the issuing authority, use INFORM to indicate responsibility of operation of the buoy.
- H) EU: For CEVNI buoy with two topmarks, encode only the upper TOPMAR.
- I) If the system of navigational marks of a special sign is different from the system mentioned in 'm\_nsys', the attribute MARSYS, INFORM or 'marsys' must be used.

**Object Class = boylat(P)**

- (M) BOYSHP = [1 (conical (nun, ogival)), 2 (can (cylindrical)), 3 (spherical), 4 (pillar), 5 (spar (spindle))]
- (M) catlam = [3 (preferred channel to starboard lateral mark), 4 (preferred channel to port lateral mark), 10 (bifurcation of the channel)]
- (M) COLOUR = [3 (red), 4 (green)]
- (M) COLPAT = [1 (horizontal stripes)]
- (C) marsys = [1 (IALA A), 2 (IALA B), 9 (no system), 10 (other system), 11 (CEVNI), 12 (Russian inland waterway regulations), 13 (Brazilian national inland waterway regulations - two sides), 14 (Brazilian national inland waterway regulations - side independent), 15 (Paraguay-Parana waterway - Brazilian complementary aids)]
- (O) CONRAD = [3 (radar conspicuous (has radar reflector))]
- (O) INFORM = (EU: Refer to letter G)
- (O) NINFOM = (Refer to Section B, General Guidance)
- (C) OBJNAM = (EU: designator as it appears on the structure; US: "Name" + (River Mile), e.g., Avoca Island Cutoff Buoy (132.7))
- (O) NOBJNM = (Refer to Section B, General Guidance)
- (M) SCAMIN = [EU: 22000; US: 60000]
- (C) SORDAT = [YYYYMMDD]
- (C) SORIND = (Refer to Section B, General Guidance)

**Coding of Equipment Object**

**Object Class = TOPMAR(P)**

- (M) COLOUR = [3 (red), 4 (green)]
- (M) TOPSHP = [1 (cone, point up), 3 (sphere), 5 (cylinder (can))]
- (C) COLPAT = [1 (horizontal stripes)]
- (M) SCAMIN = [EU: 22000; US: 60000]
- (C) SORDAT = [YYYYMMDD]
- (C) SORIND = (Refer to Section B, General Guidance)

**Object Encoding**

**Object Class = LIGHTS(P)**

- (M) COLOUR = [1 (white), 3 (red), 4 (green), 6 (yellow)]
- (M) EXCLIT = [1 (light shown without change of character), 2 (daytime light), 3 (fog light), 4 (night light)]


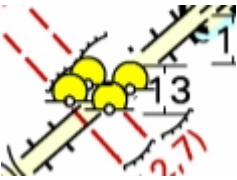

		<p>(M) LITCHR = [1 (fixed), 2 (flashing), 3 (long-flashing), 4 (quick-flashing), 5 (very quick-flashing), 6 (ultra quick flashing), 7 (isophased), 8 (occulting), 9 (interrupted quick-flashing), 10 (interrupted very quick-flashing), 11 (interrupted ultra quick-flashing), 12 (morse), 13 (fixed/flash), 14 (flash/long-flash), 15 (occulting/flash), 16 (fixed/long-flash), 17 (occulting alternating), 18 (long-flash alternating), 19 (flash alternating), 20 (group alternating), 25 (very quick-flash plus long-flash), 26 (very quick-flash plus long-flash), 27 (ultra quick-flash plus long-flash), 28 (alternating), 29 (fixed and alternating flashing)]</p> <p>(C) SIGPER = [xx.xx (e.g. signal period of 12 seconds coded as 12)]</p> <p>(C) SIGGRP = [(x),(x)...], e.g., (), (2), (2+1)</p> <p>(C) SIGSEQ = [L.LL + (E.EE)] (seconds)</p> <p>(M) SCAMIN = [EU: 22000; US: 60000]</p> <p>(C) SORDAT = [YYYYMMDD]</p> <p>(C) SORIND = (Refer to Section B, General Guidance)</p>
--	--	---

# O - Buoys, Beacons and Daymarks, Notice Marks

## O.1 Buoys

### O.1.2 Buoy at Bridge Pillar (M)

A buoy at a bridge pillar may be used to improve the visibility of the pillar location on the radar.

Graphics	Encoding Instructions	Object Encoding
<p><i>Real World</i></p>  <p><i>Chart Symbol</i></p>  <p><i>IENC Symbolization</i></p> 	<p>A) 'boylat' can act as a master object to a light object or to a top mark object.</p> <p>B) Mandatory attributes must be coded to ensure proper presentation</p> <p>C) EU: The designator as it appears on the buoy, if it can be read from a passing vessel, should be encoded in the attribute OBJNAM. Administrative information on the buoys that is not relevant for navigation should be encoded in the attribute NOBJNM. It is not repeated for each slave object.</p> <p>D) EU: If not under the issuing authority, use INFORM to indicate responsibility of operation of the buoy.</p> <p>E) If the system of navigational marks of a special sign is different from the system mentioned in 'm_nsys', or there is no 'm_nsys' object class in the cell, the attribute 'marsys' must be used.</p> <p>F) This feature must be aggregated to a bridge by a C_AGGR object.</p>	<p><b>Object Encoding</b></p> <p><b>Object Class = boylat(P)</b></p> <p>(M) BOYSHP = [1 (conical (nun, ogival)), 2 (can (cylindrical)), 3 (spherical), 4 (pillar), 5 (spar (spindle)), 6 (barrel (tun)), 8 (ice buoy)]</p> <p>(M) catlam = [23 (bridge pier mark)]</p> <p>(M) COLOUR = [6 (yellow)]</p> <p>(C) marsys = [1 (IALA A), 2 (IALA B), 9 (no system), 10 (other system), 11 (CEVNI), 12 (Russian inland waterway regulations), 13 (Brazilian national inland waterway regulations - two sides), 14 (Brazilian national inland waterway regulations - side independent), 15 (Paraguay-Parana waterway - Brazilian complementary aids)]</p> <p>(O) CONRAD = [3 (radar conspicuous (has radar reflector))]</p> <p>(C) OBJNAM = (Refer to letter C)</p> <p>(O) NOBJNM = (Refer to letter C)</p> <p>(O) INFORM = (Refer to letter D)</p> <p>(O) NINFOM = (Refer to Section B, General Guidance)</p> <p>(M) SCAMIN = [EU: 22000; US: 60000]</p> <p>(C) SORDAT = [YYYYMMDD]</p> <p>(C) SORIND = (Refer to Section B, General Guidance)</p> <p><b>Object Encoding</b></p> <p><b>Object Class = LIGHTS(P)</b></p> <p>(M) COLOUR = [1 (white), 3 (red), 4 (green)]</p> <p>(M) EXCLIT = [1 (light shown without change of character), 2 (daytime light), 3 (fog light), 4 (night light)]</p> <p>(M) LITCHR = [1 (fixed), 2 (flashing), 3 (long-flashing), 4 (quick-flashing), 5 (very quick-flashing), 6 (ultra quick flashing), 7 (isophased), 8 (occulting), 9 (interrupted quick-flashing), 10 (interrupted very quick-flashing), 11 (interrupted ultra quick-flashing), 12 (morse), 13 (fixed/flash), 14 (flash/long-flash), 15 (occulting/flash), 16 (fixed/long-flash), 17 (occulting alternating), 18 (long-</p>






		<p>flash alternating), 19 (flash alternating), 20 (group alternating), 25 (very quick-flash plus long-flash), 26 (very quick-flash plus long-flash), 27 (ultra quick-flash plus long-flash), 28 (alternating), 29 (fixed and alternating flashing)]</p> <p>(C) SIGPER = [xx.xx] (e.g. signal period of 12 seconds coded as 12)</p> <p>(C) SIGGRP = [(x),(x)...], e.g., (), (2), (2+1)</p> <p>(C) SIGSEQ = [L.LL + (E.EE)] (seconds)</p> <p>(M) SCAMIN = [EU: 22000; US: 60000]</p> <p>(C) SORDAT = [YYYYMMDD]</p> <p>(C) SORIND = (Refer to Section B, General Guidance)</p>
--	--	--

# O - Buoys, Beacons and Daymarks, Notice Marks

## O.1 Buoys

### O.1.3 Buoy Marking Danger Point (M)

Buoys to indicate the presence of potentially dangerous obstructions such as groynes, banks, or wrecks.

Graphics	Encoding Instructions	Object Encoding
<p><i>Real World</i></p>  <p><i>Chart Symbol</i></p>  <p><i>Chart Symbol</i></p>  <p><i>Chart Symbol</i></p>  <p><i>IENC Symbolization</i></p> 	<p>A) Where top mark is present, use TOPMAR as the slave object and BOYSPP as the master object.</p> <p>B) EU: The designator as it appears on the buoy, if it can be read from a passing vessel, should be encoded in the attribute OBJNAM. Administrative information on the buoys that is not relevant for navigation should be encoded in the attribute NOBJNM. It is not repeated for each slave object.</p> <p>C) In the event there is a light on the day mark, the BOYSPP object should be designated as the master and coded with the name of the light.</p> <p>D) EU: If buoys according to CEVNI are used object class 'boylat' has to be used. BOYSHP/catlam/COLOUR attributes must be used in the following combinations: 5 (spar/spindle) / 16 (danger point or obstacle at the left-hand side) / 1,4,1,4 (white / green) 5 (spar/spindle) / 15 (danger point or obstacle at the right-hand side) / 1,3,1,3 (white / red)</p> <p>E) US: Use INFORM to note the river tender or vessel used to place/set buoy</p> <p>F) EU: If not under the issuing authority, use INFORM to indicate responsibility of operation of the buoy.</p> <p>G) If the system of navigational marks of a special sign is different from the system mentioned in 'm_nsys', or there is no 'm_nsys' object class in the cell, the attribute MARSYS, INFORM or 'marsys' must be used.</p>	<p><b>Object Encoding</b></p> <p><b>Object Class = BOYSPP(P)</b></p> <p>(M) BOYSHP = [1 (conical (nun, ogival)), 2 (can (cylindrical)), 5 (spar (spindle))]</p> <p>(M) CATSPM = [41 (clearing mark), 45 (foul ground mark)]</p> <p>(M) COLOUR = [1 (white), 2 (black), 3 (red), 4 (green)]</p> <p>(M) COLPAT = [1 (horizontal stripes), 2 (vertical stripes), 3 (diagonal stripes), 4 (squared), 5 (stripes (direction unknown)), 6 (border stripe)]</p> <p>(C) MARSYS = [1 (IALA A), 2 (IALA B)]</p> <p>(O) CONRAD = [3 (radar conspicuous (has radar reflector))]</p> <p>(C) OBJNAM = (Refer to letter B)</p> <p>(O) NOBJNM = (Refer to letter B)</p> <p>(O) INFORM = (US: refer to letter E; EU: refer to letter F; EU &amp; RU: refer to letter G)</p> <p>(O) NINFOM = (Refer to Section B, General Guidance)</p> <p>(M) SCAMIN = [EU: 22000; US: 60000]</p> <p>(C) SORDAT = [YYYYMMDD]</p> <p>(C) SORIND = (Refer to Section B, General Guidance)</p> <p><b>alternative (see coding instruction D)</b></p> <p><b>Object Class = boylat(P)</b></p> <p>(M) catlam = [15 (danger point or obstacles at the right-hand side), 16 (danger point or obstacles at the left-hand side)]</p> <p>(M) BOYSHP = [5 (spar (spindle)), 8 (ice buoy)]</p> <p>(M) COLOUR = [1 (white), 3 (red), 4 (green)]</p> <p>(M) COLPAT = [1 (horizontal stripes)]</p> <p>(C) marsys = [1 (IALA A), 2 (IALA B), 9 (no system), 10 (other system), 11 (CEVNI), 12 (Russian inland waterway regulations), 13 (Brazilian national inland waterway regulations - two sides), 14 (Brazilian national</p>

inland waterway regulations - side independent), 15 (Paraguay-Parana waterway - Brazilian complementary aids)]

(O) CONRAD = [3 (radar conspicuous (has radar reflector))]

(C) OBJNAM = (Refer to letter B)

(O) NOBJNM = (Refer to Section B, General Guidance)

(O) INFORM = [US: refer to letter E; EU: refer to letter F]

(O) NINFOM = (Refer to Section B, General Guidance)

(M) SCAMIN = [EU: 22000; US: 60000]

(C) SORDAT = [YYYYMMDD]

(C) SORIND = (Refer to Section B, General Guidance)

#### **Object Encoding**

**Object Class = TOPMAR(P)**

(M) COLOUR = [2 (black), 3 (red), 4 (green)]

(M) TOPSHP = [1 (cone, point up), 2 (cone, point down), 4 (2 spheres), 5 (cylinder (can)), 10 (2 cones, point to point), 24 (triangle, point up), 25 (triangle, point down)]

(M) SCAMIN = [EU: 22000; US: 60000]

(C) SORDAT = [YYYYMMDD]

(C) SORIND = (Refer to Section B, General Guidance)

#### **Object Encoding**

**Object Class = LIGHTS(P)**

(M) COLOUR = [1 (white), 3 (red), 4 (green)]

(M) EXCLIT = [1 (light shown without change of character), 2 (daytime light), 3 (fog light), 4 (night light)]

(M) LITCHR = [1 (fixed), 2 (flashing), 3 (long-flashing), 4 (quick-flashing), 5 (very quick-flashing), 6 (ultra quick flashing), 7 (isophased), 8 (occulting), 9 (interrupted quick-flashing), 10 (interrupted very quick-flashing), 11 (interrupted ultra quick-flashing), 12 (morse), 13 (fixed/flash), 14 (flash/long-flash), 15 (occulting/flash), 16 (fixed/long-flash), 17 (occulting alternating), 18 (long-flash alternating), 19 (flash alternating), 20 (group alternating), 25 (very quick-flash plus long-flash), 26 (very quick-flash plus long-flash), 27 (ultra quick-flash plus long-flash), 28 (alternating), 29 (fixed and alternating flashing)]

(C) SIGPER = [xx.xx (e.g. signal period of 12 seconds coded as 12)]

(C) SIGGRP = [(x),(x)...], e.g., (), (2), (2+1)



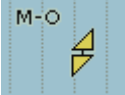

		<p>(C) SIGSEQ = [L.LL + (E.EE)] (seconds) (M) SCAMIN = [EU: 22000; US: 60000] (C) SORDAT = [YYYYMMDD] (C) SORIND = (Refer to Section B, General Guidance)</p>
--	--	---

# O - Buoys, Beacons and Daymarks, Notice Marks

## O.1 Buoys

### O.1.4 Cardinal Buoy (M)

A cardinal buoy is used to mark the position of danger points, obstacles and special features on lakes and broad waterways.

Graphics	Encoding Instructions	Object Encoding
<p><i>Real World</i></p>  <p><i>Chart Symbol</i></p>  <p><i>IENC Symbolization</i></p>  <p><i>IENC Symbolization</i></p> 	<p>A) BOYCAR must act as a master object to a top mark object and light object (if it exists)</p> <p>B) Mandatory attributes must be coded to ensure proper presentation.</p> <p>C) EU: The designator as it appears on the buoy, if it can be read from a passing vessel, should be encoded in the attribute OBJNAM. Administrative information on the buoys that is not relevant for navigation should be encoded in the attribute NOBJNM. It is not repeated for each slave object.</p> <p>D) If the system of navigational marks of a special sign is different from the system mentioned in 'm_nsys', or there is no 'm_nsys' object class in the cell, the attribute MARSYS or INFORM must be used.</p>	<p><b>Object Encoding</b></p> <p><b>Object Class = BOYCAR(P)</b></p> <p>(M) BOYSHP = [1 (conical (nun, ogival)), 4 (pillar), 5 (spar (spindle))]</p> <p>(M) CATCAM = [1 (north cardinal mark), 2 (east cardinal mark), 3 (south cardinal mark), 4 (west cardinal mark)]</p> <p>(M) COLOUR = [2 (black), 6 (yellow)]</p> <p>West: COLOUR=6,2,6 East: COLOUR=2,6,2 North: COLOUR=2,6 South: COLOUR=6,2</p> <p>(M) COLPAT = [1 (horizontal stripes)]</p> <p>(C) MARSYS = [1 (IALA A), 2 (IALA B)]</p> <p>(C) INFORM = (Refer to letter D)</p> <p>(O) NINFOM = (Refer to Section B, General Guidance)</p> <p>(O) CONRAD = [3 (radar conspicuous (has radar reflector))]</p> <p>(C) OBJNAM = (Refer to letter C)</p> <p>(C) NOBJNM = (Refer to letter C)</p> <p>(M) SCAMIN = [EU: 22000; US: 60000]</p> <p>(C) SORDAT = [YYYYMMDD]</p> <p>(C) SORIND = (Refer to Section B, General Guidance)</p> <p><b>Object Encoding</b></p> <p><b>Object Class = TOPMAR(P)</b></p> <p>(M) COLOUR = [2 (black)]</p> <p>(M) TOPSHP = [10 (2 cones, point to point), 11 (2 cones, base to base), 13 (2 cones (points upward)), 14 (2 cones (points downward))]</p> <p>(M) SCAMIN = [EU: 22000; US: 60000]</p> <p>(C) SORDAT = [YYYYMMDD]</p> <p>(C) SORIND = (Refer to Section B, General Guidance)</p>







		<p><b><u>Object Encoding</u></b></p> <p><b>Object Class = LIGHTS(P)</b></p> <p>(M) COLOUR = [1 (white)]</p> <p>(M) EXCLIT = [1 (light shown without change of character), 2 (daytime light), 3 (fog light), 4 (night light)]</p> <p>(M) LITCHR = [3 (long-flashing), 4 (quick-flashing)]</p> <p>(C) SIGPER = [xx.xx] (e.g. signal period of 12 seconds coded as 12)</p> <p>(C) SIGGRP = [(x),(x)...], e.g., (), (2), (2+1)</p> <p>(C) SIGSEQ = [L.LL + (E.EE)] (seconds)</p> <p>(M) SCAMIN = [EU: 22000; US: 60000]</p> <p>(C) SORDAT = [YYYYMMDD]</p> <p>(C) SORIND = (Refer to Section B, General Guidance)</p>
--	--	---

# O - Buoys, Beacons and Daymarks, Notice Marks

## O.1 Buoys

### O.1.5 Lateral Buoy (M)

Lateral buoys are used to mark the direction of the fairway / navigation channel.

Graphics	Encoding Instructions	Object Encoding
<p><i>Real World (Can)</i></p> 	<p>A) EU: The designator as it appears on the buoy, if it can be read from a passing vessel, should be encoded in the attribute OBJNAM. Administrative information on the buoys that is not relevant for navigation should be encoded in the attribute NOBJNM. It is not repeated for each slave object.</p>	<p><b>Object Encoding</b></p> <p><b>Object Class = boylat(P)</b></p> <p>(M) BOYSHP = [1 (conical (nun, ogival)), 2 (can (cylindrical)), 3 (spherical), 4 (pillar), 5 (spar (spindle)), 8 (ice buoy)]</p>
<p><i>Real World (Nun)</i></p> 	<p>B) US: Buoys used on the inland system are not uniquely named or identified.</p> <p>C) EU: In case TOPMAR is added: TOPSHP = 5 (cylinder, can) for right hand side buoys TOPSHP = 1 (cone, up) for left hand side buoys</p>	<p>(M) catlam = [1 (port-hand lateral mark), 2 (starboard-hand lateral mark), 5 (right-hand side of the waterway), 6 (left-hand side of the waterway), 7 (right-hand side of the channel), 8 (left-hand side of the channel), 11 (channel near the right bank), 12 (channel near the left bank), 13 (channel cross-over to the right bank), 14 (channel cross-over to the left bank)]</p> <p>(M) COLOUR = [1 (white), 3 (red), 4 (green), 6 (yellow)]</p>
<p><i>Real World (EU)</i></p> 	<p>D) EU: BOYSHP/catlam/COLOUR attributes must be used in the following combinations: 1 (nun) / 8 (left fairway side) / 4 (green) 2 (can) / 7 (right fairway side) / 3 (red)</p> <p>E) US: BOYSHP/catlam/COLOUR attributes must be used in the following combinations: 1 (nun) / 2 (starboard-hand lateral mark) / 3 (red) 2 (can) / 1 (port-hand lateral mark) / 4 (green)</p>	<p>(C) marsys = [1 (IALA A), 2 (IALA B), 9 (no system), 10 (other system), 11 (CEVNI), 12 (Russian inland waterway regulations), 13 (Brazilian national inland waterway regulations - two sides), 14 (Brazilian national inland waterway regulations - side independent), 15 (Paraguay-Parana waterway - Brazilian complementary aids)]</p> <p>(O) CONRAD = [3 (radar conspicuous (has radar reflector))]</p> <p>(C) OBJNAM = (Refer to letter A)</p> <p>(C) NOBJNM = (Refer to letter A)</p> <p>(C) INFORM = (US: refer to letter F; EU: refer to letter G)</p>
<p><i>Real World (EU)</i></p> 	<p>F) US: Use INFORM to note the river tender or vessel used to place/set buoy</p> <p>G) EU: If not under the issuing authority, use INFORM to indicate responsibility of operation of the buoy.</p> <p>H) If the system of navigational marks of a special sign is different from the system mentioned in 'm_nsys', or there is no 'm_nsys' object class in the cell, the attribute 'marsys' has to</p>	<p>(O) NINFOM = (Refer to Section B, General Guidance)</p> <p>(M) SCAMIN = [EU: 22000; US: 60000]</p> <p>(C) SORDAT = [YYYYMMDD]</p> <p>(C) SORIND = (Refer to Section B, General Guidance)</p> <p><b>Object Encoding</b></p> <p><b>Object Class = TOPMAR(P)</b></p> <p>(M) COLOUR = [3 (red), 4 (green)]</p> <p>(M) TOPSHP = [1 (cone, point up), 5 (cylinder (can))]</p>

Real World (RU)



Chart Symbol

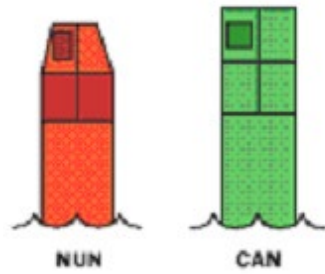
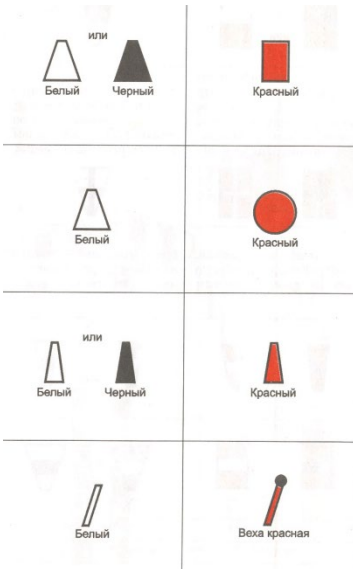


Chart Symbol



Chart Symbol



be used.

- I) 'boylat' must act as master object to a TOPMAR and LIGHTS object (if they exist).
- J) EU: In the Po River, a red buoy represents an obstacle near the right bank. The buoy has to be kept on the right when navigating in the downstream direction and has to be kept on the left when navigating in the upstream direction. COLOUR = [3 (red)]
- K) EU: In the Po River, a white buoy represents an obstacle near the left bank. The buoy has to be kept on the left when navigating in the downstream direction and has to be kept on the right when navigating in the upstream direction. COLOUR = [1 (white)]

(C) COLPAT = [1 (horizontal stripes)]

(C) INFORM = (Refer to letters F and G)

(O) NINFOM = (Refer to Section B, General Guidance)

(M) SCAMIN = [EU: 22000; US: 60000]

(C) SORDAT = [YYYYMMDD]

(C) SORIND = (Refer to Section B, General Guidance)

**Object Encoding**

**Object Class = LIGHTS(P)**

(M) COLOUR = [1 (white), 3 (red), 4 (green), 6 (yellow)]

(M) EXCLIT = [1 (light shown without change of character), 2 (daytime light), 3 (fog light), 4 (night light)]

(M) LITCHR = [1 (fixed), 2 (flashing), 3 (long-flashing), 4 (quick-flashing), 5 (very quick-flashing), 6 (ultra quick flashing), 7 (isophased), 8 (occulting), 9 (interrupted quick-flashing), 10 (interrupted very quick-flashing), 11 (interrupted ultra quick-flashing), 12 (morse), 13 (fixed/flash), 14 (flash/long-flash), 15 (occulting/flash), 16 (fixed/long-flash), 17 (occulting alternating), 18 (long-flash alternating), 19 (flash alternating), 20 (group alternating), 25 (very quick-flash plus long-flash), 26 (very quick-flash plus long-flash), 27 (ultra quick-flash plus long-flash), 28 (alternating), 29 (fixed and alternating flashing)]

(C) SIGPER = [xx.xx (e.g. signal period of 12 seconds coded as 12)]

(C) SIGGRP = [(x),(x)...], e.g., (), (2), (2+1)

(C) SIGSEQ = [L.LL + (E.EE)] (seconds)

(M) SCAMIN = [EU: 22000; US: 60000]

(C) SORDAT = [YYYYMMDD]

(C) SORIND = (Refer to Section B, General Guidance)

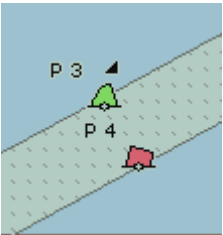
*IENC Symbolization*

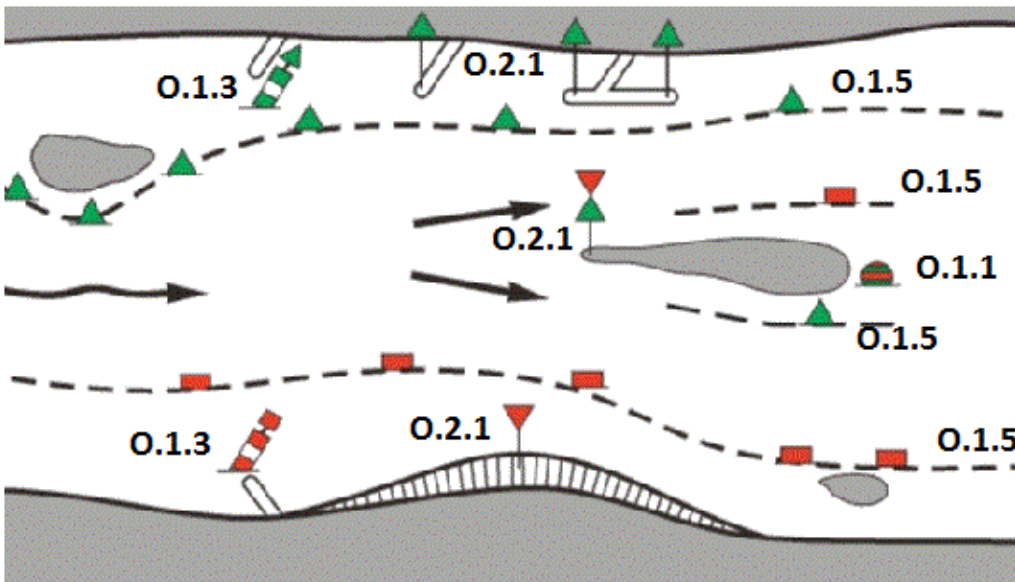


*IENC Symbolization*



*IENC Symbolization*




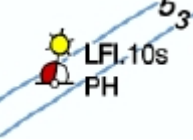
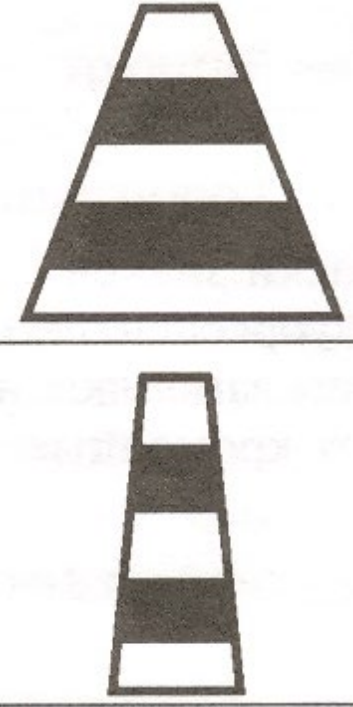


# O - Buoys, Beacons and Daymarks, Notice Marks

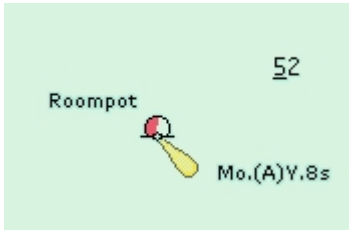
## O.1 Buoys

### O.1.6 Safe Water Buoy (M)

A safe water buoy marking the axis or middle of a channel may be used as a centerline, mid-channel on lakes and broad waterways

Graphics	Encoding Instructions	Object Encoding
<p><i>Real World</i></p>  <p><i>Chart Symbol</i></p>  <p><i>Chart Symbol</i></p> 	<p>A) BOYSAW can act as a master object to a top mark object and a light object</p> <p>B) EU: The designator as it appears on the buoy, if it can be read from a passing vessel, should be encoded in the attribute OBJNAM. Administrative information on the buoys that is not relevant for navigation should be encoded in the attribute NOBJNM. It is not repeated for each slave object.</p> <p>C) Mandatory attributes must be coded to ensure proper presentation</p> <p>D) In case TOPMAR is added: TOPSHP = 3 (sphere) and COLOUR = (3 (red))</p> <p>E) If the system of navigational marks of a special sign is different from the system mentioned in 'm_nsys', or there is no 'm_nsys' object class in the cell, the attribute MARSYS or INFORM must be used.</p>	<p><b>Object Encoding</b></p> <p><b>Object Class = BOYSAW(P)</b></p> <p>(M) BOYSHP = [1 (conical (nun, ogival)), 3 (spherical), 4 (pillar), 5 (spar (spindle))]</p> <p>(M) COLOUR = [1 (white), 2 (black), 3 (red)]</p> <p>(M) COLPAT = [1 (horizontal stripes), 2 (vertical stripes)]</p> <p>(C) MARSYS = [1 (IALA A), 2 (IALA B)]</p> <p>(C) INFORM = (Refer to letter E)</p> <p>(O) NINFOM = (Refer to Section B, General Guidance)</p> <p>(O) CONRAD = [3 (radar conspicuous (has radar reflector))]</p> <p>(C) OBJNAM = (Refer to letter B)</p> <p>(O) NOBJNM = (Refer to letter B)</p> <p>(M) SCAMIN = [EU: 22000; US: 60000]</p> <p>(C) SORDAT = [YYYYMMDD]</p> <p>(C) SORIND = (Refer to Section B, General Guidance)</p> <p><b>Object Encoding</b></p> <p><b>Object Class = TOPMAR(P)</b></p> <p>(M) COLOUR = [3 (red)]</p> <p>(M) TOPSHP = [3 (sphere)]</p> <p>(M) SCAMIN = [EU: 22000; US: 60000]</p> <p>(C) SORDAT = [YYYYMMDD]</p> <p>(C) SORIND = (Refer to Section B, General Guidance)</p> <p><b>Object Encoding</b></p> <p><b>Object Class = LIGHTS(P)</b></p> <p>(M) COLOUR = [1 (white), 6 (yellow)]</p> <p>(M) EXCLIT = [1 (light shown without change of character), 2 (daytime light), 3 (fog light), 4 (night light)]</p> <p>(M) LITCHR = [1 (fixed), 2 (flashing), 3 (long-flashing), 4 (quick-flashing), 5 (very quick-flashing), 6 (ultra quick flashing), 7 (isophased), 8 (occluding), 9 (interrupted)]</p>

*IENC Symbolization*



quick-flashing), 10 (interrupted very quick-flashing), 11 (interrupted ultra quick-flashing), 12 (morse), 13 (fixed/flash), 14 (flash/long-flash), 15 (occulting/flash), 16 (fixed/long-flash), 17 (occulting alternating), 18 (long-flash alternating), 19 (flash alternating), 20 (group alternating), 25 (very quick-flash plus long-flash), 26 (very quick-flash plus long-flash), 27 (ultra quick-flash plus long-flash), 28 (alternating), 29 (fixed and alternating flashing)]

(C) SIGPER = [xx.xx] (e.g. signal period of 12 seconds coded as 12)

(C) SIGGRP = [(x),(x)...], e.g., (), (2), (2+1)

(C) SIGSEQ = [L.LL + (E.EE)] (seconds)

(M) SCAMIN = [EU: 22000; US: 60000]

(C) SORDAT = [YYYYMMDD]



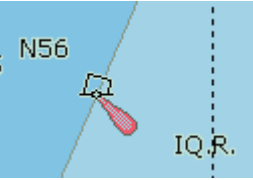
(C) SORIND = (Refer to Section B, General Guidance)

# O - Buoys, Beacons and Daymarks, Notice Marks

## O.1 Buoys

### O.1.7 Stalling Buoy (M)

The buoys (floating beacons) are used to mark stalling current which does not coincide with a direction of the fairway

Graphics	Encoding Instructions	Object Encoding
<p><i>Chart Symbol</i></p>  <p><i>Chart Symbol</i></p>  <p><i>IENC Symbolization</i></p> 	<p>A) BOYLAT must be defined as the master object, with and LIGHTS as the slave objects</p> <p>B) If the system of navigational marks of a special sign is different from the system mentioned in 'm_nsys', or there is no 'm_nsys' object class in the cell, the attribute MARSYS or INFORM must be used.</p>	<p><b>Object Encoding</b></p> <p><b>Object Class = BOYLAT(P)</b></p> <p>(M) BOYSHP = [1 (conical (nun, ogival)), 2 (can (cylindrical))]</p> <p>(M) CATLAM = [1 (port-hand lateral mark), 2 (starboard-hand lateral mark)]</p> <p>(M) COLOUR = [3, 2 (red, black), 3, 1 (red, white), 1, 2 (white, black)]</p> <p>(M) COLPAT = [1 (horizontal stripes)]</p> <p>(C) MARSYS = [1 (IALA A), 2 (IALA B)]</p> <p>(C) INFORM = (Refer to letter B)</p> <p>(O) NINFOM = (Refer to Section B, General Guidance)</p> <p>(O) OBJNAM = (buoy number)</p> <p>(O) NOBJNM = (Refer to Section B, General Guidance)</p> <p>(M) SCAMIN = [EU: 22000; US: 60000]</p> <p>(C) SORDAT = [YYYYMMDD]</p> <p>(C) SORIND = (Refer to Section B, General Guidance)</p> <p><b>Object Encoding</b></p> <p><b>Object Class = LIGHTS(P)</b></p> <p>(M) COLOUR = [3 (red), 4 (green)]</p> <p>(M) LITCHR = [2 (flashing), 9 (interrupted quick-flashing)]</p> <p>(M) SIGGRP = [4]</p> <p>(M) SCAMIN = [EU: 22000; US: 60000]</p> <p>(C) SORDAT = [YYYYMMDD]</p> <p>(C) SORIND = (Refer to Section B, General Guidance)</p>

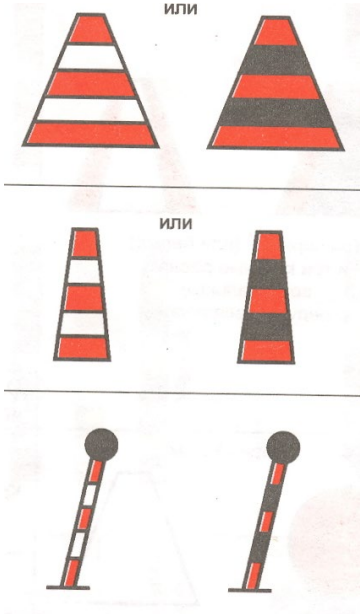
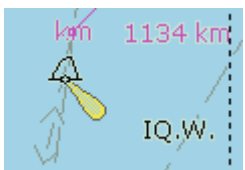


# O - Buoys, Beacons and Daymarks, Notice Marks

## O.1 Buoys

### O.1.8 Swinging Axial Buoy (M)

The buoys are used to mark swinging points of the fairway axis






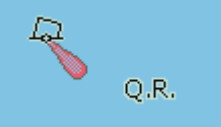
Graphics	Encoding Instructions	Object Encoding
<p><i>Chart Symbol</i></p>  <p><i>IENC Symbolization</i></p> 	<p>A) BOYSAW must be defined as the master object, with TOPMAR and LIGHTS as the slave objects</p> <p>B) If the system of navigational marks of a special sign is different from the system mentioned in 'm_nsys', or there is no 'm_nsys' object class in the cell, the attribute MARSYS or INFORM must be used.</p>	<p><b>Object Encoding</b></p> <p><b>Object Class = BOYSAW(P)</b></p> <p>(M) BOYSHP = [1 (conical (nun, ogival)), 5 (spar (spindle))]</p> <p>(M) COLOUR = [3, 2, 3, 2, 3 (red, black, red, black, red), 3, 1, 3, 1, 3 (red, white, red, white, red)]</p> <p>(M) COLPAT = [1 (horizontal stripes)]</p> <p>(C) MARSYS = [1 (IALA A), 2 (IALA B)]</p> <p>(C) INFORM = (Refer to letter B)</p> <p>(O) NINFOM = (Refer to Section B, General Guidance)</p> <p>(O) OBJNAM = (buoy number)</p> <p>(O) NOBJNM = (Refer to Section B, General Guidance)</p> <p>(M) SCAMIN = [EU: 22000; US: 60000]</p> <p>(C) SORDAT = [YYYYMMDD]</p> <p>(C) SORIND = (Refer to Section B, General Guidance)</p> <p><b>Object Encoding</b></p> <p><b>Object Class = LIGHTS(P)</b></p> <p>(M) COLOUR = [1 (white)]</p> <p>(M) LITCHR = [9 (interrupted quick-flashing)]</p> <p>(M) SIGGRP = [4]</p> <p>(M) SCAMIN = [EU: 22000; US: 60000]</p> <p>(C) SORDAT = [YYYYMMDD]</p> <p>(C) SORIND = (Refer to Section B, General Guidance)</p> <p><b>Object Encoding</b></p> <p><b>Object Class = TOPMAR(P)</b></p> <p>(M) TOPSHP = [26 (circle)]</p> <p>(O) COLOUR = [2 (black)]</p> <p>(M) SCAMIN = [EU: 22000; US: 60000]</p> <p>(C) SORDAT = [YYYYMMDD]</p> <p>(C) SORIND = (Refer to Section B, General Guidance)</p>

# O - Buoys, Beacons and Daymarks, Notice Marks

## O.1 Buoys

### O.1.9 Swinging Lateral Buoy (M)

The buoys are used to mark swinging points at the edges of the extended rectilinear fairways, as well as at the fairway edges where the vision is limited.


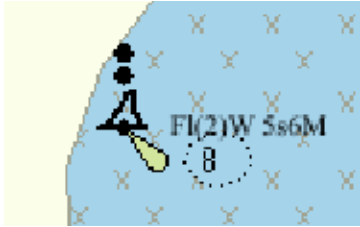
Graphics	Encoding Instructions	Object Encoding
<p><i>Chart Symbol</i></p>  <hr/>  <p><i>Chart Symbol</i></p>  <hr/>  <p><i>IENC Symbolization</i></p>  <p><i>IENC Symbolization</i></p> 	<p>A) BOYLAT must be defined as the master object, with LIGHTS as the slave object</p> <p>B) If the system of navigational marks of a special sign is different from the system mentioned in 'm_nsys', or there is no 'm_nsys' object class in the cell, the attribute MARSYS or INFORM must be used.</p>	<p><b>Object Encoding</b></p> <p><b>Object Class = BOYLAT(P)</b></p> <p>(M) BOYSHP = [1 (conical (nun, ogival)), 2 (can (cylindrical))]</p> <p>(M) CATLAM = [1 (port-hand lateral mark), 2 (starboard-hand lateral mark)]</p> <p>(M) COLOUR = [1, 2, 1 (white, black, white), 2, 1, 2 (black, white, black), 3, 1, 3, (red, white, red), 3, 2, 3, (red, black, red)]</p> <p>(M) COLPAT = [1 (horizontal stripes)]</p> <p>(C) MARSYS = [1 (IALA A), 2 (IALA B)]</p> <p>(O) INFORM = (Refer to letter B)</p> <p>(O) NINFOM = (Refer to Section B, General Guidance)</p> <p>(M) SCAMIN = [EU: 22000; US: 60000]</p> <p>(C) SORDAT = [YYYYMMDD]</p> <p>(C) SORIND = (Refer to Section B, General Guidance)</p> <p><b>Object Encoding</b></p> <p><b>Object Class = LIGHTS(P)</b></p> <p>(M) COLOUR = [1 (white), 3 (red), 4 (green), 6 (yellow)]</p> <p>(M) LITCHR = [2 (flashing), 4 (quick-flashing)]</p> <p>(M) SCAMIN = [EU: 22000; US: 60000]</p> <p>(C) SORDAT = [YYYYMMDD]</p> <p>(C) SORIND = (Refer to Section B, General Guidance)</p>

# O - Buoys, Beacons and Daymarks, Notice Marks

## O.1 Buoys

### O.1.10 Isolated Danger Buoy (M)

An isolated danger buoy is used in Brazilian rivers to mark the position of a danger of limited extent, which has navigable water all around it.

Graphics	Encoding Instructions	Object Encoding
<p><i>Chart Symbol</i></p>  <p><i>IENC Symbolization</i></p> 	<p>A) BOYISD must act as a master object to a top mark object and light object (if it exists).</p> <p>B) If there is any complementary characteristic on the buoy body or top mark, it should be described in the attribute INFORM.</p> <p>C) In the event there is a light on the buoy, the BOYISD object should be designated as the master and coded with the name of the light.</p> <p>D) BR: The Brazilian national number of the buoy (if it exists) should be encoded in the attribute NOBJNM. It is not repeated for each slave object.</p>	<p><b>Object Encoding</b></p> <p><b>Object Class = BOYISD(P)</b></p> <p>(M) BOYSHP = [4 (pillar), 5 (spar (spindle))]</p> <p>(M) COLOUR = [2 (black), 3 (red)]</p> <p>(M) COLPAT = [1 (horizontal stripes)]</p> <p>(C) INFORM = (Refer to letter B)</p> <p>(O) NINFOM = (Refer to Section B, General Guidance)</p> <p>(O) CONRAD = [3 (radar conspicuous (has radar reflector))]</p> <p>(C) OBJNAM = (Refer to letter C)</p> <p>(C) NOBJNM = (Refer to letter D)</p> <p>(M) SCAMIN = [BR: 50000]</p> <p>(C) SORDAT = [YYYYMMDD]</p> <p>(C) SORIND = (Refer to Section B, General Guidance)</p> <p><b>Object Encoding</b></p> <p><b>Object Class = TOPMAR(P)</b></p> <p>(M) COLOUR = [2 (black)]</p> <p>(M) TOPSHP = [4 (2 spheres)]</p> <p>(C) INFORM = (Refer to letter B)</p> <p>(O) NINFOM = (Refer to Section B, General Guidance)</p> <p>(M) SCAMIN = [BR: 50000]</p> <p>(C) SORDAT = [YYYYMMDD]</p> <p>(C) SORIND = (Refer to Section B, General Guidance)</p> <p><b>Object Encoding</b></p> <p><b>Object Class = LIGHTS(P)</b></p> <p>(M) COLOUR = [1 (white)]</p> <p>(M) EXCLIT = [1 (light shown without change of character), 2 (daytime light), 3 (fog light), 4 (night light)]</p> <p>(M) LITCHR = [2 (flashing)]</p> <p>(C) SIGPER = [xx.xx] (e.g. signal period of 12 seconds, coded as 12)</p>


		<p>(C) SIGGRP = [(x),(x)...], e.g., (), (2), (2+1)</p> <p>(C) SIGSEQ = [L.LL + (E.EE)] (seconds)</p> <p>(M) SCAMIN = [BR: 50000]</p> <p>(C) SORDAT = [YYYYMMDD]</p> <p>(C) SORIND = (Refer to Section B, General Guidance)</p>
--	--	--













# O - Buoys, Beacons and Daymarks, Notice Marks

## O.1 Buoys

### O.1.11 Virtual AIS Aids to Navigation (O)

An aid to navigation which is being transmitted from a remote site to appear to be coming from a physically non-existent aid to navigation.

Graphics	Encoding Instructions	Object Encoding
<p><i>IENC Symbolization</i></p> 	<p>A) For reasons of backward compatibility the mandatory attribute INFORM must contain the values of CLSNAM and CLSDEF for the object; e.g. "Virtual AIS AtoN Port lateral (IALA B); A virtual object marking the port side of a channel" for a Virtual AIS aid to navigation performing the function of a Port Lateral mark.</p> <p>B) Where known the attribute OBJNAM should be populated with the MMSI number of the Virtual AIS aid to navigation, in addition to its individual name.</p> <p>C) Virtual AIS aids to navigation should only be encoded where it is known that the Virtual aid is intended to be permanent, or deployed for a specified fixed period. Where it is known that a Virtual AIS aid to navigation is moved or withdrawn on a regular basis and/or at short notice, such that implementing these changes through the application of ENC Updates is impractical, the Virtual aid should not be encoded.</p>	<p><b>Object Encoding</b></p> <p><b>Object Class = NEWOBJ(P)</b></p> <p>(M) CLSNAM = (Refer to Diagram below)</p> <p>(M) CLSDEF = (Refer to Diagram below)</p> <p>(M) SYMINS = (Refer to Diagram below)</p> <p>(M) INFORM = (Refer to letter A)</p> <p>(O) NINFOM = (Refer to Section B, General Guidance)</p> <p>(C) OBJNAM = (Refer to letter B)</p> <p>(O) NOBJNM = (Refer to Section B, General Guidance)</p> <p>(M) SCAMIN = [US: 60000]</p> <p>(C) SORDAT = [YYYYMMDD]</p> <p>(C) SORIND = (Refer to Section B, General Guidance)</p>

<u>Purpose of Virtual Aid</u>	<u>CLSDEF</u>	<u>CLSNAM</u>	<u>SYMINS</u>	<u>PORTRAYAL</u>
North Cardinal	A Virtual object which indicates navigable water lies northwards	Virtual AtoN, North Cardinal	SY(BRTHNO01);SY(BCNCAR01); TX('V-AIS',3,2,2,'15110',2,0,CHMGD,11)	 V-AIS
East Cardinal	A Virtual object which indicates navigable water lies eastwards	Virtual AtoN, East Cardinal	SY(BRTHNO01);SY(BCNCAR02); TX('V-AIS',3,2,2,'15110',2,0,CHMGD,11)	 V-AIS
South Cardinal	A Virtual object which indicates navigable water lies southwards	Virtual AtoN, South Cardinal	SY(BRTHNO01);SY(BCNCAR03); TX('V-AIS',3,2,2,'15110',2,0,CHMGD,11)	 V-AIS
West Cardinal	A Virtual object which indicates navigable water lies westwards	Virtual AtoN, West Cardinal	SY(BRTHNO01);SY(BCNCAR04); TX('V-AIS',3,2,2,'15110',2,0,CHMGD,11)	 V-AIS
Port lateral (IALA A)	A Virtual object marking the port side of a channel	Virtual AtoN, Port Lateral	SY(BRTHNO01);SY(BOYLAT24); TX('V-AIS',3,2,2,'15110',2,0,CHMGD,11)	 V-AIS
Starboard Lateral (IALA A)	A Virtual object marking the starboard side of a channel	Virtual AtoN, Starboard Lateral	SY(BRTHNO01);SY(BOYLAT13); TX('V-AIS',3,2,2,'15110',2,0,CHMGD,11)	 V-AIS
Port lateral (IALA B)	A Virtual object marking the port side of a channel	Virtual AtoN, Port Lateral	SY(BRTHNO01);SY(BOYLAT23); TX('V-AIS',3,2,2,'15110',2,0,CHMGD,11)	 V-AIS
Starboard Lateral (IALA B)	A Virtual object marking the starboard side of a channel	Virtual AtoN, Starboard Lateral	SY(BRTHNO01);SY(BOYLAT14); TX('V-AIS',3,2,2,'15110',2,0,CHMGD,11)	 V-AIS
Isolated Danger	A Virtual object marking an isolated danger	Virtual AtoN, Isolated Danger	SY(BRTHNO01);SY(BCNISD21); TX('V-AIS',3,2,2,'15110',2,0,CHMGD,11)	 V-AIS
Safe Water	A Virtual object marking safe water	Virtual AtoN, Safe Water	SY(BRTHNO01);SY(BOYSAW12); TX('V-AIS',3,2,2,'15110',2,0,CHMGD,11)	 V-AIS
Special Purpose	A Virtual object used to mark an area or feature referred to in nautical documents	Virtual AtoN, Special Purpose	SY(BRTHNO01);SY(BOYSPP11); TX('V-AIS',3,2,2,'15110',2,0,CHMGD,11)	 V-AIS
Emergency Wreck Marking	A Virtual object marking a wreck	Virtual AtoN, Wreck Marking	SY(BRTHNO01);SY(BOYSPP11); TX('V-AIS',3,2,2,'15110',2,0,CHMGD,11)	 V-AIS

# O - Buoys, Beacons and Daymarks, Notice Marks

## O.2 Beacons & Daymarks

### O.2.1 Day Mark (M)

Day marks are used to code passing and crossing day beacons on the inland river system.



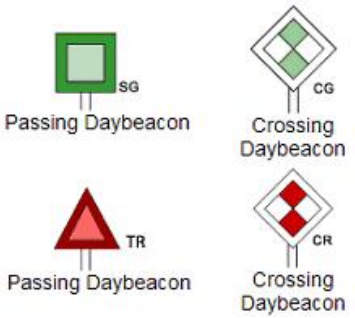
Graphics	Encoding Instructions	Object Encoding
<p><i>Real World (US)</i></p> 	<p>A) 'bcnlst' must be defined as the master object, with DAYMAR/daymar as the slave object.</p> <p>B) In the event there is a light on the day mark, the 'bcnlst' object should be designated as the master and coded with the name of the light.</p> <p>C) EU: For marks indicating the position of the channel the DAYMAR/daymar COLOUR/ COLPAT/ TOPSHP attributes must be used in the following combinations:</p> <p>1, 3, 1 (white, red, white), 1 (horizontal stripes) and 19 (square) for the right hand shore or 4, 1 (green, white), 1 (horizontal stripes) and 12 (rhombus (diamond)) for the left hand shore.</p>	<p><b>Coding of Structure Object</b></p> <p><b>Object Class = bcnlst(P)</b></p> <p>(M) BCNSHP = [1 (stake, pole, perch, post), 5 (pile beacon)]</p> <p>(M) catlam = [1 (port-hand lateral mark), 2 (starboard-hand lateral mark), 5 (right-hand side of the waterway), 6 (left-hand side of the waterway), 7 (right-hand side of the channel), 8 (left-hand side of the channel), 9 (bifurcation of the waterway), 11 (channel near the right bank), 12 (channel near the left bank), 13 (channel cross-over to the right bank), 14 (channel cross-over to the left bank), 15 (danger point or obstacles at the right-hand side), 16 (danger point or obstacles at the left-hand side), 24 (entry from a lake to a narrower waterway, right bank), 25 (entry from a lake to a narrower waterway, left bank)]</p> <p>(C) dirimp = [1 (upstream), 2 (downstream), 3 (to the left bank), 4 (to the right bank)]</p>
<p><i>Real World (CEVNI)</i></p> 	<p>D) EU: For marks indicating danger points DAYMAR ('daymar') COLOUR/ TOPSHP attributes must be used in the following combinations: 3 (red) and 2 (cone, point down) for the right hand shore or 4 (green) and 1 (cone, point up) for the left hand shore</p> <p>E) EU: The designator as it appears on the 'bcnlst', if it can be read from a passing vessel, should be encoded in the attribute OBJNAM. Administrative information on the buoys that is not relevant for navigation should be encoded in the attribute NOBJNM. It is not repeated for each slave object.</p>	<p>(M) COLOUR = ["Unknown" or 1 (white), 3 (red), 4 (green), ]</p> <p>(C) COLPAT = [1 (horizontal stripes), 2 (vertical stripes), 3 (diagonal stripes), 4 (squared), 5 (stripes (direction unknown)), 6 (border stripe)]</p> <p>(M) OBJNAM = (EU: refer to letter E; US: refer to letter H)</p> <p>(O) NOBJNM = (Refer to Section B, General Guidance)</p> <p>(O) CONDTN = [1 (under construction), 2 (ruined), 3 (under reclamation), 5 (planned construction)]</p>
<p><i>Chart Symbol (Version 1)</i></p> 	<p>F) US: For daybeacons with more than one color, such as a crossing or non-laterally significant day beacon, use multiple COLOUR attributes and populate the COLPAT field based upon the color pattern of the day beacon. For example, a NR daybeacon would be encoded as COLOUR = 1,3 with TOPSHP = 12 (rhombus(diamond)), and COLPAT</p>	<p>(M) SCAMIN = [EU: 22000; US: 60000]</p> <p>(C) SORDAT = [YYYYMMDD]</p> <p>(C) SORIND = (Refer to Section B, General Guidance)</p> <p><b>Coding of Equipment Object</b></p> <p><b>Object Class = DAYMAR(P)</b></p> <p>(M) COLOUR = [1 (white), 2 (black), 3 (red), 4 (green), 6 (yellow)]</p> <p>(M) TOPSHP = [1 (cone, point up), 2 (cone,</p>

Chart Symbol

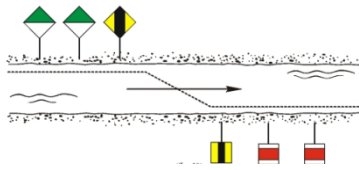


Chart Symbol

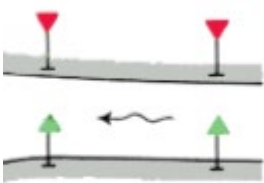


Chart Symbol

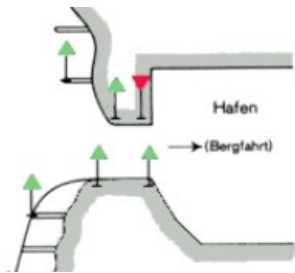
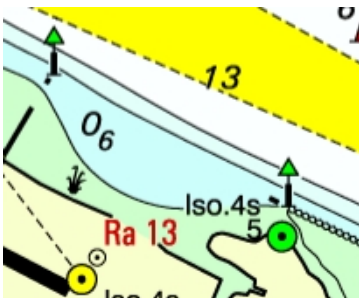


Chart Symbol



Chart Symbol



= 4 (squared).

- G) Code two daymar objects at the same location if two different day marks are present. Use 'dirimp' to designate whether the daymar impacts up-bound or down-bound traffic. If only 1 day mark is present but only impacts one direction, 'dirimp' should also be used.
- H) US: OBJNAM of 'bcnlat' must be the name designated by the US Coast Guard Light List followed by the river mile, e.g, Debutte Light and Daymark (233.4). OBJNAM should not be repeated for each slave object.
- I) If two 'daymar' objects are at the same location, as in letter G, for the daymark that is visible to up-bound vessels code ORIENT to indicate the heading of an up-bound vessel parallel to the riverbank (North = 0 degrees) and for the daymark that is visible to down-bound vessels code ORIENT to indicate the heading of a down-bound vessel parallel to the riverbank.

point down), 7 (x-shape (St. Andrew's cross)), 8 (upright cross (St George's cross)), 10 (2 cones, point to point), 12 (rhombus (diamond)), 19 (square), 24 (triangle, point up), 25 (triangle, point down), 33 (other shape (see INFORM))]

(M) COLPAT = [1 (horizontal stripes), 2 (vertical stripes), 3 (diagonal stripes), 4 (squared), 5 (stripes (direction unknown)), 6 (border stripe)]

(C) INFORM = (Refer to TOPSHP above)

(O) NINFOM = (Refer to Section B, General Guidance)

(O) CONDTN = [1 (under construction), 2 (ruined), 3 (under reclamation), 5 (planned construction)]

(M) SCAMIN = [EU: 22000; US: 60000]

(C) SORDAT = [YYYYMMDD]

(C) SORIND = (Refer to Section B, General Guidance)

**Coding of Equipment Object**

**Object Class = daymar(P)**

(M) COLOUR = [1 (white), 3 (red), 4 (green), 6 (yellow)]

(M) TOPSHP = [1 (cone, point up), 2 (cone, point down), 7 (x-shape (St. Andrew's cross)), 8 (upright cross (St George's cross)), 10 (2 cones, point to point), 12 (rhombus (diamond)), 19 (square), 24 (triangle, point up), 25 (triangle, point down), 33 (other shape (see INFORM))]

(C) COLPAT = [1 (horizontal stripes), 2 (vertical stripes), 3 (diagonal stripes), 4 (squared), 5 (stripes (direction unknown)), 6 (border stripe)]

(C) INFORM = (Refer to TOPSHP above)

(O) NINFOM = (Refer to Section B, General Guidance)

(C) dirimp = [1 (upstream), 2 (downstream), 3 (to the left bank), 4 (to the right bank)]

(C) ORIENT = [xxx or (UNKNOWN)] (degree (°)), e.g., 110

(O) CONDTN = [1 (under construction), 2 (ruined), 3 (under reclamation), 5 (planned construction)]

(M) SCAMIN = [EU: 22000; US: 60000]

(C) SORDAT = [YYYYMMDD]

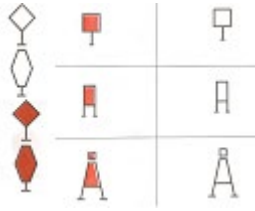
(C) SORIND = (Refer to Section B, General Guidance)

**Object Encoding**

**Object Class = LIGHTS(P)**



**Chart Symbol**



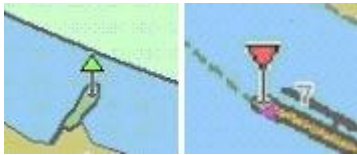
**IENC Symbolization**



**IENC Symbolization**



**IENC Symbolization**





- (M) COLOUR = [1 (white), 3 (red), 4 (green)]
- (O) EXCLIT = [1 (light shown without change of character), 2 (daytime light), 3 (fog light), 4 (night light)]
- (M) LITCHR = [1 (fixed), 2 (flashing), 3 (long-flashing), 4 (quick-flashing), 5 (very quick-flashing), 6 (ultra quick flashing), 7 (isophased), 8 (occulting), 9 (interrupted quick-flashing), 10 (interrupted very quick-flashing), 11 (interrupted ultra quick-flashing), 12 (morse), 13 (fixed/flash), 14 (flash/long-flash), 15 (occulting/flash), 16 (fixed/long-flash), 17 (occulting alternating), 18 (long-flash alternating), 19 (flash alternating), 20 (group alternating), 25 (very quick-flash plus long-flash), 26 (very quick-flash plus long-flash), 27 (ultra quick-flash plus long-flash), 28 (alternating), 29 (fixed and alternating flashing)]
- (C) SIGPER = [xx.xx] (e.g., signal period of 12 seconds coded as 12)
- (C) SIGGRP = [(x),(x)...], e.g., (), (2), (2+1)
- (C) SIGSEQ = [L.LL + (E.EE)] (seconds)
- (C) INFORM = (US: descending bank (e.g., LDB))
- (O) CONDTN = [1 (under construction), 2 (ruined), 3 (under reclamation), 5 (planned construction)]
- (M) SCAMIN = [EU: 22000; US: 60000]
- (C) SORDAT = [YYYYMMDD]
- (C) SORIND = (Refer to Section B, General Guidance)

# O - Buoys, Beacons and Daymarks, Notice Marks

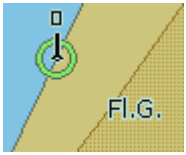
## O.2 Beacons & Daymarks

### O.2.2 Landmark Beacon (M)

The beacons are used to mark specific "Landmarks"

Graphics	Encoding Instructions	Object Encoding
<p><i>Chart Symbol</i></p> 	<p>A) BCNLAT must be defined as the master object, with TOPMAR and LIGHTS as the slave objects</p>	<p><b>Object Encoding</b></p> <p><b>Object Class = BCNLAT()</b></p> <p>(M) BCNSHP = [1 (stake, pole, perch, post)]</p> <p>(M) CATLAM = [1 (port-hand lateral mark), 2 (starboard-hand lateral mark)]</p> <p>(M) COLOUR = [2, 1, 2, 1, 2 (white, black, white, black, white), 3, 1, 3, 1, 3 (red, white, red, white, red)]</p> <p>(M) COLPAT = [1 (horizontal stripes)]</p> <p>(O) CONDTN = [1 (under construction), 2 (ruined), 3 (under reclamation), 5 (planned construction)]</p> <p>(M) SCAMIN = [EU: 22000; US: 60000]</p> <p>(C) SORDAT = [YYYYMMDD]</p> <p>(C) SORIND = (Refer to Section B, General Guidance)</p>
<p><i>Chart Symbol</i></p> 		<p><b>Object Encoding</b></p> <p><b>Object Class = TOPMAR(P)</b></p> <p>(M) TOPSHP = [21 (rectangle, vertical), 22 (trapezium, up)]</p> <p>(O) COLOUR = [2, 1, 2, 1, 2 (white, black, white, black, white), 3, 1, 3, 1, 3 (red, white, red, white, red)]</p> <p>(O) COLPAT = [1 (horizontal stripes)]</p> <p>(O) CONDTN = [1 (under construction), 2 (ruined), 3 (under reclamation), 5 (planned construction)]</p> <p>(M) SCAMIN = [EU: 22000; US: 60000]</p> <p>(C) SORDAT = [YYYYMMDD]</p> <p>(C) SORIND = (Refer to Section B, General Guidance)</p> <p><b>Object Encoding</b></p> <p><b>Object Class = LIGHTS(P)</b></p> <p>(M) COLOUR = [1 (white), 3 (red), 4 (green), 6 (yellow)]</p> <p>(M) LITCHR = [2 (flashing)]</p> <p>(M) SIGGRP = [2]</p> <p>(O) CONDTN = [1 (under construction), 2</p>

*IENC Symbolization*



(ruined), 3 (under reclamation), 5 (planned construction)]

(M) SCAMIN = [EU: 22000; US: 60000]

(C) SORDAT = [YYYYMMDD]




(C) SORIND = (Refer to Section B, General Guidance)

# O - Buoys, Beacons and Daymarks, Notice Marks

## O.2 Beacons & Daymarks

### O.2.3 Radar Beacon, RACON (M)

A radar transponder beacon (racon) may be used to indicate an entrance of a canal or a bridge passage.



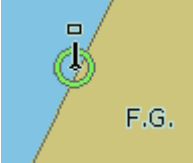

Graphics	Encoding Instructions	Object Encoding
<p><i>Real World</i></p>  <p><i>Chart Symbol</i></p>  <p><i>IENC Symbolization</i></p> 	<p>A) RTPBCN may be slave object to PILPNT, BOYLAT, BOYSPP, BOYCAR, BOYSAW.</p> <p>B) The signal group is encoded using brackets to separate the individual groups. A group of signals may be a single number, a chain of numbers separated by "+", a sequence of up to 4 letters or a letter and a number.</p> <p>C) RADWAL and SIGGRP are relevant for the safety of navigation and should be encoded therefore.</p>	<p><b>Object Encoding</b></p> <p><b>Object Class = RTPBCN(P)</b></p> <p>(M) CATRTB = [1 (ramark, radar beacon transmitting continuously), 2 (racon, radar transponder beacon), 3 (leading racon/radar transponder beacon)]</p> <p>(O) RADWAL = (The wavelength (V) (metres) and the band code character (B)), e.g., V.VV-B</p> <p>(O) SIGGRP = [A]</p> <p>(O) CONDTN = [1 (under construction), 2 (ruined), 3 (under reclamation), 5 (planned construction)]</p> <p>(M) SCAMIN = [EU: 22000; US: 60000]</p> <p>(C) SORDAT = [YYYYMMDD]</p> <p>(C) SORIND = (Refer to Section B, General Guidance)</p>

# O - Buoys, Beacons and Daymarks, Notice Marks

## O.2 Beacons & Daymarks

### O.2.4 Spring Flood Beacon (M)

The beacons are used to mark submerged banks

Graphics	Encoding Instructions	Object Encoding
<p><i>Chart Symbol</i></p>  <p><i>Chart Symbol</i></p>  <p><i>IENC Symbolization</i></p>  <p><i>IENC Symbolization</i></p> 	<p>A) BCNLAT must be defined as the master object, with TOPMAR and LIGHTS as the slave objects</p>	<p><b>Object Encoding</b></p> <p><b>Object Class = BCNLAT(P)</b></p> <p>(M) BCNSHP = [1 (stake, pole, perch, post)]</p> <p>(M) CATLAM = [1 (port-hand lateral mark), 2 (starboard-hand lateral mark)]</p> <p>(M) COLOUR = [1 (white), 3 (red)]</p> <p>(O) INFORM = (Spring flood mark of the left (right) bank)</p> <p>(O) NINFOM = (Refer to Section B, General Guidance)</p> <p>(O) CONDTN = [1 (under construction), 2 (ruined), 3 (under reclamation), 5 (planned construction)]</p> <p>(M) SCAMIN = [EU: 22000; US: 60000]</p> <p>(C) SORDAT = [YYYYMMDD]</p> <p>(C) SORIND = (Refer to Section B, General Guidance)</p> <p><b>Object Encoding</b></p> <p><b>Object Class = TOPMAR(P)</b></p> <p>(M) TOPSHP = [22 (trapezium, up), 26 (circle)]</p> <p>(O) COLOUR = [1 (white), 3 (red)]</p> <p>(O) CONDTN = [1 (under construction), 2 (ruined), 3 (under reclamation), 5 (planned construction)]</p> <p>(M) SCAMIN = [EU: 22000; US: 60000]</p> <p>(C) SORDAT = [YYYYMMDD]</p> <p>(C) SORIND = (Refer to Section B, General Guidance)</p> <p><b>Object Encoding</b></p> <p><b>Object Class = LIGHTS(P)</b></p> <p>(M) COLOUR = [3 (red), 4 (green)]</p> <p>(M) LITCHR = [1 (fixed)]</p> <p>(O) CONDTN = [1 (under construction), 2 (ruined), 3 (under reclamation), 5 (planned construction)]</p> <p>(M) SCAMIN = [EU: 22000; US: 60000]</p>

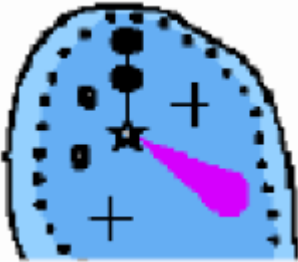
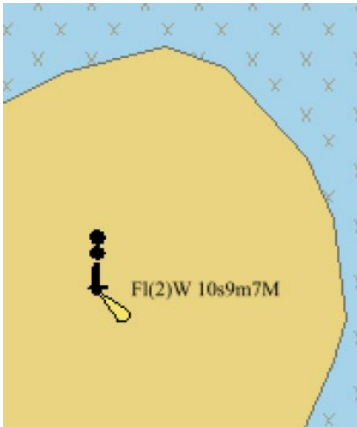
		(C) SORDAT = [YYYYMMDD] (C) SORIND = (Refer to Section B, General Guidance)
--	--	--

# O - Buoys, Beacons and Daymarks, Notice Marks

## O.2 Beacons & Daymarks

### O.2.5 Isolated Danger Beacon (M)

An isolated danger beacon is used to mark the position of a danger of limited extent, which has navigable water all around it.

Graphics	Encoding Instructions	Object Encoding
<p><i>Chart Symbol</i></p>  <p><i>IENC Symbolization</i></p> 	<p>A) BCNISD must act as a master object to a top mark object and light object (if it exists)</p> <p>B) BR: If there is any complementary characteristic on the beacon, it should be described in the attribute INFORM.</p> <p>C) In the event there is a light on the beacon, the BCNISD object should be designated as the master and coded with the name of the light.</p> <p>D) BR: The national number of the beacon (if it exists) should be encoded in the attribute NOBJNM. It is not repeated for each slave object.</p>	<p><b>Object Encoding</b></p> <p><b>Object Class = BCNISD(P)</b></p> <p>(M) BCNSHP = [1 (stake, pole, perch, post), 5 (pile beacon)]</p> <p>(M) COLOUR = [2 (black), 3 (red)]</p> <p>(M) COLPAT = [1 (horizontal stripes)]</p> <p>(C) INFORM = (Refer to letter B)</p> <p>(O) NINFOM = (Refer to Section B, General Guidance)</p> <p>(C) CONRAD = [3 (radar conspicuous (has radar reflector))]</p> <p>(C) OBJNAM = (Refer to letter C)</p> <p>(C) NOBJNM = (Refer to letter D)</p> <p>(O) CONDTN = [1 (under construction), 2 (ruined), 3 (under reclamation), 5 (planned construction)]</p> <p>(M) SCAMIN = [BR: 50000]</p> <p>(C) SORDAT = [YYYYMMDD]</p> <p>(C) SORIND = (Refer to Section B, General Guidance)</p> <p><b>Object Encoding</b></p> <p><b>Object Class = TOPMAR(P)</b></p> <p>(M) COLOUR = [2 (black)]</p> <p>(M) TOPSHP = [4 (2 spheres)]</p> <p>(C) INFORM = (Refer to letter B)</p> <p>(O) NINFOM = (Refer to Section B, General Guidance)</p> <p>(O) CONDTN = [1 (under construction), 2 (ruined), 3 (under reclamation), 5 (planned construction)]</p> <p>(M) SCAMIN = [BR: 50000]</p> <p>(C) SORDAT = [YYYYMMDD]</p> <p>(C) SORIND = (Refer to Section B, General Guidance)</p> <p><b>Object Encoding</b></p> <p><b>Object Class = LIGHTS(P)</b></p>

		<p>(M) COLOUR = [1 (white)]</p> <p>(M) EXCLIT = [1 (light shown without change of character), 2 (daytime light), 3 (fog light), 4 (night light)]</p> <p>(M) LITCHR = [2 (flashing)]</p> <p>(C) SIGPER = [xx.xx] (e.g. signal period of 12 seconds, coded as 12)</p> <p>(C) SIGGRP = [(x),(x)...], e.g., (), (2), (2+1)</p> <p>(C) SIGSEQ = [L.LL + (E.EE)] (seconds)</p> <p>(O) CONDTN = [1 (under construction), 2 (ruined), 3 (under reclamation), 5 (planned construction)]</p> <p>(M) SCAMIN = [BR: 50000]</p> <p>(C) SORDAT = [YYYYMMDD]</p> <p>(C) SORIND = (Refer to Section B, General Guidance)</p>
--	--	--






# O - Buoys, Beacons and Daymarks, Notice Marks

## O.2 Beacons & Daymarks

### O.2.6 Change Bank (O)

Used only in the Po river (Italy). Indicates that the recommended track changes to the other side of the waterway. The white half of the mark shows the direction to be followed.


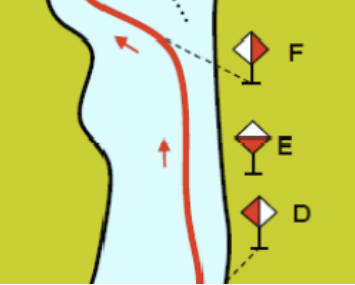
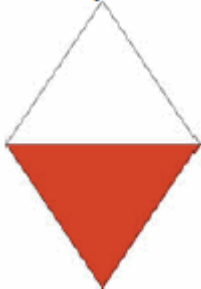
Graphics	Encoding Instructions	Object Encoding
<p><i>Real World</i></p>  <p><i>Chart Symbol</i></p>  <p><i>IENC Symbolization</i></p> 	<p>A) 'Change bank' marks are used in pairs (two equal marks, one on each bank); the alignment of the two marks indicates the track to be followed for crossing the river. Single 'change bank' marks are only used in combination with the 'touch and go' mark.</p> <p>B) Referring to navigation in the downstream direction, if it is placed on the right bank, it indicates that you have to move to the other bank; if it is placed on the left bank, it indicates that you have to approach the bank. Ships must always move in the direction indicated by the white triangle.</p> <p>C) COLOUR = [1 (white), 3 (red)] when, navigating in the downstream direction, the ship has to move to the left bank, or when navigating in the upstream direction, the ship has to move to the right bank.</p> <p>D) COLOUR = [3 (red), 1 (white)] when, navigating in the downstream direction, the ship has to move to the right bank, or when navigating in the upstream direction, the ship has to move to the left bank.</p>	<p><b>Object Encoding</b></p> <p><b>Object Class = bcnlat(P)</b></p> <p>(M) BCNSHP = [1 (stake, pole, perch, post)]</p> <p>(M) catlam = [26 (change bank)]</p> <p>(M) COLOUR = [1 (white), 3 (red), 4 (green)]</p> <p>(M) SCAMIN = [EU: 22000]</p> <p>(C) SORDAT = [YYYYMMDD]</p> <p>(C) SORIND = (Refer to Section B, General Guidance)</p> <p><b>Object Encoding</b></p> <p><b>Object Class = DAYMAR(P)</b></p> <p>(M) COLOUR = [1 (white), 3 (red)]</p> <p>(M) TOPSHP = [12 (rhombus (diamond))]</p> <p>(M) COLPAT = [2 (vertical stripes)]</p> <p>(O) CONDTN = [1 (under construction), 2 (ruined), 3 (under reclamation), 5 (planned construction)]</p> <p>(M) SCAMIN = [EU: 22000]</p> <p>(C) SORDAT = [YYYYMMDD]</p> <p>(C) SORIND = (Refer to Section B, General Guidance)</p>

# O - Buoys, Beacons and Daymarks, Notice Marks

## O.2 Beacons & Daymarks

### O.2.7 Continue Along Bank (O)

Used only in the Po river (Italy). Indicates that the recommended track continues along the same side of the waterway.


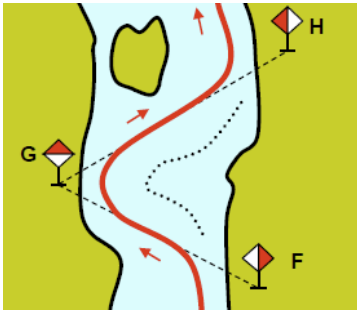
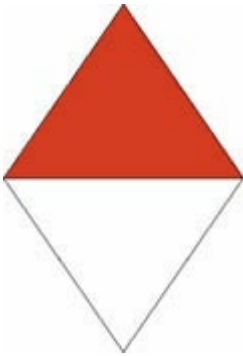
Graphics	Encoding Instructions	Object Encoding
<p><i>Real World</i></p>  <p><i>Chart Symbol</i></p>  <p><i>IENC Symbolization</i></p> 	<p>A) 'Continue along bank' marks are used to indicate that the recommended track continues along the bank on which it is placed.</p> <p>B) Referring to navigation in both directions, it generally follows a 'Change bank' mark.</p> <p>C) It is repeated about every 0.5 km, until the next 'Change bank' mark.</p> <p>D) In this case COLOUR has to be always encoded as [1,3].</p>	<p><b>Object Encoding</b></p> <p><b>Object Class = bcnlat(P)</b></p> <p>(M) BCNSHP = [1 (stake, pole, perch, post)]</p> <p>(M) catlam = [27 (continue along the bank)]</p> <p>(M) COLOUR = [1 (white), 3 (red), 4 (green)]</p> <p>(M) SCAMIN = [EU: 20000; US: 60000]</p> <p>(C) SORDAT = [YYYYMMDD]</p> <p>(C) SORIND = (Refer to Section B, General Guidance)</p> <p><b>Object Encoding</b></p> <p><b>Object Class = DAYMAR(P)</b></p> <p>(M) COLOUR = [1 (white), 3 (red)]</p> <p>(M) TOPSHP = [12 (rhombus (diamond))]</p> <p>(M) COLPAT = [1 (horizontal stripes)]</p> <p>(O) CONDTN = [1 (under construction), 2 (ruined), 3 (under reclamation), 5 (planned construction)]</p> <p>(M) SCAMIN = [EU: 22000]</p> <p>(C) SORDAT = [YYYYMMDD]</p> <p>(C) SORIND = (Refer to Section B, General Guidance)</p>

# O - Buoys, Beacons and Daymarks, Notice Marks

## O.2 Beacons & Daymarks

### O.2.8 Touch and Go (O)

Used only in the Po river (Italy). Indicates that the ship has to reach the bank and immediately move to the other bank.

Graphics	Encoding Instructions	Object Encoding
<p><i>Real World</i></p>  <p><i>Chart Symbol</i></p>  <p><i>IENC Symbolization</i></p> 	<p>A) It is used instead of two consecutive 'Change bank' marks, which should be placed very close on the same bank, to indicate that the recommended track changes again to the previous side of the waterway.</p> <p>B) It is preceded and followed by two 'Change bank' marks, both on the opposite bank of the waterway.</p> <p>C) In this case COLOUR has to be always encoded as [3,1].</p>	<p><b>Object Encoding</b></p> <p><b>Object Class</b> = bcnlat(P)</p> <p>(M) BCNSHP = [1 (stake, pole, perch, post)]</p> <p>(M) CATLAM = [26 (change bank)]</p> <p>(M) COLOUR = [1 (white), 3 (red), 4 (green)]</p> <p>(M) SCAMIN = [EU: 22000; US: 60000]</p> <p>(C) SORDAT = [YYYYMMDD]</p> <p>(C) SORIND = (Refer to Section B, General Guidance)</p> <p><b>Object Encoding</b></p> <p><b>Object Class</b> = DAYMAR(P)</p> <p>(M) COLOUR = [1 (white, 3 (red))]</p> <p>(M) TOPSHP = [12 (rhombus)]</p> <p>(M) COLPAT = [1 (horizontal stripes)]</p> <p>(O) CONDTN = [1 (under construction), 2 (ruined), 3 (under reclamation), 5 (planned construction)]</p> <p>(M) SCAMIN = [EU: 22000]</p> <p>(C) SORDAT = [YYYYMMDD]</p> <p>(C) SORIND = (Refer to Section B, General Guidance)</p>

# O - Buoys, Beacons and Daymarks, Notice Marks


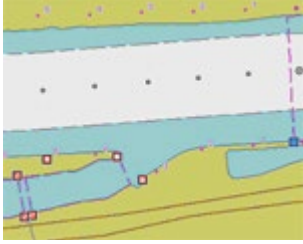

## O.3 Notice Marks

### O.3.1 Notice Marks (M)

Waterway signs in accordance with the European Code for Inland Waterways of UN/ECE (<http://www.unece.org/trans/doc/finaldocs/sc3/TRANS-SC3-115r2e.pdf> ).

Used also in Brazil in accordance with Normas da Autoridade Marítima para Auxílios à Navegação (NORMAM-17) - Diretoria de Hidrografia e Navegação (DHN) and for Waterway signs in the Russian Federation in accordance with Russian Inland Waterway Regulations GOST 26600-98.

For notice marks on bridges see O.3.2

Graphics	Encoding Instructions	Object Encoding
<p><i>Real World (Europe)</i></p>  <p><i>IENC Symbolization (CEVNI)</i></p>  <p><i>Real World (Brazil - two sides system)</i></p> 	<p>A) For detailed list of all available input ID's for category of notice mark (catnmk) see annexes "AA - CEVNI", "AB - Russian Inland Waterways", "AC - Brazilian Two Sides System", "AD - Brazilian Side Independent System" and "AE - Brazilian Paraguay-Parana Waterway".</p> <p>In Annex AA, all order numbers are referenced to the European Code for Inland Waterways – CEVNI, revision 2, edited by the Economic Commission for Europe of the United Nations.</p> <p>B) Although the list is originally based on CEVNI, the codes can be used for other notice marks with the same meaning (e.g., on the Paraguay-Parana Waterway in Brazil).</p> <p>C) For CEVNI: The function of the notice mark (fctnm) has to be encoded for display purposes as follows: 1 (prohibition mark, CEVNI signs A), 2 (regulation mark, CEVNI signs B), 3 (restriction mark, CEVNI signs C), 4 (recommendation mark, CEVNI signs D), 5 (information mark, CEVNI signs E).</p> <p>D) For CEVNI: If the notice mark is positioned rectangular to the bank, it can be seen only by vessels heading upstream (dirimp = 1) or by vessels heading downstream (dirimp = 2).</p> <p>If the notice mark is positioned parallel to the bank, it can be seen by vessels heading upstream as well as vessels heading downstream. In this case, the direction of impact is defined by triangular additional marks.</p>	<p><b>Object Encoding</b></p> <p><b>Object Class = notmrk(P)</b></p> <p>(M) catnmk = Refer to Annexes AA, AB, AC, AD and AE</p> <p>(M) fctnm = [1 (prohibition mark), 2 (regulation mark), 3 (restriction mark), 4 (recommendation mark), 5 (information mark)]</p> <p>(O) dirimp = [1 (upstream), 2 (downstream), 3 (to the left bank), 4 (to the right bank), 5 (to harbor)]</p> <p>(O) disipd = (distance of impact, downstream: unit defined in the cell header, e.g. metre (m), resolution: 1 m)</p> <p>(O) disipu = (distance of impact, upstream: unit defined in the cell header, e.g. metre (m), resolution: 1 m)</p> <p>(O) disbk1 = Minimum distance of the impact from the notice mark rectangular to the bank: unit defined in the cell header, e.g. metre (m), resolution: 1 m</p> <p>(O) disbk2 = Maximum distance of the impact from the notice mark rectangular to the bank: unit defined in the cell header, e.g. metre (m), resolution: 1 m</p> <p>(O) addmrk = [1 (top (board)), 2 (bottom (board)), 3 (right (triangle to the right)), 4 (left (triangle to the left)), 5 (bottom (triangle to the bottom))]</p> <p>(O) bnkwtw = [1 (left), 2 (right)]</p> <p>(C) ORIENT = [xxx or (UNKNOWN)] (degree (°)), e.g., 110</p> <p>(C) marsys = [1 (IALA A), 2 (IALA B), 9 (no system), 10 (other system), 11 (CEVNI), 12 (Russian inland waterway regulations), 13 (Brazilian national inland waterway regulations - two sides), 14 (Brazilian national inland waterway regulations - side independent), 15 (Paraguay-Parana waterway - Brazilian complementary aids)]</p> <p>(O) STATUS = [8 (private), 12 (illuminated)]</p>

Real World



Chart Symbol



IENC Symbolization



Real World (Brazil - one side system)



Real World (Paraguay-Parana (Brazilian))



E) For CEVNI: The distance of impact (downstream or upstream, 'disipd' or 'disipu') can be defined by the distance between two notice marks, by a number, which is shown on the top board or by a number, which is shown on an triangular additional mark.

F) For CEVNI: The minimum distance of impact from the notice mark rectangular to the bank (disbk1) can be defined by:

1. the number on a sign C.5 (distance of the waterway from the bank),
2. the first number on a sign E.5.2 (berthing permitted between two distances).

G) For CEVNI: The maximum distance of impact from the notice mark rectangular to the bank (disbk2) can be defined by:

3. the number on a sign A.5.1 (berthing prohibited within the breadth indicated),
4. the number on a sign E.5.1 (berthing permitted within the distance indicated),
5. the second number on a sign E.5.2 (berthing permitted between two distances).

H) For CEVNI: Rectangular boards on top of the main sign ('addmrk' = 1) are showing the distance at which the regulation applies or the special feature indicated by the notice mark is to be found.

Rectangular boards at the bottom of the main sign ('addmrk' = 2) are showing explanations or additional information.

Triangular pointers at the side of the main sign ('addmrk' = 3 or 4) are showing the direction of the section to which the notice mark applies.

Triangular pointers at the bottom ('addmrk' = 5) are showing the distance from the shore, within which the regulation applies.

The attribute 'addmrk' is only defining the position and shape of the additional mark. The content is given by other attributes ('disipd', 'disipu', 'disbk1', 'disbk2', INFORM, NINFOM)

I) For CEVNI: If the system of

(O) INFORM = (text of additional marks in English)

(O) NINFOM = (Refer to Section B, General Guidance)

(O) CONDTN = [1 (under construction), 2 (ruined), 3 (under reclamation), 5 (planned construction)]

(M) SCAMIN = [EU: 22000; US: 60000; BR: 50000]

(C) SORDAT = [YYYYMMDD]

(C) SORIND = (Refer to Section B, General Guidance)

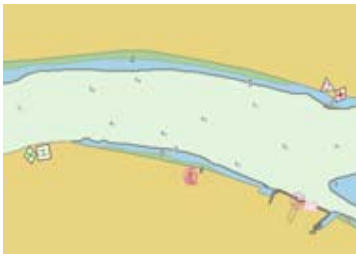
Real World



Chart Symbol



IENC Symbolization



navigational marks of a special sign is different from the system mentioned in 'm\_nsys', or there is no 'm\_nsys' object class in the cell, the attribute 'marsys' must be used.

J) For CEVNI: If a notice mark is illuminated, this should be indicated by the attribute STATUS = 12).

K) For CEVNI: Explanations or additional information shown on additional marks and

1. the number shown on the CEVNI signs B.6 (maximum speed limit) amended by the unit (e.g., "10 km/h"),

2. the frequency band and the number shown on the CEVNI sign B.11 (mandatory radiophone channel) and E.23 (nautical radio information channel) (e.g., "VHF 11"),

3. the number shown on the CEVNI signs C.1 (restricted fairway depth), C.2 (restricted vertical clearance), C.3 (restricted width of the fairway or passage), and E.5.3 (maximum number of vessels berthing abreast) have to be indicated in the INFORM attribute.

If the sign E.5.3 is used as an additional mark, the text "maximum x vessels berthing abreast" should be used. The maximum number of vessels berthing abreast has to be indicated in arabic numbers.

L) For CEVNI: The standard SCAMIN value for notice marks is 25000. Different values can be used to improve the display with regard to the safety of navigation.

M) For CEVNI: For more detailed information regarding Notice Marks and which marks should be accompanied by area features, see Section AA, Notice Marks for more detailed information.

N) For CEVNI: To encode an area, where notice marks apply, objects such as 'resare', 'achare', 'trnbsn', CTNARE, 'comare', 'achbrt' or 'berths' must be associated using a collection object C\_ASSO.

O) For CEVNI: Signs with textual description, which have the same meaning as a CEVNI sign (for example a white board with the text "mooring prohibited") can be encoded as notice marks with

	<p>INFORM = “textual description only”.</p> <p>P) For CEVNI: Signs, which are installed by private companies, should be encoded with STATUS = 8 (private).</p> <p>Q) For CEVNI: If the chart producer wants to ensure that a notice mark is displayed correctly, if detailed symbolization is used instead of the generalized symbols, ORIENT has to be encoded.</p> <p>R) BR: The function of the notice mark (fnctnm) has to be encoded.</p> <p>S) BR: The attribute bnkwtw must be encoded for display purposes when adopting marsys = 13 (Brazilian national inland waterway regulations - two sides) or marsys = 15 (Paraguay-Parana waterway - Brazilian complementary aids). It indicates the board colours.</p> <p>T) BR: The attribute orientation (ORIENT) must be used to rotate the symbol according the orientation of the board for all Brazilian notice marks.</p> <p>U) BR: The direction of impact attribute (dirimp) must be used to define if the notice mark is addressed to vessels heading upstream or downstream.</p> <p>V) This feature could be aggregated to for example a lock, bridge, communication area, anchorage area, anchor berth, berth, turning basin by a C_AGGR object.</p>	
--	---	--

	◀ Triangle left side	Triangle right side ▶
Left bank (downstream)	dirimp = 1	dirimp = 2
Right bank (downstream)	dirimp = 2	dirimp = 1

Diagram for Brazilian national inland waterway regulations - two sides

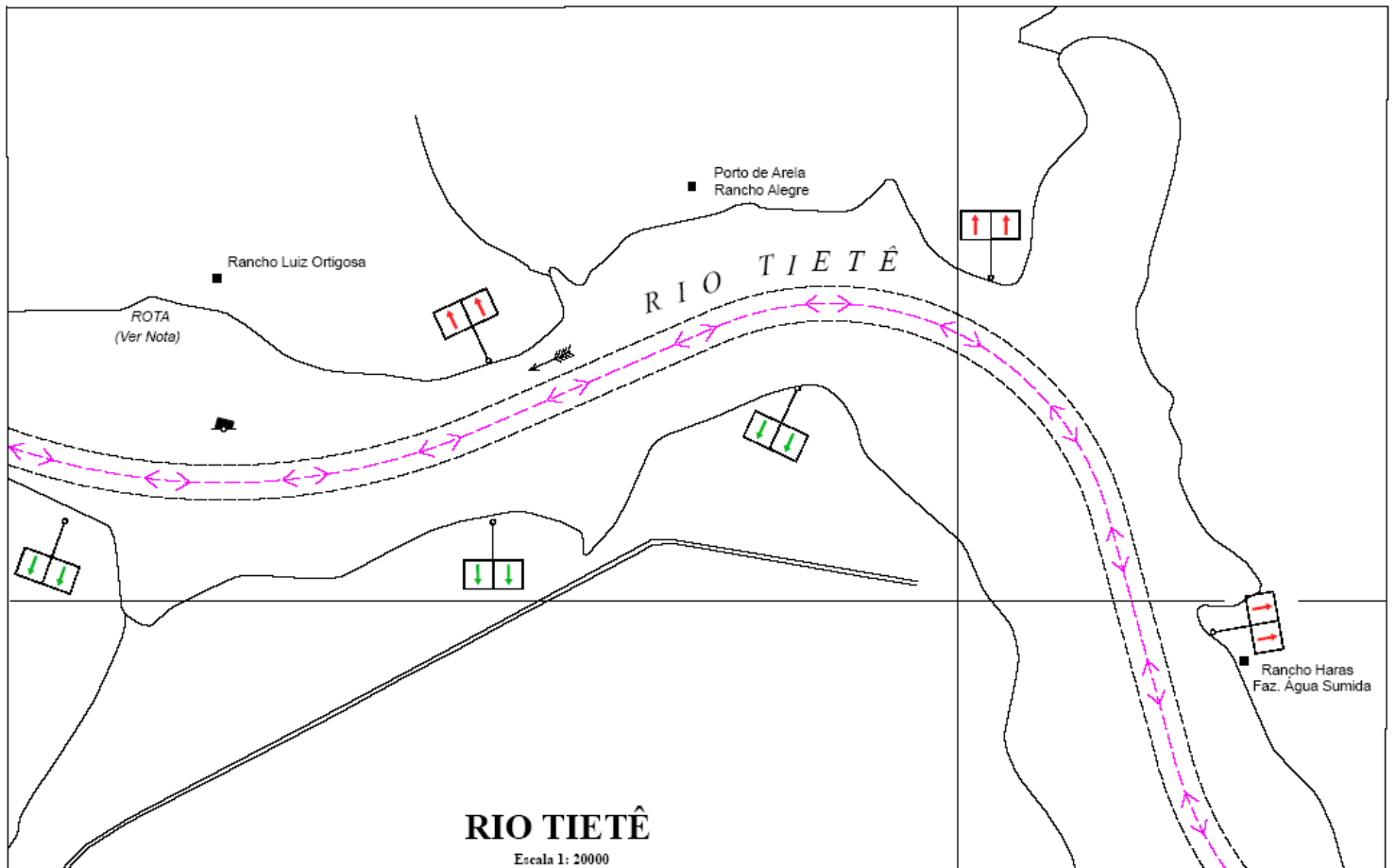




Diagram for Brazilian national inland waterway regulations – side independent

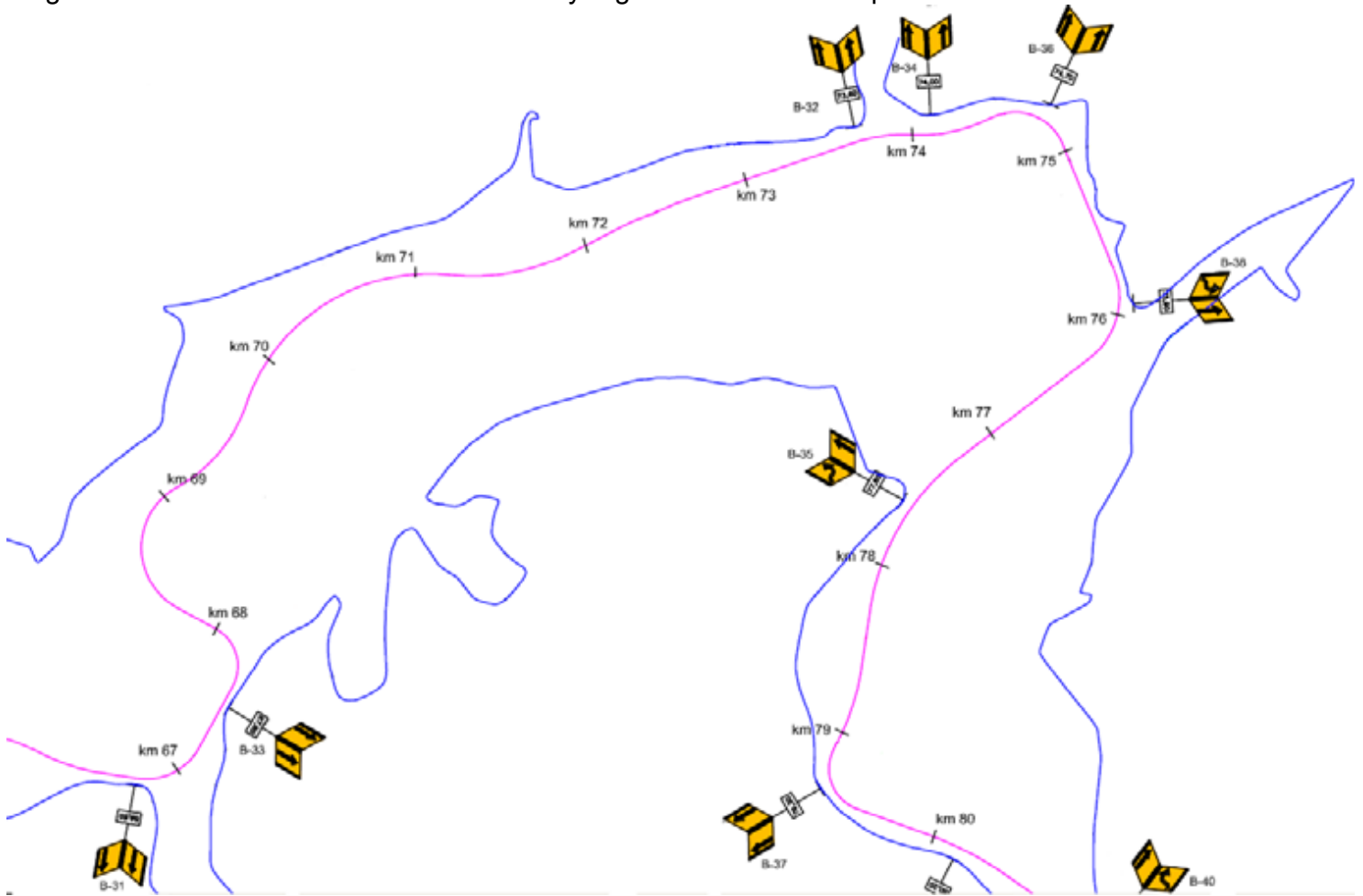
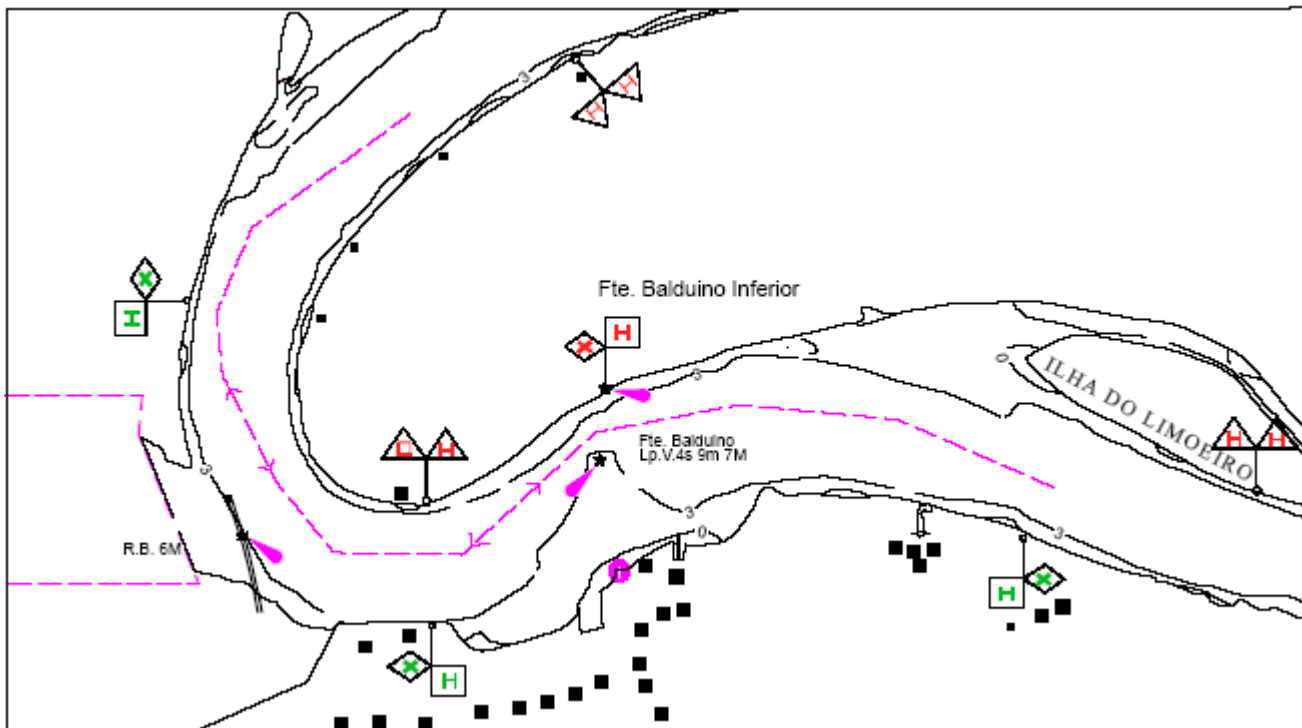


Diagram for Paraguay-Parana waterway - Brazilian complementary aids




# O - Buoys, Beacons and Daymarks, Notice Marks

## O.3 Notice Marks

### O.3.2 Notice Marks on Bridges (M)

Waterway signs in accordance with the European Code for Inland Waterways of UN/ECE  
 (<http://www.unece.org/trans/doc/finaldocs/sc3/TRANS-SC3-115r2e.pdf>)  
 For notice marks not positioned on bridges see O.3.1

Graphics	Encoding Instructions	Object Encoding
<p><i>IENC Symbolization</i></p> 	<p>A) For detailed list of all available input ID's for category of notice mark (catnmk) see annex "notice-marks.xls". All order numbers are referenced to the European Code for Inland Waterways – CEVNI, revision 2, edited by the Economic Commission for Europe of the United Nations</p> <p>B) Although the list is based on CEVNI, the codes can be used for other notice marks with the same meaning, too (e.g., on the river Po in Italy)</p> <p>C) The function of the notice mark (fnctnm) has to be encoded for display purposes.</p> <p>D) If the system of navigational marks of a special sign is different from the system mentioned in 'm_nsys', or there is no 'm_nsys' object class in the cell, the attribute 'marsys' must be used.</p> <p>E) The attribute orientation (ORIENT) must be used to rotate the symbol according the orientation of the bridge. The value of ORIENT at bridges should correspond to the prescribed heading of the vessels.</p> <p>F) If a notice mark is illuminated, this should be indicated by the attribute STATUS = 12, e.g. at bridges). If the CEVNI signs A.1, D.1 and D.2 are not illuminated, but the corresponding lights (with the same meaning according to CEVNI) are shown by night, the attribute STATUS = 12 can be used, too. If it is important for the safety of navigation to indicate the existence of the lights on the chart (e.g. to prevent confusion with other lights), the object class LIGHTS can be used instead of the attribute (see N.1.1).</p> <p>G) The SCAMIN value 8000 should be used. Different values may be used</p>	<p><b>Object Encoding</b></p> <p><b>Object Class</b> = notmrk(P)</p> <p>(M) catnmk = Refer to Annexes AA, AB, AC, AD and AE</p> <p>(M) fnctnm = [1 (prohibition mark, CEVNI signs A), 2 (regulation mark, CEVNI signs B), 4 (recommendation mark, CEVNI signs D), 5 (information mark, CEVNI signs E)]</p> <p>(O) dirimp = [1 (upstream), 2 (downstream), 3 (to the left bank), 4 (to the right bank)]</p> <p>(C) marsys = [1 (IALA A), 2 (IALA B), 9 (no system), 10 (other system), 11 (CEVNI), 12 (Russian inland waterway regulations), 13 (Brazilian national inland waterway regulations - two sides), 14 (Brazilian national inland waterway regulations - side independent), 15 (Paraguay-Parana waterway - Brazilian complementary aids)]</p> <p>(M) ORIENT = [degree (°)]</p> <p>(O) STATUS = [12 (illuminated)]</p> <p>(O) CONDTN = [1 (under construction), 2 (ruined), 3 (under reclamation), 5 (planned construction)]</p> <p>(M) SCAMIN = [EU: 8000; US: 12000]</p> <p>(C) SORDAT = [YYYYMMDD]</p> <p>(C) SORIND = (Refer to Section B, General Guidance)</p>




	<p>to improve the display with regard to the safety of navigation.</p> <p>H) This feature must be aggregated to a bridge by a C_AGGR object.</p>	
--	--	--

# O - Buoys, Beacons and Daymarks, Notice Marks

## O.3 Notice Marks

### O.3.3 Wreck Pontoon (M)

A usually temporarily installed pontoon to draw attention to obstacles and danger points and to require vessels under way to avoid causing wash.






Graphics	Encoding Instructions	Object Encoding
<p><i>Real World</i></p>  <p><i>Chart Symbol</i></p>  <p><b>catnmk = 110</b></p>  <p><b>catnmk = 111</b></p>	<p>A) In order to show which side the wreck pontoon may be passed the ORIENT attribute has to be encoded.</p> <p>B) For catnmk = 110 ORIENT = 0 means that the safe passage is on the east side of the wreck pontoon, ORIENT = 90 means that the safe passage is on the south side, ORIENT = 180 means that the safe passage is on the west side, etc.</p>	<p><b>Object Encoding</b></p> <p><b>Object Class = notmrk(P)</b></p> <p>(M) catnmk = [110 (wreck pontoon, passage allowed on side showing red-white sign), 111 (wreck pontoon, passage allowed on both sides)]</p> <p>(M) ORIENT = [xxx.xx]</p> <p>(O) INFORM = (Information about obstruction)</p> <p>(O) NINFOM = (Refer to Section B, General Guidance)</p> <p>(O) DATSTA = (Refer to Section J, DATSTA, DATEND, PERSTA and PEREND)</p> <p>(O) DATEND = (Refer to Section J, DATSTA, DATEND, PERSTA and PEREND)</p> <p>(O) PERSTA = (Refer to Section J, DATSTA, DATEND, PERSTA and PEREND)</p> <p>(O) PEREND = (Refer to Section J, DATSTA, DATEND, PERSTA and PEREND)</p> <p>(O) CONDTN = [1 (under construction), 2 (ruined), 3 (under reclamation), 5 (planned construction)]</p> <p>(M) SCAMIN = [22000]</p> <p>(C) SORDAT = [YYYYMMDD]</p> <p>(C) SORIND = (Refer to Section B, General Guidance)</p>

# O - Buoys, Beacons and Daymarks, Notice Marks

## O.4 IALA Maritime Buoyage System

### O.4.1 Special Purpose Buoy IALA (M)

A special purpose buoy is primarily used to indicate an area or feature, the nature of which is apparent from reference to a chart.

Graphics	Encoding Instructions	Object Encoding
<p><i>Real World</i></p>  <p><i>Chart Symbol</i></p>  <p><i>Chart Symbol</i></p>  <p><i>IENC Symbolization</i></p>  <p><i>IENC Symbolization</i></p> 	<p>A) BOYSPP can act as a master object to a top mark object</p> <p>B) BOYSPP can act as a master object to a light object.</p> <p>C) Mandatory attributes must be coded to ensure proper presentation.</p> <p>D) EU: The designator as it appears on the buoy, if it can be read from a passing vessel, should be encoded in the attribute OBJNAM. Administrative information on the buoys that is not relevant for navigation should be encoded in the attribute NOBJNM. It is not repeated for each slave object.</p>	<p><b>Object Encoding</b></p> <p><b>Object Class = BOYSPP(P)</b></p> <p>(M) BOYSHP = [1 (conical (nun, ogival)), 3 (spherical), 4 (pillar), 5 (spar (spindle)), 6 (barrel (tun))]</p> <p>(M) CATSPM = [6 (cable mark), 10 (recording mark), 12 (recreation zone mark), 39 (pipeline mark), 45 (foul ground mark), 50 (entry prohibited mark), 55 (marine farm mark)]</p> <p>(M) COLOUR = [6 (yellow)]</p> <p>(O) CONRAD = [3 (radar conspicuous (has radar reflector))]</p> <p>(C) OBJNAM = (Refer to letter D)</p> <p>(O) NOBJNM = (Refer to letter D)</p> <p>(M) SCAMIN = [EU: 22000; US: 60000]</p> <p>(C) SORDAT = [YYYYMMDD]</p> <p>(C) SORIND = (Refer to Section B, General Guidance)</p> <p><b>Object Encoding</b></p> <p><b>Object Class = LIGHTS(P)</b></p> <p>(M) COLOUR = [1 (white), 3 (red), 4 (green)]</p> <p>(M) EXCLIT = [1 (light shown without change of character), 2 (daytime light), 3 (fog light), 4 (night light)]</p> <p>(M) LITCHR = [1 (fixed), 2 (flashing), 3 (long-flashing), 4 (quick-flashing), 5 (very quick-flashing), 6 (ultra quick flashing), 7 (isophased), 8 (occulting), 9 (interrupted quick-flashing), 10 (interrupted very quick-flashing), 11 (interrupted ultra quick-flashing), 12 (morse), 13 (fixed/flash), 14 (flash/long-flash), 15 (occulting/flash), 16 (fixed/long-flash), 17 (occulting alternating), 18 (long-flash alternating), 19 (flash alternating), 20 (group alternating), 25 (very quick-flash plus long-flash), 26 (very quick-flash plus long-flash), 27 (ultra quick-flash plus long-flash), 28 (alternating), 29 (fixed and alternating flashing)]</p> <p>(C) SIGPER = [xx.xx] (e.g. signal period of 12 seconds coded as 12)</p>



		<p>(C) SIGGRP = [(x),(x)...], e.g., (), (2), (2+1)</p> <p>(C) SIGSEQ = [L.LL + (E.EE)] (seconds)</p> <p>(M) SCAMIN = [EU: 22000; US: 60000]</p> <p>(C) SORDAT = [YYYYMMDD]</p> <p>(C) SORIND = (Refer to Section B, General Guidance)</p> <p><b><u>Object Encoding</u></b></p> <p><b>Object Class = TOPMAR(P)</b></p> <p>(M) COLOUR = [1 (white), 2 (black), 3 (red), 4 (green), 6 (yellow)]</p> <p>(O) COLPAT = [1 (horizontal stripes), 2 (vertical stripes)]</p> <p>(M) TOPSHP = [1 (cone, point up), 2 (cone, point down), 3 (sphere), 4 (2 spheres), 5 (cylinder (can)), 6 (board), 7 (x-shape (St. Andrew's cross)), 8 (upright cross (St. George's cross)), 9 (cube, point up), 10 (2 cones, point to point), 11 (2 cones, base to base), 12 (rhombus (diamond)), 15 (besom, point up (broom or perch)), 16 (besom, point down (broom or perch)), 17 (flag), 18 (sphere over rhombus), 19 (square), 20 (rectangle, horizontal), 21 (rectangle, vertical), 22 (trapezium, up), 23 (trapezium, down), 24 (triangle, point up), 25 (triangle, point down), 26 (circle), 27 (two upright crosses (one over the other)), 28 (T-shape), 29 (triangle pointing up over a circle), 30 (upright cross over a circle), 31 (rhombus over a circle), 32 (circle over a triangle pointing up), 33 (other shape (see INFORM))]</p> <p>(C) INFORM = (Refer to TOPSHP above)</p> <p>(O) NINFOM = (Refer to Section B, General Guidance)</p> <p>(M) SCAMIN = [EU: 22000; US: 60000]</p> <p>(C) SORDAT = [YYYYMMDD]</p> <p>(C) SORIND = (Refer to Section B, General Guidance)</p>
--	--	---

# P - Fog Signals

## P.1 Fog Signal

### P.1.1 Fog Signal (M)

A fog signal transmits a warning signal from an aid to navigation, during periods of low visibility.



Graphics	Encoding Instructions	Object Encoding
<p><i>Chart Symbol</i></p>  <p><i>IENC Symbolization</i></p> 	<p>A) FOGSIG must be a slave object to PILPNT, 'boylat', BOYSPP, BOYCAR, BOYSAW, etc.</p> <p>B) The name of the navigational aid must be encoded in the attribute OBJNAM and possibly NOBJNM of the master object. It is not repeated for each slave object.</p> <p>C) The signal group is encoded using brackets to separate the individual groups. A group of signals may be a single number, a chain of numbers separated by "+", a sequence of up to 4 letters or a letter and a number.</p> <p>D) L in SIGSEQ stands for signal duration in xx.x seconds. E stands for duration of silence in xx.x seconds.</p>	<p><b>Object Encoding</b></p> <p><b>Object Class = FOGSIG(P)</b></p> <p>(M) CATFOG = [1 (explosive), 2 (diaphone), 3 (siren), 4 (nautophone), 5 (reed), 6 (tyfon), 7 (bell), 8 (whistle), 9 (gong), 10 (horn)]</p> <p>(O) SIGFRQ = [xxxxxx] (Hz), e.g. 12 for 12 Hz</p> <p>(O) SIGGEN = [1 (automatically), 2 (by wave action)]</p> <p>(C) SIGPER = [xx.xx (e.g., signal period of 12 seconds coded as 12)]</p> <p>(C) SIGGRP = [(x),(x)...], e.g., (), (2), (2+1)</p> <p>(C) SIGSEQ = [L.LL + (E.EE)] (seconds)</p> <p>(O) VALMXR = [xx.x]</p> <p>(M) SCAMIN = [EU: 22000; US: 60000]</p> <p>(C) SORDAT = [YYYYMMDD]</p> <p>(C) SORIND = (Refer to Section B, General Guidance)</p>

# Q - Radar, Radio, Electronic Positioning

## Q.1 Radar

### Q.1.1 Radar Station (O)

The radar station of a VTS or a lock to locate vessels and/ or monitor the traffic.

Graphics	Encoding Instructions	Object Encoding
<p><i>Chart Symbol</i></p>  <p><i>IENC Symbolization</i></p> 	<p>A) The object radar station (RADSTA) is used to encode the technical equipment itself independent of the building or structure where it is installed. This building or structure, e.g., mast, tower, building, radar dome is a different object.</p> <p>B) The communication information of the VTS or lock to which the radar antenna belongs should be encoded by a 'comare' object (M.4.1).</p> <p>C) RADSTA has to be the slave object of the supporting structure (e.g., landmark, see F.3.1 or building single, see E.1.2). If both objects have the same name, it is only encoded in the master object.</p>	<p><b>Object Encoding</b></p> <p><b>Object Class = RADSTA(P)</b></p> <p>(M) CATRAS = [1 (radar surveillance station)]</p> <p>(O) OBJNAM = (name and/or operator/owner)</p> <p>(O) NOBJNM = (Refer to Section B, General Guidance)</p> <p>(M) SCAMIN = [EU: 22000; US: 60000]</p> <p>(C) SORDAT = [YYYYMMDD]</p> <p>(C) SORIND = (Refer to Section B, General Guidance)</p>


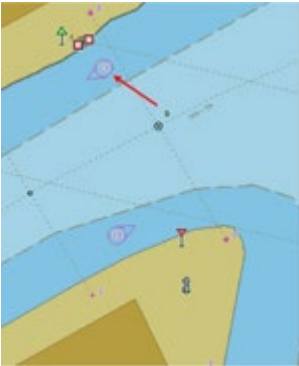


# Q - Radar, Radio, Electronic Positioning

## Q.2 Radio

### Q.2.1 Radio Calling-in Point (M)

Also called radio reporting points, they have been established in certain busy waterways and port approaches to assist traffic control. On passing these points or crossing a defined line vessels are required to report on VHF to a Traffic Control Centre. (adapted from IHO Chart Specifications, M-4)


Graphics	Encoding Instructions	Object Encoding
<p><i>Real World</i></p>  <p><i>IENC Symbolization</i></p> 	<p>A) If it's not a one-way route use TRAFIC = 4 two-way in general. Use inbound (upstream) and outbound (downstream), if the obligation to report applies only to one direction of traffic.</p> <p>B) The attribute ORIENT (orientation) is used to point in the direction of impact and enables to fix the pointer of the symbol</p> <p>C) COMCHA (communication channel) has to be used. The attribute "communication channel" encodes the various VHF-channels used for communication. Each VHF-channel should be indicated by 2 digits and up to 2 characters (A-Z); e.g., VHF-channel 7 -&gt; 07', VHF-channel 16 -&gt; &gt;16'; The indication of several VHF-channels is possible.</p> <p>D) 'catcom' should always be used.</p> <p>E) The use of line objects crossing the waterway is preferred, but it is not allowed to encode two different 'rdocal' objects on the same spatial line geometry.</p> <p>F) If a structured external XML-file with more detailed communication information is available, the reference to the file has to be entered in the TXTDSC attribute.</p> <p>G) A communication area should be encoded where relevant.</p> <p>H) This feature could be aggregated to a lock, bridge or communication area, etc. by a C_AGGR object.</p>	<p><b>Object Encoding</b></p> <p><b>Object Class</b> = rdocal(P,L)</p> <p>(M) TRAFIC = [1 (inbound), 2 (outbound), 3 (one-way), 4 (two-way)]</p> <p>(M) ORIENT = [unit: degree (°)]</p> <p>(M) COMCHA = [[XXXX];[XXXX];...]</p> <p>(M) catcom = [1 (VTS centre), 2 (VTS sector), 3 (IVS point), 4 (MIB), 5 (lock), 6 (bridge), 7 (custom), 8 (harbour)]</p> <p>(O) TXTDSC = (Refer to letter F)</p> <p>(M) OBJNAM = (name and/or operator/owner)</p> <p>(O) NOBJNM = (Refer to Section B, General Guidance)</p> <p>(C) unlocd = [ISRS Location Code]</p> <p>(M) SCAMIN = [EU: 12000; US: 22000]</p> <p>(C) SORDAT = [YYYYMMDD]</p> <p>(C) SORIND = (Refer to Section B, General Guidance)</p>

# R - Services

## R.1 Check Points



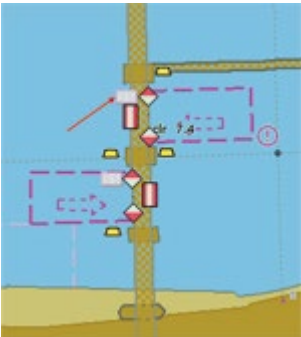
### R.1.1 Check Point (C)

An official place to register, declare, or check goods and/or people.

Graphics	Encoding Instructions	Object Encoding
<p><i>IENC Symbolization</i></p> 	<ul style="list-style-type: none"> <li>A) Places for customs controls and immigration control have to be encoded as a 'chkpnt'.</li> <li>B) This object only encodes the function. The object 'checkpoint' does not include facilities such as buildings, gates, or other installations. They may be encoded as separate objects.</li> <li>C) If a structured external XML-file with more detailed communication information is available, the reference to the file has to be entered in the TXTDSC attribute.</li> <li>D) If an UNLOCODE or an ISRS is available, it must be encoded (see General Guidance H).</li> <li>E) EU: Check points must be encoded.</li> </ul>	<p><b><u>Object Encoding</u></b></p> <p><b>Object Class</b> = chkpnt(P,A)</p> <p>(M) catchp = [1 (custom), 2 (border)]</p> <p>(M) NATION = (Nationality is encoded by a 2 character-code following ISO 3166 (refer to Annex A to S-57 Appendix A))</p> <p>(O) OBJNAM = (name of the control station)</p> <p>(O) NOBJNM = (Refer to Section B, General Guidance)</p> <p>(C) unlocd = [ISRS Location Code]</p> <p>(O) TXTDSC = (Refer to letter C)</p> <p>(M) SCAMIN = [EU: 12000; US: 22000]</p> <p>(C) SORDAT = [YYYYMMDD]</p> <p>(C) SORIND = (Refer to Section B, General Guidance)</p>





### R.2.1 Traffic Signal Station - Bridge Passage (O)

Place on shore from which signals are made for the control of vessels wishing to pass under a bridge.

Graphics	Encoding Instructions	Object Encoding
<p><i>Real World</i></p>  <p><i>Real World</i></p>  <p><i>IENC Symbolization</i></p> 	<p>A) COMCHA should not be used, communication area can be given in 'comare' object class.</p> <p>B) It's recommended to show the direction of the impact (object attribute 'dirimp') if the traffic signal station is only valid for one direction.</p> <p>C) If the traffic signal station has an official name it's has to be encoded with the object attribute OBJNAM.</p> <p>D) INFORM can be used to give unformatted text as additional information. For formatted text TXTDSC has to be used.</p> <p>E) The signals have to be aggregated with the other bridge objects by C_AGGR.</p>	<p><b>Object Encoding</b></p> <p><b>Object Class</b> = sistat(P)</p> <p>(M) catsit = [8 (bridge passage)]</p> <p>(O) dirimp = [1 (upstream), 2 (downstream)]</p> <p>(C) OBJNAM = (name and/or operator/owner)</p> <p>(O) NOBJNM = (Refer to Section B, General Guidance)</p> <p>(O) INFORM = (Refer to letter D)</p> <p>(O) NINFOM = (Refer to Section B, General Guidance)</p> <p>(O) TXTDSC = (Refer to letter D)</p> <p>(C) unlocd = [ISRS Location Code]</p> <p>(O) CONDTN = [1 (under construction), 2 (ruined), 3 (under reclamation), 5 (planned construction)]</p> <p>(M) SCAMIN = [EU: 22000; US: 60000]</p> <p>(C) SORDAT = [YYYYMMDD]</p> <p>(C) SORIND = (Refer to Section B, General Guidance)</p>



### R.2.2 Traffic Signal Station - Lock (O)

Place on shore from which signals are made for the control of vessels entering or leaving a lock.

Graphics	Encoding Instructions	Object Encoding
<p><i>Real World</i></p>  <p><i>Real World</i></p>  <p><i>Real World</i></p>  <p><i>IENC Symbolization</i></p> 	<p>A) COMCHA should not be used, communication area can be given in 'comare' object class.</p> <p>B) It's recommended to show the direction of the impact (object attribute 'dirimp') if the traffic signal station is only valid for one direction.</p> <p>C) If the traffic signal station has an official name it has to be encoded with the object attribute OBJNAM.</p> <p>D) INFORM can be used to give unformatted text as additional information. For formatted text TXTDSC must be used.</p> <p>E) The signals have to be aggregated with the other lock objects using C_AGGR.</p>	<p><b>Object Encoding</b></p> <p><b>Object Class</b> = sistat(P)</p> <p>(M) catsit = [6 (lock)]</p> <p>(O) dirimp = [1 (upstream), 2 (downstream)]</p> <p>(C) OBJNAM = (Refer to letter C)</p> <p>(O) NOBJNM = (Refer to Section B, General Guidance)</p> <p>(O) INFORM = (Refer to letter D)</p> <p>(O) NINFOM = (Refer to Section B, General Guidance)</p> <p>(O) TXTDSC = (Refer to letter D)</p> <p>(C) unlocd = [ISRS Location Code]</p> <p>(O) CONDTN = [1 (under construction), 2 (ruined), 3 (under reclamation), 5 (planned construction)]</p> <p>(M) SCAMIN = [EU: 22000; US: 60000]</p> <p>(C) SORDAT = [YYYYMMDD]</p> <p>(C) SORIND = (Refer to Section B, General Guidance)</p>




### R.2.3 Traffic Signal Station - Oncoming Traffic Indicator (O)

Place on shore from which signals are made to inform about oncoming traffic.

Graphics	Encoding Instructions	Object Encoding
<p><i>Real World</i></p>  <p><i>IENC Symbolization</i></p> 	<p>A) COMCHA should not be used, communication area can be given in 'comare' object class.</p> <p>B) It's recommended to show the direction of the impact (object attribute 'dirimp') if the traffic signal station is only valid for one direction.</p> <p>C) If the traffic signal station has an official name it's has to be encoded with the object attribute OBJNAM.</p> <p>D) INFORM can be used to give unformatted text as additional information. For formatted text TXTDSC must be used.</p>	<p><b>Object Encoding</b></p> <p><b>Object Class = sistat(P)</b></p> <p>(M) catsit = [10 (oncoming traffic indication)]</p> <p>(O) dirimp = [1 (upstream), 2 (downstream), 3 (to the left bank), 4 (to the right bank)]</p> <p>(C) OBJNAM = (Refer to letter C)</p> <p>(O) NOBJNM = (Refer to Section B, General Guidance)</p> <p>(O) INFORM = (Refer to letter D)</p> <p>(O) NINFOM = (Refer to Section B, General Guidance)</p> <p>(O) TXTDSC = (Refer to letter D)</p> <p>(C) unlocd = [ISRS Location Code]</p> <p>(O) CONDTN = [1 (under construction), 2 (ruined), 3 (under reclamation), 5 (planned construction)]</p> <p>(M) SCAMIN = [EU: 22000; US: 60000]</p> <p>(C) SORDAT = [YYYYMMDD]</p> <p>(C) SORIND = (Refer to Section B, General Guidance)</p>

### R.2.4 Traffic Signal Station - Port Entry and Departure (O)

Place on shore from which signals are made for the control of vessels entering or leaving a port.




Graphics	Encoding Instructions	Object Encoding
<p><i>Real World</i></p>  <p><i>Real World</i></p>  <p><i>IENC Symbolization</i></p> 	<p>A) COMCHA should not be used, communication area can be given in 'comare' object class.</p> <p>B) It's recommended to show the direction of the impact (object attribute 'dirimp') if the traffic signal station is only valid for one direction.</p> <p>C) If the traffic signal station has an official name it's has to be encoded with the object attribute OBJNAM.</p> <p>D) INFORM can be used to give unformatted text as additional information. For formatted text TXTDSC has to be used.</p>	<p><b>Object Encoding</b></p> <p><b>Object Class = sistat(P)</b></p> <p>(M) catsit = [2 (port entry and departure)]</p> <p>(O) dirimp = [1 (upstream), 2 (downstream), 3 (to the left bank), 4 (to the right bank)]</p> <p>(C) OBJNAM = (Refer to letter C)</p> <p>(O) NOBJNM = (Refer to Section B, General Guidance)</p> <p>(O) INFORM = (Refer to letter D)</p> <p>(O) NINFOM = (Refer to Section B, General Guidance)</p> <p>(O) TXTDSC = (Refer to letter D)</p> <p>(C) unlocd = [ISRS Location Code]</p> <p>(O) CONDTN = [1 (under construction), 2 (ruined), 3 (under reclamation), 5 (planned construction)]</p> <p>(M) SCAMIN = [EU: 22000; US: 60000]</p> <p>(C) SORDAT = [YYYYMMDD]</p> <p>(C) SORIND = (Refer to Section B, General Guidance)</p>

# R - Services

## R.3 Rescue Stations

### R.3.1 Rescue Station (O)

A place at which life saving equipment is held.


Graphics	Encoding Instructions	Object Encoding
<p><i>Real World</i></p> 		<p><b>Object Encoding</b></p> <p><b>Object Class = RSCSTA(P)</b></p> <p>(M) catrsc = [1 (rescue station with life boat), 2 (rescue station with rocket), 3 (not in use), 4 (refuge for ship-wrecked mariners), 5 (refuge for intertidal area walkers), 6 (lifeboat lying at a mooring), 7 (aid radio station), 8 (first aid equipment), 9 (lifebuoy, ring buoy, life ring, life saver)]</p> <p>(O) DATEND = (Refer to Section J, DATSTA, DATEND, PERSTA and PEREND)</p> <p>(O) DATSTA = (Refer to Section J, DATSTA, DATEND, PERSTA and PEREND)</p> <p>(O) PERSTA = (Refer to Section J, DATSTA, DATEND, PERSTA and PEREND)</p> <p>(O) PEREND = (Refer to Section J, DATSTA, DATEND, PERSTA and PEREND)</p>
<p><i>Real World</i></p> 		<p>(O) OBJNAM = [Name]</p> <p>(O) NOBJNM = (Refer to Section B, General Guidance)</p> <p>(O) STATUS = [2 (occasional), 4 (not in use)]</p> <p>(M) SCAMIN = [8000]</p> <p>(C) SORDAT = [YYYYMMDD]</p> <p>(C) SORIND = (Refer to Section B, General Guidance)</p>
<p><i>IENC Symbolization</i></p> 		

# R - Services

## R.4 Sensors

### R.4.1 Sensor (O)

A device that responds to a physical stimulus (as heat, light, sound, pressure, magnetism or a particular motion) and transmits a resulting impulse (as for measurement or operating a control).

Graphics	Encoding Instructions	Object Encoding
<p><i>Real World</i></p> 	<p>A) For a sensor used to reduce or to turn off bridge lighting, choose appropriate category of sensor and fnctsn = 1 (reduce bridge lighting).</p>	<p><b>Object Encoding</b></p> <p><b>Object Class</b> = sensor(P)</p> <p>(M) catsen = [1 (light activated), 2 (telephone activated)]</p> <p>(M) fnctsn = [1 (reduce bridge lighting)]</p> <p>(O) OBJNAM = [name and/or operator/owner]</p> <p>(O) NOBJNM = (Refer to Section B, General Guidance)</p> <p>(M) SCAMIN = [22000]</p> <p>(C) SORDAT = [YYYYMMDD]</p> <p>(C) SORIND = (Refer to Section B, General Guidance)</p>


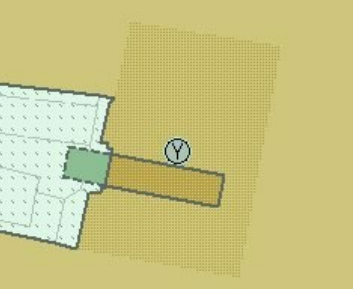


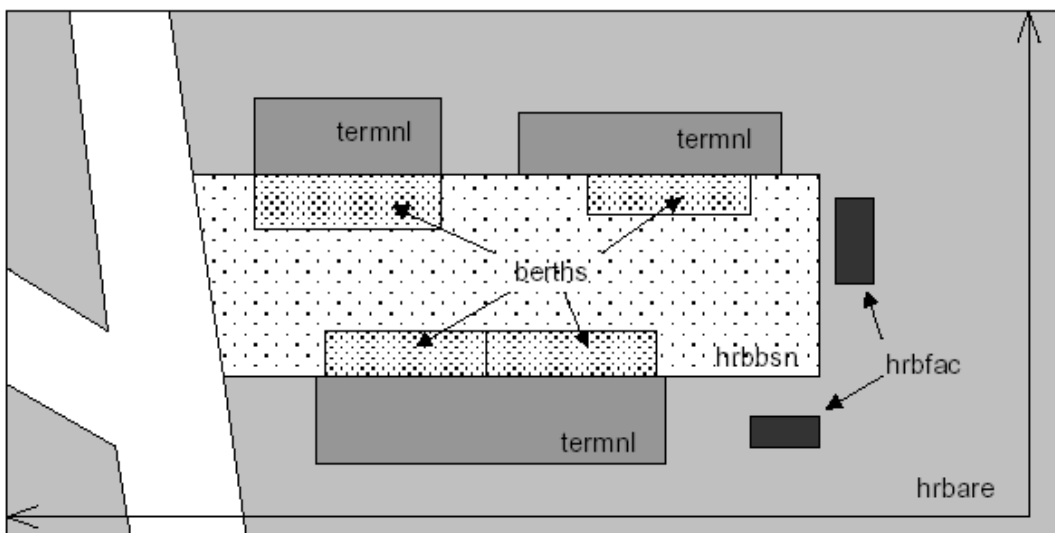
# S - Small Craft Facilities

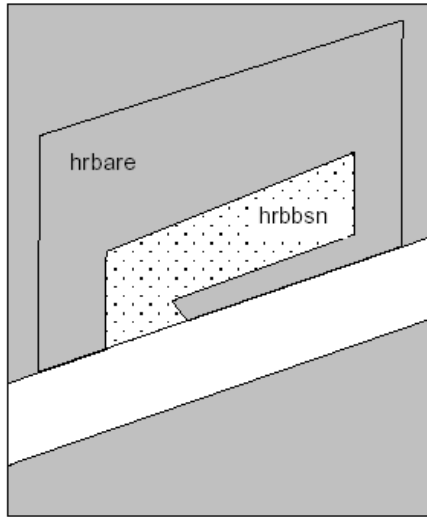
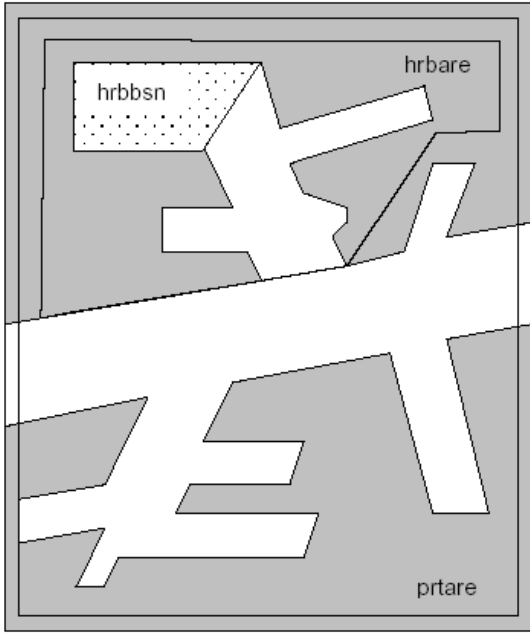
## S.1 Marinas and Other Facilities

### S.1.1 Harbor Facilities (O)

A harbor installation with a service or commercial operation of public interest.

Graphics	Encoding Instructions	Object Encoding
<p><i>Real World</i></p>  <p><i>IENC Symbolization</i></p> 	<p>A) Harbor facilities indicate only the services and not the physical buildings or other structures.</p> <p>B) Terminals are not encoded as 'hrbfac' but as 'termnl' (see G.3.19).</p> <p>C) A shipyard on shore is always encoded as hrbfac with cathaf = 9. The single slipways are encoded as SLCONS (see G.3.18). For docks see G.3.5 to G.3.7.</p> <p>D) If the harbour facility has a special time schedule or special operating hours apply, the object can be combined with a time schedule. For this purpose please refer to the time schedule (general) object 'tisdge' see T.1.1.</p> <p>E) If a structured external XML-file with more detailed communication information is available, the reference to the file must be entered in the TXTDSC attribute.</p> <p>F) Harbor master's offices, pilot offices, water police offices and custom offices are encoded as BUISGL</p>	<p><b>Object Encoding</b></p> <p><b>Object Class = hrbfac(P,A)</b></p> <p>(M) cathaf = [4 (fishing harbour), 6 (naval base), 9 (shipyard), 12 (syncrolift), 13 (straddle carrier), 16 (service and repair), 17 (quarantine station)]</p> <p>(O) TXTDSC = (Refer to letter E)</p> <p>(O) CONDTN = [1 (under construction), 2 (ruined), 3 (under reclamation), 5 (planned construction)]</p> <p>(M) SCAMIN = [EU: 12000; US: 22000]</p> <p>(C) SORDAT = [YYYYMMDD]</p> <p>(C) SORIND = (Refer to Section B, General Guidance)</p>







# S - Small Craft Facilities

## S.1 Marinas and Other Facilities

### S.1.2 Marina (O)

A harbour installation with a service or commercial operation of public interest. (S-57 Standard)

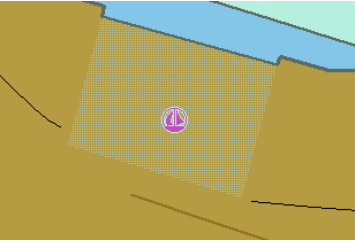
Graphics	Encoding Instructions	Object Encoding
<p><i>Real World</i></p>  <p><i>Chart Symbol</i></p> <div style="border: 1px solid red; padding: 5px; color: red; text-align: center;"> <p><b>Image to be included at a later date</b></p> </div> <p><i>IENC Symbolization</i></p> 	<p>A) Only code HRBFAC (A) object when extents of marina feature are known. Use HRBFAC (P) when extents are not known.</p>	<p><b>Object Encoding</b></p> <p><b>Object Class = HRBFAC(P,A)</b></p> <p>(M) CATHAF = [5 (yacht harbour/marina)]</p> <p>(M) OBJNAM = [(Marina Name) + "Marina"]</p> <p>(O) NOBJNM = (Refer to Section B, General Guidance)</p> <p>(O) CONDTN = [1 (under construction), 2 (ruined), 3 (under reclamation), 5 (planned construction)]</p> <p>(M) SCAMIN = [EU: 12000; US: 60000]</p> <p>(C) SORDAT = [YYYYMMDD]</p> <p>(C) SORIND = (Refer to Section B, General Guidance)</p>

# S - Small Craft Facilities

## S.1 Marinas and Other Facilities

### S.1.3 Small Craft Facility (O)

A place at which a service generally of interest to small craft or pleasure boats is available.

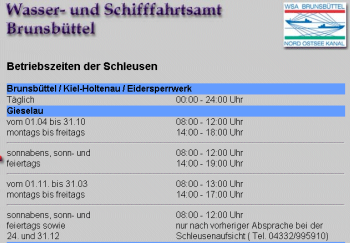
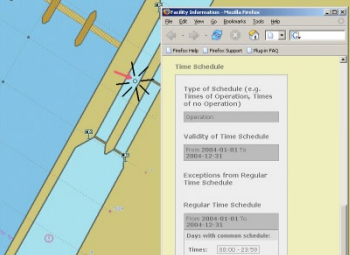
Graphics	Encoding Instructions	Object Encoding
<p><i>IENC Symbolization</i></p> 	<p>A) This object class encodes only the service available for small craft or pleasure boats at this location.</p> <p>B) The structure housing the service may be encoded separately.</p> <p>C) If the small craft facility has a special time schedule or special operating hours apply, the object can be combined with a time schedule. For this purpose please refer to the time schedule (general) object 'tisdge' see T.1.1</p> <p>D) For bunker, fuel and water supply for commercial vessels see G.3.2, for refuse dump see G.3.17.</p> <p>E) If a structured external XML-file with more detailed communication information is available, the reference to the file has to be entered in the TXTDSC attribute.</p>	<p><b><u>Object Encoding</u></b></p> <p><b>Object Class = SMCFAC(P,A)</b></p> <p>(M) CATSCF = [1 (visitor's berth), 2 (nautical club), 3 (boat hoist), 4 (sailmaker), 5 (boatyard), 6 (public inn), 7 (restaurant), 8 (chandler), 9 (provisions), 10 (doctor), 11 (pharmacy), 12 (water tap), 13 (fuel station), 14 (electricity), 15 (bottle gas), 16 (showers), 17 (laundrette), 18 (public toilets), 19 (post box), 20 (public telephone), 21 (refuse bin), 22 (car park), 23 (parking for boats and trailers), 24 (caravan site), 25 (camping site), 26 (sewerage pump-out station), 27 (emergency telephone), 28 (landing/launching place for boats), 29 (visitors mooring), 30 (scrubbing berth), 31 (picnic area), 32 (mechanics workshop), 33 (guard and/or security service)]</p> <p>(O) OBJNAM = (name and/or operator/owner)</p> <p>(O) NOBJNM = (Refer to Section B, General Guidance)</p> <p>(O) TXTDSC = (Refer to letter E)</p> <p>(O) CONDTN = [1 (under construction), 2 (ruined), 3 (under reclamation), 5 (planned construction)]</p> <p>(M) SCAMIN = [EU: 8000; US: 12000]</p> <p>(C) SORDAT = [YYYYMMDD]</p> <p>(C) SORIND = (Refer to Section B, General Guidance)</p>

# T - Time and Behaviour

## T.1 Schedules

### T.1.1 Time Schedule (general) (C)

Time schedules are used to encode operating hours of locks, bridges etc.

Graphics	Encoding Instructions	Object Encoding
<p><i>Real World</i></p>  <p><i>IENC Symbolization</i></p> 	<p>A) Encoded without dedicated spatial reference. Always associated with respective geo object (see below).</p> <p>B) Operating hours should be included in at least all movable bridges and all locks, even if these are operated 24 hours a day 7 days a week all year round.</p> <p>C) Operating hours should preferably be added for all other objects that have limited operating/ availability hours (Offices of waterway authorities, harbor masters, police, etc. / bunker services, fresh water supplies, refuse dumps, etc. / terminals, berths, pontoons, etc.)</p> <p>D) Detailed schedule information is contained in external file. The attribute 'schref' contains the respective reference.</p> <p>E) If there are different time schedules for different ship types or usages of ships, or there are different categories of time and behavior, several 'tisdge' objects must be used.</p> <p>F) Information about average passing times is encoded in an additional external file. The file name is encoded in the 'aptref' attribute</p> <p>G) Operating times have to be encoded in local time.</p> <p>H) EU: Time schedules must be encoded, however if the same time schedule applies to all kinds of vessels the reference to the external XML file can be encoded in the TXTDSC attribute of the object itself. It is not necessary to encode the tisdge object in this case.</p>	<p><b>Object Encoding</b></p> <p><b>Object Class = tisdge()</b></p> <p>(M) cattab = [1 (operational period), 2 (non-operational period)]</p> <p>(M) schref = (Time schedule reference: if a structured external XML-file is available, the reference to the file has to be entered here.)</p> <p>(M) shptyp = [1 (general cargo vessel), 2 (container vessel), 3 (tanker), 4 (sailing vessel), 5 (fishing vessel)]</p> <p>(M) useshp = [1 (liner trade), 2 (occasional professional shipping), 3 (leisure)]</p> <p>(O) aptref = Average passing time reference; if a structured external XLM-file is available, the reference to the files has to be entered here]</p> <p>(O) dirimp = [1 (upstream), 2 (downstream), 3 (to the left bank), 4 (to the right bank)]</p> <p>(C) SORDAT = [YYYYMMDD]</p> <p>(C) SORIND = (Refer to Section B, General Guidance)</p>

## U.1 Maximum Dimensions, Speed

### U.1.1 Maximum Permitted Ship Dimensions (C)

Waterway or waterway section for which a juridical regulation with respect to the maximum permitted vessel dimensions exists.

Graphics	Encoding Instructions	Object Encoding
	<p>A) The actual value for ship dimension limits are encoded by the respective regulation attributes ('lg_bme', 'lg_lgs', 'lg_drt', 'lg_wdp').</p> <p>B) If 'lg_wdp' is encoded the unit for the water displacement must be given as well.</p> <p>C) Use 'lg_rel' to indicate if the particular regulation is meant to control the general usage of the waterway, the carriage of equipment, tasks/operations performed by the skipper or other instructions.</p> <p>D) Condition attributes ('lc_csi'; 'lc_cse'; 'lc_asi'; 'lc_ase'; 'lc_cci'; 'lc_cce') must be used to describe the conditions under which a particular law / regulation is applicable.</p> <p>E) To describe the categories for ship types, ship formations and cargo type use either implicit or explicit type selection.</p> <p>F) If the value 1 'other' is used for one of the above category attributes the description attribute (lg_des) must be used to describe the details or indicate where detailed information can be found.</p> <p>G) EU: Must be encoded if a regulation for (a stretch of) a waterway with regard to maximum permitted ship dimensions exists unless a CEMT class has been encoded by a wtware feature (L.3.1 CEMT Classification, ISRS Location Code) and the permitted ship dimensions are equal to the CEMT class.</p>	<p><b>Object Encoding</b></p> <p><b>Object Class = lg_sdm(A)</b></p> <p>(M) lg_rel = [1 (other), 2 (usage of waterway), 3 (carriage of equipment), 4 (task,operation)]</p> <p>(M) lg_bme = [xx.xx] (metres), e.g., 10.45</p> <p>(M) lg_lgs = [xxx.xx] (metres), e.g., 110.00</p> <p>(M) lg_drt = [xx.xx] (metres), e.g., 3.10</p> <p>(M) lg_wdp = [xxxx.x] (m<sup>3</sup> or tonnes), e.g., 310.0</p> <p>(M) lg_wdu = [1 (other), 2 (cubic meters), 3 (tonnes)]</p> <p>(C) lg_des = [legal description; please refer to F]</p> <p>(M) lc_csi = [1 (all types), 2 (other), 3 (non-motorized vessel), 5 (craft), 6 (vessel), 7 (inland waterway vessel), 8 (sea going ship), 9 (motor vessel), 10 (motor tanker), 11 (motor cargo vessel), 12 (canal barge), 13 (tug), 14 (pusher), 15 (barge), 16 (tank barge), 17 (dumb barge), 18 (lighter), 19 (tank lighter), 20 (cargo lighter), 21 (ship borne lighter), 22 (passenger vessel), 23 (passenger sailing vessel), 24 (day trip vessel), 25 (cabin vessel), 26 (High-speed vessel), 27 (floating equipment), 28 (worksite craft), 29 (recreational craft), 30 (Dinghy), 31 (floating establishment), 32 (floating object)]</p> <p>(M) lc_cse = [1 (all types), 2 (other), 3 (non-motorized vessel), 5 (craft), 6 (vessel), 7 (inland waterway vessel), 8 (sea going ship), 9 (motor vessel), 10 (motor tanker), 11 (motor cargo vessel), 12 (canal barge), 13 (tug), 14 (pusher), 15 (barge), 16 (tank barge), 17 (dumb barge), 18 (lighter), 19 (tank lighter), 20 (cargo lighter), 21 (ship borne lighter), 22 (passenger vessel), 23 (passenger sailing vessel), 24 (day trip vessel), 25 (cabin vessel), 26 (High-speed vessel), 27 (floating equipment), 28 (worksite craft), 29 (recreational craft), 30 (Dinghy), 31 (floating establishment), 32 (floating object)]</p> <p>(M) lc_asi = [1 (all types), 2 (other), 3 (single vessel), 5 (convoy), 6 (formation), 7 (rigid convoy), 8 (pushed convoy), 9 (breasted up</p>

		<p>formation), 10 (towed convoy)]</p> <p>(M) lc_ase = [1 (all types), 2 (other), 3 (single vessel), 5 (convoy), 6 (formation), 7 (rigid convoy), 8 (pushed convoy), 9 (breasted up formation), 10 (towed convoy)]</p> <p>(M) lc_cci = [1 (all types), 2 (other), 4 (bulk), 5 (dry cargo), 6 (liquid cargo), 7 (liquid cargo (type N)), 8 (liquid cargo (type C)), 9 (gas)]</p> <p>(M) lc_cce = [1 (all types), 2 (other), 4 (bulk), 5 (dry cargo), 6 (liquid cargo), 7 (liquid cargo (type N)), 8 (liquid cargo (type C)), 9 (gas)]</p> <p>(O) lg_pbr = (publication reference)</p> <p>(C) SORDAT = [YYYYMMDD]</p> <p>(C) SORDAT = [YYYYMMDD]</p>
--	--	---

## U.1 Maximum Dimensions, Speed

### U.1.2 Maximum Permitted Vessel Speed (C)

Waterway or waterway section for which a juridical regulation with respect to the maximum permitted vessel speed exists.

Graphics	Encoding Instructions	Object Encoding
	<p>A) The actual value for the speed limit is encoded by the respective regulation attribute (lg_spd).</p> <p>B) The reference of the given speed value (e.g., speed over ground, speed through water) must be encoded by means of 'lg_spr'.</p> <p>C) Use 'lg_rel' to indicate if the particular regulation is meant to control the general usage of the waterway, the carriage of equipment, tasks/operations performed by the skipper or other instructions.</p> <p>D) Condition attributes ('lc_csi'; 'lc_cse'; 'lc_asi'; 'lc_ase'; 'lc_cci'; 'lc_cce') must be used to describe the conditions under which a particular law / regulation is applicable.</p> <p>E) To describe the categories for ship types, ship formations and cargo type use either implicit or explicit type selection.</p> <p>F) If the value 1 'other' is used for one of the above category attributes the description attribute (lg_des) must be used to describe the details or indicate where detailed information can be found.</p> <p>G) EU: Must be encoded if a regulation for (a stretch of) a waterway with regard to maximum permitted vessel speed exists.</p>	<p><b>Object Encoding</b></p> <p><b>Object Class = lg_vsp(A)</b></p> <p>(M) lg_rel = [1 (other), 2 (usage of waterway), 3 (carriage of equipment), 4 (task,operation)]</p> <p>(M) lg_spd = [xx.x] (km/h), e.g., 10.0 for a maximum permitted speed of 10.0 km/h</p> <p>(M) lg_spr = [1 (other), 2 (speed over ground), 3 (speed through water)]</p> <p>(C) lg_des = (legal description: please refer to F)</p> <p>(M) lc_csi = [1 (all types), 2 (other), 3 (non-motorized vessel), 5 (craft), 6 (vessel), 7 (inland waterway vessel), 8 (sea going ship), 9 (motor vessel), 10 (motor tanker), 11 (motor cargo vessel), 12 (canal barge), 13 (tug), 14 (pusher), 15 (barge), 16 (tank barge), 17 (dumb barge), 18 (lighter), 19 (tank lighter), 20 (cargo lighter), 21 (ship borne lighter), 22 (passenger vessel), 23 (passenger sailing vessel), 24 (day trip vessel), 25 (cabin vessel), 26 (High-speed vessel), 27 (floating equipment), 28 (worksite craft), 29 (recreational craft), 30 (Dinghy), 31 (floating establishment), 32 (floating object)]</p> <p>(M) lc_cse = [1 (all types), 2 (other), 3 (non-motorized vessel), 5 (craft), 6 (vessel), 7 (inland waterway vessel), 8 (sea going ship), 9 (motor vessel), 10 (motor tanker), 11 (motor cargo vessel), 12 (canal barge), 13 (tug), 14 (pusher), 15 (barge), 16 (tank barge), 17 (dumb barge), 18 (lighter), 19 (tank lighter), 20 (cargo lighter), 21 (ship borne lighter), 22 (passenger vessel), 23 (passenger sailing vessel), 24 (day trip vessel), 25 (cabin vessel), 26 (High-speed vessel), 27 (floating equipment), 28 (worksite craft), 29 (recreational craft), 30 (Dinghy), 31 (floating establishment), 32 (floating object)]</p> <p>(M) lc_asi = [1 (all types), 2 (other), 3 (single vessel), 5 (convoy), 6 (formation), 7 (rigid convoy), 8 (pushed convoy), 9 (breasted up formation), 10 (towed convoy)]</p> <p>(M) lc_ase = [1 (all types), 2 (other), 3 (single vessel), 5 (convoy), 6 (formation), 7 (rigid convoy), 8 (pushed convoy), 9 (breasted up</p>



		<p>formation), 10 (towed convoy)]</p> <p>(M) lc_cci = [1 (all types), 2 (other), 4 (bulk), 5 (dry cargo), 6 (liquid cargo), 7 (liquid cargo (type N)), 8 (liquid cargo (type C)), 9 (gas)]</p> <p>(M) lc_cce = [1 (all types), 2 (other), 4 (bulk), 5 (dry cargo), 6 (liquid cargo), 7 (liquid cargo (type N)), 8 (liquid cargo (type C)), 9 (gas)]</p> <p>(O) lg_pbr = (publication reference)</p> <p>(C) SORDAT = [YYYYMMDD]</p> <p>(C) SORIND = (Refer to Section B, General Guidance)</p>
--	--	---

## V - Abbreviations

ADN	Agreement on the Transport of Dangerous Goods on Inland Waterways
CEMT	Conference of European Maritime Transportation
CEVNI	European Code for Inland Waterways of the Economic Commission for Europe of the United Nations
CO	Company
Corp	Corporation
Dbn	Daybeacon
DSPM	Data set parameter
DSPM	Data Set Field Parameter
ECDIS	Electronic Chart Display and Information Systems
Hwy	Highway
IALA	International Association of Lighthouse Authorities
IEHG	Inland ENC Harmonization Group
IENC	Inland Electronic Navigational Chart
IHO	International Hydrographic Organisation
INTU	Intended usage subfield
ISO	International Standard Organisation
ISRS	International standard for electronic ship reporting in inland navigation
IVS	Reporting and Information system for inland navigation in the Netherlands
I-xx	Interstate, where xx equals interstate number
JPEG	standardized image file format of the Joint Photographic Expert Group
LDB	Left Descending Bank
Ldg	Landing
LL	Light List number
Lt	Light
MIB	Reporting and Information system for inland navigation in Germany
No	Number
RACON	Radar Transformer Beacon
RDB	Right Descending Bank
RIS	River Information Services
RR	Railway, railroad
SOTE	Skin of the Earth, (Group I features)

TIFF	Tagged Image File Format
UN	United Nations
UNECE	European Commission for Europe of the United Nations
UNLOCODE	Location Codes of the United Nations
USACE	US Army Corps of Engineers
VHF	Very High Frequency Radio
VTS	Vessel Traffic Services
XML	Extended Markup Language

## W - Naming Conventions

Bridges	Hwy,RR/Bridge Name Bridge (e.g.,Kansas City Southern RR Swing Bridge)
Cities and Towns	St. Louis, MO Vicksburg, MS
Interstates/Highways	I-90 Hwy 20
Railways	Kansas City Southern RR Union Pacific RR

## X - References

IHO S-57 Standard	IHO TRANSFER STANDARD for DIGITAL HYDROGRAPHIC DATA Edition 3.1 - November 2000
S-57 Appendix A	IHO Object Catalogue Edition 3.1 - November 2000
S-57 Appendix B.1	ENC Product Specification Edition 2.0 - November 2000
S-57 Appendix B.1, Annex A	Use of the Object Catalogue Edition 2.1 - April 2002



















## Y - Regions

BR	Brazil
EU	Europe
RU	Russian Federation
US	United States






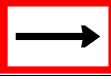















## Z - Record of Changes






















Section B   Letter H   W. Haupt	Modified: Letter H – Replaced “terminal code or passage point code” with “Object Reference Code”.
Section B   Letter K   B. Birkhuber	Added: Letter K – Collection Features Extending Beyond Cell Boundaries
DRVAL1 / DRVAL2   D.1.4, G.2.7, I.1.1, I.1.2, I.1.3, I.1.5, I.1.6, I.1.7, I.1.9   D. LaDue	Modified: Object Encoding - DRVAL1 & DRVAL2 changed to 2 decimal digits for consistency with the Feature Catalogue.
ISRS Location Code   85 Replacements   W. Haupt	Modified: Changed all incidents of “ISRS Code” with “ISRS Location Code”
M_UNIT   1.3.4, M.1.3, M.1.4, O.3.1   B. Birkhuber	Modified: Object Encoding – replaced the text “united defined in the M_UNIT meta object class” with “unit defined in the cell header”
verdat   C.1.4, C.1.5, G.1.*, G.3.3, G.3.4, G.3.7, G.3.20, G.4.5, G.4.8, G.4.9, I.3.5   G. Morlion	Removed: Attribute value 44 (Tweede Algemene Waterpassing) from the list of verdat values – TAW is a reference level, not a vertical datum
G.1.2   Bridge with Bridge Arches   G. Morlion	Modified: Encoding Instruction B – added CEMT class IVa and above. Modified: Replaced bridge diagram.
G.1.8   Overhead Cable   W. Haupt	Modified: Object Encoding - changed VERCLR to 1 decimal digit.
G.3.24   Pile or Post   R. Visser	Added: Object Encoding of (C) OBJNAM Added: Encoding Instruction Letter E – instructions for encoding OBJNAM
I.3.1   Depth Indicator   B. Birkhuber	Added: Encoding Instruction Letter D – instructions for populating OBJNAM and the conditions for use of C_AGGR Added: Object Encoding for OBJNAM & NOBJNM
I.3.4   Waterway Gauge   B. Birkhuber	Added: Encoding Instruction Letter M – instructions for populating OBJNAM and the conditions for use of C_AGGR
I.3.4   Waterway Gauge   J. Nemeth	Modified: Object Encoding – changed ELEVAT to 2 decimal digits
I.3.4   Waterway Profile   G. Morlion	Added: Object Encoding of (C) verdat Modified: Encoding Instruction Letter J – ‘vcrlev’ changed to ‘sdrlev’
L.3.3   Distance Mark Ashore   G. Morlion	Modified: Definition of Distance Mark Ashore
M.1.3   Berth without Transhipment / Fleeting Areas   G. Morlion	Added: Object Encoding for QUASOU, SOUACC, verdat Added: Encoding Instruction letter P Modified: Object Encoding for DRVAL1
M.1.4   Transhipment Berth   G. Morlion	Added: Object Encoding for QUASOU, SOUACC, verdat Added: Encoding Instruction letter P Modified: Object Encoding for DRVAL1
N.1.1   Bridge Light   J. Nemeth	Modified: Replaced IENC Symbolization Graphic for bridge lights. New graphic portrays the use of ORIENT
N.1.5   Sector Light   B. Birkhuber	Added: Encoding Instruction Letter M – instructions for encoding an oscillating light





















# Annex AA - Notice Marks (CEVNI)






















catnmk ID	Meaning	CEVNI	Picture	Area of Impact	Objects / (Attributes)
1	no entry (general sign)	A.1		no area, when at a bridge, otherwise bank to bank	resare (restrn = 7)
2	sections closed to use, no entry except for non-motorized small craft				resare (restrn = 8)
3	no overtaking	A.2		bank to bank	resare (restrn = 28)
4	no overtaking of convoys by convoys	A.3		bank to bank	resare (restrn = 29)
5	no passing or overtaking	A.4		bank to bank	resare (restrn = 30)
6	no berthing (i.e. no anchoring or making fast to the bank) on the side of the waterway on which the sign is placed	A.5		bank to fairway	resare (restrn = 1, 31)
7	no berthing on the stretch of water whose breadth, measured from the sign, is shown in metres on the sign	A.5.1		bank to indicated distance	resare (restrn = 1, 31)
8	no anchoring or trailing of anchors, cables or chains on the side of the waterway on which the sign is placed	A.6		bank to fairway or bank to bank if the sign is placed on both banks	resare (restrn = 1)
9	no making fast to the bank on the side of the waterway on which the sign is placed	A.7		bank to fairway	resare (restrn = 31) (restrn = 38 if applicable)
10	no turning	A.8		bank to bank	resare (restrn = 35)
11	do not create wash likely to cause damage	A.9		bank to bank or bank to middle of fairway depending on the size of the waterway	resare (restrn = 13)
12	no passing on left side (in openings of bridges or weirs)	A.10			
13	no passing on right side (in openings of bridges or weirs)	A.10			
14	motorized craft prohibited	A.12		bank to bank	resare (restrn = 8, INFORM = motorized craft prohibited)
15	sports or pleasure craft prohibited	A.13			
16	water skiing prohibited	A.14			
17	sailing vessels prohibited	A.15			
18	all craft other than motorized vessels or sailing craft prohibited	A.16			












19	use of sailboards prohibited	A.17			
20	water bikes prohibited	A.20			
21	end of zone authorized for high speed navigation of small sport and pleasure craft	A.18			
22	no launching or beaching of vessels	A.19			
23	proceed in left direction	B.1			
24	proceed in right direction	B.1			
25	move to the side of the fairway on your port side	B.2a			
26	move to the side of the fairway on your starboard side	B.2b			
27	keep the side of the fairway on your port side	B.3a			
28	keep the side of the fairway on your starboard side	B.3b			
29	cross fairway to port	B.4a			
30	cross fairway to starboard	B.4b			
31	stop as prescribed in the Regulations	B.5			
32	do not exceed the speed indicated (in km/h)	B.6		bank to bank	resare (restrn = 27, INFORM = 12 km/h)
33	give a sound signal	B.7			
34	keep a particularly sharp lookout	B.8			
35	do not enter the main waterway until certain that this will not oblige vessels proceeding on it to change their course or speed	B.9a			
36	do not cross the main waterway until certain that this will not oblige vessels proceeding on it to change their course or speed	B.9b			
37	obligation to enter into a radiotelephone link on the channel as indicated on the board	B.11		bank to bank	comare (catcom, COMCHA = 11, STATUS = 9)
38	depth of water limited	C.1			resare (restrn = 36, INFORM = 2.20 m)
39	headroom limited	C.2			











40	width of passage or channel limited	C.3			resare (restrn = 37, INFORM = 45 m)
41	there are restrictions on navigation: see the information plate below the sign	C.4			
42	the channel lies at a distance from the left bank; the figure shown on the sign indicates the distance in metres, measured from the sign, to which vessels should keep	C.5		bank to distance	resare (restrn = 7)
43	the channel lies at a distance from the right bank; the figure shown on the sign indicates the distance in metres, measured from the sign, to which vessels should keep	C.5		bank to distance	resare (restrn = 7)
44	recommended channel in both directions (at bridges)	D.1a			
45	recommended channel only in the direction indicated (passage in the opposite direction prohibited) (at bridges)	D.1b			
46	you are recommended to keep on right side (in openings of bridges and weirs)	D.2			
47	you are recommended to keep on left side (in openings of bridges and weirs)	D.2			
48	you are recommended to proceed in the left direction	D.3			
49	you are recommended to proceed in the right direction	D.3			
50	entry permitted (general sign)	E.1			
51	overhead cable crossing	E.2			
52	weir	E.3			
53	ferry-boat not moving independently	E.4a			
54	ferry-boat moving independently	E.4b			
55	berthing (i.e. anchoring or making fast to the bank) permitted on the side of the waterway on which the sign is placed	E.5			achare, achbrt, berths
56	berthing permitted on the stretch of water of the breadth measured from, and shown on the board in metres	E.5.1			achare, achbrt, berths
57	berthing permitted on the stretch of water bounded by the two distances measured from, and shown on the board in metres	E.5.2			achare, achbrt, berths
58	maximum number of vessels permitted to berth abreast on the side of the waterway on which the sign is placed	E.5.3			achare, achbrt, berths
59	berthing area reserved for pushing-navigation vessels that are not required to carry blue lights or blue cones on the side of the waterway on which the sign is placed	E.5.4			achare, achbrt, berths (catach = 10/catbrt = 4, clsdng = 4)
60	berthing area reserved for pushing-navigation vessels that are required to carry one blue light or one blue cone on the side of the waterway on which the sign is placed	E.5.5			achare, achbrt, berths (catach = 10/catbrt = 4, clsdng = 1)

61	berthing area reserved for pushing-navigation vessels that are required to carry two blue lights or two blue cones on the side of the waterway on which the sign is placed	E.5.6			achare, achbrt, berths (catach = 10/catbrt = 4, clsdng = 2)
62	berthing area reserved for pushing-navigation vessels that are required to carry three blue lights or three blue cones on the side of the waterway on which the sign is placed	E.5.7			achare, achbrt, berths (catach = 10/catbrt = 4, clsdng = 3)
63	berthing area reserved for vessels other than pushing-navigation vessels that are not required to carry blue lights or blue cones on the side of the waterway on which the sign is placed	E.5.8			achare, achbrt, berths (catach = 11/catbrt = 5, clsdng = 4)
64	berthing area reserved for vessels other than pushing-navigation vessels that are required to carry one blue light or one blue cone on the side of the waterway on which the sign is placed	E.5.9			achare, achbrt, berths (catach = 11/catbrt = 5, clsdng = 1)
65	berthing area reserved for vessels other than pushing-navigation vessels that are required to carry two blue lights or two blue cones on the side of the waterway on which the sign is placed	E.5.10			achare, achbrt, berths (catach = 11/catbrt = 5, clsdng = 2)
66	berthing area reserved for vessels other than pushing-navigation vessels that are required to carry three blue lights or three blue cones on the side of the waterway on which the sign is placed	E.5.11			achare, achbrt, berths (catach = 11/catbrt = 5, clsdng = 3)
67	berthing area reserved for all vessels that are not required to carry blue lights or blue cones on the side of the waterway on which the sign is placed	E.5.12			achare, achbrt, berths (clsdng = 4)
68	berthing area reserved for all vessels that are required to carry one blue light or one blue cone on the side of the waterway on which the sign is placed	E.5.13			achare, achbrt, berths (clsdng = 1)
69	berthing area reserved for all vessels that are required to carry two blue lights or two blue cones on the side of the waterway on which the sign is placed	E.5.14			achare, achbrt, berths (clsdng = 2)
70	berthing area reserved for all vessels that are required to carry three blue lights or three blue cones on the side of the waterway on which the sign is placed	E.5.15			achare, achbrt, berths (clsdng = 3)
71	anchoring or trailing of anchors, cables or chains permitted on the side of the waterway on which the sign is placed	E.6			achare, achbrt
72	making fast to the bank permitted on the side of the waterway on which the sign is placed	E.7			berths
73	berthing area reserved for loading and unloading vehicles	E.7.1			berths
74	turning area	E.8			trnbsn
75	crossing with secondary waterway ahead	E.9a			
76	secondary waterway ahead on the right	E.9b			
77	secondary waterway ahead on the left	E.9c			
78	secondary waterway ahead (main waterway right)	E.9d			
79	secondary waterway ahead (main waterway left)	E.9e			
80	secondary waterway left (main waterway right)	E.9f			



















81	secondary waterway right (main waterway left)	E.9g			
82	secondary waterway ahead and left (main waterway right)	E.9h			
83	secondary waterway ahead and right (main waterway left)	E.9i			
84	crossing with main waterway ahead	E.10a			
85	junction with main waterway ahead	E.10b			
86	junction with main waterway ahead and right	E.10c			
87	junction with main waterway ahead and left	E.10d			
88	junction with main waterway ahead and right (secondary waterway left)	E.10e			
89	junction with main waterway ahead and left (secondary waterway right)	E.10.f			
90	end of prohibition or obligation applying to traffic in one direction only, or end of a restriction	E.11			
91	drinking-water supply	E.13			
92	telephone	E.14			
93	motorized vessels permitted	E.15		bank to fairway or bank to bank depending on local situation	CTNARE (INFORM = motorized vessels permitted)
94	sport and pleasure craft permitted	E.16		bank to fairway or bank to bank depending on local situation	CTNARE (INFORM = sport and pleasure craft permitted)
95	water skiing permitted	E.17		bank to fairway or bank to bank depending on local situation	CTNARE (INFORM = water skiing permitted)
96	sailing vessels permitted	E.18		bank to fairway or bank to bank depending on local situation	CTNARE (INFORM = sailing vessels permitted)
97	craft other than motorized vessels or sailing craft permitted	E.19		bank to fairway or bank to bank depending on local situation	CTNARE (INFORM = craft other than motorized vessels or sailing craft permitted)
98	use of sailboards permitted	E.20		bank to fairway or bank to bank depending on local situation	CTNARE (INFORM = use of sailboards permitted)
99	possibility of obtaining nautical information by radio-telephone on the channel indicated	E.23		bank to bank	come (catcom, COMCHA = 11, STATUS = 3)
100	water bikes permitted	E.24		bank to fairway	CTNARE (INFORM = water bikes permitted)
101	zone authorized for high speed navigation of small sport and pleasure craft	E.21		bank to fairway or bank to bank depending on local situation	CTNARE (INFORM = zone authorized for high speed navigation of small sport and pleasure craft)

102	launching or beaching of vessels permitted	E.22		bank to fairway	CTNARE (INFORM = launching or beaching of vessels permitted)
110	wreck pontoon, passage allowed on side showing red-white sign				
111	wreck pontoon, passage allowed on both signs				
117	electrical power supply point	E.25			
118	winter harbor	E.26			
119	maximum number of vessels permitted to berth in winter harbor	E.26.1			
120	winter shelter	E.27			
121	maximum number of vessels permitted to berth in winter shelter maximum number of vessels permitted to berth abreast maximum number of rows of vessels which are berthed abreast	E.27.1			
122	use of spuds permitted	E.6.1			












# Annex AB - Notice Marks (Russian Inland Waterway Regulations)

catrnmk ID	Meaning	Russian IW Regulations GOST 26600-98	Picture	Area of Impact	Objects / (Attributes)
5	no passing or overtaking	1.3		bank to bank	resare (restrn = 30)
8	no anchoring or trailing of anchors, cables or chains	1.1		bank to fairway	resare (restrn = 1)
11	do not create wash	1.4		bank to bank	resare (restrn = 13)
39	headroom limited	2.4			
74	turning area	3.2			
112	no passing or overtaking of convoys	1.2		bank to bank	resare (restrn = 30, INFORM = no passing or overtaking of convoys)
113	small crafts prohibited	1.5		bank to bank	resare (INFORM = small crafts prohibited)
114	Attention! (Keep caution)	2.1			
115	fairway crossing	2.2			
116	shipping inspection point	3.3			

# Annex AC - Notice Marks (Brazilian Two Sides System)











catnmk ID	Meaning	Picture	Bank	Area of Impact	Function	Objects / (Attributes)
8	no anchoring or trailing of anchors, cables or chains		left (bnkwtw_1)	upstream (dirimp_1) or downstream (dirimp_2)	Prohibition mark (fnctnm_1)	resare (restrn = 1)
8	no anchoring or trailing of anchors, cables or chains		right (bnkwtw_2)	upstream (dirimp_1) or downstream (dirimp_2)	Prohibition mark (fnctnm_1)	resare (restrn = 1)
39	headroom limited		left (bnkwtw_1)	upstream (dirimp_1) or downstream (dirimp_2)	Restriction mark (fnctnm_3)	
39	headroom limited		right (bnkwtw_2)	upstream (dirimp_1) or downstream (dirimp_2)	Restriction mark (fnctnm_3)	
103	proceed close to the margin on your portside		left (bnkwtw_1)	downstream (dirimp_2)	Regulation mark (fnctnm_2)	
103	proceed close to the margin on your portside		right (bnkwtw_2)	upstream (dirimp_1)	Regulation mark (fnctnm_2)	
104	proceed close to the margin on your starboard side		left (bnkwtw_1)	upstream (dirimp_1)	Regulation mark (fnctnm_2)	
104	proceed close to the margin on your starboard side		right (bnkwtw_2)	downstream (dirimp_2)	Regulation mark (fnctnm_2)	
105	proceed in the middle of the river		left (bnkwtw_1)	upstream (dirimp_1) or downstream (dirimp_2)	Regulation mark (fnctnm_2)	
105	proceed in the middle of the river		right (bnkwtw_2)	upstream (dirimp_1) or downstream (dirimp_2)	Regulation mark (fnctnm_2)	
106	cross river to port		left (bnkwtw_1)	upstream (dirimp_1)	Regulation mark (fnctnm_2)	
106	cross river to port		right (bnkwtw_2)	downstream (dirimp_2)	Regulation mark (fnctnm_2)	
107	cross river to starboard		left (bnkwtw_1)	downstream (dirimp_2)	Regulation mark (fnctnm_2)	
107	cross river to starboard		right (bnkwtw_2)	upstream (dirimp_1)	Regulation mark (fnctnm_2)	
108	traffic between margins		left (bnkwtw_1)	upstream (dirimp_1) or downstream (dirimp_2)	Information mark (fnctnm_5)	CTNARE
108	traffic between margins		right (bnkwtw_2)	upstream (dirimp_1) or downstream (dirimp_2)	Information mark (fnctnm_5)	CTNARE
109	reduce speed		left (bnkwtw_1)	upstream (dirimp_1) or downstream (dirimp_2)	Regulation mark (fnctnm_2)	resare (restrn = 27)
109	reduce speed		right (bnkwtw_2)	upstream (dirimp_1) or downstream (dirimp_2)	Regulation mark (fnctnm_2)	resare (restrn = 27)

## Annex AD - Notice Marks (Brazilian Side Independent System)

catnmk ID	Meaning	Picture	Area of Impact	Function	Objects / (Attributes)
8	no anchoring or trailing of anchors, cables or chains		upstream (dirimp_1) or downstream (dirimp_2)	Prohibition mark (fnctnm_1)	resare (restrn = 1)
39	headroom limited		upstream (dirimp_1) or downstream (dirimp_2)	Restriction mark (fnctnm_3)	
82	secondary waterway ahead on the left, main waterway on the right		upstream (dirimp_1) or downstream (dirimp_2)	Information mark (fnctnm_5)	
83	secondary waterway ahead on the right, main waterway on the left		upstream (dirimp_1) or downstream (dirimp_2)	Information mark (fnctnm_5)	
103	proceed close to the margin on your portside		upstream (dirimp_1) or downstream (dirimp_2)	Regulation mark (fnctnm_2)	
104	proceed close to the margin on your starboard side		upstream (dirimp_1) or downstream (dirimp_2)	Regulation mark (fnctnm_2)	
105	proceed in the middle of the river		upstream (dirimp_1) or downstream (dirimp_2)	Regulation mark (fnctnm_2)	
106	cross river to port		upstream (dirimp_1) or downstream (dirimp_2)	Regulation mark (fnctnm_2)	
107	cross river to starboard		upstream (dirimp_1) or downstream (dirimp_2)	Regulation mark (fnctnm_2)	
108	traffic between margins		upstream (dirimp_1) or downstream (dirimp_2)	Information mark (fnctnm_5)	CTNARE
109	reduce speed		upstream (dirimp_1) or downstream (dirimp_2)	Regulation mark (fnctnm_2)	resare (restrn = 13)



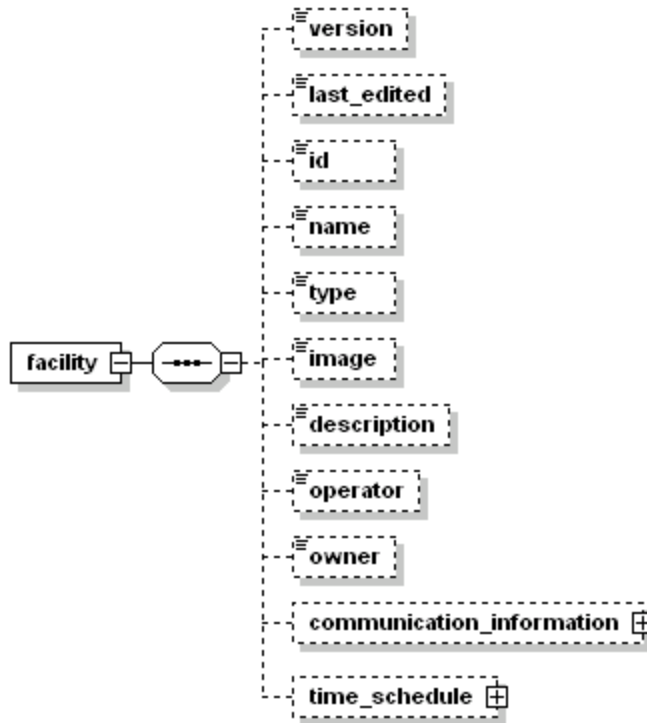
# Annex AE - Notice Marks (Brazilian Paraguay-Parana Waterway)

catnmk ID	Meaning	Picture	Bank	Area of Impact	Function	Objects / (Attributes)
82	secondary waterway ahead on the left, main waterway on the right		left (bnkwtw_1)	upstream (dirimp_1) or downstream (dirimp_2)	Information mark (fctnm_5)	
82	secondary waterway ahead on the left, main waterway on the right		right (bnkwtw_2)	upstream (dirimp_1) or downstream (dirimp_2)	Information mark (fctnm_5)	
83	secondary waterway ahead on the right, main waterway on the left		left (bnkwtw_1)	upstream (dirimp_1) or downstream (dirimp_2)	Information mark (fctnm_5)	
83	secondary waterway ahead on the right, main waterway on the left		right (bnkwtw_2)	upstream (dirimp_1) or downstream (dirimp_2)	Information mark (fctnm_5)	
103	proceed close to the margin on your portside		left (bnkwtw_1)	downstream (dirimp_2)	Regulation mark (fctnm_2)	
103	proceed close to the margin on your portside		right (bnkwtw_2)	upstream (dirimp_1)	Regulation mark (fctnm_2)	
104	proceed close to the margin on your starboard side		left (bnkwtw_1)	upstream (dirimp_1)	Regulation mark (fctnm_2)	
104	proceed close to the margin on your starboard side		right (bnkwtw_2)	downstream (dirimp_2)	Regulation mark (fctnm_2)	
105	proceed in the middle of the river		left (bnkwtw_1)	upstream (dirimp_1) or downstream (dirimp_2)	Regulation mark (fctnm_2)	
105	proceed in the middle of the river		right (bnkwtw_2)	upstream (dirimp_1) or downstream (dirimp_2)	Regulation mark (fctnm_2)	
106	cross river to port		left (bnkwtw_1)	upstream (dirimp_1)	Regulation mark (fctnm_2)	
106	cross river to port		right (bnkwtw_2)	downstream (dirimp_2)	Regulation mark (fctnm_2)	
107	cross river to starboard		left (bnkwtw_1)	downstream (dirimp_2)	Regulation mark (fctnm_2)	
107	cross river to starboard		right (bnkwtw_2)	upstream (dirimp_1)	Regulation mark (fctnm_2)	

Schema File Name: **facility\_2.0.xsd**  
 Schema File Location: **http://eg.ris.eu/sites/default/files/facility\_2.0\_0.xsd**  
 Target Namespace: **http://www.openecdis.org/**

## element facility

diagram



namespace **http://www.openecdis.org**

properties **isRef**  
**content complex**

children **version last\_edited id name type image description operator owner communication\_information time\_schedule**

```


source <xs:element name="facility">
  <xs:complexType>
    <xs:sequence>
      <xs:element name="version" type="xs:positiveInteger" minOccurs="0"/>
      <xs:element name="last_edited" type="xs:string" minOccurs="0"/>
      <xs:element name="id" type="xs:string" minOccurs="0"/>
      <xs:element name="name" type="xs:string" minOccurs="0"/>
      <xs:element name="type" type="TFacilityType" minOccurs="0"/>
      <xs:element name="image" type="xs:anyURI" minOccurs="0"/>
      <xs:element name="description" type="xs:string" minOccurs="0"/>
      <xs:element name="operator" type="xs:string" minOccurs="0"/>
      <xs:element name="owner" type="xs:string" minOccurs="0"/>
      <!-- COMMUNICATION INFORMATION -->
      <xs:element name="communication_information" minOccurs="0">
        <xs:complexType>
          <xs:sequence>
            <xs:element name="address" type="TAddress" minOccurs="0"/>
            <xs:element name="contact" type="TContact" minOccurs="0" maxOccurs="unbounded"/>
            <xs:element name="radio_communication" type="TRadioCommunication" minOccurs="0"/>
            <xs:element name="remark" type="xs:string" minOccurs="0"/>
          </xs:sequence>
        </xs:complexType>
      </xs:element>
    </xs:sequence>
  </xs:complexType>
</xs:element>
  
```

```

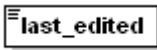
<!-- TIME SCHEDULE -->
<xs:element name="time_schedule" minOccurs="0">
  <xs:complexType>
    <xs:sequence>
      <xs:element name="type" minOccurs="0">
        <xs:simpleType>
          <xs:restriction base="xs:string">
            <xs:enumeration value="Operation"/>
            <xs:enumeration value="No Operation"/>
          </xs:restriction>
        </xs:simpleType>
      </xs:element>
      <xs:element name="valid" minOccurs="0">
        <xs:complexType>
          <xs:sequence>
            <xs:element name="from" type="xs:date"/>
            <xs:element name="to" type="xs:date"/>
          </xs:sequence>
        </xs:complexType>
      </xs:element>
      <xs:element name="individual_schedule" minOccurs="0">
        <xs:complexType>
          <xs:sequence>
            <xs:element name="day" type="TDay" maxOccurs="unbounded"/>
          </xs:sequence>
        </xs:complexType>
      </xs:element>
      <xs:element name="regular_schedule" minOccurs="0">
        <xs:complexType>
          <xs:sequence>
            <xs:element name="period" type="TPeriod" maxOccurs="unbounded"/>
          </xs:sequence>
        </xs:complexType>
      </xs:element>
      <xs:element name="remark" type="xs:string" minOccurs="0"/>
    </xs:sequence>
  </xs:complexType>
</xs:element>

```

#### element facility/version

diagram   
 namespace <http://www.openecdis.org/>  
 type **xs:positiveinteger**  
 properties isRef 0  
           content simple  
 source <xs:element name="version" type="xs:positiveInteger" minOccurs="0"/>

#### element facility/last\_edited

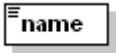
diagram   
 namespace <http://www.openecdis.org/>  
 type **xs:string**  
 properties isRef 0  
           content simple  
 source <xs:element name="last\_edited" type="xs:string" minOccurs="0"/>

#### element facility/id

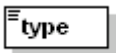
diagram   
 namespace <http://www.openecdis.org/>

type **xs:string**  
properties isRef 0  
content simple  
source `<xs:element name="id" type="xs:string" minOccurs="0"/>`


#### element facility/name

diagram   
namespace `http://www.openecdis.org/`  
type **xs:string**  
properties isRef 0  
content simple  
source `<xs:element name="name" type="xs:string" minOccurs="0"/>`


#### element facility/type

diagram   
namespace `http://www.openecdis.org/`  
type **TFacilityType**  
properties isRef 0  
content simple  
facets Lock  
Bridge  
Port Facility  
Navigation Authority  
Port Authority  
Other Authority  
Water Police  
Berth  
Bunker Station  
Waste Reception  
Cargo Terminal  
Passenger Terminal  
Other  
source `<xs:element name="type" type="TFacilityType" minOccurs="0"/>`


#### element facility/image

diagram   
namespace `http://www.openecdis.org/`  
type **xs:anyURL**  
properties isRef 0  
content simple  
source `<xs:element name="image" type="xs:anyURI" minOccurs="0"/>`

#### element facility/description

diagram   
namespace `http://www.openecdis.org/`  
type **xs:string**  
properties isRef 0  
content simple  
source `<xs:element name="description" type="xs:string" minOccurs="0"/>`

## element facility/operator

diagram 


namespace `http://www.openecdis.org/`

type **xs:string**

properties isRef 0  
content simple

source `<xs:element name="operator" type="xs:string" minOccurs="0"/>`

## element facility/owner

diagram 

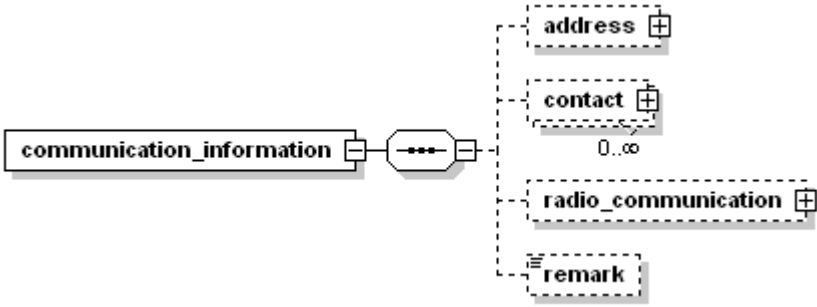
namespace `http://www.openecdis.org/`

type **xs:string**

properties isRef 0  
content simple

source `<xs:element name="owner" type="xs:string" minOccurs="0"/>`

## element facility/communication\_information

diagram 

namespace `http://www.openecdis.org/`

properties isRef 0  
content complex

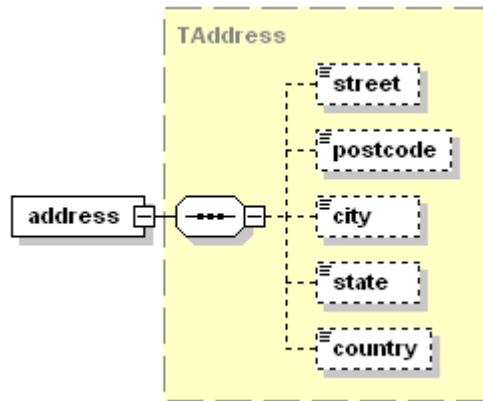
children **address contact radio\_communication remark**

source 

```
<xs:element name="communication_information" minOccurs="0">
  <xs:complexType>
    <xs:sequence>
      <xs:element name="address" type="TAddress" minOccurs="0"/>
      <xs:element name="contact" type="TContact" minOccurs="0" maxOccurs="unbounded"/>
      <xs:element name="radio_communication" type="TRadioCommunication" minOccurs="0"/>
      <xs:element name="remark" type="xs:string" minOccurs="0"/>
    </xs:sequence>
  </xs:complexType>
</xs:element>
```

## element facility/communication\_information/address

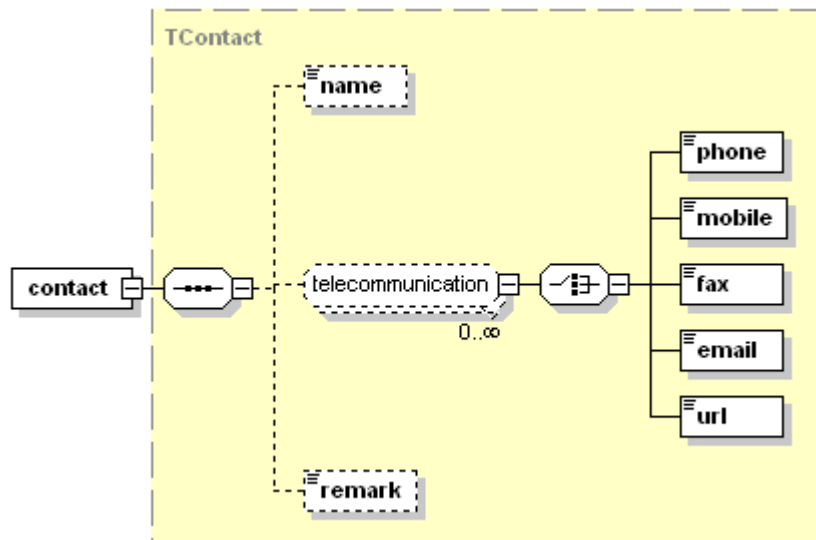
diagram



namespace <http://www.openecdis.org/>  
type **TAddress**  
properties isRef 0  
content complex  
children **street postcode city state country**  
source `<xs:element name="address" type="TAddress" minOccurs="0"/>`

### element facility/communication\_information/contact

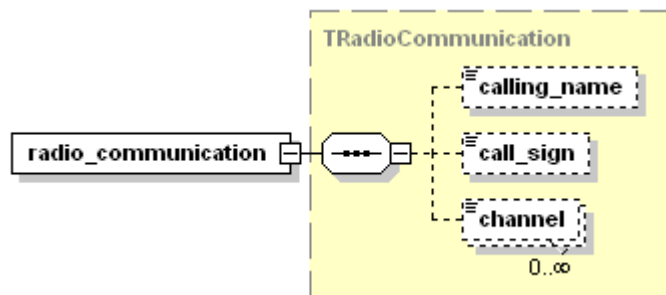
diagram



namespace <http://www.openecdis.org/>  
type **TContact**  
properties isRef 0  
content complex  
children **name phone mobile fax email url remark**  
source `<xs:element name="contact" type="TContact" minOccurs="0" maxOccurs="unbounded"/>`

### element facility/communication\_information/radio\_communication

diagram



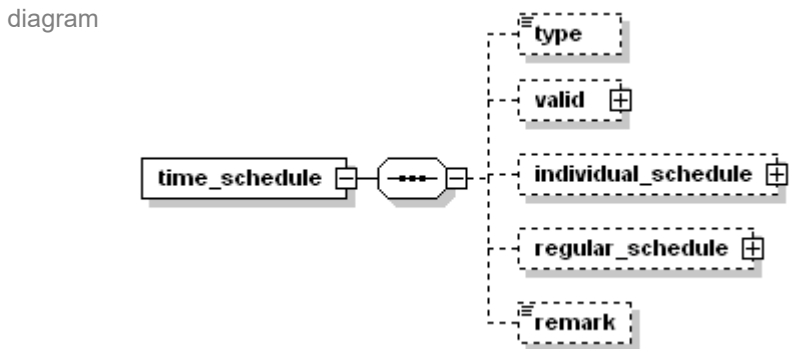
namespace `http://www.openecdis.org/`  
 type **TRadioCommunication**  
 properties `isRef 0`  
           content `complex`  
 children **calling\_name call\_sign channel**  
 source `<xs:element name="radio_communication" type="TRadioCommunication" minOccurs="0"/>`

#### element facility/communication\_information/remark



namespace `http://www.openecdis.org/`  
 type **xs:string**  
 properties `isRef 0`  
           content `simple`  
 source `<xs:element name="remark" type="xs:string" minOccurs="0"/>`

#### element facility/time\_schedule



namespace `http://www.openecdis.org/`  
 properties `isRef 0`  
           content `complex`  
 children **type valid individual\_schedule regular\_schedule remark**  
 source `<xs:element name="time_schedule" minOccurs="0">`

```

<xs:complexType>
  <xs:sequence>
    <xs:element name="type" minOccurs="0">
      <xs:simpleType>
        <xs:restriction base="xs:string">
          <xs:enumeration value="Operation"/>
          <xs:enumeration value="No Operation"/>
        </xs:restriction>
      </xs:simpleType>
    </xs:element>
    <xs:element name="valid" minOccurs="0">
      <xs:complexType>
        <xs:sequence>
          <xs:element name="from" type="xs:date"/>
          <xs:element name="to" type="xs:date"/>
        </xs:sequence>
      </xs:complexType>
    </xs:element>
    <xs:element name="individual_schedule" minOccurs="0">
      <xs:complexType>
        <xs:sequence>
          <xs:element name="day" type="TDay" maxOccurs="unbounded"/>
        </xs:sequence>
      </xs:complexType>
    </xs:element>
    <xs:element name="regular_schedule" minOccurs="0">
      <xs:complexType>
        <xs:sequence>
          <xs:element name="period" type="TPeriod" maxOccurs="unbounded"/>
        </xs:sequence>
      </xs:complexType>
    </xs:element>
    <xs:element name="remark" type="xs:string" minOccurs="0"/>
  </xs:sequence>
</xs:complexType>


```

```

    </xs:sequence>
  </xs:complexType>
</xs:element>
<xs:element name="remark" type="xs:string" minOccurs="0"/>
</xs:sequence>
</xs:complexType>
</xs:element>

```

### element facility/time\_schedule/type

diagram 

namespace <http://www.openecdis.org/>

type **xs:string**

properties isRef 0  
content simple

facets Operation  
No Operation

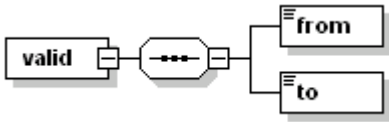
source 

```

<xs:element name="type" minOccurs="0">
  <xs:simpleType>
    <xs:restriction base="xs:string">
      <xs:enumeration value="Operation"/>
      <xs:enumeration value="No Operation"/>
    </xs:restriction>
  </xs:simpleType>
</xs:element>

```

### element facility/time\_schedule/valid

diagram 

namespace <http://www.openecdis.org/>

properties isRef 0  
content complex

children **from to**


source 

```

<xs:element name="valid" minOccurs="0">
  <xs:complexType>
    <xs:sequence>
      <xs:element name="from" type="xs:date"/>
      <xs:element name="to" type="xs:date"/>
    </xs:sequence>
  </xs:complexType>
</xs:element>

```

### element facility/time\_schedule/valid/from

diagram 

namespace <http://www.openecdis.org/>

type **xs:date**

properties isRef 0  
content simple

source 

```

<xs:element name="from" type="xs:date"/>

```

### element facility/time\_schedule/valid/to

diagram 

namespace <http://www.openecdis.org/>

type **xs:date**

properties isRef 0



content simple  
 source `<xs:element name="to" type="xs:date"/>`

### element facility/time\_schedule/individual\_schedule

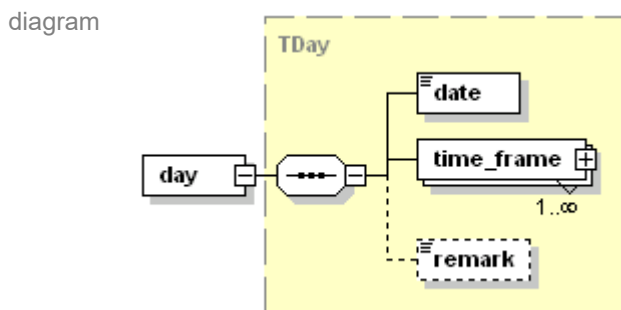


namespace `http://www.openecdis.org/`  
 properties isRef 0  
 content complex

children **day**

source `<xs:element name="individual_schedule" minOccurs="0">  
 <xs:complexType>  
 <xs:sequence>  
 <xs:element name="day" type="TDay" maxOccurs="unbounded"/>  
 </xs:sequence>  
 </xs:complexType>  
 </xs:element>`

### element facility/time\_schedule/individual\_schedule/day



namespace `http://www.openecdis.org/`  
 type **TDay**  
 properties isRef 0  
 content complex

children **date time\_frame remark**

source `<xs:element name="day" type="TDay" maxOccurs="unbounded"/>`

### element facility/time\_schedule/regular\_schedule



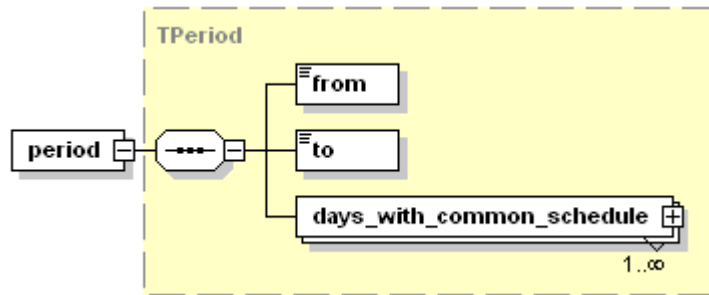
namespace `http://www.openecdis.org/`  
 properties isRef 0  
 content complex

children **period**

source `<xs:element name="regular_schedule" minOccurs="0">  
 <xs:complexType>  
 <xs:sequence>  
 <xs:element name="period" type="TPeriod" maxOccurs="unbounded"/>  
 </xs:sequence>  
 </xs:complexType>  
 </xs:element>`

### element facility/time\_schedule/regular\_schedule/period

diagram



namespace <http://www.openecdis.org/>  
type **TPeriod**  
properties isRef 0  
content complex  
children **from to days\_with\_common\_schedule**  
source `<xs:element name="period" type="TPeriod" maxOccurs="unbounded"/>`

### element facility/time\_schedule/remark

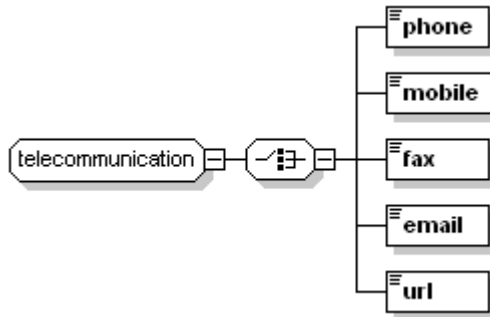
diagram



namespace <http://www.openecdis.org/>  
type **xs:string**  
properties isRef 0  
content simple  
source `<xs:element name="remark" type="xs:string" minOccurs="0"/>`

### group telecommunication

diagram

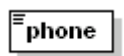


namespace <http://www.openecdis.org/>  
children **phone mobile fax email url**  
used by **Tcontact**  
source 

```
<xs:group name="telecommunication">
  <xs:choice>
    <xs:element name="phone" type="xs:string"/>
    <xs:element name="mobile" type="xs:string"/>
    <xs:element name="fax" type="xs:string"/>
    <xs:element name="email" type="xs:string"/>
    <xs:element name="url" type="xs:anyURI"/>
  </xs:choice>
</xs:group>
```

### element telecommunication/phone

diagram



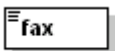
namespace <http://www.openecdis.org/>  
type **xs:string**  
properties isRef 0

content simple  
source `<xs:element name="phone" type="xs:string"/>`

### element telecommunication/mobile

diagram   
namespace `http://www.openecdis.org/`  
type **xs:string**  
properties isRef 0  
content simple  
source `<xs:element name="mobile" type="xs:string"/>`

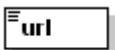
### element telecommunication/fax

diagram   
namespace `http://www.openecdis.org/`  
type **xs:string**  
properties isRef 0  
content simple  
source `<xs:element name="fax" type="xs:string"/>`

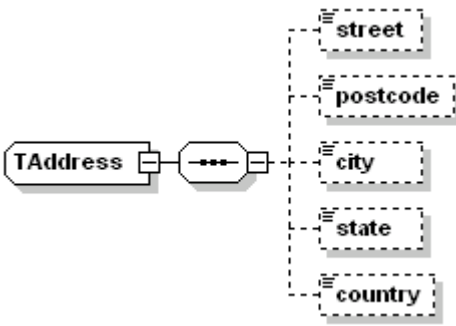
### element telecommunication/email

diagram   
namespace `http://www.openecdis.org/`  
type **xs:string**  
properties isRef 0  
content simple  
source `<xs:element name="email" type="xs:string"/>`

### element telecommunication/url

diagram   
namespace `http://www.openecdis.org/`  
type **xs:anyURL**  
properties isRef 0  
content simple  
source `<xs:element name="url" type="xs:anyURI"/>`

### complex type TAddress

diagram   
namespace `http://www.openecdis.org/`  
children **street postcode city state country**

used by **facility/communication\_information/address**

source 

```
<xs:complexType name="TAddress">
  <xs:sequence>
    <xs:element name="street" type="xs:string" minOccurs="0"/>
    <xs:element name="postcode" type="xs:string" minOccurs="0"/>
    <xs:element name="city" type="xs:string" minOccurs="0"/>
    <xs:element name="state" type="xs:string" minOccurs="0"/>
    <xs:element name="country" type="xs:string" minOccurs="0"/>
  </xs:sequence>
</xs:complexType>
```

#### element TAddress/street

diagram 

namespace <http://www.openecdis.org/>

type **xs:string**

properties isRef 0

content simple

source 

```
<xs:element name="street" type="xs:string" minOccurs="0"/>
```

#### element TAddress/postcode

diagram 

namespace <http://www.openecdis.org/>

type **xs:string**

properties isRef 0

content simple

source 

```
<xs:element name="postcode" type="xs:string" minOccurs="0"/>
```

#### element TAddress/city

diagram 

namespace <http://www.openecdis.org/>

type **xs:string**

properties isRef 0

content simple

source 

```
<xs:element name="city" type="xs:string" minOccurs="0"/>
```

#### element TAddress/state

diagram 

namespace <http://www.openecdis.org/>

type **xs:string**

properties isRef 0

content simple

source 

```
<xs:element name="state" type="xs:string" minOccurs="0"/>
```

#### element TAddress/country

diagram 

namespace <http://www.openecdis.org/>

type **xs:string**

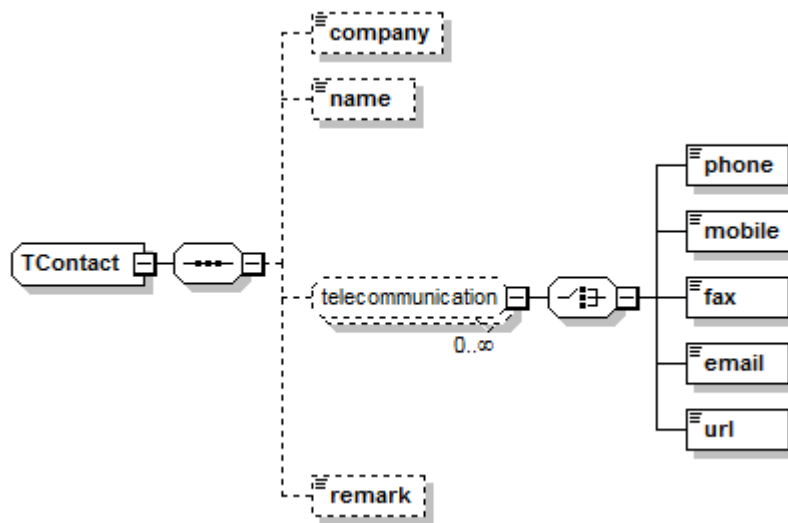
properties isRef 0

content simple

source `<xs:element name="country" type="xs:string" minOccurs="0"/>`

## complex type TContact

diagram



namespace `http://www.openecdis.org/`

children **company name phone mobile fax email url remark**

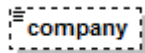
used by **facility/communication\_information/contact**

source `<xs:complexType name="TContact">`

```
<xs:sequence>
  <xs:element name="company" type="xs:string" minOccurs="0"/>
  <xs:element name="name" type="xs:string" minOccurs="0"/>
  <xs:group ref="telecommunication" minOccurs="0" maxOccurs="unbounded"/>
  <xs:element name="remark" type="xs:string" minOccurs="0"/>
</xs:sequence>
</xs:complexType>
```

## element TContact/company

diagram



namespace `http://www.openecdis.org/`

type **xs:string**

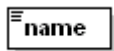
properties isRef 0

content simple

source `<xs:element name="company" type="xs:string" minOccurs="0"/>`

## element TContact/name

diagram



namespace `http://www.openecdis.org/`

type **xs:string**

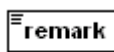
properties isRef 0

content simple

source `<xs:element name="name" type="xs:string" minOccurs="0"/>`

## element TContact/remark

diagram



namespace `http://www.openecdis.org/`

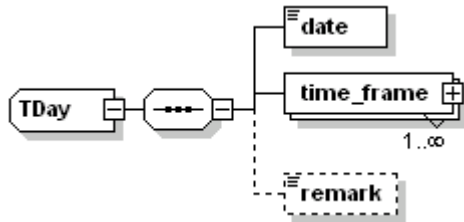
type **xs:string**

properties isRef 0

content simple  
 source `<xs:element name="remark" type="xs:string" minOccurs="0"/>`

### complex type TDay

diagram



namespace `http://www.openecdis.org/`  
 children **date time\_frame remark**  
 used by **facility/time\_schedule/individual\_schedule/day**  
 source 

```
<xs:complexType name="TDay">
  <xs:sequence>
    <xs:element name="date" type="xs:date"/>
    <xs:element name="time_frame" type="TTimeFrame" maxOccurs="unbounded"/>
    <xs:element name="remark" type="xs:string" minOccurs="0"/>
  </xs:sequence>
</xs:complexType>
```

### element TDay/date

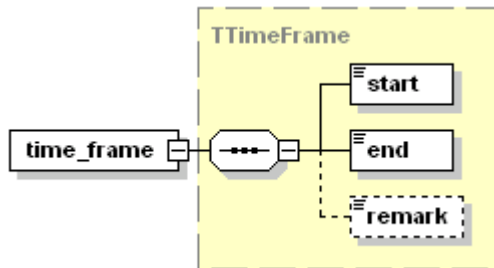
diagram



namespace `http://www.openecdis.org/`  
 type **xs:date**  
 properties isRef 0  
 content simple  
 source `<xs:element name="date" type="xs:date"/>`

### element TDay/time\_frame

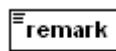
diagram



namespace `http://www.openecdis.org/`  
 type **TTimeFrame**  
 properties isRef 0  
 content complex  
 children **start end remark**  
 source `<xs:element name="time_frame" type="TTimeFrame" maxOccurs="unbounded"/>`

### element TDay/remark

diagram

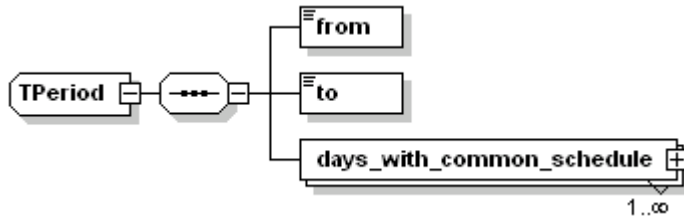


namespace `http://www.openecdis.org/`  
 type **xs:string**  
 properties isRef 0  
 content simple

source `<xs:element name="remark" type="xs:string" minOccurs="0"/>`

## complex type TPeriod

diagram



namespace `http://www.openecdis.org/`

children **from to days\_with\_common\_schedule**

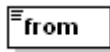
used by **facility/time\_schedule/regular\_schedule/period**

source 

```
<xs:complexType name="TPeriod">
  <xs:sequence>
    <xs:element name="from" type="xs:date"/>
    <xs:element name="to" type="xs:date"/>
    <xs:element name="days_with_common_schedule" maxOccurs="unbounded">
      <xs:complexType>
        <xs:sequence>
          <xs:element name="name_of_days" type="TListDays"/>
          <xs:element name="time_frame" type="TTimeFrame" maxOccurs="unbounded"/>
          <xs:element name="remark" type="xs:string" minOccurs="0"/>
        </xs:sequence>
      </xs:complexType>
    </xs:element>
  </xs:sequence>
</xs:complexType>
```

## element TPeriod/from

diagram



namespace `http://www.openecdis.org/`

type **xs:date**

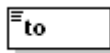
properties isRef 0

content simple

source `<xs:element name="from" type="xs:date"/>`

## element TPeriod/to

diagram



namespace `http://www.openecdis.org/`

type **xs:date**

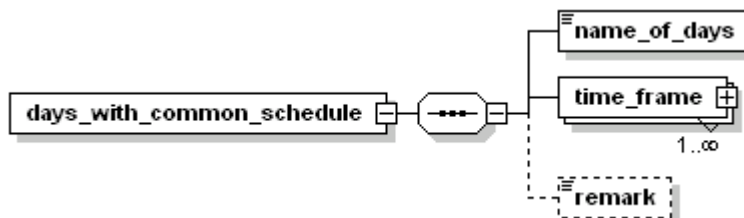
properties isRef 0

content simple

source `<xs:element name="to" type="xs:date"/>`

## element TPeriod/days\_with\_common\_schedule

diagram



namespace `http://www.openecdis.org/`

properties isRef 0

content complex  
 children **name\_of\_days time\_frame remark**  
 source 

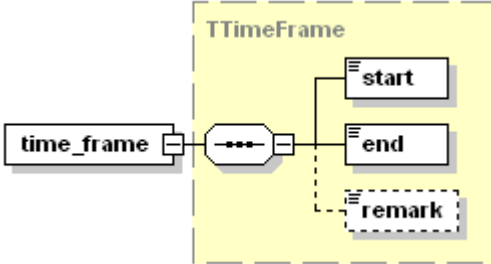
```
<xs:element name="days_with_common_schedule" maxOccurs="unbounded">
  <xs:complexType>
    <xs:sequence>
      <xs:element name="name_of_days" type="TListDays"/>
      <xs:element name="time_frame" type="TTimeFrame" maxOccurs="unbounded"/>
      <xs:element name="remark" type="xs:string" minOccurs="0"/>
    </xs:sequence>
  </xs:complexType>
</xs:element>
```

**element TPeriod/days\_with\_common\_schedule/name\_of\_days**

diagram   
 namespace <http://www.openecdis.org/>  
 type **TListDays**  
 properties isRef 0  
 content simple  
 source 


```
<xs:element name="name_of_days" type="TListDays"/>
```

**element TPeriod/days\_with\_common\_schedule/time\_frame**

diagram   
 namespace <http://www.openecdis.org/>  
 type **TTimeFrame**  
 properties isRef 0  
 content complex  
 children **start end remark**  
 source 

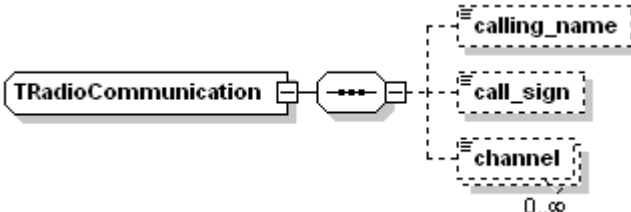
```
<xs:element name="time_frame" type="TTimeFrame" maxOccurs="unbounded"/>
```

**element TPeriod/days\_with\_common\_schedule/remark**

diagram   
 namespace <http://www.openecdis.org/>  
 type **xs:string**  
 properties isRef 0  
 content simple  
 source 

```
<xs:element name="remark" type="xs:string" minOccurs="0"/>
```

**complex type TRadioCommunication**

diagram   
 namespace <http://www.openecdis.org/>

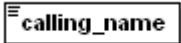


children **calling\_name call\_sign channel**  
used by **facility/communication\_information/radio\_communication**

source 

```
<xs:complexType name="TRadioCommunication">
  <xs:sequence>
    <xs:element name="calling_name" type="xs:string" minOccurs="0"/>
    <xs:element name="call_sign" type="xs:string" minOccurs="0"/>
    <xs:element name="channel" type="xs:positiveInteger" minOccurs="0" maxOccurs="unbounded"/>
  </xs:sequence>
</xs:complexType>
```

#### element TRadioCommunication/calling\_name

diagram 

namespace <http://www.openecdis.org/>

type **xs:string**

properties isRef 0

content simple

source 

```
<xs:element name="calling_name" type="xs:string" minOccurs="0"/>
```

#### element TRadioCommunication/call\_sign

diagram 

namespace <http://www.openecdis.org/>

type **xs:string**

properties isRef 0

content simple

source 

```
<xs:element name="call_sign" type="xs:string" minOccurs="0"/>
```

#### element TRadioCommunication/channel

diagram 

namespace <http://www.openecdis.org/>

type **xs:positiveinteger**

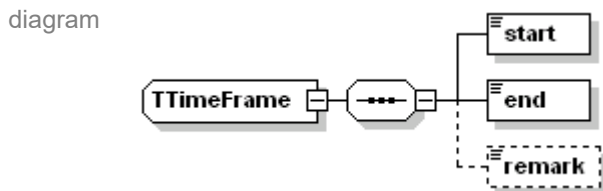
properties isRef 0

content simple

source 

```
<xs:element name="channel" type="xs:positiveInteger" minOccurs="0" maxOccurs="unbounded"/>
```

#### complex type TTimeFrame



namespace <http://www.openecdis.org/>

children **start end remark**

used by **TPeriod/days\_with\_common\_schedule/time\_frame TDay/time\_frame**

source 

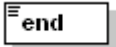
```
<xs:complexType name="TTimeFrame">
  <xs:sequence>
    <xs:element name="start" type="xs:string"/>
    <xs:element name="end" type="xs:string"/>
    <xs:element name="remark" type="xs:string" minOccurs="0"/>
  </xs:sequence>
</xs:complexType>
```

### element TTimeFrame/start

diagram 

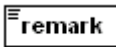
namespace <http://www.openecdis.org/>  
type **xs:time**  
properties isRef 0  
content simple  
source `<xs:element name="start" type="xs:time"/>`

### element TTimeFrame/end

diagram 

namespace <http://www.openecdis.org/>  
type **xs:time**  
properties isRef 0  
content simple  
source `<xs:element name="end" type="xs:time"/>`

### element TTimeFrame/remark

diagram 

namespace <http://www.openecdis.org/>  
type **xs:string**  
properties isRef 0  
content simple  
source `<xs:element name="remark" type="xs:string" minOccurs="0"/>`

### simple type TDays

diagram

namespace <http://www.openecdis.org/>  
type **restriction of xs:string**  
used by **TListDays**  
facets Monday  
Tuesday  
Wednesday  
Thursday  
Friday  
Saturday  
Sunday  
Public Holidays  
source 

```
<xs:simpleType name="TDays">
  <xs:restriction base="xs:string">
    <xs:enumeration value="Monday"/>
    <xs:enumeration value="Tuesday"/>
    <xs:enumeration value="Wednesday"/>
    <xs:enumeration value="Thursday"/>
    <xs:enumeration value="Friday"/>
    <xs:enumeration value="Saturday"/>
    <xs:enumeration value="Sunday"/>
    <xs:enumeration value="Public Holidays"/>
  </xs:restriction>
</xs:simpleType>
```

### simple type TFacilityType

diagram

namespace <http://www.openecdis.org/>  
 type **restriction of xs:string**  
 used by **facility/type**  
 facets  
 Lock  
 Bridge  
 Port Facility  
 Navigation Authority  
 Port Authority  
 Other Authority  
 Water Police  
 Berth  
 Bunker Station  
 Waste Reception  
 Cargo Terminal  
 Passenger Terminal  
 Other  
 source 

```
<xs:simpleType name="TFacilityType">
  <xs:restriction base="xs:string">
    <xs:enumeration value="Lock"/>
    <xs:enumeration value="Bridge"/>
    <xs:enumeration value="Port Facility"/>
    <xs:enumeration value="Navigation Authority"/>
    <xs:enumeration value="Port Authority"/>
    <xs:enumeration value="Other Authority"/>
    <xs:enumeration value="Water Police"/>
    <xs:enumeration value="Berth"/>
    <xs:enumeration value="Bunker Station"/>
    <xs:enumeration value="Waste Reception"/>
    <xs:enumeration value="Cargo Terminal"/>
    <xs:enumeration value="Passenger Terminal"/>
    <xs:enumeration value="Other"/>
  </xs:restriction>
</xs:simpleType>
```

### simple type TListDays

diagram  
 namespace <http://www.openecdis.org/>  
 type **list of TDays**  
 used by **TPeriod/days\_with\_common\_schedule/name\_of\_days**  
 source 

```
<xs:simpleType name="TListDays">
  <xs:list itemType="TDays"/>
</xs:simpleType>
```