

Guide for Permit Applicants

Information on applying for permits for work in waterways or wetlands

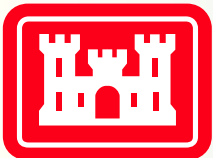

**US Army Corps
of Engineers**[®]
New England District

All written correspondence can be directed to:
Regulatory Division
US Army Engineer District, New England
696 Virginia Road
Concord, MA 01742-2751

Field Office

U.S Army Corps of Engineers
Vermont Project Office
11 Lincoln Street
Room 210
Essex Junction, Vermont 05452
802-872-2893

Maine

Augusta

Vermont



Montpelier

New Hampshire

Concord

Field Office

U.S. Army Corps of Engineers
Maine Project Office
675 Western Avenue #3
Manchester, Maine 04351

Massachusetts



Boston

Main Office

U.S. Army Corps of Engineers
New England District
696 Virginia Road
Concord, MA 01742
Attn: Regulatory Division

978-318-8338 or 8335,
or call toll-free 1-800-343-4789
(1-800-362-4367 from within Massachusetts)

Connecticut

Hartford

Providence

R.I.



US Army Corps
of Engineers ®
New England District

Introduction

This pamphlet provides specific guidance on how to apply for a permit from the New England District of the United States Army Corps of Engineers, Regulatory Division. It is designed to help you identify whether or not you need a permit and the type of permit you may require. It will also help you understand how to prepare the application materials and drawings required by the Corps of Engineers in order to apply for a permit.

A complete application will help prevent unnecessary delays in evaluating your permit. You should refer to Title 33, Code of Federal Regulations, Parts 320 through 330, for a full explanation of the Corps regulations. To review these regulations or to obtain additional information, contact the Corps of Engineers office nearest you or visit our web site at www.usace.army.mil.

TABLE OF CONTENTS

Part I.	
General Information.....	3
Authority for the Regulatory Program.....	3
Commonly Used Terms.....	4
Frequently Asked Questions.....	6
Part II.	
The Permit Application.....	9
Types of Permits.....	9
General Permits.....	9
Application	
Evaluating a General Permit	
Step-by-Step Procedure for Evaluating a Typical General Permit	
Individual Permits	11
Application	
Evaluating an Individual Permit	
Step-by-Step Procedure for Evaluating a Typical Individual Permit	
Forms of Authorization	
Fees	
Part III. Application Form.....	13
Part IV. Application Submittals.....	15
General Information	
Vicinity Map	
Plan View	
Elevation and/or Cross Section View	
Notes on Drawings	
Dredging Projects	
Highway Projects	
Utility Construction	
Part V. Sample Application Packages.....	18
Blank Application Form	
Additional Guidance for Section 404 Permit Applicants.....	19
Wetland Delineation	
Functions and Values	
Alternatives Assessment	
Resource Information.....	21

Part I.

General Information

This section provides information on the history of the Corps involvement with environmental regulations. It also outlines the laws giving the Corps authority to regulate activities in wetlands and waterways, defines commonly used terms and answers frequently asked questions.

Authority for the Regulatory Program

The U.S. Army Corps of Engineers has been regulating activities in the nation's waters since 1890. Until the 1960's, the primary purpose of the regulatory program was to protect navigation. Since then, new laws and court decisions have given the Corps the regulatory authority to protect the physical, chemical, and biological integrity of the Nation's waters. Therefore, the current regulatory program considers the full public interest for both the protection and use of water resources.

The following laws define the regulatory authorities and responsibilities of the Corps of Engineers:

Section 9 of the Rivers and Harbors Act of 1899 (33 U.S.C. 401) authorizes the Corps to regulate the construction of any dam or dike across navigable waters of the United States.

Section 10 of the Rivers and Harbors Act of 1899 (33 U.S.C. 403) authorizes the Corps to regulate certain structures or work in or affecting navigable waters of the United States.

Section 404 of the Clean Water Act (33 U.S.C 1344) authorizes the Corps to regulate the discharge of dredged or fill material into waters of the United States.

Section 103 of the Marine Protection, Research, and Sanctuaries Act of 1972, as amended (33 U.S.C. 1413) authorizes the Corps of Engineers to regulate the transportation of dredged material for the purpose of disposal in the ocean.

The Corps also coordinates compliance with related federal laws. These include the National Environmental Policy Act, the Fish and Wildlife Coordination Act, the Endangered Species Act, the National Historic Preservation Act, the Deepwater Port Act, the Federal Power Act, the Marine Mammal Protection Act, the Wild and Scenic Rivers Act, the National Fishing Enhancement Act, the Magnuson-Stevens Fishery Conservation and Management Act, the National Flood Insurance Act of 1968 (as amended), and Executive Order 11988 on Flood Management. Other laws which may also affect the processing of your application are described below.

Section 401 of the Clean Water Act requires applicants to obtain a certification or waiver from the state water pollution control agency to discharge dredged or fill materials. This agency reviews the effect of the discharge on water quality standards.

Section 307(c) of the Coastal Zone Management Act of 1972, as amended, requires applicants to obtain a certification or waiver that the activity complies with the state's coastal zone management program for activities affecting a state's coastal zone.

Commonly Used Terms

This section explains certain terms which are closely associated with the regulatory program. If you need more detailed definitions, you should refer to the Code of Federal Regulations (33 CFR Parts 320 through 330) contact Corps Regulatory Office nearest you, or visit our web site at www.usace.army.mil.

Activity(ies) include the construction, modification, or removal of structures (for example, a pier, wharf, bulkhead, or jetty) and work (for example, dredging, disposal of dredged material, filling, excavation or other modification of a Water of the United States).

Navigable Waters of the United States are those waters of the United States that are subject to the ebb and flow of the tide shoreward to the mean high water line and/or those waters that are presently used, or have been used in the past or may be susceptible to use for interstate or foreign commerce. These are waters that are navigable in the traditional sense. Permits are required in these waters pursuant to Section 10 of the Rivers and Harbors Act. This term should not be confused with the term *waters of the United States* (below).

Waters of the United States is a broader term than navigable waters of the United States defined above. This term includes navigable waters and all their tributaries, adjacent wetlands and other waters or wetlands where degradation or destruction could affect interstate or foreign commerce. Permits are required for the discharge of dredged or fill material in these waters pursuant to Section 404 of the Clean Water Act.

Pre-application Meeting is one or more meetings between members of the Corps staff and an applicant and/or agent regarding a permit application. It also may involve representatives of federal and state resource agencies. The consultation may involve jurisdiction, discussion of practicable alternatives, environmental documents, National Environmental Policy Act procedures, mitigation and potential scope of the data for an environmental impact statement, if necessary. Such meetings often benefit the applicant by providing useful information which could prevent delays during permit evaluation. For dredging permits, a pre-application meeting may facilitate the process

by determining what, if any, sediment testing may be required.

Public Hearings are held to acquire additional information in connection with a permit application or Federal project. The Corps may conduct a hearing or participate in joint public hearings with other Federal or State agencies. In addition, any person may request a public hearing in writing during the comment period specified in the Public Notice. Specific reasons must be given as to the need for a hearing. Hearings are held at times and places that are convenient for the interested public and when that is the best method to obtain information otherwise unavailable. A public hearing is seldom needed to complete the decision process.

Public Interest Review refers to the evaluation of a proposed activity to determine whether issuance of the permit is in the public interest. Expected benefits are balanced against reasonably foreseeable detriments. All relevant factors are weighed. The Corps policy is to provide applicants with a timely and carefully weighed decision which reflects the public interest.

Public Notice is the primary method of advising interested public agencies and private parties of a proposed activity. The Public Notice also solicits comments and information necessary to evaluate the probable impact of the project on the public interest. Upon request, the Corps will add anyone's name to the distribution list to receive public notices.

High Tide Line is a line or mark left upon tidal flats, beaches, or along shore objects that indicates the intersection of the land with the water's surface at the maximum height reached by a rising tide. The high tide line may be determined by tidal gages, physical markings or characteristics, vegetation lines, a more or less continuous deposit of fine shell or debris on the foreshore or berm, or other suitable means such as a line of oil or scum along the shore that delineate the general height reached by a rising tide. The term includes spring high tides and other high tides that occur with periodic frequency, but does not include storm surges in which there is a departure from the normal or predicted reach of the tide due to the piling up of water against a coast by strong winds such as those accompanying a hurricane or other intense storm.

Mean High Water Line, with respect to ocean and coastal waters, is the line on the shore established by the average of all high tides. It is established by survey based on available tidal data (preferably averaged over a period of 18.6 years because of the variations in tide). In the absence of such data, less precise methods to determine the mean high water mark are used, such as physical markings, lines of vegetation or comparison of the area in question with an area having similar physical characteristics for which tidal data are readily available.

Ordinary High Water Line, with respect to non-tidal waters, is the line on shore established by the fluctuations of water and indicated by physical characteristics such as a

clear, natural line impressed upon the bank, shelving, changes in the character of soil, destruction of terrestrial vegetation, the presence of litter and debris, or other appropriate means that consider the characteristics of the surrounding areas.

404(b)(1) Guidelines (40 CFR Part 230), are the federal environmental regulations for evaluating the filling of waters and wetlands. Prepared by the Environmental Protection Agency in consultation with the Corps, the guidelines restrict discharges of dredged or fill material where less environmentally damaging, practicable alternatives exist, among other requirements.

Frequently Asked Questions

The following questions are often asked about the regulatory program. The Corps New England District provides a reception center in case you have other questions or wish to check the status of your application. The Reception Center can be reached at (978) 318-8338 or 8335, or toll-free at 1-800-343-4789 (1-800-362-4367 from within Massachusetts). A professional staff member with experience in the permitting process will be available to answer your questions.

When should I apply for a Corps permit?

You should apply as early as possible during the conceptual stage of the project. Two to three months is normally required to evaluate a routine application involving a public notice. You must have the required approvals before you begin any work.

For a large or complex activity, a "pre-application meeting" or an informal consultation with the Corps during the early planning phase of your project is recommended. You may receive useful information at this point which could prevent delays later. When in doubt about the requirement for a permit or what you need to do, don't hesitate to call the local Corps office.

I have obtained permits from local and state governments. Why do I need a permit from the Corps of Engineers?

Because it is required by Federal law. You may not have to get an individual permit, however, depending on the type or location of work. The Corps has many general permits which authorize minor activities without the need for lengthy additional review. Check with your Corps regulatory office or our web site for information on general permits.

What will happen if I do work without getting a permit from the Corps?

Performing unauthorized work in waters of the United States or failure to comply with terms and conditions of your permit can have serious consequences. You would be in violation of Federal law and could face penalties including fines, requirements to restore the area, or both.

Enforcement is an important part of the Corps regulatory program. The Corps works with State and Local agencies to monitor their permit programs and to expedite the permit review process where possible. When in doubt about whether a planned activity needs a permit, contact the nearest Corps regulatory office or visit us online.

Is it likely that my request to do work will be denied?

Nationwide, only a small percentage of all requests for permits are denied. Those few applicants who have been denied permits usually have refused to change the design, timing, or location of the proposed activity to address environmental concerns. The Corps will try to give you helpful information, including the factors it evaluates during the public interest review as well as alternatives to consider that may prove to be useful in designing an acceptable project.

What is a wetland, and what is its value:

Wetlands are areas that are periodically or permanently inundated or saturated by surface or ground water and support vegetation adapted for life in saturated soil. Wetlands include swamps, marshes, bogs, and similar areas. A significant natural resource, wetlands serve important functions. They provide storage areas for storm and flood waters, protection of other areas from wave action and erosion, natural recharge areas where ground and surface water are interconnected, and natural water filtration and purification functions, fish and wildlife habitat, food chain production, as well as nesting, spawning, rearing and resting sites for aquatic and land species.

Although individual alterations of wetlands may constitute a minor change, the combined effect of many changes often results in major damage to aquatic resources. During the review of applications for alteration of wetlands, the Corps considers whether the proposed activity needs to be located in a wetland or waterway and whether or not alternatives exist which would be less damaging.

Wetland boundaries are determined using the three parameter approach described in the 1987 Corps of Engineers Wetlands Delineation Manual. These boundaries are often different from those delineated based on State and local laws. The New England District can provide regionally modified data forms for use with the Corps of Engineers Wetlands Delineation Manual.

How can I design my project to eliminate the need for a Corps permit?

In an area of tidal waters, the best way to avoid the need for a permit is to select a site that is above the high tide line and avoid wetlands or other waterbodies. In the vicinity of fresh water, stay above ordinary high water and avoid wetlands adjacent to the stream or lake. Also, your activity may be exempt, and you may not need a Corps permit. If your activity is authorized by a general permit, the process is greatly simplified. So, before you build, dredge or fill, contact the Corps regulatory office in your area. Ask for specific information about locations, exemptions, and general permits.

What if my project is located in a floodplain?

The Corps does not regulate activities specifically because they are located within a floodplain. Frequently however, wetlands and waterways of the United States coincide with a Special Flood Hazard Area (SFHA), identified by the National Flood Insurance Program (NFIP) on a community's Flood Insurance Rate Map (FIRM). Work within Corps jurisdiction proposed in a SFHA designated on a community's current effective FIRM is subject to the provisions of Executive Order 11988 Floodplain Management and minimum requirements of the NFIP. The executive order requires no loss in flood storage volume. Therefore, applicants are required to compensate for losses in flood storage volume which result from their project.

How can I obtain further information about permit requirements?

You can get information about the regulatory program from any Corps regulatory office or at our web site: www.nae.usace.army.mil. Most of our publications are on the web. If you prefer to receive publications by mail, write or call:

U.S. Army Corps of Engineers
New England District
696 Virginia Road.
Concord, MA 02254-9149
Attn: Regulatory Division

(978) 318-8338 or 8335,
or call toll-free 1-800-343-4789
(1-800-362-4367 from within
Massachusetts)

Two New England Field Offices are located at:

U.S. Army Corps of Engineers
Maine Project Office
675 Western Avenue #3
Manchester, Maine 04351
(207) 623-8367 or 8124, and

U.S. Army Corps of Engineers
Vermont Project Office
8 Carmichael Street, Suite 205
Essex, Vermont 05452
(802) 872-2893

Part II.

The Permit Application

This section provides information on the types of permits the Corps issues, permit application requirements, the permit application review process, and forms of authorization.

Types of Permits

The Corps issues different types of permits to authorize activities in waters of the United States. Your activity can be authorized under an **individual permit** or a **general permit**. There are two types of general permits -- nationwide permits and regional general permits.

General Permits

General permits apply to activities the Corps has determined are substantially similar in nature and cause minimal environmental impact, individually and cumulatively. The Corps performs an expedited review for projects falling within these general permit categories.

The two types of General Permits – nationwide and regional – embody the same concept: an expedited review process for work which is minimal in nature. However, there are substantial differences. Nationwide General Permits are a series of general permits issued by the Corps Washington office for minor projects in certain areas across the country. In the New England District, the nationwide permits have been suspended and replaced with Programmatic General Permits (PGP's). PGP's vary by state. However, they all take advantage of strong state coastal and wetland protection laws, reduce duplication in review between the Corps and the state and expedite the permit review process for the applicant.

Additionally, each PGP utilizes a tiered approach with categories linked to impact thresholds. These thresholds are listed in the individual PGP's and determine the level of review necessary from the federal perspective. For example, certain activities are non-reporting to the Corps once an applicant has obtained all required state and local approvals.

In many cases, however, written verification of general permit eligibility is necessary from the Corps. If you have any questions regarding the type of permit for which a project qualifies, call the Corps to verify the permit type and category. For information on the specifics of each PGP, contact the Corps office or visit our web site at

www.nae.usace.army.mil. All six New England PGP's are available on our web site.

Application

The following information should be submitted to the Corps to obtain verification that your activity is authorized under a general permit. For some PGP's the Corps may rely on information submitted through the state application process.

- *Brief Project Description* of the purpose of the proposed activity.
- *Vicinity map* locating the site of the entire project. Use an existing road map or U.S. Geological Survey topographic map.
- *Site Plan showing the project limits* as if you were looking straight down on it from above. Clearly show the entire project site, and the limits of waterbodies and wetlands. Numbered references should be made to attached detail sheets.
- *Detail plan view showing the proposed activity* as if you were looking straight down on it from above. Clearly show any activity within jurisdictional waterbodies or wetlands. If the project involves the discharge of dredged or fill material, indicate the limits of wetland filling and the area of fill in square feet.

The plan should include the dimensions of proposed structures and areas of work. Also, where possible, indicate distances to recognizable landmarks (e.g., existing roadways and buildings, utility poles, fences) to assist in locating the activity in the field.

Evaluating a General Permit

Upon receipt of your request, the Corps will determine whether the project complies with the criteria of the general permit. Each of the six New England states has Programmatic General Permits. The criteria for each state is somewhat different and the Corps project manager assigned to your application will determine if a proposal meets the criteria. Some proposals may be non-reporting to the Corps of Engineers. For these projects, it is the applicant's responsibility to meet not only the non-reporting thresholds but also the terms and conditions of the particular PGP as well as obtaining any required state or local permits. If there is any doubt about the category of your proposal, it is best to contact the Corps and review the project with a Corps project manager. The Corps can either concur that your project meets the criteria for a general permit or require that you submit an application for an individual permit. For more information on a general permit

in your state, contact the Corps at (800) 343-4789 or visit the Corps web site at www.nae.usace.army.mil.

Presently, there are no fees associated with general permits. Work must be completed within the specified authorized period.

Step-by-Step Procedure for Evaluating a Typical General Permit

1. Applicant consults Corps early in the process or applies to a state agency for Corps review under certain PGPs.
2. Project may meet criteria of general permit, Corps may suggest some modification to minimize wetland impacts.
3. Project may qualify for as non-reporting to the Corps. In this case the applicant may proceed once he or she has received all required state and local permits. The applicant is responsible for meeting the requirements and the terms and conditions of the non-reporting category for that particular PGP.
4. Applicant submits general permit application, including the plans referenced on page 9, to Corps

regulatory office or through state regulatory agency as required by General Permit.

5. Corps assigns identification number and reviews application for authorization under a general permit.
6. Corps conducts required review with the federal resource agencies and the state environmental permitting authority.
7. Corps issues general permit authorization if the Corps, the federal resource agencies and the state agree that the proposal will have minimal environmental impact. This authorization may have special conditions to insure minimal impacts. If approved under the general permit, the Corps will notify the applicant. The applicant must complete work authorized under a general permit within a specified timeframe.
8. The Corps, alone or in consultation with the federal agencies, may determine that an individual permit review is required. The applicant will be notified of this determination based on time frames within the various programmatic general permits.

Individual Permits

If your project does not fall under the criteria for a general permit, you will need to submit an application for an individual permit. Consult a Corps representative early to find out what information will be required during the review process and to arrange a pre-application meeting.

Application

You will need ENG Form 4345, Application for a Department of the Army Permit, or a joint Federal-state application that may be available in your state to begin the review process. The required information on these forms is basically the same. You can get the appropriate form from the Corps regulatory office in the area where your proposed project is located (see page 8) or on our web site.

The Corps uses the information on your application to determine the appropriate review procedure, and to evaluate your proposal. If you provide complete information in the requested format, the permit evaluation can be completed faster.

Evaluating an Individual Permit

The Corps will begin evaluating your application as soon as it receives all the required information. The Corps will acknowledge receipt of your application and tell you the file number assigned to your project. You should refer to this number when inquiring about your application. The decision whether to grant or deny a permit is based, in part, on a **public interest review** of the probable impact of the proposed activity and its intended use. When a public notice is required, the review takes into consideration all comments received and other relevant factors. Benefits and detriments are balanced by considering effects on items such as:

- conservation
- economics
- aesthetics
- wetlands
- cultural values
- fish & wildlife values
- floodplain values
- flood hazards
- food & fiber production
- energy needs
- navigation
- shore erosion & accretion
- recreation
- water supply & conservation
- water quality
- safety
- needs & welfare of the people
- considerations of private ownership
- general environmental concerns

In addition for fill projects in waters or wetlands, the proposal will be evaluated for compliance with the 404(b)(1) Guidelines for Section 404 activities. If a project is determined by the Corps not to be in compliance with the guidelines, the permit application will be denied, regardless of the Public Interest Review outcome. Specific guidance concerning the 404(b)(1) Guidelines is found in EPA's Guidelines for Specifications of Disposal Sites for Dredged or Fill Material, 40 CFR 230 - Federal Register, Dec. 24, 1980. To order a copy of these guidelines see the Guidance for Section 404 Permit Applicants at the end this pamphlet.

The **404(b)(1) guidelines**, prepared by the Environmental Protection Agency in consultation with the Corps, are the Federal environmental regulations for evaluating the filling of waters and wetlands. They are designed to avoid unnecessary filling of waters and wetlands. The guidelines prohibit discharges:

- where less environmentally damaging, practicable alternatives exist;
- which result in violations of State or Federal Water Quality Standards, the Endangered Species Act, and the Marine Sanctuaries Act;
- which cause or contribute to significant degradation of waters and wetlands;
- if all appropriate and practical mitigation has not been taken; or
- if there is not sufficient information to determine compliance with the guidelines.

The Corps will consider the following general criteria in the evaluation of every application:

- the relative extent of the public and private need for the proposed activity;
- the practicable use of reasonable alternative locations and methods to accomplish the objective of the proposed activity; and
- the extent and permanence of the proposed activity's beneficial and detrimental effects on the public and private uses to which the area is suited.

The Corps must first define the "basic project purpose". The basic project purpose guides the analysis of practicable alternatives to avoid filling waters and wetlands. The Corps uses a sequential approach of first analyzing off-site alternatives. Second, we review on-site project modifications to avoid and minimize wetland impacts. Third, we look at compensatory mitigation to replace functions and values of wetlands unavoidably impacted. For more information on wetland functions and values, please see the Guidance for Section 404 Permit Applicants at the end of this pamphlet.

Note that for non water dependent projects, there is a presumption that practicable alternatives are available that do not involve filling wetlands and other special aquatic sites. The applicant must overcome this rebuttable presumption. When unavoidable impacts occur, the Corps requires all appropriate and practicable action be taken to mitigate such impacts. Modifying your project to avoid unnecessary wetland filling may qualify your project for a general permit, which may expedite the permitting process.

A project with dredging and disposal of marine sediments may require sampling and testing of the sediments proposed to be removed. Applicants should initiate contacts with the Regulatory Division early in their planning stages so that an acceptable sampling plan can be developed that will meet all federal testing protocols.

Step-by-Step Procedure for Evaluating a Typical Individual Permit

1. Pre-application meeting
2. Applicant submits ENG Form 4345 or equivalent joint state/federal application to Corps regulatory office
3. Corps receives application and assigns identification number
4. Corps notifies applicant if additional information is required
5. Public notice issued within 15 days of receiving all required information. The public notice seeks comments from the general public, adjacent property owners, interested groups and individuals, local agencies, state agencies, and federal agencies
6. Normally, a 30 day comment period, depending upon nature of activity
7. 404(b)(1) determination
8. Corps conducts Public Interest Review, allowing applicant to respond to public comments
9. The Corps may ask applicant to provide additional information
10. Corps considers all comments and applicant's responses
11. Public hearing held, if needed
12. Corps makes decision

Forms of Authorization

An individual permit may be issued as either a Standard Permit (ENG Form 1721) or as a Letter of Permission.

A **standard permit** is issued when the typical review procedure is completed including public notice, opportunity for a public hearing, and receipt of comments.

A **Letter of Permission (LOP)** may be issued if work is minor or routine with minimum impacts, and objections are unlikely. A LOP can be issued much more quickly than a standard permit since public notice is not required. The Corps can usually reach a decision in less than 30 days. The local Corps office will notify you if your proposed activity qualifies for a LOP.

Fees

Fees are required for most individual permits. The current fee is \$10.00 for a permit for a non-commercial activity and \$100.00 for a permit for a commercial or industrial activity. These fees are subject to change. The Corps decides the amount of the fee. Do not send a fee when you submit an application. When the Corps issues a permit, you will be notified and asked to submit the required fee payable to FAO, New England District.

Fees are not charged for general permits, transferring a permit from one property owner to another, for Letters of Permission, or for permits to governmental agencies or non-profit agencies.

Part III. Application Form

The instructions given below, together with the sample application and drawings, should help in completing the required application form. If you have additional questions, contact the Corps regulatory office.

Blocks Numbered 1 through 4. To be completed by Corps of Engineers. When the Corps receives your completed application, we will assign it a number for identification purposes. We will notify you of the number. Please refer to this number in any correspondence or inquiry concerning your application.

Block 5. Applicant's Name. Enter the name of the responsible party or parties. If the responsible party is an agency, company, corporation or other organization, indicate the responsible officer and title. If more than one party is associated with the application, please attach a sheet with the necessary information marked **Block 5**.

Block 6. Address of Applicant. Please provide the full address of the party or parties responsible for the application. If more space is needed, attach an extra sheet of paper marked **Block 6**.

Block 7. Applicant Telephone Number(s). Please provide the number where you can be reached during normal business hours.

Blocks 8 through 11. To be completed if you choose to have an agent.

Block 8. Authorized Agent's Name and Title. Indicate name of individual or agency, designated by you, to represent you in this process. An agent can be an attorney, builder, wetland scientist, contractor, engineer or any other person or organization. Note: An agent is not required.

Block 9 and 10. Agent's Address and Telephone Number. Please provide the complete mailing address of the agent, along with the telephone number where he/she can be reached during normal business hours.

Block 11. Statement of Authorization. To be completed by applicant if an agent is employed.

Block 12. Proposed Project Name or Title. Please provide a name identifying the proposed project, if any (i.e.,

Landmark Plaza, Burned Hills Subdivision, Edsall Commercial Center, etc.).

Block 13. Name of Waterbody. Please provide the name of any stream, lake, marsh or other waterway to be directly impacted by the activity. If it is a minor (no name) stream, identify the waterbody the minor stream enters.

Block 14. Proposed Project Address. If the proposed project is located at a site having a street address (not a box number), please enter here.

Block 15. Location of Proposed Project Enter the county and state where the proposed project is located. If more space is required, please attach a sheet with the necessary information marked **Block 15**.

Block 16. Other Location Descriptions. If available, provide the Section, Township and Range of the site and/or the latitude and longitude. You may also provide a description of the proposed project location, such as lot numbers, tract numbers or you may choose to locate the proposed project site from a known point (such as the right descending bank of Smith Creek, one mile down from the Highway 14 bridge). If on a large river or stream, include the river mile of the proposed project site if known.

Block 17. Directions to the Site. Provide directions to the site from a known location or landmark such as an interstate highway. Include highway and street numbers as well as names. Also provide any other information that would assist someone in locating the site.

Block 18. Nature of Activity. Describe the overall activity or project. Use additional pages if necessary. Give appropriate dimensions of structures such as wingwalls, dikes, or excavations (length, width, and height). Indicate whether discharge of dredged or fill material is involved. Identify the materials to be used in construction, as well as the methods by which the work is to be done. Also, identify any structure to be constructed on a fill, piles or float supported platforms. If the activity involves dredging, state whether the dredging activity is new or for maintenance. If it is for maintenance, please provide the name and number of the previous Corps of Engineers permit for dredging this area. Also provide the additional information for dredging projects listed on the following page.

Block 19. Proposed Project Purpose. Describe the purpose and need for the proposed project. What will it be used for and why? Also include a brief description of any related activities to be developed as the result of the proposed project. Give the approximate dates you plan to both begin and complete all work.

Block 20. Reason(s) for Discharge. If the activity involves the discharge of dredged and/or fill material into a wetland or other waterbody, including temporary placement of material, explain the specific purpose of the placement of the material (such as erosion control).

Block 21. Type(s) of Material Being Discharged and the Amount of Each Type in Cubic Yards. Describe the material to be discharged and amount of each material to be discharged within Corps jurisdiction. Please be sure this description will agree with your illustrations. Discharge material includes: rock, sand, concrete, etc.

Block 22. Surface Areas of Wetlands or Other Waters Filled. Describe the area to be filled at each location. Specifically identify the surface areas, or portion thereof, to be filled. Also include the means by which the discharge will be accomplished (backhoe, dragline, etc.). For dredging projects, if offshore disposal is proposed, the proposed disposal site should be identified. If an upland disposal site is proposed, its location should be identified and the dimensions and capacity of any dewatering site(s) or structures(s) should be provided. If runback into the aquatic system is planned, it should be so stated.

Block 23. Is Any Portion of the Work Already Complete? Provide background on any part of the proposed project already completed. Describe the area already developed,

structures completed, any dredged or fill material already discharged, the type of material, the volume in cubic yards, number of square feet or acres filled if within a wetland or other waterbody. If the work was done under an existing Corps permit, identify the authorization if possible.

Block 24. Names and Addresses of Adjoining Property Owners, Lessees, etc., Whose Property Adjoins the Project Site. List complete names and full mailing addresses of the adjacent property owners (public and private) leaser, etc., whose property adjoins the waterbody or aquatic site where the work is proposed so that they may be notified of the proposed activity (usually public notice). If more space is needed, attach an extra sheet of paper marked **Block 24**.

Information regarding adjacent landowners is usually available through the office of the tax assessor in the county or counties where the project is proposed

Block 25. Information about Approvals or Denials by Other Agencies. You may need the approval of other Federal, state or local agencies for your project. Identify any applications you have submitted and the status of each application. You need not have obtained all other permits before applying for a Corps permit but you must have obtained all necessary permits before starting work.

Block 26. Signature of Applicant or Agent. The application must be signed by the applicant or other authorized party (agent). This signature shall be an affirmation that the party applying for the permit possesses the requisite property rights to undertake the activity, including compliance with special conditions, mitigation, etc.

Part IV.

Application Submittals

This section describes the requirements for graphics submitted with all applications for an individual permit from the Army Corps of Engineers. Plans submitted in this format will expedite application evaluation.

General Information

You must provide three types of drawings with permit applications -- Vicinity Map, Plan View, and Elevation/Cross Section View -- which accurately depict activities (see sample drawings). If a project involves a number of activities within Corps jurisdiction, then it is recommended that you include an overall site plan with your application. This site plan should show the project limits, limits of waterbodies and wetlands, and all proposed activities as if you were looking straight down on it from above. Numbered references should be made to attached detail sheets which should show the specific impact areas for the project.

Submit one original, or good quality copy, of all drawings on 8-1/2 x 11 inch white paper (tracing cloth or film may be used). Submit the least number of sheets necessary to adequately show the proposed activity. The Corps recommends that you prepare drawings in accordance with the general format of the samples shown herein, using block style lettering. Each page should have a title block. Drawings do not have to be prepared by an engineer, but professional assistance may become necessary if the project is large or complex.

Leave a 1-inch margin at the top edge of each sheet for the purpose of copying and binding.

Identify the proposed activity in the title block of each sheet of drawings. Include the name of the body of water, river mile (if applicable), city or town, state, name of applicant or project, number of the sheet, total number of sheets in the set, scale, and the date the drawing was prepared, including revised dates.

Since drawings must be reproduced, use heavy dark lines. Do not use color shading. You can however use dot shading, hatching, or similar graphic symbols to clarify line drawings which reproduces well in black and white.

Vicinity Map

The vicinity map you provide will be printed in any public notice that is issued for the project. The Corps of Engineers and other reviewing agencies also use the vicinity map to locate the site of the proposed activity. You may use an existing road map or U.S. Geological Survey (USGS) topographic map as the vicinity map. Please include enough details to simplify locating the site from both the waterbody and from land. Identify the source of the map or chart from which the vicinity map was taken and, if not already shown, add the following:

- Location of activity site (draw an arrow showing the exact location of the site on the map).
- Latitude, longitude, river mile, if known, and other information that coincides with Block 16 on the application form.
- Name of waterbody and the name of the larger creek, river, bay, etc., that the waterbody is immediately tributary to.
- Names, descriptions and location of landmarks.
- Name of all applicable political jurisdictions (county, parish, borough, town, city, etc.).
- Name of and distance to nearest town, community, or other identifying locations.
- Names or numbers of all roads in the vicinity of the site.
- North arrow.
- Scale, both numeric and graphic.

Plan View

The plan view shows the proposed activity as if you were looking straight down on it from above. Your plan view should clearly show the following:

- Name of waterbody (river, creek, lake, wetland, etc.) and river mile (if known) at location of activity;
- Mean high and mean low water lines and maximum high tide line in tidal areas, and direction of ebb and flood of tide;
- Ordinary high water line and ordinary low water line if the proposed activity is located on a non-tidal waterbody;
- Average water depths around the activity;
- Existing and proposed ground contours or spot elevations;
- Vertical datum (reference elevation);
- All project elements, including access roadways, parking areas, buildings, utility lines, detention ponds, and all property lines at the site;
- Dimensions of the activity and distance it extends from the mean high water line into tidal waters or from ordinary high water line into freshwater and wetlands;
- Distances to any nearby Federal channels and anchorages, if applicable;
- Distance between proposed activity and any navigation channel, where applicable;
- Location of structures, if any, in navigable waters immediately adjacent to the proposed activity, in narrow waterbodies show width of water and include structures located across from proposed work;
- Location of any waters (rivers, streams, lakes, ponds) and wetlands (marshes, swamps, bogs). Wetland boundaries must be delineated using the three parameter approach found in the 1987 Corps of Engineers Manual for Wetlands Delineation.
- New England District Wetland Delineation Data Sheets should be submitted to support the limits of wetlands.
- The location of the 100 year, 500 year, and regulatory floodway boundaries as shown on the communities current effective National Flood Insurance Program maps, if applicable;
- North arrow;
- Graphic scale;
- Dimensions of all filling in waters and wetlands, including backfill and temporary fill for structures such as cofferdams and access roads;
- If dredged material is involved, show the extent of dredging, describe the type of material, the number of cubic yards, the method of handling, and the location and dimensions of disposal area for dredged and fill material. Show on the drawing the proposed retention levees, weirs, and/or other means for retaining hydraulically placed materials;
- Mark the drawing to show previously completed portions of the activity;
- If upland disposal is proposed, show on a plan the proposed detention levees, weirs, dewatering structures, and/or other means of retaining the material. Include the capacity and the points of runback into the aquatic system.
- You do not have to include photographs of the site of the proposed activity. However, pictures are helpful, and you can submit them as part of any application.

Elevation and/or Cross Section View

The elevation and/or cross section view is a scale drawing that shows the side, front, or rear of the proposed activity. In a section view, show the proposed structure as it would look if sliced internally for display. Clearly show the following:

- Vertical datum (reference elevation);
- Water elevations as shown in the plan view, including 100 year flood and floodway encroachment lines;
- Water depth at the waterward face of the proposed activity or, if dredging is proposed, the depth of dredging, estimated disposal grades, and volume of dredged or fill material in cubic yards. In non-tidal bodies, indicate volumes below ordinary high water.
- Dimensions from the mean high water line (in tidal waters) for proposed floating or pile supported structures or dimensions from the high tide line or the upland edge of wetland for fill. Describe dimensions of any facility you will build on the structures or fill;
- Approximate side slopes;
- Existing and proposed ground contours or spot elevations;
- Graphic scale; and
- Principal dimensions of the activity.

Notes on Drawings

- Names of adjacent property owners who may be affected. List complete names and addresses in Block 24 on ENG Form 4345.
- Legal property description: Number, name of subdivision, block and lot number. Section, Township and Range (if applicable) from plot, deed or tax assessment.

Dredging Projects

Applications for dredging projects must submit the following information directly to the Corps of Engineers.

- Plan view with existing bottom depths
- Section view
- Amount of material to be dredged
- Proposed dredging depth
- Method of dredging (hydraulic or mechanical)
- Stipulate maintenance or new dredging,
- Disposal site for dredged material
- Show the location of any discharges on the plan and any potential non-point sources of pollution.
- Point source discharges/spills must be investigated. This information may be obtained from the local harbor master, U.S. Coast Guard, or the CT DEP.
- Submit any previous test data (either at your site or a nearby site), with sampling station locations shown on a plan.
- If the disposal site is upland, specify the site on a map; provide the site's existing characteristics (normal use, landscape, prior use as a disposal site, any aquifers in the area?)
- Method of containment; dike or depression
- Specify the materials to be used for berm construction and the construction method
- Specify the method of transporting the dredged material from the site to the disposal area (pipeline, sealed trucks)
- Submit grading plans
- Specify the long-term planned use of the site
- Specify containment site capacity calculations
- If open water disposal is chosen as the disposal site for the material to be dredged, please submit a

detailed upland disposal alternative analysis. This analysis should include the names and addresses of nearby landfills or other available upland disposal sites that were looked into as well as the immediate upland availability.

Please note that open water disposal of more than 25,000 c.y. of dredged material into Long Island Sound (LIS) requires authorization under Section 103 of the Ocean Dumping Act and an Individual Permit from this office.

For Projects with disposal in Long Island Sound and between 19,000 and 25,000 c.y. of dredged material, the permittee is required to submit a calculation of the total volume of material removed, based on pre- and post-dredge surveys, to this office within 60 days of the completion of dredging. The pre- and post- dredge surveys must be submitted as backup for the dredge volume calculations.

For projects that are located within 200 feet of a Federally maintained project (new structures as well as extensions to existing structures), the applicant must provide state plane coordinates of the seaward ends of the proposed structures. These should be included on your plans.

Highway Projects:

Highway Projects and associated plans need to conform to the Highway Methodology developed by the Corps New England District, Regulatory Division. If you are planning a highway project, contact your local Regulatory Office for a description of these procedures, and a copy of the Highway Methodology Workbook. The following plans show portions of a typical highway project plan set.

Utility Construction:

It is necessary to show all fill aspects of a utility project, including the method of construction and all temporary fill and coffer dam fills. Plans on the following pages show portions of typical sewer construction plans.

Part V.

Sample Application Packages.

This section presents a blank application form and sample application packages for projects needing permits under Section 10 of the Rivers and Harbors Act, Section 404 of the Clean Water Act, and a joint permit under both acts. These samples include completed application forms and typical plans in the required format for individual permits. Additional sample plans of other common projects are included at the end of this section.

Public reporting burden for this collection of information is estimated to average 5 hours per response, including the time for reviewing instructions, searching existing data sources, gathering and maintaining the data needed, and completing and reviewing the collection of information. Send comments regarding this burden estimate or any other aspect of this collection of information, including suggestions for reducing this burden, to Department of Defense, Washington Headquarters Service Directorate of Information Operations and Reports, 1215 Jefferson Davis Highway, Suite 1204, Arlington, VA 22202-4302; and to the Office of Management and Budget, Paperwork Reduction Project (0710-0003), Washington, DC 20503. Please DO NOT RETURN your form to either of those addresses. Completed applications must be submitted to the District Engineer having jurisdiction over the location of the proposed activity.

PRIVACY ACT STATEMENT

Authority: 33 USC 401, Section 10; 1413, Section 404. Principal Purpose: These laws require permits authorizing activities in, or affecting, navigable waters of the United States, the discharge of dredged or fill material into waters of the United States, and the transportation of dredged material for the purpose of dumping it into ocean waters. Routine Uses: Information provided on this form will be used in evaluating the application for a permit. Disclosure: Disclosure of requested information is voluntary. If information is not provided, however, the permit application cannot be processed nor can a permit be issued.

One set of original drawings or good reproducible copies which show the location and character of the proposed activity must be attached to this application (see sample drawings and instructions) and be submitted to the District Engineer having jurisdiction over the location of the proposed activity. An application that is not completed in full will be returned.

(ITEMS 1 THRU 4 TO BE FILLED BY THE CORPS)

1. APPLICATION NO.	2. FIELD OFFICE CODE	3. DATE RECEIVED	4. DATE APPLICATION COMPLETED
--------------------	----------------------	------------------	-------------------------------

(ITEMS BELOW TO BE FILLED BY APPLICANT)

5. APPLICANT'S NAME Simon Realty Trust	8. AUTHORIZED AGENT'S NAME AND TITLE (an agent is not required) Carmichael Associates, Inc.
6. APPLICANT'S ADDRESS 98 Slaterberg Avenue Newburyport, MA 01950	9. AGENT'S ADDRESS 1898 Mercer Street, Suite 42 Portland, ME 04112
7. APPLICANT'S PHONE NOS. W/AREA CODE a. Residence N/A b. Business (508) 555-1234	10. AGENT'S PHONE NOS. W/AREA CODE a. Residence N/A b. Business (207) 555-7896

11. STATEMENT OF AUTHORIZATION

I hereby authorize, Carmichael Associates, Inc. to act in my behalf as my agent in the processing of this application and to furnish, upon request, supplemental information in support of this permit application.

William Simon

APPLICANT'S SIGNATURE

May 5 1989
DATE

NAME, LOCATION AND DESCRIPTION OF PROJECT OR ACTIVITY

12. PROJECT NAME OR TITLE (see instructions) Simon Realty Trust	
13. NAME OF WATERBODY, IF KNOWN (if applicable) Merrimack River	14. PROJECT STREET ADDRESS (if applicable) 98 Slaterberg Avenue Newburyport, MA 01950
15. LOCATION OF PROJECT Essex COUNTY Massachusetts STATE	

16. OTHER LOCATION DESCRIPTIONS, IF KNOWN, (see instructions) Project is located at the end of Slaterberg Avenue, riverward of the one story building on Lot #11. Also, project is located approximately 7,000 feet east of the Whittier Memorial Bridge.

17. DIRECTIONS TO THE SITE
From Waltham, MA take Route 95 North to Route 113 East. Follow Route 113 through two sets of lights. After the second set of lights take a left onto Ashland Street. Follow for one-half mile and then take a right onto Merrimack Street. Take first left onto Slaterberg Avenue. Follow to end.

18. Nature of Activity (Description of project, include all features)

The applicant proposes to dredge approximately 12,725 CY of clean material to create a 200 ft. by 600 ft. boat basin, and install 660 LF of 8 ft. wide floating piers along the shoreline, 5 - 5 ft wide floating piers varying from 145 LF to 205 LF and 78 - 4 ft. wide finger floats spaced at 20 ft. to 35 ft. wide intervals, as shown on the attached plans.

19. Project Purpose (Describe the reason or purpose of the project, see instructions)

The purpose of the proposed activity is to expand the existing marina for commercial use by providing 81 additional dockage spaces. Work is expected to begin in the spring of this year.

USE BLOCKS 20-22 IF DREDGED AND/OR FILL MATERIAL IS TO BE DISCHARGED

20. Reason(s) for Discharge

Dredge material will be disposed of off site at an upland disposal area in accordance with applicable waste disposal laws. There will be no disposal of dredged material into wetlands or waterbodies.

21. Type(s) of Material Being Discharged and the Amount of Each Type in Cubic Yards

Approximately 6,000 cy of silt/clay from surface layer and approximately 6,725 cy of silty sand underlying layer.

22. Surface Area in Acres of Wetlands or Other Waters Filled (see instructions)

N/A

23. Is Any Portion of the Work Already Complete? Yes No IF YES, DESCRIBE THE COMPLETED WORK

24. Addresses of Adjoining Property Owners, Lessees, Etc., Whose Property Adjoins the Waterbody (if more than can be entered here, please attach a supplemental list).

West: Bartholomew H. Simpson 310 Riverside Drive Newburyport, MA 01950	East: Richard I. Rollo 79 Bowman Street Newburyport, MA 01950	South: Stephanie Andruss 100 Slaterberg Avenue Newburyport, MA 01950
--	---	--

25. List of Other Certifications or Approvals/Denials Received from other Federal, State or Local Agencies for Work Described in This Application.

AGENCY	TYPE APPROVAL*	IDENTIFICATION NUMBER	DATE APPLIED	DATE APPROVED	DATE DENIED
Conservation Comm.	Order of Conditions	File #12-345	Feb. 1 1989	March 15, 1989	----
Harbor Commission	Approval	--	Feb. 1 1989	March 15, 1989	----
MA DEP Div.	Waterways				
MA Waterways	License	File #89-2534	March 28, 1989	Pending	

*Would include but is not restricted to zoning, building and flood plain permits

26. Application is hereby made for a permit or permits to authorize the work described in this application. I certify that the information in this application is complete and accurate. I further certify that I possess the authority to undertake the work described herein or am acting as the duly authorized agent of the applicant.

_____	_____	<u>John Carmichael</u>	<u>5-15-89</u>
SIGNATURE OF APPLICANT	DATE	SIGNATURE OF AGENT	DATE

The application must be signed by the person who desires to undertake the proposed activity (applicant) or it may be signed by a duly authorized agent if the statement in block 11 has been filled out and signed.

18 U.S.C. Section 1001 provides that: Whoever, in any manner within the jurisdiction of any department or agency of the United States knowingly and willfully falsifies, conceals, or covers up any trick, scheme, or disguises a material fact or makes any false, fictitious or fraudulent statements or representations or makes or uses any false writing or document knowing same to contain any false, fictitious or fraudulent statements or entry, shall be fined not more than \$10,000 or imprisoned not more than five years or both.

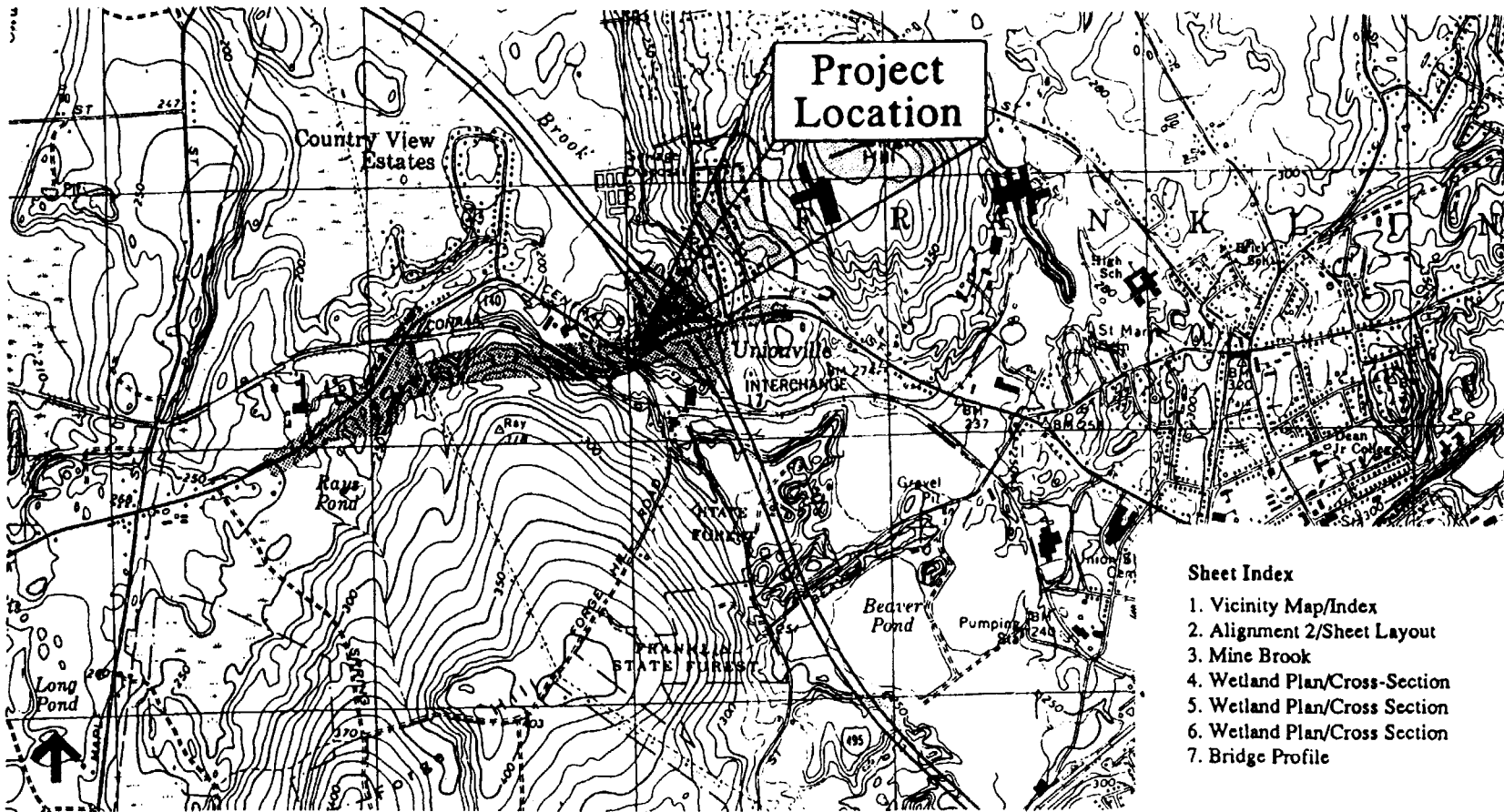

Sheet Index

1. Vicinity Map/Index
2. Alignment 2/Sheet Layout
3. Mine Brook
4. Wetland Plan/Cross-Section
5. Wetland Plan/Cross Section
6. Wetland Plan/Cross Section
7. Bridge Profile

**VICINITY MAP
U.S.G.S. FRANKLIN QUADRANGLE**



<p>Massachusetts Department of Public Works 10 Park Plaza, Boston, MA 02116-3973</p>	<p>RELOCATED ROUTE 140 VICINITY MAP / INDEX</p>		<p>DATE NOVEMBER, 1990</p>
<p>* HIGHWAY PLANS COURTESY OF VANASSE HANGEN BRUSTLIN, INC.</p>	<p>AT: FRANKLIN IN: MINE BROOK NORFOLK COUNTY COMMONWEALTH OF MASSACHUSETTS</p>	<p>APPLICATION BY: COMMONWEALTH OF MASSACHUSETTS DEPARTMENT OF PUBLIC WORKS</p>	<p>SHEET OF 1 7</p>

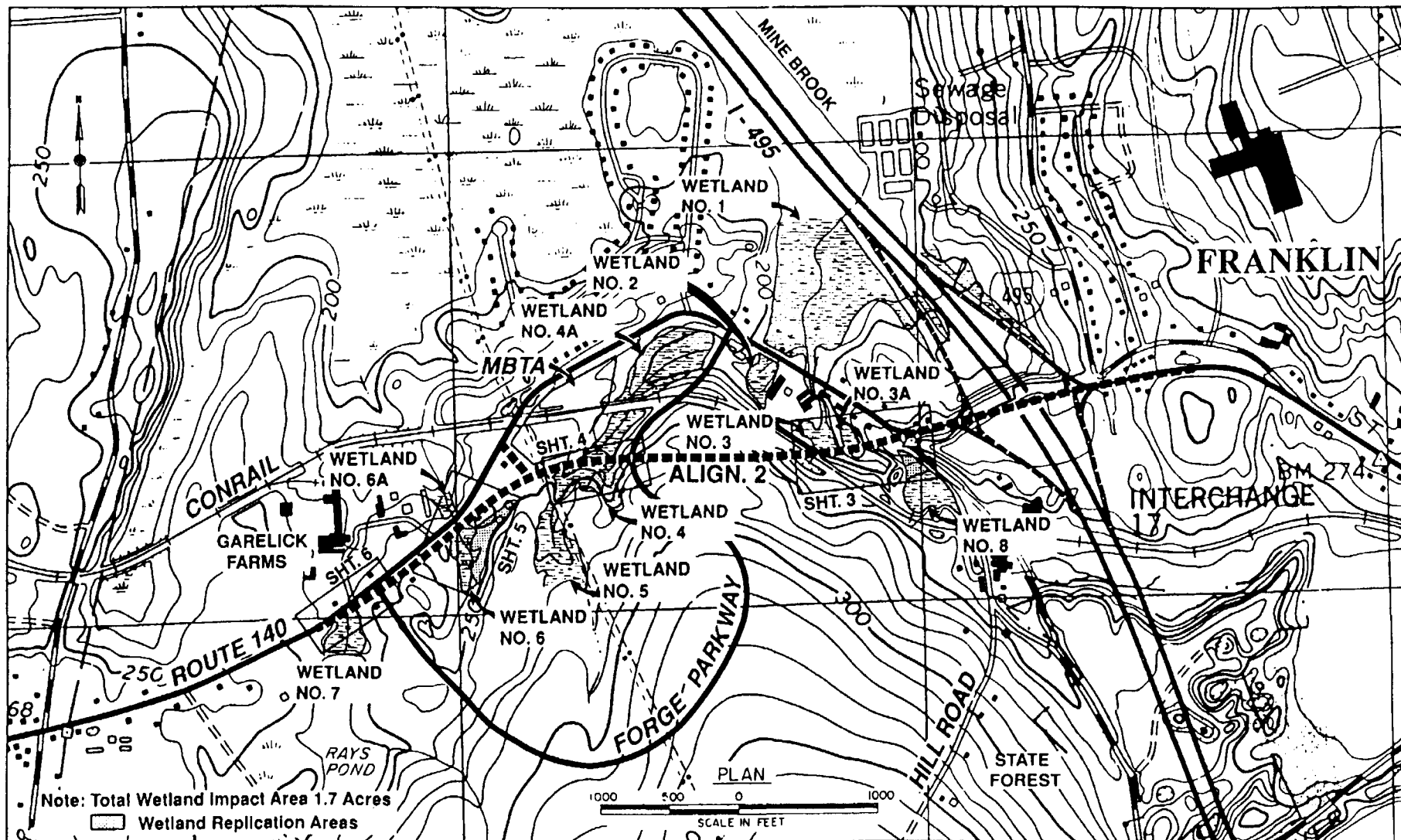

Note: Total Wetland Impact Area 1.7 Acres
 Wetland Replication Areas

Massachusetts Department of Public Works
 10 Park Plaza, Boston, MA 02116-3973

**RELOCATED ROUTE 140
 ALIGNMENT 2 / SHEET LAYOUT**

AT: FRANKLIN
 IN: MINE BROOK
 NORFOLK COUNTY
 COMMONWEALTH OF MASSACHUSETTS

APPLICATION BY:
 COMMONWEALTH OF MASSACHUSETTS
 DEPARTMENT OF PUBLIC WORKS

DATE
 NOVEMBER, 1990

SHEET OF
 2 7

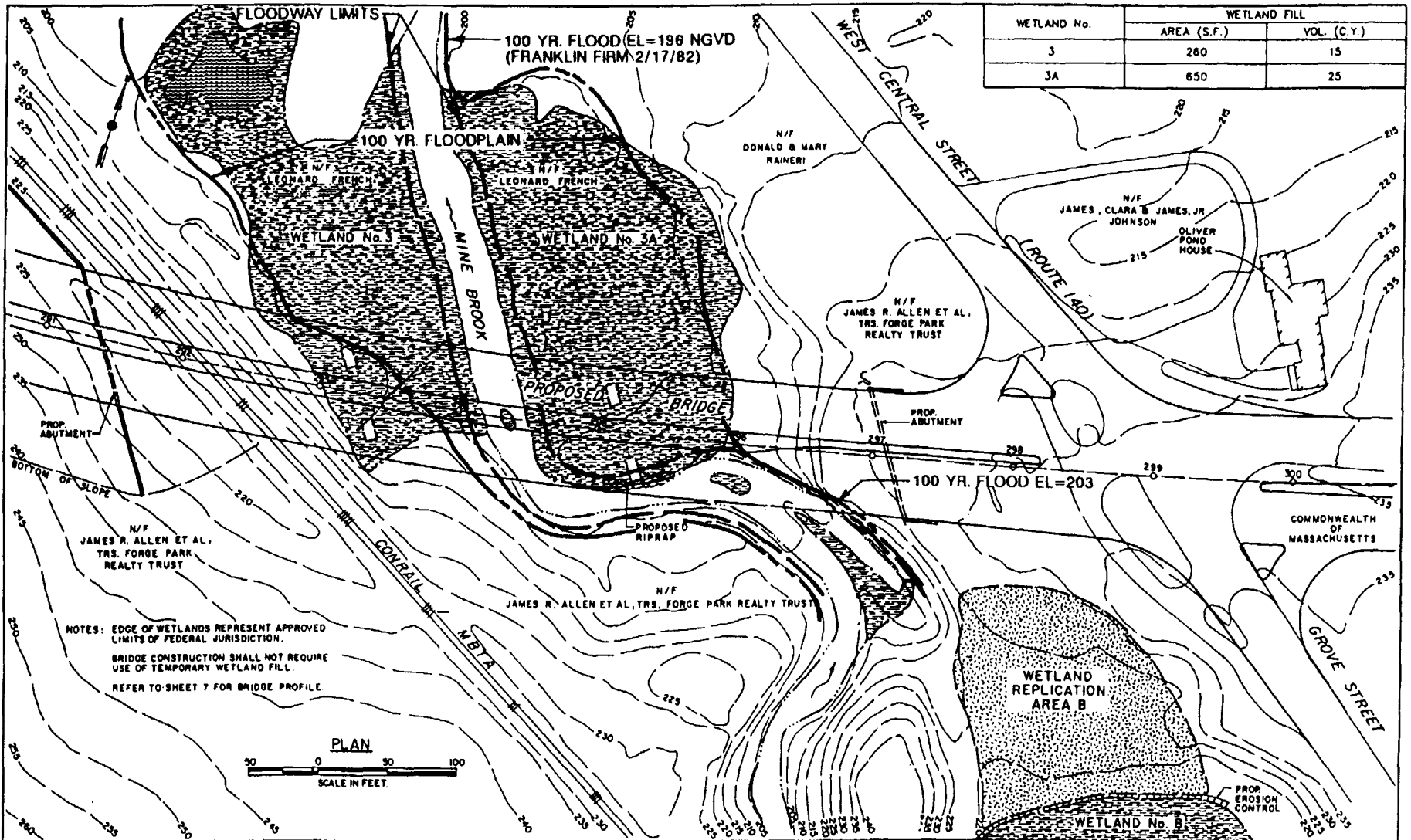

WETLAND No.	WETLAND FILL	
	AREA (S.F.)	VOL. (C.Y.)
3	260	15
3A	650	25

NOTES: EDGE OF WETLANDS REPRESENT APPROVED LIMITS OF FEDERAL JURISDICTION.
 BRIDGE CONSTRUCTION SHALL NOT REQUIRE USE OF TEMPORARY WETLAND FILL.
 REFER TO SHEET 7 FOR BRIDGE PROFILE.



Massachusetts Department of Public Works
 10 Park Plaza, Boston, MA 02116-3973

**RELOCATED ROUTE 140
 MINE BROOK**

DATE
NOVEMBER, 1990

AT: FRANKLIN
 IN: MINE BROOK
 NORFOLK COUNTY
 COMMONWEALTH OF MASSACHUSETTS

APPLICATION BY:
 COMMONWEALTH OF MASSACHUSETTS
 DEPARTMENT OF PUBLIC WORKS

SHEET OF
3 7

WETLAND No.	WETLAND FILL	
	AREA (S.F.)	VOL. (C.Y.)
4	57,025	20,990

N / F
MASS. BAY
TRANSIT
AUTHORITY

AREA OF WETLAND FILL

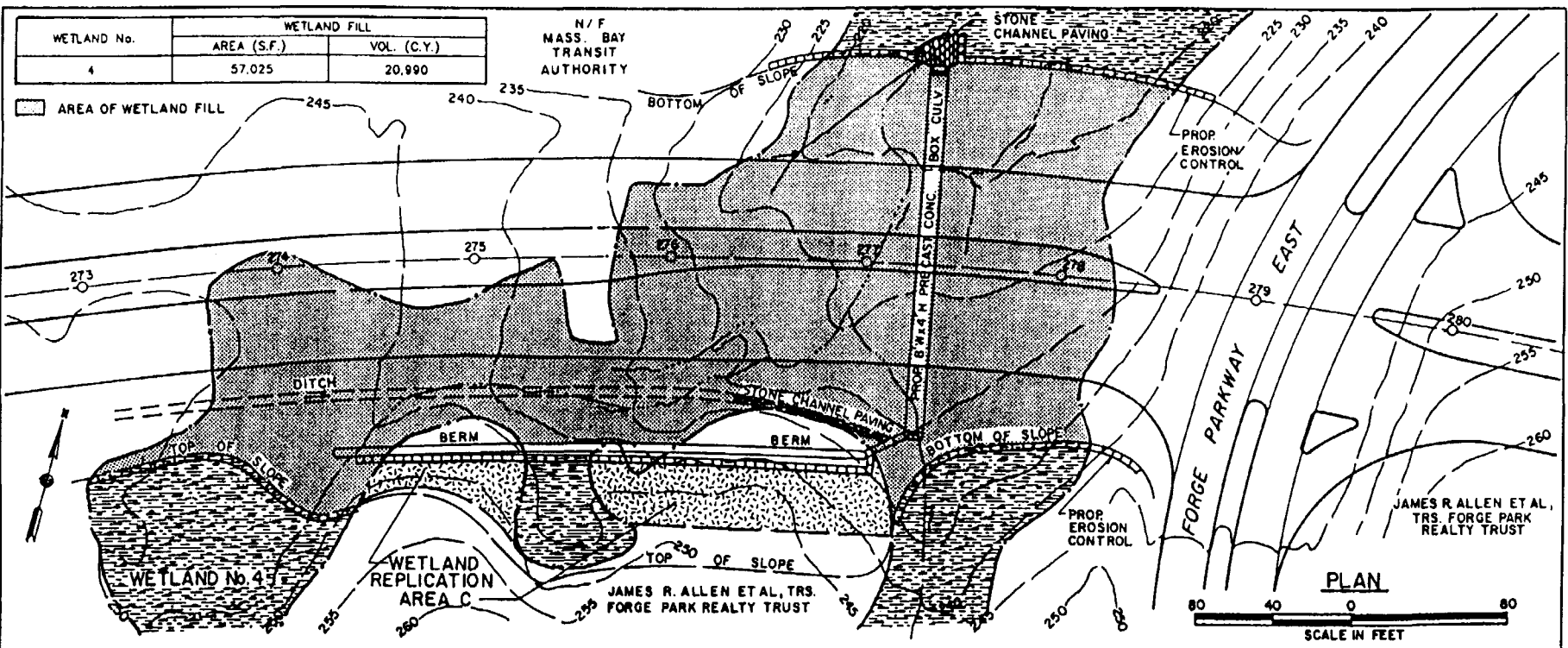

NOTE: EDGE OF WETLAND REPRESENTS APPROVED LIMITS OF FEDERAL JURISDICTION.

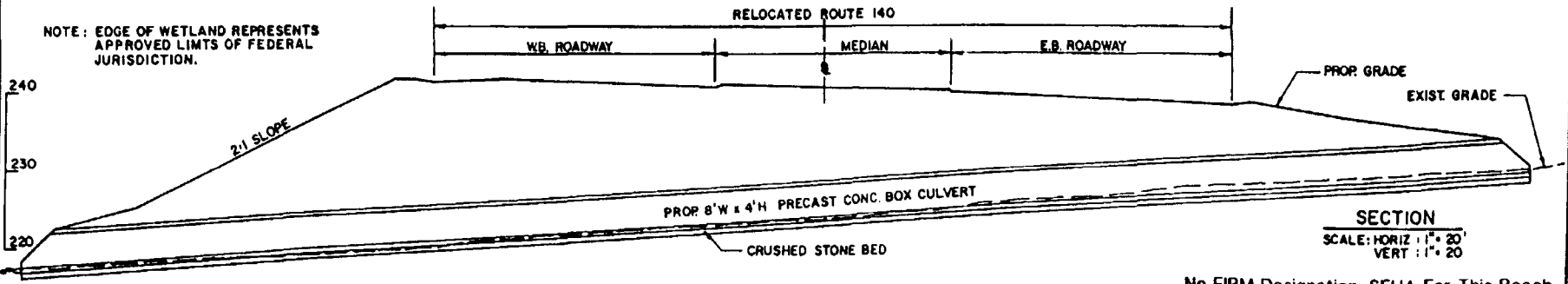

SECTION
SCALE: HORIZ : 1" = 20'
VERT : 1" = 20'

No FIRM Designation, SFHA For This Reach

Massachusetts Department of Public Works
10 Park Plaza, Boston, MA 02116-3973

RELOCATED ROUTE 140
WETLAND PLAN / CROSS SECTION

DATE
NOVEMBER, 1990

AT. FRANKLIN
IN. MINE BROOK
NORFOLK COUNTY
COMMONWEALTH OF MASSACHUSETTS

APPLICATION BY:
COMMONWEALTH OF MASSACHUSETTS
DEPARTMENT OF PUBLIC WORKS

SHEET OF
4 7

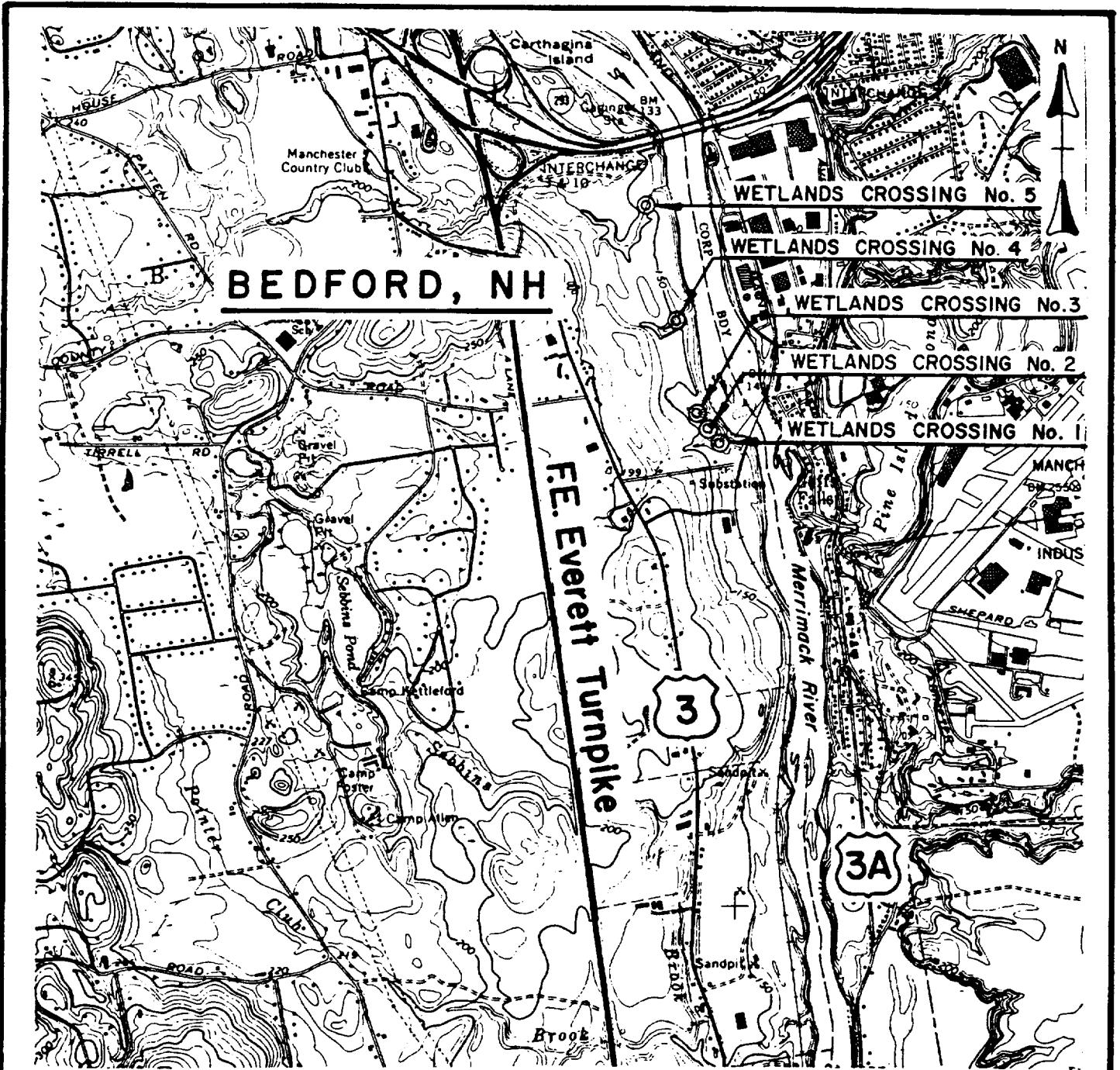

Map Source : U.S.G.S. 7.5' Quadrangle , Manchester South, NH , 1985

PURPOSE : WASTEWATER COLLECTION SYSTEM

DATUM : NGVD 1929

ADJACENT PROPERTY OWNERS :

SEE ATTACHED SHEETS

VICINITY MAP.

1000 0 2000 FT.



1:24000

TOWN OF BEDFORD, NH
PUBLIC WORKS DEPARTMENT
24 NORTH AMHERST ROAD
BEDFORD, NH 03102

SEWER INTERCEPTOR
WETLANDS CROSSINGS

ADJACENT TO : MERRIMACK RIVER
AT : TOWN OF BEDFORD

COUNTY : HILLSBOROUGH, STATE : NH
APPLICATION BY : TOWN OF BEDFORD
SHEET 1 OF 12 DATE : AUGUST 15, 1990

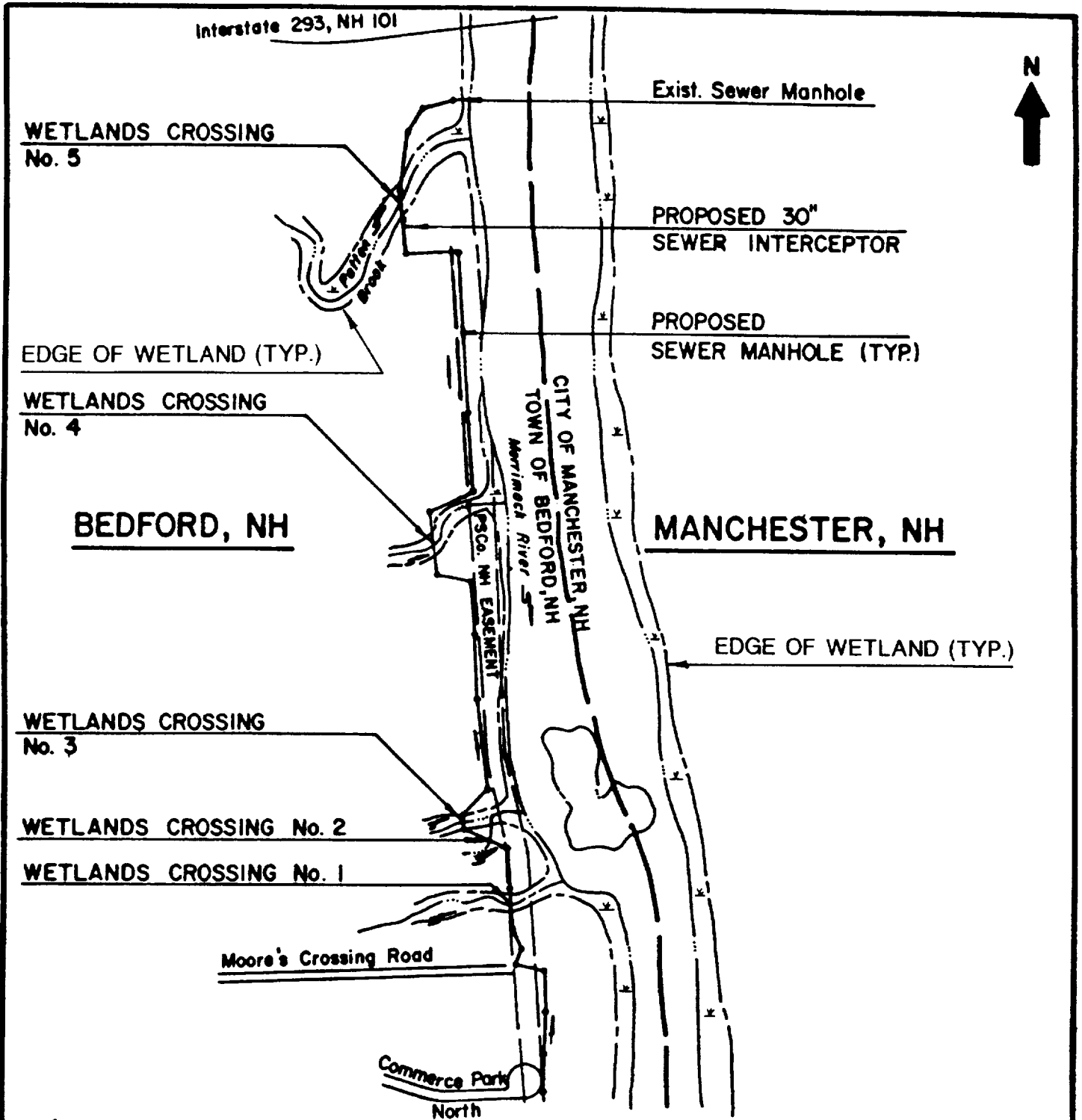

PURPOSE: WASTEWATER COLLECTION SYSTEM
DATUM: NGVD 1929
ADJACENT PROPERTY OWNERS:
 SEE ATTACHED SHEETS

OVERALL PLAN
 NOT TO SCALE
 TOWN OF BEDFORD, NH
 PUBLIC WORKS DEPARTMENT
 24 NORTH AMHERST ROAD
 BEDFORD, NH 03102

SEWER INTERCEPTOR WETLANDS CROSSINGS
 ADJACENT TO: MERRIMACK RIVER
 AT: TOWN OF BEDFORD
 COUNTY: HILLSBOROUGH, STATE: NH
 APPLICATION BY: TOWN OF BEDFORD
 SHEET 2 OF 12 DATE: AUGUST 16, 1990

LEGEND

- · EDGE OF WETLANDS
- - - · LIMIT OF AREA TO BE DISTURBED
- ▨ · AREA TO BE DISTURBED = 170 S.F.

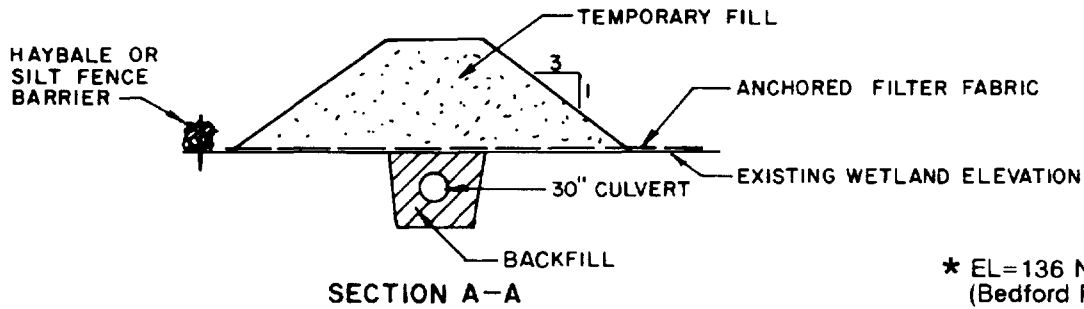
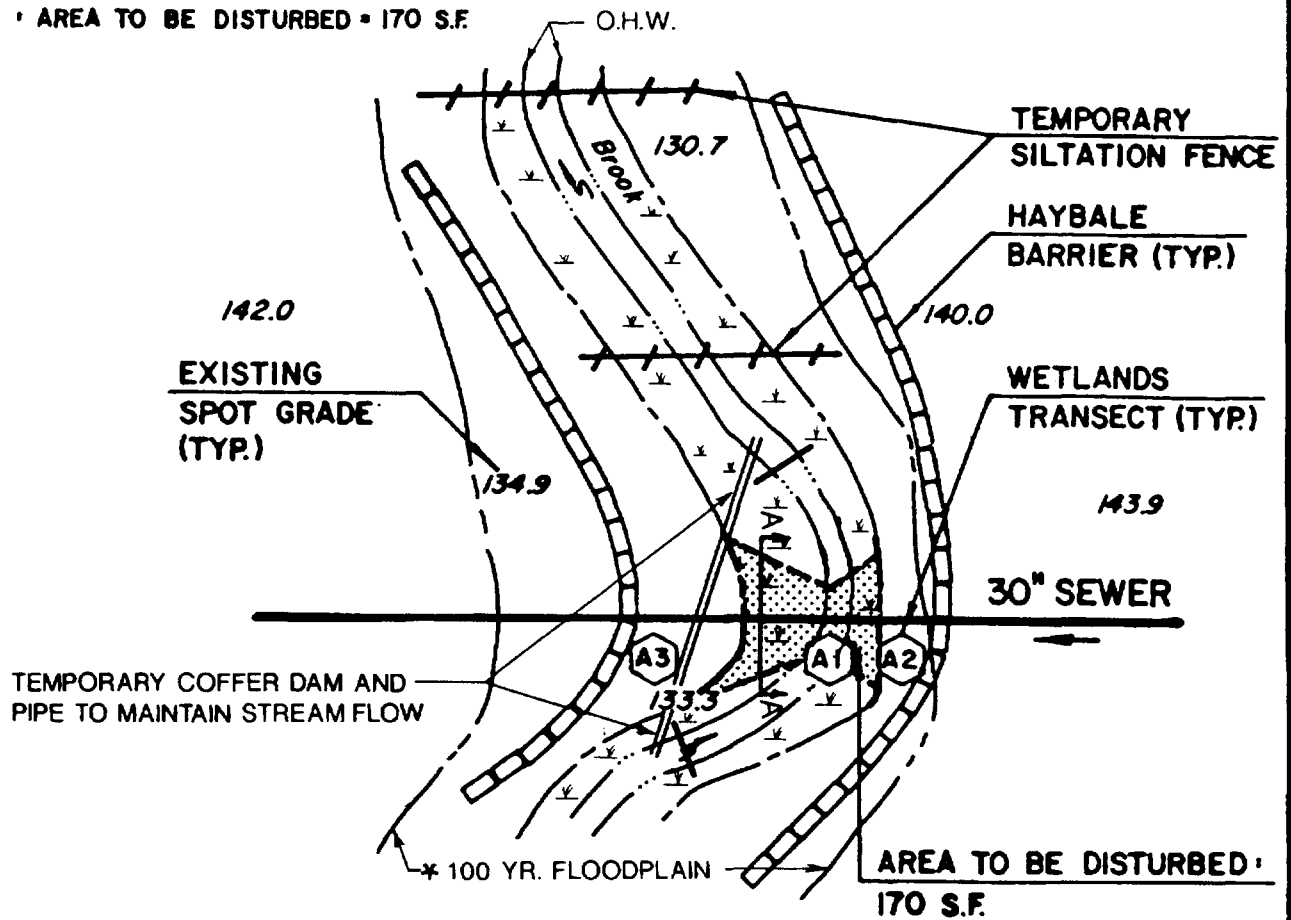

* EL=136 NGVD
(Bedford FIRM 4/16/79)
No Floodway Published
CROSSING No. 1

PURPOSE: WASTEWATER COLLECTION SYSTEM
DATUM: NGVD 1929
ADJACENT PROPERTY OWNERS:
SEE ATTACHED SHEETS

PLAN VIEW: CROSSING No. 1



TOWN OF BEDFORD, NH
PUBLIC WORKS DEPARTMENT
24 NORTH AMHERST ROAD
BEDFORD, NH 03102

**SEWER INTERCEPTOR
WETLANDS CROSSINGS**

ADJACENT TO: MERRIMACK RIVER
AT: TOWN OF BEDFORD
COUNTY: HILLSBOROUGH, STATE: NH
APPLICATION BY: TOWN OF BEDFORD
SHEET 3 OF 12 DATE: AUGUST 15, 1990

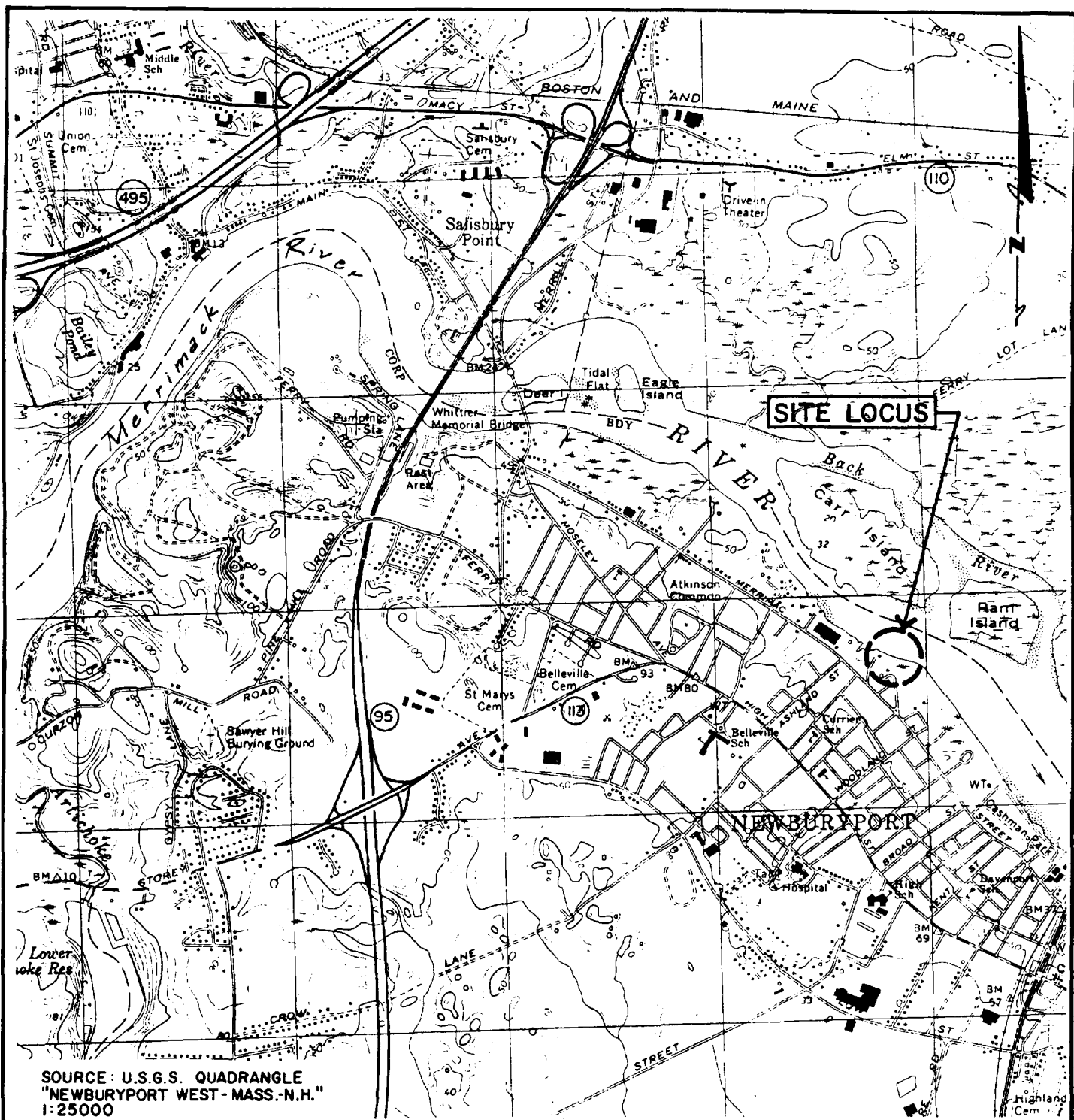

PURPOSE: ENLARGE MARINA
 CREATING ADDITIONAL SLIPS

DATUM: MLW = 0.0
 MHW = 7.5
 HTL = 7.8

CARMICHAEL ASSOCIATES, INC.
 1898 MERCER STREET SUITE 42
 PORTLAND, MAINE

VICINITY MAP

PROPOSED MARINA PLAN IN:
 MERRIMACK RIVER
 AT: 3-R MARINA
 COUNTY OF: ESSEX, MA.

APPLICATION BY:
 SIMON REALTY TRUST

DATE: MAY 1989 SHEET 1 of 5

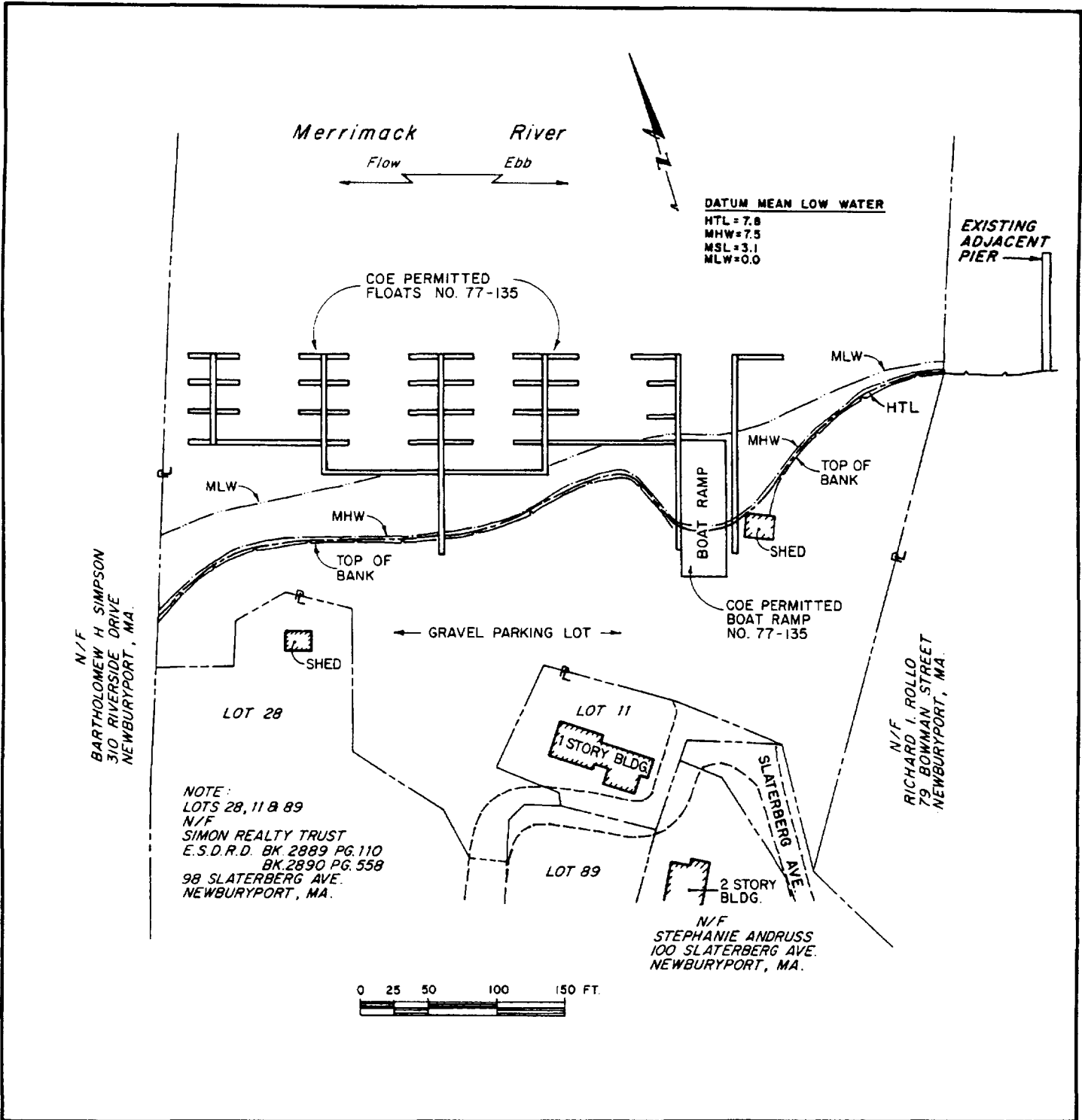

PURPOSE : ENLARGE MARINA
CREATING ADDITIONAL SLIPS

DATUM : MLW = 0.0
MHW = 7.5
HTL = 7.8

CARMICHAEL ASSOCIATES, INC.
1898 MERCER STREET SUITE 42
PORTLAND, MAINE

EXISTING MARINA

PROPOSED MARINA PLAN IN:
MERRIMACK RIVER

AT : 3-R MARINA

COUNTY OF : ESSEX, MA.

APPLICATION BY:
SIMON REALTY TRUST

DATE : MAY 1989 SHEET 2 of 5

STATE PLANE COORDINATES

	N	E
1.	665349	764733
2.	665299	764822
3.	665247	764907
4.	665205	764996
5.	665139	765072
6.	665092	765150
7.	664937	765065

Merrimack River

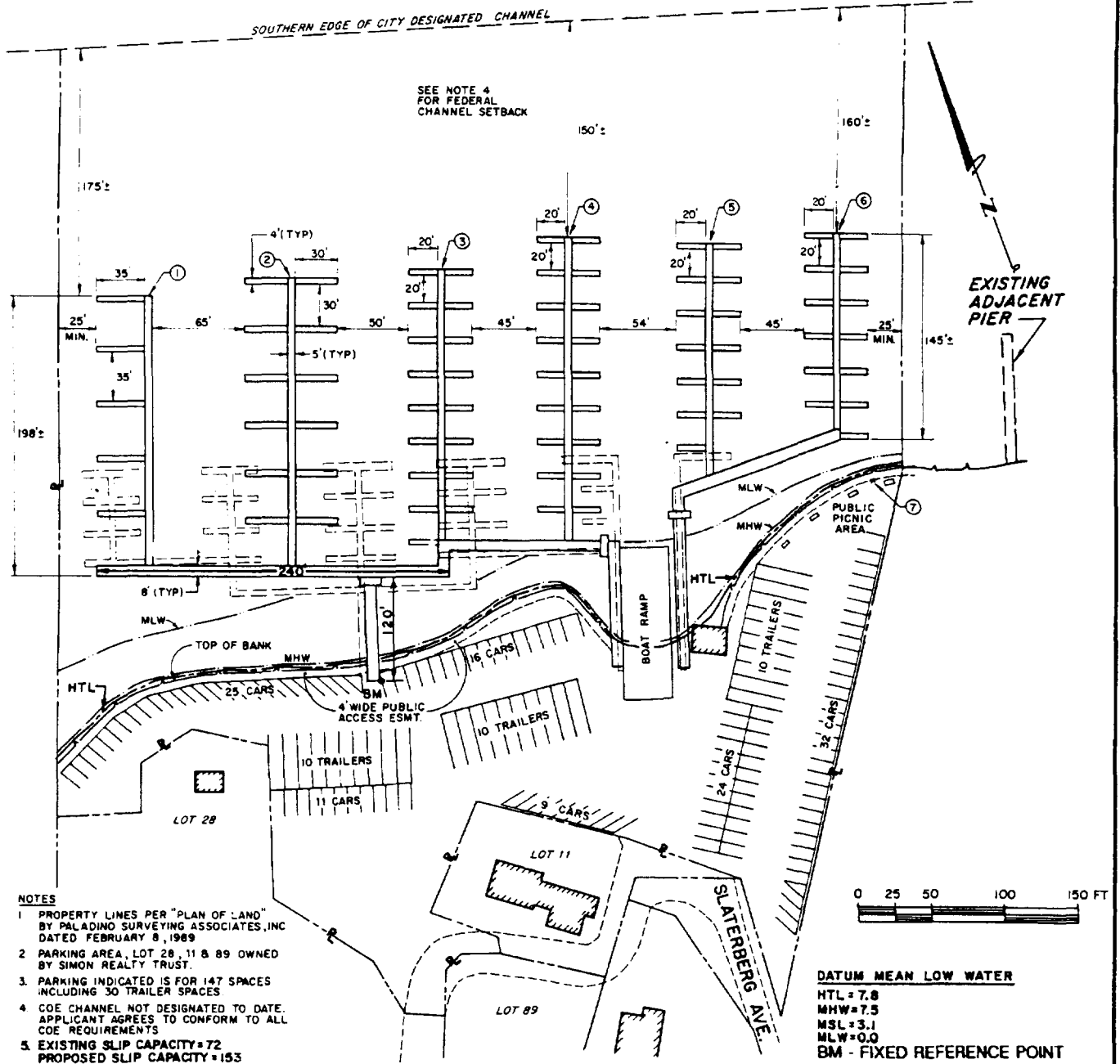
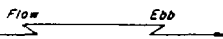

NOTES

1. PROPERTY LINES PER "PLAN OF LAND" BY PALADINO SURVEYING ASSOCIATES, INC DATED FEBRUARY 8, 1989
2. PARKING AREA, LOT 28, 11 & 89 OWNED BY SIMON REALTY TRUST.
3. PARKING INDICATED IS FOR 147 SPACES INCLUDING 30 TRAILER SPACES
4. COE CHANNEL NOT DESIGNATED TO DATE. APPLICANT AGREES TO CONFORM TO ALL COE REQUIREMENTS
5. EXISTING SLIP CAPACITY = 72
PROPOSED SLIP CAPACITY = 153

DATUM MEAN LOW WATER

- HTL = 7.8
- MHW = 7.5
- MSL = 3.1
- MLW = 0.0
- BM - FIXED REFERENCE POINT

PURPOSE : ENLARGE MARINA
CREATING ADDITIONAL SLIPS

DATUM : MLW = 0.0
MHW = 7.5
HTL = 7.8

CARMICHAEL ASSOCIATES, INC.
1898 MERCER STREET SUITE 42
PORTLAND, MAINE

PROPOSED
MARINA
PLAN VIEW

PROPOSED MARINA PLAN IN:
MERRIMACK RIVER

AT : 3-R MARINA

COUNTY OF : ESSEX, MA.

APPLICATION BY:
SIMON REALTY TRUST

DATE : MAY 1989 SHEET 3 of 5

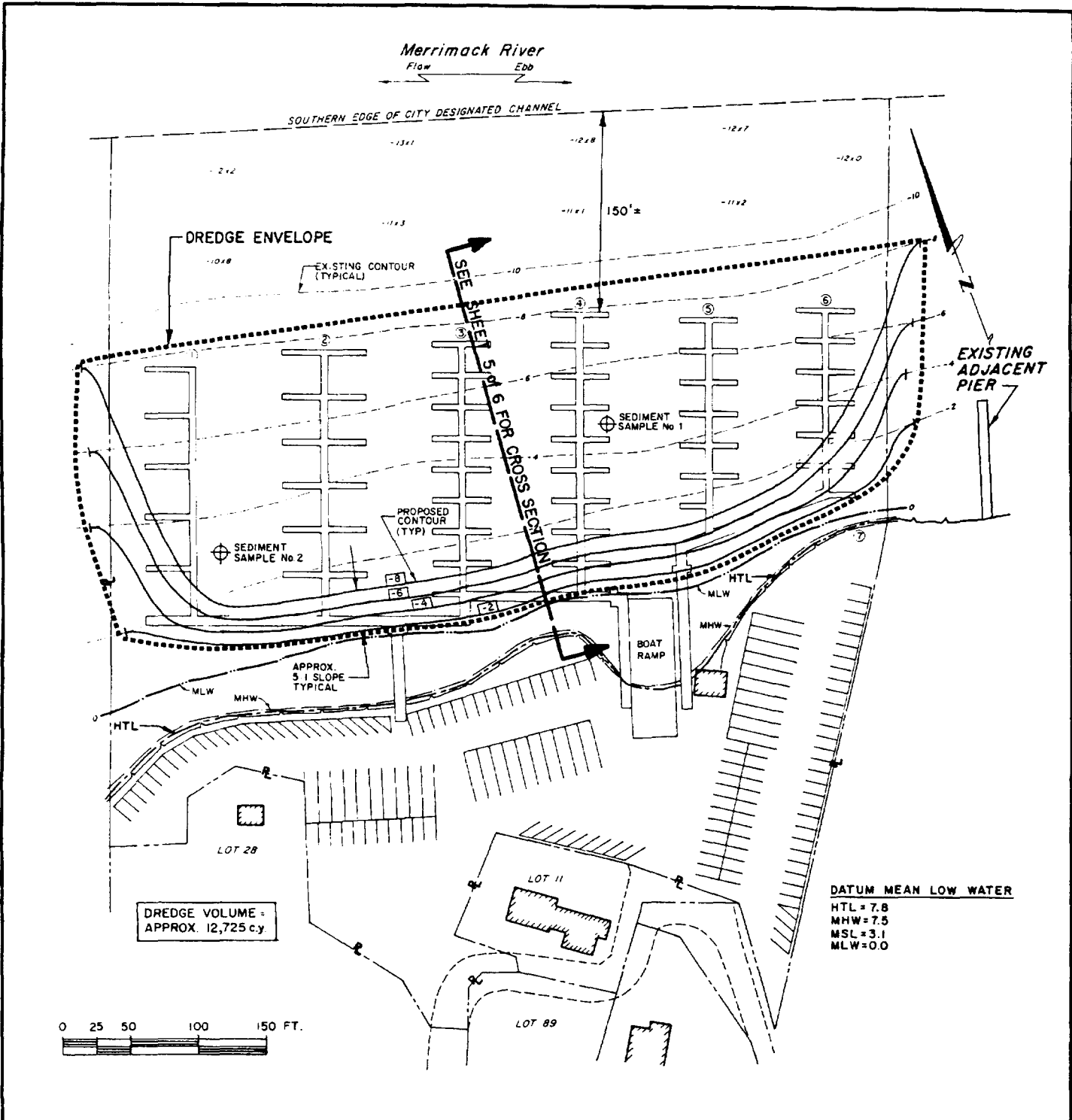

PURPOSE: ENLARGE MARINA
CREATING ADDITIONAL SLIPS

DATUM: MLW = 0.0
MHW = 7.5
HTL = 7.8

CARMICHAEL ASSOCIATES, INC.
1898 MERCER STREET SUITE 42
PORTLAND, MAINE

DREDGING PLAN

PROPOSED MARINA PLAN IN:
MERRIMACK RIVER

AT: 3-R MARINA

COUNTY OF: ESSEX, MA.

APPLICATION BY:
SIMON REALTY TRUST

DATE: MAY 1989 SHEET 4 of 5

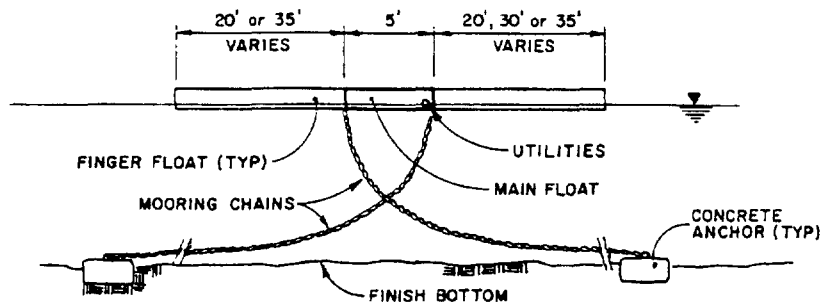

TYPICAL CROSS SECTION THROUGH FINGERS

NOT TO SCALE

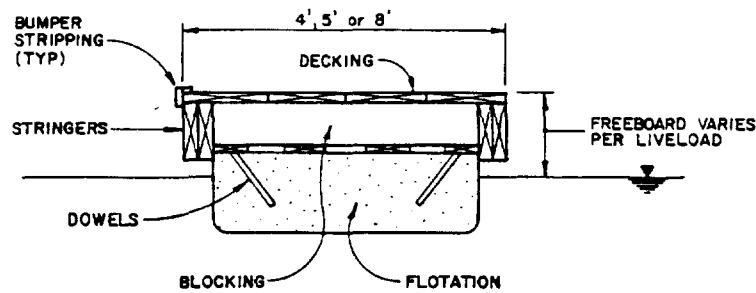

TYPICAL MARINA FLOAT

NOT TO SCALE

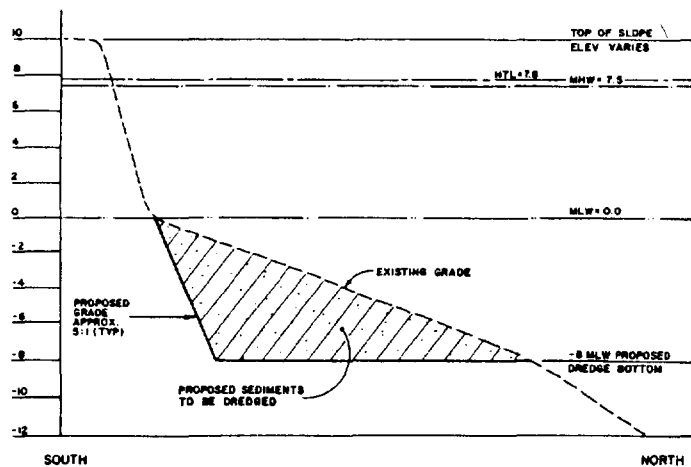

CROSS SECTION OF DREDGED AREA

SCALE: H 1" = 100' V 1" = 10'

PURPOSE: ENLARGE MARINA
CREATING ADDITIONAL SLIPS

DATUM: MLW = 0.0
MHW = 7.5
HTL = 7.8

CARMICHAEL ASSOCIATES, INC.
1898 MERCER STREET SUITE 42
PORTLAND, MAINE

**FLOAT DETAILS
AND
CROSS SECTION
OF
DREDGED AREA**

PROPOSED MARINA PLAN IN:
MERRIMACK RIVER

AT: 3-R MARINA
COUNTY OF: ESSEX, MA.

APPLICATION BY:
SIMON REALTY TRUST

DATE: MAY 1989 SHEET 5 of 5

APPLICATION FOR DEPARTMENT OF THE ARMY PERMIT
(33 CFR 325)

OMB APPROVAL NO. 0710-003
Expires October 1996

Public reporting burden for this collection of information is estimated to average 5 hours per response, including the time for reviewing instructions, searching existing data sources, gathering and maintaining the data needed, and completing and reviewing the collection of information. Send comments regarding this burden estimate or any other aspect of this collection of information, including suggestions for reducing this burden, to Department of Defense, Washington Headquarters Service Directorate of Information Operations and Reports, 1215 Jefferson Davis Highway, Suite 1204, Arlington, VA 22202-4302; and to the Office of Management and Budget, Paperwork Reduction Project (0710-0003), Washington, DC 20503. Please DO NOT RETURN your form to either of those addresses. Completed applications must be submitted to the District Engineer having jurisdiction over the location of the proposed activity.

PRIVACY ACT STATEMENT

Authority: 33 USC 401, Section 10; 1413, Section 404. Principal Purpose: These laws require permits authorizing activities in, or affecting, navigable waters of the United States, the discharge of dredged or fill material into waters of the United States, and the transportation of dredged material for the purpose of dumping it into ocean waters. Routine Uses: Information provided on this form will be used in evaluating the application for a permit. Disclosure: Disclosure of requested information is voluntary. If information is not provided, however, the permit application cannot be processed nor can a permit be issued.

One set of original drawings or good reproducible copies which show the location and character of the proposed activity must be attached to this application (see sample drawings and instructions) and be submitted to the District Engineer having jurisdiction over the location of the proposed activity. An application that is not completed in full will be returned.

(ITEMS 1 THRU 4 TO BE FILLED BY THE CORPS)

1. APPLICATION NO.	2. FIELD OFFICE CODE	3. DATE RECEIVED	4. DATE APPLICATION COMPLETED
--------------------	----------------------	------------------	-------------------------------

(ITEMS BELOW TO BE FILLED BY APPLICANT)

5. APPLICANT'S NAME American Developers Associates	8. AUTHORIZED AGENT'S NAME AND TITLE (an agent is not required) James L. Butterfield & Assoc.
6. APPLICANT'S ADDRESS 123 Broadway Providence, RI 02909	9. AGENT'S ADDRESS 19 Washington Street Providence, RI 02909
7. APPLICANT'S PHONE NOS. W/AREA CODE a. Residence N/A b. Business (401) 555-6000	10. AGENT'S PHONE NOS. W/AREA CODE a. Residence N/A b. Business (401) 555-5000

11. STATEMENT OF AUTHORIZATION
I hereby authorize, James L. Butterfield & Assoc. to act in my behalf as my agent in the processing of this application and to furnish, upon request, supplemental information in support of this permit application.

Robert E. Connors
APPLICANT'S SIGNATURE

Aug. 1, 1987
DATE

NAME, LOCATION AND DESCRIPTION OF PROJECT OR ACTIVITY

12. PROJECT NAME OR TITLE (see instructions) Shady Oaks Estates	
13. NAME OF WATERBODY, IF KNOWN (if applicable) Miller River	14. PROJECT STREET ADDRESS (if applicable) Hines Road, Cumberland
15. LOCATION OF PROJECT <u>Providence County</u> <u>Rhode Island</u> COUNTY STATE	
16. OTHER LOCATION DESCRIPTIONS, IF KNOWN, (see instructions)	

17. DIRECTIONS TO THE SITE
Take 295 to Route 114 South - Go 1/2 mile then bear left onto Bear Hill Road. Take right onto Hines Street. Follow for One mile. Look for dirt road on left.

18. Nature of Activity (Description of project, include all features)

Discharge fill material for three subdivision roadway crossings:

1. Approximately 100' x 30' in wetland crossing A at Acadia Drive (Sheet 4 of 9).
2. Approximately 120' x 60' in wetland crossing B and Miller River at Katahdin Dr. (Sheet 5 of 9).
3. Approximately 120' x 60' in wetland crossing C and Miller River, including box culvert at Acadia Drive (Sheet 7 of 9).

19. Project Purpose (Describe the reason or purpose of the project, see instructions)

Shady Oaks Estates multiple lot residential subdivision. All lots to be developed on upland. Construction is expected to begin April 1988 and take approximately one year to complete.

USE BLOCKS 20-22 IF DREDGED AND/OR FILL MATERIAL IS TO BE DISCHARGED

20. Reason(s) for Discharge

The placement of fill is necessary to construct subdivision roadways across wetlands/waterways.

21. Type(s) of Material Being Discharged and the Amount of Each Type in Cubic Yards

Clean granular fill material, trucked in, and placed by dozer, front and loader and grader:

1. 300 CY in Wetland A.
2. 760 CY in Wetland B; 15 CY below OHW of Miller River.
3. 3,000 CY in Wetland C; 20 CY below OHW of Miller River.

22. Surface Area in Acres of Wetlands or Other Waters Filled (see instructions)

1. 2,800 SF Wetland A
2. 3,600 SF Wetland B (420 SF below OHW of Miller River)
3. 6,600 SF Wetland C (800 SF below OHW of Miller River)

23. Is Any Portion of the Work Already Complete? Yes No IF YES, DESCRIBE THE COMPLETED WORK

24. Addresses of Adjoining Property Owners, Lessees, Etc., Whose Property Adjoins the Waterbody (If more than can be entered here, please attach a supplemental list).

See attached sheet.

25. List of Other Certifications or Approvals/Denials Received from other Federal, State or Local Agencies for Work Described in This Application.

AGENCY	TYPE APPROVAL*	IDENTIFICATION NUMBER	DATE APPLIED	DATE APPROVED	DATE DENIED
Planning Board	Sub-Division Approval	--	Sept. 1986	June 1987	----
Zoning Board	Site Plan Review	--	Sept. 1986	June 1987	----
RI - DEP	Wetland Permit	File #6682	Aug. 1987	Pending	

*Would include but is not restricted to zoning, building and flood plain permits

26. Application is hereby made for a permit or permits to authorize the work described in this application. I certify that the information in this application is complete and accurate. I further certify that I possess the authority to undertake the work described herein or am acting as the duly authorized agent of the applicant.

Robert E. Conners Aug. 14, 1987 Daniel Sweeney 8/14/87
 SIGNATURE OF APPLICANT DATE SIGNATURE OF AGENT DATE

The application must be signed by the person who desires to undertake the proposed activity (applicant) or it may be signed by a duly authorized agent if the statement in block 11 has been filled out and signed.

18 U.S.C. Section 1001 provides that: Whoever, in any manner within the jurisdiction of any department or agency of the United States knowingly and willfully falsifies, conceals, or covers up any trick, scheme, or disguises a material fact or makes any false, fictitious or fraudulent statements or representations or makes or uses any false writing or document knowing same to contain any false, fictitious or fraudulent statements or entry, shall be fined not more than \$10,000 or imprisoned not more than five years or both.

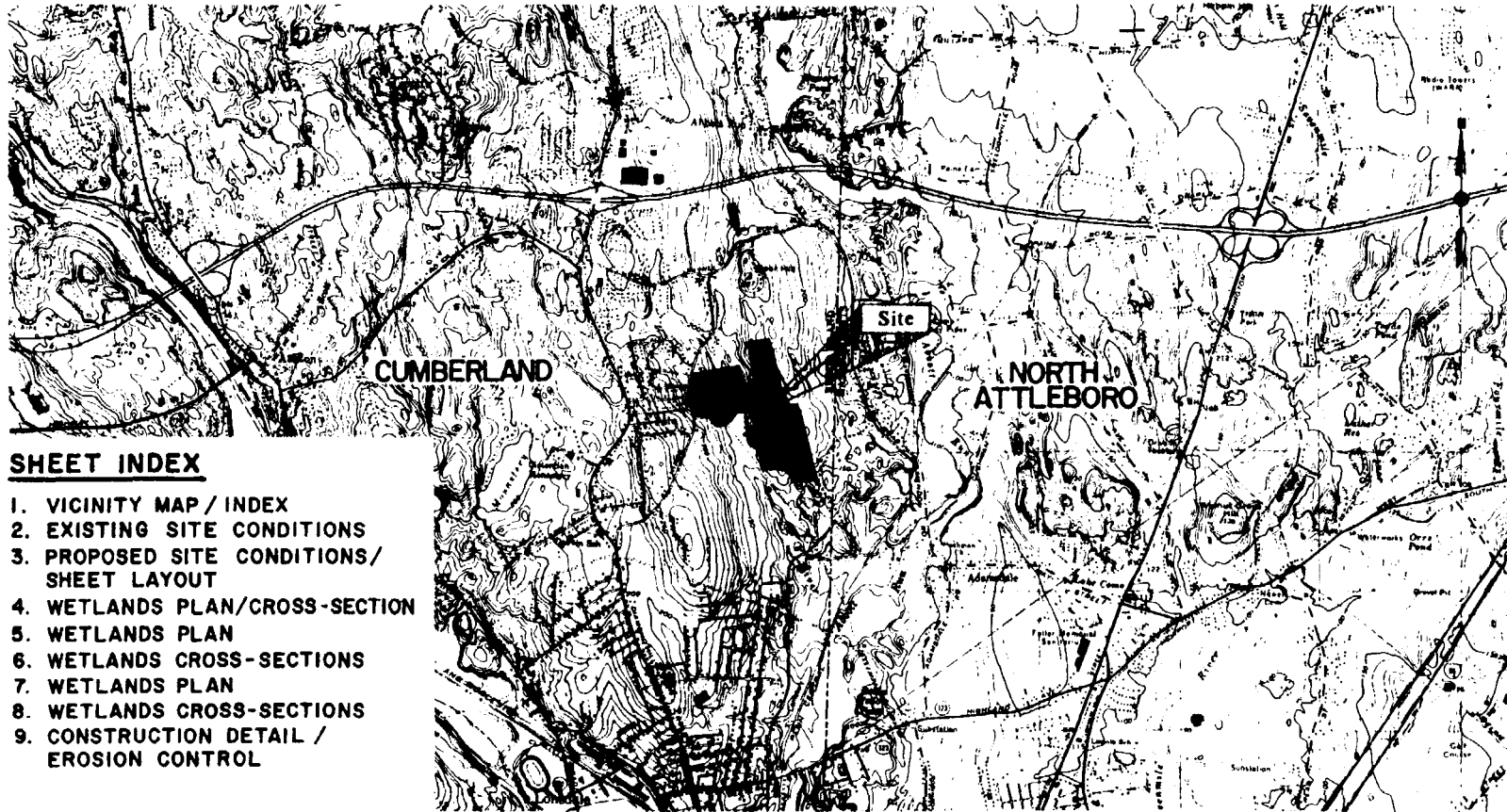

SHEET INDEX

1. VICINITY MAP / INDEX
2. EXISTING SITE CONDITIONS
3. PROPOSED SITE CONDITIONS / SHEET LAYOUT
4. WETLANDS PLAN/CROSS-SECTION
5. WETLANDS PLAN
6. WETLANDS CROSS-SECTIONS
7. WETLANDS PLAN
8. WETLANDS CROSS-SECTIONS
9. CONSTRUCTION DETAIL / EROSION CONTROL



*THESE PLANS COURTESY OF VANASSE HANGEN BRUSTLIN, INC.



James L. Butterfield & Assoc.
 Consulting Engineers & Planners
 Providence, Rhode Island 02909
 401/555-5000

SHADY OAKS ESTATES
 VICINITY MAP/INDEX

AT: CUMBERLAND
 IN: MILLERS RIVER
 PROVIDENCE COUNTY
 STATE OF RHODE ISLAND

APPLICATION BY:
 AMERICAN DEVELOPERS ASSOCIATES

DATE
 AUGUST 14, 1987

SHEET 1 OF 9

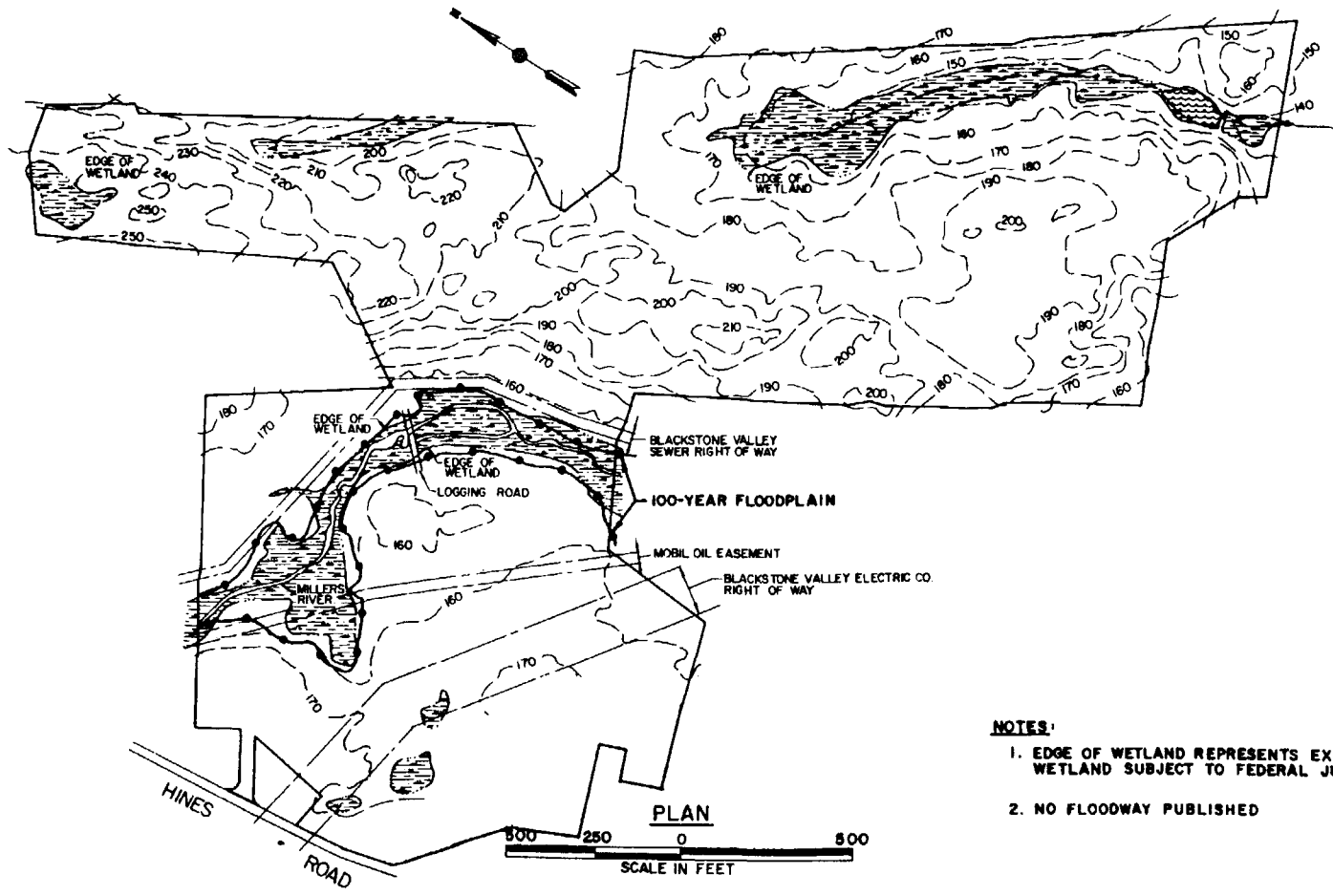

- NOTES:**
1. EDGE OF WETLAND REPRESENTS EXTENT OF WETLAND SUBJECT TO FEDERAL JURISDICTION
 2. NO FLOODWAY PUBLISHED

B James L. Butterfield & Assoc.
 Consulting Engineers & Planners
 Providence, Rhode Island 02909
 401/555-5000

**SHADY OAKS ESTATES
 EXISTING SITE CONDITIONS**

DATE
 AUGUST 14, 1987

AT: CUMBERLAND
 IN: MILLERS RIVER
 PROVIDENCE COUNTY
 STATE OF RHODE ISLAND

APPLICATION BY:
 AMERICAN DEVELOPERS ASSOCIATES

SHEET OF
 2 9

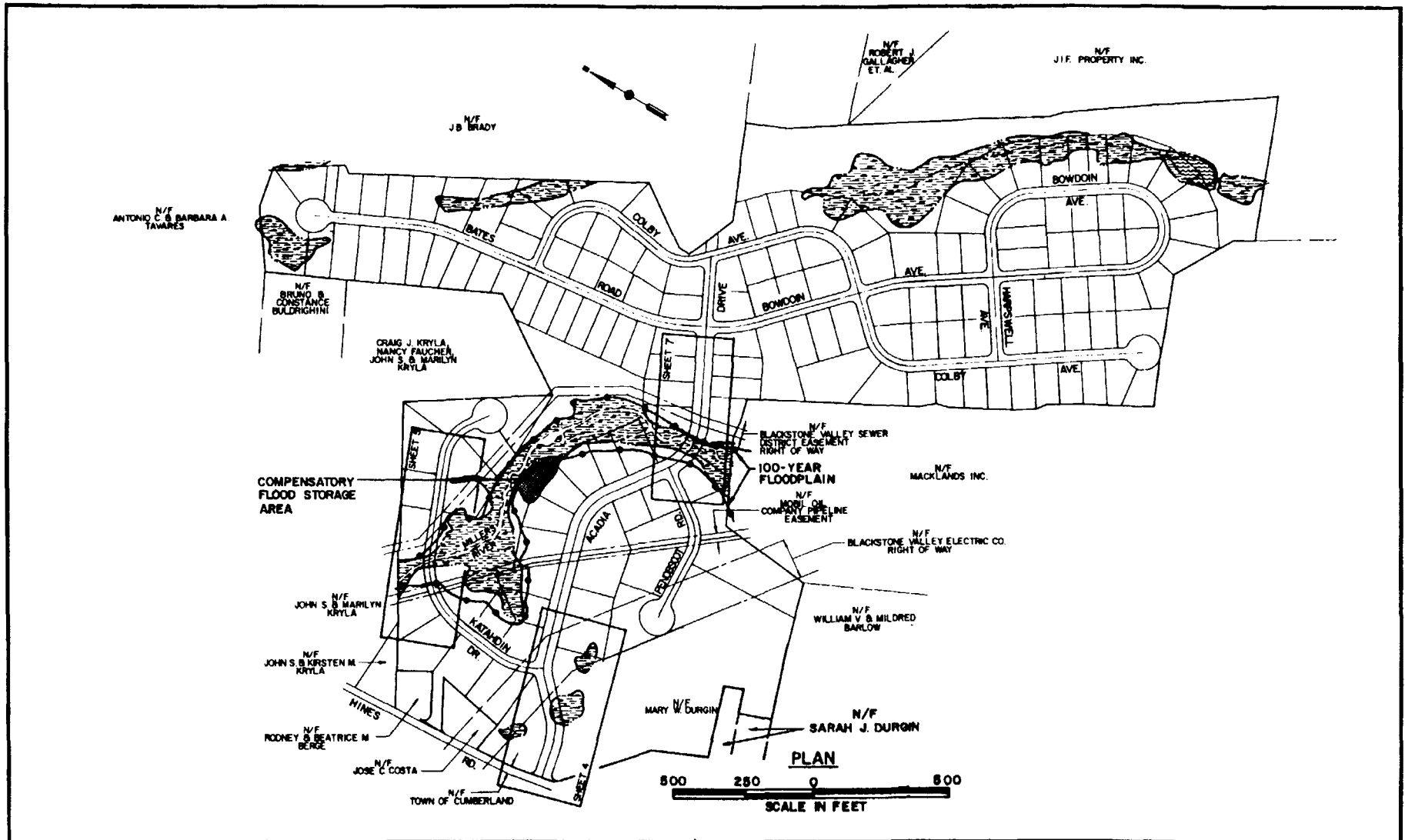

James L. Butterfield & Assoc.
 Consulting Engineers & Planners
 Providence, Rhode Island 02909
 401/555-5000

SHADY OAKS ESTATES
 PROPOSED SITE CONDITIONS/SHEET LAYOUT

DATE
 AUGUST 14, 1987

AT: CUMBERLAND
 IN: MILLERS RIVER
 PROVIDENCE COUNTY
 STATE OF RHODE ISLAND

APPLICATION BY:
 AMERICAN DEVELOPERS ASSOCIATES

SHEET OF
 3 9

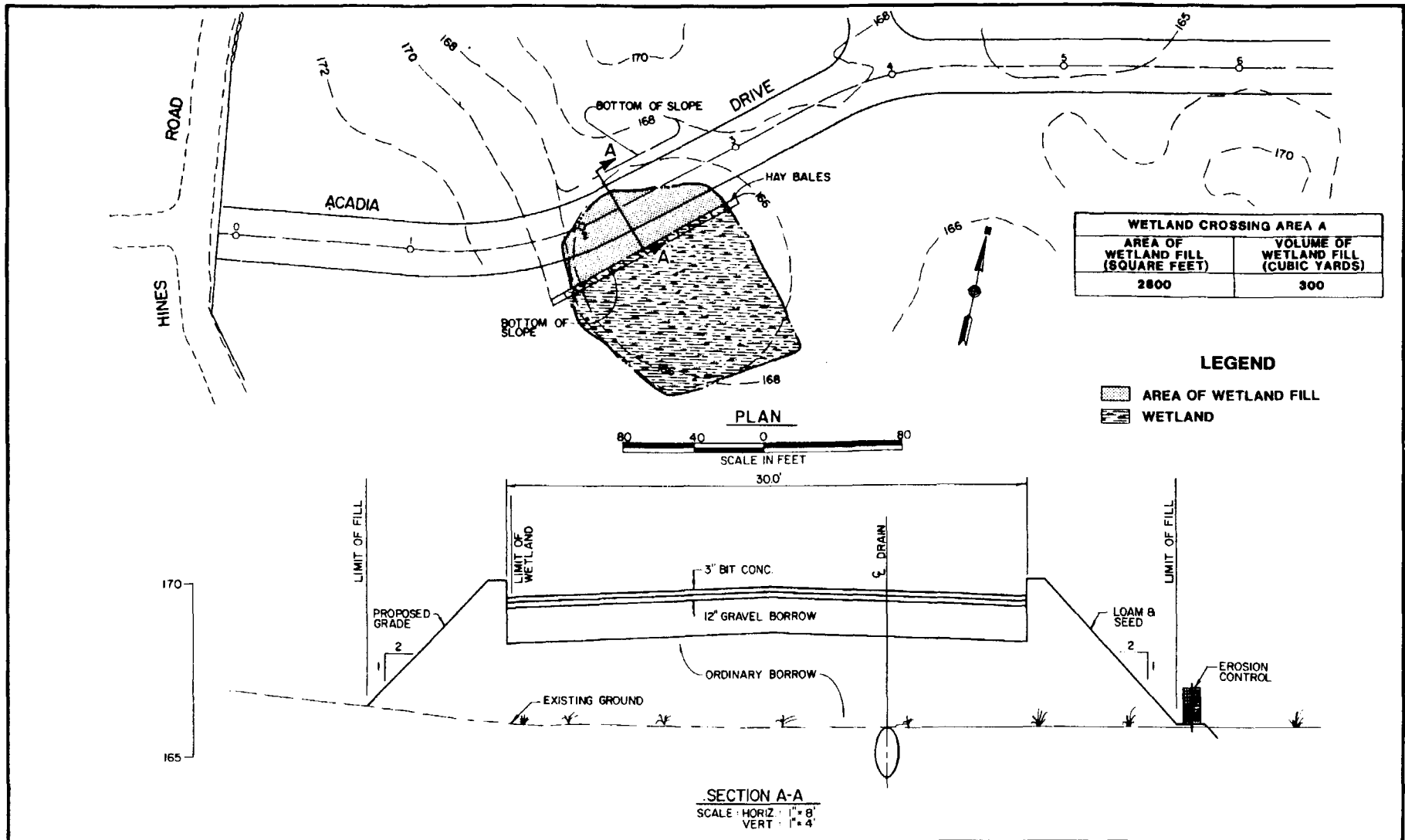

WETLAND CROSSING AREA A	
AREA OF WETLAND FILL (SQ. FEET)	VOLUME OF WETLAND FILL (CUBIC YARDS)
2800	300

LEGEND

AREA OF WETLAND FILL

WETLAND



James L. Butterfield & Assoc.
 Consulting Engineers & Planners
 Providence, Rhode Island 02909
 401/555-5000

**SHADY OAKS ESTATES
 WETLANDS PLAN/CROSS SECTION**

DATE
 AUGUST 14, 1987

AT: CUMBERLAND
 IN: MILLERS RIVER
 PROVIDENCE COUNTY
 STATE OF RHODE ISLAND

APPLICATION BY:
 AMERICAN DEVELOPERS ASSOCIATES

SHEET OF
 4 9

WETLAND CROSSING AREA B	
AREA OF WETLAND FILL (SQUARE FEET)	VOLUME OF WETLAND FILL (CUBIC YARDS)
3600	760

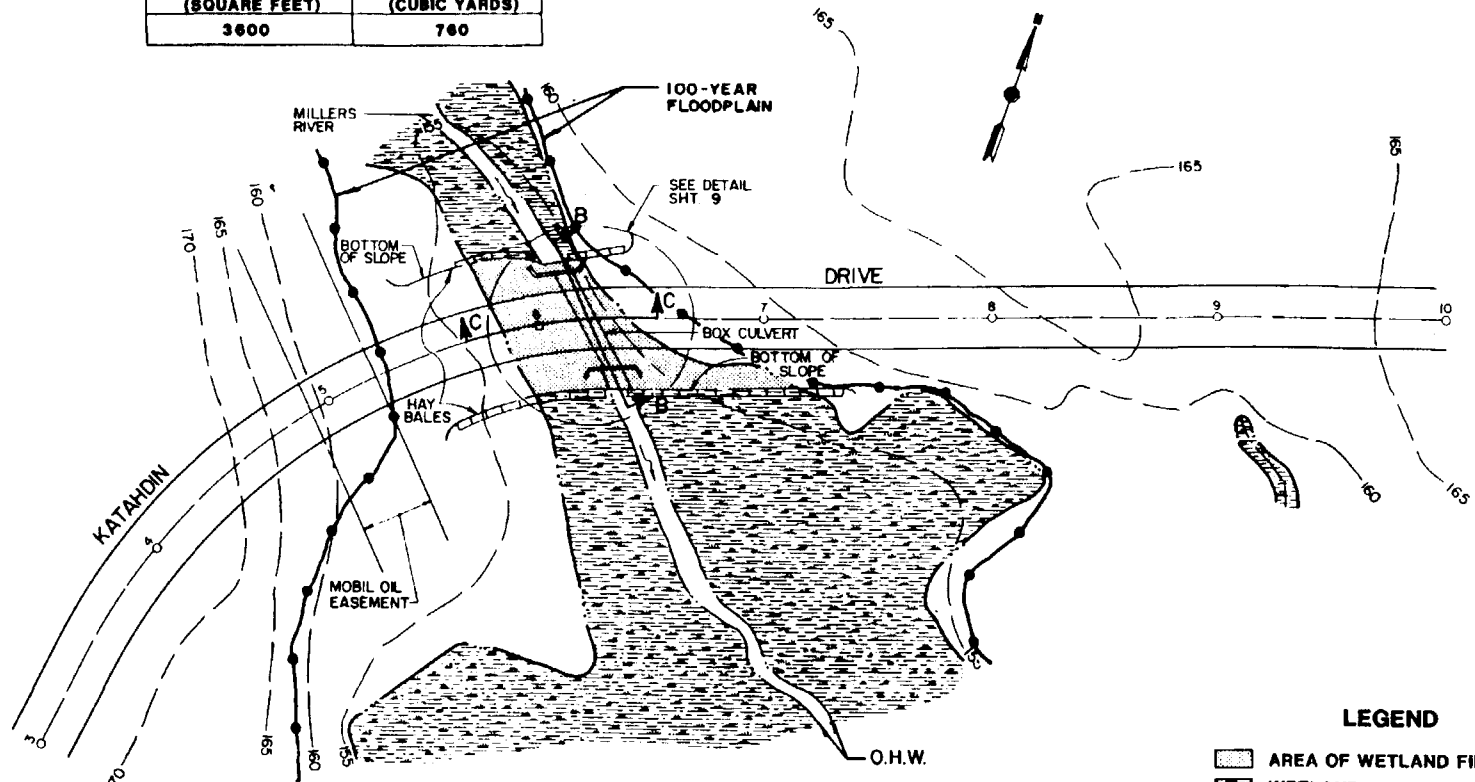

LEGEND
 AREA OF WETLAND FILL
 WETLAND

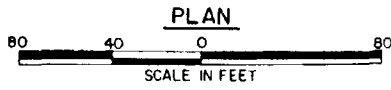

B James L. Butterfield & Assoc.
 Consulting Engineers & Planners
 Providence, Rhode Island 02909
 401/555-5000

**SHADY OAKS ESTATES
 WETLANDS PLAN**

DATE
 AUGUST 14, 1987

AT: CUMBERLAND
 IN: MILLERS RIVER
 PROVIDENCE COUNTY
 STATE OF RHODE ISLAND

APPLICATION BY:
 AMERICAN DEVELOPERS ASSOCIATES

SHEET OF
 5 9

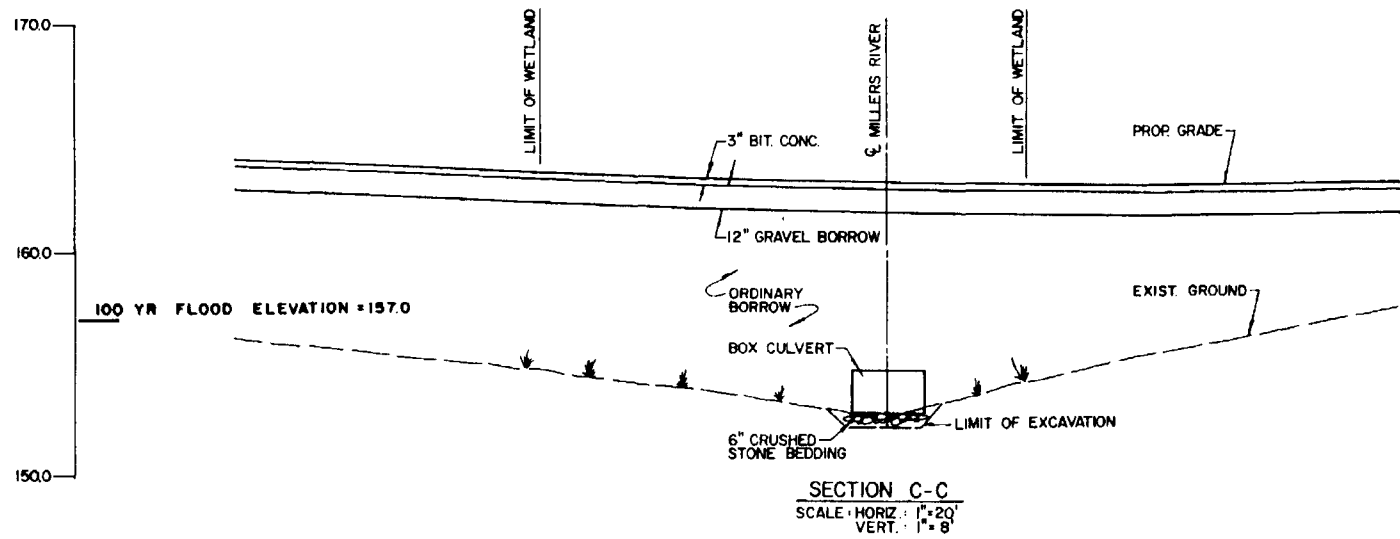
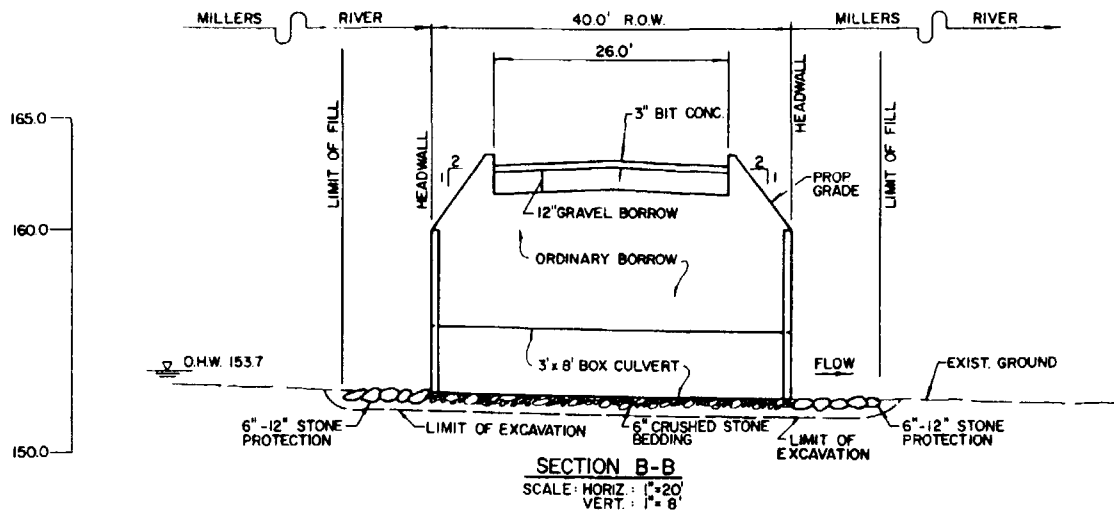

B James L. Butterfield & Assoc.
Consulting Engineers & Planners
Providence, Rhode Island 02909
401/555-5000

**SHADY OAKS ESTATES
WETLANDS CROSS-SECTIONS**

DATE
AUGUST 14, 1987

AT: CUMBERLAND
IN: MILLERS RIVER
PROVIDENCE COUNTY
STATE OF RHODE ISLAND

APPLICATION BY:
AMERICAN DEVELOPERS ASSOCIATES

SHEET OF
6 9

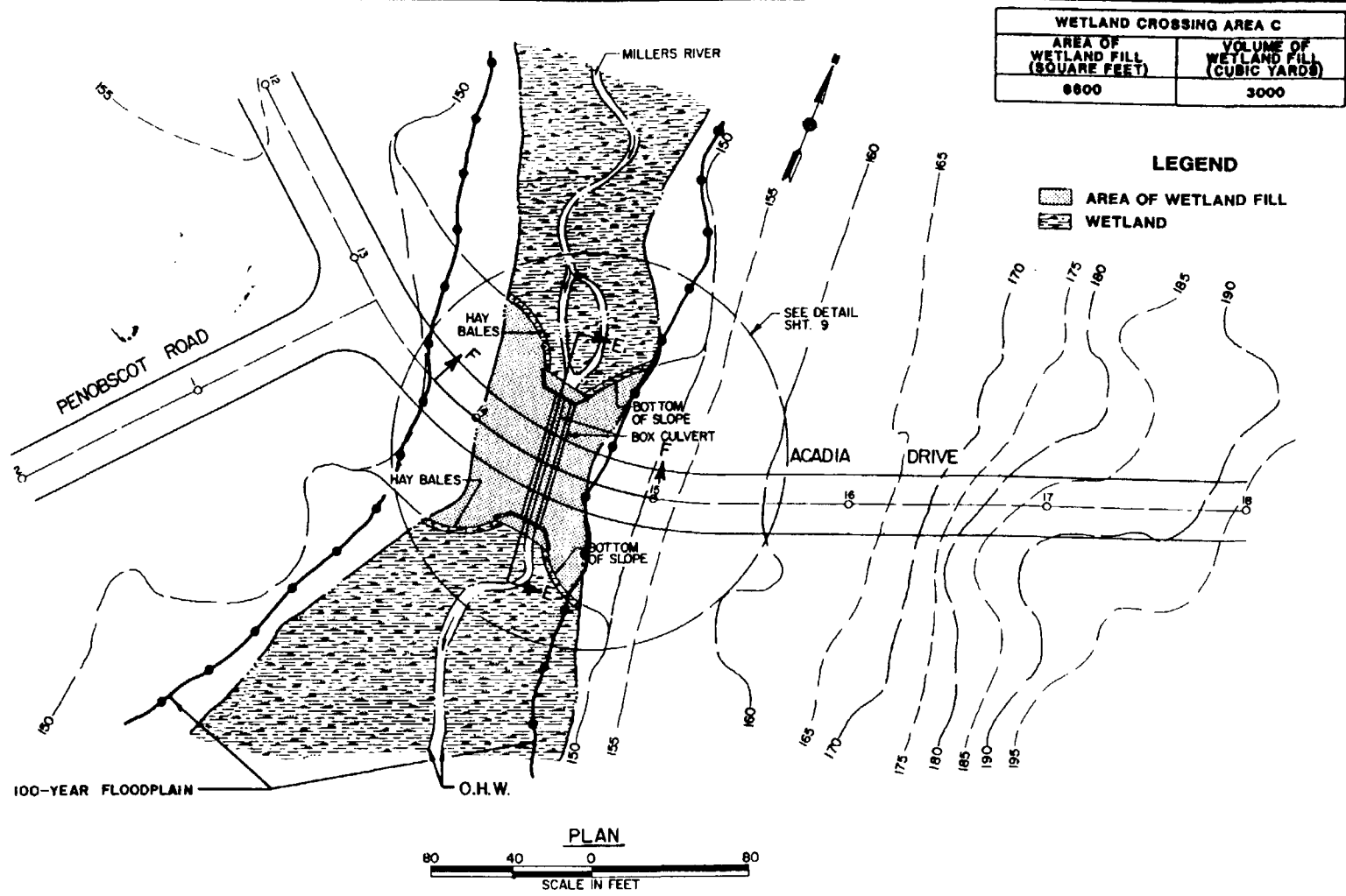

James L. Butterfield & Assoc.
 Consulting Engineers & Planners
 Providence, Rhode Island 02909
 401/555-5000

**SHADY OAKS ESTATES
 WETLANDS PLAN**

AT: CUMBERLAND
 IN: MILLERS RIVER
 PROVIDENCE COUNTY
 STATE OF RHODE ISLAND

APPLICATION BY:
AMERICAN DEVELOPERS ASSOCIATES

DATE
 AUGUST 14, 1987

SHEET OF
7 9

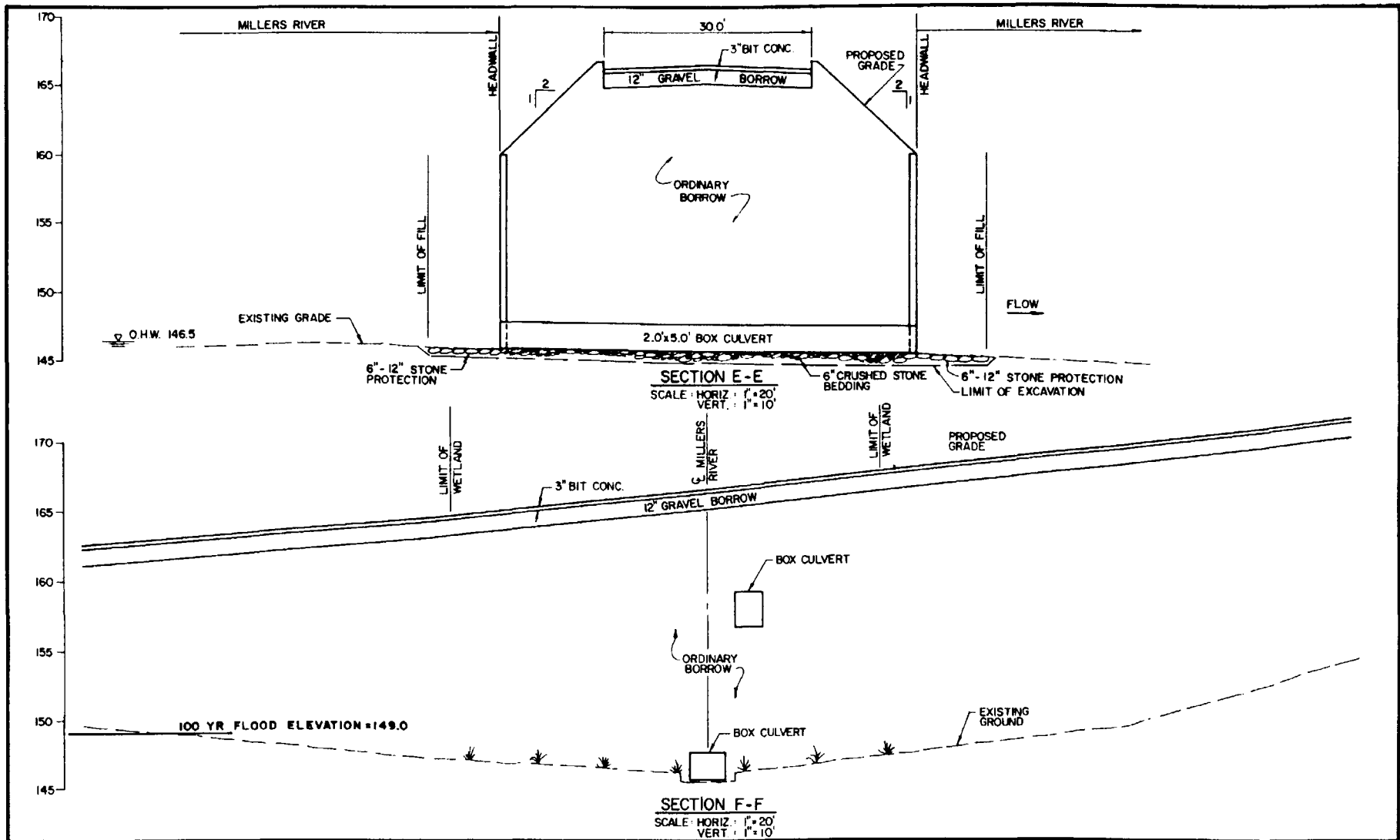

James L. Butterfield & Assoc.
Consulting Engineers & Planners
Providence, Rhode Island 02909
401/555-5000

**SHADY OAKS ESTATES
WETLANDS CROSS-SECTIONS**

AT: CUMBERLAND
IN: MILLERS RIVER
PROVIDENCE COUNTY
STATE OF RHODE ISLAND

APPLICATION BY:
AMERICAN DEVELOPERS ASSOCIATES

DATE
AUGUST 14, 1987

SHEET OF
8 9

NOTE: THIS DETAIL IS TYPICAL AT BOTH THE ACADIA DRIVE AND KATAHDIN DRIVE CROSSINGS OF MILLERS RIVER.

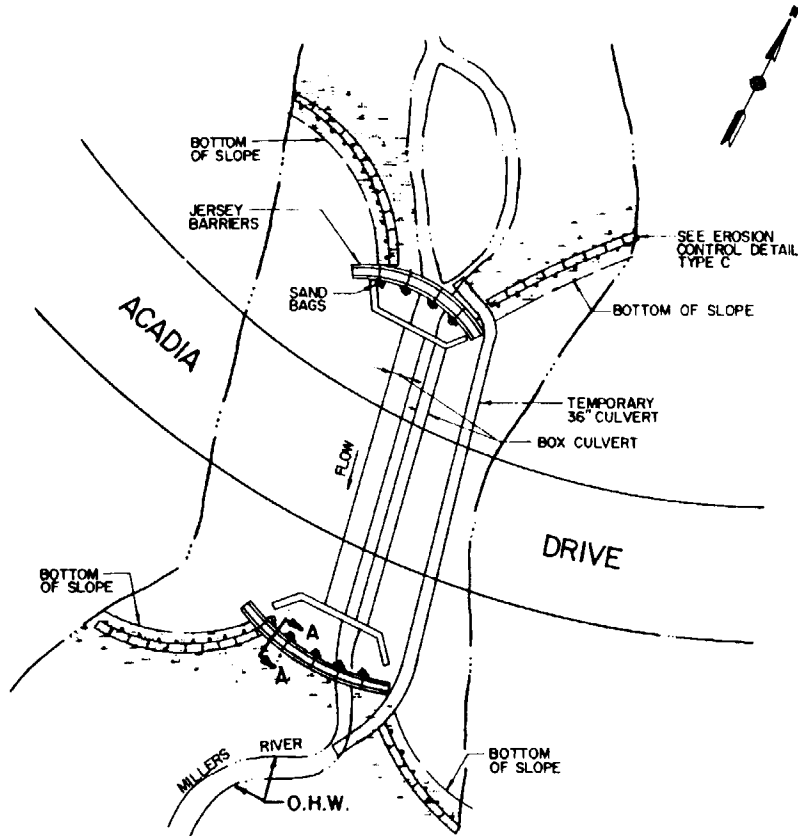

PLAN
SCALE: 1" = 40'

CONSTRUCTION PROCEDURES

1. INSTALL TYPE C EROSION CONTROL AS SHOWN.
2. EXCAVATE TRENCH FOR TEMPORARY CULVERT.
3. INSTALL TEMPORARY 36 INCH DIAMETER CULVERT. MATCH PROPOSED INVERT ELEVATIONS WITH EXISTING FLOW LINE OF MILLERS RIVER.
4. INSTALL JERSEY BARRIERS AND SAND BAGS AS SHOWN.
5. PUMP AREA BEHIND JERSEY BARRIERS TO PROVIDE DRY WORK AREA.
6. CONSTRUCT HEADWALLS, BOX CULVERTS, STONE PROTECTION, AND ROADWAYS AS SHOWN ON THE PLANS.
7. REMOVE JERSEY BARRIERS AND SAND BAGS.
8. CUT BACK TEMPORARY CULVERT INTO SIDE SLOPES SO ENTIRE CULVERT IS BURIED.
9. INSTALL TYPE C EROSION CONTROL TO EDGE OF HEADWALLS.

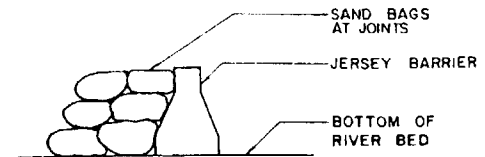

SECTION A-A
(NOT TO SCALE)

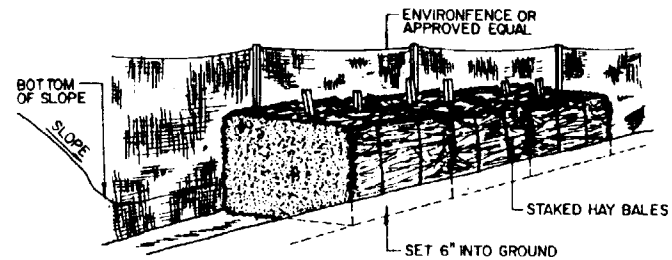

TYPE 'C'

EROSION CONTROL DETAIL
NOT TO SCALE



James L. Butterfield & Assoc.
Consulting Engineers & Planners
Providence, Rhode Island 02909
401/555-5000

SHADY OAKS ESTATES
CONSTRUCTION DETAIL/EROSION CONTROL

DATE

AUGUST 14, 1987

AT: CUMBERLAND
IN: MILLERS RIVER
PROVIDENCE COUNTY
STATE OF RHODE ISLAND

APPLICATION BY:

AMERICAN DEVELOPERS ASSOCIATES

SHEET OF

9 9

Public reporting burden for this collection of information is estimated to average 5 hours per response, including the time for reviewing instructions, searching existing data sources, gathering and maintaining the data needed, and completing and reviewing the collection of information. Send comments regarding this burden estimate or any other aspect of this collection of information, including suggestions for reducing this burden, to Department of Defense, Washington Headquarters Service Directorate of Information Operations and Reports, 1215 Jefferson Davis Highway, Suite 1204, Arlington, VA 22202-4302; and to the Office of Management and Budget, Paperwork Reduction Project (0710-0003), Washington, DC 20503. Please DO NOT RETURN your form to either of those addresses. Completed applications must be submitted to the District Engineer having jurisdiction over the location of the proposed activity.

PRIVACY ACT STATEMENT

Authority: 33 USC 401, Section 10; 1413, Section 404. Principal Purpose: These laws require permits authorizing activities in, or affecting, navigable waters of the United States, the discharge of dredged or fill material into waters of the United States, and the transportation of dredged material for the purpose of dumping it into ocean waters. Routine Uses: Information provided on this form will be used in evaluating the application for a permit. Disclosure: Disclosure of requested information is voluntary. If information is not provided, however, the permit application cannot be processed nor can a permit be issued.

One set of original drawings or good reproducible copies which show the location and character of the proposed activity must be attached to this application (see sample drawings and instructions) and be submitted to the District Engineer having jurisdiction over the location of the proposed activity. An application that is not completed in full will be returned.

(ITEMS 1 THRU 4 TO BE FILLED BY THE CORPS)

1. APPLICATION NO.	2. FIELD OFFICE CODE	3. DATE RECEIVED	4. DATE APPLICATION COMPLETED
--------------------	----------------------	------------------	-------------------------------

(ITEMS BELOW TO BE FILLED BY APPLICANT)

5. APPLICANT'S NAME Lexi S. Scott	8. AUTHORIZED AGENT'S NAME AND TITLE (an agent is not required) WVE Engineering Associates
6. APPLICANT'S ADDRESS 246 Eighth Avenue Falmouth, MA 02256	9. AGENT'S ADDRESS 1011 Harrison Avenue Northhampton, MA 01036
7. APPLICANT'S PHONE NOS. W/AREA CODE a. Residence (508) 555-3412 b. Business N/A	10. AGENT'S PHONE NOS. W/AREA CODE a. Residence N/A b. Business (413) 555-9876

11. STATEMENT OF AUTHORIZATION

I hereby authorize, WVE Engineering Associates to act in my behalf as my agent in the processing of this application and to furnish, upon request, supplemental information in support of this permit application.

Lexi S. Scott
APPLICANT'S SIGNATURE

1/3/89
DATE

NAME, LOCATION AND DESCRIPTION OF PROJECT OR ACTIVITY

12. PROJECT NAME OR TITLE (see instructions) Lexi S. Scott	
13. NAME OF WATERBODY, IF KNOWN (if applicable) Childs River	14. PROJECT STREET ADDRESS (if applicable) 246 8th Avenue Falmouth, MA 02256
15. LOCATION OF PROJECT <u>Barnstable County</u> <u>Massachusetts</u> COUNTY STATE	
16. OTHER LOCATION DESCRIPTIONS, IF KNOWN, (see instructions)	

17. DIRECTIONS TO THE SITE
From Waltham, MA take 95 South to Route 24 South to Route 495 South over the Bourne Bridge (Note 495 turns into Route 25 before crossing the Bourne Bridge). Follow 28 South into East Falmouth. Continue through East Falmouth Center then take a right onto Seacoast Shores Blvd. Take a left onto Eighth Avenue. Last house on the left.

18. Nature of Activity (Description of project, include all features)

The applicant proposes to remove an existing pier and float, and construct an 85 ft. timber bulkhead, a 4' x 72' pile-held timber pier, a 4' x 16' timber ell, an 8' x 16' timber float and 2 timber dolphins. Construction of the bulkhead requires filling approximately a 10' x 26' area below the High Tide Line (HTL).

19. Project Purpose (Describe the reason or purpose of the project, see instructions)

The purpose of the proposed activity is to provide recreational boating for the applicant to access the Childs River. Construction is expected to begin this spring and take two months to complete.

USE BLOCKS 20-22 IF DREDGED AND/OR FILL MATERIAL IS TO BE DISCHARGED

20. Reason(s) for Discharge

The proposed bulkhead alignment is needed to tie into the existing bulkheads on abutting properties. Fill material will be trucked to the site and stockpiled on uplands adjacent to the shoreline. Fill will be placed behind the bulkhead by a small, rubber tire front-end loader.

21. Type(s) of Material Being Discharged and the Amount of Each Type in Cubic Yards

A total of 200 CY of clean granular fill will be used to backfill the timber bulkhead.

22. Surface Area in Acres of Wetlands or Other Waters Filled (see instructions)

260 s.f. of waterway will be filled

23. Is Any Portion of the Work Already Complete? Yes No IF YES, DESCRIBE THE COMPLETED WORK

Existing pier and float are in place. Proposed to be removed.

24. Addresses of Adjoining Property Owners, Lessees, Etc., Whose Property Adjoins the Waterbody (If more than can be entered here, please attach a supplemental list).

East: Walter G. & Helen J. Rundle
248 8th Avenue
Falmouth, MA 02256

West: John J. & Janet H. Caldwell
244 8th Avenue
Falmouth, MA 02256

25. List of Other Certifications or Approvals/Denials Received from other Federal, State or Local Agencies for Work Described in This Application.

AGENCY	TYPE APPROVAL*	IDENTIFICATION NUMBER	DATE APPLIED	DATE APPROVED	DATE DENIED
Conservation Com. MA DEP Waterways Program	Order of Condition Waterways License	SE1-476 89-2165	Sept. 1, 1988 Jan. 1989	Dec. 14 1988 Pending	---- ----

*Would include but is not restricted to zoning, building and flood plain permits

26. Application is hereby made for a permit or permits to authorize the work described in this application. I certify that the information in this application is complete and accurate. I further certify that I possess the authority to undertake the work described herein or am acting as the duly authorized agent of the applicant.

SIGNATURE OF APPLICANT

DATE

W.V. Edwards P.E.
SIGNATURE OF AGENT

1/6/89
DATE

The application must be signed by the person who desires to undertake the proposed activity (applicant) or it may be signed by a duly authorized agent if the statement in block 11 has been filled out and signed.

18 U.S.C. Section 1001 provides that: Whoever, in any manner within the jurisdiction of any department or agency of the United States knowingly and willfully falsifies, conceals, or covers up any trick, scheme, or disguises a material fact or makes any false, fictitious or fraudulent statements or representations or makes or uses any false writing or document knowing same to contain any false, fictitious or fraudulent statements or entry, shall be fined not more than \$10,000 or imprisoned not more than five years or both.

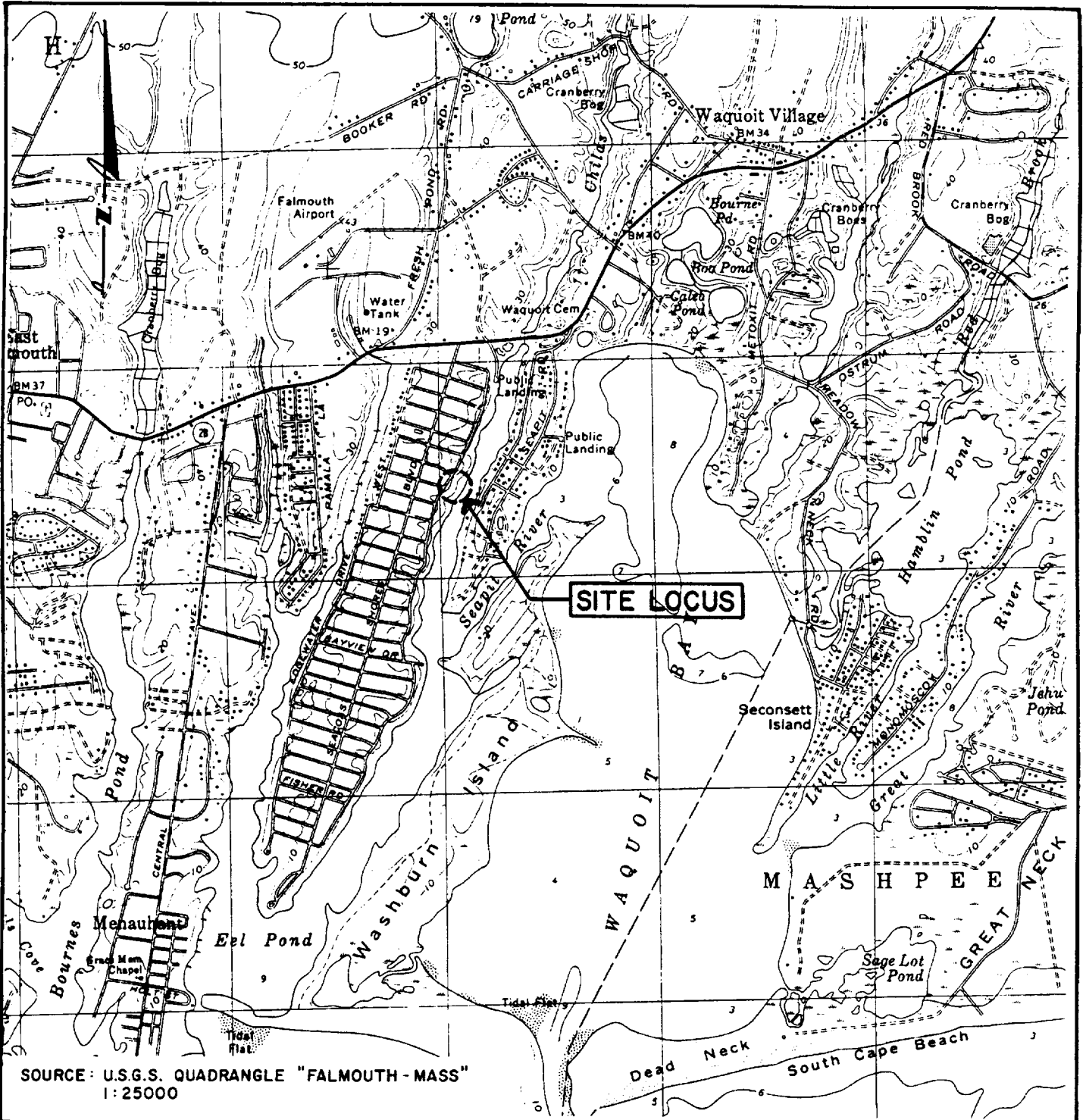

SOURCE: U.S.G.S. QUADRANGLE "FALMOUTH - MASS"
1:25000

PURPOSE: REPLACE EXISTING
TIMBER PIER

DATUM: MLW = 0.0
MHW = 1.9
HTL = 2.3

WVE ENGINEERING ASSOCIATES
1011 HARRISON AVENUE
NORTHAMPTON, MA.

VICINITY MAP

APPLICATION BY:
LEXI S. SCOTT
246 8TH AVENUE
FALMOUTH, MASSACHUSETTS

PROPOSED TIMBER PIER, FLOAT,
GANGWAY, ELL, DOLPHIN PILES
AND BULKHEAD

IN: CHILDS RIVER
AT: FALMOUTH, BARNSTABLE CO.,
MASSACHUSETTS

DATE: JAN. 1989 SHEET 1 of 4

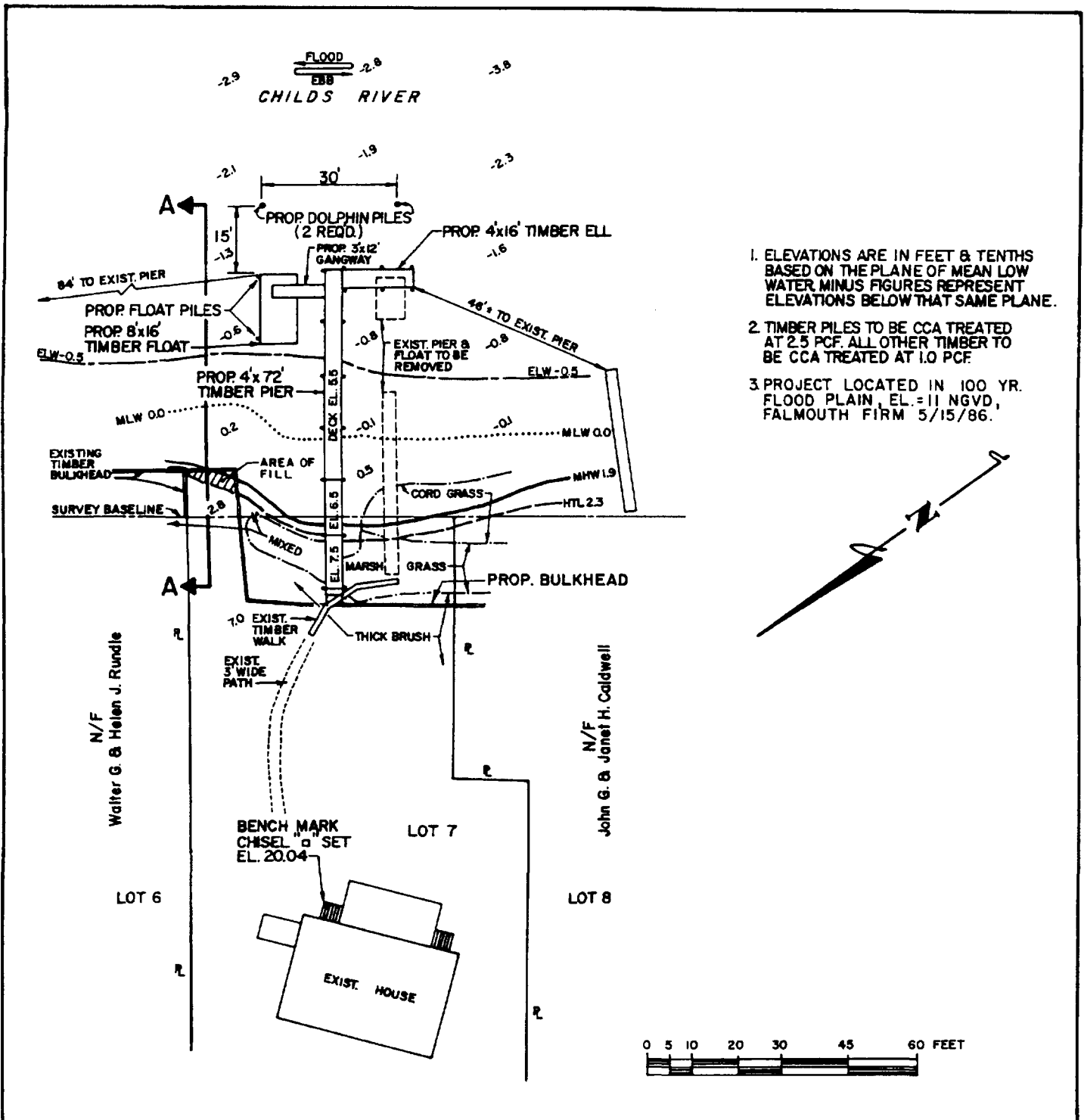

1. ELEVATIONS ARE IN FEET & TENTHS BASED ON THE PLANE OF MEAN LOW WATER. MINUS FIGURES REPRESENT ELEVATIONS BELOW THAT SAME PLANE.
2. TIMBER PILES TO BE CCA TREATED AT 2.5 PCF. ALL OTHER TIMBER TO BE CCA TREATED AT 1.0 PCF.
3. PROJECT LOCATED IN 100 YR. FLOOD PLAIN, EL = 11 NGVD, FALMOUTH FIRM 5/15/86.

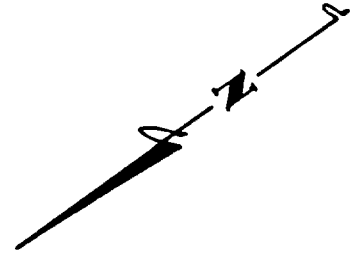

PURPOSE: REPLACE EXISTING TIMBER PIER

DATUM: MLW = 0.0
MHW = 1.9
HTL = 2.3

WVE ENGINEERING ASSOCIATES
1011 HARRISON AVENUE
NORTHAMPTON, MA.

PLAN VIEW

APPLICATION BY:
LEXI S. SCOTT
246 8TH AVENUE
FALMOUTH, MASSACHUSETTS

PROPOSED TIMBER PIER, FLOAT, GANGWAY, ELL, DOLPHIN PILES AND BULKHEAD

IN: CHILDS RIVER
AT: FALMOUTH, BARNSTABLE CO., MASSACHUSETTS

DATE: JAN. 1989 SHEET 2 of 4

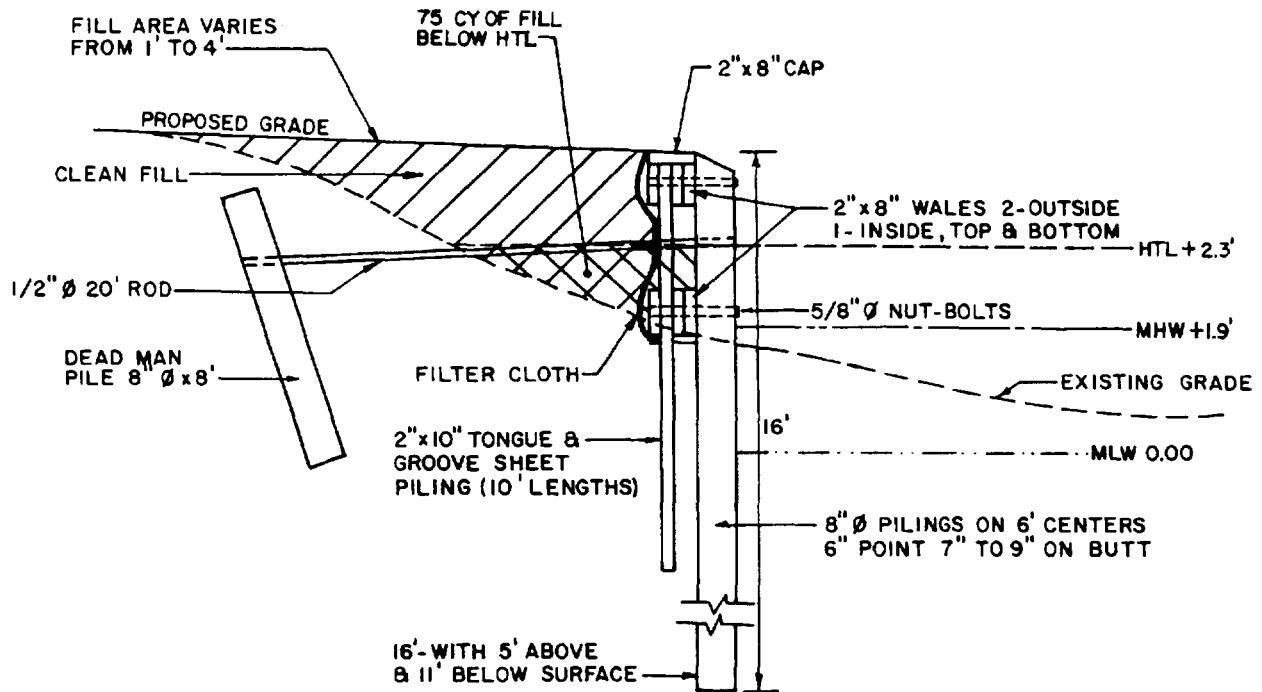

NOTE:

- 1) ALL TIMBER (INCLUDING PIER) PRESSURE & CHEMICAL TREATED.
- 2) ALL HARDWARE (INCLUDING PIER) HOT DIPPED GALVANIZED.
- 3) BULKHEAD TO BE PLACED BEHIND FRINGE WETLANDS
- 4) APPROX. 200 CU. YDS. OF CLEAN FILL.

SECTION A-A

NOT TO SCALE

PURPOSE: REPLACE EXISTING
TIMBER PIER

DATUM: MLW = 0.0
MHW = 1.9
HTL = 2.3

WVE ENGINEERING ASSOCIATES
1011 HARRISON AVENUE
NORTHAMPTON, MA.

**CONSTRUCTION DETAIL/
SECTION VIEW OF
PROPOSED BULKHEAD**

APPLICATION BY:
LEXI S. SCOTT
246 8TH AVENUE
FALMOUTH, MASSACHUSETTS

PROPOSED TIMBER PIER, FLOAT,
GANGWAY, ELL, DOLPHIN PILES
AND BULKHEAD

IN: CHILDS RIVER
AT: FALMOUTH, BARNSTABLE CO.,
MASSACHUSETTS

DATE: JAN. 1989 SHEET 4 of 4

APPLICATION FOR DEPARTMENT OF THE ARMY PERMIT
(33 CFR 325)

OMB APPROVAL NO. 0710-0003
Expires June 30, 2000

The Public burden for this collection of information is estimated to average 10 hours per response, although the majority of applications should require 5 hours or less. This includes the time for reviewing instructions, searching existing data sources, gathering and maintaining the data needed, and completing and reviewing the collection of information. Send comments regarding this burden estimate or any other aspect of this collection of information, including suggestions for reducing this burden, to Department of Defense, Washington Headquarters Service Directorate of Information Operations and Reports, 1215 Jefferson Davis Highway, Suite 1204, Arlington, VA 22202-4302; and to the Office of Management and Budget, Paperwork Reduction Project (0710-0003), Washington, DC 20503. Respondents should be aware that notwithstanding any other provision of law, no person shall be subject to any penalty for failing to comply with a collection of information if it does not display a currently valid OMB control number. Please DO NOT RETURN your form to either of those addresses. Completed applications must be submitted to the District Engineer having jurisdiction over the location of the proposed activity.

PRIVACY ACT STATEMENT

Authorities: Rivers and Harbors Act, Section 10, 33 USC 403; Clean Water Act, Section 404, 33 USC 1344; Marine Protection, Research and Sanctuaries Act, 33 USC 1413, Section 103. Principal Purpose: Information provided on this form will be used in evaluating the application for a permit. Routine Uses: This information may be shared with the Department of Justice and other federal, state, and local government agencies. Submission of requested information is voluntary, however, if information is not provided the permit application cannot be evaluated nor can a permit be issued. One set of original drawings or good reproducible copies which show the location and character of the proposed activity must be attached to this application (see sample drawings and instructions) and be submitted to the District Engineer having jurisdiction over the location of the proposed activity. An application that is not completed in full will be returned.

(ITEMS 1 THRU 4 TO BE FILLED BY THE CORPS)

1. APPLICATION NO.	2. FIELD OFFICE CODE	3. DATE RECEIVED	4. DATE APPLICATION COMPLETED
--------------------	----------------------	------------------	-------------------------------

(ITEMS BELOW TO BE FILLED BY APPLICANT)

5. APPLICANT'S NAME	8. AUTHORIZED AGENT'S NAME AND TITLE (an agent is not required)
6. APPLICANT'S ADDRESS	9. AGENT'S ADDRESS
7. APPLICANT'S PHONE NOS. W/AREA CODE	10. AGENT'S PHONE NOS. W/AREA CODE
a. Residence	a. Residence
b. Business	b. Business

11. STATEMENT OF AUTHORIZATION

I hereby authorize, _____ to act in my behalf as my agent in the processing of this application and to furnish, upon request, supplemental information in support of this permit application.

APPLICANT'S SIGNATURE

DATE

NAME, LOCATION AND DESCRIPTION OF PROJECT OR ACTIVITY

12. PROJECT NAME OR TITLE (see instructions)	
13. NAME OF WATERBODY, IF KNOWN (if applicable)	14. PROJECT STREET ADDRESS (if applicable)
15. LOCATION OF PROJECT	
_____ COUNTY _____ STATE	

16. OTHER LOCATION DESCRIPTIONS, IF KNOWN, (see instructions)

17. DIRECTIONS TO THE SITE

18. Nature of Activity *(Description of project, include all features)*

19. Project Purpose *(Describe the reason or purpose of the project, see instructions)*

USE BLOCKS 20-22 IF DREDGED AND/OR FILL MATERIAL IS TO BE DISCHARGED

20. Reason(s) for Discharge

21. Type(s) of Material Being Discharged and the Amount of Each Type in Cubic Yards

22. Surface Area in Acres of Wetlands or Other Waters Filled *(see instructions)*

23. Is Any Portion of the Work Already Complete? Yes No IF YES, DESCRIBE THE COMPLETED WORK

24. Addresses of Adjoining Property Owners, Lessees, Etc., Whose Property Adjoins the Waterbody (If more than can be entered here, please attach a supplemental list).

25. List of Other Certifications or Approvals/Denials Received from other Federal, State or Local Agencies for Work Described in This Application.

AGENCY	TYPE APPROVAL *	IDENTIFICATION NUMBER	DATE APPLIED	DATE APPROVED	DATE DENIED
--------	-----------------	-----------------------	--------------	---------------	-------------

* Would include but is not restricted to zoning, building and flood plain permits

26. Application is hereby made for a permit or permits to authorize the work described in this application. I certify that the information in this application is complete and accurate. I further certify that I possess the authority to undertake the work described herein or am acting as the duly authorized agent of the applicant.

SIGNATURE OF APPLICANT

DATE

SIGNATURE OF AGENT

DATE

The application must be signed by the person who desires to undertake the proposed activity (applicant) or it may be signed by a duly authorized agent if the statement in block 11 has been filled out and signed.

18 U.S.C. Section 1001 provides that: Whoever, in any manner within the jurisdiction of any department or agency of the United States knowingly and willfully falsifies, conceals, or covers up any trick, scheme, or disguises a material fact or makes any false, fictitious or fraudulent statements or representations or makes or uses any false writing or document knowing same to contain any false, fictitious or fraudulent statements or entry, shall be fined not more than \$10,000 or imprisoned not more than five years or both.

Additional Guidance for Section 404 Permit Applicants

Wetland Delineation

Applicants should contact the Corps early in the project planning stage for delineation requirements. It is often beneficial to work your local, state, and federal permit applications concurrently to avoid duplication of effort and time delays. The Corps does not require final design information. The applicant or the applicant's consultant should check with Corps if any of the procedures described are not understood from pre-application meetings.

- Prepare a surveyed site plan of property with existing contours.
- Stake out a field delineation of waters and wetlands subject to Corps jurisdiction as defined in Corps permit regulations published in the November 13, 1986 Federal Register and the criteria identified in the current accepted Corps Manual for identifying and delineating jurisdictional wetlands.
- Plot the limits of these waters and wetlands on surveyed site plan.
- Have Corps staff field check these jurisdictional limits as necessary.
- On the site plan, which now shows the limits of waters and wetlands, draw the footprint of the entire project. Include buildings, roadways, parking areas etc., and limits of all fill to be placed in waters and wetlands.
- New England District Wetland Delineation Data sheets should be submitted to support the limits of wetlands.

Values Assessment

During the field delineation, the applicant should gather preliminary data to support an estimate of the functions and values of the waters and wetlands which are likely to be impacted by the project. Primary functions and values for wetlands are:

- Groundwater recharge/discharge
- Flood flow alteration
- Fish and shellfish habitat
- Sediment/toxicant retention
- Nutrient removal
- Production export
- Sediment and shoreline stabilization
- Wildlife habitat
- Recreation
- Educational scientific value
- Uniqueness/heritage
- Visual Quality/Aesthetics
- Endangered species

For each affected wetland, an evaluation should be prepared addressing at least these wetland functions and values. Others may be included based on professional judgement. Several protocols for estimating wetlands functions have been published and are in use. However, the New England Division requires a descriptive approach where the applicant determines the functions and values provided by each wetland. In consultation with the Corps and the resource agencies, the applicant determines the principal functions and values of the wetland and describes the rationale behind that decision. Corps confidence in the valuation is based upon the strength and accuracy of the supporting information.

This descriptive approach is described in the New England Division's Highway Methodology Supplement Workbook entitled, "Wetland Functions and Values, A Descriptive Approach". Using this information, the Corps will estimate the potential for individual and cumulative impacts to each wetland function and value.

For projects where mitigation is proposed or likely, the applicant should refer to the New England District's Mitigation Checklist. This checklist will guide the applicant and consultants in developing complete mitigation plans. The requirements for clarity are similar to those for project plans. However, there are additional details that are specific to mitigation which must be added.

Alternatives Analysis

The Corps must determine the "basic project purpose" after which the applicant must analyze practicable alternatives to avoid filling waters and wetlands. For individual permits, subject to public notice, the Corps uses a sequential approach of first analyzing off site alternatives. Second, we look at on-site project modification to avoid and minimize wetland impacts. Third, we consider compensatory mitigation to replace the functions and values of wetlands unavoidably impacted. In this way the Corps follows the following sequencing to minimize impacts to wetlands: avoid, minimize, compensate.

Note that for non-water dependent projects, there is a presumption in the 404(b)(1) guidelines that practicable alternatives are available that do not involve filling wetlands and other special aquatic sites. Unless the applicant can rebut this presumption, a permit for non-water dependant fills cannot be issued. Project modification to avoid unnecessary wetland filling may result in reduced wetland

impacts. These modifications may qualify the project for a general permit, in which case permit review is expedited.

If an Individual Permit is required including a public notice, permit application drawings should show the limits of waters, wetlands, fill, and the footprint of all project elements in a clear schematic fashion. These application

drawings must be 8 1/2 x 11 inches in size and be clearly reproducible. Reductions of the engineering drawings are usually not acceptable as they become cluttered and unreadable when reduced. However, tracing some of the information from the engineering drawings and then reducing usually works well.

Available Resource Information:

Corps of Engineers Permit Regulations 33 CFR 320-330 Federal Register, Nov. 13, 1986

Superintendent of Documents
U.S. Government Printing Office
Washington, D.C. 20402

Guidelines for Specifications of Disposal Sites for Dredged or Fill Material 40 CFR 230 - Federal Register, Dec. 24, 1980

Superintendent of Documents
U.S. Government Printing Office
Washington, D.C. 20402

Current accepted Corps Manual for Identifying and Delineating Jurisdictional Wetlands

Superintendent of Documents
U.S. Government Printing Office
Washington, D.C. 20402
(202) 783-3283

As of this printing, the government document is: ADA 176-734

Wetland Plant Lists

Porter B. Reed, Jr.
U.S. Fish & Wildlife Service
National Wetlands Inventory
9720 Executive Center Drive
Suite 101, Monroe Building St.
Petersburg, FL 33702

National List of Scientific Plant Names

USDA Soil Conservation Service
Office of Ecological Sciences
P.O. Box 2890
Washington, D.C. 20013
(202) 447-2587
Publ. No. SCS-TP-159 (1982)

Hydric Soils of New England

UMass Cooperative Extension
Bulletin Center/Cottage A
Thatcher Way
University of Massachusetts
Amherst, MA 01003

Hydric Soils List

National Technical Committee for Hydric Soils
National Research Conservation Service
Rm. 152, Federal Building
100 Centennial Mall North
Lincoln, NE 68508-3866
Mail Stop 33
(402)437-5423

Keys to Soil Taxonomy

International Soils
Pocahontus Press
P.O. Drawer F
Blacksburg, VA 24063-1020

Aerial Photography - List of Sources

USGS National Cartographic Information Center
507 National Center
Reston, VA 22092
(703)860-6045

Aerial Photography - Photo Sources

Consolidated Farm Service Agency
Aerial Photo Field Office
Sioux Falls, SD 57198
(605)594-6151

Aerial Photography - Photo Sources

USCA EROS Data Center
P.O. Box 30010
Salt Lake City, UT 84130
(801) 524-5856

National Wetland Inventory Map Distribution Outlets:

CT: Ken Metzler
Department of Environmental Protection
Natural Resource Center
165 Capital Ave., Room 553
Hartford, CT 06106
(203) 424-3540

MA: Dennis Swartwout
Cartographic Information Center
102-D Hasbrouck Lab
University of Massachusetts
Amherst, MA 01003
(413)545-0359

ME: Chris Palmer
ME Geological Survey
State House Station 22
Augusta, ME 04333
(207) 287-2801

NH: James McLaughlin
Office of State Planning
State of New Hampshire
2 1/2 Beacon Street
Concord, NH 03301
(603) 271-2155

RI: Department of Environmental Management
Freshwater Wetlands Section
291 Promenade Street
Providence, RI 02908
(401) 277-6820

VT: Carl Pagel
Vermont Department of Water Resources
Waterbury, VT 05602
(802) 244-6951

For other states call: 1-800-872-6277 (there may be costs for maps, printed documents and shipping and handling.)