

CECW-ED Engineer Manual 1110-2-4300	Department of the Army U.S. Army Corps of Engineers Washington, DC 20314-1000	EM 1110-2-4300 15 September 1980 (original) 30 November 1987 (change 1)
	Engineering and Design INSTRUMENTATION FOR CONCRETE STRUCTURES	
	Distribution Restriction Statement Approved for public release; distribution is unlimited.	

ENGINEERING AND DESIGN

INSTRUMENTATION
FOR
CONCRETE STRUCTURES



DEPARTMENT OF THE ARMY
CORPS OF ENGINEERS
OFFICE OF THE CHIEF OF ENGINEERS

CEEC-ED

DEPARTMENT OF THE ARMY
US Army Corps of Engineers
Washington, D.C. 20314-1000

EM 1110-2-4300
Change 1

Engineer Manual
No. 1110-2-4300

30 November 1987

Engineering and Design
INSTRUMENTATION FOR CONCRETE STRUCTURES

1. This change to EM 1110-2-4300, 15 September 1980, provides information on additional types of instruments for measuring tilt of structures. This change also provides information on instrumentation automation techniques.

2. Insert the attached pages as shown below:

Remove old pages

iii and iv
4-19 thru 4-33
8-1 thru 8-4
None
A-1 thru A-3
None

Insert new pages

iii thru vi
4-19 thru 4-55
8-1 thru 8-3
9-1 thru 9-48
A-1 thru A-4
D-1 thru D-13

3. File this change sheet in front of the publication for reference purposes.

FOR THE COMMANDER:

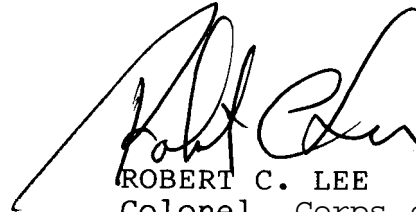

ROBERT C. LEE
Colonel, Corps of Engineers
Chief of Staff

Engineer Manual
No. 1110-2-4300

15 September 1980

Engineering and Design
INSTRUMENTATION FOR CONCRETE STRUCTURES

1. Purpose. The purpose of this manual is to provide guidance and information related to the instrumentation of concrete structures and the measurement of structural behavior.
2. Applicability. This manual applies to all field operating activities having responsibility for the design of Civil Works projects.
3. General. The discussion of the principles, applications, and equipment in this manual is intended to assist in designing, installing, operating and utilizing data from instrumentation systems installed on large concrete structures to monitor structural behavior and to serve field operations or those operating as contracting officers representatives.

FOR THE CHIEF OF ENGINEERS:

FORREST T. GAY, III
Colonel, Corps-of Engineers
Executive Director, Engineer Staff

DEPARTMENT OF THE ARMY
Office of the Chief of Engineers
Washington, DC 20314

Engineering and Design
INSTRUMENTATION FOR CONCRETE STRUCTURES

TABLE OF CONTENTS

<u>Paragraph</u>		<u>Page</u>
CHAPTER 1 - INTRODUCTION		
1-1	Purpose and Scope	1-1
1-2	Applicability	1-1
1-3	References	1-1
1-4	Program Planning and Execution	1-2
1-5	Contract Work	1-3
1-6	Types of Instruments	1-4
1-7	Instrument Uses	1-5
1-8	Collection of Complementary Data	1-5
1-9	Comments	1-9
CHAPTER 2 - TRANSDUCERS		
SECTION 1	Carlson Type Transducers	2-1
2-1	Description of the Instruments	2-1
2-2	Strain Meter	2-1
2-3	Miniature Strain Meter	2-2
2-4	Joint Meter	2-4
2-5	Stress Meter for Concrete	2-5
2-6	Pore Pressure Cell	2-7
2-7	The Reinforced Concrete Meter	2-9
2-8	Resistance Thermometer	2-10
2-9	Source	2-11
2-10	Instrument Preparation	2-11
2-11	Waterproofing Treatment	2-15
2-12	Cable Leads	2-15
2-13	Calibration Corrections	2-16
2-14	Correction Factors	2-18
2-15	Resistance Thermometer Calibration	2-19
2-16	Final Calibration Adjustments	2-19
2-17	Instrument Installation	2-20
2-18	Embedment Techniques	2-21

15 Sep 80

Paragraph		Page
SECTION II	Terminal Facilities and Reading Instruments	2-22
2-19	Design of Terminal Recesses	2-22
2-20	Terminal Equipment	2-23
2-21	Installing Cable Leads	2-27
2-22	Installing Terminal Equipment	2-31
2-23	Reading Equipment	2-33
SECTION III	Data Collection and Reduction	2-35
2-24	Collection of Data	2-35
2-25	Reading Schedules	2-36
2-26	Field Reduction of Data	2-39
SECTION IV	Other Stress-Strain Type Transducers	2-41
2-27	General	2-41
2-28	Strain Measuring Instruments	2-41
2-29	Linear Variable Differential Transformers	2-48
2-30	Resistance Strain Gage	2-50
2-31	Stress Measuring Instruments	2-50
Plates 2-1 through 2-10		2-54

CHAPTER 3 - UPLIFT AND LEAKAGE

SECTION I	Uplift	3-1
3-1	Purpose	3-1
3-2	Description	3-1
3-3	Installation	3-2
3-4	Collection of Data	3-5
3-5	Reading Schedules	3-7
SECTION II	Leakage	3-8
3-6	General	3-8
3-7	Vee-Notch Weir	3-8
3-8	Critical Depth Meter	3-10
SECTION III	Supplemental Instruments	3-11
3-9	General	3-11
3-10	Water Level Indicator	3-11
3-11	Vibrating Wire Piezometer	3-12
3-12	Strain Gaged Diaphragm Pressure Gage	3-13
3-13	WES Pressure Measuring Telemetry System	3-13
3-14	Hydraulic Pore Water Pressure Cell	3-15
3-15	WES Hydrostatic Pressure Cell	3-17
Plates 3-1 through 3-4		3-19

<u>Paragraph</u>		<u>Page</u>
CHAPTER 4 - PLUMBING INSTRUMENTS AND TILT MEASURING DEVICES		
4-1	General	4-1
4-2	Description	4-1
4-3	Installation Procedures	4-4
4-4	Maintenance and Care of Equipment	4-10
4-5	Collection of Data	4-11
4-6	Processing of Data	4-14
4-7	Inverted Plumb Line	4-14
4-8	Optical Plummet	4-17
4-9	Tilt Measuring Instruments	4-19
4-10	Instruments that Measure Tilt Through a Structure	4-19
4-11	Instruments that Measure Surface Tilt	4-31
4-12	Terzaghi Water Level Meter	4-41
Plates	4-1 through 4-5 (Sheet 3 of 3)	4-44
CHAPTER 5 - CRACK AND JOINT MEASURING DEVICES		
5-1	Purpose	5-1
5-2	Description of the Instruments	5-1
5-3	Instrument Details and Characteristics	5-1
5-4	Instrument Installation	5-9
5-5	Collection of Data	5-13
5-6	Reading Schedules	5-14
Plates	5-1 through 5-8	5-15
CHAPTER 6 PRECISE MEASUREMENT SYSTEMS		
SECTION I	Types of Measurement	6-1
6-1	Purpose	6-1
6-2	Types of Measurement	6-1
SECTION II	Precise Alignment Instruments	6-4
6-3	Laser Alignment Instruments	6-4
6-4	Instrument Installation	6-5
6-5	Data Collection	6-7
6-6	Data Reduction	6-7
6-7	Theodolite Alignment Instruments	6-8
6-8	Instrument Installation	6-11
6-9	Data Collection	6-15
6-10	Data Reduction	6-16
6-11	Precise Leveling	6-17
6-12	Data Collection	6-18
6-13	Data Reduction	6-18

EM 1110-2-4300
 Change 1
 30 Nov 87

<u>Paragraph</u>	<u>Page</u>
SECTION III Precise Distance Measuring Instruments	6-19
6-14 Electronic Distance Measurement (EDM) Instruments	6-19
6-15 Instrument Installation	6-20
6-16 Data Collection	6-20
6-17 Data Reduction	6-21
SECTION IV Triangulation and Trilateration	6-22
6-18 Triangulation	6-22
6-19 Instrument Installation	6-23
6-20 Data Collection	6-23
6-21 Data Reduction	6-24
6-22 Trilateration	6-24
6-23 Description of the Instrument	6-26
6-24 Data Collection	6-27
6-25 Data Reduction	6-28
Plates 6-1 through 6-3	6-29
CHAPTER 7 - TEMPERATURE MEASUREMENT	
7-1 General	7-1
7-2 Temperature Measuring Devices	7-1
7-3 Installation	7-2
7-4 Collection of Data	7-2
7-5 Processing of Data	7-3
CHAPTER 8 - SEISMIC INSTRUMENTATION	
8-1 Introduction	8-1
8-2 Description	8-1
8-3 Design Considerations	8-2
8-4 Hydrodynamic Pressure Measurement Considerations	8-2
8-5 Installation and Maintenance	8-3
8-6 Processing of Data	8-3
CHAPTER 9 - INSTRUMENTATION AUTOMATION TECHNIQUES	
SECTION I Introduction	9-1
9-1 Introduction	9-1
9-2 Scope	9-1
SECTION II System Requirements	9-2
9-3 Defining the Objectives	9-2
9-4 Functional Requirements	9-2
9-5 Environmental Requirement	9-6

*

*	<u>Paragraph</u>	<u>Page</u>
	SECTION III System Design	9-7
	9-6 System Considerations	9-7
	9-7 Automated Measurement Techniques	9-7
	9-8 Component Compatibility	9-8
	9-9 Instrument/System Characteristics	9-8
	9-10 Interfacing Techniques	9-9
	9-11 Power Sources	9-9
	9-12 Grounding Techniques and Lightning Protection	9-10
	9-13 Maintainability	9-10
	9-14 Operability	9-11
	9-15 System Calibration	9-11
	9-16 System Flexibility	9-12
	9-17 Economic Factors	9-12
	SECTION IV Sensor Selection Criteria	9-13
	9-18 Sensor Selection Criteria	9-13
	9-19 Economic Factors	9-13
	9-20 Sensor Hazards	9-13
	SECTION V Signal Conditioning	9-15
	9-21 Introduction	9-15
	9-22 Bridge Circuits	9-16
	9-23 Amplification	9-17
	9-24 Instrumentation Amplifier	9-17
	9-25 Isolation Amplifiers	9-18
	9-26 Filtering	9-19
	9-27 Signal Conversion	9-20
	9-28 Electrical Interferences	9-22
	SECTION VI Data Transmission	9-24
	9-29 Types of Data Transmission	9-24
	9-30 Multiplexing	9-24
	9-31 Network Configurations	9-25
	9-32 Transmission Techniques	9-27
	9-33 Transfer Rate(resolution and accuracy)	9-27
	SECTION VII Data Processing, Display, and Recording	9-28
	9-34 Complexity	9-28
	9-35 Data Processing	9-28
	9-36 Display	9-29
	9-37 Recording/Storage	9-29
	SECTION VIII System Design Document and Design Review	9-30
	9-38 System Development	9-30
	9-39 Guidelines for Preparation of a System Design Document	9-30
	9-40 Guidelines for Conducting a Design Review	9-31

*

EM 1110-2-4300
 Change 1
 30 Nov 87

Paragraph		Page		
*	SECTION IX	System Implementation	9-32	
	9-41	Detailed Design	9-32	
	9-42	Procurement and Receiving Inspection	9-32	
	9-43	Acceptance Tests	9-33	
	9-44	Metrology Controls	9-34	
	9-45	System Fabrication	9-34	
	9-46	System Integration	9-35	
	9-47	System Installation	9-35	
	9-48	Documentation	9-37	
	SECTION X	Maintenance	9-37	
	9-49	Maintenance Philosophy	9-37	
	9-50	Preventive Maintenance	9-38	
	9-51	Calibration	9-39	
	9-52	Documentation	9-40	
	9-53	Maintenance Software (diagnostic)	9-41	
	9-54	Spare Parts	9-42	
	9-55	Test Equipment	9-42	
	9-56	Training	9-43	
	SECTION XI	Retrofitting	9-44	
	9-57	Definition	9-44	
	9-58	Need	9-44	
	9-59	Degrees of Retrofit	9-45	
	9-60	Retrofitting Analysis	9-46	
	9-61	Necessary Components	9-46	*
	APPENDIX A	SELECTED BIBLIOGRAPHY	A-1	
	APPENDIX B	SPLICING TECHNIQUE	B-1	
	APPENDIX C	EMBEDMENT TECHNIQUES FOR CARLSON TYPE TRANSDUCER INSTRUMENTS	C-1	
*	APPENDIX D	SAMPLE FORM OF SYSTEMS REQUIREMENT DOCUMENT	D-1	*

CHAPTER 1

INTRODUCTION

1-1. Purpose and Scope. This manual is issued as a guide for use by individuals and organizations in the Corps of Engineers engaged in the planning of instrumentation programs and in the preparation, installation, and collection of data from instruments and devices for measurement of structural behavior installed on or embedded within concrete gravity prototype structures for civil works projects. The manual describes new techniques which have evolved from recent technological advances in electronic instrumentation as well as methods which have been developed over a long period of time for the preparation, fabrication, protection, and installation of instruments and the collection of data therefrom. Efforts to improve the techniques will be continued, based on field experience and laboratory investigations, and the manual updated when appropriate. Instruments described include those installed for the measurement of strain, stress, joint movement, pore pressure, interior concrete temperature, uplift pressure, leakage, structural deflection, head loss, and distance measurement.

1-2. Applicability. The provisions of this manual are applicable to all field operating activities having Civil Works design responsibilities.

1-3. References.

a. Other Engineer Manuals. Portions of the following manuals relate to aspects of structural design and behavior to which the instruments and devices described herein relate.

EM 1110-2-1802	Subsurface Investigations - Geophysical Explorations
EM 1110-2-1908, parts 1 and 2	Instrumentation of Earth and Rock-Fill Dams
EM 1110-2-2000	Standard Practice for Concrete
EM 1110-2-2200	Gravity Dam Design
EM 1110-2-2300	Earth and Rock-Fill Dams General Design and Construction Considerations
EM 1110-2-2501	Wall Design (Floodwalls)
ER 1110-2-100	Periodic Inspection and Continuing Evaluation of Completed Civil Works Structures
ER 1110-2-103	Strong Motion Instruments for Recording Earthquake Motions on Dams
ER 1110-2-1802	Reporting Earthquake Effects
ER 1110-2-1150	Post Authorization Studies

b. Other Technical Publications. Appendix A consists of a selected bibliography of literature pertaining to instruments for and measurement of structural behavior of prototype concrete gravity structures.

1-4. Program Planning and Execution.

a. Responsibility. Structural behavior instrumentation programs may be proposed by a field agency when necessary to measure the structural integrity of a concrete structure or when an opportunity exists to obtain data which will add to basic knowledge, check design assumptions or aid in the solution of incompletely solved problems. When a program is considered desirable, a recommendation should be forwarded to the Chief of Engineers through channels indicating the scope and objective of the proposed program, estimated cost, and justification. The Chief of Engineers may also direct that such a program be initiated by a field agency when a need exists. Planning structural behavior investigation programs for concrete structures, development of guides for the installation and observation of instruments, and assembling, processing, and dissemination of collected data are responsibilities of the Engineering Divisions in the U.S. Army Engineer Districts. Installation of the instruments and collection of data during construction in accordance with prescribed procedures are the responsibilities of the Construction Divisions in the Districts. Collection of data from the instruments after construction is the responsibility of the Operations Divisions. Coordination, review, approval, and termination of such programs are functions of the Chief of Engineers.

b. Guide to Critical Readings. Threshold limits will be established for each safety-related instrument in the structural behavior program. These critical values (usually maxima) should directly reflect design criteria, be derived from design data, or represent engineering judgment and experience. Quantitative limit values will be developed prior to completion of construction, and may be subsequently modified as the performance history of the structure is established.

c. Disposition of Results. Preparation of graphical history plots, schematic diagrams, or tabulations based on the processed data is required for all approved Structural Behavior Instrumentation installations. Results shall be available for examination during the scheduled periodic inspections, and where appropriate, summaries included as a part of the formal periodic inspection reports.

1-5. Contract Work.

a. General. The general policy of the Chief of Engineers is to perform all civil works by contract unless it is in the best interest of the United States to accomplish the work by Government forces. However, the specialized nature of instrumentation facilities and the care required in the preparation, calibration, and placement of test apparatus demands that these features of work be retained under close operational control of the Corps of Engineers. In view of these conditions, direct procurement by the Government of embedded meters, cable, tubing, test sets, microscopes, slide micrometers, scales, indicating or recording equipment, and similar items not normally encountered in construction work, and the utilization of Government personnel to accomplish certain phases of the fabrication and installation work, such as embedment of instruments and splicing of cables, is recommended.

b. Work Performed by Contractor. Work which may be accomplished by the construction contractor should be limited to the following types:

(1) Furnish and install embedded conduit and supports for cable leads.

(2) Furnish and install the basic terminal reading station facilities, including cabinet, panel board, terminal strips, and power or lighting outlets therein.

(3) Make cable connections at reading stations.

(4) Furnish and install uplift cell collector boxes, piping, and all reading station facilities associated with uplift cells.

(5) Furnish and install pipe shafts for deflection plumb lines.

(6) Construct reference monuments in connection with precise alignment facilities.

(7) Furnish unskilled labor required during the embedment of instruments and cable leads.

c. Plans and Specifications. Project plans should show the complete instrument layout, supplemented by detail drawings covering the size and location of cable conduit, terminal reading stations, panel boards, terminal strips, uplift cell collector boxes, uplift piping, deflection plumb line shafts, and reference monuments.

15 Sep 80

The project specifications should include a separate technical section setting forth workmanship, materials,, codes, and standard practices, and similar installation requirements pertaining to items of work for which the contractor will be responsible in connection with the instrumentation facilities. Government-furnished equipment should also be listed.

d. Measurement and Payment. Establishment of units of measurement for instrumentation facilities is generally not feasible, and payment should be made by lump sum. A single lump sum payment item covering all features of the structural instrumentation installation is recommended for facilities of normal size and scope. For minor programs the work performed by the contractor frequently may be included under one of the larger concrete items, and no separate payment made.

1-6. Types of Instruments.

a. Relationship to Measurement of Safety Conditions. The instruments described herein can be grouped into two main categories; those that directly measure conditions that relate to safety and those that indirectly measure conditions related to the safety of the structure. A further category describes instruments that could be grouped into either one of the two main categories.

b. Safety Related Instruments. Instruments that measure overall movement, or phenomena that cause overall movement of the structure can be grouped into the category of direct measurement of safety conditions. Plumbing, alignment, and uplift pressure measuring instruments are in this category. Seismic instruments measure the intensity and characteristics of an earthquake as it is happening and therefore do not warn of unsafe conditions before the fact. They can, however, tell the conditions and forces experienced by the structure during the earthquake which may be of importance in determining whether the structure is unsafe after the shock.

c. Instruments Indirectly Related to Safety. Instruments that measure quantities such as stress and strain, length change, pore pressure, leakage, and temperature change are not directly related to safety determination. They generally measure standard conditions of the structure which if they become extreme or unusual will indicate conditions related to structure safety. Certain types of these instruments fall in a category between the above mentioned two, that is they sometimes measure structural safety conditions directly and at other times indirectly. For example, crack and joint measuring instrumentation normally measure expansion and contraction of joints which are an expected movement, however, if these instruments are installed over a crack that has developed unexpectedly, then they are primarily being used to monitor structural movement related to safety.

1-7. Instrument Uses. The instruments described in this manual serve a variety of jobs, and for that reason, grouping them as to the jobs they perform is also a helpful categorization. Table 1-1 is intended to be used as a quick reference to indicate what instruments perform what functions.

1-8. Collection of Complementary Data.

a. Related Data. The collection of related and supporting data pertaining to structural behavior is an integral part of the instrumentation program, and should proceed concurrently with the readings of the embedded instruments. Types of information required to support or clarify the instrument observation results include:

(1) Construction Progress. Schematic concrete placing diagram showing lift placement dates, concrete placing temperatures, and lift thicknesses.

(2) Concrete Mixes. Cement contents, water-cement ratios, and typical combined aggregate gradings for interior and exterior mixes, typical fine aggregate gradings, before and after mixing, and amount of entrained air, admixtures used, and how introduced.

(3) Cement. Type, source, or sources, physical and chemical properties, including heat of hydration.

(4) Aggregates. Types, geologic classification, petrographic description, source or sources, and chemical and physical properties.

(5) Curing and Insulation. Type and method of curing; type, location, and duration of insulating protection.

(6) Temperatures. Daily maximum and minimum air temperatures.

(7) Pool Elevations. Daily reservoir and tailwater elevations.

(8) Concrete Properties. Specific heat, conductivity, diffusivity, thermal coefficient of expansion, dynamic and static modulus of elasticity, creep, compressive, flexural, and tensile strength.

(9) Temperature Control Procedures. Location, size, and arrangement of embedded cooling pipes, cooling water temperatures, pumping rates, and sequence or history of cooling operations; extent and method of precooling concrete mixes.

(10) Foundation Conditions. Final rock elevations, unusual geologic features.

TABLE 1-1

INSTRUMENT USE INDEX
(Prepared by CE)

		<u>Location</u>
STRAIN AND DEFLECTION MEASUREMENT		
Strain Measurement - Internal Gages		
Strain Meter	(Linear Measurement)	Chapter 2
Miniature Strain Meter	(Linear Measurement)	Chapter 2
Embedable Strain Gage	(Linear Measurement)	Chapter 2
Vibrating Wire Strain Gage	(Linear Measurement)	Chapter 2
Electrical Resistance Strain Gage	(Linear Measurement)	Chapter 2
Reinforced Concrete Meter	(Linear Measurement)	Chapter 2
Strain Measurement - External Gages		
Whittemore Mechanical Strain Gage	(1 or 2 Dimensional)	Chapter 2
Mechanical Scratch Gage	(Linear Measurement)	Chapter 2
Vibrating Wire Strain Gage	(Linear Measurement)	Chapter 2
Monfore Standardizing Strain Gage	(Linear Measurement)	Chapter 2
Linear Variable Differential Transducer	(Linear Measurement)	Chapter 2
Electrical Resistance Strain Gage	(Linear Measurement)	Chapter 2
EXPANSION AND CONTRACTION MEASUREMENT		
Crack or Joint Movement - Internal Gages		
Joint Meter	(Linear Measurement)	Chapters 2 and 5
Multiple Position Borehole Extensometer	(Linear Measurement)	Chapter 5
Crack or Joint Movement - External Gages		
Relative Movement Indicator	(3 Dimensional Measurement)	Chapter 5
Monolith Joint Displacement Indicator	(3 Dimensional Measurement)	Chapter 5
Ball-N-Box Gage	(3 Dimensional Measurement)	Chapter 5
Multiposition Strain Gage	(2 Dimensional Measurement)	Chapter 5
"L" Shaped Gage	(2 Dimensional + Rotation)	Chapter 5
Dial Gage	(Linear Measurement)	Chapter 5
Mechanical Scratch Gage	(Linear Measurement)	Chapters 2 and 5
Portable Crack Measuring Microscope	(Linear Measurement)	Chapter 5

TABLE 1-1 (Continued)

		<u>Location</u>
STRESS AND PRESSURE MEASUREMENT		
Stress Measurement		
Stress Meter	(Concrete Stress Measurement)	Chapter 2
Vibrating Wire Stress Meter	(Concrete Stress Measurement)	Chapter 2
Pressure Measurement		
WES Pressure Gage	(Hydrostatic Pressure Measurement)	Chapter 2
Gloetzel Pressure Cell	(Hydrostatic Pressure Measurement)	Chapter 2
WES Pressure Measuring Telemetry System	(Hydrostatic Pressure Measurement)	Chapter 3
WES Hydrostatic Pressure Cell	(Hydrostatic Pressure Measurement)	Chapter 3
Vibrating Wire Piezometer	(Hydrostatic Pressure Measurement)	Chapter 3
Hydrostatic Pore Water Pressure Cell	(Hydrostatic Pressure Measurement)	Chapter 3
Hydrodynamic Pressure Gage	(Hydrodynamic Pressure Measurement)	Chapter 8
Uplift Pressure Measurement		
Standpipe Uplift Cell	(Hydraulic Pressure Head Measurement)	Chapter 3
Diaphragm Uplift Cell	(Hydraulic Pressure Head Measurement)	Chapter 3
Water Level Indicator	(Used in Conjunction with Standpipe Uplift Cell)	Chapter 3
HYDRAULIC LEAKAGE MEASUREMENT		
Vee-Notch Weir	(Flow Measurement)	Chapter 3
Critical Depth Meter	(Flow Measurement)	Chapter 3
BENDING, TILTING, AND DEFLECTION MEASUREMENT		
Plumbness Measurement		
Plumb Lines		Chapter 4
Inverted Plumb Lines		Chapter 4
Optical Plummets	(Optical Measurement)	Chapter 4
Levelness Measurement		
Electrolevel	(Spint Level Measurement)	Chapter 4
Terzaghi Water Level Meter	(Water Level Measurement)	Chapter 4
Precise Leveling	(Settlement Measurement)	Chapter 6

1-7

TABLE 1-1 (Concluded)

	<u>Location</u>
PRECISE ALIGNMENT MEASUREMENT	
Alignment	
Laser Alignment Measurement	Chapter 6
Theodolite Alignment Measurement	Chapter 6
Triangulation	Chapter 6
Trilateration	Chapter 6
Settlement	
Precise Leveling	Chapter 6
Distance Measuring	
Electronic Distance Measurement	Chapter 6
SEISMIC MEASUREMENT	
Time History Measurement	
Strong Motion Accelerometers	Chapter 8
Peak Reading Accelerometers	Chapter 8
Hydrodynamic Pressure Gages	Chapter 8
Magnitude Measuring Device	
Seismoscope	Chapter 8
	(No time History)
TEMPERATURE MEASUREMENT	
Resistance Thermometer	Chapters 2 and 7
Thermocouple	Chapter 7

1-8

EM 1110-2-4300
15 Sep 80

b. Time of Collection. Much of the preceding listed information will usually be available from investigations carried out prior to and during the project design stage or will be obtained under usual construction control operations. A special supporting laboratory program for the determination of those concrete properties required in the analysis of results may be necessary for the larger or more important instrumentation installations.

c. Periodic Observation. Observers should be alert to detect cracks or similar evidences of structural distress which may develop, and record time of occurrence, initial size and extent, subsequent changes in size and extent, and any corrective action taken.

1-9. Comments. It is requested that comments concerning the instruments contained in this manual, or ones that should be included in the next change, be furnished to the Department of the Army, Waterways Experiment Station, Corps of Engineers, P. O. Box 631, Vicksburg, Mississippi, 39180, ATTN: WESSC, and a copy furnished to HQDA (DAEN-CWE-DC), WASH DC 20314. Two types of comments should be made: (a) Recommendations concerning the format of the manual, and (b) Recommendations for additional information on instruments proposed to be included in the manual.

CHAPTER 2

TRANSDUCERS

Section I. Carlson Type Transducers

2-1. Description of the Instruments. Since the Carlson transducers have been so universally accepted for use in concrete structures, these transducers will be considered separately. The Carlson transducers utilize two different electromechanical principles, namely changes in wire tension cause change in the electrical resistance of the wire, and also changes in the temperature of the wire cause change in its electrical resistance. The strain meter, joint meter, stress meter, pore pressure cell, and the reinforced concrete (R-C) meter utilize both principles to measure deformation and temperature changes. In the resistance thermometer temperature changes are measured by means of resistance changes of copper wire.

2-2. Strain Meter.

a. Operating Principle. The standard Carlson strain meter can be embedded in concrete or attached to a surface with saddle mounts. It measures change in length (strain) and temperature with the help of a simple Wheatstone-bridge test set or the Carlson Test Set. The meter, Figure 2-1, contains two coils of highly elastic steel wire, one of which increases in length and electrical resistance when a strain occurs, while the other decreases. The ratio of the two resistances is independent of temperature (except for thermal expansion) and, therefore, the change in resistance ratio is a measure of strain. The total resistance is independent of strain since one coil increases while the other decreases the same amount due to the change in length of the meter. Therefore, the total resistance is a measure of temperature.

b. Lengths and Features. The standard strain meter is furnished in three different lengths, from 8 to 20 in., but all have identical sensing elements (Table 2-1). The meter has a 1/4-28 SAE tapped hole in the end plug opposite the cable end to permit attachment to a spider for mass concrete embedment, or for adding an extender to increase the length and sensitivity. The body is covered with PVC sleeving to break the bond with the concrete.

c. Temperature Correction. The frame of the meter is all steel, making the temperature correction for thermal expansion of the frame 6.7 microstrains per degree F. This value is nearly the same as the thermal expansion of the concrete making only a small temperature correction necessary due to the change in length of the frame due to temperature change.

CARLSON ELASTIC WIRE STRAIN METER

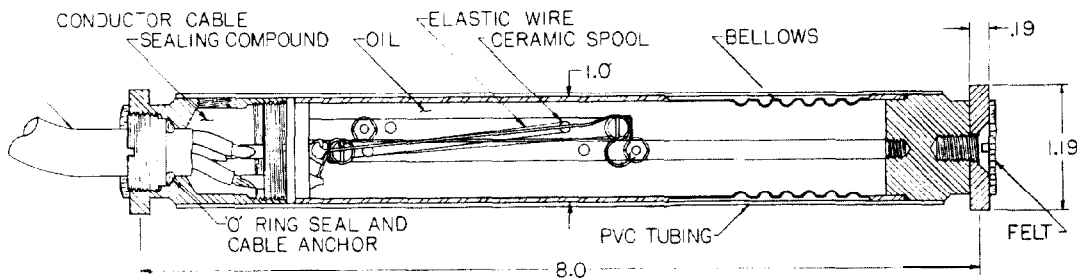

Figure 2-1. Carlson Elastic Wire Strain Meter (Courtesy of Carlson Instruments)

Table 2-1

SPECIFICATIONS - "A" SERIES, CARLSON STRAIN METER

Model Number	A8	A10	A10S ^(b)	A20
Range, micro-strain ^(a)	2600	2100	2100	1050
Least reading, micro-strain, max.	3.6	2.9	2.9	1.5
Least reading, temperature, °F	0.1	0.1	0.1	0.1
Gage length, in.	8	10	10	20
Weight, lb	.8	1.3	1.3	1.8

(a) Normally set at factory for 2/3 range in compression. Within limits, other settings may be specified.

(b) Saddle mount. Mounting diameter is 1-1/16 in.

2-3. Miniature Strain Meter. The miniature meter (Figure 2-2) is for embedment in concrete where small size and economy are essential. The principle of operation is basically the same as the standard strain meter. A feature of the miniature meter is that the basic 4-in. meter can be extended to greater lengths by removing the end flange and adding an extender without disturbing the sensing element, thus increasing its sensitivity (Table 2-2). The body of the meter is covered with PVC tubing to break the-bond to the concrete. The conductor cable for the strain meter is 3 - conductor No. 22 AWG shielded with PVC insulation.

CARLSON MINIATURE STRAIN METER

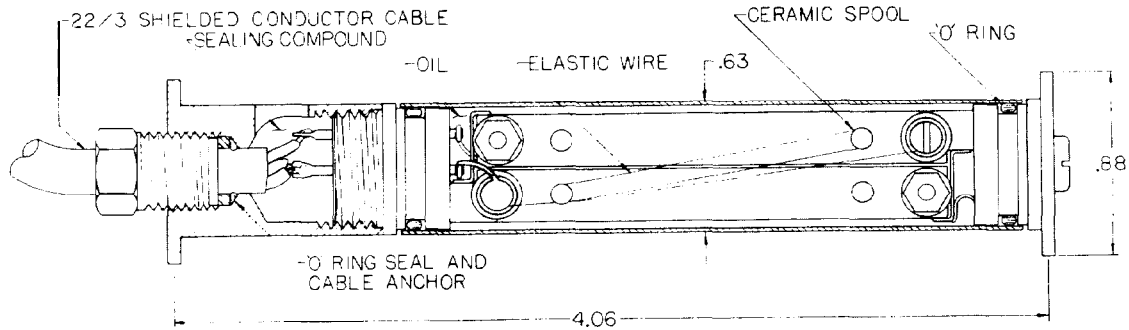

Figure 2-2. Carlson Miniature Strain Meter. (Courtesy of Carlson Instruments)

Table 2-2

SPECIFICATIONS - M SERIES, CARLSON MINIATURE STRAIN METER

Model Number	M4	M8	M10
Range, micro-strain (a)	3900	2000	1600
Least reading, micro-strain	5.8	2.9	2.3
Least reading, temperature, °F	.1	.1	.1
Gage length, in.	4.062	8	10
Weight, lb	.19	.54	.71

(a) Normally set at factory for 2/3 to 3/4 of range in compression. If specified, range may be divided equally between compression and expansion.

2-4. Joint Meter.

a. Operating Principle. The Carlson joint meter, Figure 2-3, is similar to the strain meter except that it has a greater range. This is accomplished by having a coil spring in series with each of two loops of elastic wire. The joint meter is used mainly to measure the opening-of joints, and therefore, it has most of its range in expansion (Table 2-3). It measures temperature as well as expansion or contraction in the same way as the strain meter does.

b. Lengths and Features. The dimensions of the joint meter are about the same as those of the strain meter. A bellows near the center of the length permits movement to be transmitted to the interior wires. The bellows has a bursting pressure of 400 psi, but should normally not be exposed to more than 100 psi hydraulic pressure. Polyolefin heat-shrinkable tubing is placed over the bellows to prevent bonding or jamming by concrete or mud.

c. Installation Sockets. The installation of joint meters is facilitated by embedding a steel socket on one side of the joint, and not inserting the joint meter until just before placing the concrete on the second side. However, the joint meter can be ordered with or without sockets.

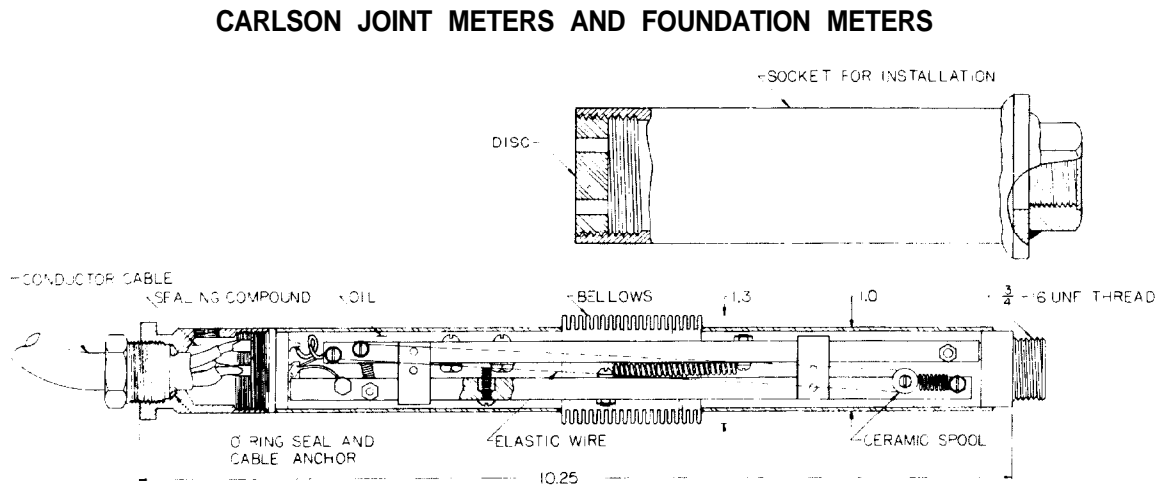

Figure 2-3. Carlson Joint and Foundation Meter. (Courtesy of Carlson Instruments)

Table 2-3
(Courtesy of Carlson Instruments)
SPECIFICATIONS - J & F SERIES,
CARLSON JOINT AND FOUNDATION METERS

Model Number	JO.1 ^(a)	JO.25 ^(a)	JO.5 ^(a)	F0.1 ^(b)	F0.25 ^(b)	F0.5 ^(b)
<u>Range</u>						
Contraction, in.	.02	.01	0.1	.08	.24	0.4
Expansion, in.	.08	.24	0.4	.02	.01	0.1
<u>Least Reading</u>						
Strain, in.	.0002	.0005	.001	.0002	.0005	.001
Temperature, °F	.1	.1	.1	.1	.1	.1
Weight, lb	1.2	1.2	1.2	1.2	1.2	1.2
Resistance, ohms ^(c)	64	64	64	64	64	64

(a) Designed for expansion.

(b) Designed for contraction.

(c) Approximate resistance for two coils at room temperature.

2-5. Stress Meter for Concrete.

a. Description. The Carlson Concrete Stress Meter (Figure 2-4) is designed for embedment in concrete to measure compressive stress in concrete independent of shrinkage, expansion, creep, or changes in the modulus of elasticity of the concrete. The Stress Meter is designed to simulate as nearly as practicable a thin plate with a finite modulus of elasticity.

b. Principle of Operation. The meter consists essentially of a 7-in. diameter plate with a strain meter sensing element mounted on one face. The plate has a mercury film at its midthickness and a flexible rim with the result that any stress through the plate is applied to the mercury film. The mercury is in contact with the more flexible center portion and deflects it elastically in direct proportion to the intensity of stress. The measuring unit is a small, elastic, wire strain meter as described in paragraph 2-2, again measuring the temperature along with stress. The sensing element is isolated from the concrete by being protected by a metal shield tube covered with PVC tubing.

15 Sep 80

c. Installation Considerations. Since the design of the stress meter requires that the modulus of elasticity of the plate through its thickness be not less than half that of the concrete around it, (Table 2-4), it is essential that it be in intimate contact with the concrete after embedment. Poor contact would be equivalent to a low modulus of elasticity. Whenever possible, the C800 stress meter with a range of 800 psi should be used in preference to others because this combines the most favorable design characteristics.

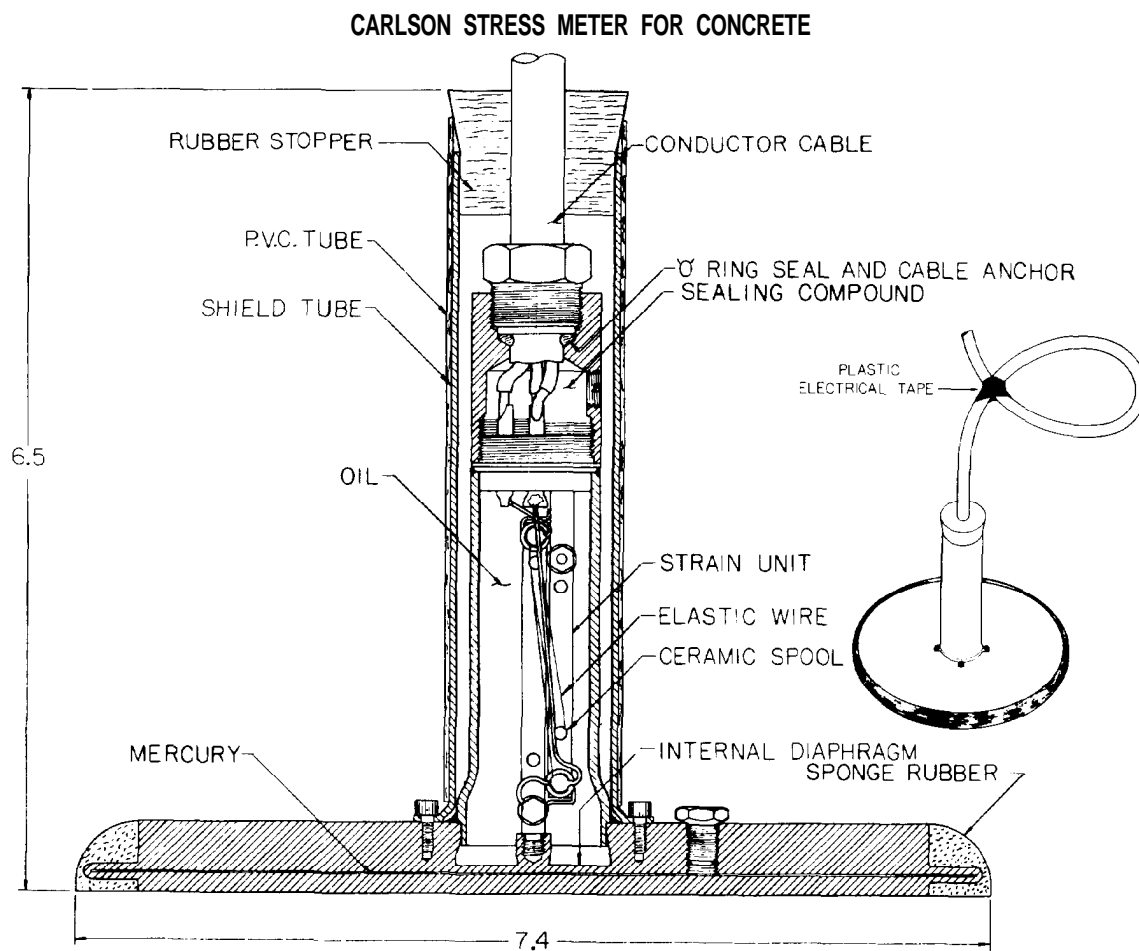

Figure 2-4. Carlson Stress Meter. (Courtesy of Carlson Instruments)

15 Sep 80

Table 2-4

(Courtesy of Carlson Instruments)

SPECIFICATIONS - C SERIES, CARLSON CONCRETE STRESS METER

Model Number	C400	C800	C1500
Range, psi ^(a)	400	800	1500
Least reading, psi	3	5	10 Least
Least reading, temperature, °F	.1	.1	.1
Modulus of elasticity, psi	2x10 ⁶	4x10 ⁶	6x10 ⁶
Effective area of meter, sq in.	35	35	35
Weight, lb	6.7	6.7	6.7

(a) Higher ranges are available upon special order.

2-6. Pore Pressure Cell. The Carlson Pore Pressure Cell (Figure 2-5) is designed to measure the pressure in the pores of any porous material. It functions by allowing the water pressure to pass through a sintered stainless steel disk to an internal diaphragm while holding back the pressure due to other forces. The water pressure causes a very small deflection of the internal diaphragm. The deflection is measured with the same sensing element as used in the stress meters (paragraph 2-2). The same electrical resistance wires which sense the deflection of the diaphragm also sense the temperature. The conductor cable most commonly used is the same as for the stress meter and standard strain meter. The characteristics of the gage are given in Table 2-5.

Table 2-5

(Courtesy of Carlson Instruments)

SPECIFICATIONS - P SERIES, CARLSON PORE PRESSURE CELL

Model Number	P25	P50	P100	P200
Range, psi ^(a)	25	50	100	200
Least reading, psi	.1	.2	.4	.8
Least reading, temperature, °F	.1	.1	.1	.1
Weight, lb	2.25	2.25	2.25	2.25

(a) Special ranges may be ordered.

CARLSON PORE PRESSURE CELL

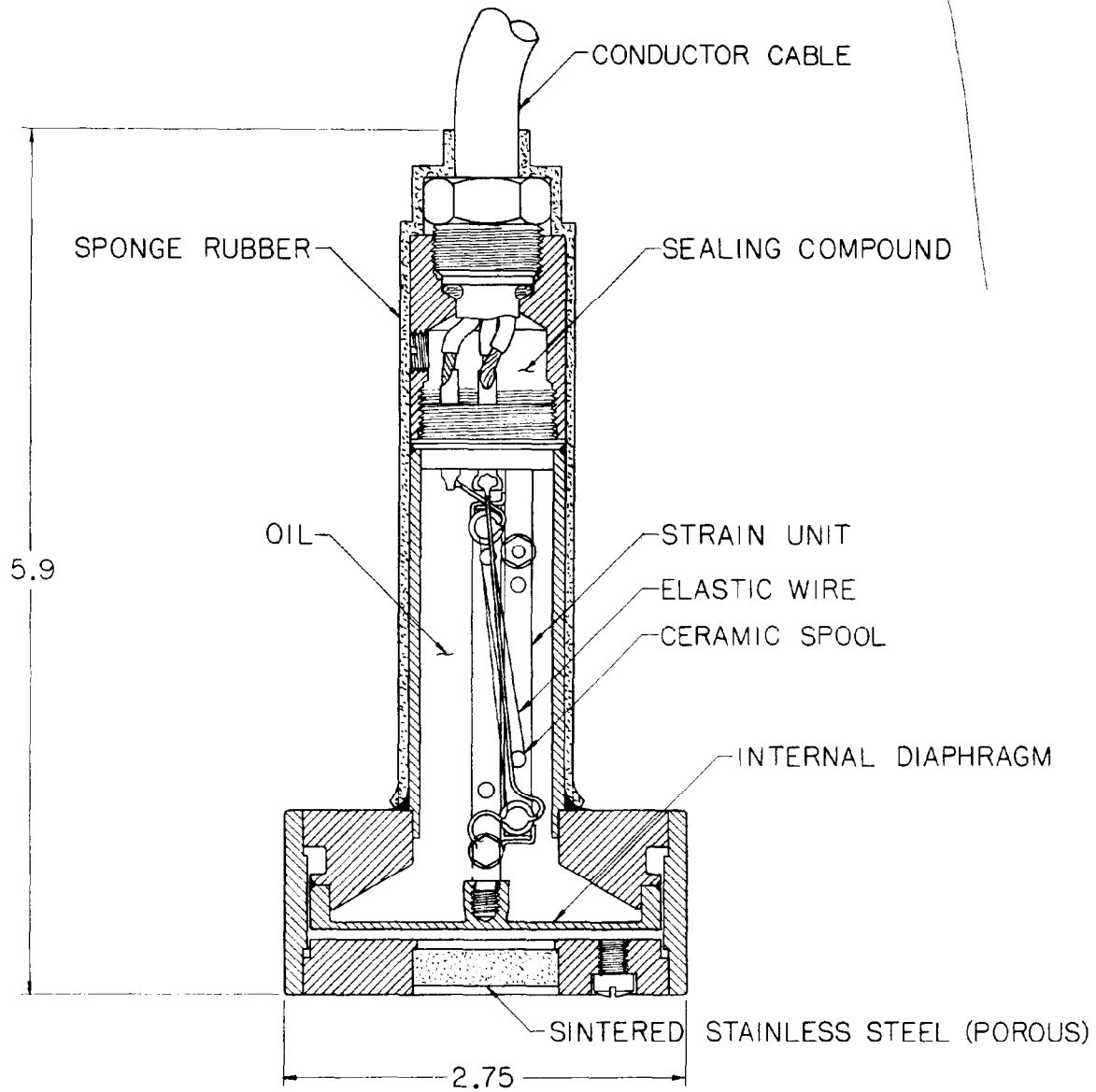
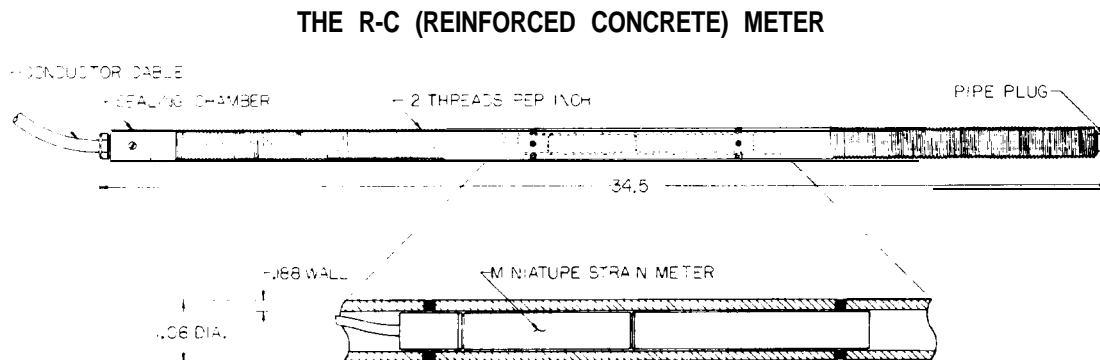

Figure 2-5. Carlson Pore Pressure Cell. (Courtesy of Carlson Instruments)

15 Sep 80

2-7. The Reinforced Concrete Meter. The reinforced concrete meter (R-C meter) is a device for measuring the strain behavior of reinforced concrete. It consists of a miniature strain meter encased in a 0.188-in.-thick hollow steel bar of 1.06-in. diameter (Figure 2-6). It is used for embedment in reinforced concrete and measures the average strain over the rods length. The rod is 34.5 in. in length and the ends of the rod are threaded to provide a bond surface to anchor the meter in the concrete.

a. Advantage. This gage measures the average length change. This is important in that it measures the stress as a function of the distance between threaded anchors at the end of the bar. Conventional strain meters of shorter length would indicate a different result depending upon whether a crack is within the gage length or just beyond it. Consequently, a strain reading in the meter larger than the strain capacity of the concrete is an indication of a tensile crack in the concrete. Also, when the strain is below the tensile strain capacity, the meter indicates both the tensile stress in the reinforcing and the strain in the concrete.



SPECIFICATIONS

Range (micro-strain)	# 950
Least Reading (micro-strain)	3.4
Least Reading, (stress in steel PSI)	100
Least Reading, temperature (°F)	0.1
Maximum Stress (PSI)	44,000
Weight (lbs.)	5.5

Figure 2-6. Reinforced Concrete Meter. (Courtesy of Carlson Instruments)

b. Installation. Since the sensing element is encased in a hollow steel chamber, the meter is quite rugged. It is most usually attached to the reinforcements by means of wires attached between the meter and the reinforcement at the meters ends. The cable lead from the meter should be attached to the reinforcement in such a way that it will not pull when the concrete is placed.

c. Temperature correction. The temperature correction can be applied simply and accurately because the R-C meter is also a thermometer, and the correction per degree is already a known factor.

2-8. Resistance Thermometer.

a. Description. The Carlson resistance thermometer (Figure 2-7) is especially designed and constructed for embedment in concrete. The resistance thermometer is simply a non-inductively-wound coil of enameled copper wire enclosed in a vinyl mastic cover. The wire is wound on an insulating spool in such a way that there will be no appreciable strain changes as the temperature changes. The thermometers have a uniform resistance of 39.00 ohms at 0°F and change 0.01 ohms per degree. The temperature range on the thermometer is 0°F to 180°F (Table 2-6).

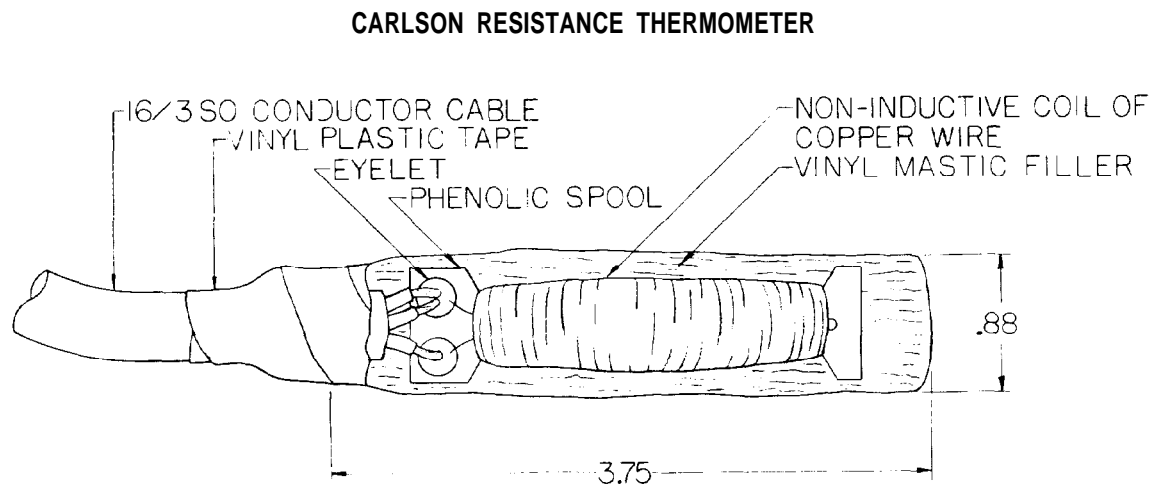

Figure 2-7. Resistance Thermometer. (Courtesy of Carlson Instruments)

Table 2-6
(Courtesy of Carlson Instruments)
SPECIFICATIONS - TF1,
CARLSON RESISTANCE THERMOMETER

Model Number	TF1
Range, °F ^(a)	0 to 180
Least reading, °F	0.10
Weight, lb	0.5

(a) Thermometers are trimmed to be within $\pm 0.5^\circ\text{F}$.

b. Conducting Cable. Each thermometer is supplied with 30 in. of three-conductor rubber-covered cable, size 16, Type SO. The three conductors make it possible for special test sets to make an automatic subtraction of the resistance of the leads by balancing one conductor against another in adjacent arms of the Wheatstone bridge circuit.

2-9. Source. The six resistive-type instruments previously described are shown on Figure 2-8. These instruments may be purchased from Carlson Instruments, 1190-c. Dell Avenue, Campbell, California, 95008.

2-10. Instrument Preparation.

a. Receipt. Strain meters, joint meters, and resistance thermometers are carefully packed for shipment. Stress meters are shipped in specially designed cartons which in turn are placed in a double walled carton. Upon receipt of a shipment of instruments they should be unpacked, inspected for damage, and checked for operability. Strain meters and joint meters should be closely examined for oil leaks and all instruments should be read and the readings checked against calibration data furnished by the manufacturer. In the case of strain meters, stress meters, joint meters, and pore pressure cells the ratio should be very close to the neutral or no-load ratio given in the calibration data. Instruments which show oil leaks, are unreadable, or give obviously unreasonable readings, should be separated from the shipment and immediately returned to the manufacturer for repair or replacement.

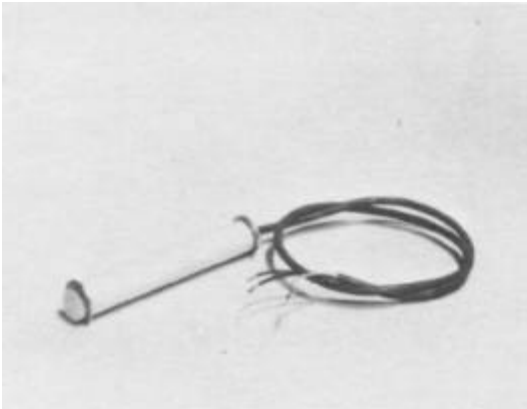

Strain Meter

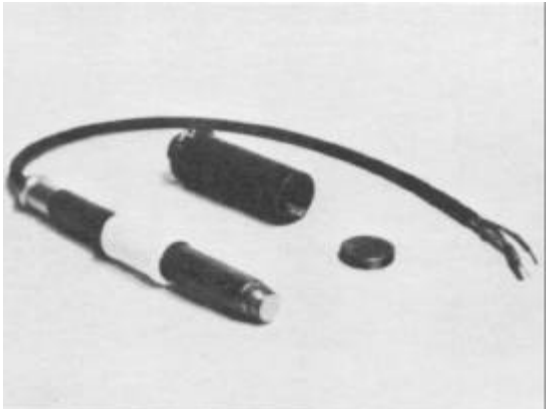

Joint Meter



Stress Meter

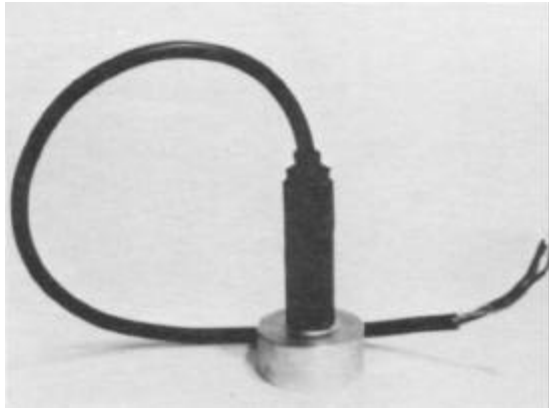

Pore Pressure Cell

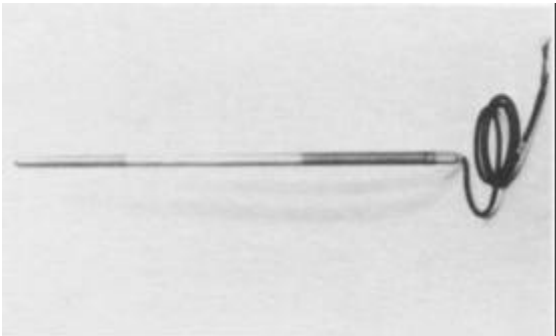

Reinforced Concrete Meter



Resistance Thermometer

Figure 2-8. Carlson Embedment Instruments (Courtesy of Carlson Instruments).

b. Instrument Storage and Protection. Stress meters and pore pressure cells should be left in packing boxes for storage as illustrated in Figure 2-9, secured as received. The inspection and reading check to be made as outlined above can be completed without removing the strips which secure the meters for shipment. For protection during cable splicing operations and handling on the job, strain meters and joint meters may be carefully repacked in the manner received or preferably each meter may be placed in a protective container such as shown in Figure 2-10. The container illustrated was made by cutting fiber conduit of appropriate size (about 2-1/2-in. id) into suitable lengths. The meters are loosely wrapped with waste cloth or rags and placed inside the container. Inside the container the instrument is surrounded with wrapping paper and some end packing so that it is held securely and cushioned against shock, which might damage it. The ends of the container are taped with friction or other suitable tape to hold the meter and the packing in place. No special protection is necessary for resistance thermometers.

c. Identification. Each meter should be identified by a letter prefix designating the type of instrument, and numbered consecutively for each type. Thermometers usually are given the prefix T, joint meters JM, strain meters SM, stress meters C, pore pressure cells PP, and reinforced concrete meters, RC. Those instruments which are installed for a special purpose, such as "no-stress" strain meters placed so as to be unaffected by stresses within the structure, should be further identified by a letter suffix, usually X. To facilitate identification of the instruments during the difficult and hurried operations accompanying placement each meter should be plainly marked by lettering its identification number on the temporary protective cardboard cover. Those instruments not provided with such protectors may be marked by fastening a large mailing tag, with the identification number lettered thereon, to the meter.

d. Cable Identification. When the cable lead is spliced or connected to a meter, a copper band with the instrument identification number stamped or punched on it is crimped to the cable about 3 ft from the meter and a similar band crimped about 1 ft from the free end of the cable. In addition, in case this latter metal band is stripped off during placement operations, a second marker consisting of the identification number marked on white tape, and covered with linen and friction tape, should be placed around the cable near the reading end.

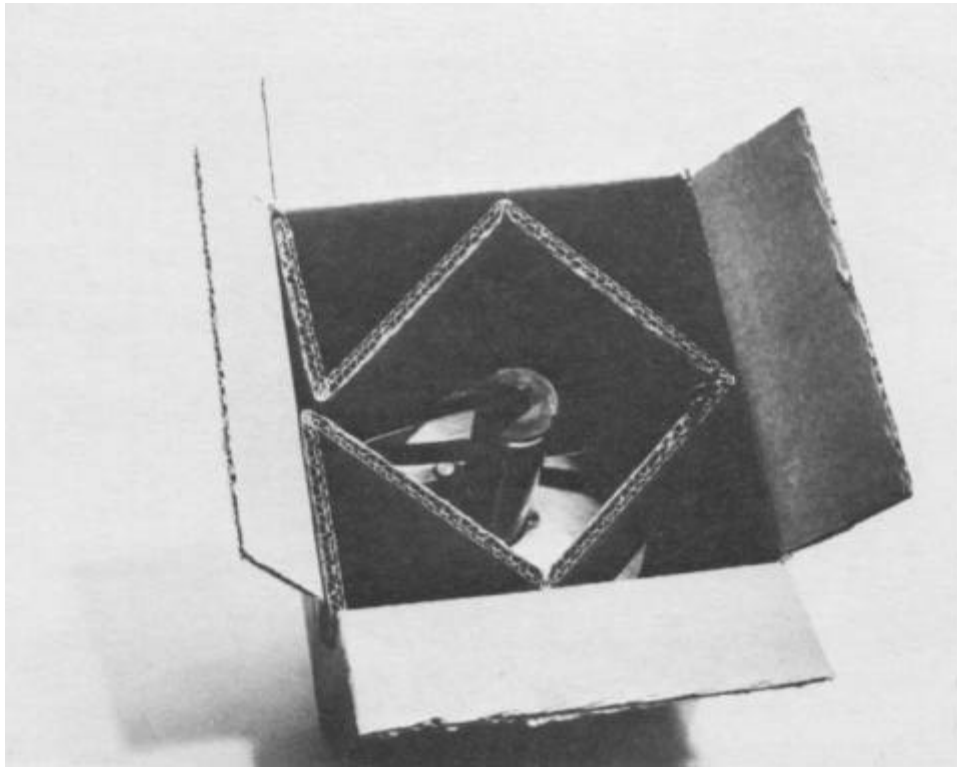

Figure 2-9. Stress Meter Packed for Shipment (Courtesy of Carlson Instruments).

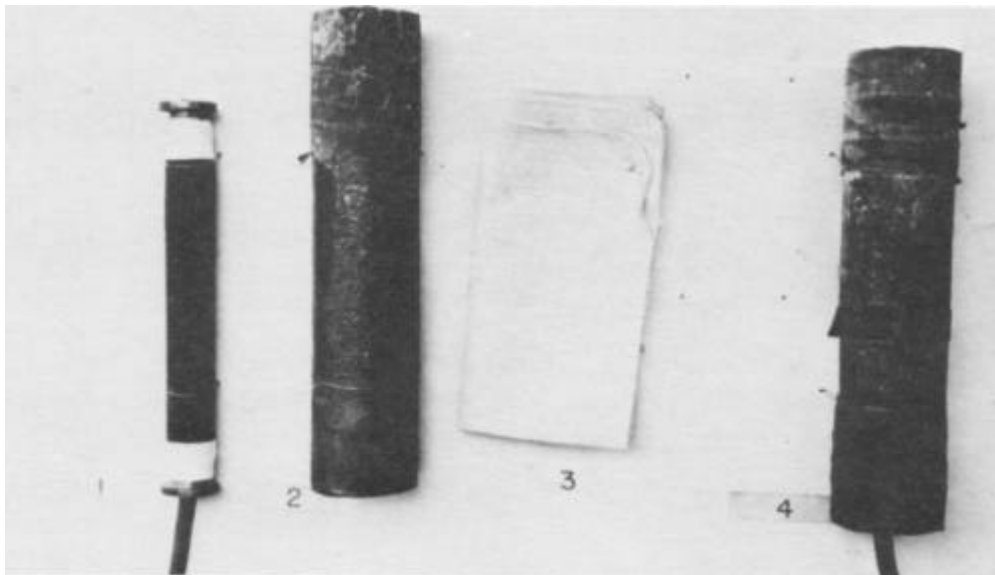

Figure 2-10. Strain Meter and Protecting Case (Courtesy of the Tennessee Valley Authority).

15 Sep 80

e. Alternate Identification. An alternative method of cable identification has been used by Walla Walla District. Two types of heat shrinking tubing are used. First, a white shrink-tubing is heat shrunk around the cable. Identification markings are made on this tubing with a Kingsly Wire Marking Machine. Secondly, for permanent protection, a clear type of tubing is heat shrunk over the white tubing containing the identification markings. Two tags are placed on each cable.

2-11. Waterproofing Treatment.

a. Method. Subsequent to being purchased each thermometer is given an additional waterproofing treatment consisting of coating the thermometer case and several inches of the attached cable lead with GE Cable Joint Compound No. 227. This is done by dipping the thermometer into a bucket of hot (325°-350°) melted joint compound, quickly removing it, and immediately immersing it in a bucket of cold water to prevent damage to the interior coils which might occur due to overheating. The coated meter is then wrapped with ordinary friction tape as protection to the coating during handling. While this additional treatment provides additional moisture-proofing, the coating also acts as undesirable thermal insulation. For this reason only those thermometers which are to be located more than 3 ft from any concrete surface (excluding walls, roofs, and floors of galleries and interior rooms or recesses) should be given the additional waterproofing treatment.

b. Exclusions. No coating should be applied to strain meters, stress meters, joint meters, and pore pressure cells, since the tape and joint compound would affect the bond with the concrete, and hence influence their response to stress or strain conditions.

2-12. Cable Leads.

a. Types. The Carlson meters are normally supplied with about 30 in. of No. 16 AWG three conductor, Type SO, neoprene rubber-covered cable. This size is used for cable runs of up to 600 ft; larger gage wire is used for longer runs. In most instances more cable will be needed than that supplied with the instrument. It is recommended that any type of cable splice be avoided when running these instruments from point of embedment to the terminal station in a gallery. Splices are viewed as sources of potential failure of embedded instruments and subject to deterioration that can disable the meter. To avoid field splicing, adequate cable lengths can be ordered with the instrument.

15 Sep 80

b. Cable Length. In estimating the length of cable to be added, a suitable route between the point of embedment of the instrument and the terminal station in the gallery is selected by study of the drawings. In selecting the route, due consideration must be given to the construction procedures involved in placing the concrete where the instrument is to be embedded and to possible obstructions along the chosen route. After the selected route has been verified the length of cable required is estimated, and a small amount (usually 10 percent or 5 ft, whichever is larger) is added to allow for extra length required due to normal variation from the selected route. This amount of cable should be ordered with the meter at the time of purchase.

c. Splicing Procedures. Although splicing cables onto meters is strongly discouraged, there are situations where splicing cannot be avoided. In these cases lead cable should be Type SO neoprene jacketed of appropriate gage and of three or four conductor as required. Field splicing can be accomplished by using the technique described in Appendix B.

2-13. Calibration Corrections.

a. Calibration Factors. Except for resistance thermometers, each instrument is individually calibrated by the manufacturer and calibration factors are furnished for all instruments. These factors are normally obtained from calibration runs, using short 2-or 3-ft leads, and calibration adjustments must be computed by the user to take into consideration the ballasting effect of the added cable leads when resistance ratios are involved in the instrument observations. The instrument characteristics furnished by the manufacturer should be recorded in a permanent file or ledger, together with the project identification number assigned to each meter and the results of the calibration correction measurements described herein. These records will prove invaluable later if necessary to trace some deviation in the readings, and also serve to detect improper splices or malfunctioning of the meter before it is installed. The calibration adjustments should be done by fully trained personnel. It is suggested that the individuals responsible for this work consult with either the manufacturer of the instruments or the USAE Waterways Experiment Station (WES) to assure that proper methods and equipment are used.

b. Strain Measuring Units. The transducer element in the strain meter, stress meter, joint meter, pore pressure cell, and the R-C meter is the basic elastic wire strain gage, requiring at least 3-conductor color coded cable, shown on the wiring diagrams (Plates 2-1 and 2-2). When 4-conductor cable is added, the fourth wire is connected to the white conductor during splicing operations.

c. Operation Check. In order to check the operation of the meter, establish resistance values of various parts of the electrical circuit for each instrument, and secure information for correcting or checking the given calibration factors, a series of direct resistance observations (Plate No. 2-3) is made in the shop by means of a Wheatstone bridge or portable test set.

(1) First. After the cable lead to be added to the instrument has been cut to the required length and the conductor ends stripped and tinned, the total resistance of each individual conductor in the cut cable is measured and recorded.

(2) Second. Just prior to splicing the long cable to the short leads on the instrument, total resistances of the instrument coils and short leads are measured. These include -

(a) Expansion coil including white and green short leads.

(b) Contraction coil including black and green short leads.

(c) Expansion and contraction coils in series including black and white short leads. In addition, using the conductor common to both coils (green) as a leg of the Wheatstone bridge (Plate No. 2-2), the resistance of each coil is measured.

(d) Expansion coil only.

(e) Contraction coil only.

Also, the ratio of the resistance of the two coils is determined directly by means of the bridge.

(f) Resistance ratio at splice.

(3) Third. After the cable splice has been completed, a set of six resistance measurements similar to the series just described is made. These readings will include the effect of the full cable leads.

d. Data Sheet. Typical results of resistance calibration measurements are shown on Plate No. 2-3. These values provide the necessary information for correcting calibration factors, and, by properly combining the observed resistances, serve as a check on the operation of the instrument and in detection of improper splices and defective cable.

15 Sep 80

2-14. Correction Factors.

a. Calibration Factor Correction. The calibration factor furnished by the manufacturer (strain change per unit change in resistance ratio for strain meters, and similar changes for stress meters, joint meters, and hydrostatic pressure cells) is corrected by multiplying the given factor by the ratio of the measured series resistance of the two instrument coils and the entire cable leads to the measured series resistance of the same two coils and the short cable leads. This operation is shown on Plate No. 2-4. The correct calibration factor will always be greater than the initial factor, since the long cable leads introduce additional resistance into the circuit, thus demonstrating that the added cable leads reduce the sensitivity of the instrument. A correction factor ratio also may be calculated from the individual resistance readings made during the operational checking of the instrument, and it is even possible to arrive at a correction ratio after the instrument is embedded in the structure. These values are only approximate, and normally are used solely for checking the result from the more accurate method.

b. Temperature Factor Correction. The total resistance of strain units is frequently used to measure temperature at the instrument. With either 3-conductor or 4-conductor leads, compensating test set circuits may be arranged as shown on the wiring diagrams so as to eliminate the resistance of the added cable leads, provided the individual resistances of all conductors in the cable are precisely equal. Since this condition rarely exists with commercially available cable, the given meter resistance at the base temperature (usually 0°F) must be corrected to take into consideration the differences in resistance between the individual conductors of the added cable. The direct resistance measurements made previously of each added cable conductors are used for this purpose as follows:

(1) For 3-conductor cable - add, algebraically, the quantity $(2r_3 - r_1 - r_2)$, to the given meter resistance at the base temperature.

(2) For 4-conductor cable- add, algebraically, the quantity $(r_2 - r_1)$ to the given meter resistance at the base temperature.

Where: r_1 = resistance of the conductor lead (black) connected to the free end of the contraction coil
 r_2 = resistance of the conductor lead (white) connected to the free end of the expansion coil
 r_3 = resistance of the conductor lead (green) common to the contraction and expansion coils.

Normally no correction is applied to the given meter resistance change per unit of temperature furnished by the manufacturer. Temperature correction calculations are shown on Plate No. 2-4.

15 Sep 80

2-15. Resistance Thermometer Calibration. A similar type of temperature calibration correction is necessary for the resistance thermometers as for the strain units, but is accomplished by a more precise and accurate method. After the conductor splices have been made but prior to adding the insulation and completing the splice, the meter is immersed in a bucket of water at room temperature and allowed to remain long enough for the entire meter to reach a uniform temperature. Resistance reading (3-conductor compensating circuit) are then made in the usual manner at the splice and at the end of the added cable lead. The exact temperature of the water bath is not significant, so long as it is constant during the calibration readings of a thermometer. The corrected resistance calibration of the meter at the basic temperature (usually in ohms at 0°F) is obtained by adding, algebraically, the quantity ($R'_y - R_v$) to the basic resistance value furnished by the manufacturer,

where: R'_y = Resistance reading from test set at end of
cable leads, ohms.

R_v = Resistance reading from test set at the splice,
ohms.

Normally no correction is applied to the given meter resistance change per unit of temperature furnished by the manufacturer.

2-16. Final Calibration Adjustments.

a. Cable Length Adjustments. Further correction of instrument calibration factors is required whenever any appreciable length of conductor cable is added to or cut off from the initial length of added cable lead. Since all cable initially added to instruments has some allowance for contingencies which might be encountered during embedment, it is usually necessary to cut off some surplus cable when making permanent connections at the terminal. To adjust for the effect of possible changes in total conductor resistance and to detect changes in electrical circuits resulting from terminal connection operations, a series of resistance readings are made immediately prior to trimming off excess cable and again after the permanent terminal board or strip connection is completed.

b. Temperature Adjustments. Final adjustment of the temperature factor (ohms at 0°F) for resistance thermometers is obtained by measuring the 3-wire resistance of the instrument before and after trimming the cable lead. The previously corrected temperature factor (ohms per °F) is then adjusted by adding, algebraically, to the factor the measured instrument resistance after trimming minus the measured instrument resistance before trimming. No adjustment is made of the temperature calibration (°F per ohm change).

15 Sep 80

c. Strain Adjustments. For strain units the total resistance of the expansion and contraction coils in series including the attached conductors (black and white) is measured before and after trimming the cable. The final adjusted calibration factor (strain change, or similar stress, pressure or length change, per unit change in resistance ratio) is obtained by multiplying the previously corrected calibration factor by the ratio of the total resistance before trimming to the total resistance after trimming. No adjust is made of the temperature factor (ohms at 0°F) or of the temperature calibration (°F per ohm change) for strain-type instruments, except when 4-conductor cable is used. In that event the final adjustments are made in the same manner as is subsequently described for resistance thermometers.

2-17. Instrument Installation.

a. Personnel. The key man in all embedment operations is the instrumentation group leader. Aided by an assistant, he should be able to accomplish the placement of many of the thermometers, pore pressure cells, joint meters, and single strain meters, providing all the instruments are not to be embedded simultaneously within a lift. Where several stress meters, strain meters, or thermometer groups, all of which require considerable care in placement, are planned for a single concrete lift, the group leader will require the assistance of as many as three junior engineers or concrete technicians plus several unskilled laborers. The engineers do the actual placing of the instruments, directing the laborers in digging the required holes and cable trenches, and in backfilling over the meters. In extensive installations within one lift, fatigue and haste will usually cause a relaxation in the precision with which the last few strain or stress meters are placed, and ample personnel should be provided in order to avoid this situation.

b. Preliminary Preparations. As soon as the group leader responsible for the meter installation is designated, several weeks or months prior to the time the first instrument is to be installed, details of meter placement and alignment should be worked out in the project office. Locations of the instruments as indicated on the contract drawings should be checked for errors or impractical arrangements, and any necessary deviations presented to the District office for their concurrence. When "spiders" are to be used to support strain meters in their proper positions, they should be fabricated in the shop or purchased from a commercial source. If the strain meters are to be located and aligned by means of templates, these should be constructed. Block-out boxes, used to form temporary cavities or working spaces in which the groups of meters are to be placed, should be constructed of the proper size and shape. Pipe supports for strain meter boundary groups and for multiple thermometer assemblies should be fabricated. The sequence of instrument embedment should be established so that proper cable lengths can be ordered with the instrument to minimize the amount of splicing that is necessary and calibration operations for each meter can be scheduled in their proper order. In addition to providing for material and equipment requirements, personnel who are to do the actual embedment of stress meters and strain meters should become thoroughly familiar with the techniques involved. It is essential that trial runs of stress meter placement be made as part of the familiarization phase. The conditions of embedment are such that there will be no opportunity during meter embedment operations to consult written placement instructions, and a thorough knowledge of techniques is essential.

c. Final Preparations. Before concrete placement is started in the lift to contain the instruments, the group leader should tour the location, checking to see that cable conduits are available and clear and that recesses and terminal box block-outs are made. Arrangements should be made for such extra help as will be required during the installation. Survey points should be established and plainly marked so as to be visible and clear of concrete operations. Block-out boxes, templates, and instruments should be placed so as to be readily available.

2-18. Embedment Techniques. Installing strain meters is the most difficult and precise job involved in a special instrumentation program. Installing stress meters is somewhat less difficult, chiefly because fewer are installed at any one location, and placement often may be done following completion of a lift. Joint meters, resistance thermometers, and pore pressure cells require only moderate care in placement. Details of the established techniques for embedment of the Carlson transducer instruments described in this section (para 2-1 through 2-8) are given in Appendix C.

15 Sep 80

Section II: Terminal Facilities and Reading Equipment

2-19. Design of Terminal Recesses.

a. Location. Permanent facilities for making readings are provided in terminal recesses usually located in block-outs on walls of galleries nearest the instruments. It is customary to locate the recesses near a monolith joint in order that vertical runs of cable can be placed near bulkhead forms. The reading stations for all embedded instruments in a monolith should be located in that monolith if possible, in order to avoid running cable leads across contraction joints. Separate terminal recesses for cable leads from different types of instruments are not required. Where a gallery of similar semiprotected location is not available, a conveniently accessible exterior location may be selected, and the facilities secured against unauthorized tampering.

b. Size and Arrangement. Up to about 60 instruments may be served conveniently by a single terminal recess. More than this number create difficulty in bringing the cables into the recess and making connections to the panel board or terminal strip. The recess need not be lined, except that where only a small number of cables terminate at one station a commercial flush-type steel cabinet is acceptable. Outside reading stations require a weather-proof cabinet (Crouse-Hinds Co., 1347 Wolf St., Syracuse, NY 13201, traffic control box or similar). The bottom of the recess should be at a waist-level working height, and at least 1 ft of clear working space provided on the sides of the panel board or terminal strip to allow sorting and arranging of the cable leads. The door may be hinged on the bottom, and held in a horizontal position by chains when open to provide a convenient table space when making readings. If the doors are side-hinged, additional space is desirable within the cabinet for this purpose. A recess depth of at least 12 in, is necessary. Where auxiliary indicating or recording equipment is to be used, the recess should be enlarged sufficiently to accommodate these facilities.

c. Lighting. Normal gallery lighting is usually not adequate, and a supplementary fixture at the terminal reading station is necessary. A duplex convenience outlet, suitable for use in the reading station recess, is also recommended.

15 Sep 80

d. Moisture Prevention. To reduce corrosion at the cable terminals and panel board connections, usually a serious problem in dam galleries, an electrical strip heater should be installed within the terminal recess. A 500-watt heater is ample for a large recess. Where the reading station is small, a 100-watt heater may be used, or an ordinary 100-watt electric light bulb installed within the recess will serve the purpose.

e. Doors. Unlined recesses should be provided with angle-iron door frames and sheet steel doors with latch and lock. A closed recess aids in maintaining a more nearly moisture proof atmosphere around the panel board and automatic equipment, and provides security against tampering by curious workmen and other personnel. Doors for small enclosures should be hinged at the bottom, and snubber chains provided to hold the door in a horizontal position when open as a working space when making observations. Large enclosures usually have an ample interior working area.

2-20. Terminal Equipment.

a. General. To facilitate reading the embedded meters, the instrument leads terminate in the reading station at either a plug board or a terminal strip. Selector switches or automatic indicating or recording potentiometers, when used, are served from the terminal strip. Commercially available automatic equipment can be used only for direct resistance or voltage measurements. Some have microprocessors incorporated and are able to calculate resistance ratios from measured values and to perform data corrections.

b. Plug Boards. Plug boards are of 1/4-in. thick commercial bakelite, ebonite, hard rubber, or similar nonconductive material. Sheets are job-cut to size and drilled for insertion of 10-ampere telephone jacks or color-coded laboratory panel jacks. The board is held in place by brackets cinch-anchored to the recess walls or bolted to the metal cabinet, and the instrument identification numbers are stamped or painted on the board to identify the jack groups. A completed plug board is shown in Figure 2-11. In place of a separate jack for each conductor wire, reading operations can be expedited and positive electrical contacts more readily secured by installing ordinary 3- or 4-prong male electrical plugs in the board with the prongs protruding outward, and attaching the female socket to the short length of portable test cable lead.

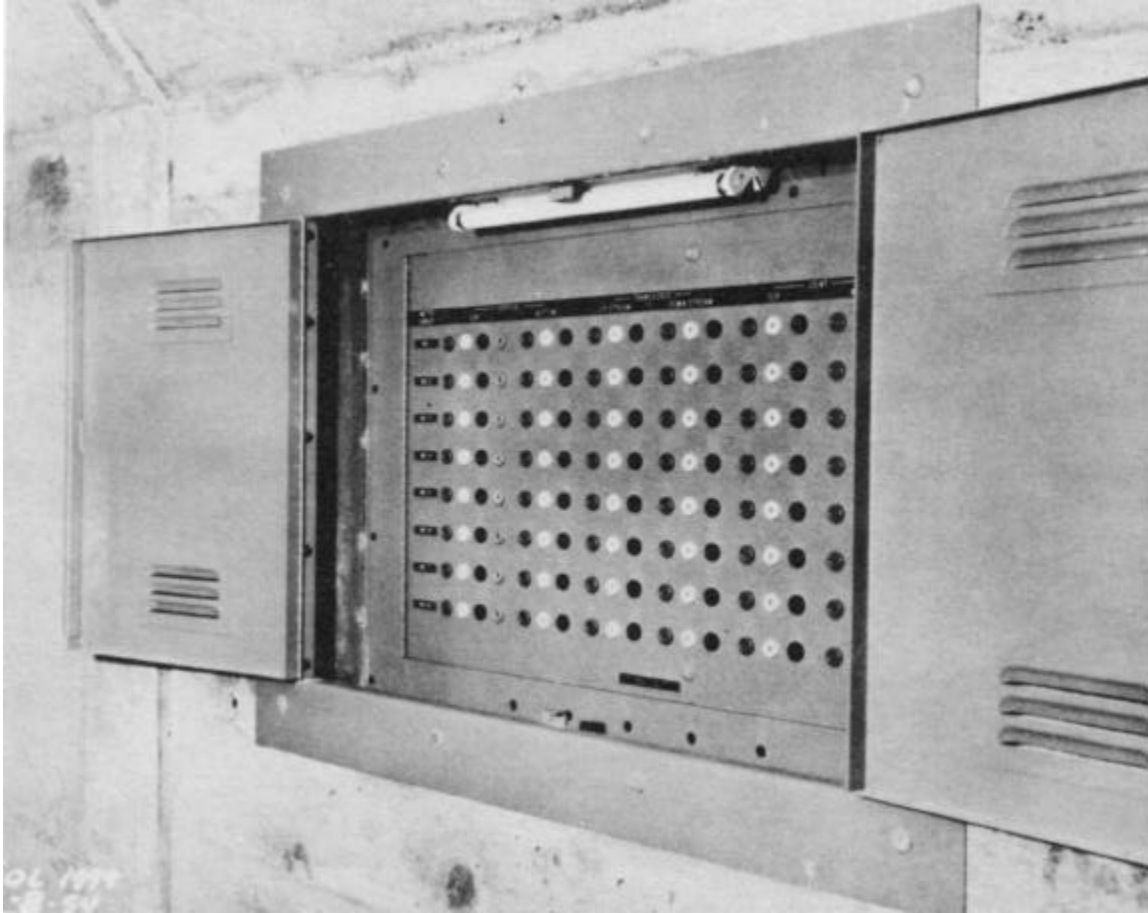

Figure 2-11. Plug Board in Folsom Dam. (Photo by CE-WES)

c. Terminal Strips. Commercially available terminal strips, Figure 2-12, cinch-anchored or bolted to the recess walls, serve as a termination point for the cable leads when supplementary indicating equipment is to be installed. Permanent soldered and moisture-proofed connections should be made on the embedded cable side of the strips, and reading instrument connections made with short lengths of insulated conductor from the other side of the strip.

15 Sep 80

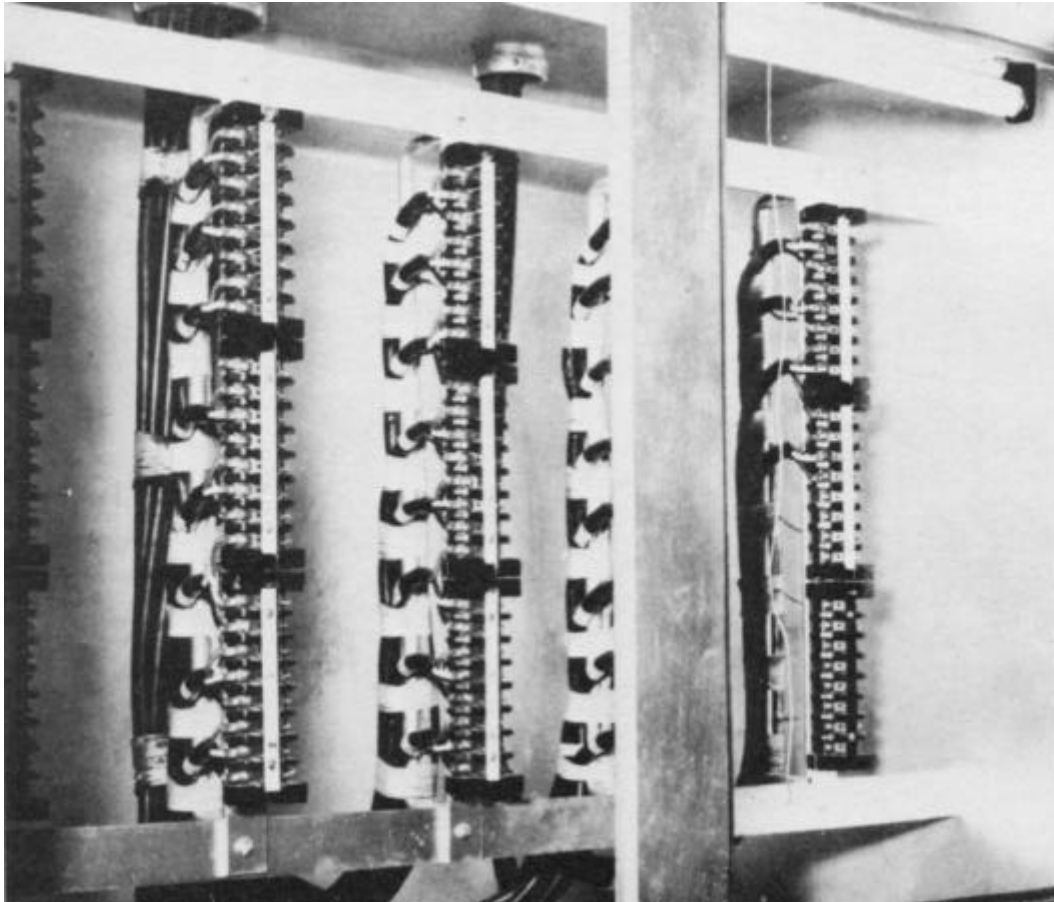

Figure 2-12. Terminal Strips in Reading Station Recess. (Photo by CE-WES)

d. Selector Switches. Equipment of this type, either commercially available or job-built, serves the same purpose as a plug board in that it facilitates making many successive connections during observation operations. Measurement of electrical units is not accomplished by the switching device; a test set or potentiometer must be provided as with a plug board. Electrical contacts within the switch require periodic maintenance in order to avoid introducing extraneous resistances into the embedded instrument circuit.

e. Semiautomatic Indicating Equipment. When a large number of cable leads from resistance thermometers terminate at one reading station, the tedious job of manually balancing the Wheatstone Bridge of a portable test set for each thermometer during a set of readings may be eliminated by installing a multipoint indicating potentiometer in the terminal recess. One type of semiautomatic indicator, Elektronik 15 Precision Indicator, manufactured by the Process Control Division of Honeywell, Inc., 1100 Virginia Dr., Ft. Washington, PA 19034, is available in capacities of 6-point multiples up to a maximum of 48 points. The instrument is basically a Wheatstone Bridge, automatically balanced by means of an electronic amplifier unit and a reversible two-phase motor which drives a slidewire contact to the balancing position. The various embedded resistance thermometers are cut into the circuit through a bank of push-button switches on the face of the instrument. Readings are indicated on a 9-in. diameter rotating disc scale which is driven to indicating position by the balancing motor. The instrument requires a 110-volt external power supply, 50 or 60 cycles, and thus cannot be placed in operation until power is available at the terminal reading station. It is usually necessary that the manufacturer make minor modifications to the standard instrument to adapt it for use with the Carlson resistance thermometer and the power supply available. In order to make certain that the equipment functions accurately and satisfactorily with the type of resistance thermometer with which it is to be used, temperatures indicated by the automatic instrument always must be checked, prior to installation of the equipment, against values as determined by a reliable manual test set. The instrument is not suitable for outdoor installation, nor can it be used for other than direct resistance (or temperature) measurements. A typical indicator installation is shown in Figure 2-13.

f. Automatic Recording Equipment. Continuous temperature readings over time periods of limited duration may be made with the Honeywell Elektronik 15 Multi-Point Strip Chart Recorder, manufactured by the Process Control Division of Honeywell, Inc., 1110 Virginia Dr., Ft. Washington, PA 19034. These instruments are available in 2, 3, 4, 6, 8, 12, 16, or 24 point models, with many combinations of chart speeds, print wheel slide speeds, printing operation speeds, and continuous or intermittent printing sequences. The print wheel has different symbols or numbers on its circumference, and the wheel is rotated automatically one notch for successive printings. The recorder is a continuous-balance potentiometer which measures and records the magnitudes of a number of variables. It is supplied with the actuation, range, and number of recording points. Kits are available for changing the number of points, range of measurement, and type of potentiometer actuation, for example, change actuation from millivolt to thermocouple actuation. As with the semiautomatic indicator, its operation with the resistance thermometers to be used must be checked prior to installation. Use of the instrument is subject to the same limitations as the Honeywell Precision Indicator in regard to voltage and frequency of the external power supply, indoor use, and direct resistance measurements. A Honeywell Electronic 15 Multi-Point Strip Chart Recorder is shown in Figure 2-14.

g. Multiple Position Terminal Switches. For convenient readout of many gages without the need to change the leads of the reading equipment from cable to cable, multiple position terminal switches are available. Leeds and Northrup Co., Dept. MD337, North Wales, PA 19454, manufactures a 3-or 4-pole, 12-position, rotary selector switch that will accommodate up to twelve gages. Three switches per panel can be installed on each board as is shown in the surface mounted readout box shown in Figure 2-15.

2-21. Installing Cable Leads.

a. Cable Orientation. In general, instrument cable leads are run horizontally within the concrete lift containing the embedded instruments to the terminal recess or to a point directly above or below the terminal recess location. Where a group of several cables are to be run horizontally in a lift, they may be taped together at intervals and laid on the top of the next to last layer of concrete in the lift, covered with pads of fresh concrete at several points along their length, and placement of the final concrete lift layer allowed to proceed in the normal manner. Single or pairs of cable leads may be "walked into" the concrete, aided by inserting the vibrator into the concrete layer at intervals along the cable run. With this method care must be exercised to obtain adequate and complete embedment of the cable in order to avoid damage during subsequent lift joint clean-up operations.

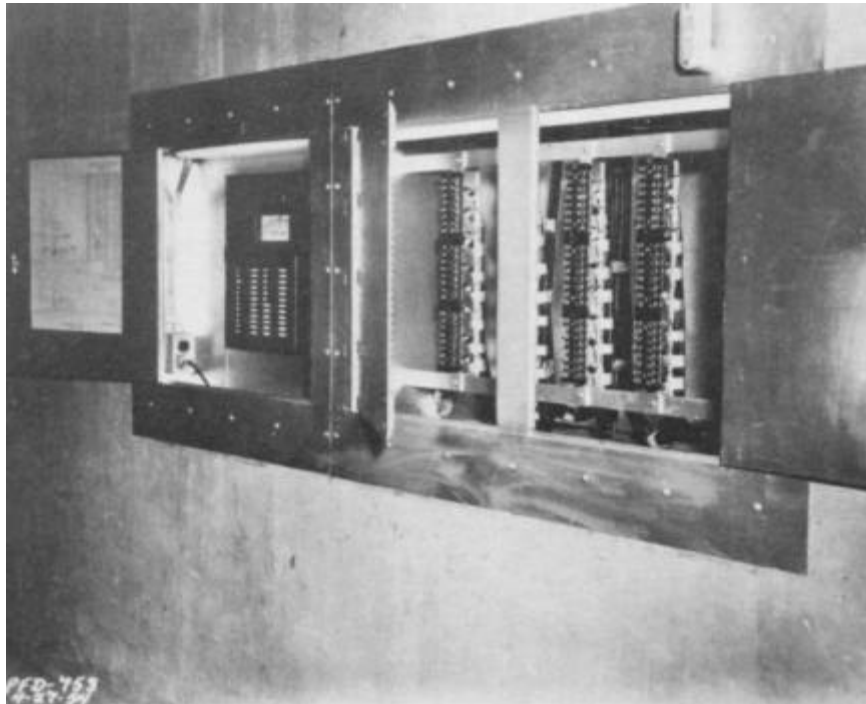

Figure 2-13. Indicating Potentiometer in Reading Station.
(Photo by CE-WES)

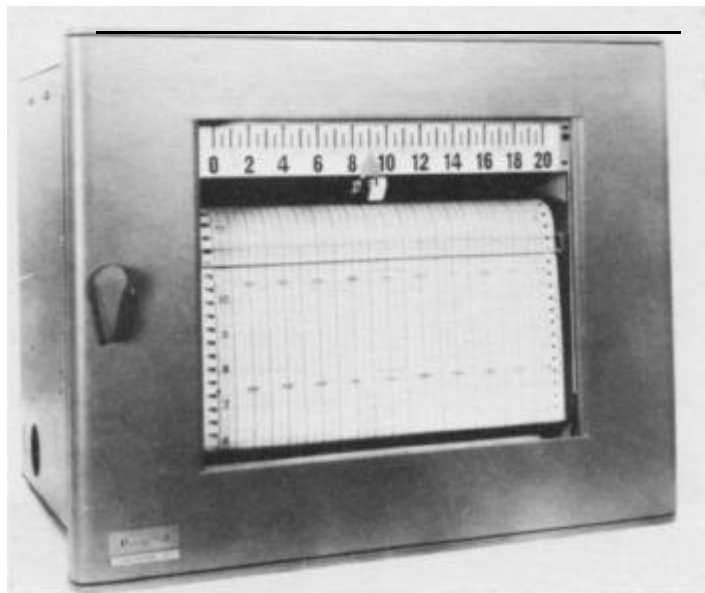

Figure 2-14. Recording Potentiometer (Courtesy of Honeywell, Inc.).

b. Instruments Above Terminal Reading Station. Cable leads are run downward in conduit from the lift containing the instruments to the terminal recess, with separate conduits serving each individual lift. The cable conduit should enter the terminal recess from the bottom of the recess to eliminate water from condensation or drainage flowing over the panel board. Figure 2-15 shows a typical surface mounted reading station with the conduit entering from below. Steel or iron pipe is commonly used for conduit, particularly for the longer vertical runs, but conduit of any material which will not collapse in fresh concrete is frequently satisfactory. Every effort should be made to avoid having a splice in the section of cable which is to be threaded through a conduit.

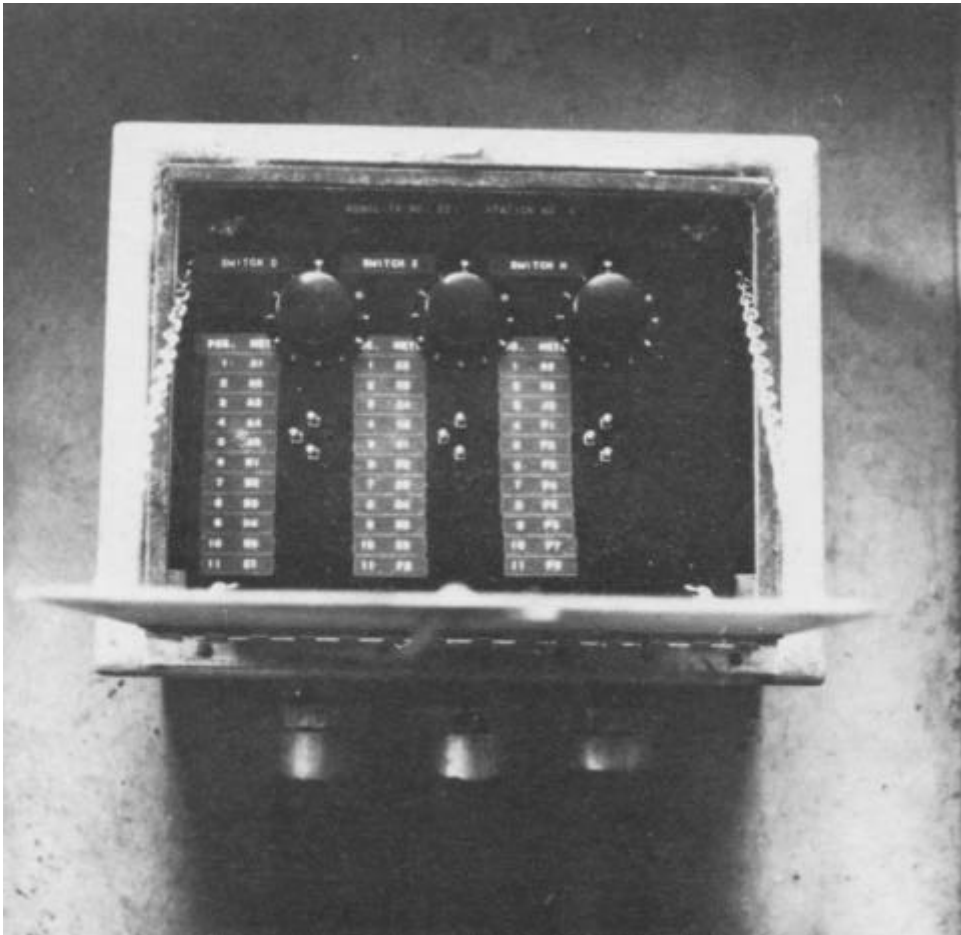

Figure 2-15. Surface-Mounted Terminal Station with Multiple Position Terminal Switches Showing Conduit Fed in from Bottom. (Photo by CE-WES)

c. Instruments Below Terminal Reading Station. Cable leads are run upward without conduit from the lift containing the instruments to the terminal recess. Vertical risers of pipe or reinforcing bars embedded in the concrete of each successive lift are helpful in providing a support for the cables. The cables are simply taped to the riser pipe at short intervals before placing each lift, and the remainder of the cable coiled and hung clear of the fresh concrete.

d. Size of Conduit. Size of conduit required is determined graphically by drawing contiguous circles of diameters equal to that of the cable, in a general circular group, providing for 1-1/2 times the number of cables to be accommodated where the conduit run is short, and up to twice the number of cables where the run is long or where there are bends. Circumscribe the group of circles with a larger circle to determine the inside diameter of the conduit. This is illustrated in Figure 2-16 where a conduit is being sized to hold ten 1/4-in. diameter cables.

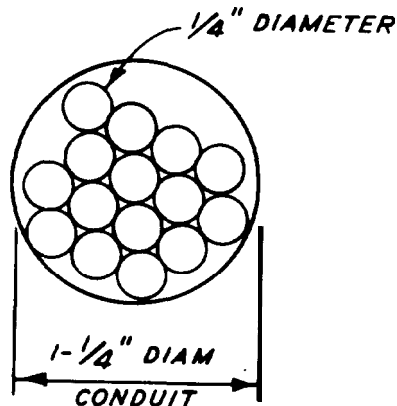

Figure 2-16. Method of Sizing Conduit to Hold Ten 1/4-in. Cables.
(Prepared by WES)

e. Installation of Cables. Cables should be separated and threaded individually into conduit, in order that each cable will be required to support only its own weight. At conduit entrances burlap or similar padding should be provided around each cable and in the interstices between the cables to prevent sharp bends and to exclude concrete and grout from the conduit. Any cable purchased should have filler material for good round firm cable, and the conductor insulation solid color-coded. In lifts where many cables are to be brought together and run downward in conduit, the operation may be accomplished in two steps. First, a wood box or frame is placed around the upper end of the conduit to form a blockout about 18 in. in the concrete lift surface. The cables are embedded in the concrete as usual, brought into the blockout and hung clear of the fresh concrete. Second, on the next day, or when the concrete has hardened sufficiently to bear traffic, the cables are taken down, separated, and threaded through the conduit. This procedure allows the lift to be topped out without interference or delay, facilitates the threading of the cable through the conduit by keeping it clean, and avoids the haste which usually is associated with the final threading operation.

f. Cable Runs Across Joints. When it is necessary for the cable leads to cross expansion or contraction joints in the structure, a "slack cable" recess must be provided at the crossing point. This may consist of a wooden box blockout, as shown in Figure 2-17, forming a recess into which the newly placed cable is run. During placement of concrete in the adjacent monolith or column, a 1-ft loop of slack cable is left in the unfilled blockout, and the remaining length of cable lead extended and embedded in the new concrete in the usual manner.

2-22. Installing Terminal Equipment.

a. Cable Preparation. After all cable leads have been brought into a terminal recess, the surplus cable is cut off and the ends of the individual conductors prepared for permanent connection to the panel board or terminal strip. The metal identification tags attached near the original cable ends should be removed and refastened to the cable above the proposed cutoff point.

b. Electrical Connections. Soldered cable connections at the panel board or terminal strip are required. After connections have been completed and are dry, two coats of a commercial electrical insulating varnish should be sprayed over the exposed conductors and connections to afford protection against moisture.

15 Sep 80

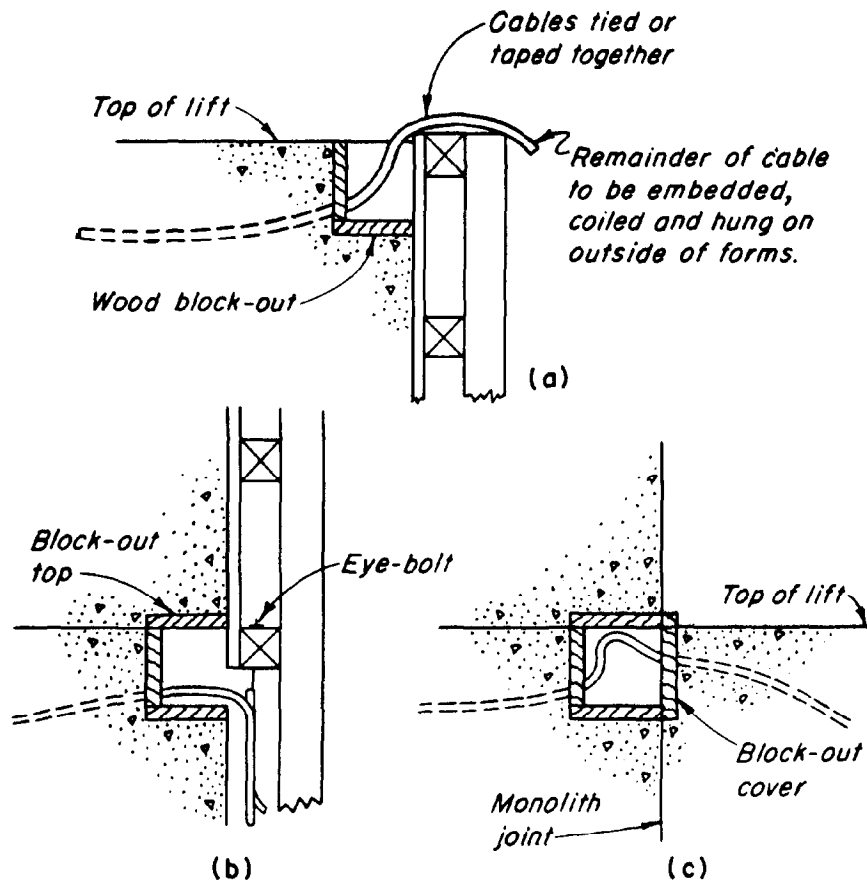

Figure 2-17. Slack Cable Recess. (Prepared by WES)

c. Instrument Check Readings. In order to make the final calibration corrections for each instrument and to check the quality of the connections, manual test set readings are made of each instrument immediately prior to trimming the surplus cable, after trimming the cable, and from the panel board or terminal strip after connections have been made. These readings should be recorded on the field data sheets and final calibration constant corrections made, if required.

d. Read Out Boxes. All read out boxes should be the same dimensions, a convenient size being 18- by 13- by 8-in. The box should be constructed of welded steel with a hinged door that is chained such that when it is let down it forms a table for the read-out bridge or for recording data. These boxes are used either exposed, wall-mounted, as in Figure 2-15, or installed in blockouts on steel face plates.

2-23. Reading Equipment.

a. Carlson Test Set. The Carlson test set shown in Figure 2-18 is basically a portable Wheatstone Bridge, consisting of a galvanometer, two known equal resistances, a variable resistance, and suitable binding posts for use with 2-, 3-, or 4-conductor cable. The variable resistance is adjusted by means of four decade dials, permitting resistance measurements from 0.01 to 109.00 ohms and resistance ratio measurements from 0.0001 to 1.0999 to be made. Direct readings of 2-wire resistance, 3-wire resistance, 3-wire resistance ratio, or 4-wire resistance and resistance ratio may be made with the same test set by proper binding post connections and galvanometer switches. Thus the Carlson test set is suitable for use with all the Carlson-type instruments. Schematic wiring diagram and operating instructions are shown on the interior of the test set cover. Similar wiring diagrams are given on Plates No. 2-1 and 2-2.

b. Biddle Test Set. The Biddle Test Set, No. 72-4010, is a special Bridge that is also designed for use with all Carlson instruments and can be obtained from James Biddle Co., Township Line and Jolly Roads, Plymouth Meeting, PA 19462.



Figure 2-18. Carlson Test Set. (Photo by WES)

15 Sep 80

c. Maintenance. The current activating the galvanometer is supplied by ordinary flashlight batteries contained in the test set box, and the batteries should be replaced at intervals of not more than six months or whenever the galvanometer needle deflections become weak or sluggish. Holding the galvanometer switch button down continuously while balancing the bridge causes an excessive drain on the batteries as well as raising the temperature of the embedded instrument resistance coils, and should be avoided. At least once each year or whenever there is reason to suspect malfunctioning of the test set, the test set should be partially dismantled, accumulated dust and dirt removed from the decade dial spindles, and the decade resistance buttons and contact arms cleaned and polished. A light film of petroleum jelly wiped onto the contacts will aid in maintaining a satisfactory contact surface. For more extensive repairs or recalibration it is recommended the test set be returned to the supplier.

d. Recorders. For a continuous monitoring of the Carlson instruments the use of multi-point strip chart recorders will monitor up to 24 instruments. Para 2-20.f. gives detailed information about these recorders.

Section III: Data Collection and Reduction

2-24. Collection of Data.

a. Data Sheets.

(1) Field Reading Sheets. Resistance and resistance ratio readings from all Carlson-type instruments may be recorded on field reading sheets (prepared in advance) similar to Plate No. 2-5. The established instrument numbers and symbols are printed in the first column, the previous resistance and ratio readings entered in the second and third columns, and the remaining columns provide space for recording the current measurements. By placing duplicate sheets in a clip board, suitably offset and with a sheet of carbon paper between, the readings recorded during one series of observations are printed on the second sheet as "previous readings" for the next series of observations. The value of having the previous readings readily available lies in the opportunity thus afforded the observed for quickly checking and comparing the current measurements, and unusual, excessive, or erroneous readings may be immediately detected. A second or check reading may then be made.

(2) Data Record Sheets. Individual data record forms should be provided for each separate embedded instrument. These sheets provide a place for recording the location of the instrument, original and corrected calibration constants, lead resistances, temperature correction equations, zero resistance and ratio readings, and any other pertinent instrument characteristic. Reduction and conversion of the indicated readings to the desired units of stress, strain, temperature, joint movement, or pore pressure is made on this data sheet. Sample sheets suitable for the various types of Carlson instruments are given as plates No, 2-6 to 2-10 inclusive.

b. Protection of Accumulated Data.

(1) Transfer of Data. The measurements recorded on the field reading sheets should be transferred to the individual data record forms with the least practicable delay after each set of readings are made. Transcribing of these data should be carefully done, and checked at least once in order to reduce the possibility of errors. Utilizing data record forms in this manner eliminates the necessity for exposing the only copies of accumulated readings for each instrument to the possibilities of loss or damage while making observations under job conditions. The practice of using field books for recording the readings is not recommended, since column headings and instrument numbers must be inserted by the observer, and considerable irreplaceable data are taken onto the job for each set of readings (frequently before the results have been transferred to data record forms).

(2) Filing Field Reading Sheets. After the readings have been transferred to data record forms, field reading sheets should be retained in the field office until analysis of the collected data has progressed to a point where any questionable readings have been detected and checked against the original recorded values.

(3) Filing Data Record Sheets. As each individual data sheet is completed it should be forwarded to the office where the analysis is to be accomplished. This practice will provide additional protection against loss or destruction of accumulated data, since the original field reading sheets will be retained in the field office.

2-25. Reading Schedules.

a. General. Initial readings must be made within three hours after embedment of the instruments and continued at frequent intervals during early ages in order to measure the rapid volume, stress, and temperature changes resulting from hydration of the cement. After maximum temperatures have been attained the observation frequency may be reduced, since volume, stress, and temperature change more slowly during the cooling-off period. A further reduction in reading frequency is permissible after much of the heat of hydration has been dissipated and the structure is responding to normal climatic and load cycles. In the interest of simplicity in establishing a reading program it is generally advisable to refer progressive decreases (or increases) in observation frequencies to "days after embedment" for each instrument rather than stages of temperature or heat loss. The recommended duration of the various reading frequencies are intended to represent minimum requirements and to serve as a guide in establishing a reading program. In practice, changes in observation frequencies for some instruments are deferred until such time as the change may be made simultaneously for a large number of instruments.

b. Strain Meters. A normal program consists of an initial reading made between 1 to 3 hours after embedment, readings twice daily for 3 days, once daily for the next 12 days, twice weekly for the next 4 weeks, weekly during the remainder of the construction period, and twice each month thereafter.

c. Boundary Strain Meters. The observation program for boundary meter groups would be similar to the normal program, except that the twice daily readings should be continued for the first 15 days after embedment.

15 Sep 80

d. Joint Meters. Joint movements usually occur slowly and over extended periods of time. A normal program would consist of an initial reading between 1 and 3 hours after the meter is covered, then weekly during the remainder of the construction period, and twice each month thereafter.

e. Stress Meters. The normal observation program for stress meters may be similar to that described for strain meters.

f. Pore Pressure Cells. Hydrostatic pore pressures within concrete develop slowly, and occur only when a hydraulic head is sustained for an extended period against the concrete surface. The normal pore pressure cell reading program includes an initial reading at 1 to 3 hours after embedment, subsequent readings at weekly intervals after the reservoir reaches the level of the instruments until the operating pool elevation has been attained, and twice monthly thereafter.

9. Thermometers.

(1) General. The normal observation program as described for strain meters should be followed for all embedded thermometers except those specifically covered hereinafter.

(2) Thermometers in Foundation Rock. An initial reading should be made as soon as the instruments are installed, and continued at daily intervals until the first concrete lift is placed above their location. Subsequent observations should conform to a normal program generally applicable to thermometers.

(3) Thermometers Adjacent to Horizontal Lift Surfaces. The primary purpose of thermometers located at various depths within a concrete lift is to establish temperature gradients and heat losses during the exposure interval. Thermometers located in lifts placed under nominally continuing concrete operations (exposure interval of only several days between successive lifts) should begin at 1 to 3 hours after placement, and continue at twice daily intervals (or a continuous record secured from strip chart recorders) until no significant temperature gradient exists within a single thermometer group. At that time observations may be terminated on all instruments except one, and this selected typical thermometer incorporated in the long-time temperature observation program for the structure.

(4) Thermometers in a Top Lift. Where a vertical line of thermometers is located in a top lift which is to be exposed for an extended period of time (such as during the suspension of construction over the winter season or during concrete operations in other stages) the observation program should consist of the usual early initial reading, twice daily readings for 10 days, and daily readings over the remainder of the exposure period. After the covering lift is placed, the daily readings should be continued until such time as a reasonably uniform vertical temperature gradient exist through the previously exposed lift. Observations may then be terminated on all instruments except one in the group.

(5) Thermometers Adjacent to Bulkhead Faces. An adequate reading program will usually consist of the initial observation at 1 to 3 hours after embedment, twice daily readings for a period of 15 days, and at daily intervals thereafter until concrete in the adjacent block has reached an elevation above the thermometer group level and no significant temperature gradient exists within the group. One instrument may then be selected, if desired, to be incorporated in the thermometer pattern for the monolith and observations of the remainder of the meters terminated.

(6) Thermometers Adjacent to Exterior Faces. The normal reading program followed for interior thermometers will be satisfactory, with the exception that the twice-daily observations be continued for the first 15 days after embedment.

h. Special Stress, Strain, and Temperature Readings. In order to determine the effect of daily cyclic or other comparatively sudden climatic changes, and extremes of ambient air temperature on the development of stress, strain, or temperature gradients within a structure, several series of continuous readings (of up to two days duration) should be made on instruments located near exposed surfaces. Each set will consist of test set readings (or a strip chart temperature record if automatic equipment is used with thermometers) at 3 or 4 hours intervals over a 48-hour period. These observation series are usually made in pairs, during the spring and the autumn seasons to define the maximum range in daily temperature cycles and during the winter and summer seasons to coincide with the extremes of air temperatures. Similar types of observations are also made on embedded instruments adjacent to insulated surfaces to measure the effect of such insulation.

1. Extended Reading Schedules. Reading schedules can be extended to once monthly or even once quarterly after a sufficient amount of time has elapsed to verify that the change in reading will only be small between the specified time interval. However, if extended reading schedules are utilized and any abnormal occurrence should happen, readings should be made immediately and the reading schedule should return to that used for a new gage.

2-26. Field Reduction of Data.

a. Field Office Preparation. The term "reduction of data" refers to the arithmetical operations necessary to convert individual instrument readings into significant units of stress, strain, temperature, length, or pressure. It is desirable that these operations be performed in the field office in order that possible reading errors may be detected as soon as possible, explanations for apparently unusual results more readily and promptly secured, and preliminary results made available for use by project engineers at an early date. The practice of deferring office calculations for several months until construction work slackens or having the data reduction work accomplished at other than the project office, should be avoided.

b. Required Calculations. Reduction of data calculations required for Carlson-type instruments includes one or more of the following general operations: calculations of meter temperature, application of the calibration constant to the measured resistance ratio, and correcting the indicated results for the effects of temperature changes in the concrete and in the meter. Step-by-step explanation of these procedures is given on plates No. 2-6 through 2-10 for the several Carlson instruments. Specific examples of the transfer of raw data to finished numbers of strain, stress, pressure, and movement are given in Plates 2-11 through 2-14.

c. Personnel. On large and important instrumentation installations a field group should be established, under the project engineer, to carry out the functions of preparation, calibration, and installation of the instruments, making subsequent observations, reduction of the collected data, and the collection of additional related data as required. The group should be headed by an engineer with a civil, structural, or electrical background, whose primary duty will be the prosecution of the instrumentation program. A short period of supplementary training for this instrumentation group leader in the District Office Engineering Division, covering the purposes of the proposed instrumentation program, operational principles of the instruments, embedment practices, and observation program is recommended in order to assure a successful structural behavior investigation study. The remainder of the group will consist of personnel whose primary duties are in connection with inspection or laboratory activities, but may be made available to the extent required for the preparation and embedment of the meters and for making subsequent observations.

15 Sep 80

(1) Extensive Installations. A field group for an extensive instrumentation installation will likely require one or two full-time group leaders, a full-time electrician, and three or more junior engineers or concrete technicians for part of the time. Supplementary unskilled labor will be needed during embedment operations. Preparation of the instruments, cable splicing, and installation of indicating and recording equipment is done by the electrician and the engineers make the calibration checks on the instruments and do the actual placement.

(2) Small Installations. Where the number of instruments is comparatively small, and where embedment procedures are simple, one engineer or capable technician will be able to carry out alone all the work incident to preparation, installation, and reading of the meters.

d. Office and Working Space. To support a major instrumentation program (800 to 1000 or more instruments), about 300 sq ft of laboratory and shop working space should be provided, consisting of work benches, storage cabinets, shop facilities, and office space solely for use in connection with the instrumentation program. For small installations, the project laboratory facilities will normally be adequate.

Section IV: Other Stress-Strain Type Transducers

2-27. General. The gages described in the following paragraphs are various stress-strain type instruments that have been used in recent years to perform specialized tasks. The majority of the gages are electro-mechanical; however, some are purely mechanical type gages. Some of the gages are more sensitive than previously described stress-strain gages and may not be suitable for long-term exposure type of monitoring tasks.

2-28. Strain Measuring Instruments.

a. Types. Two types of gages are generally used for measuring strains: surface gages and internal or embedded gages. These types can be further divided into short- and long-term gages, depending on the duration of measurements. Usually short-term strains are best measured by electrical type gages, while some long-term strains (e.g., creep and shrinkage) can be conveniently measured using detachable mechanical gages. Some of the gages used for measuring strain in structures are described below.

b. Whittemore Mechanical Strain Gage.

(1) Description. This is a universally accepted gage for measuring long-time static strains on structures. Strain is derived essentially from measuring changes in distances between attached reference points on the structure. Reference points are located on the structure by bonding contact seats to the surface of, or by drilling holes in the structure wall and embedding inserts for supporting contact seats. The Whittemore gage shown in Figure 2-19 has conical points which are seated in small holes in the reference points when strain measurements are made. The dial attached to the gage indicates the positions of the two reference points from which the strain is obtained before and after the stressed condition. The gage has a gage length of 10 in. and readings to one ten-thousandth of an inch (0.0001 in.) can be made. This gage and its accessories are available from Soiltest, 2205 Lee Street, Evanston, Illinois 60602.

(2) Calibration and Gage Accuracy. An invar master bar, shown in Figure 2-20, with stainless steel inserts is used for standard measurements. The gage kit includes: brass inserts; contact seats; invar master bar; and strain gage punch bar for accurately locating inserts. Repeatability of this gage is generally found satisfactory if the same operator always reads the gage. With care taken, the operator can repeat a measurement of 0.0001 in. The gage readings are linear over the 0.200-in. range. The indicator is accurate to 0.0005 in.

EM 1110-2-4300
15 Sep 80

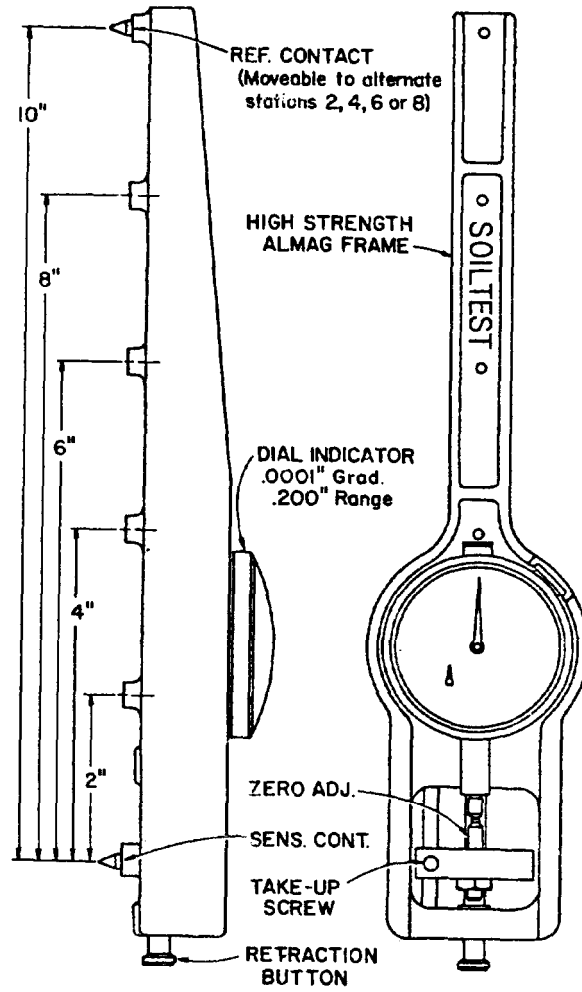

Figure 2-19. Whittemore Type Mechanical Strain Gage (Courtesy of Soiltest, Inc.).

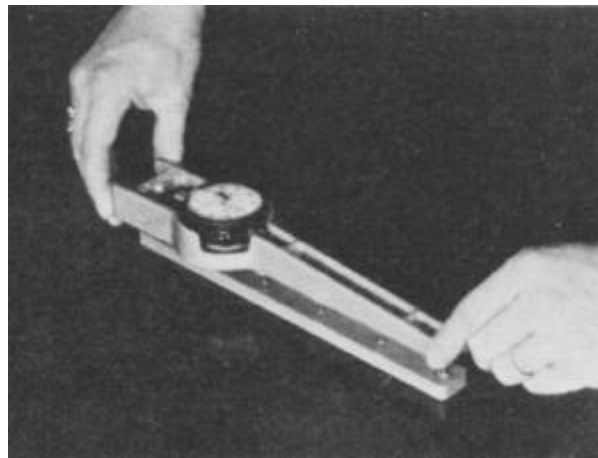

Figure 2-20. Whittemore Type Strain Gage in Position on Invar Master Bar (Courtesy of Soiltest, Inc.).

15 Sep 80

c. Mechanical Scratch Gage.

(1) Description. The temperature compensated, self-contained scratch gage measures strains or tiny movements that occur in most structures. In this scratch gage, a tiny arm carrying a recording scribe serves as a gage point. The scribe sharply scratches the amount and direction of deformation on a round, polished-brass recording head or "target" which is the opposite gage point. The gage is attached to structures with clamps, drive screws or adhesives. Recordings can be made over long periods of time, yet it easily records rapid events. The gage operates accurately in the open within a temperature range of -67°F to 1000°F . It also works well under water and is not affected by pressure. It is very durable and can be used over and over. The gage accuracy is determined by the reading equipment. The strain can be determined from the scribed disk using a calibrated eyepiece or microscope.

(2) Principle of Operation. As shown in Figure 2-21, the circular target is held in place by two tiny rollers and two stainless steel brushes. The long driver brush is made up of small wires. One end of the long brush is fixed to the small base plate and the other end terminates in a peripheral groove of the target. It is guided and supported between these two points through a small bent tube. A short wire brush engages the target groove adjacent to the long driver brush and is fixed on the other end to the large base plate. The short brush holds the circular target firmly against the rollers to eliminate false readings due to play. When tensile strain occurs, the two base plates move apart causing the scribe to scratch the disk (Figure 2-22), recording the total strain. When the strain is relieved, the target automatically rotates, allowing separation of each tensile strain. When compressional strain occurs, the two base plates move together, causing the scribe to scratch the disk in the opposite direction. The longer driver wires engage the surface of the target groove, causing the target to rotate. The shorter brush prevents reverse or clockwise rotation.

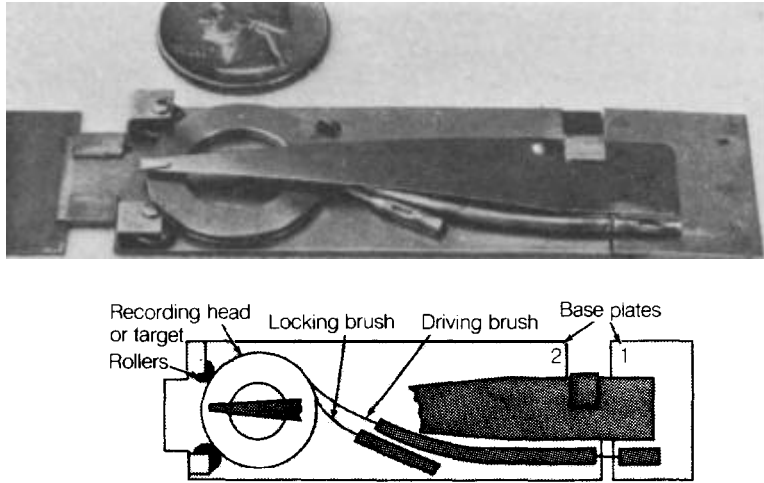

Figure 2-21. Mechanical Scratch Gage (Courtesy of Prewitt Associates).

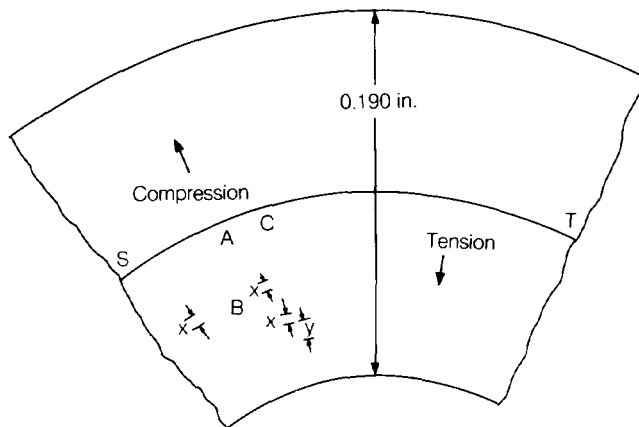

Figure 2-22. Typical Scratch Representation (Courtesy of Prewitt Associates).

d. Embedable Strain Gages.

(1) Principle of Operation. Recent developments in the technology of strain gages have produced lightweight embedment type strain gages that are suitable in mass concrete. The transducers operate on the principle that the resistance of a wire varies directly with strain in tension or compression. Figure 2-23 shows an embedable strain gage manufactured by Ailtech, a Cutler Hammer Company, 19535 E. Walnut Drive, City of Industry, California 91748. The Ailtech gage consists of a short length of nickel-chromium, platinum-tungsten, or similar alloy wire which has been electro-formed or etched so that a sensitive element is formed. The wire is insulated by highly compacted magnesium oxide powder and encased in a small diameter tube made of stainless steel, aluminum, titanium, Inconel or gold alloy. The gage has two end flanges which serve to anchor it in the concrete at the location where strain is to be read. Embedment techniques should be similar to those used to embed the Carlson instruments outlined in Appendix C.

(2) Gage Properties. The temperature compensated embedable strain gage is suitable for measurements of tensile or compressive strain levels to 6000 microinches per inch over extreme temperature ranges. It is completely hermetically sealed and waterproofed with mechanical protection from the gage to the flexible waterproof cable. The gages can be obtained with both quarter and half bridge, 60, 120, or 360 ohm active units. Standard bridge completion network and power supply can be used with these gages.

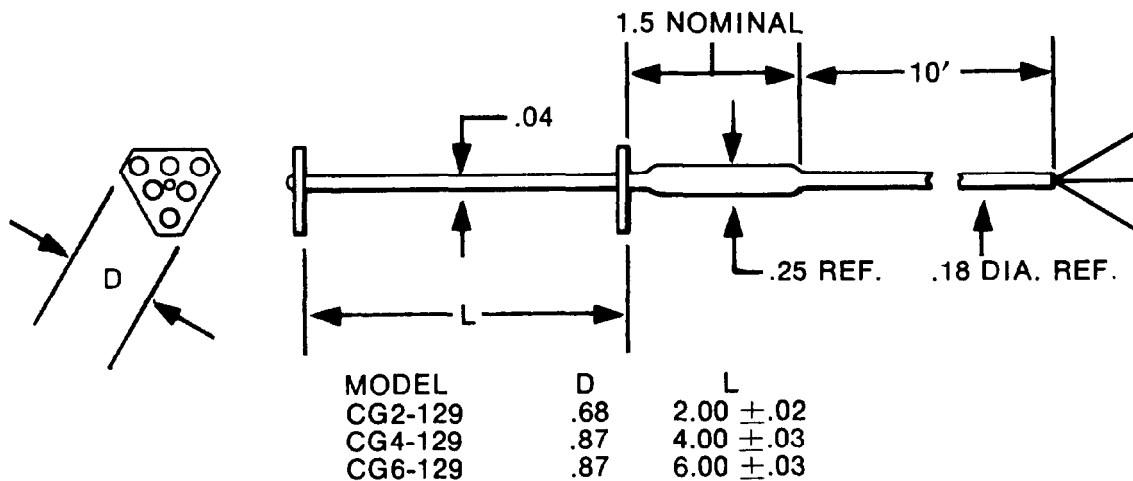

Figure 2-23. Ailtech Embedable Strain Gages (Courtesy of Ailtech).

15 Sep 80

e. Vibrating Wire Strain Gage.

(1) Principle of Operation. A vibrating wire strain gage consists of a pretensioned fine steel wire clamped between two end flanges and enclosed in a stainless steel or acrylic tube. The end flanges can be welded or bolted to the surface of a structure or can be cast in place in concrete. Forces acting on the structure produce strains which introduce relative movements between the end flanges and thus a change of tension in the steel wire. A dual purpose electromagnetic coil is mounted in the gage housing, adjacent to the wire, and is electrically coupled to the measuring equipment by a flexible cable. A current pulse, generated by the measuring equipment, energizes the coil, thus plucking the wire and causing it to vibrate at a natural frequency determined by the tension in the wire. The vibrating wire, in turn, induces an ac voltage in the coil with a frequency corresponding to that of the vibrating wire. The frequency of the coil output voltage is sensed by the measuring equipment. The fundamental natural frequency of a stretched wire is given by

$f = \frac{1}{2\ell} \sqrt{\frac{T}{M}}$ (where ℓ is the length of the wire between the clamps; T, its tension; and M, its mass per unit length).

(2) Advantages. The main advantages of the vibrating wire meter are: good long-term stability; high sensitivity; unaffected by cable lengths; and relatively insensitive to moisture and resulting electrical ground leakage. Figure 2-24 is a picture of a typical vibrating wire gage.

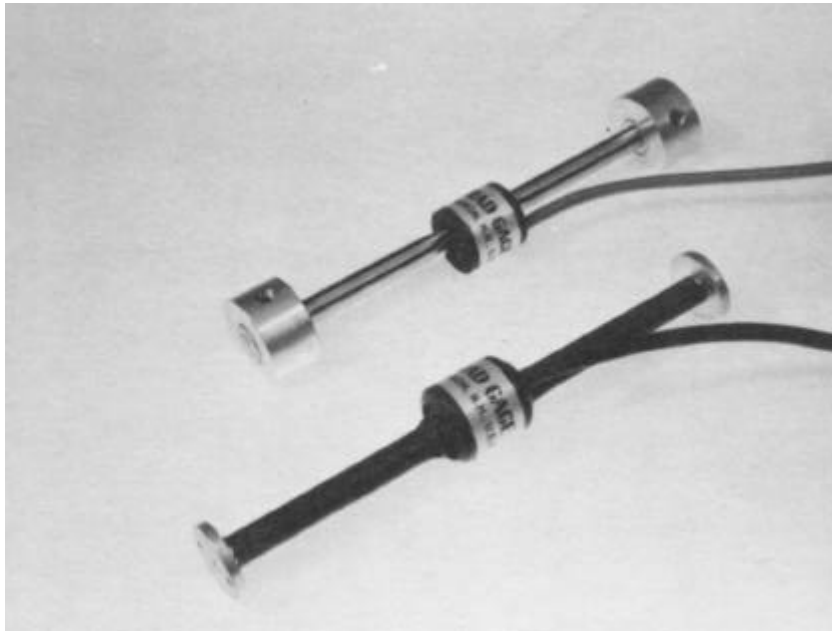

Figure 2-24. Vibrating Wire Strain Gages (Courtesy of Irad Gage, Inc.).

15 Sep 80

(3) Reading Equipment. Solid state portable digital readout instruments are available for use with the vibrating wire gages. Irad Gage, 14 Parkhurst St., Lebanon, New Hampshire 03766, manufactures both vibrating wire gages and readout devices, as do other geotechnical instrumentation manufacturers. The Irad readout box operates by initially generating a voltage pulse containing a spectrum of frequencies spanning the natural frequency range of the wire. When the signal reaches the coil/magnet assembly mounted inside the gage and when one of the input frequencies coincides with the natural frequency of the wire, the wire vibrates and continues to vibrate after the input signal has ceased. A voltage is then generated in the coil at a frequency corresponding to that of the wire as it vibrates in the field of the coil/magnet assembly. This constant frequency signal generated by the gage is timed by a precise quartz clock in the readout meter and the time displayed digitally.

(4) Operation. To obtain useful readings, the operator: connects the gage; sets a switch to one of two positions corresponding to gage type; and depresses the "read" button. The readout appears in the display window and flashes on and off as the instrument constantly checks the reading.

f. Monfore Standardizing Strain Gage. Figure 2-25 shows the Monfore gage mounted on the surface of a structure. The gage consists of a tube, a piston fitted into one end of the tube, and a small diameter elastic wire stretched inside the tube from the piston to the other end of the tube. The wire is adjusted so that it is under slight tension when the piston is in its normal position with the piston shoulders in contact with the end of the tube. The tube and piston assembly is attached to the structure by means of insert 1. Insert 2 located at distance L from insert 1, serves as a stop for the outward movement of the piston, which is caused by the application of 16 psi air pressure within the tube. The gage measures strain by monitoring changes in length L. From Figure 2-25, $L = s + d$, where s is the length of the standard and d is the total movement of the piston from the standard position s to insert 2. The change in the electrical resistance of the elastic wire as the piston is moved outward from the standardizing position until it contacts insert 2 is used to compute d. The strain of the material under test is finally computed from d/L . Since the resistance wire is not permanently stressed, creep does not affect the measurement. The range of the gage is about 3000 microstrains with a resolution of a few millionths of an inch. A standard Wheatstone bridge circuit can be used for resistance measurements.

15 Sep 80

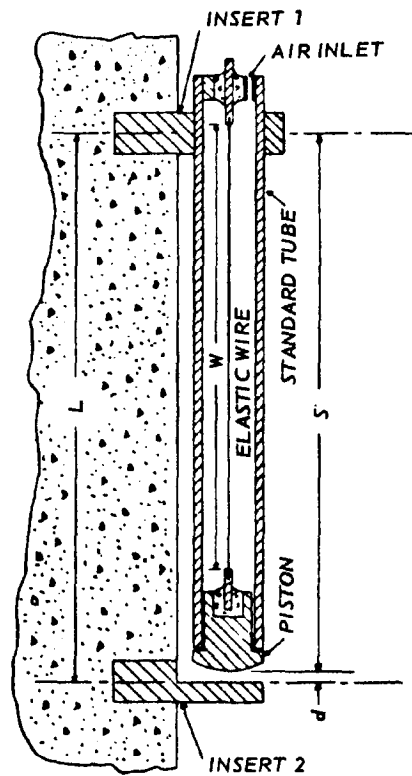

Figure 2-25. Monfore Standardizing Strain Gage. (Prepared by WES)

2-29. Linear Variable Differential Transformers.

a. Description. The linear variable differential transformers (LVDT) is a small electrical device that can be used for the measurement of displacement and strain. The unit can be used for measuring strain over a certain gage length or to measure displacement by using suitable attachments. The LVDT is an inductive device. Its only movable part, a permeable or ferromagnetic core, develops a variable coupling between the primary and the two secondary windings. The position of this core varies the voltage induced into each of two identical secondaries connected in series opposed fashion. When the core is moved off-center, a differential voltage will appear across the secondaries. The voltage is a linear function of displacement. The WES low modulus inductive strain meter, shown in Figure 2-26, utilizes an LVDT mounted in a cylindrical tube with two end plates. The gage is designed to monitor very early strains in fresh concrete as well as long-term strains.

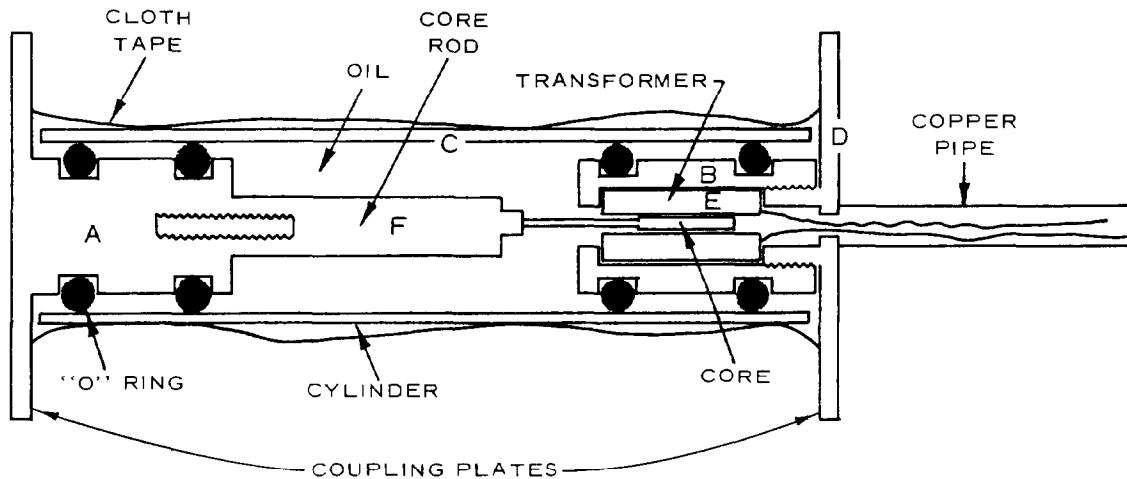

Figure 2-26. Low Modulus Linear Variable Differential Transformer Strain Meter. (Prepared by WES)

b. Voltage Requirements. The gages are available in both direct current (dc) and alternating current (ac) models. The ac model requires an exciter-demodulator, which supplies regulated ac excitation (usually at a frequency of 1 K to 3 K hertz) to the transducer, demodulates the transducer output signal, and produces a filtered dc output signal precisely proportional to mechanical input, over the full plus and minus range of the transducer. The dc model requires a regulated dc input to a self-contained solid state oscillator and a phase-sensitive demodulator. The oscillator converts the dc input to ac, exciting the primary windings of the differential transformer. The voltage induced in the two secondary windings are connected to the demodulator consisting of a full-wave bridge and a RC filter. The resulting dc output is proportional to the core displacement from the electrical center. The polarity of the voltage is a function of the direction of the core displacement with respect to the electrical center.

2-30. Resistance Strain Gage. An electrical strain gage (resistance gage) is another device used to measure strain. It is constructed such that any strain in the body to which it is bonded is accompanied by a proportional change in the resistance of the gage. Resistance gages are used for many applications because they are versatile and offer many advantages over other gages; i.e., small size, light weight, ease of attachment, sensitivity to strain, usefulness for static and dynamic strain, low cost, and easy adaptability for remote recording. The readings from these gages, directly recorded by a strain indicator utilizing a Wheatstone bridge technique, can resolve strain as accurately as one microinch per inch. The main disadvantages of the resistance-type gages are: excessive electrical drift which occurs over a long period of time; and sensitivities to ambient variables. They are not a good choice for long-term embedment because of waterproofing difficulties. Resistance gages are used successfully, however, in the fabrication of commercial pressure gages.

2-31. Stress Measuring Instruments.

a. Stress Measurements. Stress measurements can be made both directly and indirectly. Whenever possible, direct stress measurements should be made. For some applications, i.e., detecting tensile stress, it may be necessary to measure other quantities, such as strain, and then compute stress. It is sometimes desirable to provide for some strain measurements for a check or back-up for direct stress measurements and for detecting tension. The stress meters considered here are the WES pressure gage, Gloetzel pressure cell, and the vibrating wire stress gage.

b. WES Pressure Gage. The principle of operation of the WES pressure gage is similar to that of the Carlson stress meter. The diaphragm in the WES meter, shown in Figure 2-27, is filled with oil (5) rather than mercury and a bonded strain gage (7) is used to measure the deformations of the central flexible portion (6). A dummy gage (9) mounted on a free cantilever (8) serves for temperature compensation. The measuring technique for this gage is essentially the same as for any strain gage network consisting of two active arms (active strain gage and temperature compensating gage). Length of cable and effects of temperature on cable need to be taken into consideration. Like the Carlson stress gage, the WES gage is not suitable for tension measurements.

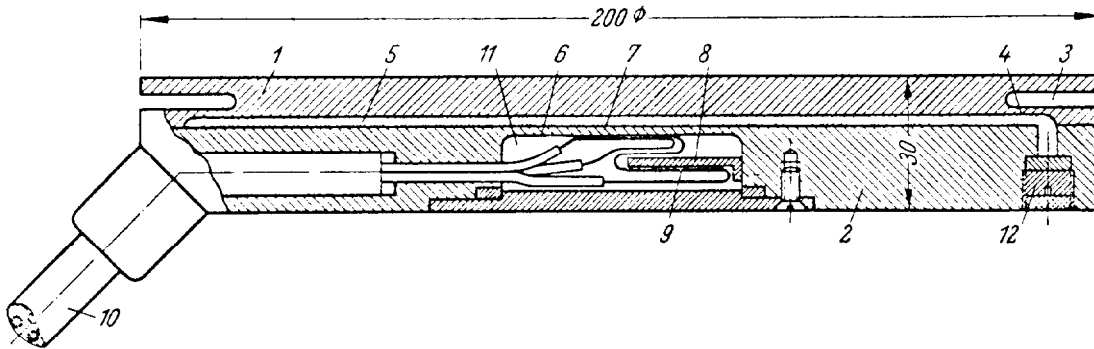
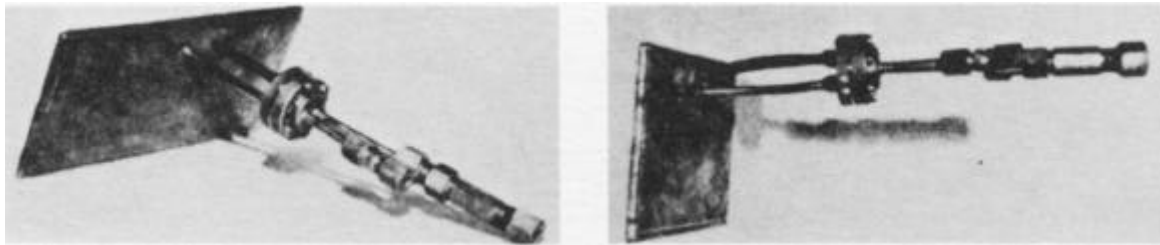
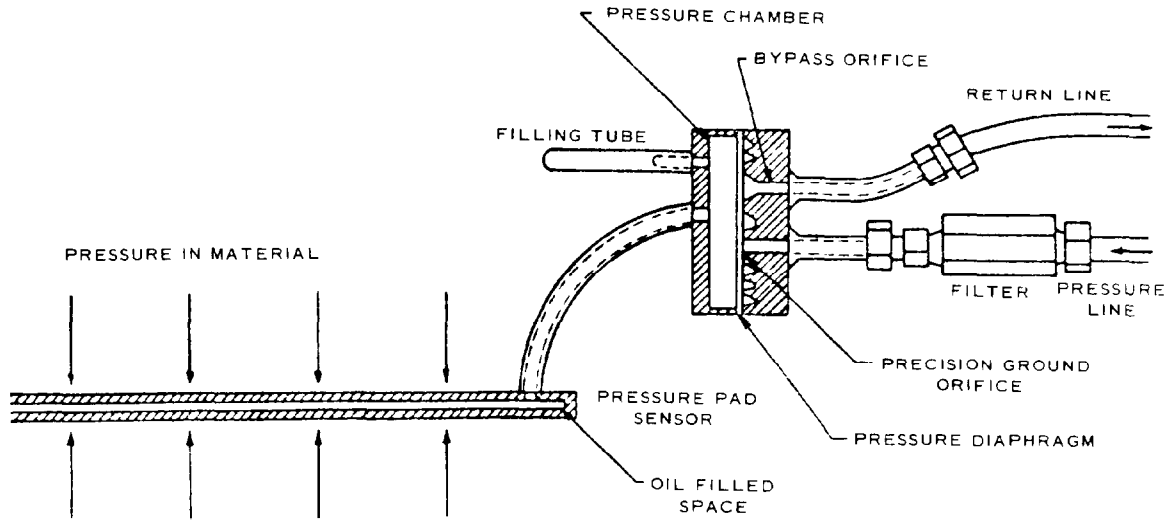

Figure 2-27. WES Pressure Gage. (Prepared by WES)

e. Gloetzel Pressure Cell.

(1) Description. The Gloetzel pressure cell is a hydraulic, direct stress measuring system based on the principle of a bypass valve. The meter, shown in Figure 2-28, consists of two disks welded together around their outer diameters. The inward-facing surface of one of the disks has circular and radial grooves. Since the disks lie against one another, a force can be transmitted through them without bending. The grooved disk has a bypass valve opening and a pressure line inlet opening. The cell is maintained in a closed configuration by the action of pressure on the sensing pad. To measure the magnitude of the pressure on the sensing pad, the hydraulic pressure in the cell delivery line is slowly increased at a constant rate. When the delivery pressure becomes equal to the pressure acting on the cell, the valve system opens, bypassing hydraulic fluid to the cell return lines. The pressure at which bypass occurs is indicated by a precise readout instrument in the delivery line.



CONCRETE STRESS CELL

- Size - 2-3/4" x 5-1/2" x 3/32"
 and 4" x 8" x 3/32"
 (others on request)
- Measuring Range - 0 - 3570 psi
- Sensitivity - 0.15 psi
 1.5 psi

Figure 2-28. Gloetzel Pressure Cell. (by WES, after Terrametrics)

(2) Capabilities. The Gloetzel pressure cell operation is completely hydraulic having long-term reliability. It is a relatively low cost instrument requiring only simple readout equipment, i.e., manometer. It enables the determination of the actual stress developed in structures, e.g., concrete-stress, soils pressure, pore pressure, and total water-pressure over the measuring range of 0 to 3750 psi. It is unaffected by strains due to shrinkage, creep, and cyclic loading, especially in concrete. With minor corrections for temperature, line friction, and elevation differences between the cell and the manometer, the manometer pressure is equivalent to the pressure acting on the cell.

e. Vibrating Wire Stress Meter.

(1) The vibrating wire stress meter manufactured by Irad Gage (Figure 2-29) has been designed to monitor stress changes in rock, coal, or concrete under the most adverse environmental conditions. When pre-stressed into a 1-1/2-in. borehole, the cylindrical gage can sense stress changes of as little as 2 psi. The stress changes act on the gage and alter the period of the resonant frequency of a highly tensioned steel wire clamped diametrically across the gage. Because the stress meter is rigid compared to the surrounding material, conversion of the frequency readings to stress changes do not require accurate knowledge of the media modulus. Calibration charts are supplied with the gages.

(2) The stress meter can be installed in dry or water-filled boreholes at depths of up to 100 ft. It is set by means of a manually or hydraulically operated setting tool that pulls a wedge in between the gage and a platen. Like the vibrating wire strain meter, contact resistance, leakage to ground or signal cable lengths do not influence the gage readings and the signal cable needs only to be continuous in order for a reading to be made. Signal cable lengths up to a mile can be used. The frequency readings are obtained with a portable digital readout meter. Gages can be obtained for maximum readings to 10,000 psi.

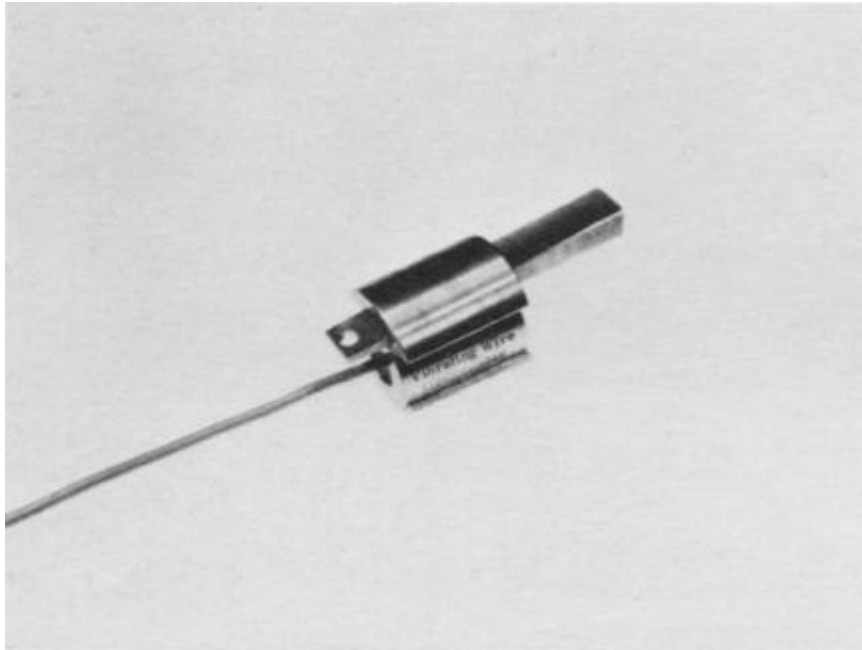
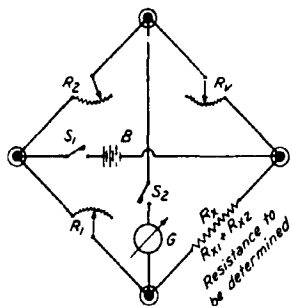

Figure 2-29. The IRAD Vibrating Wire Stressmeter (Courtesy of Irad Gage, Inc.).

2-54



WHEATSTONE BRIDGE, $\frac{R_3}{R_2} = \frac{R_4}{R_1}$

NOTE:
Carlson Bridge, $R_1 = R_2 \dots R_x = R_y$

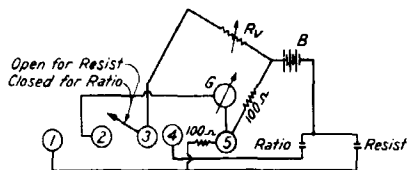
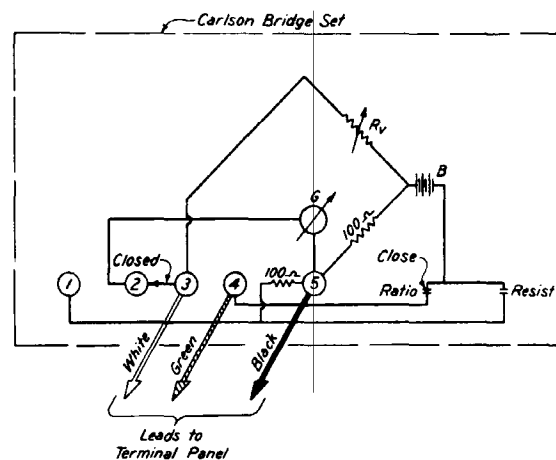
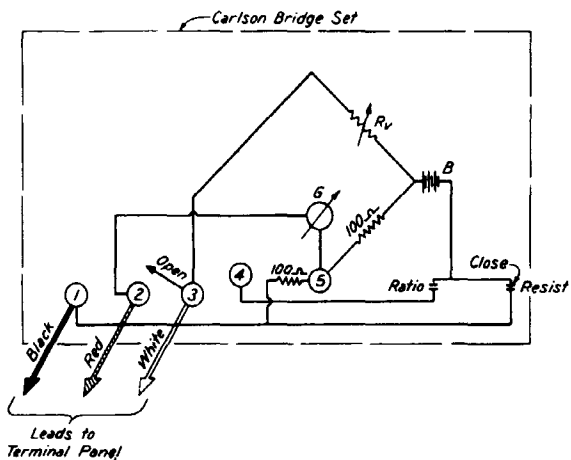

CARLSON BRIDGE

NOTE:
When switch between 2 and 3 is closed,
bridge will balance with a 50 Ω resistance
between 1 and 3 showing maximum of
50.02 on R_v . Order of error = $\pm 0.02 \Omega$

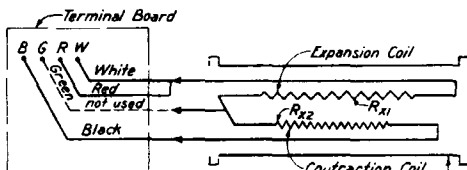

STRAIN METER

RESISTANCE MEASUREMENT

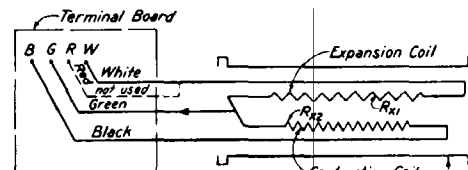

STRAIN METER

RATIO MEASUREMENT

Reproduced through the courtesy
of the Tennessee Valley Authority
from unpublished report entitled
"Fontana Dam - Preparation and
Installation of Special Measuring
Instruments."

MANUALS - CORPS OF ENGINEERS
U. S. ARMY
ENGINEERING AND DESIGN
INSTRUMENTATION FOR MEASUREMENT OF STRUCTURAL
BEHAVIOR OF CONCRETE GRAVITY STRUCTURES
WIRING DIAGRAMS FOR CARLSON INSTRUMENTS
SHEET 1 OF 2
EM 1110-2-4300

PLATE 2-1

Plate 2-1

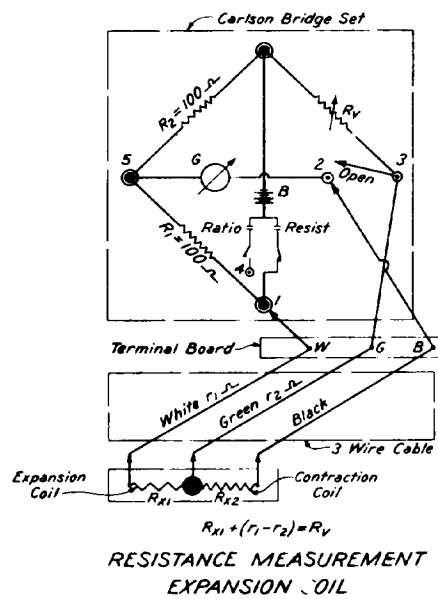
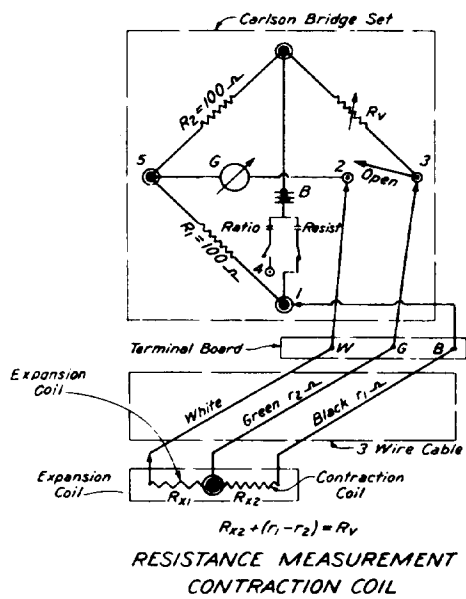
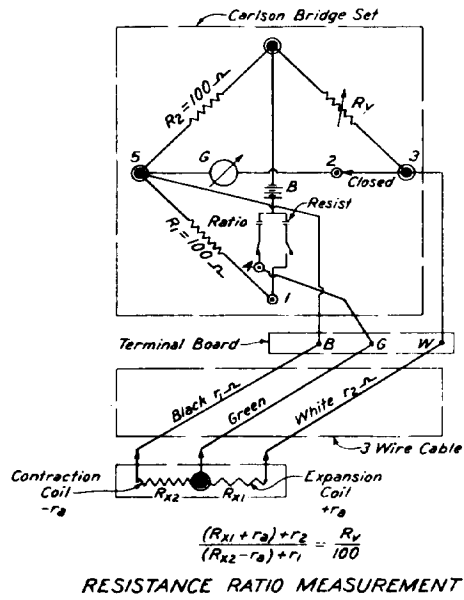
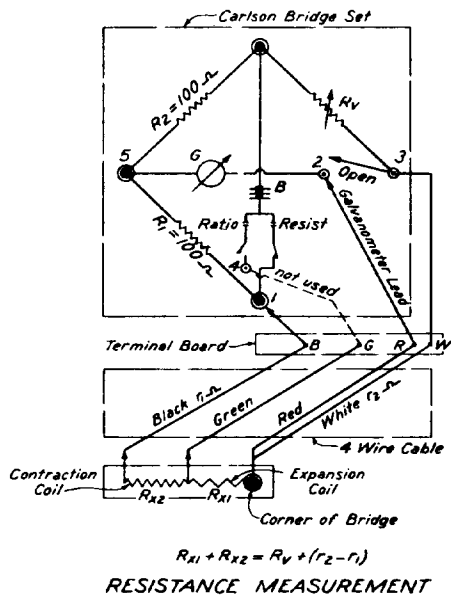

SYMBOLS:

- Corners of Bridge
- 3 Corners of Bridge & Terminal Post
- 2 Terminal Post

Reproduced through the courtesy of the Tennessee Valley Authority from unpublished report entitled "Fontana Dam - Preparation and Installation of Special Measuring Instruments"

MANUALS - CORPS OF ENGINEERS
U. S. ARMY
ENGINEERING AND DESIGN

INSTRUMENTATION FOR MEASUREMENT OF STRUCTURAL BEHAVIOR OF CONCRETE GRAVITY STRUCTURES
WIRING DIAGRAMS FOR CARLSON INSTRUMENTS
SHEET 2 OF 2
EM 1110-2-4300

PLATE 2-2

MEASUREMENTS TAKEN TO CORRECT INSTRUMENT CALIBRATIONS

Carlson Number	Wire resistances				Coll resistances at splice					Coll resistances at end					Ratio at splice	Ratio at end	Temperature
	Red	Black	White	Green	G W	G B	B W	B W G	W B G	G W	G B	B W	B W G	W B G			
1	0.40	0.40	0.38	0.40	38.58	37.55	76.03	37.51	38.53	39.37	38.36	76.78	37.51	38.51	1.0274	1.0264	75.98
2	.46	.46	.44	.46	38.43	38.16	76.47	38.12	38.38	39.38	39.14	77.49	38.15	38.39	1.0062	1.0062	76.53
3	.57	.54	.52	.54	37.97	37.67	75.53	37.62	37.92	39.04	38.76	76.58	37.62	37.90	1.0077	1.0071	75.48
4	.88	.91	.87	.92	38.34	37.96	76.23	37.93	38.32	40.19	39.84	78.11	37.92	38.28	1.0102	1.0093	76.28
JM-34	.42	.39	.38	.40	27.61	28.05	55.49	28.02	27.59	28.41	28.87	56.35	28.02	27.57	.9841	.9839	55.57
-31	.79	.79	.81	.83	27.66	28.29	55.81	28.26	27.63	29.33	29.95	57.47	28.23	27.61	.9775	.9786	55.82
21	.14	.14	.14	.14	27.09	27.76	54.67	27.73	27.06	27.38	28.05	54.99	27.73	27.06	.9755	.9756	54.71
25	.24	.24	.24	.24	27.34	27.82	54.97	27.78	27.31	27.85	28.34	55.52	27.78	27.31	.9827	.9827	55.01
36	.62	.62	.62	.62	28.08	28.57	56.48	28.54	28.06	29.34	29.82	57.75	28.54	28.06	.9829	.9831	56.50
43	.87	.88	.87	.87	26.97	27.52	54.34	27.50	26.94	28.73	29.29	56.15	27.51	26.94	.9794	.9799	54.38
46	1.23	1.23	1.18	1.23	27.36	27.48	54.69	27.45	27.33	29.77	29.95	57.11	27.44	27.26	.9952	.9937	54.67
144	.37	.38	.36	.38	34.17	33.74	67.82	33.72	34.14	34.94	34.53	68.63	33.72	34.13	1.0126	1.0119	67.86
2	.38	.39	.39	.40	33.38	32.92	66.28	32.96	33.34	34.20	33.82	67.13	32.95	33.34	1.0114	1.0116	66.33
19	-----	.40	.39	.38	32.69	32.64	65.23	32.62	32.67	33.50	33.45	66.11	32.64	32.68	1.0015	1.0014	-----
38	-----	.39	.39	.38	33.06	33.02	65.98	33.00	33.03	33.87	33.83	66.87	33.02	33.06	1.0009	1.0009	-----
26	-----	.39	.38	.37	33.59	33.71	67.24	33.68	33.56	34.38	34.39	68.03	33.69	33.57	.9964	.9964	-----
22	-----	.39	.39	.38	33.51	33.29	66.70	33.26	33.47	34.29	34.09	67.54	33.27	33.48	1.0061	1.0061	-----
131	.29	.29	.29	.29	33.54	33.60	67.04	33.58	33.50	34.14	34.22	67.71	33.58	33.51	.9978	.9978	67.11
141	-----	.31	.31	.30	33.88	33.26	67.08	33.23	33.85	34.52	33.90	67.73	33.24	33.86	1.0186	1.0185	-----
147	-----	.30	.30	.29	33.69	33.51	67.14	33.48	33.67	34.33	34.14	67.80	33.50	33.69	1.0056	1.0054	-----

(Prepared by WES)

2-56

Plate 2-3

COMPUTATION OF CALIBRATION CORRECTIONS CARLSON-TYPE INSTRUMENTS

	Carlson number	Original calibration constant	Resistance at instrument	Resistance at end	Corrected calibration constant	Given resistance at 0° F.	Resistance				Corrected resistance at 0° F.	Given temperature factor	Corrected temperature equation	Notes
							White wire	Black wire	Green wire	Correction				
		(1)	(2)	(3)	(1)×(3)/(2)	(R0)					(R0)	(° F./ohm)		
Stress meters	1	5.6 psi	76.03	76.78	5.66 psi	66.08	0.38	0.40		0.02	66.10	7.84	t = (R _t -66.10) 7.84	4-cond. cable.
	2	5.4	76.47	77.49	5.47	66.40	.44	.46		.02	66.42	7.80	t = (R _t -66.42) 7.82	Do.
	3	6.3	75.53	76.52	6.39	66.00	.52	.54		.02	66.02	7.85	t = (R _t -66.02) 7.85	Do.
	4	5.7	76.23	78.11	5.84	66.15	.87	.91		.04	66.19	7.83	t = (R _t -66.19) 7.78	Do.
Joint meters.	JM-34	.00053	55.49	56.35	.000538	48.36	.38	.39		.01	48.37	10.72	t = (R _t -48.37) 10.71	Do.
	JM-31	.00051	55.81	57.47	.000525	48.63	.81	.79		-.02	48.61	10.79	t = (R _t -48.61) 10.66	Do.
	JM-21	.00056	54.67	54.99	.000563	47.29	.14	.14		0	47.29	10.96	t = (R _t -47.29) 10.96	Do.
	JM-25	.00053	54.97	55.52	.000535	47.70	.24	.24		0	47.70	10.86	t = (R _t -47.70) 10.86	Do.
	JM-36	.00051	56.48	57.75	.000521	48.38	.62	.62		0	48.38	10.71	t = (R _t -48.38) 10.71	Do.
	JM-43	.00056	54.34	56.15	.000579	47.80	.87	.88		.01	47.81	10.84	t = (R _t -47.81) 10.84	Do.
Strain meters	JM-46	.00054	54.69	57.11	.000564	47.51	1.18	1.23		.05	47.56	10.91	t = (R _t -47.56) 10.90	Do.
	144	3.70	67.82	68.63	3.74	57.95	.36	.38		.02	57.97	8.94	t = (R _t -57.97) 8.94	Do.
	2	3.70	66.28	67.13	3.75	57.84	.39	.39		0	57.84	8.96	t = (R _t -57.84) 8.96	Do.
	131	3.75	67.04	67.71	3.79	57.90	.29	.29		0	57.90	8.95	t = (R _t -57.90) 8.95	Do.
	19	3.75	65.23	66.11	3.80	57.73	.53	.56	.57	.05	57.78	8.98	t = (R _t -57.78) 8.98	3-cond. cable.
	38	3.75	65.98	66.87	3.80	57.81	.33	.32	.32	-.01	57.80	8.96	t = (R _t -57.80) 8.96	Do.
	26	3.70	67.24	68.03	3.74	57.85	.68	.69	.68	-.01	57.84	8.96	t = (R _t -57.84) 8.96	Do.
	22	3.75	66.70	67.54	3.80	57.92	.12	.12	.13	.02	57.94	8.95	t = (R _t -57.94) 8.95	Do.
	141	3.65	67.08	67.73	3.69	57.96	.94	.97	.96	.01	57.97	8.94	t = (R _t -57.97) 8.94	Do.
	147	3.70	67.14	67.80	3.74	57.77	1.21	1.18	1.18	-.03	57.74	8.97	t = (R _t -57.74) 8.97	Do.

(Prepared by WES)

2-57

Plate 2-4

EM 1110-2-4300
15 Sep 80

_____ PROJECT
FIELD READINGS ON EMBEDDED INSTRUMENTS

Instr. No.	Previous readings		Date	Time	Resist.	Ratio	Obs.
	Resist.	Ratio					
T-1							
2							
3							
4							
5							
6							
7							
SM-1							
2							
3							
4X							
JM-1							
2							
3							
4							
5							
6							
PP-1							
2							
3							
4							
5							
6							
7							
8							

Reproduced through the courtesy of the Tennessee Valley Authority

15 Sep 80

_____ PROJECT
PORE PRESSURE CELL DATA SHEET

Pore pressure cell No. _____ Sheet _____

Location _____

Calibration data:

Meter resistance at (A)* ° F (B)* ohms.
 Change in temperature per ohm change in resistance (C)* ° F.
 Ratio at zero stress %.
 Original calibration constant (*) psi/.01 % ratio change.
 Calibration constant corrected for leads (D) psi/.01 % ratio change.
 Resistance of leads at ___ ° F ohms (pair).

1	2	3	4	5	6	7	8	9	10
Date	Time	Total resist., ohms	Lead ohms	Meter resist., ohms	Temp., ° F.	Resist. ratio, %	Change in ratio, %	Indicated hydrost. pressure, psi	Remarks

*Furnished by manufacturer.

EXPLANATION:

Cols. 3 to 7, inclusive—Similar to corresponding columns on stress meter data sheet. No temperature corrections are made; but the temperature data is of general interest and provides a possible means for detecting faulty operation of the strain-measuring units.

Col. 8—Total change in resistance ratio (column 7) from a selected initial value, usually the first reading after the concrete has hardened or at about 24 hours age. Proper algebraic sign should be shown.

Col. 9—Multiply values in column 8 by the corrected calibration constant (D). Negative values of the ratio changes (column 8) indicate positive hydrostatic pressures. Except for minor ratio variations prior to the development of significant hydrostatic pressures, the pore pressure cell will not respond reliably to negative pressures, and all entries in column 9 will represent hydrostatic pressures above the oil pressure in the cell chamber (approximately atmospheric).

(Prepared by WES)

PROJECT _____
STRESS METER DATA SHEET

Stress meter No. _____ Sheet _____

Location: _____

Calibration data:

Meter resistance at (A)*° F _____ (B)* ohms
 Change in temperature per ohm change in resistance _____ (C)* ° F
 Ratio at zero stress _____ %
 Original calibration constant _____ (D)* psi/.01 ratio % change.
 Calibration constant corrected for leads _____ (E) psi/.01 ratio % change.
 Resistance of leads at ___° F _____ ohms (per pair)
 Temperature correction = $-\frac{1}{E}(80T/D + 6.7)10^{-6} - K|E \cdot F$ $80T/D = \frac{1}{E} * - ; K = - ; F = \frac{1}{E} *$
 = $-\frac{1}{E}(10^{-6})$ psi per 1° F. temp. rise

1	2	3	4	5	6	7	8	9	10	11	12	13	14
Date	Time	Total resist., ohms	Lead resist., ohms	Meter resist., ohms	Temp., ° F.	Resist. ratio, %	Change in ratio, %	Indic. stress psi	Est. E. million psi	Corr. per ° F., psi	Total temp. corr., psi	Actual stress, psi	Remarks

*Furnished by manufacturer

EXPLANATION:

- Col. 3—Total resistance of meter as measured in field. With 4-conductor cable the meter resistance is measured directly, and this column may be left blank.
- Col. 4—Resistance of the white and black conductors, as measured directly during the splicing operations. Or a reasonably accurate value may be determined by subtracting the total resistance of the contraction and expansion coils measured in series from the sum of the resistances of the contraction and expansion coils measured separately.
- Col. 5—Resistance of meter excluding cable leads. It is obtained by subtracting column 4 from column 3. With 4-conductor cable the meter resistance is measured directly.
- Col. 6—Temperature of meter, obtained by subtracting (B) from the meter resistance in column 5, multiplying by (C), and adding to (A).
- Col. 7—The resistance ratio of the meter as measured with the test set.
- Col. 8—Column 7 minus the resistance ratio at zero stress. The "zero ratio" is determined by taking several readings during the first several hours after the meter is placed, and adopting a value which is representative. Since the concrete will be under little stress and highly plastic at this early age, the measured resistance ratios will vary but little from the zero stress ratio. Proper algebraic signs must be shown with the numerical values.
- Col. 9—Column 8 values multiplied by calibration constant E. Negative resistance ratio changes (column 8) are associated with the development of compressive stress, which, by custom, is considered a positive quantity.
- Col. 10—This column and the next two columns develop a correction for temperature to be applied to the indicated stress (column 9), which is necessary since the meter responds to stress resulting from differences in thermal expansion between the meter and the surrounding concrete. In column 10 is entered estimated values of the sustained modulus of elasticity of the concrete. This is a reduced modulus of elasticity which includes the effect of creep over the period of time covered by the temperature correction. A value of one-half of the ordinary modulus of elasticity is frequently used.
- Col. 11—Computed from the temperature correction equation given above, using a value for the thermal coefficient of expansion of the concrete obtained from laboratory tests or estimated from other data, and values of E from column 10.
- Col. 12—The net change in temperature from the initial reference temperature multiplied by column 11 values. Since the magnitude of the correction is usually small in comparison to applied or load stresses, precise values in columns 10 and 11 are not essential. The algebraic sign of the correction is significant, and signs of the temperature change and temperature correction must be observed.
- Col. 13—Actual stress, obtained by adding values in column 12 to values in column 9, observing the signs of the temperature corrections in column 12. A temperature rise causes the stress meter to expand more than the concrete (usually) and results in an indicated compression response by the stress meter in addition to any load-produced stress which may exist. An indicated compressive stress then must be reduced, and vice versa.

(Prepared by WES)

_____ PROJECT
STRAIN METER DATA SHEET

Strain meter No. _____ Sheet _____

Location _____

Calibration data:

- Meter resistance at (A)*° F..... (B)* ohms.
- Change in temperature per ohm change in resistance..... (C)* ° F.
- Original calibration constant..... (*) millionths/.01 % ratio change.
- Calibration constant corrected for leads..... (D) millionths/.01 % ratio change.
- Resistance of leads at ___° F..... ohms (pair).
- Temperature correction for meter..... (E)* millionths/° F.
- Concrete coefficient of thermal expansion..... (F) millionths/° F.

1	2	3	4	5	6	7	8	9	10	11	12	13	14
Date	Time	Total resist., ohms	Lead resist., ohms	Meter resist., ohms	Temp. ° F.	Resist. ratio, %	Change in ratio, %	Indicated unit length change, millionths	Correc-tion for meter expan-sion, mil-lionths	Actual unit length change, mil-lionths	Correc-tion for concrete expan-sion, mil-lionths	Actual strain, mil-lionths	Re-marks

*Furnished by manufacturer.

EXPLANATION:

- Col. 3 to 7, inclusive—Similar to corresponding columns on the stress meter data sheet.
- Col. 8—Total change in resistance ratio (column 7) from a selected initial value. This initial reference value is usually taken as the first reading made after the concrete has attained its final set. Usually it is at 12 or 24 hours age. The proper algebraic sign must be indicated.
- Col. 9— Multiply the values in column 8 by the corrected calibration constant (D). The algebraic signs of the column 8 values are carried over into column 9. An increase in resistance ratio indicates an increase in length, and vice versa.
- Col. 10—The correction for thermal expansion or contraction of the meter frame is computed by multiplying the difference between a base reference temperature and the measured meter temperature (including the proper algebraic sign) by the given temperature correction factor (E). The base reference temperature selected is not significant, since only strain differences are considered in the application of the actual strain results. A base reference temperature of 70° F. is frequently used. The algebraic sign of the correction is important, a rise in measured meter temperature will result in a potential expansion of the meter frame, and the correction must be added to the indicated length change to obtain the actual length change.
- Col. 11—The algebraic sum of the values in column 9 and column 10. This column represents the actual length changes of the concrete due to all causes.
- Col. 12— Changes in temperature cause potential length changes in the concrete, and the derived length changes in column 11 are corrected to compensate for this effect. The correction is equivalent to subtracting the thermal length change which would have taken place had the concrete been unrestrained, and is always opposite in sign to the meter frame correction. Its value is determined in a manner similar to that followed for column 10, using a base reference temperature (usually 70° F.) and the concrete coefficient of thermal expansion (F) taken from laboratory data or estimated from other sources. An increase in temperature (column 6) results in a negative value for the column 12 figure, and a decrease in temperature, a positive value.
- Col. 13— The algebraic sum of the values in columns 11 and 12.
- Col. 14— Identify the reading selected as the no-stress or initial condition, and give age of concrete for that date and hour.

(Prepared by WES)

_____ PROJECT
 RESISTANCE THERMOMETER DATA SHEET

Resistance thermometer No. _____ Sheet _____

Location _____

Calibration data:

Meter resistance at (A)* ° F _____ (B)* ohms
 Calibration constant _____ (C)* ohm change/°F
 Corrected meter resistance at (A) ° F _____ (D) ohms
 Resistance of leads at ___ ° F _____ ohms (pair)

1	2	3	4
Date	Time	Meter Resist., ohms	Temp., ° F.

1	2	3	4
Date	Time	Meter Resist., ohms	Temp., ° F.

*Furnished by manufacturer.

EXPLANATION:

Calibration Data—Meters are usually so wound as to have 39.00 ohms resistance (B) at 0° F. (A), which, for the quality of copper wire used, provides a calibration constant (C) of 0.10 ohm change per degree F. change. The corrected meter resistance (D) is obtained from the given value (B) during the field calibration check.

Col. 3—Measured 3-wire resistance of meter.

Col. 4—Temperature of meter, obtained by subtracting corrected meter resistance (D) from resistances in column 3, multiplying result by calibration constant (C), and adding to base temperature (A).

(Prepared by WES)

PROJECT
JOINT METER DATA SHEET

Joint meter No. _____ Sheet _____

Location _____

Calibration data:

Meter resistance at (A)* ° F _____ (B)* ohms.
 Change in temperature per ohm change in resistance _____ (C)* ° F.
 Ratio in closed position _____ %.
 Original calibration constant _____ (*) in./01 % ratio change.
 Calibration constant corrected for leads _____ (D) in./01 % ratio change.
 Resistance of leads at ___ ° F _____ ohms (pair).

1	2	3	4	5	6	7	8	9	10
Date	Time	Total resist., ohms	Lead ohms	Meter resist., ohms	Temp., ° F.	Resist. ratio, %	Change in ratio, %	Indicated movement, inches	Remarks

*Furnished by manufacturer.

EXPLANATION:

Cols. 3 to 7, inclusive—Similar to corresponding columns on stress meter data sheet. Since the magnitude of thermal length changes of the meter and concrete due to changes in temperature are insignificantly small relative to the joint movements being measured and the range of the meter, no temperature correction is made. Temperature data is of general interest and provides a means for detecting faulty operation of the strain measuring unit.

Col. 8—Total change in resistance ratio (column 7) from a selected initial value when the joint is known to be closed. This is usually taken at about 24 hours after the concrete has been placed. The proper algebraic sign must be shown.

Col. 9—Multiply values in column 8 by the corrected calibration constant (D). The algebraic signs of column 8 are carried over into column 9, positive values indicating an opening of the joint with respect to the initial position, and vice versa.

(Prepared by WES)

PROJECT _____
PORE PRESSURE CELL DATA SHEET

Pore pressure cell No. _____ Sheet _____

Location _____

Calibration data:

Meter resistance at 0 * ° F 50.16 * ohms.
 Change in temperature per ohm change in resistance 11.10 * ° F.
 Ratio at zero stress 96.79 %.
 Original calibration constant 5.25 * psi/.01 % ratio change.
 Calibration constant corrected for leads 5.68 psi/.01 % ratio change.
 Resistance of leads at 70° F 6.30 ohms (pair).

1	2	3	4	5	6	7	8	9	10
Date	Time	Total resist., ohms	Lead ohms	Meter resist., ohms	Temp., ° F.	Resist. ratio, %	Change in ratio, %	Indicated hydrost. pressure, psi	Remarks
2-5-80	8 am	62.85	6.30	56.55	70.9	96.79	0	0	at placement
2-6-80	8 am	63.08	6.35	56.73	72.9	96.77	-0.02	11.4	24 hrs-age
2-7-80	8 am	63.65	6.51	57.14	77.5	96.77	-0.02	11.4	

EXAMPLE CALCULATIONS

- Column 1 Self explanatory
- Column 2 Self explanatory
- Column 3 Total resistance of meter as measured in the field. This reading is taken directly from the readout box (with selector switched to resistance) and includes resistance for both meter and associated lead cable.
- Column 4 The resistance of the lead wires when disconnected from the meter, or if the leads are connected to the meter, measure resistance between the red-white terminals and between the red-black terminals. Sum these two resistances and subtract the sum from the resistance between the black-white terminals. If the meter has a 4-conductor cable it can be read directly.
- Column 5 (Value in column 3) - (Value in column 4)
62.85 - 6.30 = 56.55, 63.08 - 6.35 = 56.73, and 63.65 - 6.51 = 57.14
- Column 6 The temperature reading of the meter is calculated by subtracting the calibration meter resistance (usually that at 0°F) from the meter resistance in col. 5 and then multiplying by the change in temperature per ohm change in resistance.
(56.55 - 50.16)(11.10) = 70.9, (56.73 - 50.16)(11.10) = 72.9, (57.14 - 50.16)(11.10) = 77.5
If the calibration temperature is not 0°F then the above calculated temperature is added to the temperature at which the meter was calibrated.
- Column 7 Reading as taken directly from the test set (with selector switch set to ratio) if the ratio is greater than 100%, some instruments assume the presence of the hundreds column and only measure XX.XX
- Column 8 (Present value of column 7) - (Ratio in closed position)
96.79 - 96.79 = 0, 96.77 - 96.79 = -0.02, 96.77 - 96.79 = -0.02
- Column 9 (Value in column 8)(Calibration constant corrected for leads)
(-0.02)(5.68) = 11.4

* Data supplied by Gage Manufacturer.
 ** Readings must be taken at placement to obtain a reference pressure.

(Prepared by WES)

PROJECT
STRESS METER DATA SHEET

Stress meter No. _____ Sheet _____

Location: _____

Calibration data:

Meter resistance at 0 °F 59.44 * ohms
 Change in temperature per ohm change in resistance 9.44 * ° F
 Ratio at zero stress 101.72 %
 Original calibration constant 5.25 * psi/.01 ratio % change.
 Calibration constant corrected for leads 5.68 psi/.01 ratio % change.
 Resistance of leads at 70 ° F 5.48 ohms (per pair)
 Temperature correction = $-\frac{[(80T/D + 6.7)10^{-6} - K]E \cdot F}{E(10^{-6})}$ psi per 1 ° F. temp. rise
 80T/D = 2.0 * ; K = 5.5×10^{-6}
 F = 0.07 *

1	2	3	4	5	6	7	8	9	10	11	12	13	14
Date	Time	Total resist., ohms	Lead resist., ohms	Meter resist., ohms	Temp., ° F.	Resist. ratio, % (101.72)	Change in ratio, %	Indic. stress psi	Est. E. million psi	Corr. per ° F., psi	Total temp. corr., psi	Actual stress, psi	Remarks
2-5-80	8 am	72.61	5.5	67.11	72.4	101.73	+0.01	-6	1.0	-0.2			
2-6-80	8 am	73.43	5.61	67.82	79.1	101.70	-0.02	+11	1.1	-0.2	0	11	24 hr-age
2-7-80	8 am	73.44	5.3	68.14	82.1	101.71	-0.01	+6	1.2	-0.3	-1	5	

EXAMPLE CALCULATIONS

- Column 1 Self explanatory
- Column 2 Self explanatory
- Column 3 Total resistance of meter as measured in the field. This reading is taken directly from the readout box (with selector switched to resistance) and includes resistance for both meter and associated lead cable.
- Column 4 The resistance of the lead wires when disconnected from the meter, or if the leads are connected to the meter, measure resistance between the red-white terminals and between the red-black terminals. Sum these two resistances and subtract the sum from the resistance between the black-white terminals. If the meter has a 4-conductor cable it can be read directly.
- Column 5 (Value in column 3) - (Value in column 4)
72.61 - 5.5 = 67.11, 73.43 - 5.61 = 67.82, 73.44 - 5.3 = 68.14
- Column 6 The temperature reading of the meter is calculated by subtracting the calibration meter resistance (usually that at 0°F) from the meter resistance in col. 5 and then multiplying by the change in temperature per ohm change in resistance.
(67.11 - 59.44) 9.44 = 72.40, (67.82 - 59.44) (9.44) = 79.11, (68.14 - 59.44) 9.44 = 82.12
If the calibration temperature is not 0°F then the above calculated temperature is added to the temperature at which the meter was calibrated.
- Column 7 Reading directly as taken from the test set. On some test sets the 100 is assumed and the meter would read, for example, 01.73
- Column 8 (Most recent value of column 7) - (Zero stress ratio)
101.73 - 101.72 = +0.01, 101.70 - 101.72 = -0.02, 101.71 - 101.72 = -0.01
- Column 9 (Value in column 8) (Corrected calibration constant)
(0.01%)(5.68 millionths/.01%) = -6 millionths
(0.02%)(5.68 millionths/.01%) = +11 millionths
(0.01%)(5.68 millionths/.01%) = +6 millionths
- Column 10 Estimated value of modulus of elasticity (including effects of creep)
- Column 11 Correction calculated from temperature correction data at the head of the sheet
For example: Value in col. 11 on 2-7-80
 $-\frac{[(80T/D + 6.7)10^{-6} - K]E(F)}{E(10^{-6})} = -\frac{[(2.0 + 6.7)10^{-6} - (5.5)10^{-6}](1.2)(0.07)}{E(10^{-6})} = .3 \times 10^{-6}$
- Column 12 (Temperature in col. 6-assumed reference temp**)(Value in column 11)
(79.1 - 79.1)(-0.2) = 0, and (82.1-79.1)(-0.2) = -1
- Column 13 (Value in column 9) + (Value in column 12)
11 + 0 = 11, and 6 + (-1) = 5

* Data supplied by Gage Manufacturer.
 ** In this example temp at 24 hrs is reference.

(Prepared by WES)

PROJECT
STRAIN METER DATA SHEET

Strain meter No. _____ Sheet _____

Location _____

Calibration data:

Meter resistance at 0*° F56.10* ohms.
 Change in temperature per ohm change in resistance..... 8.61* ° F.
 Original calibration constant..... 3.82 millionths/.01% ratio change.
 Calibration constant corrected for leads..... 3.98 millionths/.01% ratio change.
 Resistance of leads at 70 ° F..... 2.61 ohms (pair).
 Temperature correction for meter..... 7.5 * millionths/° F.
 Concrete coefficient of thermal expansion..... 5.5 millionths/° F.

1	2	3	4	5	6	7	8	9	10	11	12	13	14
Date	Time	Total resist., ohms	Lead resist., ohms	Meter resist., ohms	Temp. ° F.	Resist. ratio, %	Change in ratio, %	Indicated unit length change, millionths	Correc-tion for meter expan-sion, mil-lionths	Actual unit length change, mil-lionths	Correc-tion for concrete expan-sion, mil-lionths	Actual strain, mil-lionths	Re-marks
2-5-80	9 am	66.91	2.61	64.30	70.60	100.97		0	+4	+4	-3	+1	age 24 hrs
2-6-80	9 am	67.36	2.63	64.73	74.30	100.91	-0.06	-24	+32	+8	-23	-15	

EXAMPLE CALCULATIONS

- Column 1 Self explanatory
- Column 2 Self explanatory
- Column 3 Total resistance of meter as measured in the field. This reading is taken directly from the readout box (with selector switched to resistance) and includes resistance for both meter and associated lead cable.
- Column 4 The resistance of the lead wires when disconnected from the meter, or if the leads are connected to the meter, measure resistance between the red-white terminals and between the red-black terminals. Sum these two resistances and subtract the sum from the resistance between the black-white terminals. If the meter has a 4-conductor cable it can be read directly
- Column 5 (Value in column 3) - (Value in column 4)
66.91 - 2.61 = 64.30, and 67.36 - 2.63 = 64.73
- Column 6 The temperature reading of the meter is calculated by subtracting the calibration meter resistance (usually that at 0°F) from the meter resistance in col. 5 and then multiplying by the change in temperature per ohm change in resistance.
(64.30 - 56.10)(8.61) = 70.60, and (64.73 - 56.10)(8.61) = 74.30
If the calibration temperature is not 0°F then the above calculated temperature is added to the temperature at which the meter was calibrated.
- Column 7 Reading directly as taken from the test set. On some test sets the 100 is assumed and the meter would read, for example, 00.97
- Column 8 (Most recent value of column 7) - (Zero stress ratio)
100.91 - 100.97 = -0.06
- Column 9 (Value in column 8)(Corrected calibration constant)
(-0.06%)(3.98 millionths/.01%) = -24 millionths
- Column 10 (Temp. in Column 6. - Reference temp.)(Temp. correction for meter)
(70.60 - 70.00)(7.5) = +4.5 millionths, and (74.3 - 70.00)(7.5) = +32 millionths
- Column 11 (Value in column 10) + (Value in column 11)
0 + (+4) = +4 millionths, and (-24) + (+32) = +8 millionths
- Column 12 (Temp. in column 6 - Reference temp.)(Concrete coefficient of thermal expansion)
(70.60 - 70.00)(5.5) = -3 Negative because it is subtracted from the strain
(74.30 - 70.00)(5.5) = -23 Negative because it is subtracted from the strain
- Column 13 (Value in column 11) + (Value in column 12)
(+4) + (-3) = +1 millionths, and (+8) + (-23) = -15 millionths

* Data supplied by Gage Manufacturer.

(prepared by WES)

PROJECT _____
JOINT METER DATA SHEET

Joint meter No. _____ Sheet _____

Location _____

Calibration data:

Meter resistance at 0 ° F 50.16 * ohms.
 Change in temperature per ohm change in resistance..... 11.10 * ° F.
 Ratio in closed position 96.79 %.
 Original calibration constant 0.00046 * in./01 % ratio change.
 Calibration constant corrected for leads 0.00051 in./01 % ratio change.
 Resistance of leads at 70 ° F 6.30 ohms (pair).

1	2	3	4	5	6	7	8	9	10
Date	Time	Total resist., ohms	Lead ohms	Meter resist., ohms	Temp., ° F.	Resist. ratio, %	Change in ratio, %	Indicated movement, inches	Remarks
2-5-80	8 am	62.85	6.30	56.55	70.9	96.79	0	0	concrete setting, joint closed
2-6-80	8 am	63.08	6.35	56.73	72.9	96.77	-0.02	-0.0010	
2-7-80	8 am	63.65	6.51	57.14	77.5	96.77	-0.02	-0.0010	

EXAMPLE CALCULATIONS

- Column 1 Self explanatory
- Column 2 Self explanatory
- Column 3 Total resistance of meter as measured in the field. This reading is taken directly from the readout box (with selector switched to resistance) and includes resistance for both meter and associated lead cable.
- Column 4 The resistance of the lead wires when disconnected from the meter, or if the leads are connected to the meter, measure resistance between the red-white terminals and between the red-black terminals. Sum these two resistances and subtract the sum from the resistance between the black-white terminals. If the meter has a 4-conductor cable it can be read directly.
- Column 5 (Value in column 3) - (Value in column 4)
62.85 - 6.30 = 56.55, 63.08 - 6.35 = 56.73, 63.65 - 6.51 = 57.14
- Column 6 The temperature reading of the meter is calculated by subtracting the calibration meter resistance (usually that at 0°F) from the meter resistance in col. 5 and then multiplying by the change in temperature per ohm change in resistance.
(56.55 - 50.16)(11.10) = 70.9, (56.73 - 50.16)(11.10) = 72.9, (57.14 - 50.16)(11.10) = 77.5
If the calibration temperature is not 0°F then the above calculated temperature is added to the temperature at which the meter was calibrated.
- Column 7 Reading as taken directly from the test set (with selector switch set to ratio) if the ratio is greater than 100%, some instruments assume the presence of the hundreds column and only measure XX.XX
- Column 8 (Present value of column 7) - (Ratio in closed position)
96.79 - 96.79 = 0, 96.77 - 96.79 = -0.02, 96.77 - 96.79 = -0.02
- Column 9 (Value in column 8)(Calibration constant corrected for leads)
(-0.02)(0.00051) = -0.0010

* Data supplied by Gage Manufacturer.

(Prepared by WES)

CHAPTER 3

UPLIFT AND LEAKAGE

Section I. Uplift

3-1. Purpose. Measurement of uplift pressure intensities at several points under a structure are made to check the validity and accuracy of the design assumptions pertaining to uplift, and to provide information for future designs as to the areal extent and magnitude of hydrostatic pressures. The practice of attempting to determine uplift pressures by installing pressure gages on foundation drains is improper and should be avoided, since, determination of pressure at a single point on a gradient is of little value, and the actual uplift pressure pattern is modified when a foundation drain is prevented from functioning in its normal manner. For converse reasons, uplift cells should not be utilized for leakage determinations.

3-2. Description.

a. Uplift Cells. Uplift pressure cells are normally placed on the foundation rock and located 15 to 20 ft apart along lines normal to the axis of the dam as shown in Plate No. 3-1. Where the transverse distribution of uplift pressures is to be investigated also, up to five or more separate lines of cells may be placed under one monolith. Except for unusual foundation conditions, uplift instrumentation facilities are usually confined to one or two of the large monoliths.

b. Standpipe Type Cell. The simplest and most widely used type of uplift cell consists of a gravel-filled wooden box installed over a shallow drilled hole, containing a pipe tee and two short lengths of perforated pipe. Plain pipe runs from the perforated pipe in the collector box to the reading station in a gallery wall, where the pipe is capped with a gage adapter coupling and a shutoff cock. Pressure heads at the cell exceeding the elevation of the reading station are measured by Bourdon-type gages. Pressure heads at the cell less than the gage elevation are determined by removing the gage adapter and sounding to the water surface in the pipe or by reading the water level by one of the other methods available such as the water level indicator mentioned in paragraph 3-10. Typical details of the box and piping are shown on Plate No. 3-1.

15 Sep 80

c. Diaphragm Type Cell. This type is cylindrical in shape, with a porous disk in one end and tubes or electrical cable entering the other. Immediately behind the porous disk is an impermeable diaphragm, the deflection of which is measured by strain gages, or either air or oil pressure, depending on whether the piezometer is classified as electrical or pneumatic. An example of the first type is the Carlson pore pressure cell described in paragraph 2-6, and the second type is the Gloetzel pressure cell described in paragraph 2-31e. The Carlson pore pressure cell has been the most commonly used in the U.S. for installation in concrete dams. See Figures 2-5 and 2-8.

3-3. Installation.

a. Standpipe Type Cell.

(1) Collector Box. As soon as foundation excavation and cleanup has been completed, the cell locations are marked and the shallow holes drilled. The pipe tee, perforated pipe sections, and a length of plain pipe are put in place and the hole filled with clean No. 4 to 3/4-in. crushed rock or gravel. A wooden box is built to conform with the foundation surface in that area, filled with crushed rock or gravel, and the top nailed in place. On the day prior to placing the lift concrete, the box cell is covered with hand-placed mass or face concrete (depending upon the location of the cell) to hold the box in place during subsequent concrete operations.

(2) Pipe Runs. Lengths of plain galvanized pipe are added to the section protruding from the cell box to an elevation above the top of the first lift. Subsequent lengths are added as successive concrete lifts are placed. Pipe runs are placed with an upward slope of about 1/4-in. per foot from the cell to a point directly beneath the reading station, and thence vertically upward to the gallery recess. Pipe assemblies may be held in position during concrete placement by welded angle-iron or pipe frames embedded directly in the concrete together with the pipe runs, as in Figures 3-1 and 3-2. Large radius bends are permissible for slight changes in direction; but conventional pipe elbows should be used for abrupt direction changes. Normally pipe runs will not cross contraction joints, but when necessary to do so, "dresser" expansion couplings should be provided. All threaded pipe connections should be made leakproof by painting the threads with white lead or similar plumbing compound.

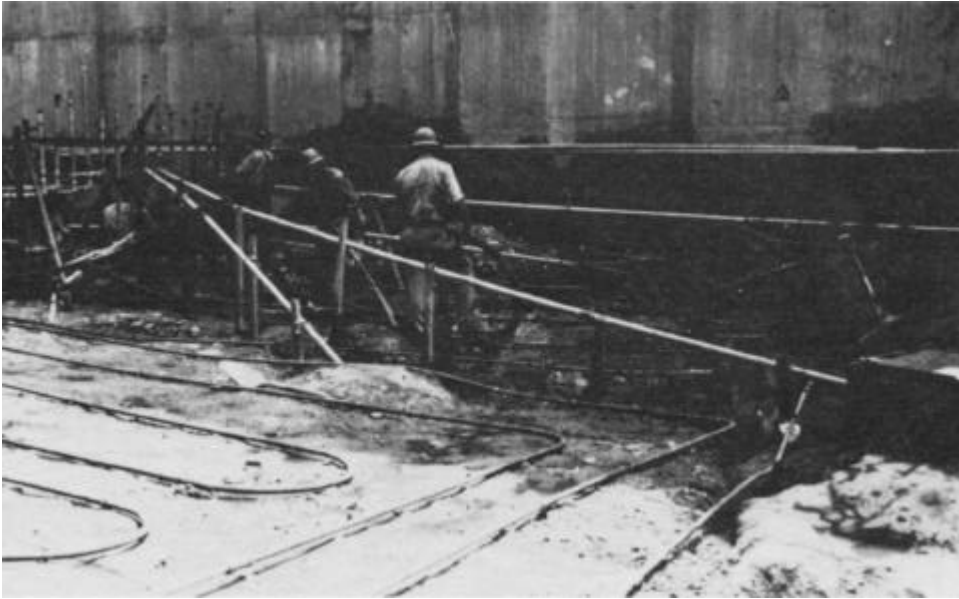

Figure 3-1. Uplift Cell and Sloping Pipe Assembly (Courtesy of the Tennessee Valley Authority).

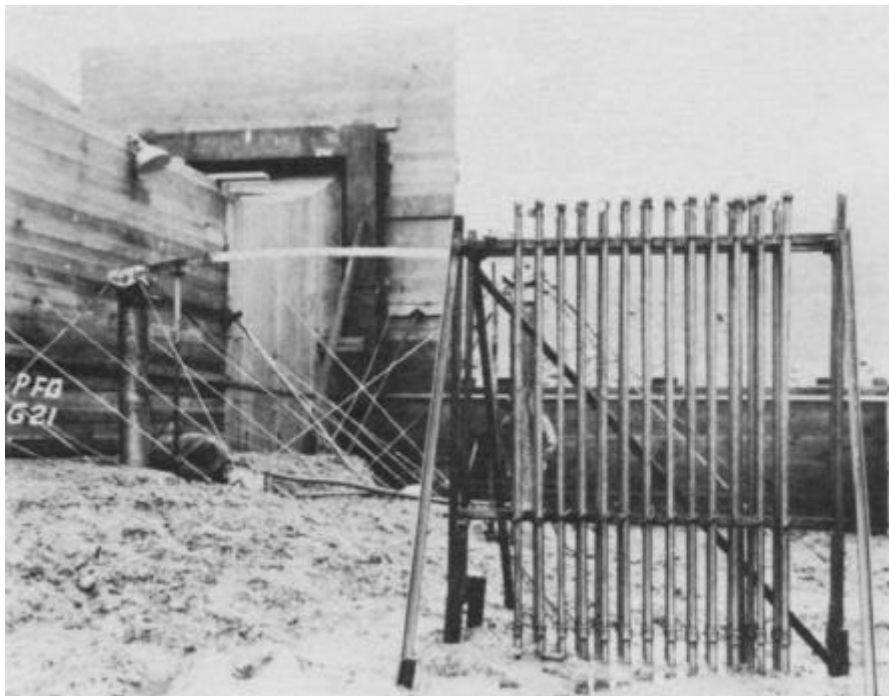

Figure 3-2. Vertical Pipe Runs from Uplift Cells. (Photo by WES)

15 Sep 80

(3) Readout Station. The exposed end of each uplift pipe at the reading station should be capped with a shutoff cock and gage adapter coupling. A typical station is shown in Figure 3-3. This will enable a portable pressure gage of suitable capacity to be temporarily attached to a pipe for a pressure reading, thus reducing the number of such instruments required at a project and avoiding the corrosion problems associated with installed gages in damp galleries. A set of portable gages should consist of three high-quality commercial type gages. One set composed of a low, an intermediate, and a high capacity gage covering the range from minimum to maximum possible pressure heads is usually adequate. Where uplift head is below the elevation of the reading station a graduated tape with a small float will be necessary. Also a number of electrical type probe devices are commercially available, some of which are described later in this chapter. When the probe contacts the water surface, the circuit is closed and registered on an ohmmeter. The length of wire is measured with a tape if graduation marks are not made on the wire. Metal identification markers should be welded or otherwise permanently fastened to each uplift pipe extending into the gallery recess.

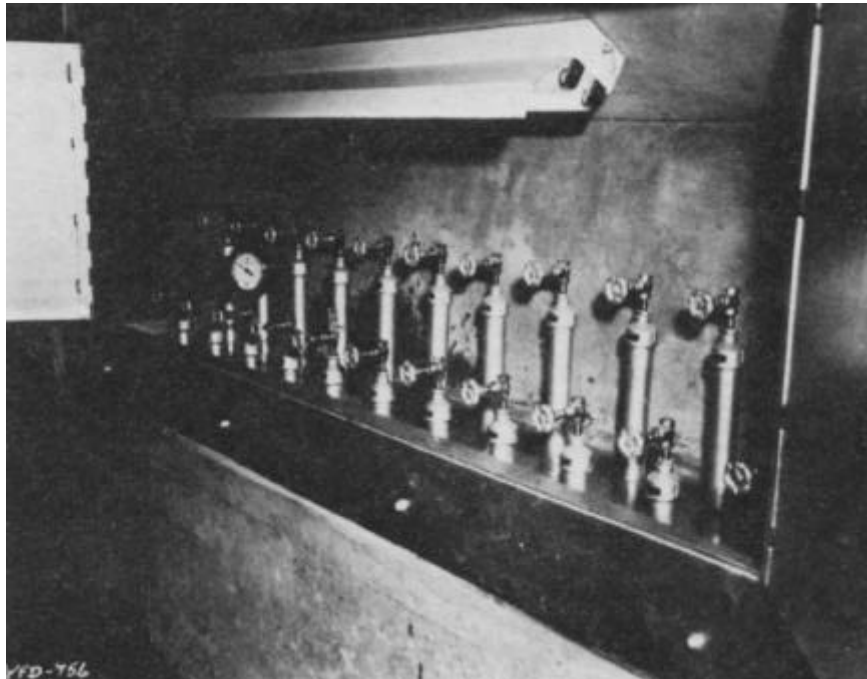

Figure 3-3. Uplift Cell Terminal Reading Station. (Photo by CE-WES)

15 Sep 80

b. Diaphragm Cell.

(1) Preliminary Precautions. The installation of this type of gage must be carefully done in order to prevent damage of the instrument. Before taking the pressure cells to the site for placement, the porous plug of the Carlson gages should be removed and the space between the plug and the diaphragm filled with petroleum jelly. After all foundation excavation and cleanup has been completed the cells with attached cables or tubes should be securely fastened to the rock. A day before placing the lift concrete, a small amount of mass concrete should be hand placed and tamped around the cell. Vibrators should not be used because of the possibility of cement mortar clogging the porous disk of the cell. When the mass concrete is placed, care should be taken to tamp the concrete around the conductor cable to prevent it from providing a leakage path to the cell and thus alter the pressure being measured.

(2) Reading Station. The station for a Carlson type pore pressure gage should be identical to that required for the Carlson stress meters and strain meters, as discussed in paragraphs 2-2 to 2-5. The station for other types of meters should be designed to use the reading equipment required by the type of gage installed. Metal identification markers should be permanently fastened to each of the cables or tubes from the cell in the foundation.

3-4. Collection of Data.

a. Standpipe Cells.

(1) Elevations. At the time the cells are installed and the pipe runs placed, elevation of each uplift cell and of the 90° bend beneath the reading station should be recorded. The exact position of each cell as finally installed should be shown on a copy of the final foundation rock elevation geologic map.

(2) Shutoff Cock. Where the pipes at the reading station are capped, the shutoff cocks should be left open until the hydrostatic pressure gradient exceeds the reading station elevation as evidenced by water discharging from the pipe. After the entrapped air has been completely expelled from a pipe, the shutoff cock should be kept closed except during the time the pressure gage is attached.

15 Sep 80

(3) Readings. To make a pressure reading, slowly open the shutoff cock slightly to determine if hydrostatic pressure exists at the reading station and to allow any accumulated air or gas to escape. If a positive pressure is apparent, close cock immediately, attach a portable Bourdon-type gage and slowly open the cock. Allow a few minutes for the pressure in the pipe and gage to become stabilized and then record the indicated pressure. Where the general magnitude of the pressure is unknown, it is best to initially attached the maximum capacity gage to determine the approximate pressure, replacing it with one of the lower capacity gages of the set if feasible for making the pressure reading. Where the uplift head is below the elevation of the reading station, the shutoff cock fitting must be removed at each reading and the free water level in the pipe determined by sounding. A graduated tape with a small float attached will be found suitable for this purpose. Additionally, the water level can be determined through the electrical gage mentioned in paragraph 3-10.

(4) Field Data Sheets. In order to provide a uniform method for recording and presenting uplift data, and to facilitate analysis of the results, water surface elevations and pressure heads should be recorded directly on ENG Form 2254, Foundation Uplift Pressures, reproduced here in Plate 3-2. When the pressure at the standpipe reading station is positive, the pressure gradient is obtained by multiplying the reading in pounds per square inch by 2.308 to obtain the value in feet of water. This value is added to the elevation of the reading station to obtain the hydrostatic uplift pressure gradient value. When the standpipe gage does not show a pressure, and the pressure head elevation is determined by plumbing, the distance measure from the reading station to the water level is subtracted from the reading station elevation to obtain the hydrostatic uplift pressure for recording on the form, With the reservoir water surface and tailwater elevations also recorded on the field reading sheet, all information is readily available for plotting pressure histories, as shown on Plate No. 3-3, and hydrostatic gradients on Plate No. 3-4, without further calculations. Leakage data is obtained in many forms, depending upon the manner with which the flow rate is measured. The results should be expressed in gallons per minute.

(5) Processing of Data. Computation of the field data should be made and filed in the field office. Copies should be sent to the Engineering Division for evaluation.

b. Diaphragm Type Cell. The technique for observing this type of piezometer should be in accordance with the recommendation of the manufacturer. If the Carlson type is used, the readings should be obtained in the same manner as for strain and stress meters discussed in Chapter 2.

15 Sep 80

3-5. Reading Schedules. The observation program should be started during the construction period, preferably 3 to 6 months prior to final closure. Readings at monthly intervals will provide adequate information on the uplift conditions existing before the effect of the reservoir head becomes apparent. During the initial filling of the reservoir the monthly readings should be increased to once every one or two weeks. After the initial filling of the reservoir and stabilization of the water table in the vicinity of the dam, uplift pressures will change relatively slowly with respect to time, even for the more permeable foundations. For that reason the reading interval may be increased considerably. These routine observations should be supplemented by additional weekly measurements during each period of high reservoir level which is expected to equal or exceed the maximum pool level previously attained. The special measurements should continue for several weeks past the time of the high reservoir level. A complete record of pool and tailwater elevations, either from an automatic recorder or routine daily observation is necessary and should be recorded at the time of piezometer observations.

Section II. Leakage

3-6. General. Periodic measurement of leakage from foundation drains, joint drains, and face drains serve as an indication of the adequacy of the foundation grout curtain, functioning of the drains and reveal when and where remedial measures may be required. Observations of leakage from contraction joints, lift joints, and cracks provide a means for judging the quality of workmanship or construction practices, as well as disclosing the necessity for corrective measures to preserve the integrity of the structure. The main drainage sump may be utilized as a collecting and gaging point for all flows. Two types of gages are available: vee-notch weirs and critical depth meters.

3-7. Vee-Notch Weir.

a. Description. Measurement of flow in selected lengths of gutters may be accomplished by inserting vee-notch weirs to measure total cumulative flow above each weir. Figure 3-4 shows a weir with gutter design for ease of installation. Individual drains or joints leaking excessively may be gaged separately.

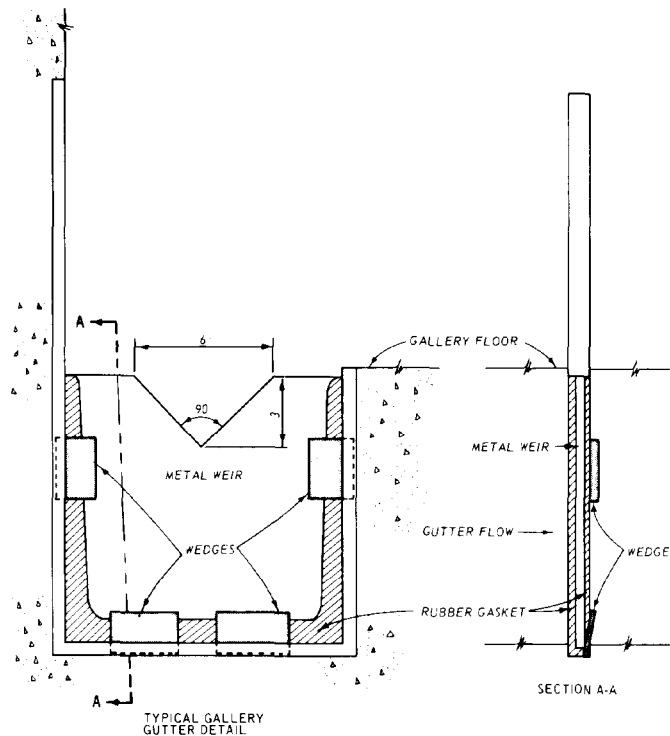

Figure 3-4. Vee-Notch Weir. (Prepared by WES)

15 Sep 80

b. Collection of Data. Total leakage into the interior drainage system of the structure may be calculated by one of the following methods.

(1) The on-off operation chart of the sump pump and the capacity of the sump between the float operating limits.

(2) A simple mechanical counter actuated by a lever arm fastened to the float stem or line, to indicate the number of fill-pump cycles over a period of several hours or days.

(3) Manually timing the water level rise in the sump,

(4) Measuring the head above the base of a vee-notch weir with a hook gage or scale at one or more locations in the gallery gutters, and the flow rate determined from standard hydraulic tables. Flows from individual foundation drains, vertical face, and joint drains discharging at excessive rates can be determined by measuring the weight or volume of water discharged over a short known time period.

c. Data Sheets. Since the manner of making leakage measurements is dependent upon the type and arrangement of interior drainage facilities, no standard data form has been established. Survey field books or forms developed in the project office are satisfactory, providing arrangements are made for retaining the results in a permanent file for comparison with subsequent leakage data.

d. Reading Schedules. Measurement of excessive individual drain flows and of total leakage should be made at least twice yearly. One measurement should be made at a high pool level and one at the minimum pool level. Where suitable facilities exist for determining total leakage rates with the expenditure of little effort, such as from automatic sump pump operation records, measurement of flows at intervals as short as one week (or even continuously) may prove to be of value. Semi-annual measurements may be reported in tabular form with pool and tailwater elevations given for the data of measurement. It has been found helpful to identify the location of individual measurements if the table is beneath a longitudinal section of the dam with all monoliths shown and numbered.

15 Sep 80

3-8. Critical Depth Meter.

a. Description. A flow meter that functions on the principle of measurement of the backwater curve established when water flows from subcritical velocities to critical velocity in a weir is marketed by Neptune UES, 7070 Commerce Circle, Pleasanton, California, 94566. The meter shown in Figure 3-5 consists of a U-shaped flume that fits in conduit or gutter and a monitoring power source.

b. Collection of Data. Data are automatically recorded on a strip chart that measures flow versus time. It also has a counter that measures total flow past the flume. The recorder prints through the impinging action of the stylus driven by a clamping bar against pressure sensitive paper. Its presentation is a series of dots appearing as a continuous line. The recorder can be powered by either 12v DC current for remote installations or 120v-60 Hz in continuous operation.

c. Reading Schedules. The flow can be monitored continuously when excessive leakage is apparent or it can be monitored at specific yearly intervals as outlined in paragraph 3-7d.

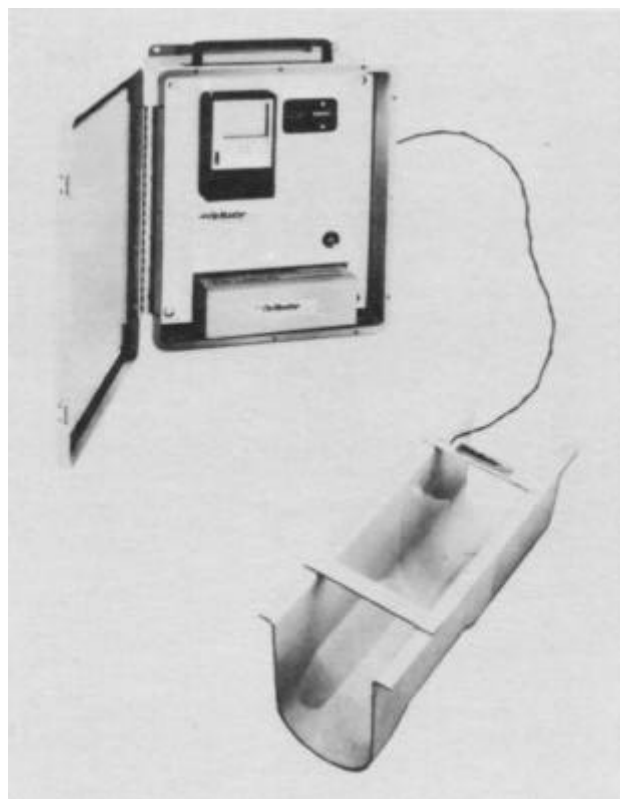
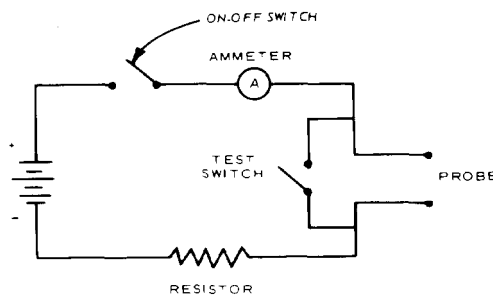
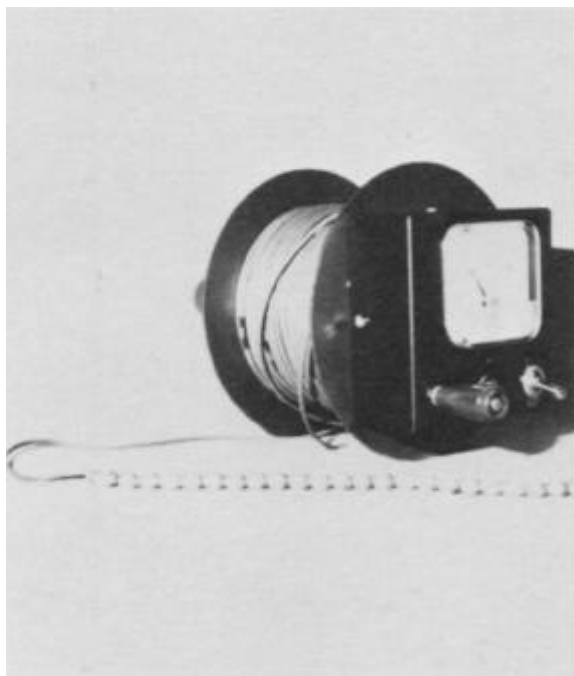

Figure 3-5. Neptune UES Critical Depth Meter (Courtesy of Neptune UES, Inc.).

Section III. Supplemental Instruments.

3-9. General. There are some electrical and hydraulic instruments that can also be useful on structures for monitoring water height in piezometer standpipes, pressure under stilling basin slab, and pore pressure. Some of the instruments can be permanently installed and monitored with a portable readout device or with an automatic data acquisition system.

3-10. Water Level Indicator. Electronic water level indicators are useful in monitoring the level of water in the uplift pressure cell standpipe; The Soiltest DR-760A Water Level Indicator, shown in Figure 3-6a, is a self-contained, portable, transistorized instrument for determining water levels in boreholes to depths of 300 ft. Other models are available for greater depths. The high strength, 1/8-in. diameter electrical cable is mounted on a 6-in. diameter steel and plastic spool and has interval markers every 5 ft. The weighted probe assembly keeps the cable taut as it is lowered into the hole. The instrument has a test button, indicating meter, battery, and on-off switch. The simplified circuit is shown in Figure 3-6b. When the probe makes contact with the water, continuity is established, current flows in the circuit, and the ammeter indicator deflects from 0 to full scale.



a. Soiltest Model DR-760A

b. Simplified Circuit

Figure 3-6. Water Level Indicator (Courtesy of Soiltest, Inc.).

15 Sep 80

3-11. Vibrating Wire Piezometer.

a. Description. The IRAD vibrating wire piezometer shown in Figure 3-7 is designed to provide remote digital readouts of water pressure in fully and partially saturated natural soils, in rolled earth fills, and on the interface of retaining structures. It is particularly useful for hard to monitor spots, such as under the floor of a lock chamber. The vibrating wire gage exhibits very small time lags, an ability to measure negative pressures, high sensitivity and reliability, and transmission of signals as a frequency over long lead-wire lengths. It can be buried in fill during construction, sealed in boreholes after construction, and driven directly into loose ground from the surface (provided the appropriate head design is used). A major application is to upgrade standpipe installations by lowering the piezometer to a fixed point and measuring head pressure directly from a remote readout station.

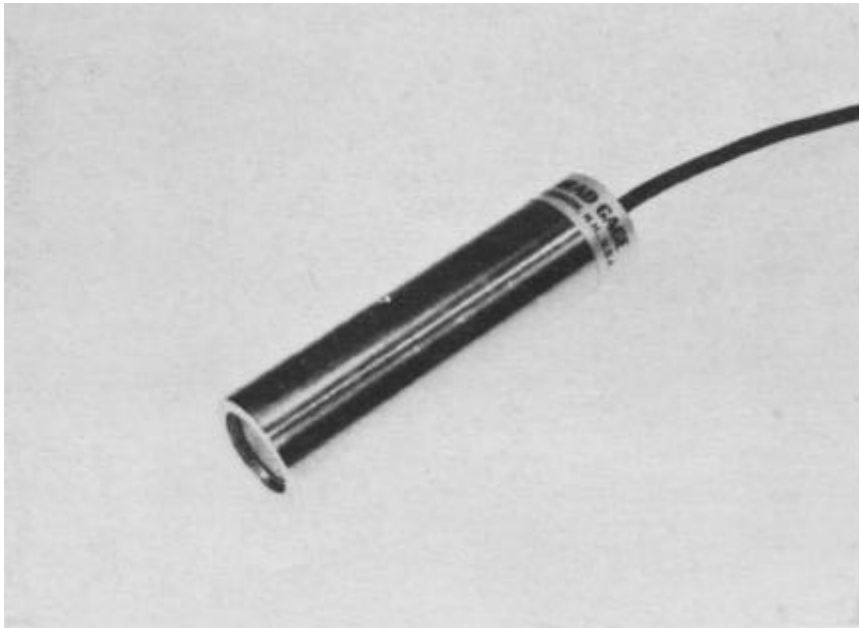

Figure 3-7. IRAD Vibrating Wire Piezometer (Courtesy of Irad Gage, Inc.).

15 Sep 80

b. Principle of Operation. Water that enters the gage through a filter stone exerts a pressure against the face of a diaphragm. The resulting deflection changes the resonant frequency of a tensioned steel wire clamped between the diaphragm and the main body of the gage. Like the vibrating wire strain meter, contact resistance, leakage to ground or signal cable need only be continuous in order for a reading to be made. Signal cable lengths up to a mile can be used. The frequency readings are obtained with a portable digital readout meter. A variety of heads and filter permeabilities can be provided.

3-12. Strain Gaged Diaphragm Pressure Gage. There are now available some strain gaged diaphragm pressure gages that have the stability necessary for long time measurements. These gages can be useful for pore and uplift pressure measurements as utilized in the WES Telemetry system for measuring the pressure under a stilling basin slab and transmitting the data by radio waves at periodic intervals. The pressure gage used in the WES Telemetry system is the Bell and Howell 4-403 pressure transmitter. The current output instrument is a true 2-wire device with no moving parts, offering long-term stability under extreme environmental conditions. The instrument is temperature compensated over the range of 0°F to +165°F. Since it is a current transmitter, relatively long electrical cable can be used without affecting its output. The simplified measuring circuit and gage configuration are shown in Figure 3-8a and b.

3-13. WES Pressure Measuring Telemetry System.

a. Transmitter and Gage. The WES Telemetry System was developed for measuring pressure under the stilling basin slab and transmitting this data out of the concrete slab, through the water and air to the receiving antennas on the structure. The transmitting package, Figure 3-8a, consists of: a Bell and Howell type 4-403 pressure transmitter, an A to D converter, conditioning system, a 100KHZ transmitter, lithium batteries, a stainless steel canister, and a ferrite rod antenna encased in plastic. The transmitting package is placed in a 7-in. drilled hole in the concrete slab with the pressure inlet end located at or near the bottom of the concrete slab and the top of the antenna located very near the top surface of the slab. After locating the package and sealing around the bottom of the canister with sand, the remainder of the hole is filled with a high strength grout.

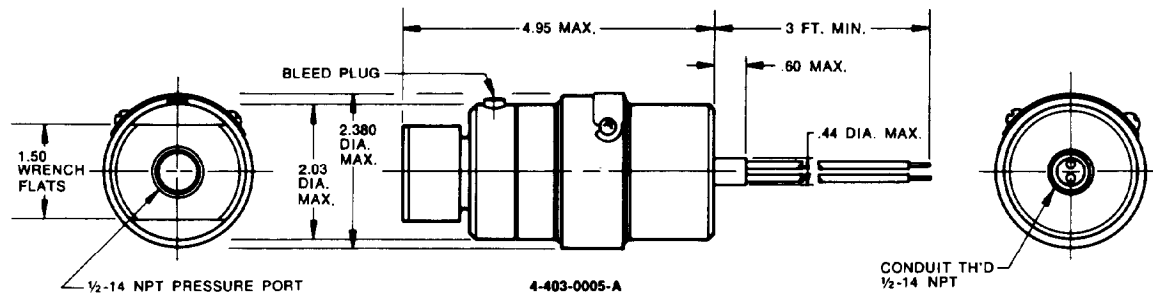

a. Pressure Transmitter

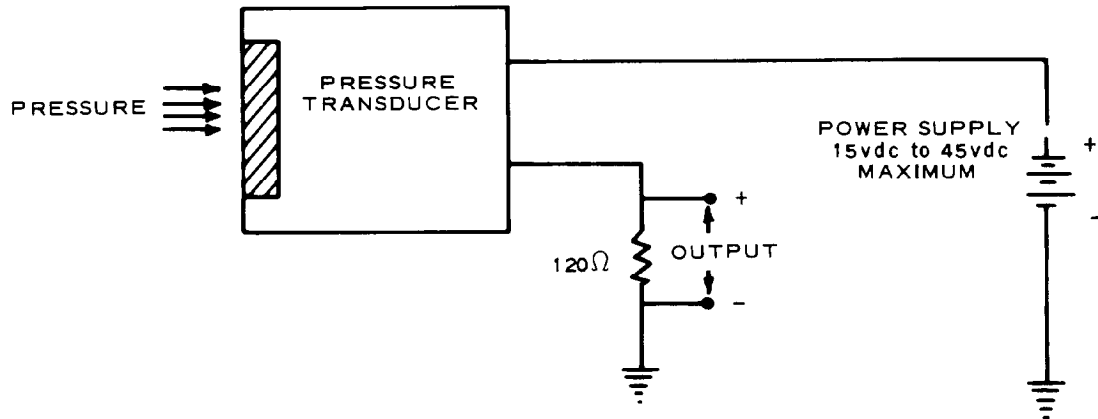

b. Measuring Circuit

Figure 3-8. Strain Gaged Diaphragm Pressure Gage (Courtesy of Consolidated Electro-dynamics).

b. Receiving System. The receiving system consists of a 100KHZ loop antenna connected to receivers with RG213 coaxial cable, receivers with microcomputers, data logger with microcomputer, and a printer. The BCD pressure data are transmitted at 30-minute intervals. The receivers hold the previous data for approximately 29-3/4 minutes, clears the data, and waits for new data. The main logging system continuously scans the remote receivers and operates on the data to provide continuous reading of pressure or equivalent water elevation. The printer can be set to print the data at a selected time interval. Figure 3-9 shows the gage and transmitter in the foreground and the receiving system in the background. For more detailed information on this system contact the Structures Laboratory, Waterways Experiment Station, P. O. Box 631, Vicksburg, MS 39180.

3-14. Hydraulic Pore Water Pressure Cell.

a. Principle of Operation. Hydraulic Pore Water Pressure Cell, shown in Figure 3-10, is designed to provide a low cost piezometer for use in both embankments and foundations. The cell operates on the hydraulic relief principle which is precise, rugged, and reliable. Water in the soil or rock mass acts on the cell through a filter stone which covers an oil-filled chamber leading to a diaphragm. The pressure of the water acts on the diaphragm through the medium of a piston which is also acted on by a compression spring. Pressure on the diaphragm holds it flat against a pressure plate in which two small inlet ports are drilled. The inlet ports are connected by nylon or steel tubing to the readout station. At the readout station, the tubing is connected to a hydraulic pump. This instrument is available from Terrametrics, 16027 West Fifth Avenue, Golden, CO 80401.

b. Reading. To read the pore water pressure, one inlet port is pressurized until the diaphragm lifts off the pressure plate, When this occurs, the oil escapes for one inlet port across to the other and bleeds back to the oil reservoir. Additional operation of the pump causes no further increase of pressure. The pore pressure is then calculated by the simple formula:

$$P = G + H - S$$

where P is the pore water pressure, G is the maximum attainable gage pressure (occurs when diaphragm lifts), H is the hydraulic head in the inlet port tubing, and S is the spring pressure.



Figure 3-9. WES Pressure Measuring Telemetry System. (Photo by WES)

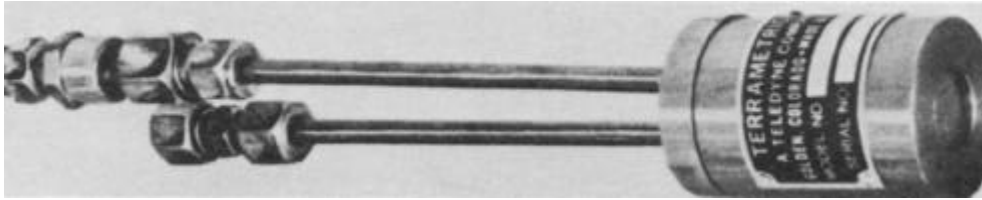

Figure 3-10. Terrametrics Pore Water Pressure Cell (Courtesy of Terrametrics, Inc.).

3-15. WES Hydrostatic Pressure Cell. A hydrostatic pressure cell for measuring pore water pressure in concrete is available from the Operations Branch, Instrumentation Services Division of the Waterways Experiment Station, P. O. Box 631, Vicksburg, Mississippi 39180. Its principle of operation is the amount of electrical resistance generated in a full bridge electrical resistance strain gage circuit bonded to a metal diaphragm that reacts to water pressure on its face. As shown in Figure 3-11, the metal diaphragm is directly behind a porous stone in the instrument face. The pore pressure deflects the metal diaphragm inducing strain which is proportional to the pore pressure at the face of the meter. Readings are taken with a standard strain indicator such as the Carlson test set or Biddle strain gage indicator.

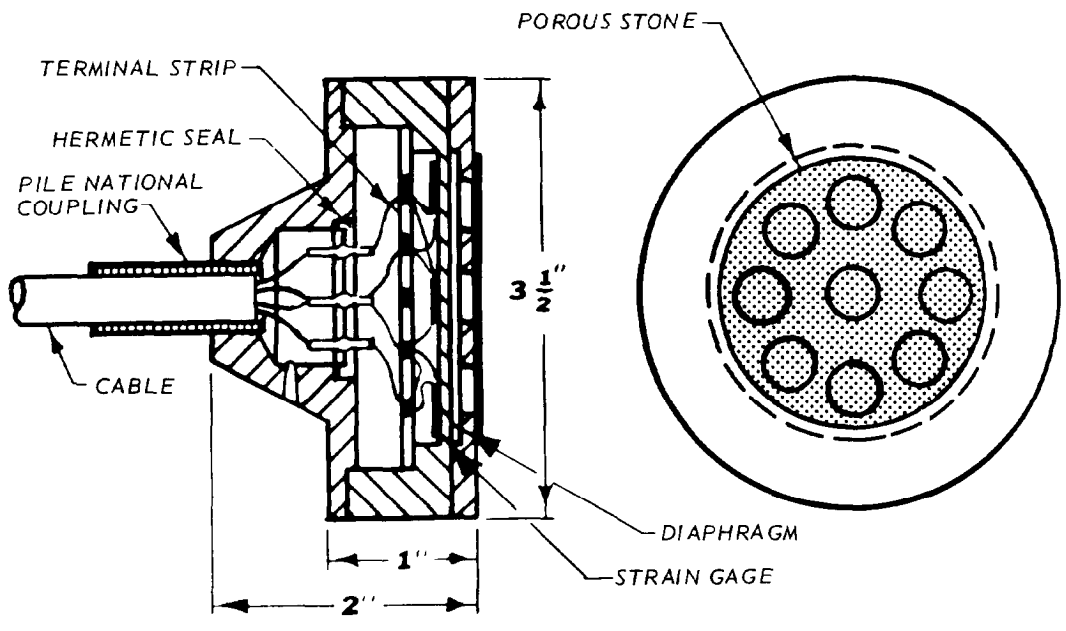
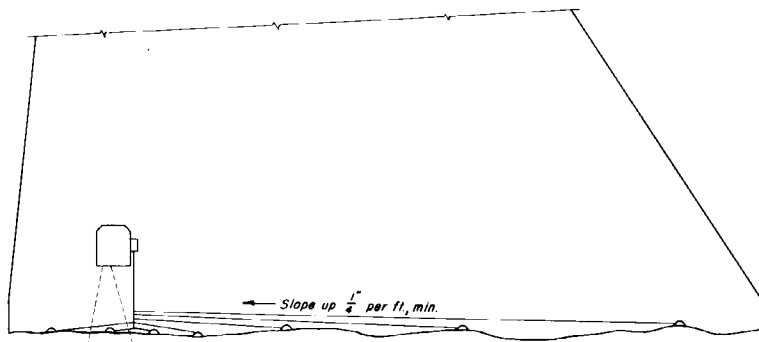
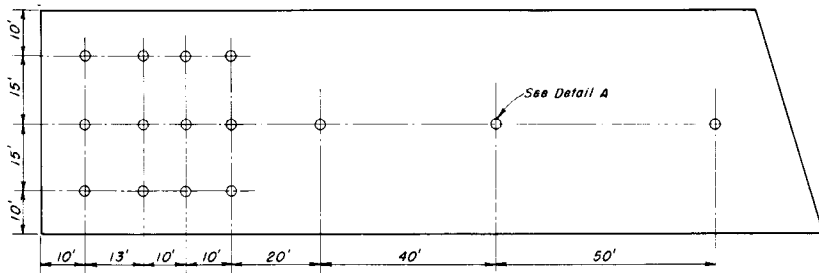

Figure 3-11. WES Hydrostatic Pressure Cell. (Drying prepared by WES)

3-19



SECTION ALONG MONOLITH C-C



TYPICAL LAYOUT PLAN

Plate 3-1

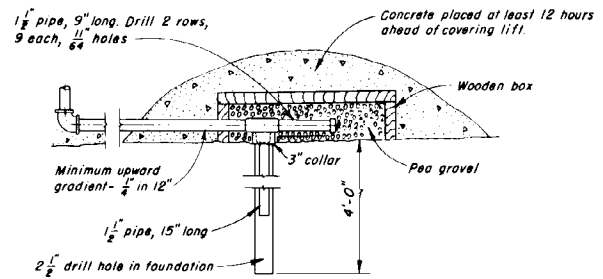

SECTION A-A

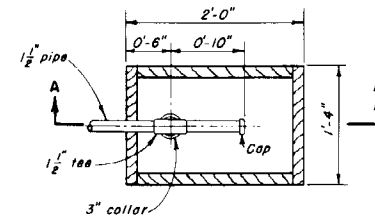

DETAIL A

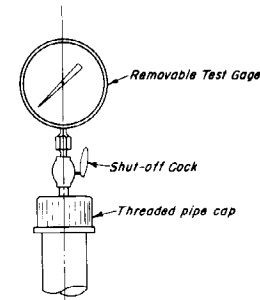

GAGE CONNECTION DETAIL

MANUALS - CORPS OF ENGINEERS
U. S. ARMY
ENGINEERING AND DESIGN
INSTRUMENTATION FOR MEASUREMENT OF STRUCTURAL
BEHAVIOR OF CONCRETE GRAVITY STRUCTURES
UPLIFT CELL LAYOUT AND DETAILS

EM 1110-2-4300

PLATE 3-1

(Prepared by CE-WES)

EM 1110-2-4300
15 Sep 80

3-21

Plate 3-3

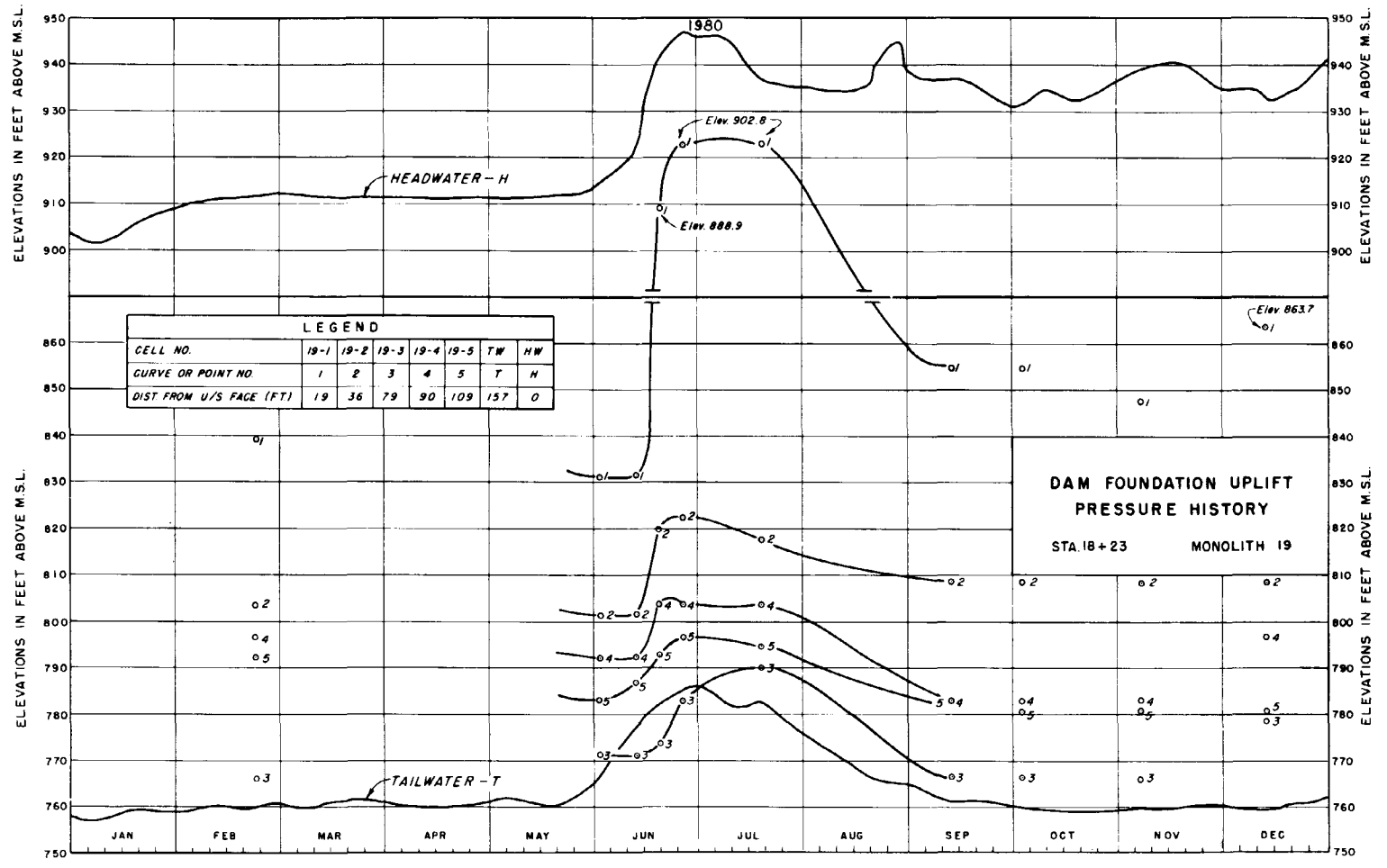

(Prepared by CE)

PLATE 3-3

EM 1110-2-4300
 15 Sep 80

FOR DESIGN UPLIFT
ASSUMPTIONS SEE
EM 1110-2-2200

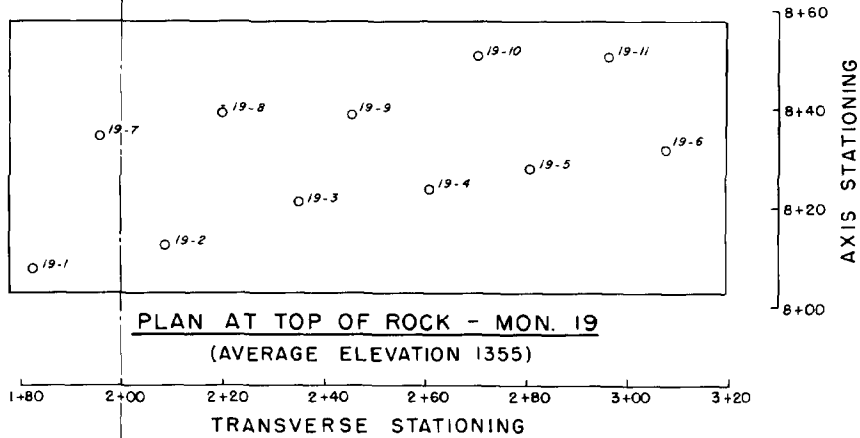
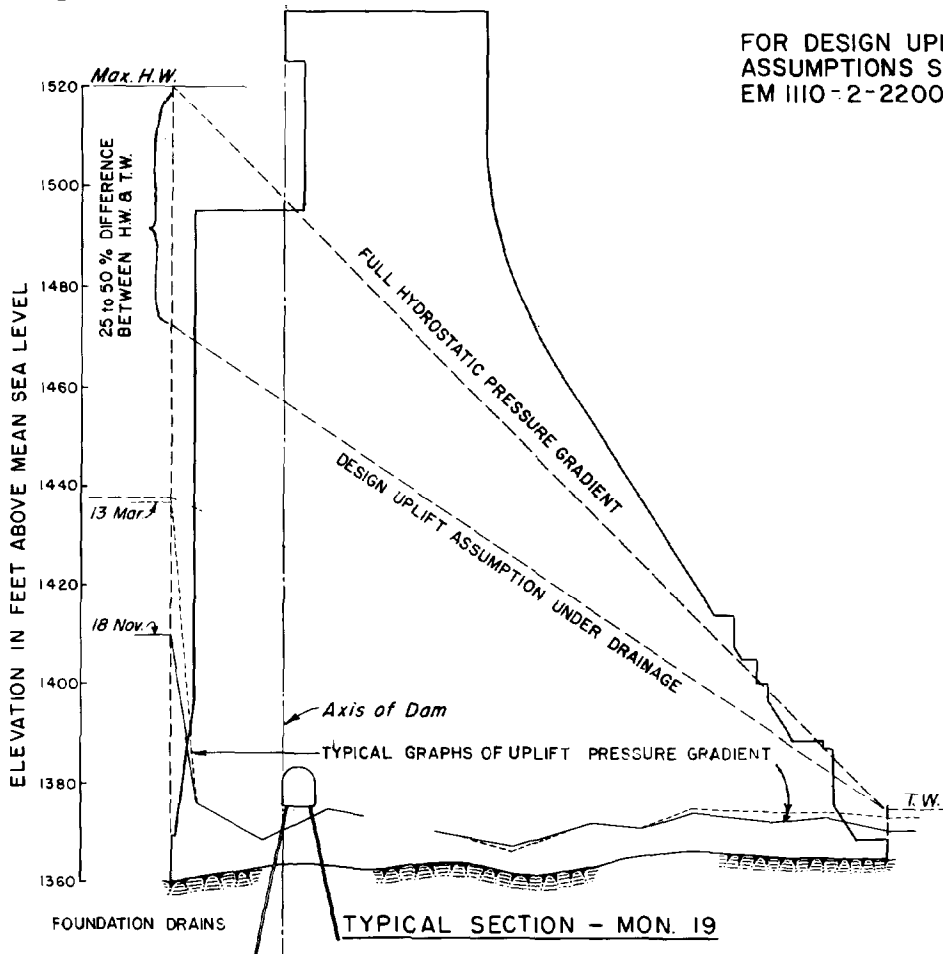

MANUALS - CORPS OF ENGINEERS
U. S. ARMY
ENGINEERING AND DESIGN
INSTRUMENTATION FOR MEASUREMENT OF STRUCTURAL
BEHAVIOR OF CONCRETE GRAVITY STRUCTURES
METHOD OF SHOWING
UPLIFT PRESSURE GRADIENTS
EM1110-2-4300 PLATE 3-4
(Prepared by CB-WBS) Plate 3-4

CHAPTER 4

PLUMBING INSTRUMENTS AND TILT MEASURING DEVICES

4-1. General.

a. Purpose. Plumb lines, inverted plumb lines, and optical plumbets are designed to accurately measure bending, tilting, or deflection of concrete structures resulting from external loading to the structure, temperature changes within the structure, sliding of the structures, or deformation of the foundation. Through the measurement of structural deformations they will furnish information in regard to the general elastic behavior of the entire structure and foundation, provide a means for determining the elastic shape of the deflected structure which will permit separation of load deflection and thermal deflection components, and, with precise alignment data, provide for estimating the amount of translation or sliding.

b. Location. These instruments should be located in structures where unusual structural deflections are anticipated or where information on deflections is required. They should be located in the highest monoliths of the structure and at locations where reading stations will be easily accessible. The conventional type plumb bob system should be installed in structures where provisions for installing a plumb bob line near the top of the structure with a reading station in the lower part of the structure can be made. Reading points are provided in one or more of the galleries in the lower portion of the structure and at other elevations if practicable, where the position of the plumb line with respect to the structure is measured by a micrometer microscope. Plumb bob systems based on an inverted pendulum or deflectometer may be installed in structures where a reading station cannot be constructed near the base of the structure, or where it is desired to extend the reference points into the foundation.

4-2. Description.

a. Plumb Line. The conventional plumb line system is composed of a vertical shaft, a suspension assembly, a plumb bob, line, and dashpot, a reading station, and a microscope and micrometer.

15 Sep 80

b. Shaft. The plumb line wire is housed in a vertical shaft, usually formed by embedding lengths of non-rusting rigid metal pipe in each concrete lift from the lowest reading station to the suspension point. Utilizing an elevator shaft or air vent for the plumb line shaft is usually unsatisfactory since the mechanical and air flow disturbances therein cause undesirable vibrations of the wire during observations.

c. Shaft Sizes. For deflection plumb lines of lengths up to 200 ft, an 8-in. diameter pipe installed with reasonable care will provide a clear projected opening of ample size to allow for maximum expected movements. A 12-in. diameter pipe is recommended for plumb lines exceeding 200 ft. Figure 4-1 shows a section of embedded pipe shaft in place, ready for placement of the next lift of concrete.

d. Suspension Assembly. The plumb wire is suspended at the upper end of the shaft by a suspension assembly as shown in Figure 4-1 and Plate 4-1. The suspension plate should be designed with a watertight cover to prevent moisture entry and corrosion of the wire.

e. Wire, Plumb Bob, and Dashpot. The wire suspending the plumb bob should be 1/32-in. diameter stainless steel or other high-strength corrosion resistant steel wire. Satisfactory results have been obtained at Libby Dam by using a 20-gage stainless steel wire equivalent to Federal specification QQ W 390C. The plumb line will have a tendency to stretch with time so a suitable means of adjusting for stretch in the wire should be incorporated at the upper end of the plumb bob shaft. The major amount of stretch should occur within one month of installation.

f. Plumb Line Damping. The plumb bob shall be a conventional or job-built cylinder of a weight sufficient to maintain the wire steady and free from unwanted vibrations. Past experience has shown that at least 25 lb is necessary to weight the line. To damp the pendulum action of the wire and plumb bob and to minimize local vibrations of the wire an oil-filled container is provided in which the plumb bob is immersed. This dashpot must be at least 8 in. in diameter in order to insure free deflection of the plumb bob, and about 10 in. in depth. It should be filled with a noncorrosive oil and fitted with a deflecting metal cover if moisture traveling down the sides of the shaft or the plumb wire might contaminate the oil.

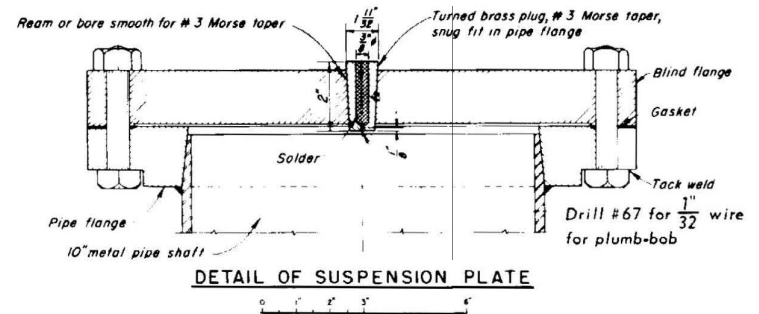
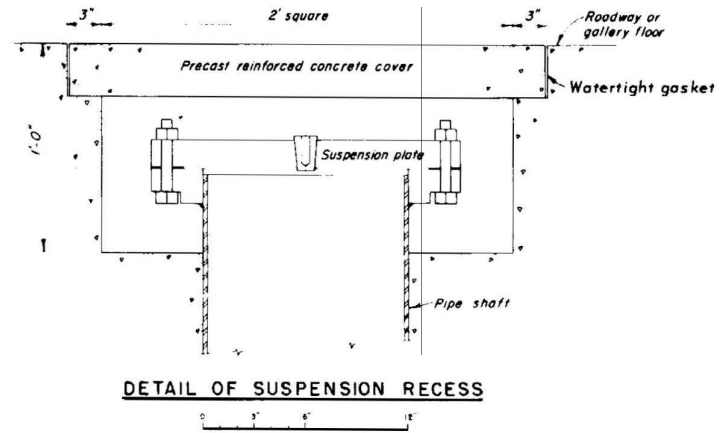
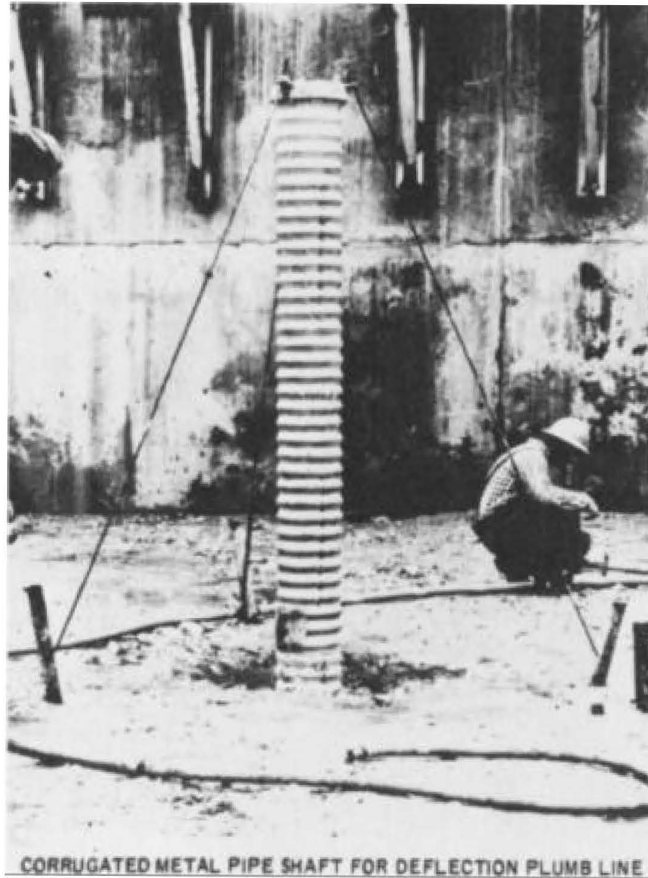

Figure 4-1 Corrugated metal pipe shaft at interface of a lift, and details of suspension plate attached on top of the shaft. (Prepared by CE-WES)

15 Sep 80

g. Reading Station Enclosure. The reading station should be located in the lower portion of the structure in the case of a conventional plumb bob system. It should be a recess in the concrete located in one of the galleries. The dimensions may be similar to those shown in Plate 4-1. The enclosure may also be used as a reading station for the inverted plumb line discussed later in this chapter. To prevent unauthorized access to the plumb line and reading station facilities, a sheet steel cabinet or doors should be provided at the recess. This also serves to eliminate undesirable plumb line movements sometimes caused by drafts. Illumination during readings is furnished by one or more adjustable spot lights, and a permanently lighted bulb or small strip heater will assist in reducing condensation and corrosion of the metal plates and bars within the recess. The cabinet doors should be provided with a suitable latch and lock.

h. Microscope and Micrometer. The movement of the structure is measured by the change in the distance between the plumb line and reference marks on the base plate attached to the structure. This is accomplished by measuring the distance between the plumb line and an etched line on the micrometer reference bar. The distance is read by a microscope mounted onto the reference bar at the reading station. Suitable instruments for this reading have been obtained from the Gaertner Scientific Corporation, 1201 Wrightwood Avenue, Chicago, Illinois 60614.

i. Reference and Microscope Support Bars. Within each reading station recess there are two 1/2-in. thick steel plates, welded together along one vertical edge at an angle of 90°. These plates are placed on edge, with the welded corner vertical, in a position such that the plumb line is located in the 90° quadrant formed by the plates. A pair of polished steel bars extend inward from and normal to each plate. One bar of each pair serves as a mount for the portable micrometer slide and microscope, while the second bar provides a surface upon which is inscribed a permanent reference point. A keyway is provided in the support bars to receive the keyed micrometer support clamp, and a flat face is ground along the reference bar. Machining and fabrication of the plates and bars must be carefully done in order to obtain true 90° angles. Originally the plate assembly was oriented at an angle of 45° with the structure axis, but this required adjustment computations to align the data to the movement of the structure. In recent years it has been more useful to orient the assembly with one plate parallel to the structure axis and the other perpendicular to it (in the case of arch dams, radially oriented) as seen in Plates 4-1 and 4-2.

4-3. Installation Procedures.

a. Recess. Forming the reading station recess to receive the microscope support rods and plates is a routine concrete construction procedure and is included with other form work.

b. Shaft. The plumb line shaft is made by installing lengths of metal pipe vertically from the top of the lowest recess up to the suspension point. Spiral welded steel pipe or corrugated metal pipe has been found satisfactory for this purpose. Special care in alignment and bracing is necessary to assure plumbness of the pipe sections and to insure a clear projected net opening approaching the full size of the pipe. Figure 4-1 shows one bracing arrangement which has been used.

c. Suspending the Plumb Bob. The plumb bob should be suspended from the center of the net opening of the plumb line shaft. This point must be located on the suspension plate so that the wire will hang from the suspension plate over the center of the shaft. It can be located by suspending a temporary plumb line from a transit located over the shaft. The plumb line should be sufficiently long to reach from the transit to the top of the reading station. A sheet of cardboard is secured in place directly beneath the lower end of the shaft, and a pattern of the clear projected net openings of the pipe established by marking the positions of the plumb bob as the suspension cord is moved around the periphery of the pipe at the top of the shaft. The plumb bob should be allowed to come to rest at each of the eight or ten points required to define the clear opening pattern. With the cardboard still in place the center of the pattern is established to within 1/4 in. and projected to the top of the shaft by means of the temporary plumb line. The permanent plumb line will be set as close to this center point as possible.

d. Permanent Installation. Installing the permanent plumb bob must be done with care to avoid kinks and twists in the plumb wire. The wire is threaded through the collet in the plug, through the suspension plate and attached to the plumb bob as shown in Figure 4-2. With a conventional plumb bob the cap may be removed and the connection made by threading the wire through the hole in the center of the cap, the interior of which contains a cone-shaped recess. The wire is twisted around a short nail lodged in the cone-shaped recess and hot solder poured in to cover the nail and fill the cup. After the solder has cooled, the cap is lowered through the shaft to the reading station as in Figure 4-3. When the plumb bob cap is at the level of the damping pot, the cap is screwed onto the bob, lowered into the damping pot and sufficient oil added to cover the plumb bob. The freely suspended bob is adjusted to an elevation just below the oil level in the dashpot, and the wire securely fixed at the suspension point.

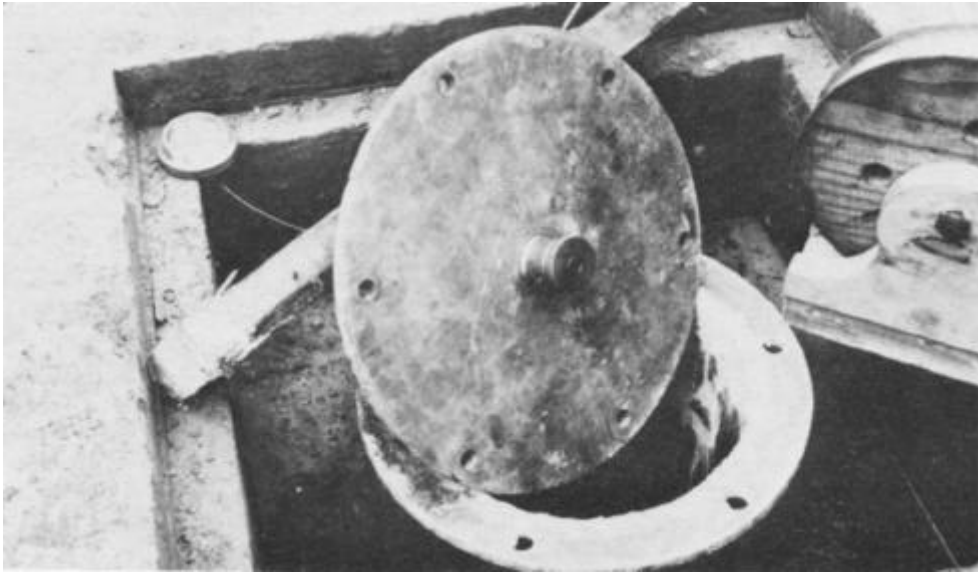

Figure 4-2. Attaching Wire to Plumb Bob Cap (Courtesy of the Tennessee Valley Authority).



Figure 4-3. Lowering Plumb Bob Cap and Wire Through Suspension Plate (Courtesy of the Tennessee Valley Authority).

e. Tightening the Plumb Wire. Since the wire is subject to stretching under the weight of the plumb bob, the attachment at the suspension plate should be made to be permanent but should have provisions for removing the slack as the wire stretches. Where the suspension point will continue to be reasonably accessible, the closing nut of the spring collet is tightened to securely grip and hold the plumb line wire. For suspension points which will become inaccessible, the spring collet may be eliminated, and the wire wrapped around a short nail, placed in a cone-shaped cup in the top of the suspension plate, and the cup filled with hot solder. In the situation where the suspension point will become inaccessible provisions for removing the slack in the wire should be made at the plumb bob end. For protection of inaccessible suspension points, two coats of red lead paint should provide the necessary protection.

f. Laying Out the Reading Station. The suggested layout of the reading station should be similar to that shown in Plate 4-1. Each station should consist of a recess in the concrete adjacent to a gallery or other accessible space containing access from above for the plumb line shaft, the reading apparatus and support assembly, adequate lighting to illuminate the reading apparatus, heating equipment to minimize moisture condensation and a dashpot filled with oil to dampen movement of the plumb bob.

(1) The position of the two microscope mounts and two reference bars attached to the bar support plates should depend upon the following:

(a) Maximum expected movement of the plumb line.

(b) Mechanical working distance of the microscope. This is the distance, in inches, from the front of the objective lens mount to the object plane.

(c) Length of telescope draw tube travel. This is the external range of the rack and pinion movement of the objective lens mount.

(d) Offset dimensions of the micrometer support clamp.

15 Sep 80

(2) The first step in determining this positioning is to establish the expected extreme positions of the plumb line shown in Plate No. 4-2. The range of annual movement in a direction normal to the axis of the dam is determined by adding the structural deflection due to a full reservoir water load to an estimated annual temperature deflection cycle. Both the annual temperature deflection cycle and the same cycle modified by the maximum load deflection are superposed upon the estimated permanent thermal deflection to obtain the maximum possible range normal to the axis of the dam. Since transverse movements are generally small and impossible to predict with any degree of accuracy, the transverse range of the plumb line is estimated to be at least one eighth of the total estimated upstream-downstream movement on each side of the initial position of the plumb line.

(3) The second step consists of determining the length and position of the reference bars and establishing the required size and characteristics of the microscope and micrometer slide. The shaded rectangle in plate No. 4-2 represents the area of extreme plumb line movement previously established, and the reference bars should be located as close as possible to the sides of this shaded area to increase reading accuracy. The optical characteristics of a selected microscope are laid off on the diagram to establish a position of the microscope from which the reference bar and plumb line may be viewed satisfactorily without interfering with plumb line movements. Modification of the mechanical working distance of the selected microscope is possible by substituting an objective lens with a different focal length. It is generally good practice to provide for at least 2 in. of clear distance between the end of the microscope and the plumb line movement rectangle, or more where the plumb line is exceptionally long or where foundation deformations may be considerable. The required range of the micrometer slide is determined by projecting the extremes of the movement rectangle upon the reference bar, and a micrometer slide selected which is capable of reaching each end of this projected dimension from the proposed location of the reference mark.

(4) The third step locates the position of the microscope support bar with respect to the reference bar. With the distance from the end of the microscope to the reference bar determined, the location of the micrometer slide which will receive the microscope is established. The dimensions of the clamp holding the vertical rod which supports the micrometer slide determines the position of the support bar with respect to the reference bar. The support bar is located at an elevation such that the microscope line of sight and the reference bar are in the same horizontal plane.

(5) After the bar sizes and locations have been worked out initially on the drawing board, and before fabricating the plates and bars, it is recommended that the dimensions and details be checked by a full-size mockup. The plates may be of wood, with holes drilled to receive the steel reference and support bars. Sightings with the microscope and micrometer slide should be made on a short length of plumb line suspended at extreme, as well as intermediate, positions to test the design layout.

g. Microscope and Micrometer Slide. The microscope and micrometer slide should be procured by the Government prior to installation of the plumb bob or fabrication of the bar support plates. Information on diameter of shaft, the mechanical working distance of the microscope and method of attachment of the micrometer slide to the reference bar will all be used to determine the size of the reference bars and position of reference and rider bars on the support plate. Gaertner Scientific Corporation, 1201 Wrightwood Avenue, Chicago, Illinois 60614, manufactures microscopes that insert in micrometer slides. Other manufacturers may also make acceptable microscopes and micrometers; this is just one source that has been used in the past with good results. When the plumb line movement is expected to be limited to a square having an area of 1-1/2-in. on a side, Gaertner model M101A microscope and micrometer slide with special modified mount model M301AD may be used. When a 4-in. square deflection area is considered necessary, it can be obtained by using Gaertner model M533 microscope, and micrometer slide model M303A.

h. Alignment. The plumb bob and wire, suspension plate and bar support plate may be procured and installed by a contractor but coordination between the contractor and Government forces familiar with instrumentation is necessary, and final fabrication of the suspension plate and bar support plates should be withheld until information on actual installation of the shaft is completed. Setting the bar support plates, and machining and aligning the bars must be carefully done by a competent machinist, and the assembly checked repeatedly during erection by the engineer responsible for the instrumentation installation. Reliable deflection measurements demand the closest possible alignment between the parts and angular accuracy not exceeding 0.5 degree. The plates should be firmly secured in their proper position by backfilling behind the plates with concrete or by welding to anchor bolts in the floor or sides of the reading station recess.

15 Sep 80

1. Marking Reference Points. A permanent reference mark is scratched on the flat surface of each reference bar in the following manner; the vertical cross hairs of the microscope are aligned with the plumb line and the microscope then focused on the reference bar. With a straight edge or metal rule placed firmly against the reference bar and being plumbed by reference to the cross hairs, make a vertical scratch on the reference bar by one pass of a razor blade along the edge of the rule. A second, diagonal scratch is added, and the two scratches rubbed down to very thin lines with crocus cloth or fine abrasive powder. The point of intersection of the two lines is used as a base for referencing all subsequent positions of the plumb line.

j. Location of the Scribe Marks. By placing the reference scratches just upstream or downstream of, or towards the right or left abutment of, the plumb line travel area, all subsequent measurements of the plumb line will always be made to one side of the reference mark, and the error of identifying the direction of movement will be eliminated. The micrometer slide range should also be considered in locating the scribe mark so that it will not be exceeded by placing the mark so far downstream that the maximum measurement upstream may not be obtainable. If a micrometer with range smaller than the expected maximum plumb line travel is used, the reference marks should be scribed midway between the limits of expected plumb line movement. If this latter reference mark location is adopted, a thick stripe of colored enamel should be applied longitudinally along the flat face of the reference bar on one side of the reference point, and a contrasting colored strip on the other side of the point, to visually assist and remind the observer to recognize and record the position of the plumb line with respect to the reference mark. The scribe mark and initial readings should be performed by an instrumentation engineer familiar with the microscope and plumb bob system operation. The instrumentation engineer should train at least two of the project operating personnel in the use of the microscope and micrometer slide as these are precision instruments which require detailed instructions on their care and use.

4-4. Maintenance and Care of Equipment.

a. Reading Station Facilities. A light film of oil rubbed over the reference and support bars at the conclusion of each observation will afford supplementary protection against corrosion. This oil film, and any moisture condensation, should be wiped off when readings are made. Normally the only maintenance required for the plumb line will be keeping the oil-filled damping pot filled to the proper level, and checking to make sure that excessive stretching of the plumb wire has not occurred. Additionally, the light bulb or heating element in the reading station should be checked periodically to insure that it has not burned out.

15 Sep 80

b. Micrometer Slide and Microscope. The micrometer slide and microscope should be stored in their carrying case in a safe, -dry place, not in the reading station. Since they are precision instruments, they must be handled with care at all times. One or two drops of light lubricating oil applied to exposed screw threads and sliding surfaces of the micrometer at intervals of several months should be sufficient to keep the instruments lubricated.

4-5. Collection of Data.

a. Observation Technique. The microscope and micrometer slide are precision instruments designed for precise laboratory work, and should be used in a manner conforming to good laboratory practice. So far as practicable, all microscope readings should be made by the same individual, thoroughly familiar with procedures prescribed herein. Whenever it becomes necessary to change observers, either for a short period of time or permanently, the recommended step-by-step operations to be followed in making readings should be carefully explained and demonstrated to the new observer. A written instruction sheet usually will be found indispensable.

b. Recommended Procedure for Plumb Line Deflection Observations.

(1) Slide clamp, micrometer rod and collar, and micrometer onto the support bar, insert microscope, and clamp entire assembly in a position such that the reference mark and the plumb line fall within the range of the micrometer slide.

(2) Adjust position of micrometer rod and collar so that the microscope horizontal cross hair is slightly above or below the reference mark, and the plane of the micrometer slide movement is parallel to the reference and support bars. If the micrometer rod is properly keyed to the rod support clamp, this latter step is not necessary. Otherwise some other means must be used to assure that the microscope line of sight is exactly perpendicular to the reference bar. Sighting through the microscope into a small mirror held against the flat surface of the reference bar, and twisting the micrometer assembly until the cross hairs and their reflection coincide, may serve to determine the proper position.

(3) With the objective lens out of focus, focus the eye piece sharply on the system of cross hairs.

(4) For the next four steps, the positions of the micrometer rod and assembly support clamp must not be disturbed. Focus objective lens on the reference bar. By use of the micrometer slide wheel, move the slide and microscope well to the left of the reference mark, and then bring the slide back slowly until the reference mark is centered at the cross-hair intersection or between the parallel vertical hairs. Stop the cross hairs precisely in the proper position; do not attempt to make slight adjustments by reversing the wheel motion. If the reference mark is "overshot", move slide to far left and start again. Read and record micrometer slide position.

(5) Repeat operation, approaching reference mark from the right, and record micrometer slide position. By approaching the reference mark both from the left and from the right, the effect of any slack in the gears and cogs of the slide mechanism will be eliminated.

(6) Focus objective lens on plumb wire. By means of the micrometer slide wheel, move the slide and microscope well to the left of the left edge of the plumb wire, and then bring the slide back slowly until the intersection of the cross hairs or the two vertical parallel hairs are centered on the left (or near) edge of the plumb wire. Do not adjust position by reversing wheel motion. Read and record micrometer slide position. Then continue movement of the slide until the cross-hair pattern is centered over the right (or far) edge of the plumb wire. Read and record micrometer slide position.

(7) Repeat operation, approaching plumb wire edges from the right side, and read and record micrometer slide positions.

(8) Visually observe and record the relative position (upstream or downstream) of the plumb wire with respect to the reference mark. The difference between the average of the Step 4 and Step 5 readings and the average of the Step 6 and Step 7 readings represents the dimensional position of the plumb line with respect to the reference mark.

(9) Repeat Steps 4 through 8 twice more from the same support bar.

(10) Repeat Steps 1 through 9 for the second pair of support and reference bars.

c. Reading Schedules. Initiation of the long-time observation program early in the life of the structure will provide data on the effects of cooling and temperature adjustments within the structure, early deformations of the foundation, and deflections of the structure under first applications of load. When a plumb bob system is being installed in an existing structure, the early pattern or readings will establish the movement of the structure such that at later dates less frequent measurement can be made.

d. Frequency of Readings. Daily readings should be made for about the first two weeks in order that the observer may become familiar with the equipment and procedures. A program of observations at weekly intervals should be followed for the first year, to define the range of cyclic movement and obtain detailed information on initial deflections. After this period a reading interval of about two weeks will adequately define the annual deflection cycle under normal reservoir operations. Observations at intervals of greater than a month are of little value. At least one reading should be made when the reservoir level approaches or reaches the maximum design pool elevation. Reading schedules should become more frequent in periods of extreme temperature or other conditions of nature where it is suspected that abnormal deflections may occur.

e. Special Observation Schedules. One or more special observation series may be required at selected installations to determine the amplitude of the daily movement cycle. Readings at intervals of two hours over a period of 24 or 48 hours, twice annually, are generally specified. Data obtained permits the determination of the magnitude of deflections due entirely to changes in surface temperatures of the structure, since external loads and annual temperature cycle adjustments will not vary significantly during the short observation period.

f. Supplementary Data. Reservoir pool and tailwater elevations (to the nearest foot) existing on the dates of observations must be included in the measured deflection records. A daily record of water surface elevations is more useful, and is usually available from routine project operation records or from other instrumentation data. Air temperature readings, from a recorder or from hourly observations, are required in connection with the special deflection observations series. Average monthly air temperatures for each month of long-time observation data are sufficient.

g. Coordination with Other Readings. The plumb line readings should be taken at the same time as the alignment readings are taken to allow an accurate pictures of the total movement of the structure.

15 Sep 80

4-6. Processing of Data.

a. Field Data Sheets. Micrometer slide readings for each of the three (or more if required) trials from each of the two microscope support bars at a reading station are recorded on a single field data sheet for each plumb line observation. This sheet is shown on Plate 4-3. Not only should the position of the plumb line (upstream or downstream or towards the left abutment or right abutment of the reference mark) be noted on the field sheet, but a scheme for identifying each of the two reference marker bars at a reading station must be adopted. This may be done by designating the reference bar on the right of the plumb line (nearest the right bank of the stream) as the A-bar, and the other the B-bar. Other schemes may be equally satisfactory, providing the meaning of the terminology is explained and is used consistently. Space is provided on the field sheet for noting weather conditions, dates, times, and similar data which frequently proves useful in interpreting unusual results. The field data sheets should be retained permanently, as they represent original and irreplaceable field notes.

b. Reduction of Data. The field data should be forwarded to the Engineering Division for computation and evaluation. The values of deflection can be directly read from column 13 of the Field Reading Sheet with the proper sign applied to this value. These values can be inserted into a deflection computation sheet similar to that shown in Plate 4-4 for a time history of deflection.

c. Presentation of Results. The deflection history plots (plate No. 4-4) should be prepared for the two principal directional movements at each reading station from the deflections computed on the data record sheets. The purpose of this initial plotting is to detect significant error in either the field observations or the data reduction operations, to eliminate minor discrepancies in the deflection movement cycle, and to provide deflection values at intermediate dates. The preparation of the history plots is the final step in the field data collection program.

4-7. Inverted Plumb Line.

a. General. The inverted plumb line is similar in construction and operation to the conventional plumb line. It consists of an anchor at the base or foundation, a plumb wire, and a float assembly at the top end of the plumb line. The float moves freely in a container of oil and establishes the plumbness of its wire from being perpendicular to the surface of the oil. It is used in conjunction with conventional plumb lines to extend the length of measurable plumb path and to make reading of a long path easier since both reading stations can be combined in the same opening.

15 Sep 80

b. Alternate Inverted Plumb Line. It is recommended that an inverted plumb line that is read directly beneath the float be used. It is also recommended that the inverted plumb line be located in the same monolith and reading station as the conventional plumb lines. However, if a situation arises where there are no convenient galleries, or it is desired to run the inverted plumb line from foundation to top of structure, an alternate type of inverted plumb line can be used. This system is shown in Plate 4-5, drawing 1, 2, and 3 of 3. The system is different in that the wire is not read as the moving element but a pair of cross hairs that are scribed on the top nut of the float and these cross hairs are read from above the float through a plexiglass cover. The cross hairs are read through a micrometer operated microscope mounted on the plexiglass cover. This system, shown in Figure 4-4, provides an alternate method of inverted plumb readings when galleries are not available. Since the wire is not the part of the system that is read, some errors due to twist of the float may be expected and the reading of the cross hairs can be hampered by condensation on the underside of the plexiglass.

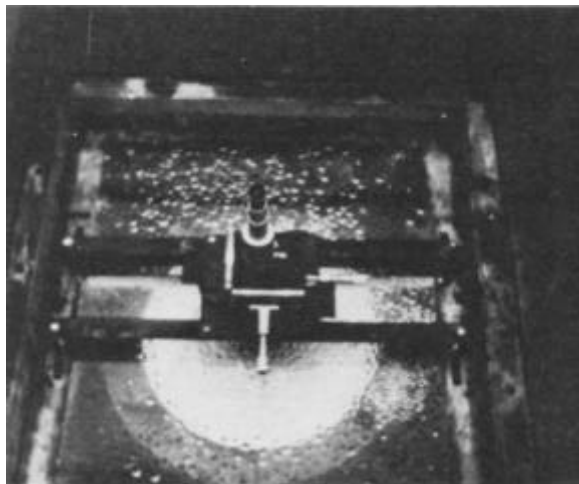

Figure 4-4. Float and Reading Assembly of Alternate Inverted Plumb Line.
(Photo by WES)

15 Sep 80

c. Description of Components. The shaft and plumb wire requirements for the inverted plumb line are the same as for the conventional plumb line. The float assembly is the most changed from the conventional plumb line. It consists of a doughnut-shaped tank into which a doughnut-shaped float is placed and the container filled with oil. The float has the plumb wire attached to its center and the wire runs through the center of the doughnut-shaped tank as shown in Plate 4-5. The wire is weighted at the other end with a weight of approximately 25 lb similar to the conventional plumb line.

d. Installation.

(1) Anchor. The shaft can be drilled to the bottom of the monolith or can go into the foundation. The plumb wire is anchored to either a plate that is grouted into the bottom of the shaft or attached to a heavy weight that is cone-shaped on its bottom and sits in a cone-shaped receptacle grouted into the bottom of the shaft. The latter method is preferred since the weight can be retrieved if the wire should break and reinstallation is a simple procedure of repairing the attachment to the weight and lowering the weight back into its cone-shaped seat.

(2) Float Assembly. The tank and float should be installed directly above the reading station such that the length of wire that will be read for dam movement is close to the float. The tank should be supported on a frame that rests on the bottom surface of the readout station, and not secured to the concrete above the readout station. This prevents the possibility of the tank dislodging from the concrete and falling to the surface of the station. The oil should be put into the tank until the tension on the plumb wire is sufficient to keep the wire from vibrating.

(3) Readout Station. The inverted plumb line should be located in the same monolith with the conventional plumb line such that the same readout station that is used for the conventional plumb line can be used to read the inverted plumb line. The height of the readout station should be constructed so as to be comfortable for the personnel who will be reading the instruments. A reading light should be installed in the blackout such that it will provide proper illumination of the wire when it is to be read. A portable light constructed from the lantern from a miner's helmet and a moldable substance such as modeling clay can be made that will allow the operator to place his portable light exactly where he wants it. This light can be carried from station to station by the instrumentation party.

e. Data Collection. Data are collected in the same manner as is described in Paragraph 4-5. The reading schedule should also be as outlined in Paragraph 4-5.

4-8. Optical Plummet.

a. General. The optical plummet works on the principle of line-of-sight readings rather than the reading of the movement of a wire that is under the influence of gravity. Since they do not measure wire movement, they must rely upon bubble levels or mercury reflectors to keep the reading line precisely vertical. The more accurate plummets use the mercury reflectors making use of the reflection of the reading line-of-sight from the surface of a pool of mercury which is perpendicular to the vertical. Since these instruments operate on optical principles, they are susceptible to errors that are caused by refraction of light waves. Various errors can occur due to the atmospheric conditions between the plummet and the target, which become larger as the distance between the two increases. Also, changes in atmospheric density and temperature between the instrument and target cause refraction and distortion of the light waves which, in turn, cause small errors in the reading.

b. Accuracy. The optical plummets that have the highest accuracy are those which use a mercury horizon for reference to the plumb. These instruments have an accuracy of 1 in 300,000 or approximately 0.01 in. in 328 ft. One such instrument that has shown sufficient accuracy for high precision power dam surveys is the Wild GLQ Precision Nadir Plummet with mercury horizon, shown in Figure 4-5. It is available from Wild Heerbrugg Ltd., CH9435 Heerbrugg, Switzerland, on a special order basis. It is recommended that if it is desirable to use an optical plummet for vertical plumbing, that the less accurate plummets that rely on bubble levels not be used since a more precise method is available through the use of the inverted or conventional plumb line.

c. Description.

(1) Instrument. The instrument consists of a telescope mounted on a rotating base that is graduated in degrees. The location of the telescope on the rotating base is controlled by a micrometer such that the position of the cross hairs in the telescope eyepiece is always described by a rotation and a translation. The-entire instrument sits on a ring that has three self-centering holes arranged in a triangle with unequal legs such that the instrument will always be mounted in the same manner for each reading.

(2) Targets. The targets on which the instruments are sighted are of the fixed variety. They should have graduated blocks of a known width, such as 1 or 2 cm painted on the surface for obtaining the movement of the structure. The smaller the blocks, the greater the plumbing accuracy.

EM 1110-2-4300
15 Sep 80

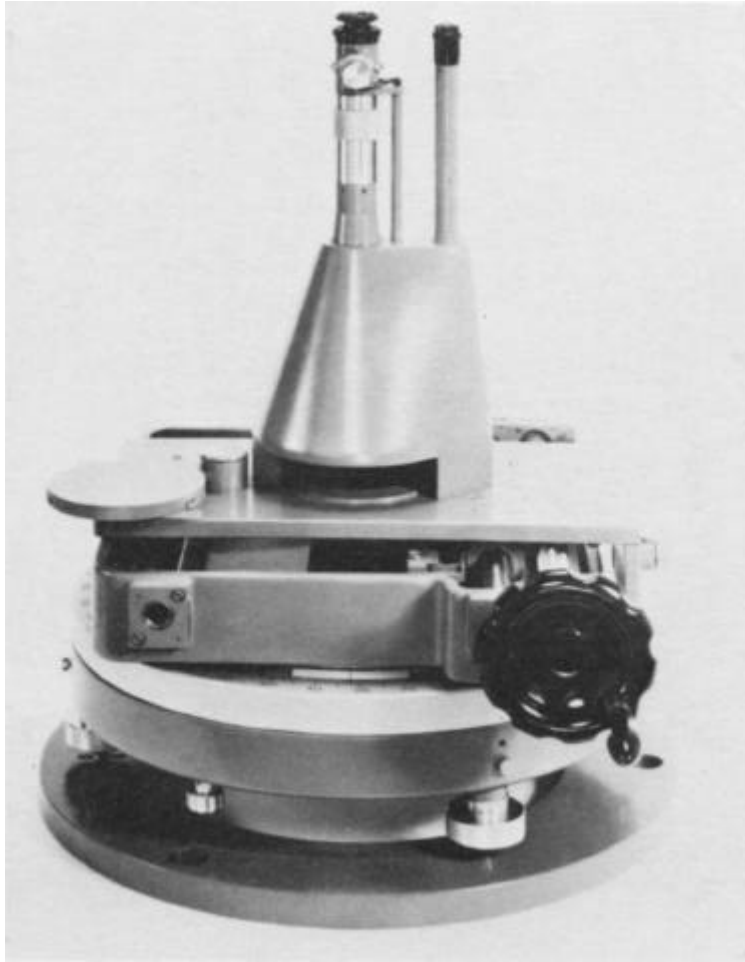

Figure 4-5. Wild GLQ Precision Nadir Plummet (Courtesy of Wild Heerbrugg Ltd.).

(3) Shaft. The shaft that holds the targets can be any convenient diameter, but it should be large enough to allow easy reading of the targets along its length. The targets should be spaced along the length of the shaft from top to bottom in order to get both relative movement and overall monolith movement (with respect to the base or foundation) and they should be well lighted for easy readability. If the air in the shaft should become heated, then the heat will affect the optical sight line and produce distorted readings; for this reason, the light sources used to illuminate the targets should be cool, fluorescent-type bulbs that do not distort the light waves.

- * 4-9. Tilt Measuring Instruments. The tilting or deflection of concrete structures resulting from external loads, temperature changes, or deformation of the foundation is a vital piece of information for evaluating structural safety and stability. This section provides information on types of instruments that are available, both commercially and by special construction, that are capable of measuring tilt in concrete structures. Some of these instruments were designed to measure tilt and some were designed for other uses but are adaptable to tilt measurement. Some measure surface tilt only, while others can measure tilt at various elevations within a structure.

4-10. Instruments that Measure Tilt Through a Structure. These instruments, most generally, are devices that are lowered through some sort of pipe, borehole, or channel that has been constructed in the structure. The instrument is not fixed to the structure but moves through this channel taking readings at desired locations through the structure.

a. Digitilt Inclinator. This instrument, manufactured by Slope Indicator Co. of Seattle, Washington, is mainly designed for measuring lateral movements in earth embankments and rock foundations. However, it can be installed in concrete structures to make tilt measurements.

(1) Description. The sensor is shown in Figure 4-6 along with its digital read-out indicator. The sensor is 36.5 inches in length and has an outside diameter of 1.69 inches at the body. Two pairs of spring-loaded wheels at the top and bottom of the sensor guide the sensor when inserted into the casing which is either an aluminum or plastic tube having four lengthwise grooves spaced 90 degrees apart on its inside circumference. These grooves guide the sensor in two orthogonal directions of measurement. The electrical cable connected to the sensor is 0.42 inches in diameter, six-conductor cable with a 1/16-inch stranded steel center wire to support any tension on the wires. A water-proof neoprene cover surrounds the wires and the cable has external markings at each 1-foot increment. This inclinometer has the overall sensitivity of one part in 10,000 or to .0001-foot lateral movement per 2 feet of casing.

(2) Installation Procedures. The only portion of the instrument that is permanently installed in the concrete structure is the inclinometer casing. This portion of the instrument is fitted into a borehole and then backfilled with a suitable supporting material (generally a cementitious grout). The borehole should be approximately 8 inches in diameter. This will,

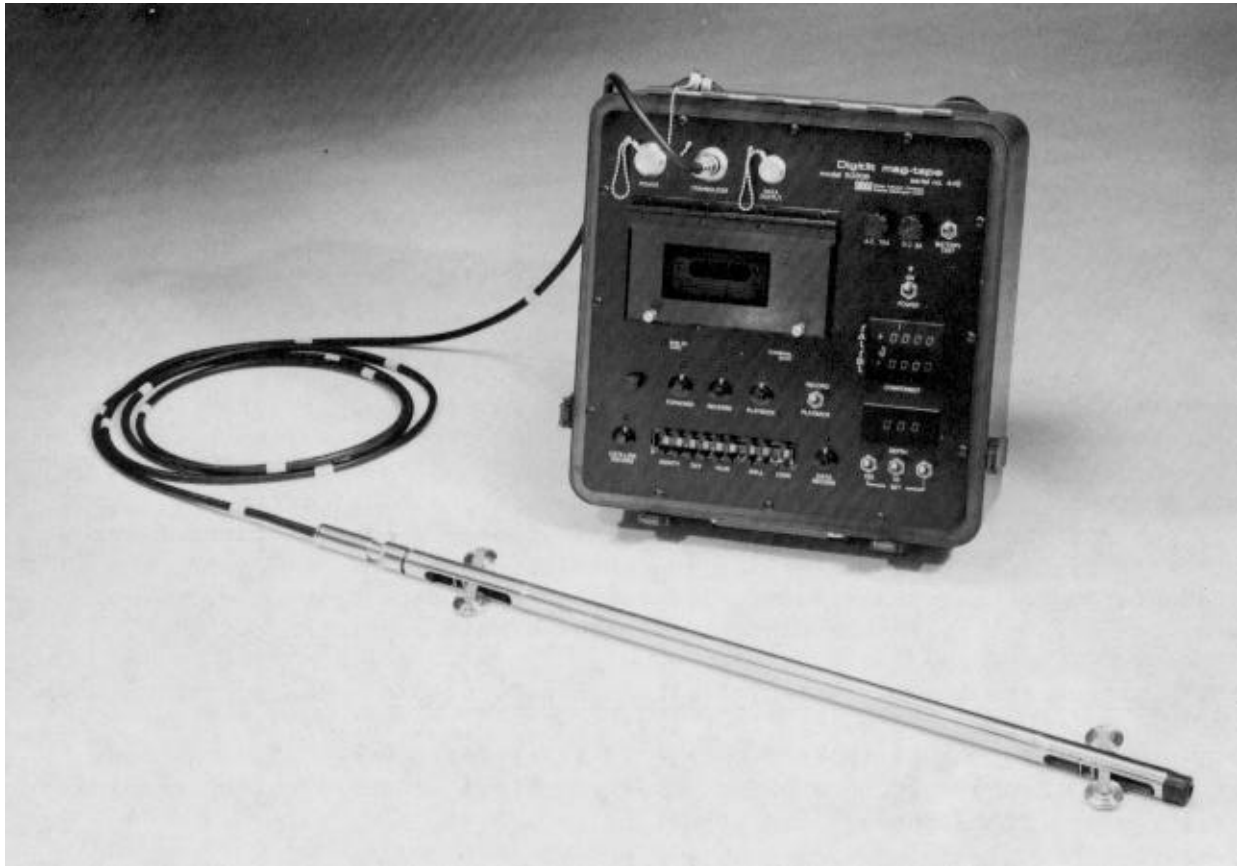

* Figure 4-6. Digitilt Inclinerometer and Digital Readout Indicator

accommodate all sizes of inclinometer casings. The borehole is drilled to below the elevation where measurement is required. Both the aluminum and plastic casings are installed in either 5- or 10-foot sections. The sections are butted together and joined by means of a sleeve that is pop riveted to the sections on each side of the joint. Care should be taken in the joining process to minimize any possible spiral of the grooves in the casing. As each successive section of casing is added to the previous length, the grooves must be aligned with the grooves in the previous section. Care should also be taken to install and backfill the inclinometer casing so that it remains vertical. This is not critical with respect to reading the instrument since the first set of readings produces a baseline condition, and all subsequent readings are relative to the baseline; however, the less vertical the casing is, the smaller the reading range becomes.

(3) Method of Operation. The sensor consists of two servo-accelerometers, one with its sensing axis in the same plane as the spring-loaded wheels and the other at 90 degrees to the first. Changes in tilt with respect to the vertical move a servo-accelerometer. This circuitry produces a restoring current, the magnitude of which is a measure of the tilt. The voltage output from the circuit is proportional to the sine of the angle made *

*between the longitudinal axis of the sensor and the vertical. Sensor elements housing the 0.5-gram accelerometers have a range of operation through ± 30 degrees from the vertical, while 1.0-gram accelerometers can function through ± 90 degrees from vertical. The voltage output from the sensors is sent to a digital read-out indicator where the output is displayed on an illuminated digital display. A more sophisticated method of read-out is provided by means of a magnetic tape indicator (Figure 4-6) that will record the sensor voltage output directly on tape as well as display the voltage digitally.

(4) Data Collection. Output data are read with a four-digit bipolar digital voltmeter. It is self-contained and runs on a 6-volt rechargeable battery which allows operation for a period of 8 hours before requiring recharging. The output is given as a voltage that represents a variation from the vertical through the equation:

$$\theta = \sin^{-1}(V/2)$$

where θ = angle, in degrees, made between the longitudinal axis of inclinometer and the vertical.

V = output voltage read on the indicator.

The inclinometer is lowered to the bottom of the casing by the connecting cable, and readings are taken at intervals as the inclinometer is raised from the bottom of the casing. The voltage reading is transferred to field data sheets for later computations. An alternative read-out device is available that eliminates the possibility of errors obtained by misreading or miscopying the manual read-out. The device is a magnetic tape recorder that automatically records the output on tape. This tape can then be read into a computer for automatic processing of the raw data.

(5) Care and Maintenance. The inclinometer and its indicator are not part of the permanent installation and, as such, are not subjected to continuous field weather conditions. They should be given the same care that any sensitive field instrument is given. The indicator casing remains in the field at all times. By virtue of its construction, either plastic or aluminum, it is generally maintenance free; however, the casing should be protected by a cap that is designed to prevent debris and water from entering when the casing is not being used.

b. Slope Indicator. This instrument is similar to the Digitilt inclinometer but is less sensitive to tilt due to its method of operation. It is a less expensive instrument manufactured by the same company, but can be used to make tilt measurements.

(1) Description. The slope indicator is shown in Figure 4-7. It is 2.38 inches in diameter and 15 inches in length. It is connected to read-out instrumentation by a cable similar to the Digitilt inclinometer. It is guided through its casing by a set of spring-loaded wheels also similar to the Digitilt inclinometer. *

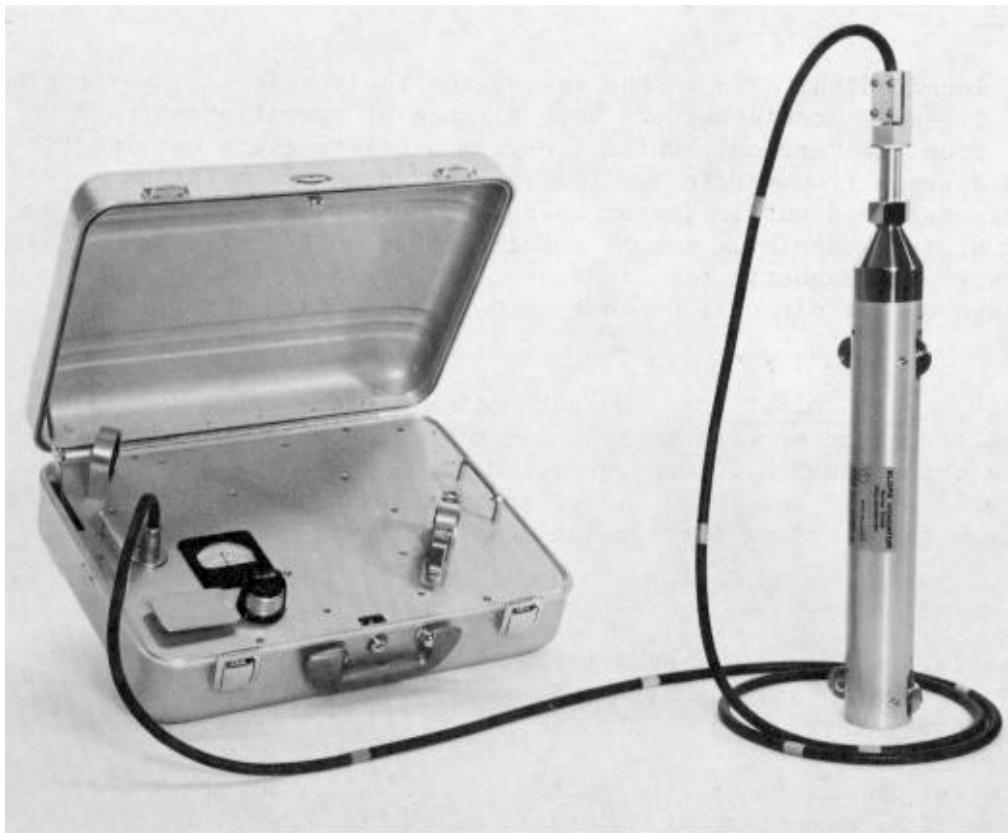

* **Figure 4-7.** Slope Indicator Series 200B Inclinerometer With Reading Instrument

(2) Installation Procedures. The instrument casing is the only portion of the instrument that is installed, and its installation is the same as that described for the Digitilt inclinometer.

(3) Method of Operation. The Slope Indicator instrument consists of a pendulum-actuated conventional Wheatstone Bridge circuit within the sensor. The pendulum contacts a fixed resistance element which subdivides the element into two resistances forming one-half of the Wheatstone Bridge. The other half of the bridge is contained in the control case in the form of a 10-turn precision potentiometer which is manually operated to balance the bridge. The 10-turn potentiometer is coupled to a counting dial reading from 0 to 1000. The inclination of the instrument is proportional to the potentiometer dial reading when the circuit is in balance. The instrument has a sensing range of ± 12 degrees from the vertical. It has a sensitivity of 1 part in 1000, which means it cannot measure tilt of less than 3 minutes of arc.

(4) Data Collection. Data are taken by balancing the Wheatstone Bridge. A potentiometer in the bridge is coupled to a counting device registering from 0 to 1000. The number read from the counter when the bridge is balanced is proportional to the angle of tilt of the instrument. Raw data of counter readings are taken in the field and later reduced to angle of tilt. *

* (5) Casing Spiral. As mentioned earlier, spiral of the grooves in the inclinometer casing will cause errors in instrument readings. Consequently, inclinometer installation extending to a depth greater than 50 feet should be checked using the spiral meter developed by MRD Laboratory* or other proven devices to measure the angular change of grooves in the casing for the purpose of correcting the displacement direction as measured by tiltmeter data.

c. Wall Deflection Pipes. Several instruments that fall under the category of instruments that measure tilt through a structure must be installed in the structure during its construction. These instruments rely on a shaft or casing that has been cast into the structure in order to make their measurements. Two instruments requiring shafts are the plumb line and the optical plummet referred to earlier in this chapter. The instrument that requires a cast-in-place casing is the wall deflection pipe.

(1) Description of the Instrument. The wall deflection pipes and deflectometer (Figure 4-8) are designed and constructed at the U.S. Army Engineer Waterways Experiment Station (WES). The equipment consists of a deflectometer, which is a compound vice and two dial deflection gages, a plumb bob attached to the deflectometer, and a casing which is made up of flanged sections of 5 inches inside diameter iron pipe. The casing extends from the top of the structure down to a point below where the lowest reading is to be taken. At each joint between pipe sections, there are mounted four silver-plated brass contact rods oriented around the inside wall of the pipe with each rod at 90 degrees to the adjacent rod. They serve as contact points inside the pipe.

(2) Installation Procedures. Proper alignment and plumbness of the deflection pipe are important in the installation procedure. The pipe base plate installation is most important with respect to alignment. It is installed in the monolith at an elevation approximately 5 feet below the elevation of the first instrument reading point. Three anchor bolts are cast into the top of the previous concrete lift such that they will be properly aligned with the three slotted holes in the base plate shown in Figure 4-9. The base plate is leveled by adjusting nuts on either side of the plate flange and serves to hold its alignment. It is important to align the scribe cross hairs on the base plate parallel to the two orthogonal directions in which measurements will later be taken. If the base plate is not properly aligned, none of the pipe sections will be properly aligned since they all key on the base plate. When the base plate has been properly aligned and leveled, the nuts on the anchor bolt are tightened. The leveling and alignment should be checked after tightening the nuts and the first pipe section then placed on

* The equipment and an operator can be made available to Divisions and Districts upon request. Inquiries should be directed to the Director, MRD Laboratory, 420 South 19th Street, Omaha, Nebraska 68102, phone (402) 221-3207, FTS 864-3207.

*

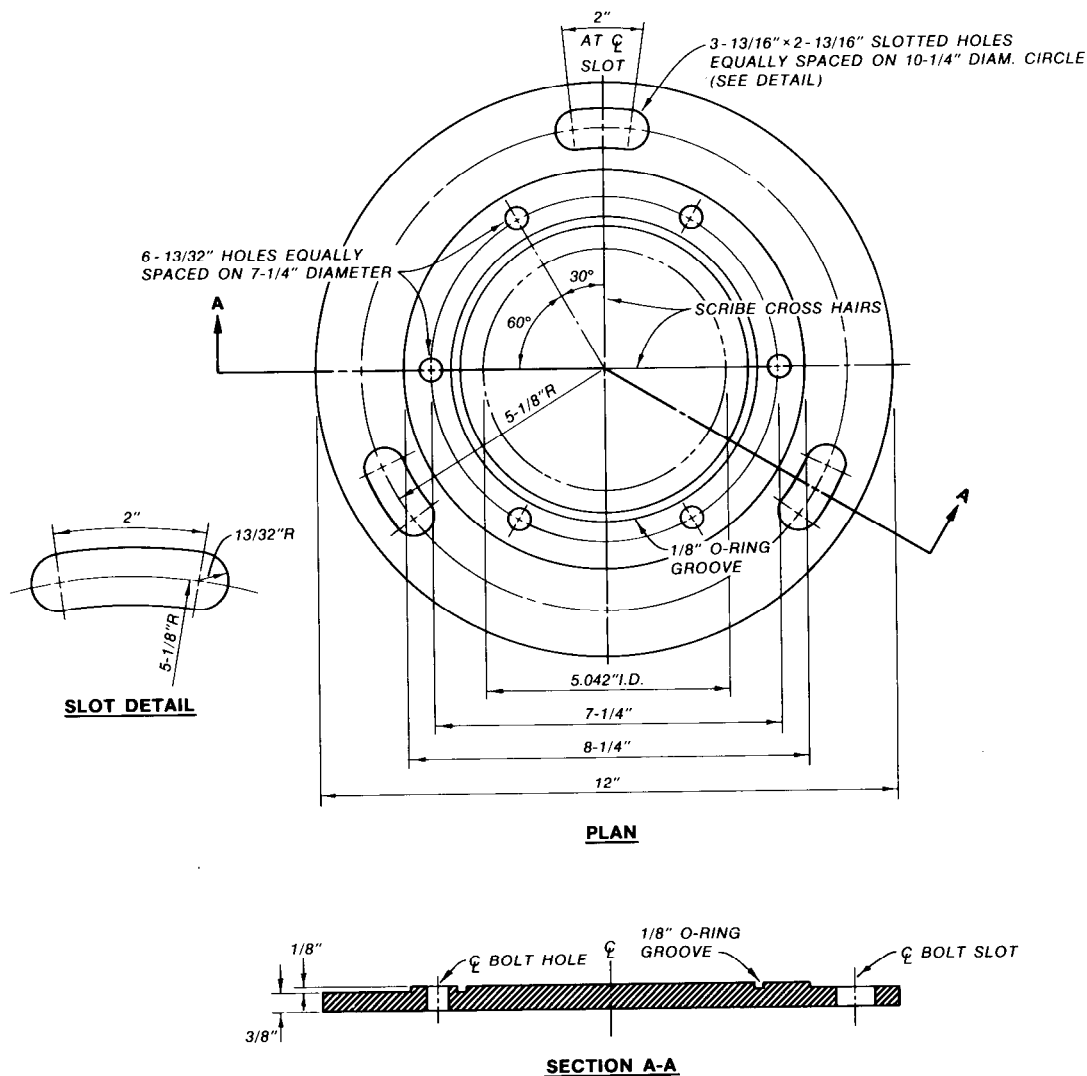

*

Figure 4-9. Base Plate of the Wall Deflection Pipe

the base plate. Plumbness of each pipe section is achieved by leveling. A proper sized "O" ring must be placed in the groove provided in the base plate before the first pipe section is installed. After the first section of pipe is secured to the base plate with six machine bolts, it is stabilized by attaching three anchor rods to the top pipe flange and secured to the concrete lift below. Turn buckles should be installed in the rods just below the pipe flange. This is done by inserting eye bolts through three bolt holes in the flange and attaching the turn buckle to the eye bolts. A special temporary cover plate, machined to make its faces precisely parallel, is placed over the top of the pipe. The top surface of the temporary cover plate is then made level by adjusting the turn buckles. This, in turn, plumbs the pipe. When the deflection pipe section has been plumbed, the concreting operation can begin. As the concrete lift is being placed, the level of the temporary plate should be checked and adjusted as the lift rises until it is no longer possible to manipulate the turn buckles due to the elevation of the fresh concrete. *

- * At this point the eye bolts should be removed from the flange. The top flange of the deflection pipe should emerge approximately 6 inches from the top of the completed lift. The temporary cover plate should be replaced with a less expensive plate and be left on the top flange until the next pipe section is installed. This will prevent water and debris from entering the pipe. Each remaining section of pipe is installed in the same manner as that of the first. The top of the last pipe section should extend no less than 2-5/16 inches above the top of the structure in order to mate with the deflectometer that fits on top of the deflection pipe. After the deflection pipe has been installed, it should be filled with transformer oil which will act as a damping medium to the swing of the plumb bob in the pipe. Care should be taken in filling the pipe with oil to prevent air entrapment.

(3) Method of Operation. Figure 4-10 is a schematic diagram showing the equipment operation. The plumb bob is lowered into the pipe to contact elevations and moved in four directions 90 degrees from each other until contact is made as determined electronically. Horizontal positions of each set of contacts in respect to each other are determined from deflection gage readings taken upon contact and, therefore, the positions of each set in respect to the bottom set of contacts. For each coupling the positions of two contact points are determined so that the center of each coupling is established. In this manner any inherent errors in determining the points of contact are partially compensable. Changes in the relative position of the coupling centers based on subsequent measurements indicate the lateral movement which occurs during the period between the two observations. The apparatus was designed to measure changes in alignment of the wall from the vertical of ± 2 inches with an accuracy of ± 0.01 inches over a height of 68 feet. Details of the instrument and its method of operation can be obtained through the Instrumentation Services Division of the WES.

(4) Data Collection. The deflection pipe is read by moving the plumb bob within the deflection pipe until an electrical circuit is completed. The plumb bob is moved towards or away from the contact bar by means of the deflectometer shown in Figure 4-8. The circuit, which consists of a battery, an ohmmeter, and the plumb bob, is an open circuit whenever the plumb bob is not touching a contact bar. It becomes a closed circuit when the bob touches a bar. The reading technique consists of moving the deflectometer so that the plumb bob approaches a contact bar. The proximity of the plumb bob to the contact bar may be monitored by observing the ohmmeter. As the plumb bob comes in close proximity to the contact bar, the infinite reading on the ohmmeter will begin to drop. At this point, movement of the deflectometer should be slowed and the ohmmeter monitored until the resistance drops to, or close to, zero. When the resistance measures zero, contact has been made and the dial gage attached to the deflectometer can be read. The same procedure is followed to read the contact bar on the opposite side of the pipe. With these two readings an average can be computed that describes the location of the center of the pipe. Figure 4-11 shows a sample deflection pipe data sheet with computations for 11 sets of readings through a monolith. The sheet contains each dial gage reading (E, W or N, S), the computation that describes the center of the deflection pipe, $(E + W)/2$, and a check calculation that *

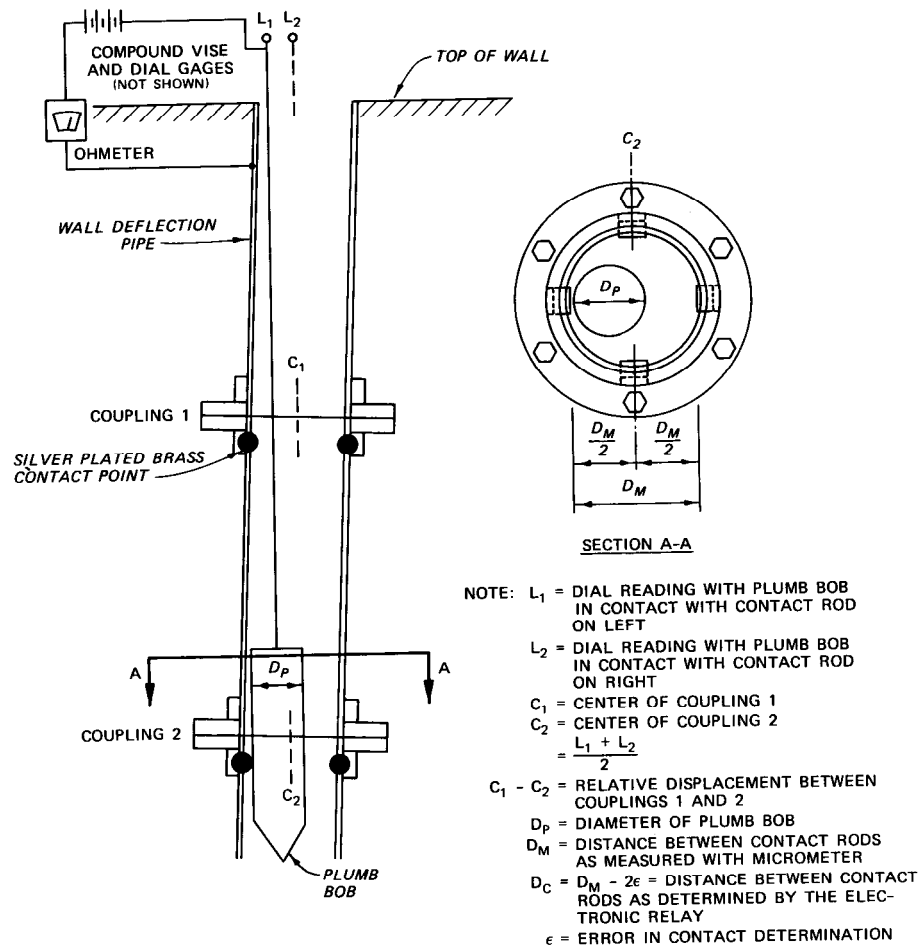

* Figure 4-10. Schematic Diagram of Equipment Used for Measuring Wall Deflections

should equal the distance between opposing contact bars, $|E - W| + P.B.$ This check reading insures that the dial readings were recorded properly. For instance, in Figure 4-11, the check computation made for the dial readings of coupling No. 7 made on 8 July shows an error. The check calculation should be 4.750 ± 0.001 . A check of the dial reading data shows that the 2.894 reading is suspect and should be corrected to 2.794. Figure 4-12 shows the computation sheet for the data in Figure 4-11. The deflection computation is made by computing the difference between the center of the pipe at the elevation in question, and the center of the pipe at the lowest measurable elevation.*

* This procedure assumes that the lowest point in the pipe does not move, which makes the deflection of all the points above the lowest one relative to the movement of the lowest point.

*

WALL DEFLECTION PIPE DATA SHEET									
Project <u>SAMPLE DATA SHEET</u>					Deflection Pipe No. <u>S1</u>				
Plumb Bob Dia. <u>4.299</u>					Observed by _____		Date <u>5 Jan & 8 Jul</u>		
Coupling No.	Counter Reading	Dial Reading			E-W +P.B.	Dial Reading			N-S +P.B.
		E	W	$\frac{E+W}{2}$		N	S	$\frac{N+S}{2}$	
DATE 5 Jan									
1	El. 30.0	3.482	3.032	3.257	4.749	3.366	2.914	3.140	4.751
2	35.0	3.472	3.022	3.247	4.749	3.392	2.940	3.166	4.751
3	40.0	3.457	3.007	3.232	4.749	3.389	2.937	3.163	4.751
4	45.0	3.420	2.969	3.194	4.750	3.357	2.906	3.132	4.750
5	50.0	3.372	2.922	3.147	4.749	3.345	2.893	3.119	4.751
6	55.0	3.294	2.844	3.069	4.749	3.330	2.879	3.104	4.750
7	60.0	3.218	2.767	2.992	4.750	3.304	2.852	3.078	4.751
8	65.0	3.120	2.670	2.895	4.749	3.281	2.829	3.055	4.751
9	70.0	2.983	2.533	2.758	4.749	3.241	2.789	3.015	4.751
10	75.0	2.857	2.407	2.632	4.749	3.191	2.739	2.965	4.751
11	80.0	2.672	2.222	2.447	4.749	3.116	2.664	2.890	4.751
DATE 8 Jul									
1	El. 30.0	3.183	2.733	2.958	4.749	3.850	3.399	3.625	4.750
2	35.0	3.143	2.693	2.918	4.749	3.896	3.444	3.670	4.751
3	40.0	3.115	2.665	2.890	4.749	3.901	3.449	3.675	4.751
4	45.0	3.056	2.606	2.831	4.749	3.870	3.419	3.645	4.750
5	50.0	2.988	2.537	2.763	4.750	3.834	3.383	3.609	4.750
6	55.0	2.896	2.446	2.671	4.749	3.800	3.348	3.574	4.751
7	60.0	2.794 2.894	2.342	2.568 2.618	4.751 4.851	3.749	3.298	3.524	4.750
8	65.0	2.659	2.208	2.434	4.750	3.714	3.263	3.489	4.750
9	70.0	2.509	2.059	2.284	4.749	3.658	3.207	3.432	4.750
10	75.0	2.358	1.908	2.133	4.749	3.601	3.149	3.375	4.751
11	80.0	2.173	1.723	1.948	4.749	3.536	3.084	3.310	4.751

WES Form No. 1084
May 1960

Figure 4-11. Data Sheet for Deflection Pipe Readings

DEFLECTION PIPE COMPUTATION SHEET

PROJECT Sample Computation SheetDEFLECTION PIPE NO. S1 OBSERVED BY _____ DATE 5 Jan & 8 Jul

Date	East-West Direction			North-South Direction	
	Contact	Center	Deflection	Center	Deflection
	Elev	Reading		Reading	
5 Jan	30.0	3.257	0	2.914	0
	35.0	3.247	W 0.010	2.940	S 0.026 (+)
	40.0	3.232	W 0.025	2.937	S 0.023 (+)
	45.0	3.194	W 0.063	2.906	N 0.008 (-)
	50.0	3.147	W 0.110	2.893	N 0.021 (-)
	55.0	3.069	W 0.188	2.879	N 0.035 (-)
	60.0	2.992	W 0.265	2.852	N 0.062 (-)
	65.0	2.895	W 0.362	2.829	N 0.085 (-)
	70.0	2.758	W 0.499	2.789	N 0.125 (-)
	75.0	2.632	W 0.625	2.739	N 0.175 (-)
	80.0	2.447	W 0.810	2.664	N 0.250 (-)

Date	East-West Direction			North-South Direction	
	Contact	Center	Deflection	Center	Deflection
	Elev	Reading		Reading	
8 Jul	30.0	2.958	0	3.625	0
	35.0	2.918	W 0.040	3.670	S 0.045 (+)
	40.0	2.890	W 0.068	3.675	S 0.050 (+)
	45.0	2.831	W 0.127	3.645	S 0.020 (+)
	50.0	2.763	W 0.195	3.609	N 0.016 (-)
	55.0	2.671	W 0.287	3.574	N 0.051 (-)
	60.0	2.568 2.618	W 0.340 W 0.390	3.524	N 0.101 (-)
	65.0	2.434	W 0.524	3.489	N 0.136 (-)
	70.0	2.284	W 0.674	3.432	N 0.193 (-)
	75.0	2.133	W 0.825	3.375	N 0.250 (-)
	80.0	1.948	W 1.01	3.310	N 0.315 (-)

Figure 4-12. Computation Sheet for Deflection Pipe

4-30

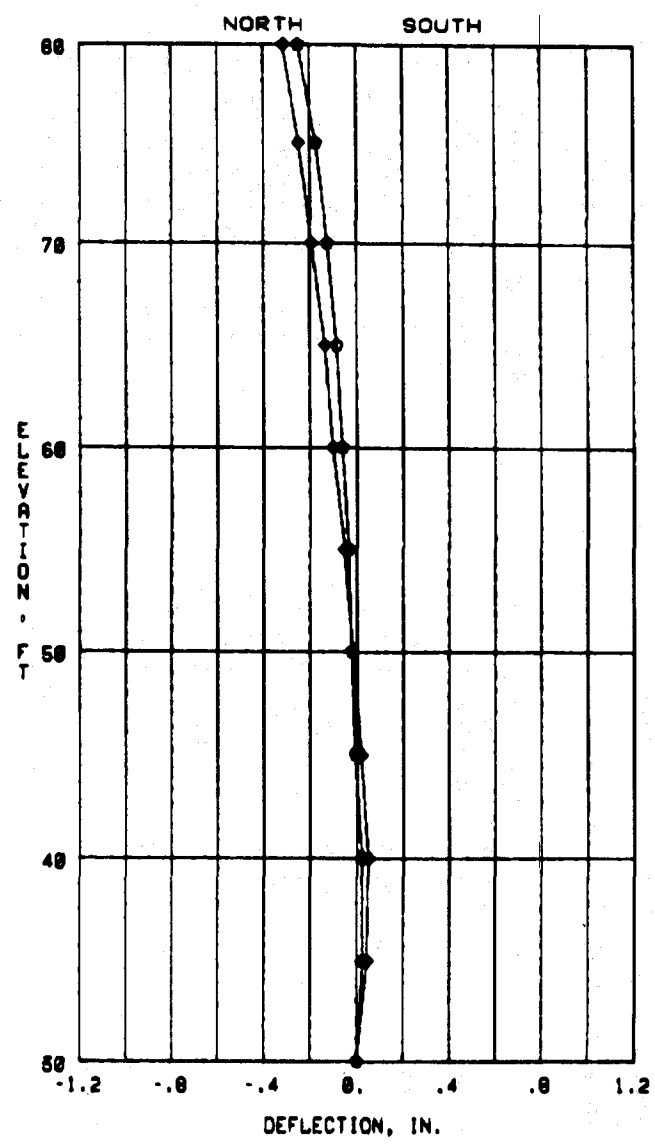
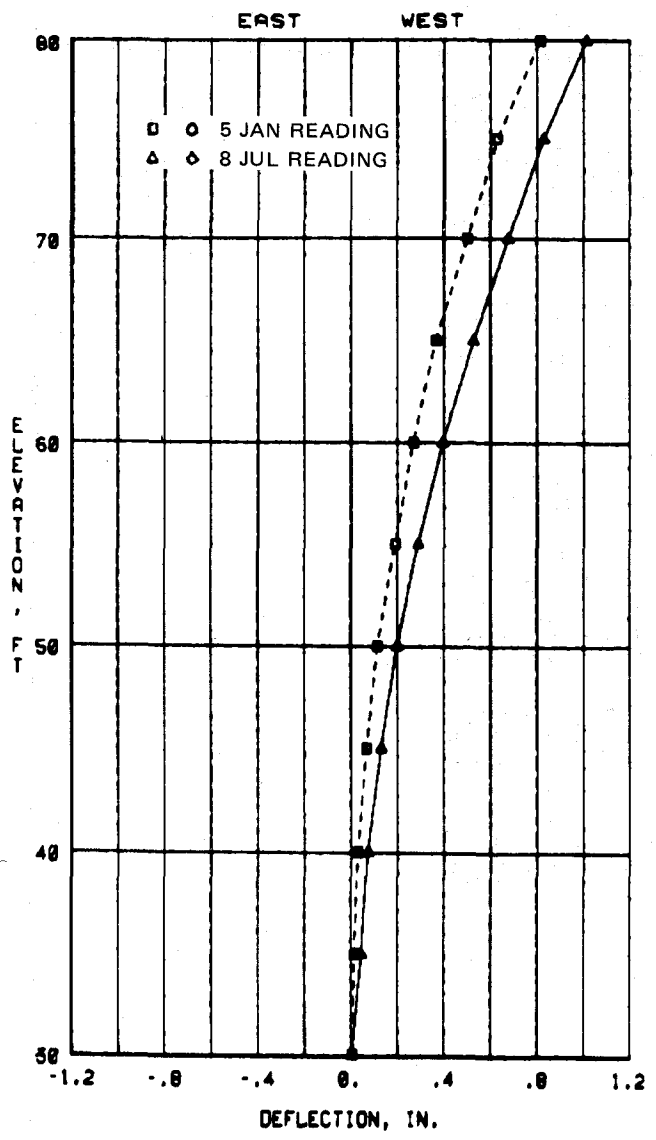

Figure 4-13. Typical Graph of Deflection Versus Elevation

*

*The data are typically reported as a graph of elevation versus deflection as shown in Figure 4-13, which is a graph of the computed data from Figure 4-12.

4-11. Instruments that Measure Surface Tilt. This category of tiltmeter includes the instruments that are located at one site, and provide a record of tilt for a given location. They may be fixed, in which case a number of these instruments may be necessary to describe the tilt of a structure, or they may be moveable in which case one unit is moved around and used to measure the tilt at a number of locations. In general, the former can be automated, and the latter must be accomplished by manual means. *

a. Electrolevel.

(1) The "Electrolevel", shown in Figure 4-14, is a British instrument which is designed to provide a remote-reading facility for measurement and control of small angular movements. It has a spirit level vial with a precision-ground upper surface that is filled with an electrically conducting liquid and has three electrodes of platinum rigidly attached to the inner surface. The liquid is an alcoholic solution that has virtually the same properties as the liquid of a spirit level. The bubble runs on the curved surface which is free from discontinuities over the operating range. Movement of the bubble changes the electrical resistance values between the inner and outer electrodes. By using an alternating current bridge circuit the bubble position can be read with a pointer-type instrument (meter movement).

(2) The Electrolevel vial provides an electrical signal proportioned to the angular deviation from horizontal over a range of ± 30 minutes of arc. When used with a bridge circuit and detector amplifier, indications of tilt of less than 1 second of arc can be displayed. The Electrolevel heads can be located at distances up to 300 feet from the detector. More detailed information about this tilt measuring device can be obtained from Tellurometer U.S.A. Division of Plessey Incorporated, 87 Marcus Boulevard, Hauppauge, New York 11787.

* b. Applied Geomechanics AGI 700. This tiltmeter is similar to the electrolevel, but measures tilt angles to a resolution of 0.02 seconds of arc. It is manufactured by Applied Geomechanics, Incorporated of Santa Cruz, California. The meter, along with a readout instrument, is shown in Figure 4-15. It is manufactured as both a single-axis and a dual-axis tiltmeter.

(1) Description. The AGI 700 surface mount tiltmeter detects tilt through the motion of a bubble in an electrolytic sensor similar to a spirit level. As the meter changes tilt angle, the sensor changes resistance. The resistance element is part of an internal bridge network, and the change in resistance affects the output voltage of the tiltmeter.

(2) The AGI 700 electronics are contained on three printed circuit boards in the meter. The Power Supply board contains the power supply regulating circuitry. The AGI-700 is externally powered by a ± 12 VDC, 50 mA power supply. This board also contains circuitry to perform temperature *

*

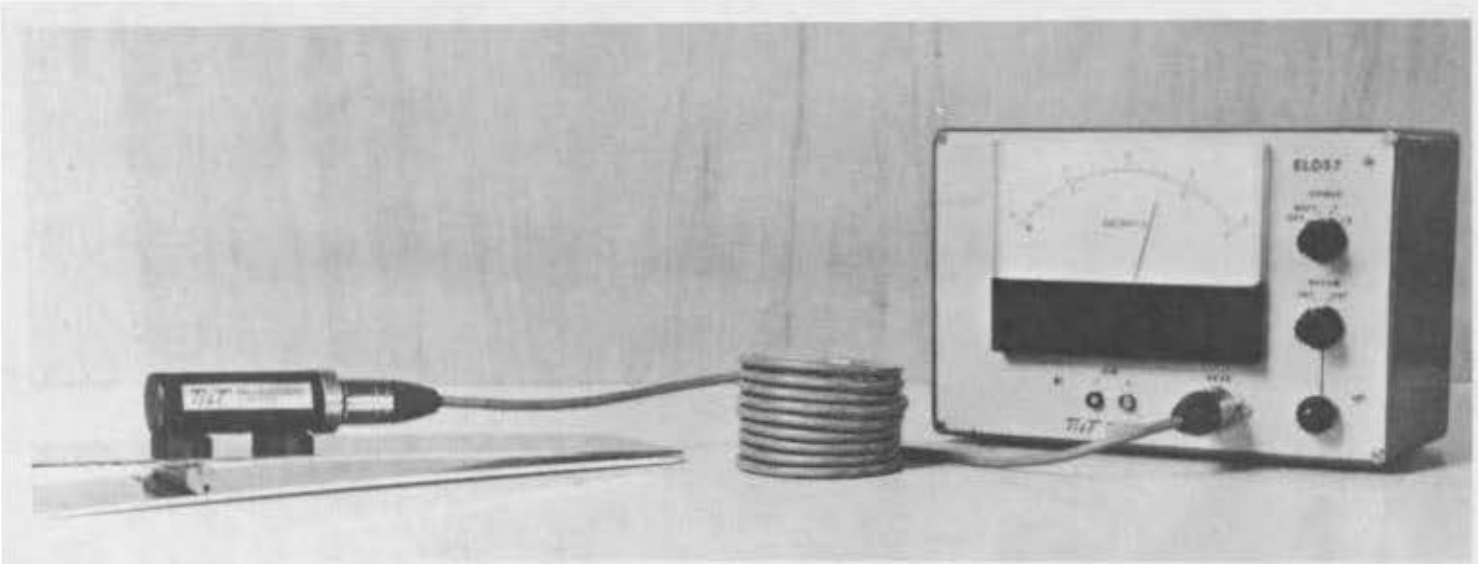

ELH/10

Figure 4-14. British Aircraft Corporation Electrolevel Unit
(Courtesy of Tilt Measurement Ltd.)

*

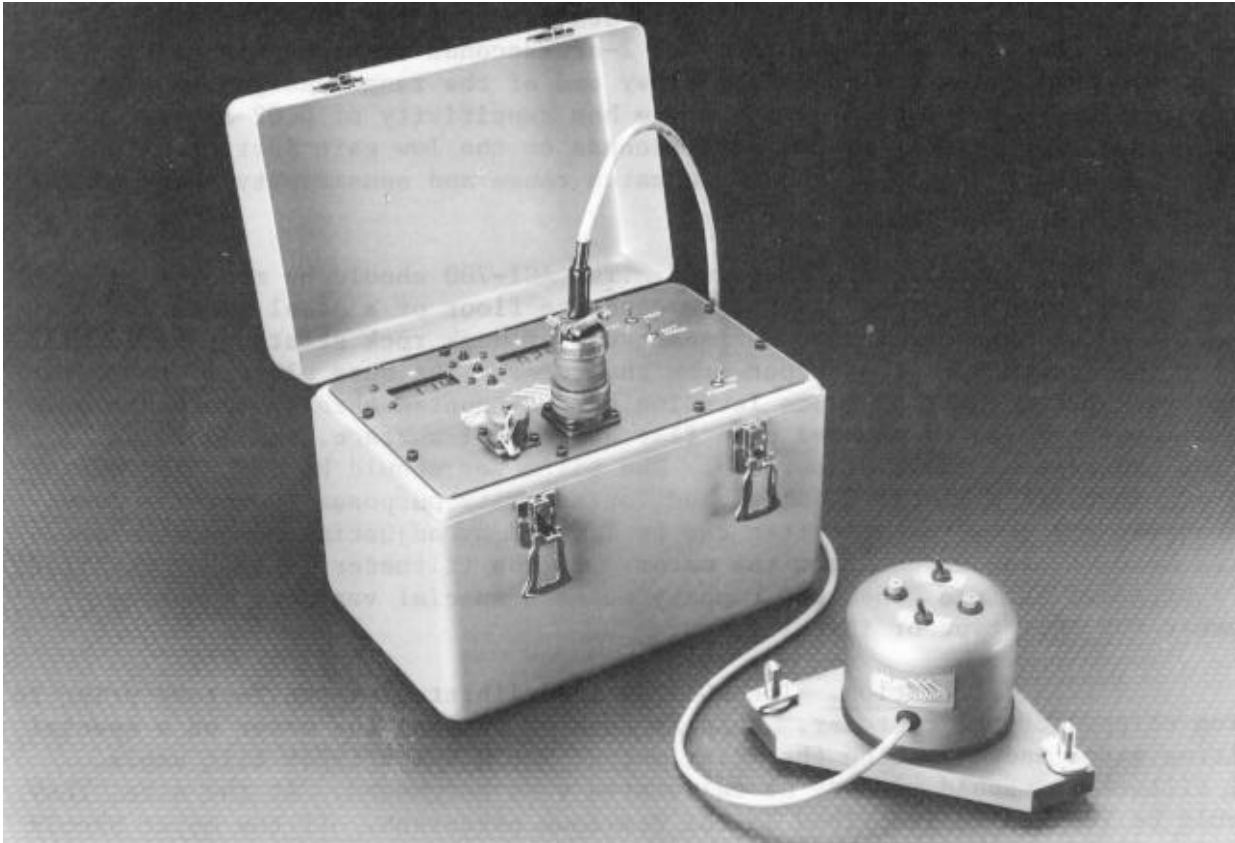

* Figure 4-15. Applied Geomechanics AGI 700 Surface Mount Tiltmeter with Read-Out Box

calibration and amplification, as well as provide clock circuitry. The dual amplifier circuit board contains the balance bridge, the amplifier, the rectifier, and output circuitry for both axes of tilt output. The third circuit board, the switchboard, contains gain and filter circuitry, switches to control these functions, and signal input/output circuitry.

(3) All circuitry as well as the sensors are housed in an anodized 6061-T6 aluminum dome and base. The dome is secured to the aluminum base and is gasketed at the intersection to prevent ingress of water and other foreign materials.

(4) Tilt Ranges. As conventionally manufactured by Applied Geomechanics, the AGI-700 can measure tilt angles in one of three ranges; ± 60 degrees, ± 5 degrees, and ± 0.5 degrees. The company says they can custom manufacture sensors for other ranges. Within each range described above, the sensor can be adjusted to monitor one of two subranges by changing the position of a gain switch mounted on the dome of the meter. For example, a tiltmeter designed for the ± 0.5 -degree range can monitor tilting in the ± 24 -arc-minute range with the gain switch set to low, and monitors tilt angles of ± 2.4 arc minutes with the gain switch set on high.

*

* (5) Sensitivity. Tiltmeters designed for the ± 60 -degree range have output sensitivity (resolution) of 2-arc-seconds on high gain setting and 20-arc-seconds on low gain. On the other end of the range designs, a tiltmeter designed for the ± 0.5 -degree range has sensitivity of 0.02-arc-seconds on the high gain setting and 0.2-arc-seconds on the low gain setting. The particular sensor should be chosen to match range and sensitivity needs of the application.

(6) Installation Procedure. The AGI-700 should be mounted on a clean, hard, smooth surface such as a concrete floor or a steel girder. Mounting the tiltmeter on soft surfaces such as weak rock strata or soils will affect the accuracy of the output from the meter. The base plate of the meter comes with three Invar or brass leveling screws mounted through the plate. If the tiltmeter is to be mounted on a flat horizontal surface, the leveling screws can rest on the flat surface. The tiltmeter should be installed out of the way where it will not be disturbed for security purposes. Once the leveling screws are set, the tiltmeter can be leveled by adjusting the screws to get a zero voltage output from the meter. If the tiltmeter is to be installed on a vertical surface, then the company makes a special vertical mounting bracket for this type of installation.

(7) Calibration. The AGI-700 is calibrated at the factory prior to being shipped to the customer. This is done by putting the meter on a special tilting stage and adjusting the meter output for a known input tilt angle. All tiltmeters should already be calibrated when purchased. At the site, they should be leveled as described in the previous paragraph. If the meter should require field calibration, it can be removed from its measurement location and placed on a similar stage for calibration.

(8) Data Collection. The tiltmeter can be purchased with an Applied Geomechanics readout instrument, or it may be purchased separately and integrated into a data acquisition system. The AGI readout unit supplies the power to the tiltmeter, and provides a display for reading the tilt data. The readout unit has a rechargeable 12-V battery such that there is no need for access to an outlet when reading the meters. The AGI-700 plugs into the front of the readout unit (see Figure 4-15) and displays tilt for both x and y axes in terms of mV of output. The output mV are converted to angular degrees of tilt by applying a gain factor and a conversion factor supplied by the manufacturer.

C. Swiltometer. This instrument, manufactured by Structural Behavior Engineering Laboratories, Inc. of Phoenix, Arizona, is a subminiature servo system that mounts on a structure, or at any location within the structure, and is capable of measuring sway, tilt, settlement, and alignment of the structure at the point of attachment of the instrument. The Swiltometer is also capable of measuring dynamic motion due to its use of miniature accelerometers as sensing devices.

(1) Description. As shown in Figure 4-16, the Swiltometer is housed in a rugged casing which is securely bolted to the structure. The *

* casing is either aluminum or stainless steel depending upon the corrosive effects of the environment surrounding the meter. The base plate is an L-shaped plate welded to the casing. This plate allows the Swiltometer to be attached to either a vertical or horizontal surface. The sensing element is a D.C. servo accelerometer. There are three ranges of sensitivity, 0.1 G, 1 G, and 5G, with the 0.1-G range offering the highest degree of sensitivity. The Swiltometer requires a 15-volt battery for power and the output signal from the instrument is sent to a signal amplifier and then to the individual's choice of output display, voltmeter, millivolt strip chart recorder or oscilloscope. The Swiltometer can be used to measure tilt or used to gather acceleration data since the instrument can survive up to 100-G shock loads (momentarily). The instrument can measure tilt values as low as 0.0001 inches per foot which translates to approximately 2 seconds of arc. The tilt can be resolved into two components in two vertical planes, and as an accelerometer accelerations of as small as 0.001 G can be detected.

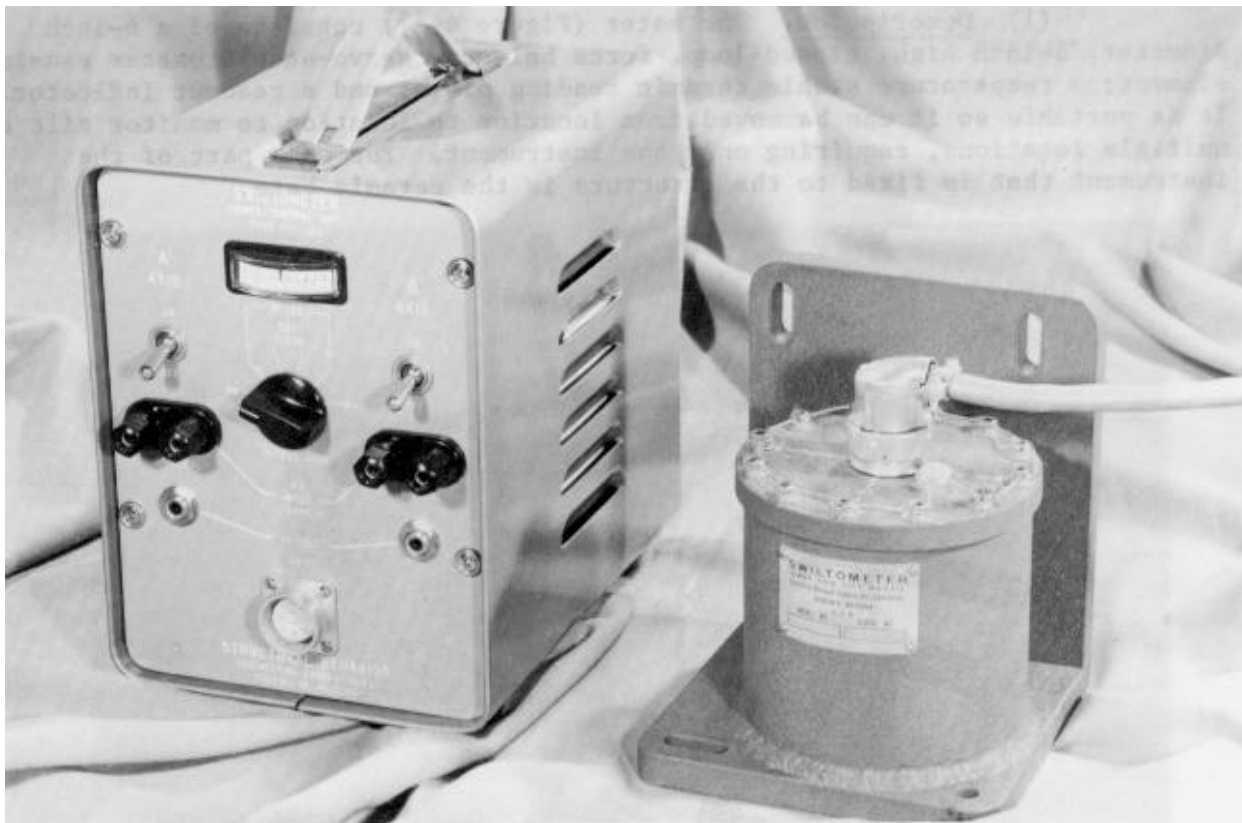

Figure 4-16. Swiltometer

(2) Installation Procedures. The Swiltometer is furnished with a leveling adapter which is a demountable turntable attachment to facilitate in checking the levelness of precision platforms and surface tables. The Swiltometer should be mounted on a flat metal platform which has been secured to the structure to be measured. The base or platform should be capable of being adjusted by means of a tribrach assembly in order to insure levelness at installation. The Swiltometer can be used to measure tilt at more than one location in a structure. For instance, if the tilt through a structure from *

EM 1110-2-4300
Change 1
30 Nov 87

*crest to foundation is desired, the instrument can be moved from one base plate to the next with readings being made and recorded at each location.

(3) Data Collection. In order to make static tilt measurements with the Swiltometer, the instrument must be connected to a power source/control unit. This unit is also shown in Figure 4-16. A typical data plot would either be a graph of voltage (tilt) versus time in the case of an instrument monitoring one tilt location over a length of time, or voltage (tilt) versus location in a structure when the Swiltometer is moved through a structure to give a picture of tilt with respect to elevation.

d. Portable Horizontal-Vertical Tiltmeter. Slope Indicator Co. makes a surface-mounted tiltmeter that is portable and can measure tilt in both the vertical and horizontal planes.

(1) Description. The meter (Figure 4-17) consists of a 6-inch diameter, 3-inch high, closed-loop, force balanced servo-accelerometer sensing element; a temperature stable ceramic reading plate; and a readout indicator. It is portable so it can be moved from location to location to monitor tilt at multiple locations, requiring only one instrument. The only part of the instrument that is fixed to the structure is the ceramic base.



Figure 4-17. Portable Horizontal-Vertical Tiltmeter Sensor in Reading Position on Ceramic Tilt Plate

*

(2) Installation Procedures. The ceramic base plate is the portion of the instrument which is installed. It is bonded to the structure by means of grout or epoxy. Standard surface preparation procedures for epoxy-bonding should be followed in this matter. Every effort should be made to get the ceramic plate bonded in the horizontal plane or the vertical plane since any deviation will reduce the range through which the instrument will effectively operate. If the system is to monitor tilt in a structure where the surface material is not sound enough to act as a base for attachment of the meter, then the following procedure should be followed. The instrument will be mounted to a base plate assembly that is anchored into the structure a few feet below the surface of the structure. A borehole approximately 8 inches in diameter should be drilled down into sound material. The depth of penetration of the borehole through the sound material should be at least 2 feet. Blasting is not recommended since this could damage the sound material. A steel pipe 4 to 6 inches in diameter and long enough to reach from the bottom of the borehole to the surface of the structure should be inserted into the center of the borehole, and structural grout should be placed around the pipe up to the top of the sound material (Figure 4-18). When this has hardened, the remainder of the hole should be backfilled with a soft insulating material such as fiberglass or Styrofoam beads. This will insulate the exposed pipe shaft and prevent any movement of the base of the instrument due to temperature changes. It will also insure the isolation of the base of the instrument should the unsound upper layer of material have a tendency to move independently of the lower layer.

(3) Method of Operation. The portable tiltmeter utilizes a closed-loop, force-balanced servo-accelerometer similar to the Digitilt inclinometer (paragraph 4-10a.). It senses changes in tilt in one plane perpendicular to the surface of the ceramic plate. To operate, the sensor is lined up on three of the pegs in the plate and an angle is read on the four-digit indicator display. **The display reads $2 \sin \theta$ over the standard operating range of ± 30 degrees where θ is the inclination from the vertical, thus** allowing angular deformations of 10 seconds to be monitored. This is equivalent to a displacement of 200 pinches over the 4-inch length between pegs of the ceramic plate.

(4) Calibration and Reading. A method of measuring the accuracy of the portable tiltmeter should be obtained. It should have a sensor that allows for checking of the tilt angles throughout the range of the tiltmeter from horizontal measurement through maximum angle of tilt with at least one intermediate measurement. The accuracy of the calibration device should be at least as accurate as the tiltmeter. The portable tiltmeter units should be calibrated both before and after each day's use. This will minimize the occurrence of instrument errors. At each ceramic plate, readings should be taken by wiping the plate with a clean dry cloth to make sure there is no debris on the plate and then placing the instrument on three of the four points on the plate and reading the output voltmeter. This procedure should be repeated until consistent readings are obtained. The instrument should then be rotated 180 degrees and the above procedure repeated. Pairs of readings taken 180 degrees apart are averaged to correct for face error. *

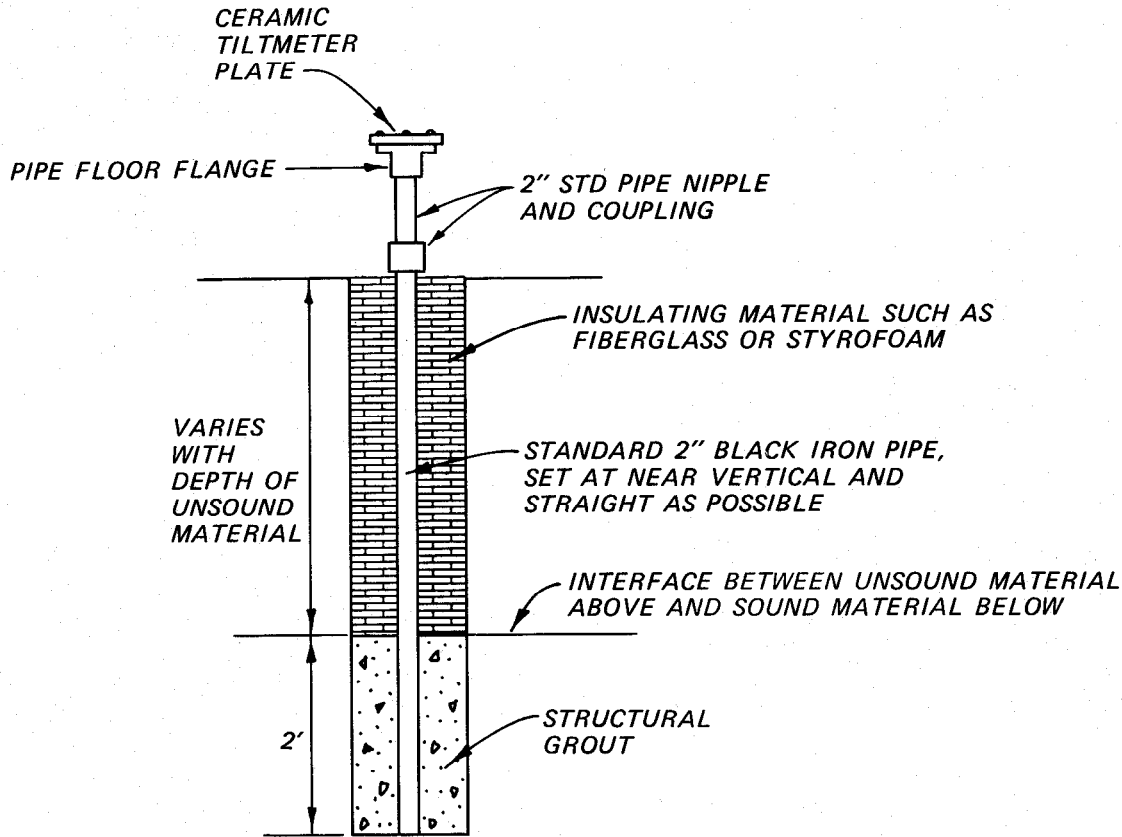

* Figure 4-18. Drilled-in Installation of Tiltmeter

Additionally, sets of readings similar to the above should be made with the instrument at 90 degrees to the original orientation to record the transverse tilt as well as the axial tilt of the structure. Typical reporting of results are by graph as shown in Figure 4-19.

e. Autocollimating Tilt Measurement Systems. A method of measuring tilt of a structure using an automatic level equipped with an autocollimating eyepiece and an optical vernier has been devised recently at the U.S. Army Engineer Topographic Laboratories. This system can measure both short- and long-term tilt of a structure and has the accuracy of about 2 seconds of arc over a range of ± 7.5 minutes of arc.

(1) Description. The system, as shown in Figure 4-20, consists of a Zeiss Ni 2 Automatic Level, an autocollimating eyepiece, an optical vernier, and a calibration mirror. Long-term measurements of tilt are made of permanently mounted structure mirrors. These mirrors are attached to each vertical surface where measurement of tilt is required. As the vertical surface tilts, the mirror follows the movement and the system is designed to detect these small deflections. For short-term measurements, such as those encountered *

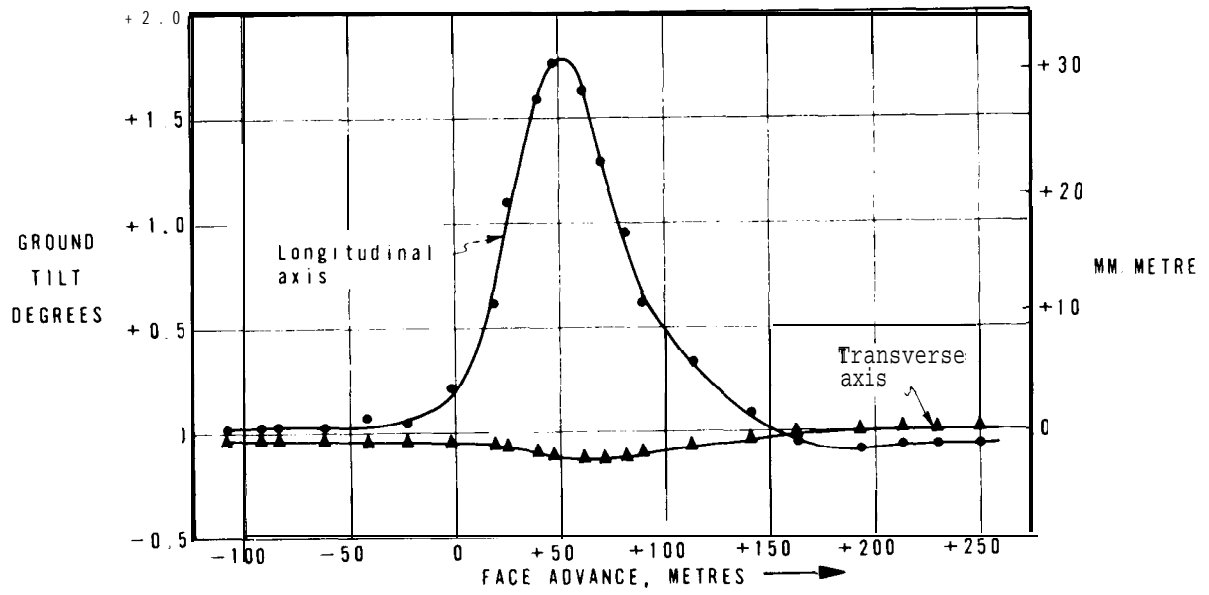

Figure 4-19. Typical Graph of Horizontal-Vertical Tiltmeter Data



Figure 4-20. Autocollimating Tilt Measurement System

EM 1110-2-4300
Change 1
30 Nov 87

*during the filling-emptying cycle in a lock, a tripod mounted mirror may be used.

(a) Automatic Level. There are several competing automatic levels with comparable qualities. However, the Zeiss Ni 2 automatic level is the only automatic level known to be suitable because it is the only one which may be fitted with a standard autocollimating eyepiece and has a reticle graduated over a range of several minutes of arc.

(b) Autocollimating Eyepiece. The autocollimating eyepiece consists of a small lamp, half-silvered diagonal mirror, a reticle for reading angles, and an eyepiece for viewing the reading reticle. The use of the autocollimating eyepiece will turn the automatic level into an autocollimator which is a widely used device for measuring small angles.

(c) Optical Vernier. The optical vernier consists of essentially an optical wedge mounted within a rotating stage. The optical vernier may be used to deviate the line of sight by a known amount. In use, the wedge is rotated until the cross hair image is brought into coincidence with one of the reticle graduations. The rotation of the wedge needed to accomplish this is an accurate measure of the difference in seconds between the image and the reticle line.

(d) Calibration Mirror. Because of the errors in the automatic level compensator and in the positioning of the autocollimator reticle, it is necessary to calibrate the system before use so that all measurements, even those taken years apart, will be related to a common base, i.e., the direction of the vertical or gravity vector. The calibration of the system is performed by using a calibration mirror which consists of a two-sided mirror mounted to a tribrach in an approximately vertical position and a reading of tilt is made of one face with the instrument. Without moving the calibration mirror, the instrument is then used to make a reading of the other face. The mean of the two readings is the error of the system and should be used to correct the readings of the structure mirrors.

(e) Structure Mirror. The mirror assembly consists of a high quality surface mirror and an adjustable mirror mount. The mirror is round, approximately 2 inches in diameter and 1/2 inch in thickness. The purpose of the adjustable mount is to both hold the mirror rigidly in position and to provide a means for initially adjusting the mirror to a nearly vertical position.

(2) Installation Procedures. The structure mirrors are the only part of the system that must be installed. The mirror must be mounted in such a manner that it accurately follows the tilt of the structure. In addition, the mount must not distort the mirror so that an unclear image is seen in the autocollimator. Using 1/4-inch-diameter stainless steel anchor bolts and stainless washers for mounting the mirror is recommended. The anchor bolts should have a sufficient length to provide at least 1-1/2 inches of embedment *

*length. A steel metal cover box may be used to protect the mirror surface from damage and to protect the mirror assembly from accidental movement.

(3) Method of Operation. When the lamp of the autocollimating eyepiece is turned on, it illuminates the cross hair of the automatic level. The focus of the level is set for infinity and the objective lens of the level projects an image of the cross hair along a collimated beam against a structure mirror, the tilt of which is being measured. The structure mirror, which is usually placed within a few inches to a few feet from the instrument, reflects the cross hair image back into the level, where it comes to a focus in the plane of the original cross hair. An observer looking into the eyepiece will see both the cross hair and its image, with the displacement between the two being proportional to the degree of the tilt of the structure mirror. The observer will also see the measuring reticle graduated in increments of 10 arc seconds. Using this reticle and the displacement between the cross hair and its image, a quantitative measurement may be made of the tilt of the mirror with respect to the optical axis of the level. Detailed instruments for assembly of the instrument, calibration, and measurements of the tilt of the structure mirror can be obtained from U.S. Army Engineer Topographic Laboratories, Ft. Belvoir, VA.

4-12. Terzaghi Water Level Meter.

a. General. The Terzaghi water level meter is used to measure differences in elevation of floors, footings, columns, walls, galleries in dams or any place where leveling could be used. Most frequent use of the water level is in measurement of differential settlements in structural foundations in buildings, power plants, dams, and similar structures. The measuring points can be permanently or semi-permanently installed in walls, columns, or piers for measurement against a permanent bench mark. Its principle of operation is the measurements of the water level in two cylinders that are connected by a flexible tube. The water level may be used to determine differences in elevation between two points to an accuracy of 0.005 inch within a range of 6 inches. The apparatus shown in Figure 4-21 consists of two plastic sight tubes each of which is connected with a variable height setting to a mounting frame. The cylinders may be positioned on the mounting frame at 1/2-inch intervals over a range of 6 inches. The two sight heads are connected with plastic tubing and have air relief valves. Also, a tapered-point micrometer, graduated to 0.001 inch is mounted in each sight head. By setting the point of the micrometer at the water level in each cylinder and reading the micrometer and mount setting, the difference in elevation between fixed points on each cylinder assembly may be determined.

b. Operation. To use the water level, both cylinders and tubing are filled with water that is free from air bubbles. The two cylinders are placed into their frames such that the water level is within range of the point of the micrometers. The observations are taken simultaneously, and a minimum of two sets of readings should be taken. After making the first set of readings, the cylinder assemblies should be interchanged and a second set of readings

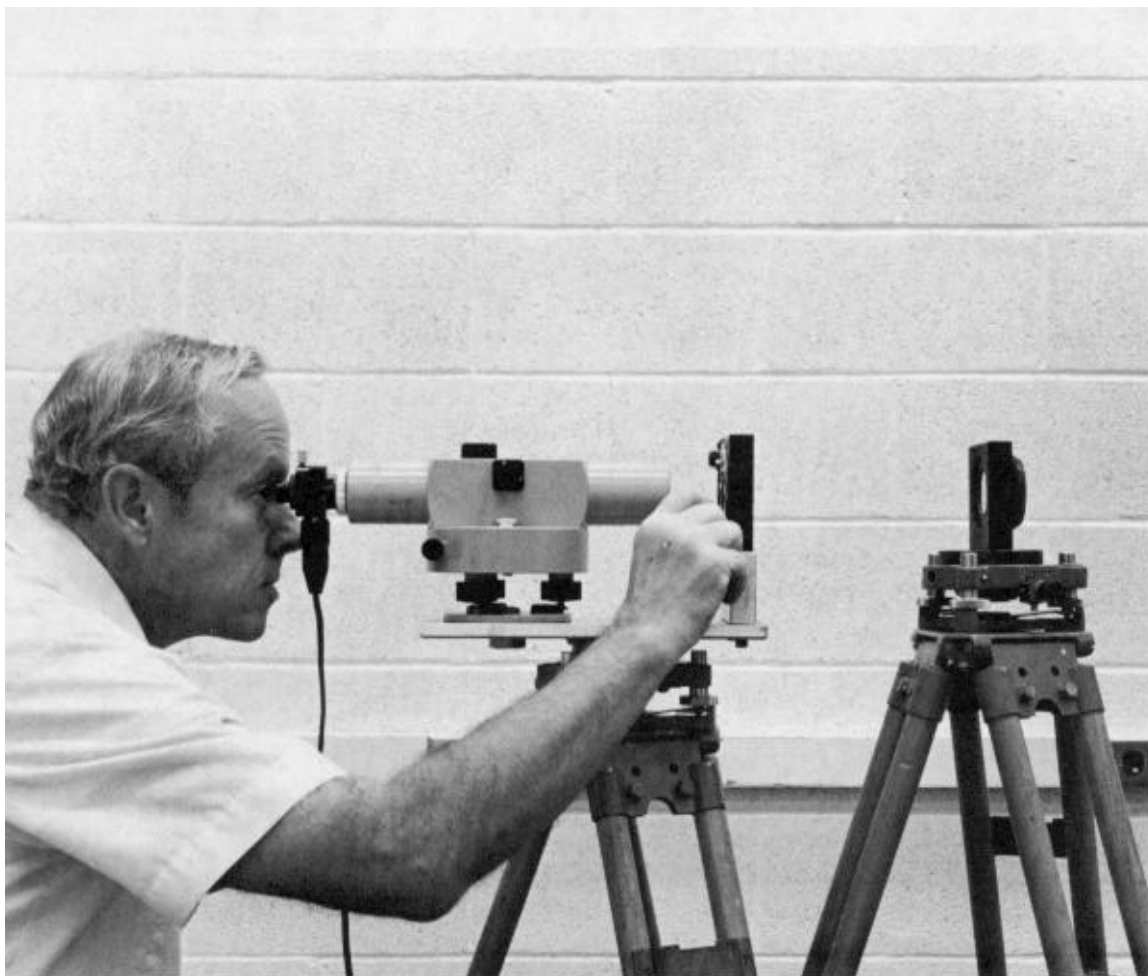

Figure 4-21. Terzaghi Water Level Gage (Courtesy of Soiltest Inc.)

taken. The difference in elevation between the two points should then be computed as the average of the difference of the two readings.

C. Reading the Gage. In making a measurement, the reading should be taken when the micrometer point just touches the water surface. To record a reading, count the number of holes above the base of the mounting frame to and including the hole where the head is attached. The lowest hole should be considered as zero. Multiply the number of holes by $1/2$, and record this as inches. Read the micrometer setting, and add this value to the above. The micrometer is graduated to readings of 0.001 in. The numbers on the micrometer post represent tenths of inches. The sum of the mounting frame reading in inches and the micrometer reading represent the total reading and should be recorded. The difference between the recorded values for each cylinder represents the difference in elevation between the mounting points.

a. Precautions. The tube connecting the levels should not be exposed to variations in temperature throughout its length, since local changes in density of water will occur. For this reason it is necessary to isolate the tube from any hot water pipes, etc., and also to keep it out of direct sunlight. If it is necessary to use this instrument in sub-freezing temperatures, it has been found that a saturated salt solution can be used in place of water. Such a solution is well suited for this purpose since its coefficient of volume change is considerably smaller than that of other common antifreeze solutions.

e. Availability. This gage is not commercially available, but complete plans for construction of a gage can be obtained from either the Structures Laboratory, U.S. Army Engineer Waterways Experiment Station, Vicksburg, MS, or the Structures Branch, U.S. Army Corps of Engineers, Washington, DC.

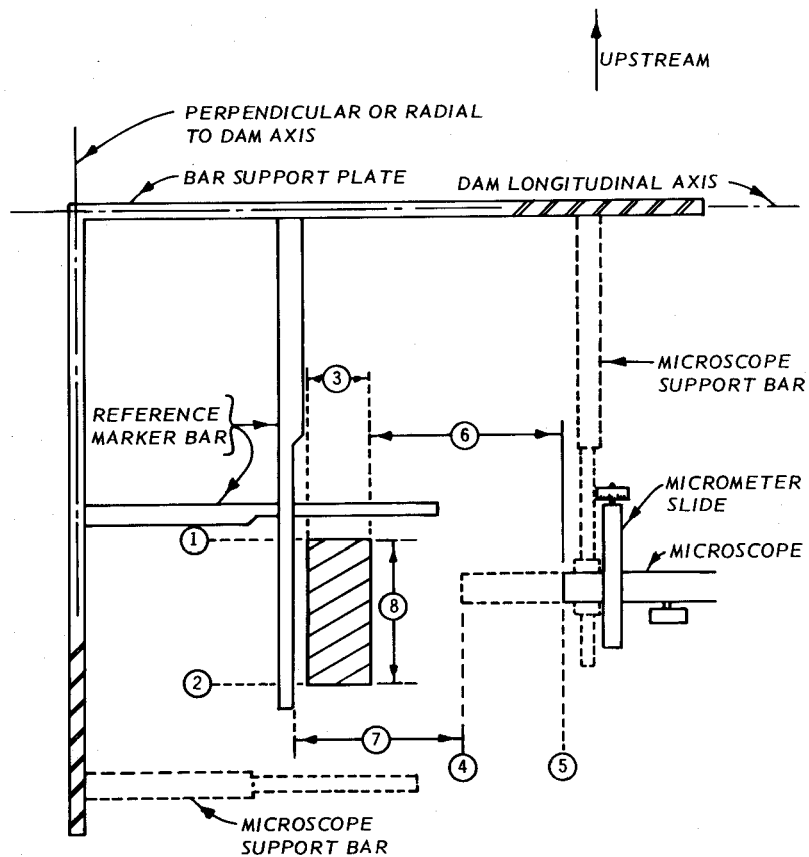
LEGEND

- ① EXTREME LIMIT OF EXPECTED PLUMB LINE MOVEMENT UPSTREAM.
- ② EXTREME LIMIT OF EXPECTED PLUMB LINE MOVEMENT DOWNSTREAM.
- ③ ALLOWANCE FOR TRANSVERSE MOVEMENT (APPROX 1/4 DISTANCE BETWEEN ① AND ②).
- ④ MICROSCOPE DRAW TUBE EXTENDED.
- ⑤ MICROSCOPE DRAW TUBE RETRACTED.
- ⑥ MECHANICAL WORKING DISTANCE OF MICROSCOPE.
- ⑦ -DO-
- ⑧ RANGE OF MOVEMENT TO BE MEASURED BY MICROMETER SLIDE.

MANUALS-CORPS OF ENGINEERS
U. S. ARMY

ENGINEERING AND DESIGN

INSTRUMENTATION FOR MEASUREMENT OF STRUCTURAL
BEHAVIOR OF CONCRETE GRAVITY STRUCTURES
DETAILED LAYOUT REQUIREMENTS OF PLUMB
LINE READING STATION FACILITIES

EM 1110-2-4300

PLATE 4-2

EM 1110-2-4300
 Change 1
 30 Nov 87

_____ PROJECT
 FIELD READING SHEET-DEFLECTION MEASUREMENTS

MONOLITH _____ PLUMB LINE NO. _____ READING STA. ELEV. _____ DATE _____ TIME _____
 WEATHER _____ MEAN DAILY TEMP. _____ POOL ELEV. _____ TW ELEV. _____

BAR	TRIAL	REFERENCE MARK			PLUMB LINE							DEFLECTION	
		FROM RIGHT	FROM LEFT	AVG.	RIGHT EDGE			LEFT EDGE			CENTER- LINE	IN.	POS- TION
					FROM RIGHT	FROM LEFT	AVG.	FROM RIGHT	FROM LEFT	AVG.			
(1)	(2)	(3)	(4)	(5)	(6)	(7)	(8)	(9)	(10)	(11)	(12)	(13)	(14)

EXPLANATION:

- IN COL. 1 SHOW REFERENCE BAR DESIGNATION.
- IN COL. 2 SHOW OBSERVATION TRIAL NUMBER. A MINIMUM OF 3 TRIALS ARE USUALLY REQUIRED.
- IN COLUMNS 3 AND 4 INSERT READINGS OF THE SLIDE MICROMETER WHEN THE MICROSCOPE IS CENTERED ON THE REFERENCE MARK FROM THE RIGHT AND LEFT, RESPECTIVELY.
- IN COL. 5 INSERT THE AVERAGE OF COLS. 3 AND 4.
- COLUMNS 6 AND 7, AND 9 AND 10, ARE SIMILAR TO COLS. 3 AND 4, BUT ARE RECORDED WHEN THE MICROSCOPE IS CENTERED ON THE PLUMB LINE.
- COLUMNS 8 AND 11 ARE THE AVERAGES FROM COLS 6 AND 7, AND 9 AND 10.
- IN COL. 12 RECORD THE MEAN OF THE VALUES IN COLS. 8 AND 11. THIS REPRESENTS THE POSITION OF THE CENTER OF THE PLUMB LINE WIRE.
- IN COL. 13 INSERT THE NUMERICAL DIFFERENCE BETWEEN COLS. 5 AND 12, WITHOUT REGARD TO ALGEBRAIC SIGN.
- IN COL. 14 RECORD THE POSITION OF THE PLUMB LINE WIRE WITH RESPECT TO THE REFERENCE MARK, EITHER U/S OR D/S, OR R/A OR L/A WHEN READING PARALLEL TO DAM AXIS. THIS USUALLY CAN BE EASILY DETERMINED BY EYE WITHOUT THE USE OF THE MICROSCOPE.

4-49

Plate 4-4

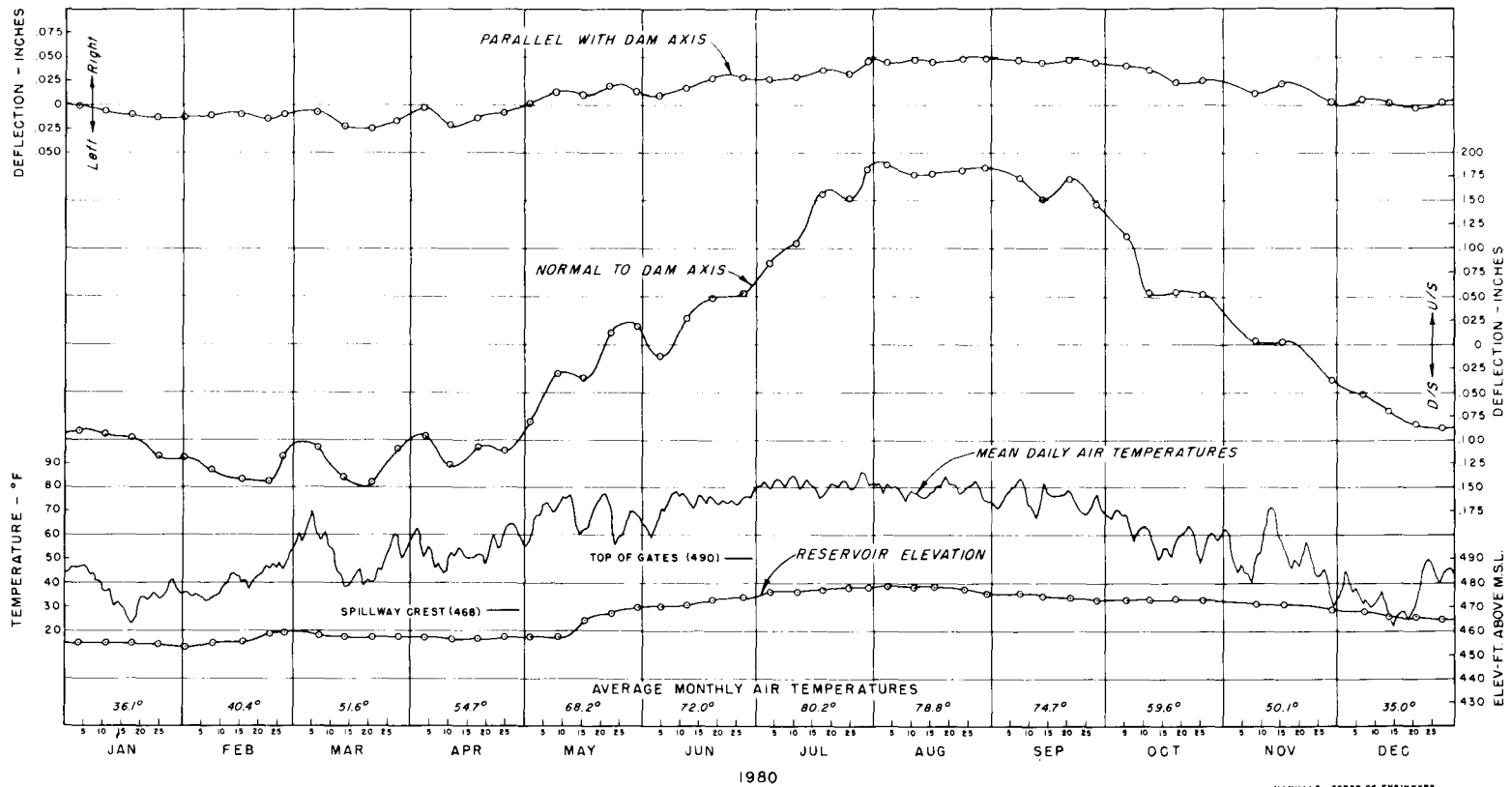

MANUALS - CORPS OF ENGINEERS
U.S. ARMY

ENGINEERING AND DESIGN
INSTRUMENTATION FOR MEASUREMENT OF STRUCTURAL
BEHAVIOR OF CONCRETE GRAVITY STRUCTURES
TYPICAL DEFLECTION HISTORY
(MONOLITH 13)

EM1110-2-4300

PLATE 4-4

(Prepared by CE-WES)

EM 1110-2-4300
Change 1
30 Nov 87

REVISIONS				
NO.	DATE	DESCRIPTION	BY	APPROVED
1	10-10-87	Revised MM for D & C		

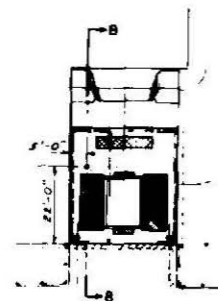

PARTIAL PLAN - INTAKE STRUCTURE - EXISTING
TYPICAL OF FOUR - NO SCALE

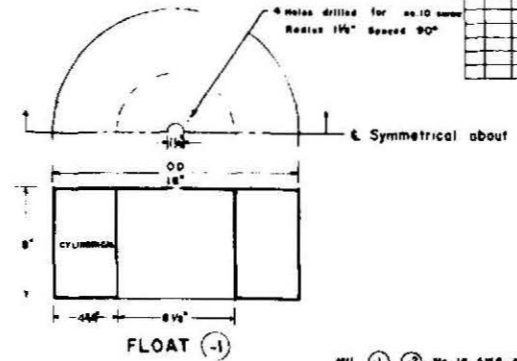
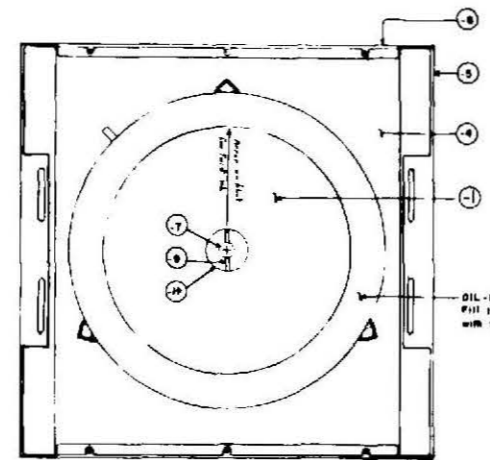

MIL (1) (2) No. 16 AWS Aluminum 3003-H14

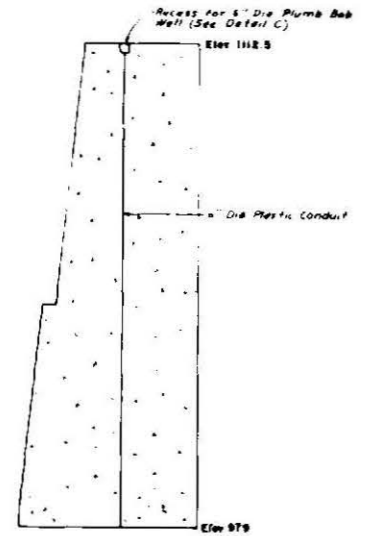

SECTION B-B
SCALE: 1/8" = 1'-0"

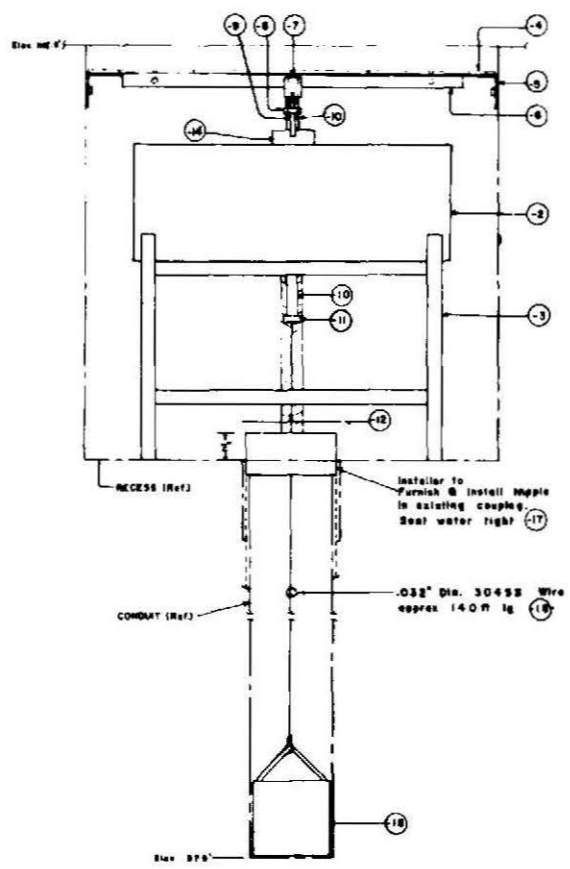

UNIT ASSEMBLY
4 Units required
NOT TO SCALE

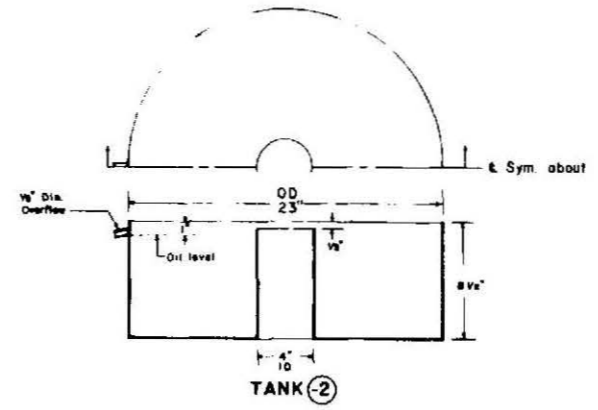

TANK (2)

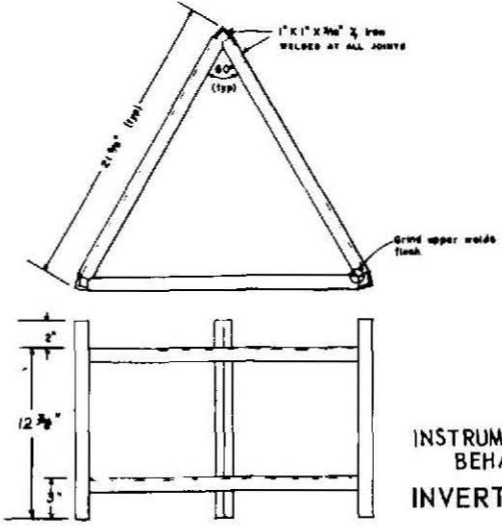

TANK SUPPORT FRAME (3)
scale 1/4" = 1"

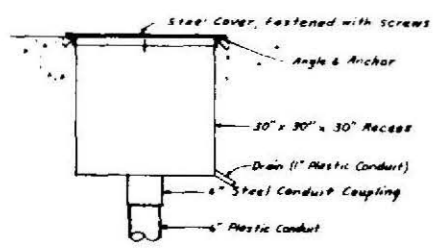

DETAIL C
SCALE: 1/2" = 1'-0"

- NOTES:
- Items shown are per assembly.
 - Items (2) Fabricate from AISI 4140 steel and heat treat to BHN 300 Hard, quench in oil 1350°F and temper 1000°F.
 - Grooves in (3) for placement of (1) are to be ANSIS B4.1 LC-1 location clearance fit.
 - Provide necessary hardware for complete assembly & installation of units.
 - Leave approximately 1.5 feet of SS wire beyond holding screw in has cap and closely coil above (8).

MANUALS - CORPS OF ENGINEERS
U. S. ARMY

ENGINEERING AND DESIGN

INSTRUMENTATION FOR MEASUREMENT OF STRUCTURAL
BEHAVIOR OF CONCRETE GRAVITY STRUCTURES

INVERTED PENDULUM ASSEMBLY AND DETAILS

CARTERS DAM CARTERS, GEORGIA

REVISIONS			
NO.	DATE	DESCRIPTION	APPROVED

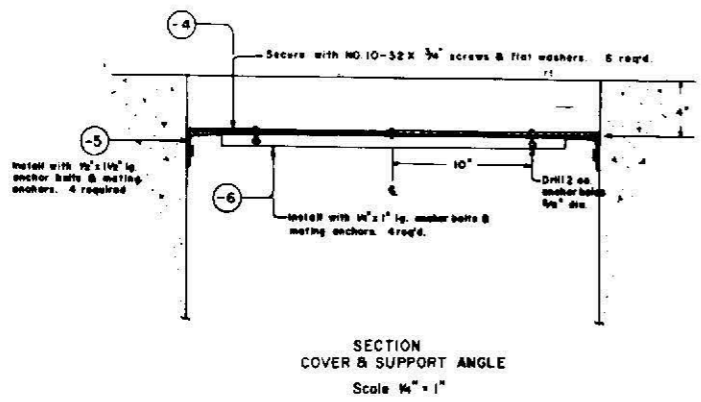
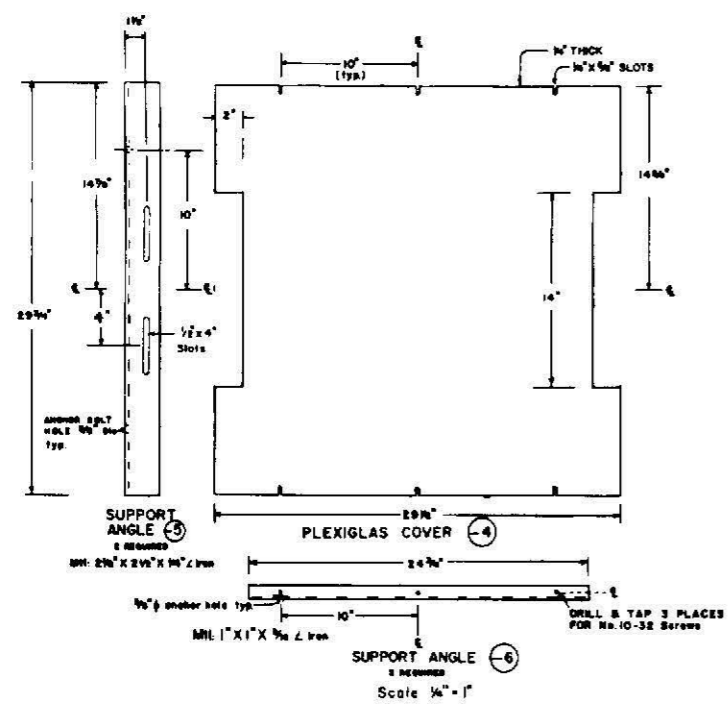

SEE NOTES ON SHEET 1

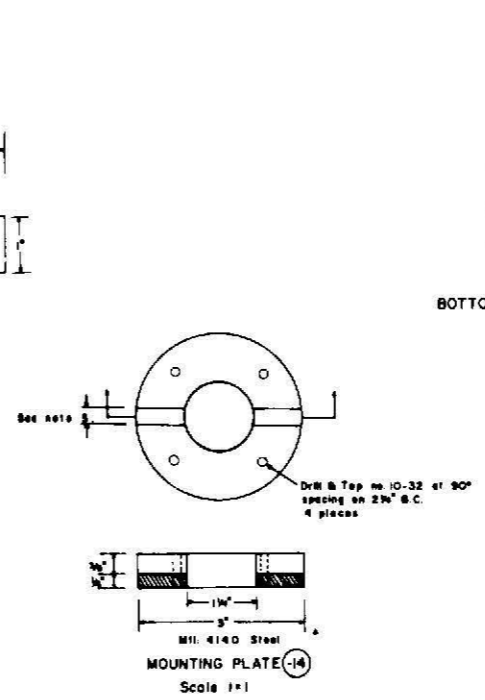
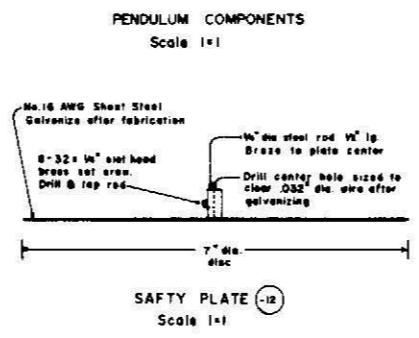
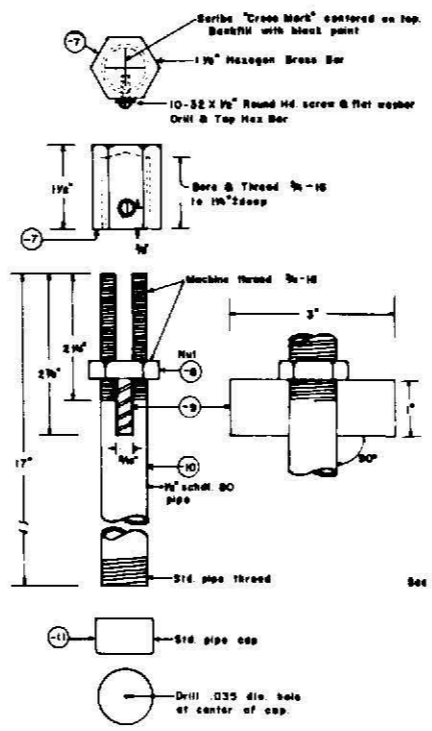

MANUALS - CORPS OF ENGINEERS
U.S. ARMY

ENGINEERING AND DESIGN

INSTRUMENTATION FOR MEASUREMENT OF STRUCTURAL
BEHAVIOR OF CONCRETE GRAVITY STRUCTURES

INVERTED PENDULUM ASSEMBLY AND DETAILS

CARTERS DAM CARTERS, GEORGIA

REVISIONS			
NO.	DATE	DESCRIPTION	APPROVED

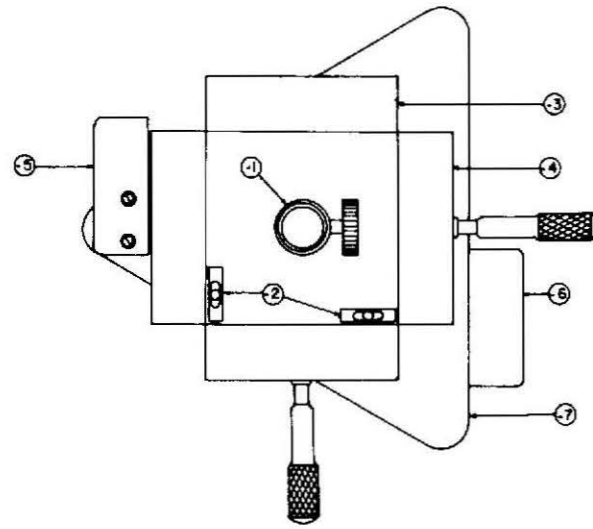

PLAN VIEW

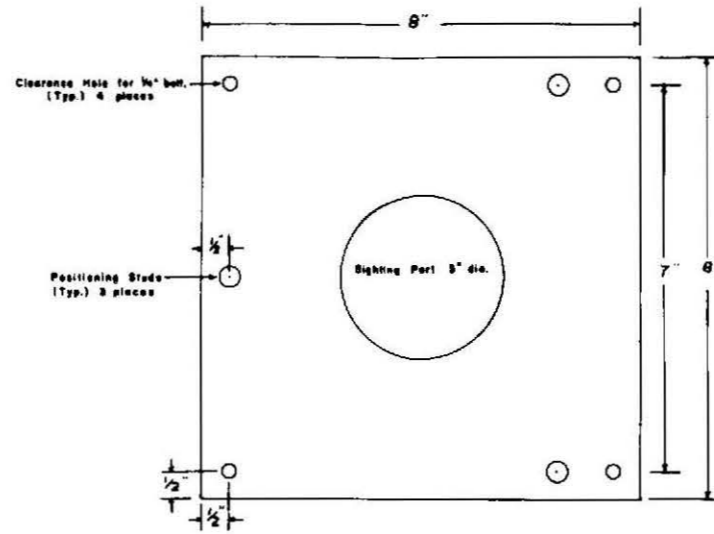

PLAN VIEW

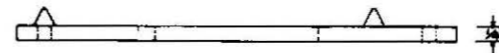

ELEVATION VIEW

SUPPORT PLATE
 Match Positioning Studs to (1) See note 2
 4 Required

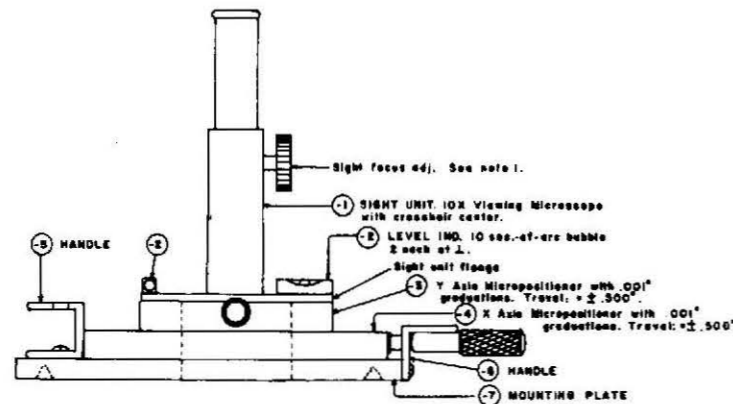

ELEVATION VIEW
 SIGHT ASSEMBLY
 1 Required

- NOTES:
1. For required vertical coverage of Focus control see the specifications.
 2. For required repeatable positioning on each respective Plate see the specifications.

MANUALS-CORPS OF ENGINEERS
 U.S. ARMY

ENGINEERING AND DESIGN

INSTRUMENTATION FOR MEASUREMENT OF STRUCTURAL
 BEHAVIOR OF CONCRETE GRAVITY STRUCTURES

OPTICAL PLUMB ASSEMBLY
 CARTERS DAM CARTERS, GEORGIA

SHEET 3 OF 3

CHAPTER 5

CRACK AND JOINT MEASURING DEVICES

5-1. Purpose. In both new and existing structures the development of cracks and the movement of joints are indications of stresses on the structure that are sometimes above normal. In some cases these conditions can be anticipated beforehand while in others the situation arises spontaneously. Measurement of these areas of distress is provided through crack and joint displacement indicators that can either be installed in predetermined locations to monitor expected cracks or observe joint behavior, or placed at the site of a known crack or joint as the need arises for its monitoring.

5-2. Description of the Instruments. These instruments are either manual in operation or utilize one of the electrical principles adaptable to displacement measurement. The monolith joint displacement indicator, relative movement indicator, ball-n-box gages, multiposition strain gage, dial gage, "L" shaped gage, and scratch gage are all manual gages requiring periodic reading to determine the displacements. The Carlson joint meter and the multiple position borehole extensometer are electrical instruments utilizing the change in resistance of a stretching wire as a measure of strain.

5-3. Instrument Details and Characteristics.

a. Relative Displacement Instruments. There are three types of gages in this category, the monolith joint displacement indicator, the relative movement indicator, and the ball-n-box gage. All three instruments use the same procedures to monitor monolith movement in three dimensions. They function by measuring the relative displacement between two surfaces of the instrument attached to opposite sides of a crack or joint. As the crack or joint moves, the two halves of the gage move relative to each other. The monolith joint displacement indicator consists of two cold finished, SAE 1018 steel bars as shown in Figure 5-1 and Plate 5-1. These bars are 1-1/2- by 1-1/2-in. in cross section with 1-1/2- by 3-in. measurement surfaces faced with at least 1/8-in. hard brass, machine-ground to a smooth surface. The pairs of opposing finished surfaces, C-C', D-D', and E-E', shown in Plate 5-1, must be parallel to each other.

15 Sep 80



Figure 5-1. Monolith Joint Displacement Indicator. (Photo by WES)

b. The Relative Movement Indicator. This gage consists of two steel angles that bolt to either side of the crack or joint to be measured. The gage is shown in Plate 5-2. The indicator arm bolts to the flange of one of the angles and consists of a 5/8-in. diameter threaded stainless steel shank with a 1-in. diameter stainless steel ball soldered to the end of the shank with silver solder. The ball sits in a 1- by 1-1/2-in. cutout in the flange of the remaining angle. Accessories necessary to measure movement with this gage include a setting and checking gage, shown in Plate 5-2, and a conventional 24-leaf automotive thickness gage (.0015- through 0.32-in.). This gage is also described in ETL 1110-2-118.

c. Ball-n-box Gage. This third type of relative displacement indicator, shown in Figure 5-2 and Plate 5-3, will measure relative movement in three orthogonal directions across a crack or joint. The gage consists of a chrome-plated steel or brass rod with a steel ball silver soldered to the tip of the rod attached to the structure on one side of the crack or joint and a hollow, box-type aluminum frame bolted to the structure on the opposite side of the crack or joint. The three reference faces of the box have been machined orthogonal to each other.

(1) Measurement is made by the use of a dial gage mounted on a base plate. The foot of the dial gage is placed on the steel ball and moved until the minimum reading on the dial gage is achieved. This point will be the highest point on the steel ball with respect to the face of the hollow box from which the measurement is being made. This minimum dial gage reading is recorded and compared to the previous reading for that face of the cube to determine the relative movement of the two sides of the joint or crack.

(2) The accuracy of measurement has been recorded down to 0.001 in. and good consistency of measurement has been achieved even with multiple instrument readers. More detailed information about this instrument can be obtained from the Omaha District Corps of Engineers.

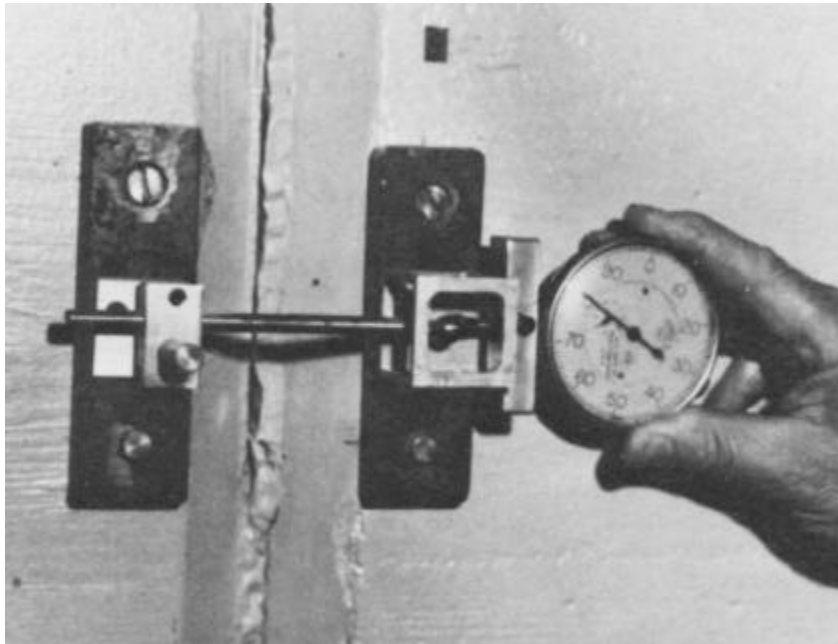
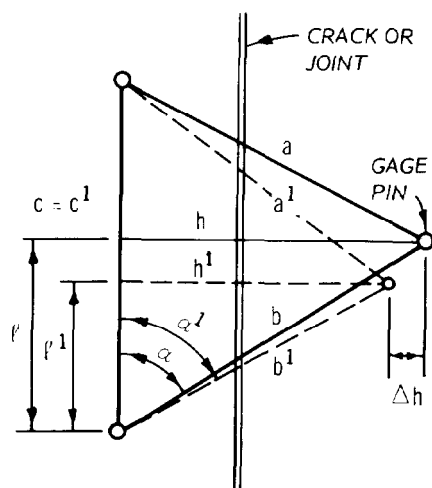

Figure 5-2, Ball-N-Box Gage. (Photo by WES)

15 Sep 80

d. Multiposition Strain Gage. This measurement technique utilizes the Whittemore strain gage described in paragraph 2-28b, and three brass inserts that are placed in the concrete on either side of the crack or joint to be measured. It measures movement in two dimension in the plane of the surface on which the crack appears by measuring the distance between the three inserts and by using triangulation principles to determine the horizontal and vertical components of the movement. Figure 5-3 shows the gage setup and gives the equations necessary for calculation. Two insert pins, one placed on each side of the crack or joint, can also be used; however, this setup will only measure the component of crack movement parallel to the line of the gage points.



$$\cos \alpha = \frac{b^2 + c^2 - a^2}{2bc}$$

$$\rho = b \cos \alpha = \frac{b^2 + c^2 - a^2}{2c}$$

$$h = \sqrt{b^2 - \rho^2}$$

$$\Delta \rho = \rho - \rho^1 \quad \Delta h = h - h^1$$

TO OBTAIN $\cos \alpha^1$, h^1 AND ρ^1 SUBSTITUTE PRIMED VALUES OF a , b , AND c ABOVE.

Figure 5-3. Multiposition Strain Gage. (Prepared by WES)

e. "L" Shaped Gage. The gage shown in Figure 5-4 is another variation of the two dimension measurement gages. It consists of two "L" shaped plates fastened to the concrete on opposite sides of the crack, as shown in the figure. Measurement is made with calipers at the openings between the two gages. This gage will measure movement in the two component directions in the plane of the crack. In addition to translation, this gage will also measure rotation of one side of the crack with respect to the other side. By measuring the gage openings on both sides of the gage, the angle of rotation since the last measurement had been made can be calculated.

f. Dial Gage. The dial gage, shown in Figure 5-5, is intended to measure only expansion and contraction of the crack or joint. The instrument consists of two bars attached to the concrete on opposite sides of the joint with one bar having a mount to accept a dial gage and the other a foot on which the plunger of the dial gage rests. The whole instrument is housed in a metal box with a plexiglass viewing cover, and is attached to the face of the monolith to one side of the crack. Its accuracy is dependent upon the accuracy of the dial gage used.

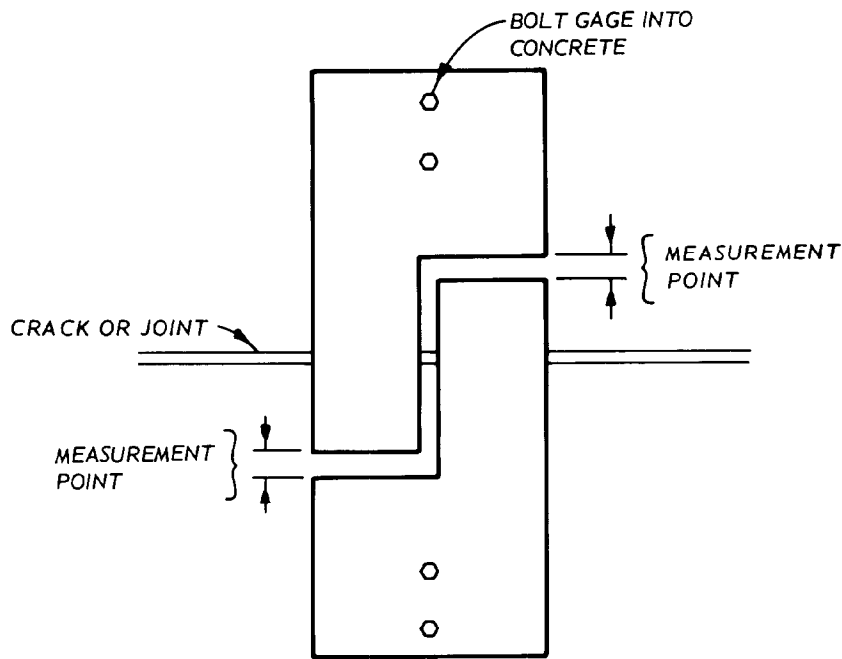

Figure 5-4. "L" Shaped Gage. (Prepared by WES)

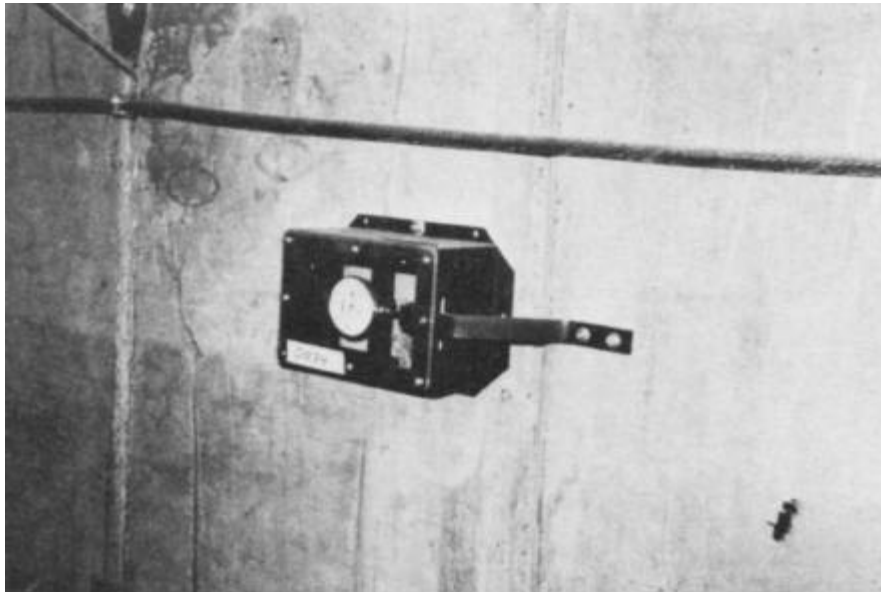

Figure 5.5. One Dimensional Dial Gage. (photo by WES)

g. Scratch Gage. The scratch gage is a mechanical instrument that provides a continuous history of movements, by scribing the movement of one surface with respect to another, on a metal plate. It is described in detail in paragraph 2-28c as a strain measuring instrument, but it also can be used to measure crack movement. The scribings on the ring will represent both tension and compression movements of the crack up to approximately 0.20 in. Since the gage is restricted to movement coincident with its longitudinal axis, the gage must be oriented with its longitudinal axis aligned with the direction of crack movement.

h. Joint Meter. The Carlson joint meter is an electrical movement gage that measures movement as a function of the change in resistivity of a stretching wire. It is intended to be used as an embedment gage, as described in paragraph 2-4 in the strain instrument portion of this manual; however, when mounted as shown in Figure 5-6, it can be used to monitor crack or joint movement at the surface of a structure. Each end of the joint meter must be securely attached to the monolith and span the crack or joint to be monitored.

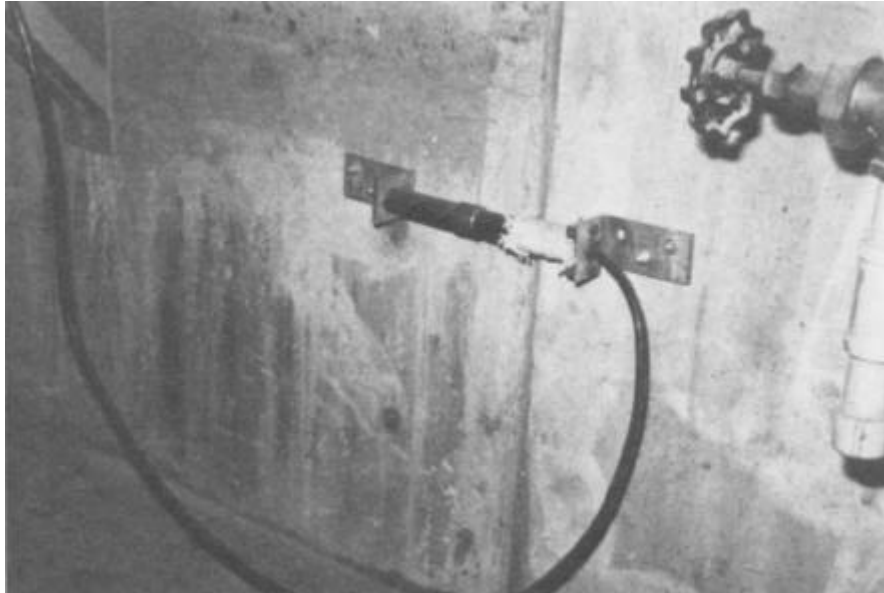

Figure 5-6. Carlson Joint Meter. (Photo by WES)

i. Multiple Position Borehole Extensometer (MPBX). This instrument is well suited to measuring movement of cracks that are not surface accessible. The instrument, as shown in Figure 5-7, is fitted into a borehole and anchored at eight locations. These locations can be between cracks in the interior of a structure to monitor how the concrete is moving. The MPBX measures the relative displacement of the borehole anchors which are mechanically fixed to the wall of the borehole. Each anchor is connected to a tensioning wire which is attached to the sensing head. As the anchors move, they in turn move a cantilever in the sensing head which is connected to an electrical transducer that records the movement of the cantilever.

15 Sep 80

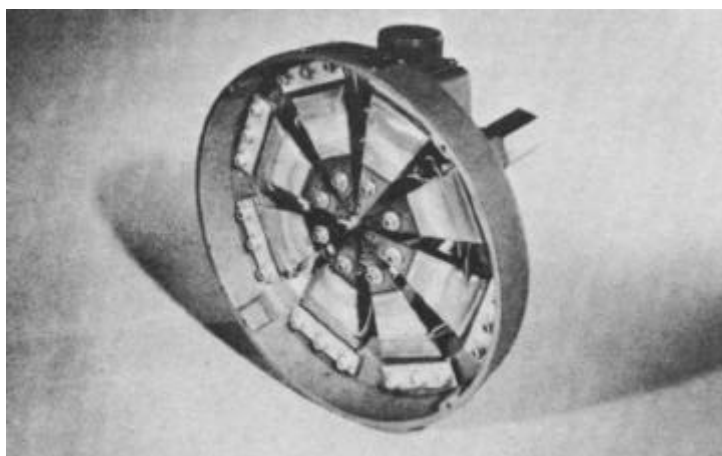

Figure 5-7. Multiple Position Borehole Extensometer (Courtesy of Terrametrics, Inc.).

j. Portable Crack Measuring Microscope. For purposes of measuring cracks conveniently, without installation of a gage, Du Maurier Company, Elmira, NY, manufactures a shirt pocket inspection and measuring microscope of high quality. It is a four lense, prefocused optical system of about the same size and shape as a fat ink pen. It comes in 10X, 20X, 40X, and 50X powers with field of view range of .265-, .190-, .082-, and .065-in. Reading is accomplished by holding the tip of the microscope over the crack, sighting through the eyepiece, and tilting it until the crack comes into focus. At that point the crack width is read directly from the scale superimposed on the field of view. All scales are direct-reading and accurate to within 1 percent.

15 Sep 80

5-4. Instrument Installation.

a. Personnel. The joint and crack measuring instruments covered in this section are primarily intended to be installed after the completion of the construction either at joints that become suspect of excessive movement or at cracks that develop in the structure. The installation of most of these gages requires secure attachment of two halves of the gages to opposite sides of the crack or joint. This can generally be accomplished by one engineer and the necessary crew of workers to install the instruments. In most cases it will be necessary to drill holes in sound concrete on either side of the discontinuity and install either the gage or an anchor. A grouting crew will be necessary to grout around instruments such as the monolith joint displacement indicator installed in drilled holes.

b. Monolith Joint Displacement Indicator.

(1) This measurement indicator is directly embedded into the structure to be monitored. Two drill holes 3-in. in diameter and at least 5-in. deep should be drilled perpendicular to the plane of the surface to be monitored approximately 13 in. on either side of the crack or joint to be measured. The drill holes should be oriented on a line parallel to the direction of major crack movement; for example, if a crack is oriented at 45° to the vertical and it is determined that the major direction of movement of the two cracked faces will be horizontal, then the drill holes should be placed on a horizontal line on either side of the crack.

(2) The gage is installed by filling the 3-in. diameter holes with quick-setting grout that is of a non-shrink nature, and inserting the anchor ends of the gage into the fresh grout. Special care must be taken to assure that the two halves of the gage are installed such that their machined reading faces remain parallel. This can be accomplished by making a template on which to fasten both halves of the gage in their parallel working orientation in order to hold them in place until the grout hardens. This template is shown in Figure 5-8. Once the grout has hardened, the template can be removed.

15 Sep 80

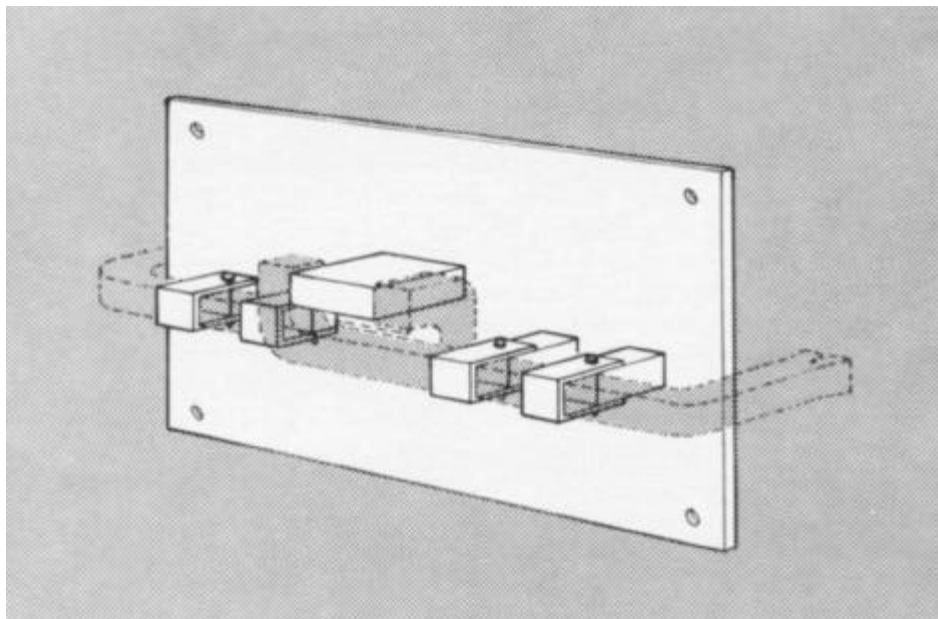

Figure 5-8. Mounting Template for Monolith Joint Displacement Indicator.
(Prepared by WES)

c. Relative Movement Indicator. The gage is installed with one angle on each side of the crack or joint to be monitored. As mentioned in paragraph b above, the major direction of the movement for this gage should also be determined and the gage installed such that the longitudinal axis of the indicator arm is parallel to the major direction of movement. The installation consists of de-burring the concrete in the area of installation and drilling four 11/16-in. diameter-holes in the wall utilizing the "Wall Drilling Template" shown in Plate 5-2. Concrete anchors designed to fit these holes should then be installed. JETLOCK concrete anchors, manufactured by LOCTITE Corporation, Newington, CT, have been used to anchor the bolts into the concrete. Coat the threads of all bolts with an appropriate sealant. The assembly is installed and adjusted to the dimensions shown in Plate 5-2 by the party chief using the setting and checking gage shown on the drawing. The 0.250-in. dimensions are the dimensions that will be logged and these shall be within 0.005 in. of the 0.250 after installation and adjustment. After a 24-hr setup period for the sealant, the dimensions shall be checked and logged and these will be used as the gage initial reading.

15 Sep 80

d. Multiposition Strain Gage.

(1) Installation of this gage consists of installation of the reference points in which to insert the Whittemore type mechanical strain gage. The brass or stainless steel reference points are installed in sound concrete on either side of the joint or crack to be measured. Either two or three points may be installed depending whether movement in one or two directions is to be monitored. If it is desired to monitor movement in two directions, three points should be installed. They should be arranged in the shape of an equilateral triangle with the distance between each reference point approximately equal to the gage length of the reading device. If a Whittemore gage is used, the gage length can be adjusted to 2-, 4-, 6-, 8-, or 10-in. intervals. For purposes of measuring crack width, it is recommended that at least an S-in. gage length be used to insure that the reference points are embedded in sound concrete. On one side of the crack or joint two pins should be installed on a line perpendicular to the major direction of movement of the crack and the remaining reference point should be installed on the other side of the joint a distance equal to the gage length from both reference points on the first side of the crack.

(2) The gages should be set flush with the concrete surface and just prior to the first reading should be center punched to accept the cone-shaped point of the Whittemore gage. If only vernier calipers are available to read the distance between reference points, the pins must be set to protrude above the concrete surface enough to allow the calipers to be used. With this setup there is the danger that the points will be accidentally damaged or bent. This method should only be used when a Whittemore type strain gage is not available and if it is used the points should be protected against accidental damage.

(3) A two-pin system consisting of one pin on each side of the crack or joint, oriented parallel to the major direction of crack movement, may be suitable in some cases. Measurements will indicate opening and closing of the crack but no other movement can be detected.

e. Dial Gage. The dial gage is mounted on a bar assembly attached to one side of the crack and the dial gage oriented such that the longitudinal axis of the plunger is parallel to the major direction of crack movement and seated against a foot attached to the concrete on the other side of the crack. The entire assembly is then housed in a protective case that is attached to the concrete on the same side of the crack as the dial gage. Care should be taken to insure that the plunger of the dial gage is seated in the center of the foot so that minor movement will not cause the dial gage plunger to slip off the reference foot.

f. Scratch Strain Gage. The scratch strain gage is installed with the recording or scratching arm on one side of the joint and the target or scratched plate on the other. Special precautions should be taken when installing the scratch strain gage to insure that the longitudinal axis of the gage is oriented parallel to the direction of crack movement. In the case of strain measurements the length between points of attachment of the gage to the concrete must be accurately known to determine the strain. In the case of crack measurement this is not necessary because all the expansion or contraction will take place at the crack. If mechanical fasteners are used, the distance over which the strain is being measured is the distance between the fasteners; however, if the gage is attached by use of an adhesive, the adhesive should be confined to a limited area of the gage such that accurate measurements of the distance between adhesive areas can be made.

g. Joint Meter. The joint meter measures movement parallel to its longitudinal axis. For this reason the gage must be installed with the longitudinal axis of the gage parallel to the major direction of crack or joint movement. If there is movement in two directions, the joint meter will indicate the distance between points of fastening of the meter, but will not differentiate between horizontal or vertical movement. The cable from the meter should be secured to the floor or wall of the gallery so that it will not be pulled loose or damaged by accident.

h. Multiple Position Borehole Extensometer.

(1) Anchor Installation. In order for this instrument to function properly, care must be exercised in its installation. The anchors must be pushed down the borehole with a special installation tool. This tool is designed to allow the anchor to move freely when being pushed into the hole, but when it is in place and the setting tool is retracted, its design is intended to set the anchor against the sides of the borehole. The anchors must be placed carefully such that the measuring wire which is attached to the anchor before it is placed in the hole will not get tangled or wrapped around the other wires in the hole.

(2) Head Installation. The borehole extensometer head contains the transducers that monitor the motion of the concrete in contact with the extensometer's anchors. The head should be recessed in the concrete such that it will be protected when the installation is complete. A cover should be placed over the recess to add extra protection to the electrical mechanisms in the head.

5-5. Collection of Data.

a. The data sheets for recording the readings of the various instruments mentioned in this chapter should be devised to suit the type of movement indicator that is being monitored. Plates 5-4 through 5-8 are suggested field data sheets for the various gages reported here. They may be used in their entirety or tailored to the user's needs.

b. The peripheral information collected when each gage is read should include at least all of the following: the name of the structure at which the gage is located, the date upon which the readings are taken, the time the readings are taken, the temperature at the gage location, and the ambient temperature at the site of the structure, and pertinent pool elevations. The time of day and temperatures should be recorded to adjust the gage for temperature expansion or contraction. They also help identify the cause of the structure movement. The pertinent pool elevations are necessary such that it can be known what loading conditions the structure is subjected to. Additional information that is deemed pertinent by the reading party chief should also be included.

c. All the gages in this chapter have relatively direct field reading values that can be recorded directly from the instrument or readout device onto the data sheet. However, the scratch strain gage must be read under a microscope with calibrated eyepiece. This should be done either in a laboratory or field office where the movements can be accurately read and recorded. A special microscope for reading the scratch strain gage (Figure 5-9) is available from Prewitt Associates, Lexington, KY. It is a small microscope with calibrated eyepiece, attached lighting source, and a rotating device to change the position of the target while it is under the microscope.

d. The data sheets are set up to read a number of different gages at various locations all within the same reading period. This is done to have a record of all movements on a certain date on one sheet and that comparisons with data taken on other dates will only require two data sheets. Protection of accumulated data should be accomplished in the same manner as that described in paragraph 2-24b of Chapter 2.

15 Sep 80

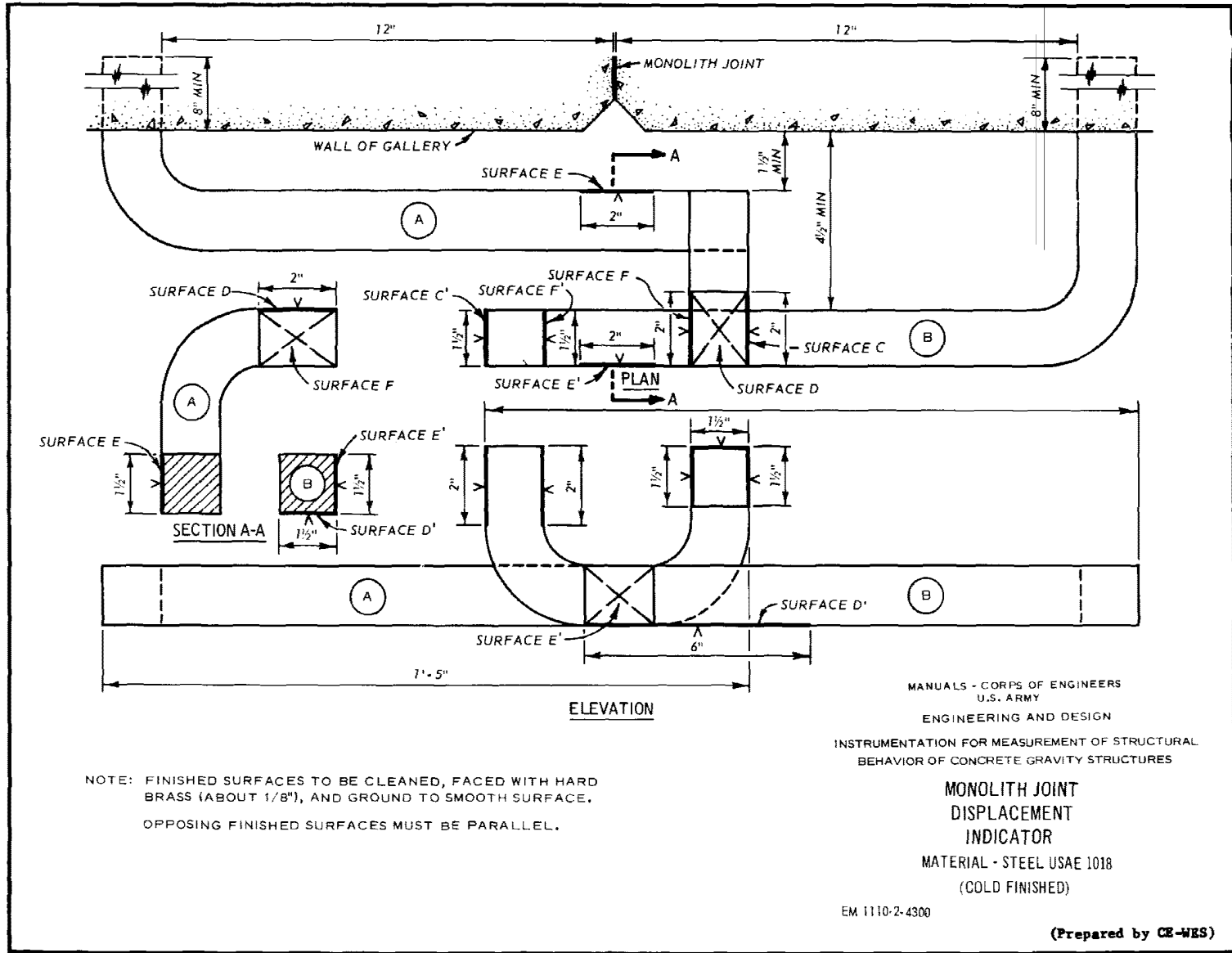

Figure 5-9. Scratch Strain Gage and Reading Microscope (Courtesy of Prewitt Associates).

5-6. Reading Schedules. The frequency of readings should be governed by the location and type of crack or joint being studied. In situations where a new crack has formed it is advisable to read the gages at least weekly until the movement of the crack is better understood. Also in the case of a lock wall reading with the lock empty and then lock full may be appropriate. Readings every month may be suitable on some portions of a dam. After the rate, amount, and direction of movement have been determined, the frequency of readings should be adjusted as required by the behavior of the crack or joint.

5-15

Plate 5-1



NOTE: FINISHED SURFACES TO BE CLEANED, FACED WITH HARD BRASS (ABOUT 1/8"), AND GROUND TO SMOOTH SURFACE.
OPPOSING FINISHED SURFACES MUST BE PARALLEL.

EM 1110-2-4300
15 Sep 80

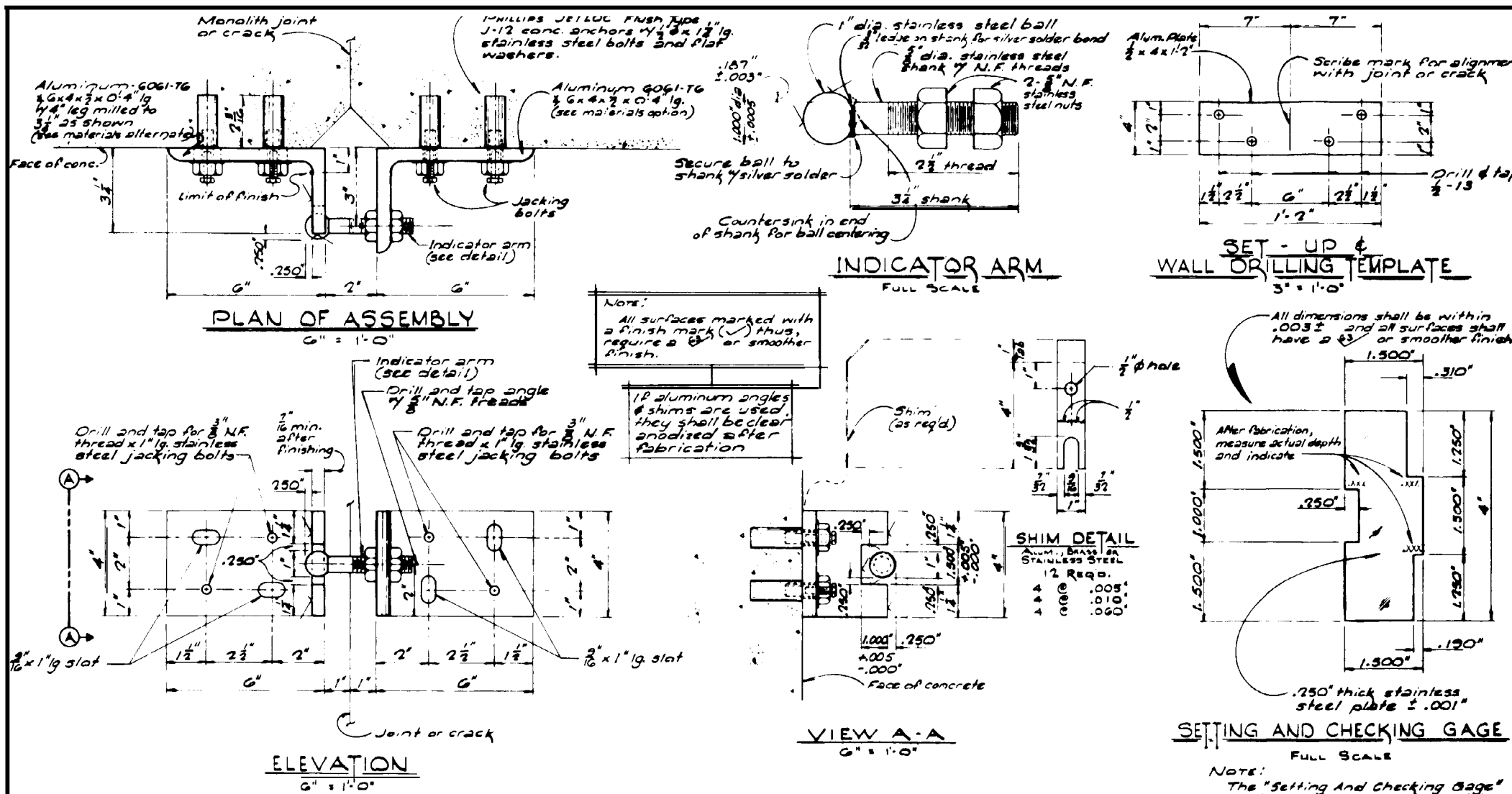

Materials Alternate

The 6 x 4 x 3/8 angles may be stainless steel or heavy chrome plated mild steel. If the chrome plated steel option is selected the threads for the jacking bolts and indicator arm shall be protected during the chrome plating process to assure proper thread fit.

Installation Procedure

De-burr concrete in the installation area. Drill 4-1/16" φ holes in wall utilizing "Wall Drilling Template" and install "JETLOC" concrete anchors. Treat threads and for 1/2" φ and 3/8" φ bolts with "LOCQUIC CLEANER" and "LOCTITE SEALANT", Grade "A" (Loctite Corporation, Newington Conn.) Install and adjust assembly to dimensions shown on the drawing using "Setting And Checking Gage", slotted holes, shims and jacking bolts as required. The .250" dimensions are the dimensions which will be logged and these shall be within .005" of the .250" after installation and adjustment.

MANUALS - CORPS OF ENGINEERS
U.S. ARMY
ENGINEERING AND DESIGN
INSTRUMENTATION FOR MEASUREMENT OF STRUCTURAL
BEHAVIOR OF CONCRETE GRAVITY STRUCTURES
RELATIVE MOVEMENT INDICATOR

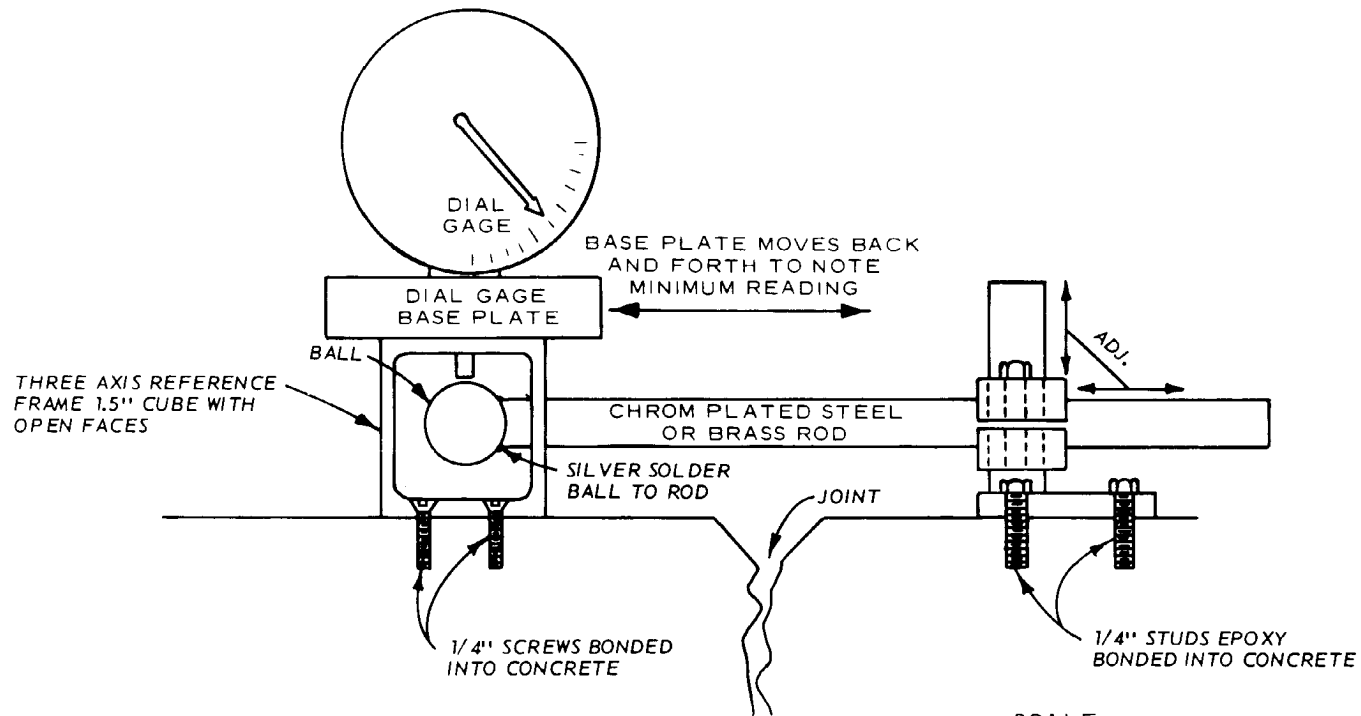

NOTE: THIS UNIT IS BEING USED WITH GOOD RESULTS TO MEASURE MOVEMENT ACROSS JOINTS IN CONCRETE STRUCTURES. THE REFERENCE FRAME HAS PRECISELY MACHINED FACE SO THAT THE DIAL GAGE BASE PLATE CAN BE MOVED TO THREE ORTHAGONAL FACES. SKETCH SHOWS DIAL GAGE POSITION FOR MAKING VERTICAL MOTION MEASUREMENT.

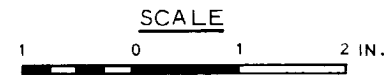

MANUALS - CORPS OF ENGINEERS
 U.S. ARMY
 ENGINEERING AND DESIGN
 INSTRUMENTATION FOR MEASUREMENT OF STRUCTURAL
 BEHAVIOR OF CONCRETE GRAVITY STRUCTURES
BALL-N-BOX INSTRUMENT
 FOR MEASURING MOVEMENT ACROSS
 JOINTS IN CONCRETE STRUCTURES

EM 1110-2-4300

(Prepared by CE-WES)

MULTI POSITION STRAIN GAGE FIELD DATA SHEET

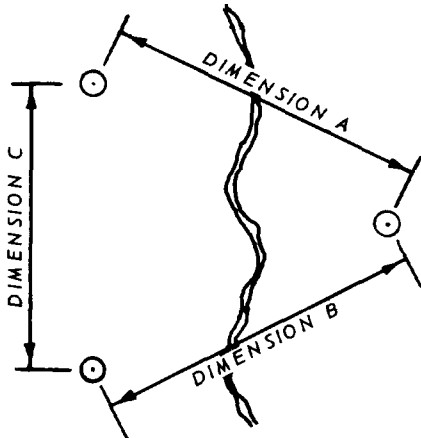

THREE POINT ARRANGEMENT

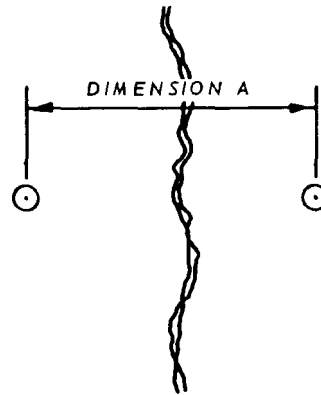

TWO POINT ARRANGEMENT

PROJECT: _____
 DATE: _____ TIME: _____
 TEMPERATURE: _____
 PERTINENT POOL ELEVATIONS:
 UPSTREAM: _____ DOWNSTREAM: _____
 LOCK FULL: • LOCK EMPTY: •
 FOR INITIAL READING SEE SHEET DATED: _____

GAGE LOCATION	DIMENSION A	DIMENSION B	DIMENSION C

COMMENTS: _____

SHEET OF _____

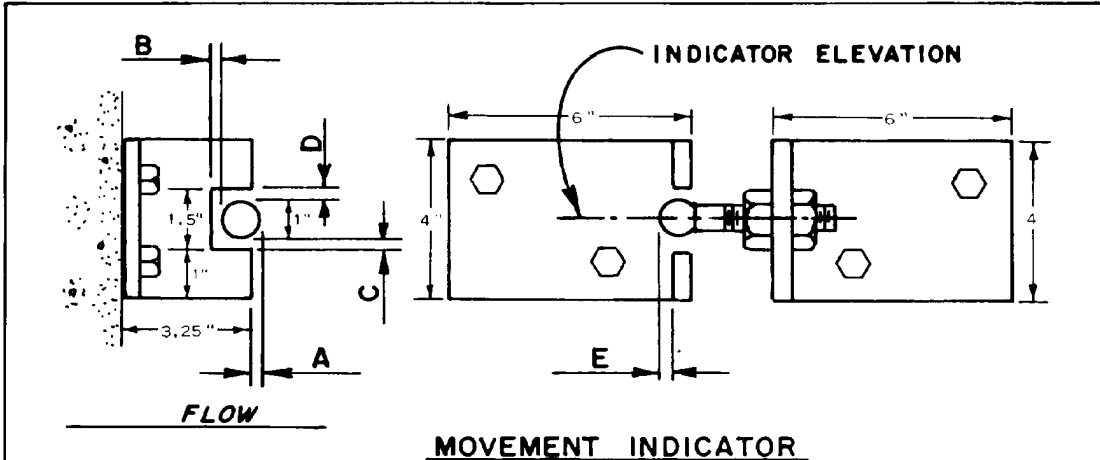

MOVEMENT INDICATOR

PROJECT:	DATE:	TIME:	POOL ELEV. U.S. D.S.	OUTSIDE AIR TEMP.
-----------------	--------------	--------------	-----------------------------------	--------------------------

LOCATION OF MEASUREMENT	DIMENSIONS (IN INCHES)					INDICATOR ELEVATION
	A	B	C	D	E	
JOINT OR CRACK						

COMMENTS:

(Prepared by WES)

Plate 5-5

CHAPTER 6

PRECISE MEASUREMENT SYSTEMS

Section I. Types of Measurement

6-1. Purpose. Bending, tilting, and displacement of concrete structures may be detected by measuring changes in horizontal alignment and vertical deflection of their separate parts. Measurement of the position of dam monoliths at six-month intervals over a period of several years provides an indication of the net magnitude of elastic or inelastic deformations that occur in the structure and its foundation. Twisting of side hill blocks and excessive variations in foundation deformations may be detected. All of these types of data are valuable as an indication of the stability of the structure, and furnish information in regard to the correctness and validity of the various design assumptions and analytical procedures.

a. The measurement techniques described in this chapter represent the present technology in the field of precise determination of lengths, angles, and alignments. The instruments include optical, laser, and wavelength techniques to provide alignment, distance measurement, and minute movement to very high degrees of accuracy.

b. On dams and similar structures these techniques require setting up permanent and movable monuments as reference points for using the instruments and targets. Permanent marker points are set in the top and the toe of structures, and length, alignment and deflection readings are made with the precise instruments set up on these monuments. Readings from the electronic instruments that relate to distance measurement are generally accurate to 0.01 ft while alignment measured with the use of micrometer targets are recorded to the nearest 0.001 in., and are usually made at night to avoid troublesome optical distortions due to sunlight and heat radiation.

6-2. Types of Measurement. The types of measurement described in this paragraph fall into three categories, precise alignment instruments, precise distance measuring instruments, and triangulation and trilateration surveys, depending upon their purpose and method of operation. Their installation and operation procedures will be described in more detail in Sections II-IV of this chapter.

a. Precise Alignment Instruments. These instruments function by establishing a precise reference line described by the instrument and the measurement of the distance between markers on the structure and this precise reference line.

15 Sep 80

(1) Laser Alignment Instruments. This type of instrument is best suited for finding deflections of structures perpendicular to a base line along the length of the structure such as lock wall deflections or dam deflections due to changes in pool elevation.

(2) Theodolite Alignment. This measurement system is similar to the laser alignment system in that it also measures deflections from a base line, however, it uses conventional high precision theodolites and optical targets and has a shorter maximum range than the laser measurement system.

(3) Precise Leveling. This method of measurement uses precise levels and rods to measure change of elevation from a previously established elevation.

b. Precise Distance Measuring. This type of measuring technique utilizes the measurement of the time that it takes a wave of light to travel from its source to a reflector and back to the source. Since the speed of the light wave can be accurately measured and corrected for various conditions of atmospheric density, the distance from source to target is a function of the time it requires the light beam to travel the course. The instrument used for this measurement is the Electronic Distance Measuring (EDM) instrument. This type of precision measurement is made to accurately determine the distance between a reference monument and an alignment marker. Used in its primary capacity it will accurately measure distance, however, when it is used in triangulation and trilateration surveys it will measure deflection of alignment markers.

c. Triangulation and Trilateration Surveys. These methods of precise measurement utilize theories and equations of geometry to transform linear and angular measurements into deflections of alignment points.

(1) Triangulation. This is a method of measurement where deflection of alignment markers is determined by measurement of a base line and the angles associated with the three sides necessary to describe a triangle. This system works well to measure deflections of points on a structure with a curved longitudinal axis. It does not measure vertical deflection well unless the base line and angles measured are in a vertical plane.

(2) Trilateration. This method of measurement determines deflection of points on a structure by successive measurements of the lengths of lines necessary to construct a triangle. It uses the trigonometric principles of angle calculation from known lengths of the sides of triangles to determine the location at points on a structure. It can be used on structures with straight or curved axes and will measure vertical deflection if the measured triangles are in a vertical plane.

Section II. Precise Alignment Instruments

6-3. Laser Alignment Instruments.

a. Description of the Instrument. The laser system consists of a two-component unit of a transmitter and a receiver. The transmitter shown in Figure 6-1 developed by the U. S. Army Engineer Topographic Laboratory, is a continuous-wave helium-neon gas laser, mounted in a yoke, which is similar to the standards of a theodolite, with elevation and azimuth adjustments. The laser mount is attached to a Wild T-2 tribrach which has a built-in circular level and optical plummet for centering on a reference point. The laser exciter is a separate unit and can be operated by either 12-v dc or 115-v ac current. The laser transmitter is equipped with a 2.0-in. beam expanding telescope to provide the necessary degree of collimation.

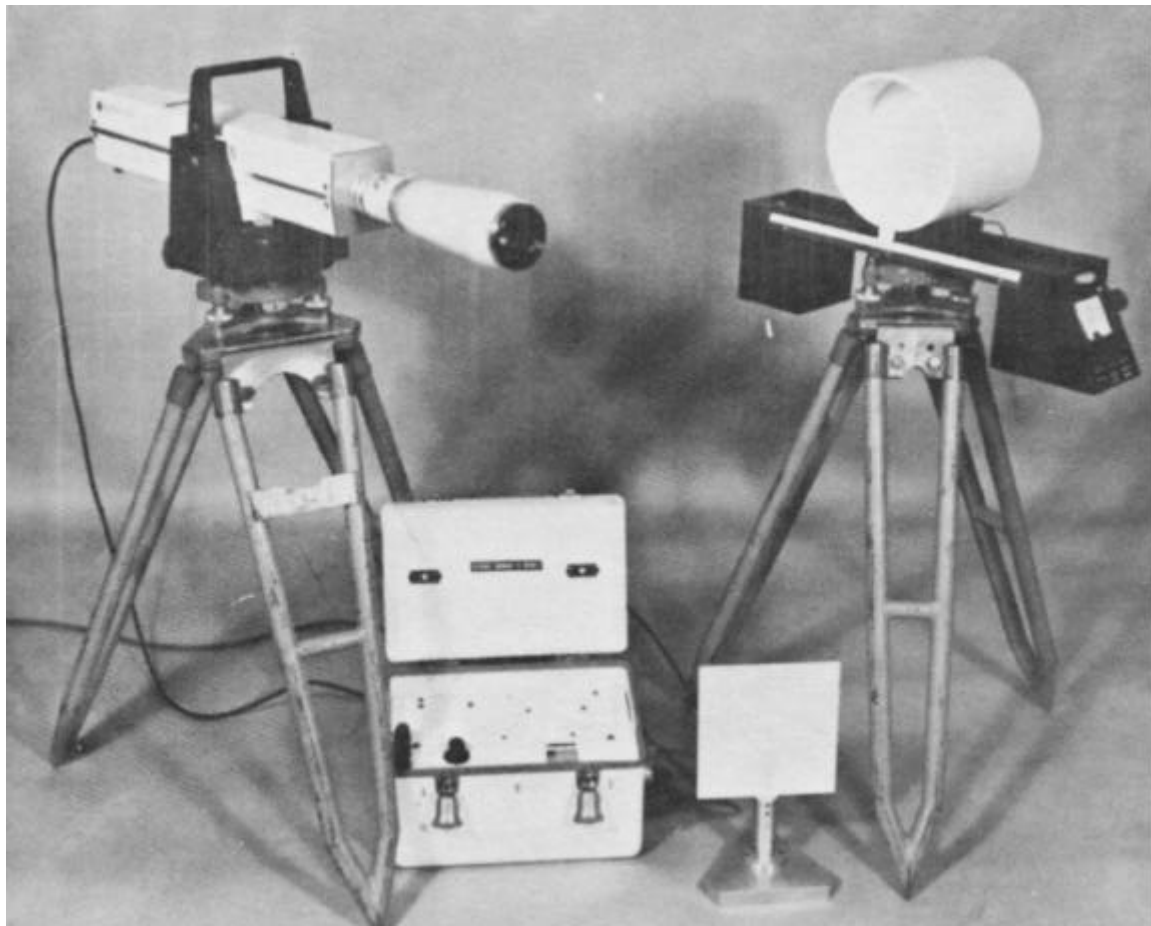

Figure 6-1. Laser Transmitter, Power Source, Alignment Target, and Receiver. (Courtesy of Engineer Topographic Laboratories)

15 Sep 80

b. Receiver. The fixed target used with a laser is called a receiver. The receiver is basically a short cylinder mounted horizontally, with a vertical divider separating the cylinder into two equal chambers. A lucite diffusion plate covers the receiving end of the cylinder, and a cadmium sulfide photoconductive cell mounted in each chamber measure the amount of light received. The receiver is wired through a Wheatstone bridge circuit to a 50-0-50 microamp meter for readout. Four damping elements in the circuit provide adjustable damping for meter stability. The receiving chamber is mounted on a dovetail slide base assembly which is, in turn, mounted on a Wild T-2 tribrach with built-in circular level and optical plummet. Movement of the receiving chamber is accomplished by an endless cable on the base. Measurement is made on a metric scale fixed to the base and externally lighted for reading ease. Reading is direct to 1 mm and interpolation can be made to 0.1 mm.

6-4. Instrument Installation. Precise laser alignment measuring is accomplished by establishing a straight base line between reference points preferably beyond the structure, and the measurement of the points on the monolith along the base line at periodic intervals. The measurements obtained are an indication of the net magnitude of elastic and inelastic deformations that occur in the structure and its foundation.

a. Location of Reference Monuments. The location of the reference monuments and monolith marker points should be established along the proposed base line as shown in Figure 6-2. The base line should be located so that at completion of construction the line of sight between the reference monuments is unobstructed. Also, consideration should be given to location based on least interference from other operations during alignment measurements. The reference monuments should be located off the structure a sufficient distance not to be influenced by movement of the structure. In instances where this is impractical, the first marker point at each end of the structure may be used as reference points providing the end blocks have low and level foundations. The reference monument elevation should be the least practical vertical height above the structure to maintain the least angle between the precision instrument and monolith marker points. Normally two marker points will be installed on each side of a vertical joint between monoliths. An overall plan and a section between reference monuments and first marker point on the structure should be part of the design submission.

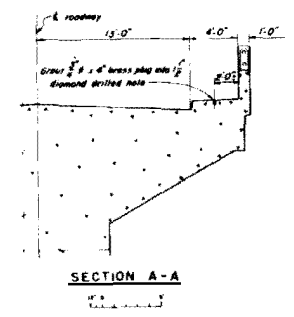
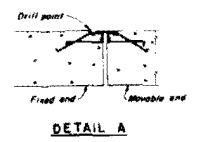
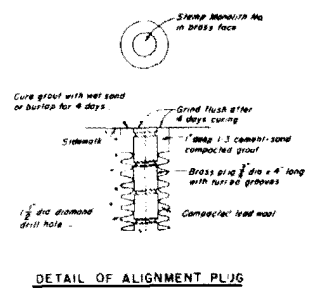
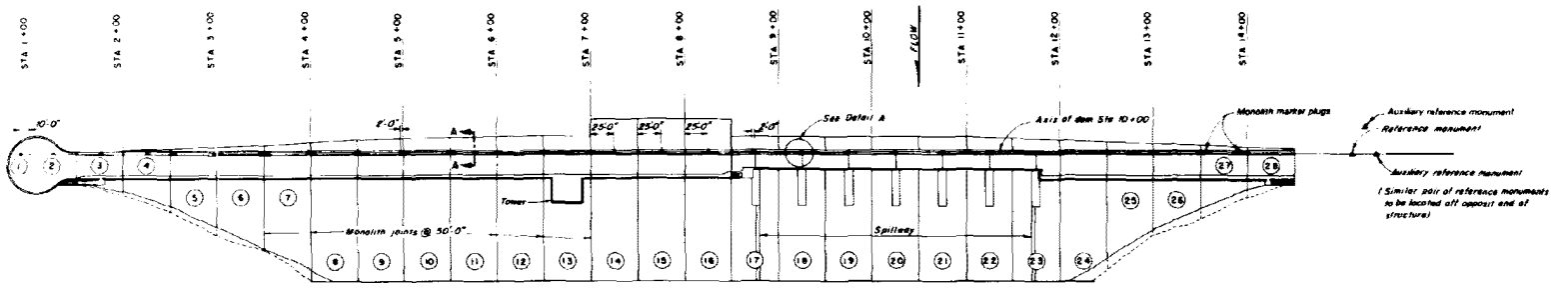

6-6

Figure 6-2. Example of Precise Alignment Layout.
(Prepared by CE-WES)

15 Sep 80

b. Monolith Marker Plugs. The brass tablet and brass plugs should be installed by a government survey party. The reference monuments and holes for marker plugs may be installed by the contractor but coordination between contractor and government forces is necessary. If installation is in a new structure, the markers may be set in the fresh concrete; if the installation is in an existing structure, holes must first be drilled in the concrete and then filled with a non-shrink grout and the markers set in the fresh grout.

c. Transmitter. In use, the laser transmitter is placed approximately in line with the monuments and at least 3 ft beyond the end point of the marker line. The laser beam is then directed to strike a reflection target mounted at a corresponding position beyond the other end of the line. The distance between each monument and the source of the laser beam is then measured with the centering detector. Finally, the distance between monuments is measured with a tape. These distance measurements need only to have an accuracy of about one part in 300 and under normal circumstances, need not be repeated during future alignments. Final calculations of alignment may be made with a slide rule.

6-5. Data Collection. During data collection several precautions should be taken to assure good readings. If conditions are subject to gusts of wind, the instrument should be shielded to prevent movement due to high wind forces. Since the stability of the laser beam is directly proportional to the stability of ambient atmospheric conditions, it is recommended that two receivers be used in a survey, one placed at the end point and one placed at the intermediate reading point. As a measurement is made on the intermediate point, one would be made on the end point to measure the beam refraction at that time. Then the appropriate portion of the change could be applied to the measurement taken at the intermediate point. At each point between the two end points, the perpendicular distance from the marker to the reference line is recorded.

6-6. Data Reduction. The data for each monument are read by the instrument monitor and recorded on a field data sheet similar to the one shown in Plate 6-1. When data have been taken for each monument, including the two end point monuments, calculations may be made in the field with a slide rule. The distance between the first and last reading of the alignment network shows how much the markers are out of parallel with the laser beam. By linear proportioning, this difference can be distributed to each of the intermediate points in the network. These adjustments are then subtracted from the raw readings at each intermediate point to get the adjusted reading. If the data are reduced in the field, the data sheet shown can be used and, when completed, sent to the district office. A modified version of this sheet showing only the raw readings, the adjustment, and the distance between the first and last monument can be completed in the field and sent to the district office where the remaining data reduction will be completed.

15 Sep 80

6-7. Theodolite Alignment Instruments.

a. Description of the Instrument. The alignment of structures using the theodolite requires the precision theodolite, reference monument, monolith alignment markers, stationary line-of-sight target, and movable micrometer targets.

b. Precision Theodolite. The theodolite should be one of the precision theodolites capable of at least 30 times magnification. Two such instruments, the Wild T2 and F. W. Breithaupt and Sohn "TEAUT," satisfy these requirements. The eyepiece should contain stadia cross hairs with at least one set of double parallel hairs so that the fixed and movable targets may be more accurately viewed and centered. It is preferred that the instrument be equipped with an optical plummet for centering the instrument over the reference monument; however, a conventional plumb bob or other accurate centering device may be used.

c. Reference Monument. A stainless steel or brass base plate embedded in a concrete monument, which is set on rock or otherwise rigidly fixed, forms the permanent end bench mark. The base plate and the entire monument should be protected by a large diameter concrete pipe and cover. A second auxiliary monument at each end of the dam, set in line with the two principal monuments, will permit recovery of the initial line of sight should a monument be disturbed during construction or maintenance operations.

d. Monolith Marker Points. Single marker points, 3/4-in. diameter brass plugs embedded in the walkway or roadway are normally located on the center line of the dam monoliths. Where two points are placed in a monolith, one should be located adjacent to a bulkhead joint and the other adjacent to the opposite joint.

e. Stationary Line-of-Sight Targets. The distant or fixed targets shown in Figure 6-3 are used in establishing the base line. They are self-lighted targets that are commercially available. The target shown in Figure 6-3.a. is of the type that is rigidly mounted in anchors at the end of the sighting line, and that shown in Figure 6-3.b. is a tripod mounted target that is plumbed over a reference monument when there are no permanent anchor points available such that a target as shown in 6-3.a. can be used. Both targets are back-lighted and can be run by 12-volt battery jacks when conventional line current is not available.



a. Rigidly-mounted target.

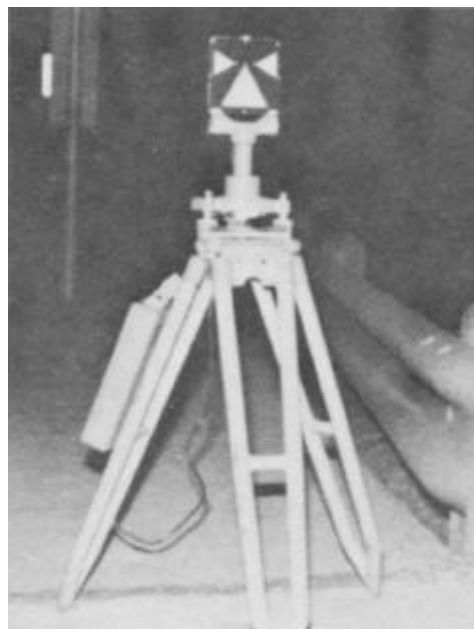

b. Tripod-mounted target.

Figure 6-3. Stationary Line-of-Sight Targets. (Photos by WES)

f. Movable Targets. Two general types of target are available.

(1) The tripod mounted type is shown in Figure 6-4. It consists of a T-shaped tripod in which two of the legs of the tripod are equipped with leveling screws and the third leg, directly beneath the target, fits into a center punch in the alignment marker described in subparagraph d. of this paragraph. The tripod has two perpendicular bubble levels for leveling the target. The target consists of the target plate inserted in a wide mouth vernier caliper. A standard micrometer anvil with vernier readings to 0.001 in. is provided with a recoil spring along the line of vernier travel to facilitate adjustment of the target plate.

(2) The second type of target, shown in Figure 6-5, screws into a tapped plug embedded in the monolith. It consists of a target mounted in a sliding track that is controlled by a micrometer. The target is moved perpendicular to the line-of-sight until it aligns with the stadia hairs of the theodolite, at which time the micrometer is read and data recorded.

(3) Both targets can be illuminated by a portable lamp reflected off the target for measurement made at night, while the second type can also be lit internally.

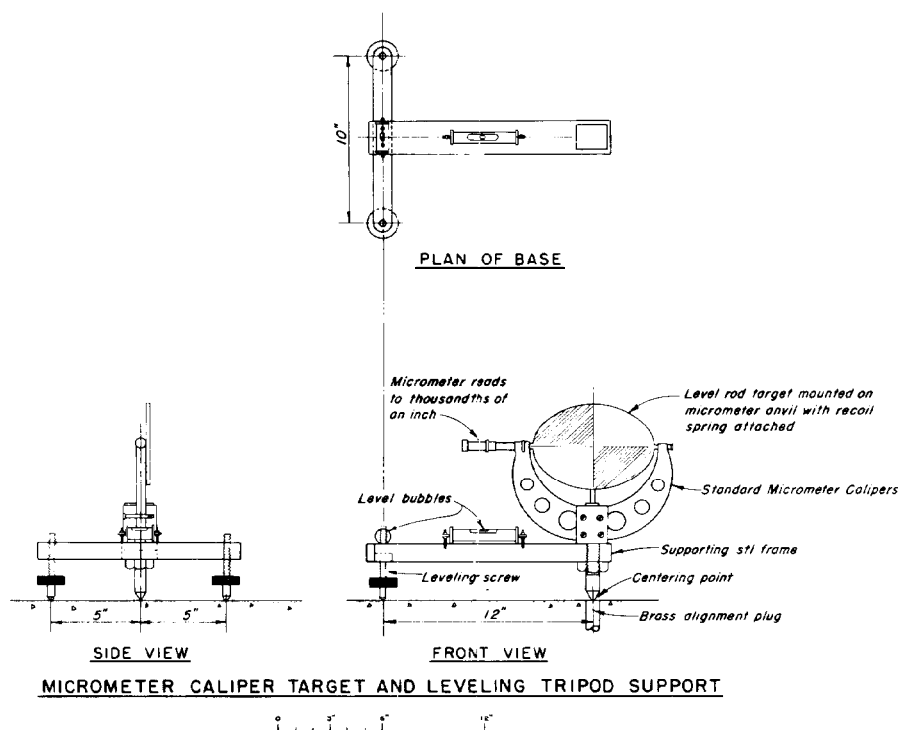

Figure 6-4. Micrometer Caliper Target and Leveling Tripod Support.
 (Prepared by WES)



Figure 6-5. Inserted Micrometer Alignment Target. (Photo by WES)

g. Points on Tangent. Points on tangent between the ends of the dam that are occupied by the theodolite may be established using the device shown in Figure 6-6. The device consists of a heavy steel plate supported by three leveling screws. A movable steel plate controlled by a slow motion screw and having a tapered hole into which a special sighting pin or target is inserted permits aligning the tapered hole on line where it may be clamped in position. When a plumb bob or optical centering device is used on the theodolite, the target of the point-on-tangent device may be replaced with a center punched pin.

6-8. Instrument Installation.

a. Reference Monuments. These monuments are used as the reference points for the theodolite in alignment measurements, and for the theodolite and the Electronic Measuring equipment used in triangulation and trilateration described later in this chapter.

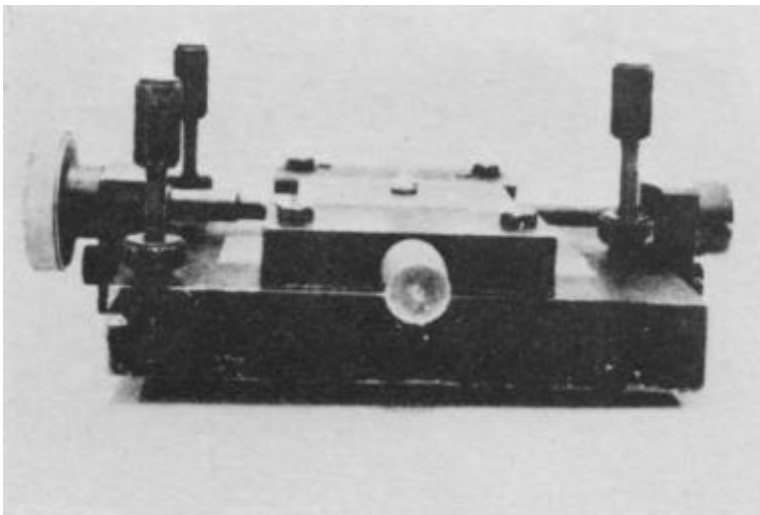

Figure 6-6. Point on Tangent Device with Removable Sighting Pin.
(Photo by WES)

(1) Erection of the permanent reference monuments is usually accomplished late in the construction period to reduce the possibility of accidental disturbances of the embedded posts by heavy equipment. Since they are expected to be the reference base for all subsequent measurements, they must be installed such that they will not move with respect to their foundation. A suggested detail for this type of monument is shown in Figure 6-7. It should be used for systems on large structures using triangulation or trilateration and for other locations where precise surveys are made. The monument consists of two concentrically located casings. The inner casing is filled with concrete and the two are grouted together below the ground level. The inner casing acts as the base for the instrument mounting. As shown in Figure 6-7, the monument should be installed at least 10 ft into foundation rock; however, where no solid rock is located near the surface, it should be anchored in solid material.

(2) Auxiliary monuments of similar construction should be installed in line with the primary monuments and to the outside of the monuments such that they can be used to reset any disturbed primary monuments. The reference points should be brass plugs set in concrete, slightly below grade and protected by a large diameter concrete pipe with cover.

(3) A base plate that is compatible with the instrument to be used should be grouted into the top of the monument. This plate makes it possible to mount the instrument in the same orientation and height every time it is to be used. Fastening devices should be cast into the monuments such that a protective cover can be locked over the monument when it is not in use.

15 Sep 80

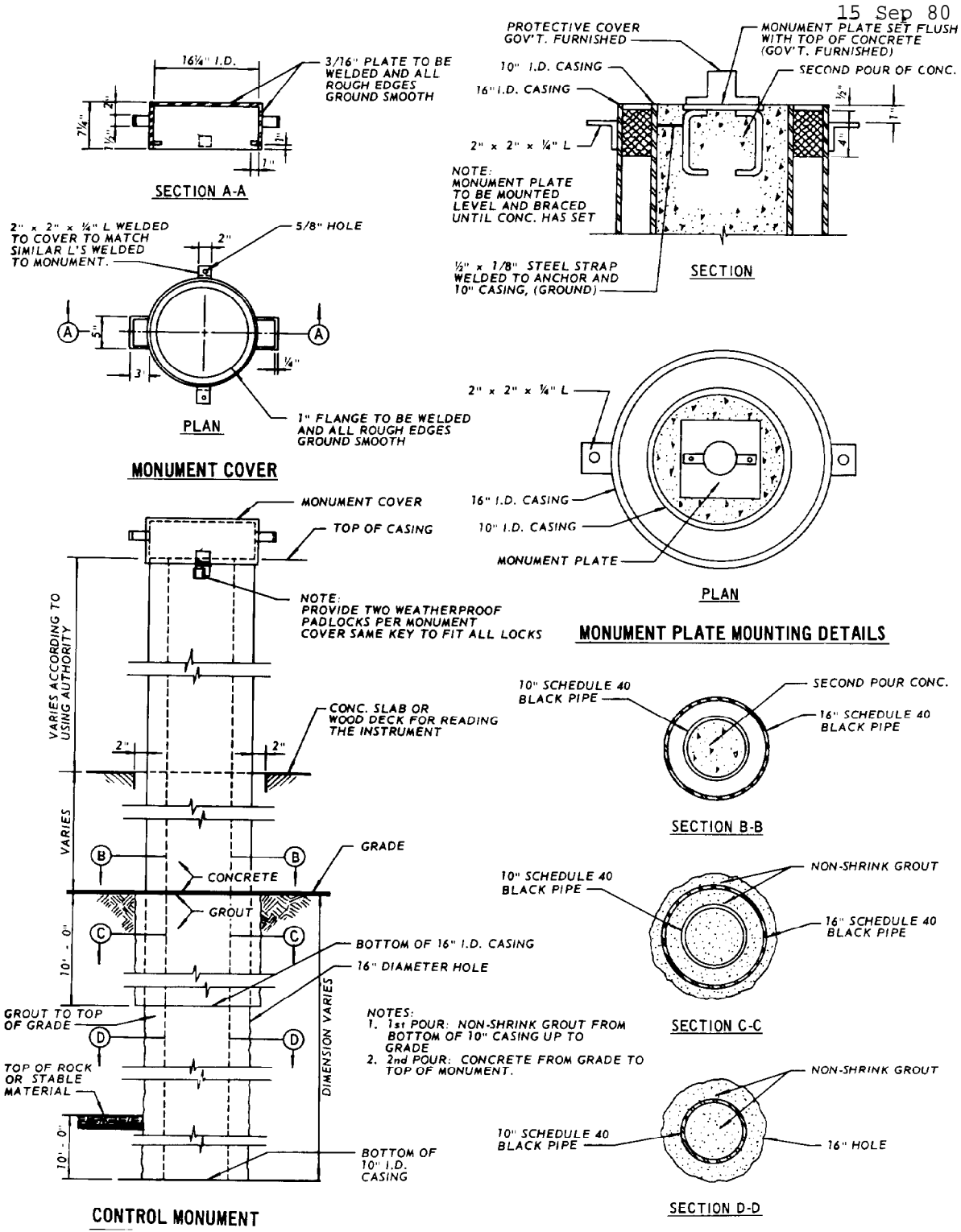

Figure 6-7. Typical Control Monument. (Prepared by CE-WES)

(4) A 6-in. thick concrete pad or wooden deck of sufficient area to provide a good platform on which the survey party can stand should be provided around the base of the monument. The pad should be free of the monument such that any movement of the pad will not affect the monument.

b. Monolith Alignment Markers. The marker points between the end reference monuments are 3/4-in. diameter brass plugs set in the concrete as shown in Figure 6-8. Two types of plugs have been used. One is solid and the initial point on the line is carefully punched or scratch marked in the top. The other type is drilled and tapped with a protective plug screwed in the top. Any markers located in traffic ways should be placed in a small recess in the concrete and protected by a cover. The target-micrometer device for the first type rests on the concrete surface or is tripod-mounted, and the device for the second type screws into the insert.

(1) An ordinary transit is centered over one end reference mark, sighted on the opposite end mark, and the locations of the intermediate monolith marker points spotted on or near this line of sight. The markers should be installed on the structure at the points that would be most likely to experience the greatest or most frequent movement. Consideration should be given to the reservoir water load, and season of the year, when locating the position of the marker plugs in order that subsequent deformations of the structure will not exceed the range or limit of movement of the target-micrometer device. In the case of a lock or dam the most logical location for the alignment markers would be at the high points along the lock or crest of the dam to monitor deflections due to changes in water elevation on the dam or the movement of the monoliths due to filling and emptying of the lock chamber.

(2) The installation should insure that the marker doesn't move with respect to the monolith that it is referencing. In new structures it can be installed at the time of casting the structure, and in older structures a hole in the structure should be drilled and grouted, and the marker set into the fresh grout.

c. Theodolite. The instrument should be set on the base plate of the reference monument, or if no reference monument is used, it should be mounted on a low rigid tripod so that the eyepiece is not more than about 2 ft above the reference marker to facilitate centering the instrument accurately over the marker. It is preferred that the instrument be equipped with an optical plummet for alignment over the marker, but a plumb line is considered accurate.

15 Sep 80

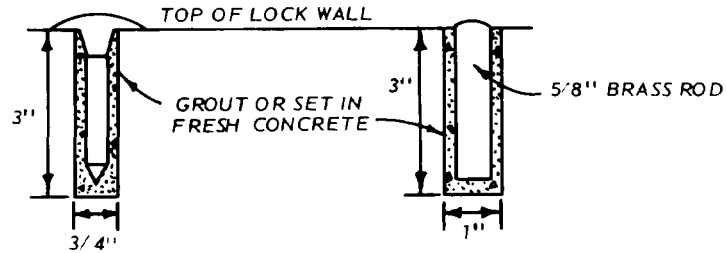

Figure 6-8. Monolith Alignment Markers. (Prepared by WES)

d. Fixed Target. The distant or fixed target is set and remains in the same position throughout each alignment survey as one end of the base line. The target is usually placed at the base line reference monument, but on some sites might be mounted on the extended base line in rock at a vertical abutment. The target should be internally lighted. Where an electrical outlet for operating a fixed lamp is not conveniently available, a battery powered lighting fixture of adequate intensity must be adapted to the target assembly.

e. Movable Targets. The movable target is set over the alignment points in the survey such that the target on the instrument lies in a plane perpendicular to the line-of-sight between the theodolite and the fixed target. This procedure is intended to insure that the target is set up the same each time it is read. The instrument is leveled by the use of the adjustment screws in the legs of the target shown in Figure 6-4, and if a target instrument similar to that shown in Figure 6-5 is used, the instrument is screwed into the alignment point. The alignment point must be installed in the monolith such that when inserted, the instrument will be level.

6-9. Data Collection

a. Observation Procedures. Readings shall be performed at night to avoid troublesome optical distortions due to sunlight and heat radiation. Under some circumstances the readings may take two nights to complete. Since it is recommended that readings be taken at night, the theodolite should have illuminating attachments to make reading the horizontal and vertical circles possible in darkness.

15 Sep 80

(1) The theodolite is sighted on the fixed target at the far end of the points to be aligned. This sighting is referred to as the line-of-sight. The movable target is placed over or screwed into a marker plug and moved to coincide with the line-of-sight. Four readings of the vernier calipers are obtained for each sighting, two by moving the target into the line-of-sight from the right and two from the left. Four additional readings are obtained when using a theodolite with the telescope in an inverted position. The target caliper readings at each marker plug are recorded on field data sheets, as shown in Plate 6-2. Obviously erroneous readings are discarded, and replaced by supplementary observations.

(2) A general rule should be established requiring the tripod legs to be placed consistently on either the upstream or downstream side of the monolith marker plugs and all sightings to be made from the same end monument so far as practicable in order to avoid error in establishing the direction of measured incremental movements.

b. Reading Schedule. A complete set of observations should be made twice annually, at nearly the same dates each year, one reading in the summer, the other during the winter season. In addition, a third set of observations should be made during periods of unusually high reservoir level. The initial observation should be made prior to the initial filling of the reservoir if possible, in order to record the effect of the first water load against the structure. After three years' records have been obtained, the results should be examined to determine the necessity or desirability of continuing or altering the program.

c. Supplementary Data. A continuous record of reservoir and tailwater elevations will be required. Average monthly air temperatures, preferably from a U. S. Weather Bureau or Corps of Engineers station, frequently will be found valuable in evaluating the precise alignment data or in accounting for possible discrepancies in the results.

6-10. Data Reduction.

a. Field Data Sheets. The eight target caliper readings at each monolith marker plug are recorded on field data sheets for each set of observations. The arithmetic average of the eight values at each plug is computed and entered directly on the field sheet.

b. Processing of Data. Since the true shape of the deflected structure at any given time is rarely known, it is customary to consider the initial measured position as being a straight line. The initial reading values are assumed to be zero, and the incremental changes in alignment are computed by simply subtracting subsequent readings from the initial readings for each monolith marker. A tabular record form is ideally suited for the processing and presentation of the collected data.

15 Sep 80

c. Presentation of Results. The data reduction procedure, while entirely valid arithmetically, frequently produces apparent deformations that are misleading as to the deflected position of the structure, depending upon the conditions at the time of the initial observations. When the initial survey is made during the coldest of the winter months, most if not all subsequent readings will indicate deflections in an upstream direction. Conversely, an initial survey during a hot summer month will result in downstream deflections during all other times of the year. If the reservoir elevation is comparatively high at the time of the initial survey, subsequent observations during similar seasons with lower reservoir elevations will indicate an upstream deformation. Finally, the initial survey is usually made after the concrete structure has lost some of its heat of hydration but prior to the attainment of final stable temperature conditions; thus the movements observed include only a portion of the permanent temperature readjustment effects. After several surveys have been obtained it may be possible to arrange the results so as to present a more realistic or logical movement history by selecting one of the intermediate surveys to represent the initial or zero condition, and all other deformation readings referred to this base position. A graphical schematic diagram, as shown in Plate 6-3, should be prepared to present the collected precise alignment data. Results of several surveys may be shown on a single sheet.

6-11. Precise Leveling.

a. Description of the Instrument. The level should be of the type designed for accurate geodetic leveling capable of reading vertical elevations to 0.001 m similar to the Wild N-3 level. It should contain a reticle with stadia hairs of 1:100, conventional or split-bubble leveling device, and tripod leveling screws. Object magnification should be greater than 30x for easy readability at long distances.

b. Rod. The level rod should have gradations of 0.01 ft and a micrometer target for readings to 0.001 ft or 1 mm. The rod should be equipped with a centering point that can be attached to its base such that the alignment markers inserted in the top face of locks and dams can also be used for settlement purposes. Care should be taken so that the centering point does not make the level rod readings inaccurate. A bubble level is also required to aid in keeping the rod vertical.

c. Reading Markers. The location of permanent bench markers should be established during design, and survey markers should be located on the structure. These survey markers can coincide with monolith alignment markers.

6-12. Data Collection. Surveys should be performed annually to determine movement of the structure. The first survey elevations should be established as the base elevations. Subsequent surveys should be recorded and compared to the base elevations for overall movement, and to the previous survey for relative movement of the structure.

6-13. Data Reduction. The results of each survey can be reduced to a graphical plot of settlement versus location of data point on the structure by considering the initial survey elevations to be a zero line and plotting the difference between the subsequent surveys and the original survey, as shown in Figure 6-9. An alternate method to record successive surveys is to compute the difference between successive surveys and plot this difference relative to the displacement of the previous survey.

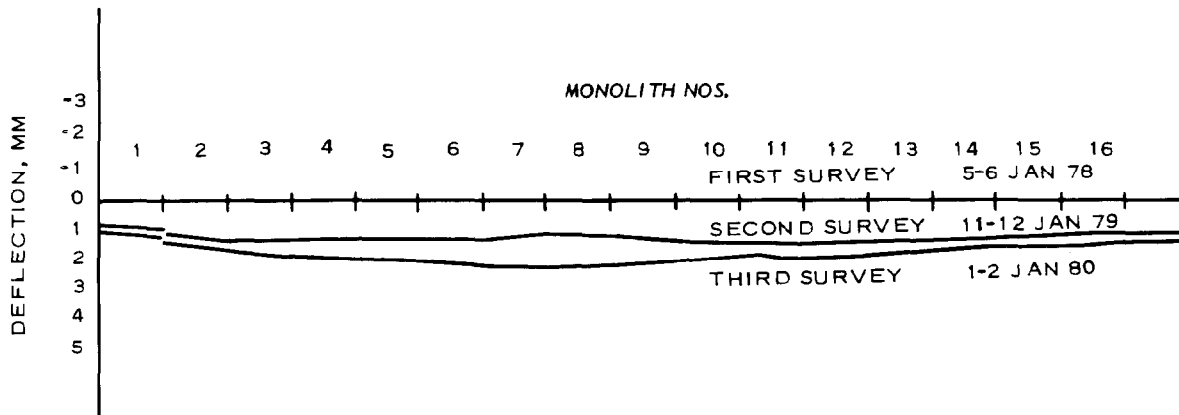

Figure 6-9. Deflection History of Precise Level Survey.
(Prepared by WES)

Section III. Precise Distance Measuring Instruments

6-14. Electronic Distance Measurement (EDM) Instruments.

a. Description of the Instrument. EDM's consist of a source instrument, which is also the readout portion of the instrument, a reflector prism assembly, and reference monuments.

b. EDM Source. All modern EDM instruments measure distance by timing, in an indirect fashion, how long it takes light to travel from a source to a reflector and back. By knowing the velocity of light, the distance from the source to the reflector may be calculated. This method of measurement can be used to increase accuracy and decrease time consumption in measurement when compared to the old-fashioned method of taping distances. Depending upon the instrument, resolutions as fine as 0.001 ft can be made by this method of measurement; however, precise frequencies used to modulate the light source and phase comparisons introduce errors into the measurement that need to be compensated.

c. Range. The source instruments should have a range of at least 2 miles and provide least readings of 0.001 m. They should be lightweight for movement around control networks and capable of working from a 12-v battery source for at least 4 hr of normal use without recharge. They should be installed either on the base plate of the reference monuments or set up on tripods and plumbed or optically plumbed to the monument.

d. EDM Prisms. These prisms are used at the alignment marker or reference monument to return the light source to the EDM. Various makes are available; it is recommended that prisms manufactured by the maker of the EDM equipment be used to be compatible with the reading instrument. Figure 6-10 shows some typical prism configurations. Due to the spread of light being proportional to the distance from the light source, the longer the distance being measured the greater number of prisms that are required to reflect the light.

e. Reference Monuments. The reference monuments used are the same as described in paragraphs 6-7c and 6-8a.

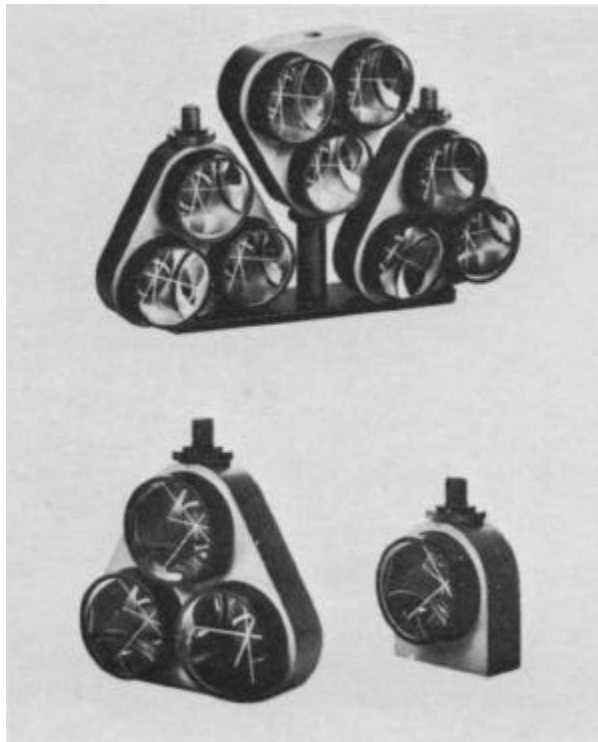

Figure 6-10. EDM Prism Assemblies.(Photo by WES)

6-15. Instrument Installation. The EDM instrument and reflector are set up on the reference markers between which the desired distance is to be measured. Both the instrument and reflector are plumbed over their respective markers and a raw distance is read from the EDM instrument. The path between instrument and reflector should be chosen such that the atmospheric conditions along the length to be measured are the same. If this cannot be accomplished, then the temperature and pressure should be recorded at both the instrument and the reflector and the temperature and pressure information recorded as the average.

6-16. Data Collection. The EDM instrument should be read at least five times and each value of the distance recorded for every measurement from source to reflector. This is done in order to get a good average for the raw reading. The reading of the instrument should be done in accordance with the manufacturer's recommendations. A typical data sheet for one measurement is shown in Figure 6-11.

15 Sep 80

Date	②	El.	②	El.	Page	of
1	No. _____ Time _____		1	No. _____ Time _____		
2	Sta. _____ El. _____		2	Sta. _____ El. _____		
3	HI _____		3	HI _____		
4			4			
5			5			
6	Sta. _____ El. _____		6	Sta. _____ El. _____		
7	HI _____		7	HI _____		
8			8			
9	D _{obs.} → <input type="text"/>		9	D _{obs.} → <input type="text"/>		
10			10			
M	Temp. _____		M	Temp. _____		
Corr	Press. _____		Corr	Press. _____		
D _s	D _{corr.} → <input type="text"/>		D _s	D _{corr.} → <input type="text"/>		

Figure 6-11. Field Data Sheet for EDM Instrument. (Prepared by WES)

6-17. Data Reduction. The mean of the five raw readings is recorded on the line marked M in Figure 6-11. Each reflector has a correction factor that must be applied to the mean of the raw readings to take into account the errors that are due to the reflection of the light wave and the condition that arises when the reflector prism is not directly over the plumbed monument. This correction is either added to or subtracted from the mean to give D_s . The corrected mean distance is then corrected to the spheroid distance D_{obs} and finally D_{obs} is corrected for temperature and pressure to D_{corr} . Throughout the calculations the station and elevation of the monuments for both the EDM instrument and the reflecting prisms should be kept as well as the height of the instruments and the temperature and pressure at the time of the readings .

Section IV. Triangulation and Trilateration

6-18. Triangulation.

a. General. The face of massive concrete structures such as arch dams is in continuous motion since it undergoes movement as a combined action of temperature fluctuations in the external medium, hydrostatic pressure, and other fluctuating loads. By measuring the changes of coordinate location of each deflection point on the dam, a displacement pattern at each point in each horizontal line of points and each vertical line of points will be determined. A triangulation system consists of a grid pattern of a number of points or targets on the downstream face of the structure and on the foundations along the abutments. The target locations will be charted periodically by observations from a system of theodolite piers downstream of the structure using precise first-order triangulation surveying methods.

b. Description of the Instrument. The equipment necessary to perform a first-order triangulation survey consists of a theodolite of sufficient accuracy with auxiliary equipment from the theodolite manufacturer, reference monuments and deflection targets, and either precise taping equipment or electronic distance measuring equipment,

(1) The description of the theodolite has been previously given in paragraph 6-7a and the description of the Electronic Distance Measuring Equipment in paragraphs 6-14a and b.

(2) The reference monuments and deflection targets should be installed by the contractor during construction. The monuments should be 16 in. in diameter concentrically located, concrete filled metal pipes, and grouted into the foundation rock or stable soil. Access to monument location and suitable platforms should be constructed at monument locations. A brass plate of dimensions compatible with the instrument should be mounted onto the top of the monument to support the theodolite or EDM. Provisions should be made for covering the base plate for protection against weather or accidental damage. Details of these plates are available from theodolite manufacturers. The targets should be installed at specified locations by the contractor. The selection and details of theodolite targets are a design consideration based on site layout from the piers. Field trials and observations of various type targets should be accomplished during design.

6-19. Instrument Installation.

a. Monuments. The theodolite monuments should be located so that a network of quadralaterals is established. These monuments are located on the structure and downstream from the structure. In locating and installing them, care should be taken to insure that

- (1) each monument is visible from every other monument.
- (2) they are located at the same elevation.
- (3) they are accessible or made easily accessible.
- (4) they are visible to every target on the structure.

b. Targets. The targets shall be arranged at equally spaced distances along the top of the structure. If a vertical alignment is to be performed, the targets should also be placed along the downstream face of the structure in horizontal rows at the selected elevations where measurements are to be taken.

6-20. Data Collection.

a. Performing Surveys. Surveys shall be performed at night to avoid troublesome optical distortions due to sunlight and heat radiation. The surveys shall be in accordance with the accuracy with methods established for first-order triangulation measurements as stipulated by the U.S. Coast and Geodetic Survey.

b. Measurements. Before starting a triangulation survey, the distances and angles between the primary and secondary reference monuments should be measured to check for any movement of the primary monuments. If any movement has occurred, then the primary monuments must be restored to their position prior to the movement by using the distance and angle between primary and secondary monuments of the previous survey as a reference.

c. Base Lines. Measurement of the base line can be performed either through the use of a high precision metal tape or through the use of an EDM instrument. The procedures for measurement using an EDM should be the same as those described in paragraphs 6-14 through 6-17.

(1) The measurement of the distance between the primary reference monuments at each end of the base line should be made first. The distance should be measured at least two times and the average used as the base length. Temperatures should be taken along the base line to determine the length correction when using an invar tape. The best time to conduct a survey is either at night when atmospheric distortion is not a problem or on overcast days when temperatures are fairly constant across large expanses of the terrain to be measured. If an EDM is used, both pressure and temperature readings should be taken at least at both primary reference monuments.

(2) Angles should be measured from the primary reference monument at each end of the base line to all monuments and targets in the survey. All angles should be measured at least eight times and the average used for computation purposes. Elevations should be obtained on each survey point and secondary reference monument with the primary reference monuments serving as permanent bench marks.

6-21. Data Reduction. All raw distances and angles should be recorded on field data sheets as well as the averages of these figures. Temperatures, pressures, time and date of the survey should also be included on the field data sheet.

a. Computations. All computations of data should be made by automatic data processing methods. The data should be expressed in terms of the coordinates of each target and monument as calculated from the geometric properties of the triangle. The displacements of the targets are calculated by comparison of the coordinates of the targets of successive surveys.

b. Data Representation. The displacements can be graphically represented in a manner similar to that used in Figure 6-12. By referencing all displacements to an original profile, a continued record of the shape of the structure can be maintained.

c. References. Additional information on triangulation systems are referenced in the bibliography.

6-22. Trilateration.

a. General. The most recent trend in precise measurement surveys used by the Corps of Engineers is trilateration. Since the development of EDM equipment has made distance measurement both rapid and very accurate, measurement of monument location by the determination of the lengths of the sides of a triangle has become both economical and precise.

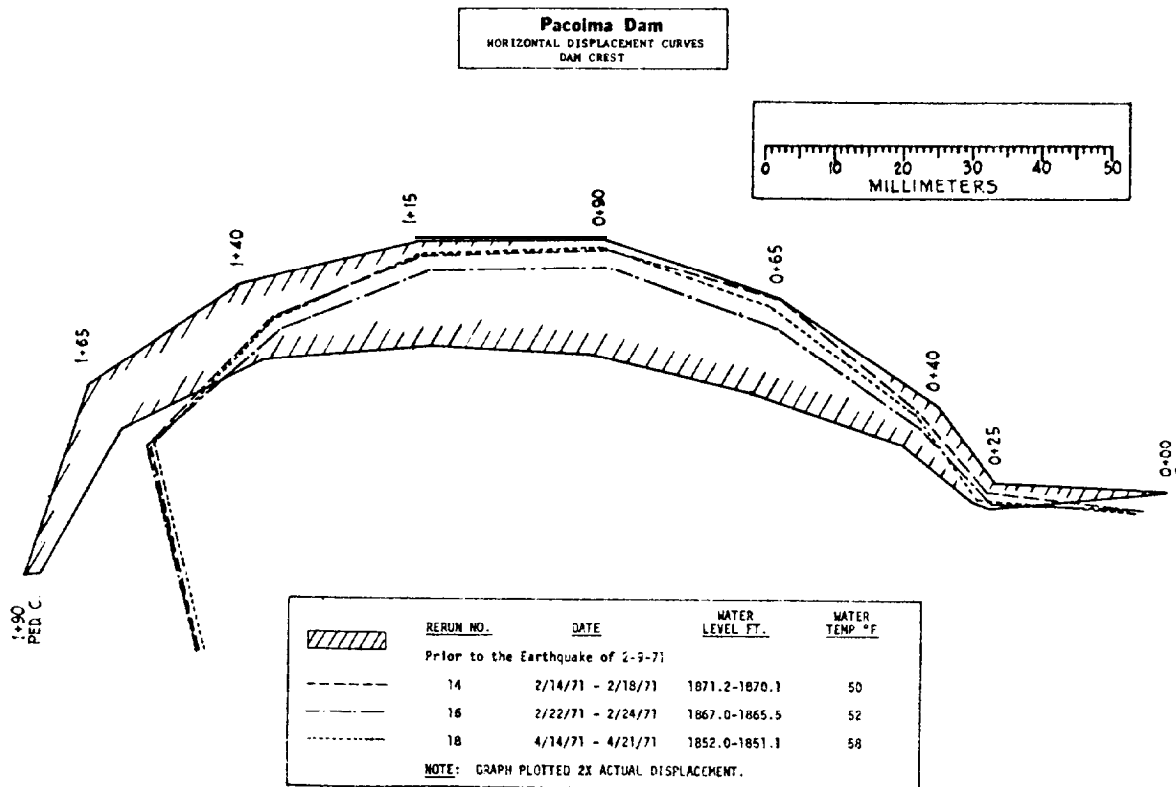

Figure 6-12. Graphic Plot of Horizontal Displacement of Dam Crest.
(Prepared by CE-WES)

b. Sources of Error. Due to the preciseness of the method of measurement, sources of errors that are normally ignored in a conventional survey become major areas of inaccuracies in trilateration, and must be removed. Errors caused by changes in elevation of the line of sight, changes in pressure at different instrument locations, atmospheric refraction, and length changes due to earth curvature must be corrected before a final "corrected distance" can be recorded.

6-23. Description of the Instrument.

a. Method. The method of precise measurement of large structure movement consists of measurements in two areas. The first area is a control network of reference monuments from which all the alignment measurements are to be made and where a control length is established. The second area is the alignment markers that are to be measured for movement.

b. Control Network. The control network is set up as a stable reference from which to make measurements of movement on the structure. Since it is designed to be a static reference, the location of the monuments must be placed on stable ground a distance away from the structure sufficient to insure that the monuments will not be influenced by the forces which cause displacement of the structure. There must be at least two control monuments from which to sight on the alignment markers in order to determine their location. By using three or more control monuments additional sightings can be made on each alignment marker as an accuracy check of its location. If two dimensional movement of the structure is required, the angle of intersection of the control monuments with respect to the alignment markers should be at approximately a 90 degree angle to each other. A monument such as that shown in Figure 6-7 may be used.

c. Alignment Markers. The second portion of the trilateration network is the alignment markers. These points are the locations that are of interest for their movement. They are sighted from the control network and through comparison with the coordinates of previous sightings on these markers they describe the movement of the marker and consequently of the structure. They can be used to measure deflection, expansion, relative crack movement or rotation of a structure. Alignment markers similar to those shown in Figure 6-8 may be used.

d. Distance Measuring Equipment. The distance measuring equipment (EDM) required for the distance measurement consists of any one of the available EDM's on the market and their associated peripheral equipment. The minimum equipment necessary to determine the distance between monuments is an EDM meter, tripod, reflecting prism, and prism stand. The description of these instruments and their operation is contained under the Electronic Distance Measurement section of this manual, paragraphs 6-14 through 6-17.

15 Sep 80

6-24. Data Collection.

a. Initial Reading. The initial reading of the control network should be done to determine the locations of all the control monuments in the network and to assign to them a set of x and y coordinates in a chosen coordinate system. An EDM is set over each control monument, plumbed to the monument, and sighted on every other control monument in the network. The EDM is read when sighted on each monument and again read when resighted on the first monument sighted. The reason for resighting to the first monument is to account for any electrical drift in the EDM or changes in atmospheric conditions during the time it takes to read the network. It is a good practice to use the same control monument for the resighting as often as is possible to give a good mean distance for reference. A minimum of five measurements should be taken between each pair of monuments such that the average of the five readings can be taken as the observed distance between monuments. It is also important to measure both the temperature and atmospheric pressure at each end of each line that is measured. With the temperature and pressure known, any changes in the velocity of the light waves through the air can be determined. This process is continued until all monuments of the control network have been occupied by the EDM and sightings made to the rest of the monuments.

b. Measurement Corrections. When all the control monuments have been occupied and all the possible lines measured, the figure may be reduced to a series of triangles. Before the angles can be calculated, each line must be reduced to a chord distance on the spheroid. This reduction is necessary to apply geometric checks to figures or to calculated positions from several sets of data that agree with each other. With the measurement of all the monuments corrected and recorded, adjustments to the corrected spheroid distance can be made to account for changes in atmospheric conditions or electrical drift of the EDM.

c. Reference. The method of reading a trilateration network is a highly precise process that will yield very accurate measurement of monolith movement. For further and more detailed information on the method of operation of Electronic Distance Measuring Instruments and the procedures to conduct a trilateration survey, the reader is referred to U.S. Army Engineer Topographic Laboratories Manual ETL-0048, "The Use and Calibration of Distance Measuring Equipment for Precise Measurement of Dams," available from Engineer Topographic Laboratories, Fort Belvoir, VA 22060.

15 Sep 80

6-25. Data Reduction. With all the data collected, the distances are used to establish a coordinate system in which each reference monument, and alignment marker is assigned a coordinate. The coordinates are established by using conventional trigonometric relationships. By comparing the coordinates of each successive survey, differences in the location of the points establish the movement of the structure.

a. This method of small measurement movement has become one of the most accurate methods of surveys available. The accuracy and ability of the survey method depends upon the capabilities of the EDM used. Three instruments that have been tested by the Government and provide the high capabilities necessary for this type of survey are the Keuffel and Esser Ranger IV, the Tellurometer MA100, and the Hewlett Packard HP3808.

6-31

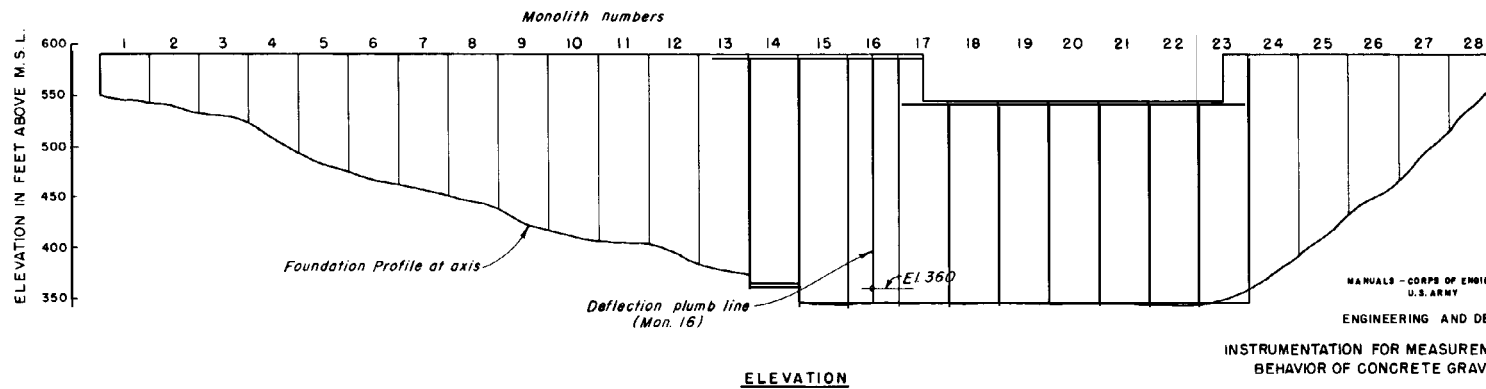
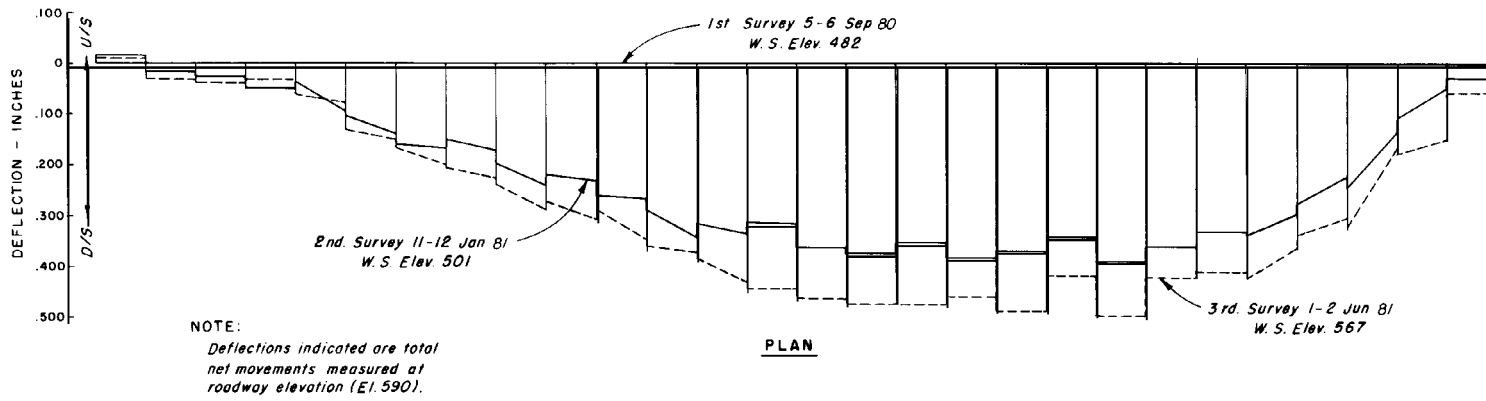

MANUALS - CORPS OF ENGINEERS
U.S. ARMY
ENGINEERING AND DESIGN
INSTRUMENTATION FOR MEASUREMENT OF STRUCTURAL
BEHAVIOR OF CONCRETE GRAVITY STRUCTURES
PRECISE ALIGNMENT HISTORY
EM1110-2-4300 (Prepared by CE-WES)

Plate 6-3

EM 1110-2-4300
15 Sep 80

CHAPTER 7

TEMPERATURE MEASUREMENTS

7-1. General. The resistance thermometer and thermocouple are types of instruments that will measure temperature in concrete. In mass concrete, temperature changes are the primary causes of volume change and stress. The temperature rise within the concrete causes an outward expansion during the early life of the concrete. The temperature of the internal mass is higher than that of the exposed surfaces. Thus, as the outer surface cools and tends to shrink, compressive stresses develop internally, and tensile stresses externally. In order to determine the effect of temperature on the stress and volume change, temperatures may be measured at a number of points within the structure, as well as at the boundaries. However, it is not necessary to determine the detailed temperature history of every portion of the structure. It is considered sufficient to select those portions which are typical and those which are most severe. Design temperature histories will give information on these locations. Thermocouples are suitable for measuring temperature under certain conditions and at several locations. However, resistance thermometers are preferred over thermocouples because they have been found to be more dependable, of greater precision and less complicated in their operation. One type of layout would be to place a thermometer every 50 ft in cross section and elevation in a monolith of a large massive structure. For a small structure, a finer spacing may be desirable. A few thermometers should be placed near and in the dam faces to evaluate the daily and weekly fluctuations in temperature. Another layout commonly used is in selected lines of thermometers parallel and transverse to the dam axis, and in a vertical direction. The spacing of the instruments may be very close at exposed faces, and quite wide in the more uniform temperature interior. Lines near or crossing construction joints usually have instruments close to the joint because of the effect of new concrete placed against the older.

7-2. Temperature Measuring Devices.

a. Resistance Thermometer. The resistance thermometer, a Carlson type instrument described in detail in paragraph 2-7, consists of a non-inductively-wound coil of enameled copper wire enclosed in a brass case. The thermometer is provided with 30 in. of three-conductor, rubber-covered cable. Two conductors are connected to one end of the coil, and one to the other end. This three-conductor arrangement eliminates the effect of total resistance and resistance changes in the conductor leads when used with a Carlson testing set. This is accomplished by having one conductor in each of two arms of a Wheatstone bridge, such that they cancel one another. The resistance of the thermometer is 39.00 ohms at 0° F increasing exactly 0.10 ohm per degree Fahrenheit.

15 Sep 80

b. Thermocouples. When two dissimilar metal wires are joined together, a small d-c voltage is developed in this electrical circuit at each junction. Since the two voltages are opposite and direct, the net voltage is proportional to the temperature difference between the junctions. By placing a potentiometer in the circuit and measuring the net voltage, the temperature difference is found. Insulated thermocouple wire is available commercially in many combinations of metals, gages, and insulation types. Either copper-constantan or iron-constantan wire pairs are suitable for measuring concrete temperatures. Adequate sensitivity and sufficient strength and flexibility are secured with AWG 16 or 18 size wire. Conductor insulation and sheath for cable must be rubber or polyvinyl plastic. The special protective metallic or ceramic tubes used to house thermocouple elements are not considered necessary.

7-3. Installation. The thermometer or thermocouples may be installed by the contractor. Sufficient details should be shown on the contract drawings and adequate specifications provided to obtain required installation. Thermometers or thermocouples on a single horizontal plane within a lift is most easily done by placing them at the bottom of the lift. An adequate length of three-wire, rubber-insulated, rubber-covered stranded copper wire cable has to be attached from resistance thermometer location to the terminal board location. The thermometer or thermocouple should be taped or tied to the previous lift at the proper location. Thermometers located within about 3 ft of exposed concrete surfaces or bulkhead faces subject to daily temperature variations must be placed accurately at their intended distance from the surface or face. Thermometers or thermocouples in a vertical plane in a lift should be taped to a pole which is embedded in the previous lift. Wooden or plastic poles approximately 1/2-in. diameter should be used. Metal poles and reinforcing bars should not be used. Identification tags attached to the cable should be used to accurately identify thermocouple or thermometer. Special installation is required for a thermocouple that is not required for resistance thermometers. A clear distance of at least 1 ft should be maintained between thermocouples. Extension cable from the thermocouple location to the terminal board must be kept at least 1 ft away from an a-c line. Also a closed cabinet and interior heating should be provided at all reading stations.

7-4. Collection of Data. The resistance thermometer or thermocouple is read with a potentiometer. There are commercially available portable, semiautomatic and automatic types. The selection of the type should be based on the number of instruments that are to be read. The initial readings should be taken 1 to 3 hr after installation, then two or three readings at 12-hr intervals thereafter, then daily for the next 20 days, twice weekly for the next month, once weekly for the remainder of the construction period, and every other week during operation of the project. Readings may be discontinued when three years of final stable temperatures or annual cycle of temperature are obtained.

15 Sep 80

7-5. Processing of Data. Copies of readings should be maintained and temperature histories performed by the Engineering Division, except during construction of the project they may be maintained by construction personnel with copies of data supplied to the Engineering Division.

CHAPTER 8

SEISMIC INSTRUMENTATION

8-1. Introduction. The failure of a concrete dam or intake tower when subjected to an earthquake could have serious consequences. Although earthquake forces are considered in the design of structures, data obtained from instrumentation during earthquakes have indicated significantly different results when compared to those anticipated in design. Instrumentation should be installed in regions of significant seismic activity to measure ground motion, hydrodynamic water pressures, and response of concrete dams and intake towers 100 ft or more in height. Also, seismic instrumentation may be desired at other locations where the structure and seismic activity are unusual. Each project should be instrumented to suit the particular structure, geologic and seismic condition. Reference is made to EM 1110-2-1908, Part 2, dated November 1976, which describes instruments, techniques, and methods of analysis used to monitor seismic activity. The chapter written here is intended for informational purposes only.

8-2. Description.

a. Types. Instruments used to obtain a seismic data are strong-motion accelerometers, peak recording accelerometers, hydrodynamic pressure gages, and seismoscopes.

b. Strong-Motion Accelerometers. These instruments contain accelerometers which measure the acceleration of a mass due to strong, quick motions. They generally contain three accelerometers oriented orthogonally which are activated under forces of 0.5 or 1.0 g's by a pendulum device.

c. Peak Recording Accelerometers. The inexpensive peak recording accelerometer detects and records peak amplitudes of low-frequency accelerations and is used to supplement data obtained from conventional accelerometers. The peak acceleration is recorded by erasure of prerecorded units on 1/4-in. magnetic tape with a total error bank of + 5 percent. The device is available with sensitivities varying from 0.1 to 10 g.

d. Hydrodynamic Pressure Gages. These gages measure the increase in water pressure when subjected to additional inertial forces of liquids associated with earth motion. Instruments consist of a Carlson type strain meter, with recording device activated by an accelerometer.

e. Seismoscopes. The seismoscope is an inexpensive device that indicates the occurrence of an earthquake but does not write a time record of the forces associated with it. The instrument consists of a free conical pendulum that can move in any horizontal direction to record the response of a single-degree-of-freedom system of prescribed period and damping to the earthquake ground motion. It records direction of motion and indicates relative intensity. Installation of seismoscopes in new projects is not recommended. It has been observed in the past that the information obtained from these instruments has been difficult to interpret and thus not of significant value. Policy on seismoscopes should be to maintain any such instruments that are already installed, but not to install new ones.

8-3. Design Considerations. The instruments mentioned in paragraph 8-2 should be installed in all concrete dams and intake towers over 100-ft high in seismic Zones 2, 3, and 4 shown on the seismic zone map in ER 1110-2-1806. The seismic instruments should be procured and installed by the Government. The instruments selected should be based on the type of structure and its seismic zone. Concrete dams over 200 ft in height in Zones 3 and 4 should be instrumented with four strong-motion accelerometers; and since the actual accelerations during earthquakes may exceed the accelerometer ranges, particularly in Zones 3 and 4, peak recording accelerometers should be provided to supplement the strong motion accelerometers. Concrete dams between 100 and 200 ft in height in Zones 3 and 4 and over 100 ft in height in Zone 2 west of longitude 106°W, should be instrumented with three strong-motion accelerometers supplemented by peak reading accelerometers. In dams with three or more strong-motion accelerometers, one should be located on top of one of the higher dam monoliths, one in the upstream gallery near the base of the same monolith, and one of the bedrock foundation at a distance downstream of the toe of about three times the dam height. For the larger structures (about 200 ft or over in height), or where foundation conditions warrant, a fourth accelerometer should be located at about mid-height of the principal instrumented monolith or elsewhere on the structure. Concrete dams over 100 ft in height in Zone 2 east of longitude 106°W require only one strong-motion accelerometer. Intake towers over 100 ft in height in Zone 2 west of longitude 106°W require two strong-motion accelerometers with those in Zones 3 and 4 supplemented by peak recording accelerometers. The strong-motion accelerometers should have a maximum operating range of 0.5 g except those installed near the crest of concrete dams over 300 ft high; they should have a maximum operating range of 1.0 g. Strong-motion triaxial accelerometers similar to Model SMA-I manufactured by Kinemetrics, Inc., 336 Agostino Road, San Gabriel, CA 91776, or Model RFT 350 manufactured by Terra Technology, Inc., 3860 148th Avenue N.E., Redmond, Washington 98052, are suitable instruments. Peak recording accelerometers should be similar to Model PRA-100 manufactured by Terra Technology, Inc. *

8-4. Hydrodynamic Pressure Measurement Considerations. At dams and intake towers over 300-ft high in Zones 3 and 4, and Zone 2 west of longitude 106°W hydrodynamic pressure gages should be installed to measure the increased pressure of the reservoir water during earthquake occurrences. The gages should be placed in a vertical line on the upstream face of the dam spaced approximately 75 ft apart. On intake towers, they should also be placed in

vertical lines spaced approximately 75 ft apart, but be installed on two orthogonal faces of the tower. Proposed seismic instrumentation should be submitted by Design Memorandum for review and approval.

8-5. Installation and Maintenance. Instruments mounted in the galleries are subjected to high humidity atmospheres, consequently if not protected, they will only realize a short life span due to corrosion. When instruments are specified in galleries, environmental protection, special housings, heaters to keep the instrument and housing dry, and a source of AC power should also be specified. In the past it has been standard procedure to electronically link seismic instruments together to insure that they would all function at the moment of a seismic event. However, it was found that electrical malfunctions, when there was no seismic event, were tripping all the recorders and wasting the recording paper. More recently it has been recommended that recorders not be linked together, but instead to install triggering devices in each instrument to alleviate the problem of accidental triggering of all instruments. Seismic instrumentation should be installed by personnel familiar with its installation. The services of the USGS and WES are available for seismic installation. The equipment should be periodically maintained as required by the manufacturer's instructions.

8-6. Processing of Data. The U.S. Army Engineer Waterways Experiment Station (WES) is assigned the responsibility for analyzing and interpreting the, instrumental data. A report should be sent to USAEWES, Attn: Geotechnical Laboratory, for each project having seismic instrumentation whenever a recordable earthquake occurs. The report on each project should include a complete description of the locations and types of the instruments and a copy of the instrumental records as outlined in ER 1110-2-1802, Reporting Earthquake Effects.

CHAPTER 9

INSTRUMENTATION AUTOMATION TECHNIQUES

Section I. Introduction

9-1. Introduction. Instrumentation automation is increasingly becoming a valuable means of collecting instrument data for several reasons. Primarily, some tasks that are traditionally done by instrumentation personnel are better accomplished by machines, for the fact that the machine will take measurements in the same manner at each reading, whereas human error can cause minor variations in reading and interpreting data. Automation permits a greater volume of data to be collected in a given period of time. Where an instrumentation reading party may take 4 to 6 hours to read a set of plumblines, the same readings can be taken in less than 10 minutes when collected by automated plumblineline monitoring equipment. The cost of instrumentation and computers to monitor these instruments has decreased drastically within the past five years. It is now more economical, in terms of overall cost, to automate the reading of certain types of instrumentation than to continue reading them by manual methods.

9-2. Scope. This chapter describes the steps necessary for implementing automated instrumentation monitoring systems suitable for use in or at large concrete structures. It covers the sensor selection, data transmission, data conversion, data manipulation, data display, and data storage. The definition of system requirements, and a sample "Systems Requirements Document" to serve as a guideline in specifying the system's functional requirements, are also presented. This chapter discusses key factors that must be considered as the system develops. System considerations in determining measurement techniques, component compatibility, system characteristics, interfacing techniques, power sources, grounding techniques, maintainability, operability, system calibration, system flexibility, sensor selection criteria, transducer hazards, signal conditioning techniques, data transfer, data processing, data display, and recording and storage techniques are covered. The information presented in this chapter is condensed from a more detailed report entitled "Instrumentation Automation Techniques". That report is one of three reports on instrumentation automation for concrete structures published under the Repair, Evaluation, Maintenance, and Rehabilitation (REMR) Program.

Section II. System Requirements Document

9-3. Defining the Objectives. A logical approach to specifying operating requirements for any data collection and reduction system is to first define the broad objectives of that system. Answering several simple questions will assist in identifying these objectives:

- o What information is needed?
- o How often does the information need updating?
- o In what form does the information need to be presented?
- o What is the relative economic value of the information?

By defining the scope of the information needs, an engineer may begin the task of specifying the general requirements of an instrumentation system to satisfy those needs.

All system operating requirements may be broadly categorized into two types: 1)functional and 2)environmental. Functional requirements include system operating parameters that are related to or influenced by functions of hardware and software. Environmental requirements include all systems operating parameters that are influenced by external conditions, such as the natural and induced physical environment, and spatial distribution/constraints related to system installation.

b. The proper vehicle for describing the scope of the system needs is the system requirements document. This is a document that serves as a guideline in determining the system functional and environmental requirements. In it, the needs of the system are documented. The phenomena to be measured is defined and quantified, and each component of the system to be designed is analyzed to be certain that its requirements are fully defined and documented. A sample of a requirements document is presented in Appendix D.

9-4. Functional Requirements.

a. Defining the Measurement. The process of breaking-down the physical phenomena to be measured into their fundamental quantities of length, time, mass, and temperature enables the engineer to better define the best type of measuring component (transducer) for the instrument system. In other words, the engineer should explicitly define and examine the non-electrical quantities that must be converted to usable electrical signals. Ultimately, these electrical signals must reliably and-accurately represent the value of physical quantities being measured. *

* b. Defining the Level of Need.

(1) Sample Rate and Frequency of Interest. An automated electronic data collection, processing, and storage system performs these functions at high throughput rates and can compile enormous amounts of information. The engineer must determine the frequency at which any given parameter must be measured, processed, and recorded. Typically, data are collected on a predetermined time schedule, or when a predetermined setpoint has been exceeded.

(2) The use of programmable, microprocessor-based data acquisition systems (DAS) and test equipment provides the user with flexibility to easily modify measurement rates (sample and process speed) with software, and expand data storage capacity (memory or magnetic disk). System process speed is not a critical consideration for accurate measurements of relatively slow changing quantities, such as temperature, deformation and strain. However, if an accurate time history of rapidly changing phenomena (active seismic data) is required, the system sample and process rate becomes critical. Generally speaking, the sampling frequency and system response should be an order of magnitude greater than the maximum data frequency expected to be recovered by the system.

c. Signal Distribution and Acquisition.

(1) Distribution and acquisition of electronic signals from numerous sensors and instruments require one of two primary approaches for system architecture. A centralized system is generally recommended if the application is small, with signal sources close together. However, larger applications, where instruments are geographically dispersed (typical of large dams), may require remote processing or distributed intelligence in the data acquisition system architecture. Wiring costs can be a large factor in determining the proper type of system.

(2) In a centralized DAS, all signal processing takes place in or next to the computer chassis with field wiring and cabling providing the signal link from sensors to processor. A centralized architecture keeps the amount of software needed to a minimum. However, wiring and cabling may be expensive and prohibitive unless all sensors are relatively near the computer, and if the central unit fails, or is down for maintenance/program modification, the whole system is inoperative.

(3) For environments too harsh for a computer, or where applications are physically spread out, a distributed architecture is recommended. The two types of systems in this category are those with remote front ends, and those with distributed intelligence. These systems reduce wiring costs by "

- * **processing the signal close to the sensor**, and transmitting the results to the central unit over less expensive wire. Added costs from these systems come from the remote processors.

d. Reliability and Criticality. System reliability in automated electronic instrumentation is influenced by five primary factors. The level to which each is implemented influences overall cost and must be considered in establishing this requirement. They are as follows:

(1) State-of-the-Art Equipment. As a general rule, use of more recently developed instrumentation increases system reliability, and generally reduces the total cost of data over the life of the system.

(2) System Complexity. As the number of subsystems increases, instrumentation system reliability generally decreases. Consequently, simplicity or minimal complexity is recommended in design and integration.

(3) Environmental Conditions. System reliability generally decreases with increased severity of environmental conditions to which the components are exposed. Subsystems involving critical measurements should be environmentally protected wherever possible.

(4) Operating Time. All active components have a limited operating life. Reduction of continuous operating requirements to intermittent or cyclic functions generally extends the life of subsystem components.

(5) Preventive Maintenance. Proper and periodic maintenance increases system reliability and extends operating life.

Consideration of these reliability factors is very important in applications that: 1) monitor critical functions over extended periods; 2) have components that cannot be easily replaced; or 3) do not have skilled maintenance personnel readily available. Component redundancy to increase reliability to an acceptable level can solve this condition.

e. Resolution and Accuracy. The term "measurement resolution and accuracy" simply implies to what degree the measured value represents the "true" quantitative value. With respect to instrumentation systems requirements, the engineer must clearly define the degree to which measured quantities must reflect actual values in order to provide adequate information to satisfy the need. Typically, there is a direct relationship between cost and the degree of measurement accuracy and resolution. The measurement accuracy and resolution requirement should reflect the relative economic value of the desired information. *

* f. Computation Requirements. The engineer must make a reasonable estimate of the volume, speed, and complexity of computations that an automated data collection and reduction system will be required to perform. Simple conversions and mathematics may be performed by individual hardware elements (analog signal conditioning and recording devices) in one and two data-channel systems. However, for automated multi-channel, multifunction data acquisition and processing, a microprocessor-based instrumentation system and supporting software is recommended. The major considerations for the engineer are identifying: 1) maximum system operating speed and storage capacity requirement for programs and data; and 2) available sources of system operating software.

g. Power and Power Conditioning Requirements. An automated electronic system requirements list must include considerations for power provisions. The factors that are pertinent include:

(1) Specific power requirements for individual instruments, to include requirements for current usage. Most instruments that require direct current contain internal power supplies or batteries with line charge capability.

(2) Alternative direct current power sources (batteries, photovoltaic cells, etc.) and power inverters must be installed if the electronic system is likely to be located in a remote area with no available line power.

(3) The relative economic value of a data loss must be weighed against significant costs for backup computer power hardware such as motor generators, uninterruptible power systems (UPS), line isolation, and regulation transformers. If computer back-up or uninterruptible power is not economically feasible, the operating program should be in read only memory (ROM) instead of random access memory (RAM) so that the system will automatically restart after a power failure.

(4) State-of-the-art computer applications routinely use software that collects, processes, and moves data into permanent storage at speeds that prevent more than miniscule loss of collected data if a hardware anomaly occurs.

h. Data Display and Recording Equipment. A basic function of an instrumentation system is to present desired measurement data to the user in a form that satisfies information needs. Thus, the engineer must explicitly define the requirements for acquired data display, storage, or special processing functions such as limit/alarm control. Processed data may be displayed on digital meters, video screens, multi-axis plotters, *

* chart recorders, or tabulated, formatted, and printed in hard copy on command by the user or a preprogrammed schedule by software. Also, all data may be stored on magnetic media for future processing.

9-5. Environmental Requirements. To complete the general requirements for design of an automated instrumentation and measurement system, the engineer must identify the major elements and range of the natural and induced physical environment to which specific subsystems will be subjected during operation. System performance and reliability depend upon the proper match of instrumentation and operating environment. To achieve this end, either the instruments can be fitted to the environment, or the environment can be conditioned to suit the needs of the instruments.

a. Natural Environment. Natural elements of the physical environment include temperature, humidity, vibration, pressure, dust, dirt, etc. The design requirements document should specify instrumentation subsystem components that are functional within a range of each applicable element. The following recommendations deserve particular consideration.

(1) Uncontrolled environmental excursions are generally excessive for typical automated instrumentation. Environmentally controlled enclosures are recommended for computer-based and other sophisticated equipment.

(2) Since exposure duration affects equipment survivability, where environmental conditions are severe, the use of portable data acquisition equipment will limit the equipment exposure to those times it is being used. The equipment might then be returned to a controlled environment for data processing and display.

b. Induced Environment. Induced elements of the physical environment include electromagnetic and electrostatic interference, the technical skill of system personnel, and spatial factors such as geographic and geometric distribution and size limitations of subsystem components. Examples of these are:

(1) Electromagnetic and electrostatic interference, and field sources of electrical signal noise generated by instrumentation power generators. These are damaging to improperly shielded existing subsystems. Identify and minimize large generators of electromagnetic and electrostatic fields and maximize proper shielding and ground plane techniques in retrofitted instrumentation.

(2) Skill level requirements of operation/maintenance personnel are generally a direct function of system complexity. Match the instrumen- #

* tation application with available personnel skills to reduce additional training-related costs and hardware/software problems.

(3) Installation of additional instrumentation requires additional space within an allocated area. Consider: 1) Centrally locating system components to facilitate efficient operation and reduce maintenance and interconnection requirements, 2) Make equipment accessible for maintenance, 3) Make instrumentation that requires frequent interaction with a human operator adequately labelled, lighted, and accessible.

Section III. System Design

9-6. System Considerations.

a. Having established the system requirements, a search for system components begins. A primary concern in such a venture is a cost versus performance comparison. A system that meets the minimum cost/performance ratio requirements now might not meet future requirements. Future expansion should be evaluated into the decision. It is best to select a system that may have specifications and capabilities beyond the current requirements to allow for future needs.

b. The stability of a manufacturer and the extent of his support are of great concern. If a manufacturer goes out of business or cancels the product line, problems with spare parts, maintenance, and expansion can arise. Talking with other users of like or similar systems provides a good input for rating a manufacturer. A check of the company's financial standing is also recommended.

c. System architecture influences speed and ease of access to the system. Central Processing Unit (CPU) speed is rated by width of bit units and cycle time. The data paths internal to the CPU are rated as 8-, 16-, or 32 bit units. The wider path is capable of handling larger numbers faster. Computer time is measured in CPU clock cycles. Each instruction requires a certain number of cycles; therefore, the time required for a process is the number of cycles required multiplied by the cycle time. The power of a computer is also determined by its instruction set. The more powerful an instruction set, the more powerful the computer.

9-7. Automated Measurement Techniques.

a. Digital computers now available provide the best means for acquiring and processing measurement information. The size and cost of the system will depend on the extent of processing, and the number and

*

* frequency of measurements. If storage is the only purpose of a system, the cost is low. Costs increase with system complexity and size.

b. A measurement is made by an element or transducer which produces a voltage, current, or frequency that represents the quantity or property being measured. This is accomplished by varying inductance, light, capacitance, or resistance. The output must be digitized for use by the computer system. It may be digitized at the source before transmission, or later at the system. Care must be employed in the transmission of the signal if they are digitized at the system. Transmission of digital signals have a high noise immunity, and may be checked to assure that what is transmitted is what is received. Low-level (mV or below) analog signals are the most critical in high-noise environments.

c. Computer systems offer means to calibrate and compensate for system errors to assure accurate readings. Most DAS manufacturers offer signal conditioning with multi-channel analog-to-digital (A/D) converters. Depending upon the type of input device, signal conditioning consists of amplification, bridge completion networks, thermocouple compensation, excitation voltage and current supplies, and filtering. The more accuracy and precision required, the more the system costs. Also, maintenance and calibration costs rise. Therefore, only the minimal accuracy and precision required should be specified.

9-8. Component Compatibility. In choosing components for a system, beware of the manufacturers' exaggerated claims of compatibility and performance. The best way to determine compatibility is to connect the units and observe their operation. However, when this is not possible, a competent engineer or technician should check specifications of all parameters for compatibility. Try to avoid special interfaces and special software drivers as they are expensive and difficult to maintain.

9-9. Instrument/System Characteristics.

a. Matching the instrument to the system is a critical part of system integration. For voltage output instruments, if the voltage level of the instrument does not match the voltage level of the system input, signal conditioning must be added. Some systems provide various levels, ranges, and resolutions with programmable gains. These and other forms of signal conditioning add to the cost of a system, and should only be specified when necessary.

b. If an excitation voltage is used, the system should be able to read this voltage for calibration purposes. The distance between the transducer and the system is a consideration because of line loss and in- *

* interference. Signal drivers, shielding and filtering may be necessary to reduce electromagnetic interference (EMI) on long leads. This is especially true in harsh electrical environments.

9-10. Interfacing Techniques. Using standard interfacing techniques is recommended since nonstandard interfaces make system integration a difficult task. There are two basic types of interfaces: serial, and parallel. Choosing an interface technique depends on distance, required transmission speed, and environment.

a. Serial. The Electronics Industry Association (EIA) RS-232-C standard is the most popular serial interface. Its limitations are distance and numbers of devices (17 meters and 1 device). Baud rates (bits per second) of 19.2 kbaud are possible. The EIA RS-422 standard interface is a differential version of the EIA RS-232-C standard. It is capable of transmitting over longer distances and at higher speeds (100 meters and 100 kbaud), and has better noise immunity. The EIA RS-449 standard serial interface has good noise immunity and baud rate (100 kbaud at 1200 meters), but handshaking slows the throughput rate. The 20-mA current loop is also a popular serial interface that may be used for transmission of data up to 180 meters at 9600 baud. Fiber-optic links are special serial interfaces. Their major advantages are: speed (10 Mbaud to 1 Gbaud), complete electrical isolation, and no electromagnetic interference (EMI). They are excellent for use in electrically harsh environments. They will transmit over 3 kilometer lengths without repeaters.

b. Parallel. The Institute of Electrical and Electronic Engineers (IEEE) IEEE-488 standard instrument bus is the most popular parallel interface. It is 8 bits wide and is capable of speeds of up to 1 Mbyte/set. Its limitations are distance and number of devices (30 meters and 15 devices). Another low cost interface is the Hewlett-Packard interface loop (HP-IL). This is a very simple two-wire link and is used on instruments, hand-held calculators, and computers. This link uses a loop configuration and can transfer 5 kbytes per second.

9-11. Power Sources.

a. Commercial power is sometimes unacceptable because of excessive noise, voltage fluctuations, and drop-outs. Less severe power problems can be overcome by using line conditioners which regulate voltage, filter noise, and protect against transients. More severe conditions could require the use of a motor-generator set which provides a higher level of line conditioning features. If power failures are intolerable, an uninter- *

* ruptible power system (UPS) should be considered. These systems monitor the input power and switch to a back-up system (battery, diesel generator, etc.) when there is a power interruption.

b. At sites where commercial power is not available, power can be obtained from batteries coupled with generators. System instrumentation should be chosen that operates with minimum power consumption to reduce backup power system costs. Batteries will store the power, and inverters convert the DC voltage to needed 120 VAC. Solar cells, thermoelectric and wind-powered generators may be used to maintain trickle charges on batteries. If available, water-generated energy may also be used. If these sources are not adequate, gas or diesel-powered generators may be installed. Also, power backup and conditioning, to minimize the effects of AC line voltage problems such as transient noise spikes, and dropouts may be required to ensure that a temporary power anomaly does not interrupt or prevent critical data acquisition.

9-12. Grounding Techniques and Lightning Protection.

a. The best system for grounding is to establish a single point for ground which is referenced to incoming power. All grounds should be referenced to this point with heavy gage copper wire. The single ground point should be a copper bar or plate. Analog and digital grounds should be separated except at the single system ground point. Cable shields should be grounded at the source end only. Equipment cabinets should only be grounded through a bus to the single ground point.

b. When it is necessary to establish a ground at a remote site, isolation should be used at the host system end. For digital systems, the least expensive and most effective method of isolation is the opto-coupler. Several isolation amplifiers are available for analog systems. AC signals may be isolated by using isolation transformers.

c. Some form of isolation and line conditioning such as high-isolation power transformers or additional grounding circuitry should be used between the system and commercial power, and in areas where lightning is likely to disturb the instrumentation. This prevents commercial power disturbances and lightning activity from damaging sensitive circuits in both the system and the field instrumentation.

9-13. Maintainability.

a. When reviewing a system design for maintainability, one should check for ease of access to components for test purposes. If the system uses plug-in printed circuit cards, an extender card should be available to^k

* aid troubleshooting. If the system has a modular construction, the modules should be of reasonable size and perform a particular function. This enables a "board swapping" approach to troubleshooting and minimizes system downtime. This approach requires stocking of spare boards. If parts are rare and unusual, ensure that the manufacturer can support the unit and that parts lead time is not excessive.

b. Documentation should be clear and concise, yet detailed. It should include a general description, a theory of operation, a block diagram of the unit, installation instructions, a section on troubleshooting, a parts list, and logic or schematic diagrams. Even the best technicians are unable to repair a unit without this basic documentation.

9-14. Operability. The ease with which a system functions determines the level of expertise required by the operator. Controls should be well labelled and easily understood, Try to avoid complex operation procedures. The more automatic the system, the less the chance for operator error.

9-15. System Calibration.

a. System calibration is essential to verify the accuracy of the various readings taken by the system. Measurement errors are the quantitative difference between the true values of the measurand and the values indicated by the measuring system.

b. The most accurate method of calibration is to apply a standard reference quantity to the sensor and adjust the measurement system to the proper reading at several points over the range of the sensor. Two types of reference standards are used in calibration. The primary standard is a standard which is directly traceable to the National Bureau of Standards (NBS) or a natural physical constant. Primary standards are seldom used in field measurement applications, but are used mainly under laboratory conditions. Secondary standards are those calibrated to a primary standard, and are normally used in field calibrations.

c. The most common method of calibration, although less accurate, is signal substitution. In this case, an electrically equivalent signal is substituted for the actual sensor output, and the measurement system is adjusted to the proper reading. The highest accuracy for this type calibration is obtained by signal substitution as close to the sensor as practical.

d. Generally, the accuracy of the calibration standard should be a factor of ten higher than the desired accuracy of the reading. In some

*

- * cases, a factor of three is sufficient, but this should be carefully re-searched.

e. Calibration should take place as close to actual and mean operating conditions as possible. For example a calibration taken at 70 F. may be inaccurate when used at 0 F.

9-16. System Flexibility.

a. System flexibility is enhanced by choosing a general purpose system as opposed to a special purpose system. The first consideration for system flexibility is the number of input/output (I/O) channels and communications ports the system is capable of handling. I/O may be limited to the unit itself or expandable through an expansion chassis. Most systems are expandable by use of a communications port and an intelligent front end. Intelligent front ends can reduce the load on the main system through distributed processing. Another advantage is that they require less wiring and speed up system throughput. Intelligent front ends may also be used on remote sites where they can be controlled via a modem, or through radio transmission.

b. The more memory and storage capability a system has, the more flexible it becomes. The sample rate of a system can also influence flexibility. Features designed into a system, such as limit alarms, can increase flexibility. The amount and type of system power, as well as environmental specifications tend to restrict system flexibility. The type of system bus will influence the number of products that are compatible with that bus. A local area network (LAN) is a bus structure supported by several manufacturers, but which requires an intelligent controller. LANs can increase system flexibility by distributing access to the system. Many peripheral devices can be linked to the system by a single bus. This provides a convenient way to reconfigure the system by adding or removing devices.

9-17. Economic Factors. The material cost of the system is always an economic factor. The labor cost of programming, installation, check-out, and documentation must also be considered. Once the system is installed and working, maintenance becomes the major economic factor. The service offered by the manufacturer or his representative directly influences maintenance costs. Parts availability and cost also influence maintenance cost. The cost of downtime is a factor; the cost of expansion is another. The replacement projection and cost should be considered. When life-cycle costs are evaluated, a system which costs \$10,000 and lasts five years isn't necessarily as good a buy as one which costs \$20,000 and lasts ten years.

*

*

Section IV. Sensor Selection Criteria

9-18. Sensor Selection Criteria. Sensor selection criteria may be categorized into four general fields: 1) data requirements, 2) environmental requirements, 3) system considerations, and 4) economic factors. The System Requirements Document should clearly define data and environmental requirements relating to sensor selection. Table 9-1 lists general data, environmental and system criteria which must be considered in selecting a suitable transducer for a given application.

9-19. Economic Factors. There are several economic factors to be considered in selecting sensors. They are as follows:

- a. Accuracy. Specify only the required accuracy.
 - (1) - Special sensors add to cost.
 - (2) - Extra documentation adds cost; i.e., calibration record.
 - (3) - More expensive transmission lines are required for highest accuracy.
- b. Range. Choose a flexible range and an overrange which prevents sensor damage.
- c. Temperature Compensation. Eliminate unless required.
- d. Material. Must be compatible with media being sensed.
- e. Shock, Vibration, Acoustic Bombardment, etc. Remotely locating the sensor can reduce shock. This may permit selection of less expensive sensors, simpler mountings, and less expensive cable.
- f. Electrical Characteristics. Choose sensitivity, impedance, excitation to match the needs of the system.
- g. Physical Characteristics (Size, Weight, Mounting). These are economic factors. Miniature sensors generally cost more; weight and custom mounting may be a cost factor.
- h. Connectors. If connectors are not included, the cost of a single connector may be as much as \$150.
- i. Repairability. Repair charges are usually about 50% of the cost of a new sensor.

9-20. Sensor Hazards. Sensors are susceptible to damage and failure when exposed or subjected to certain hazardous conditions. Some general and specific sensor hazards at Corps sites include:

- a. Over Excitation. With strain and temperature bridges, excessive current simply melts the wires in the bridge causing it to "open", or at least alter the sensitivity, linearity, and hysteresis of the sensor. Sources of over excitation can result from changes caused by line voltage variations, line transients, as well as a misadjusted power supply. Some power supplies produce up to +100% spikes when turned on. Proper excitation *

EM 1110-2-4300
 Change 1
 30 Nov 87

* turn-on procedures, the use of zener diodes as DC voltage regulators, and metal-oxide varistors (MOV) as power supply AC-line transient suppressors will minimize the chance of over-excitation damage to sensors.

Table 9-1

Sensor Selection Criteria

<u>Data Requirements</u>	<u>Environmental</u>	<u>System</u>
Range	Temperature	Excitation
Overrange (limits)	compensation	I/O impedance
Resolution	Thermal zero shift	Sensitivity
Responsibility	Thermal sensitivity	Gage factor
Frequency response	shift	Shunt calibration
Residual unbalance	Thermal shunt cal- ibration shift	Dimension, weight & size
Linearity/hysteresis	Static acceleration	Mounting
Total absolute accuracy	Vibration	Connector
	Acoustic bombardment	Insulation resistance
	Altitude & Humidity	Calibration
	Magnetic	Signal conditioning
	Electromagnetic	Reliability
	Side axis response	
	Nuclear	
	Thermal & Physical Shock	

b. Improper Polarity of Excitation. If connected backwards, the power supply may damage the sensors. Connect a diode in series with the power leads to prevent current from flowing when polarized backward.

c. Temperature Effects. Low temperature problems appear more often in civil engineering applications than those associated with high temperature. Some low temperature considerations are:

(1) Thermal Coefficient of Expansion. In sensors that rely on close dimensional tolerances, particularly between moving parts of different materials, differential expansion can cause damage to the sensor or inaccuracies in their readings.

(2) Freezing of Liquids. In sensors that measure liquids or make use of them in the measurement process, freezing temperatures can damage the sensor or cause measurement errors. Piezometers are constantly plagued with malfunctions caused by freezing of the water they measure.

* (3) Recording Devices. Certain recording devices do not function normally in low or freezing temperatures. Pen plotters which make use of liquid inks will not record properly, and display devices (particularly liquid crystal displays) do not function at temperatures below freezing.

d. Shock. Shock is defined as, "An abrupt impact applied to a stationary object." Any sensor may be damaged by shock, and some common sources of shock are:

(1) Shipping. Sensors are generally well packed to prevent shipping shock.

(2) Handling. Handling represents a source of shock damage. Dropping may easily subject a sensor to a shock of several hundred g's.

(3) Storage. Delicate sensors should be stored in compartments lined with shock-absorbent materials or in their original shipping containers.

(4) Sensor Installation. Some of the more prevalent poor installation practices are: applying excessive physical force when mounting or electrically connecting the sensor, installing a sensor to a test specimen before mechanical work is complete, touching exposed sensing elements, or using improper tools to mount a sensor.

e. System Checkout and Calibration. Sensors are sometimes damaged when a system checkout is being performed. Never exceed the maximum physical input capability of the sensor.

f. Cleaning. Sensors should only be cleaned with materials which do not harm them.

Section V. Signal Conditioning

9-21. Introduction. Low-level electrical signals generated by basic measuring sensors generally need some form of "conditioning" before they are sent to the automated system processor or recorder. Such signal conditioning functions may require specific devices for certain classes of sensors (strain gage bridge), or they may be general purpose, as with filters, applying to a variety of signal transformations. Although certainly not exhaustive, the following types of signal conditioning are often required in the design of engineering measurement systems.

*

30 Nov 87

* 9-22. Bridge Circuits.

a. The resistive strain gage and Wheatstone bridge network is used extensively as the transducing element in measurement systems. Strain gage bridge applications require special signal conditioning techniques with elements of bridge excitation, bridge balance, bridge completion, and calibration (Figure 9-1).

b. Bridge excitation supplies should generally be grounded and caution taken not to ground the output of the bridge. Output signals typically are applied to fully differential amplifier inputs of recorders, meters, or processor systems. Bridge excitation, E_{ex} , must be a regulated constant voltage. Individual bridge sensitivities may be varied with the application of a series rheostat, R_s , allowing numerous bridges to be excited by one constant voltage source. Connection of a balance potentiometer, R_{z1} and a series resistor R_{z2} , provides for adjusting the output voltage to be precisely zero. Resistor R_{z2} should be kept as high in value as practical, since it shunts the bridge and reduces its sensitivity somewhat.

c. Strain gage bridges may be calibrated directly by introducing an accurately known resistance change, R_c "shunted" across R_2 , and recording the effect on the bridge output. A field effect transistor (FET) switch may be used to connect the shunt resistor, R_c , to the bridge, but it should operate at the input or guard potential, and be optically isolated from ground.

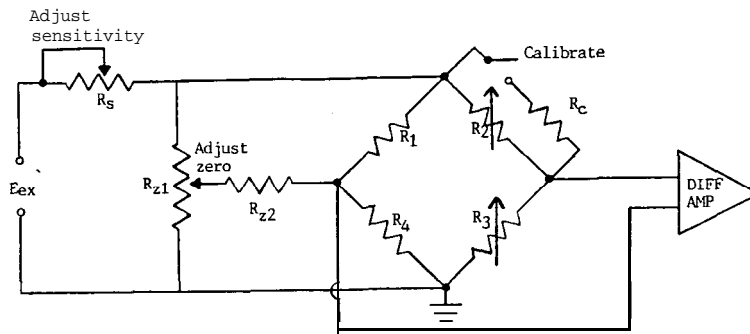

If $R_1 \approx R_2 \approx R_3 \approx R_4 < 1,000$ ohms (usual strain-gage transducer)

then $R_{z2} \approx 100 R_1$

$R_{z1} \approx 25,000$ ohms

Figure 9-1. Bridge with Sensitivity, Balance and Calibration features.

* 9-23. Amplification. Signal conditioning functions such as buffering, isolation, gain, level translation, and current-to-voltage or voltage-to-current conversion are performed by operational amplifiers. Most sensor circuit techniques required for best design and implementation generally lead the prudent system designer to seek packaged, commercially available "system solutions", such as modular, multichannel DC instrumentation amplifiers. These instruments are characterized by excellent key amplifier specifications of input and output impedances, stability (drift), input bias current or offset current, gain, and common-mode rejection. Bandwidth is critical in applications of high frequency dynamic signals such as seismic accelerometer outputs. Most commercial instrumentation amplifiers have selectable bandwidths from DC to 100kHz.

9-24. Instrumentation Amplifiers.

a. An instrumentation amplifier is a committed "gain block" that measures the difference between the voltages existing at its two input terminals, amplifies it by a precisely set gain, usually from 1 to 1000 V/V or more, and causes the result to appear between a pair of terminals in the output circuit. An ideal instrumentation amplifier responds only to the difference between the input voltages. If the input voltages are equal, the output of the ideal instrumentation amplifier is zero.

b. An amplifier circuit which is optimized for performance as an instrumentation-amplifier gain block has high input impedance, low offset and drift, low nonlinearity, stable gain, and low effective output impedance. Applications which capitalize on these advantages include thermocouples, strain gage bridges, current shunts, biological probes, preamplification of small differential signals superimposed on large common-mode voltages, signal-conditioning and moderate isolation for data acquisition, and signal translation for differential and single-ended signals wherever the common "ground" is noisy or of questionable integrity.

c. The most-important specifications in sensor interfacing are those relating to gain (range, equation, linearity), offset, bias current, and common-mode rejection.

(1) Gain Range. Values of magnitude 1 to 1000 V/V are common, but higher values are possible.

(2) Gain Equation. "Gain accuracy" specifications describe the deviation from the gain equation when the gain-setting resistor is at its nominal value. To take into account the lumped gain errors of all the stages *

* in the analog portion of the system, from the sensor to the A/D converter, systems using digital processing may be made self-calibrating.

(3) Nonlinearity. The magnitude of linearity error (or nonlinearity) is the maximum deviation from a "best straight line", on the plot of full-scale range output vs input. It is expressed as a percentage-of full-scale output range.

(4) Offset. While initial voltage offset may be adjusted to zero, shifts in offset voltage with time and temperature introduce errors. systems that involve "intelligent" processors can correct for offset errors in the whole measurement chain. In most applications, the instrumentation amplifier's contribution to system offset error must be considered.

(5) Input Bias. Input bias currents may be considered as sources of voltage offset (when multiplied by the source resistance). For balanced sources, the offset current, or difference between the bias currents, determines the bias-current contribution to error. Differences between the bias currents with temperature, common-mode level, and power supply voltage may lead to voltage offset or common-mode error.

(6) Bias Current Return Path. Although instrumentation amplifiers have differential inputs, there must be a return path for the bias currents, however small. If the path is not provided, those currents charge stray capacitances, which cause the output to drift uncontrollably or to saturate. Therefore, when amplifying the outputs of "floating" sources, such as transformers, thermocouples, and AC-coupled sources, there must be a DC "leak" from both inputs to common. If a DC return path is impractical, an isolator must be used.

(7) Common-mode Rejection. Common-mode rejection (CMR), is a measure of the change in output when both inputs are changed by equal amounts. Typical values of CMR in instrumentation amplifiers range from 70dB to 110dB. In the high-gain bridge amplifiers found in modular signal-conditioners, the minimum line-frequency common-mode rejection is of the order of 140dB.

9-25. Isolation Amplifiers.

a. The isolation amplifier, or isolator, has an input circuit that is galvanically isolated from the power supply and the output circuit. Isolators are intended for: applications requiring safe, accurate measurement of DC and low-frequency voltage or current in the presence of high common-mode voltage (to thousands of volts) with high common-mode rejection; line-receiving of signals transmitted at high impedance in noisy en- *

* vironments; and for safety in general-purpose measurements where DC and line-frequency leakage must be maintained at levels well below certain mandated minimums. Principal applications are in electrical environments of the kind associated with dams, large concrete structures, and field-portable instrumentation. The medium that is currently in widest use is transformer-coupling of a high-frequency carrier for communicating power to and signals from the input circuit.

b. One of the most important considerations about using an isolation amplifier is the manner in which it is hooked up. Since the more common sources of electrical noise arise from ground loops, electrostatic coupling, and electromagnetic pickup, the following guidelines concern the guarding of low level millivolt signals in hostile environments (also refer to Figure 9-2).

(1) Use twisted shielded cable to reduce inductive and capacitive pickup.

(2) Where possible, drive the sensor cable shield, S, with the common-mode signal source, EG, to reduce the effective cable capacitance

(3) To avoid ground loops and excessive hum, signal low, B, or the sensor cable shield, S, should never be grounded at more than one point.

9-26. Filtering. Conditioning analog signals with filtering is a method of attenuating or eliminating electrical signals of undesired frequencies. The four basic types of filters are: 1) low-pass, 2) high-pass, 3) band-pass, and 4) notch.

a. The low-pass filter is commonly used in low frequency data applications to eliminate signal noise that originates at the signal source or is picked up in data transmission. It passes low frequency data signals with little attenuation and attenuates amplitudes at high frequencies. The majority of structural measurements made by the Corps result in very low frequency data signals which can be low-pass filtered to increase signal-to-noise ratio and enhance accuracy. It is highly desirable to select a cut off frequency as low as possible for the sensor signal conditioning. A good guideline is to select a cut off frequency which is as low as the desired information from the sensor will permit.

b. High-pass filters characteristically pass high frequency signals and attenuate low frequency signals. Typically, high-pass filtering may be used in piezoelectric accelerometer measurements of seismic activity to minimize errors due to amplifier bias currents and high noise gain at low frequencies in charge amplifiers. *

* C. A band-pass filter is typically formed by cascading a low-pass and a high-pass filter of appropriate cut off frequencies to obtain the desired band-pass characteristics. It is used with low to moderately high frequency signals.

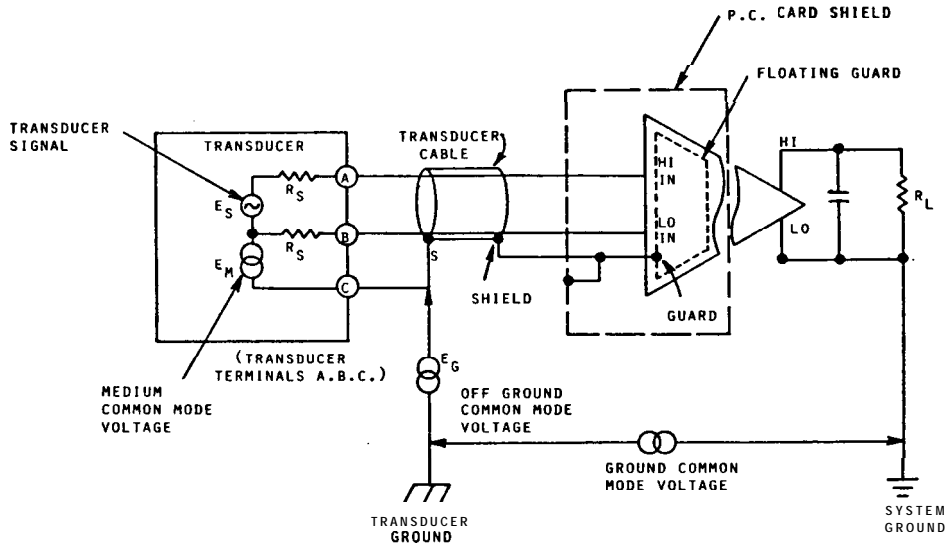

Figure 9-2. Sensor-Amplifier Interconnection

d. A notch filter is characterized by attenuating or "notching out" a narrow frequency band of an electrical signal. A common use of the notch filter is the rejection or elimination of 60-Hz power line interference in analog data signals.

9-27. Signal Conversion. Frequently, it is necessary to convert electrical signals from analog to digital form and vice-versa in large instrumentation and data acquisition systems. Signal conversions in these applications are generally of four basic types: 1) analog-to-digital, 2) digital-to-analog, 3) voltage-to-frequency, and 4) frequency-to-voltage.

a. The analog-to-digital converter (ADC) is the most widely used signal converter today. As the name implies, this device converts or

*

* "digitizes" analog signals to a digital form. Conversion time, accuracy, and linearity are important parameters. There are two types of ADCs generally used in data acquisition systems: successive-approximation and integration.

(1) Successive-approximation ADCs are quite widely used, especially for interfacing with computers, because they are capable of both high resolution and high speed. Conversion time is fixed and independent of the magnitude of the input voltage. Since the accuracy of this type of ADC is dependent upon the input not changing during the conversion process, a "sample-hold" device is usually employed ahead of the converter to retain the starting input value.

(2) The integrating ADC is also quite popular. It performs an indirect conversion, by first converting to a function of time, then converting from the time function to a digital number using a counter. The dual-slope type is especially suitable for use in digital voltmeters and those applications in which a relatively lengthy time may be taken for conversion to obtain the benefits of noise reduction through signal averaging. Though too slow for fast data acquisition, dual-slope converters are quite adequate for such sensors as thermocouples and gas chromatographs.

b. The digital-to-analog converter (DAC) is used to convert digitally formatted signals to analog voltages or currents. The output of a DAC can be either current or voltage. Typical applications of a DAC include programmable power supplies, current sources, pulse generators, panel meters, and industrial process control.

c. Voltage-to-frequency and frequency-to-voltage conversion is a process of transforming electronic data signals from the analog domain to the time domain and vice-versa. Voltage-to-frequency converters (VFC) convert analog voltage or current levels to pulse trains or other repetitive waveforms at frequencies that are accurately proportional to the analog quantity. Typical applications for VFCs include FM modulation, frequency-shift keying, A/D conversion with high resolution, two-wire high-noise-immunity digital transmission, and digital voltmeters.

d. Frequency-to-voltage converters (FVC) perform the inverse operation of the VFC; they accept a variety of periodic waveforms and produce an analog output proportional to frequency of the input waveform. Frequency-to-voltage applications include programmable frequency switches in instrumentation, motor speed control, and voltage controlled oscillator (VCO) stabilization. In analog-to-analog data transmission, the FVC converts serially transmitted data-pulse streams back to analog voltages.

*

* 9-28. Electrical Interferences.

a. Low level instrumentation signals are very susceptible to any number of electrical interferences, generating spurious, error-producing voltages that are orders-of-magnitude larger than the actual measuring sensor output. Electrostatic, electromagnetic, and radio frequency (RF) source interferences are frequently encountered. They require special conditioning and shielding techniques to minimize their effects on system measurement accuracy.

b. Electrostatic interference is a function of potential difference between two points. Any path, intentional or unintentional between these potential differences carries current and produces voltages. To minimize unwanted electrostatic signals, special shielding techniques such as the following are applied:

(1) Enclose low level signal carrying components in metal-shielded containers whenever possible and ground the container to earth or zero signal reference potential.

(2) Ground or connect shields at only one point in the general path of signal flow, to prevent voltage gradients along the shield.

c. The circuit in Figure 9-3 is designed to reject common-mode signals defined as voltage E. This voltage is a common-mode signal because it is impressed in "common" on both input leads. Often, this signal is called a normal-mode signal.

d. A second type of common-mode signal frequently encountered in instrumentation is the excitation voltage used in a strain gage bridge. If one corner of the bridge is grounded, then one-half of the excitation is common-mode and must be rejected. This circuitry is shown in Figure 9-4.

e. Instrumentation amplifiers are widely used to reject unwanted common-mode signals in data systems. A common-mode signal for an instrument amplifier is defined as the average input signal or:

$$ECM = 1/2 (E1 + E2)$$

and the differential-mode signal is defined as the difference voltage or:

$$EDM = E2 - E1$$

Note that if $E1 = 0$, the difference signal is $E2$ and the common-mode signal is $1/2 E2$. *

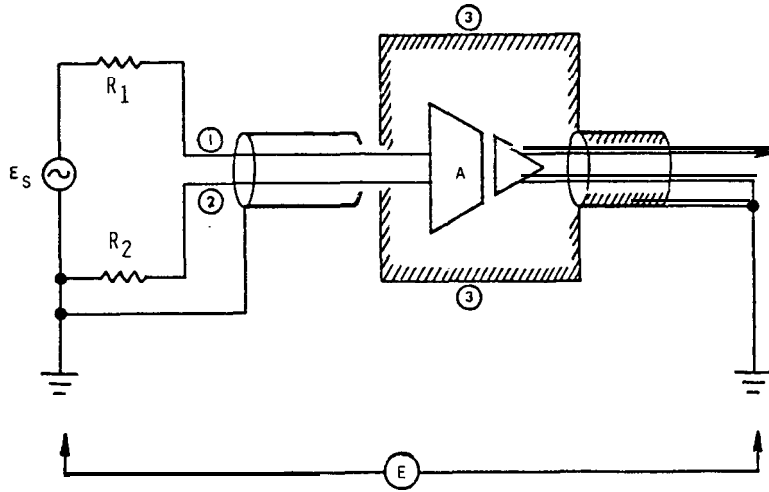

Figure 9-3. A Single Amplifier to Reject Signal E

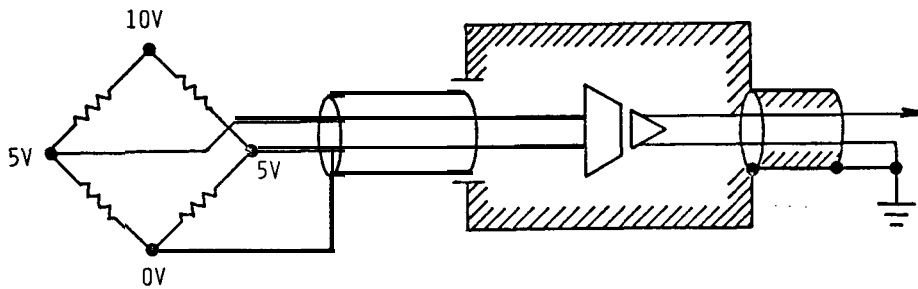

Figure 9-4. Excitation Voltage as a Common-mode Signal

* f. Changing magnetic fields result in electromagnetic radiation which induces stray currents and voltages in nearby conductors and circuits. At RF frequencies, even small capacitances appear as low reactances. For example, 100 pF is 150 ohms at 10 MHz. This means that nearly every conductor associated with a rack of instrumentation forms a ground loop with the ground plane and numerous other conductors.

g. Typical RF sources are radio, television, and radar. Also present are such devices as diathermy machines, arc welding, fluorescent lights, and glow lamps. Proper system grounding and shielding techniques preclude effects of RF interference.

Section VI. Data Transmission

9-29. Types of Data Transmission. The two basic types of data transmission are: cable and radio transmission. Radio is generally more costly on short links, and cable more costly in long links. The type chosen should depend upon economy and system needs. The cost of signal amplifiers, cable, and cable installation should be weighed against the cost of the radio transmitter, receiver, and antennas. When choosing a method of transmission, the three most important factors are distance, frequency, and environment. Generally, a short distance, low frequency link in a low electrical interference environment is the least expensive. The data may be transmitted in analog or digital form. Digital methods are less subject to interference, have the advantage of data verification, and can be transmitted serially or in parallel. The disadvantage is the requirement of digitizing the signal at the source. This requires a power source and analog-to-digital converters at the sensor end of the data link. Low level analog voltage signals are the most subject to interference. Most analog signals are transmitted as voltage levels over short distances, but can be transmitted as 4-20 mA current signals. Because the system operates from 4 to 20 mA rather than 0 to 20 mA, the presence of a 4-mA current confirms link connection.

9-30. Multiplexing.

a. Multiplexing is the sending of two or more separate signals over the same channel. There are two forms: time-division and frequency-division. Time-division breaks each transmission into segments of known time length and sends them serially. Frequency-division sends multiple transmissions on different frequencies at the same time. Several hundred signals can be transmitted in parallel over the same channel using this method. Multiplexing can reduce signal conditioning, cabling requirements, and the number of receivers, and sensors.

*

* b. The disadvantages of multiplexing are mainly the requirement for power at the transmitter end, and the cost and maintenance of the electronics for the transmitter and receiver. The main advantage is that it reduces system hardware redundancy.

9-31. Network Configurations.

a. When designing a data transmission scheme, the three most common network configurations are centralized, loop and distributed. These configurations require intelligent controllers at each end and not merely signals from sensors, meters, etc. In a centralized system, data lines are connected to a central point where a controller handles most shared tasks (Figure 9-5). The advantages of a centralized network are simplification of network control and shared control hardware and software. The disadvantage is that host lines are dedicated and can not be shared with others.

b. In a loop configuration, the interfaces are serially linked in a circular manner (Figure 9-6). This works well when remote controllers are relatively close to each other. Communications interfaces are less costly for this configuration.

c. In a distributed configuration, intercommunications may be achieved by any node pair in the network (Figure 9-7). Its advantage is that a failure at one node does not affect the rest of the network. Its disadvantages are that it is difficult to control and requires a complex communications interface at each node.

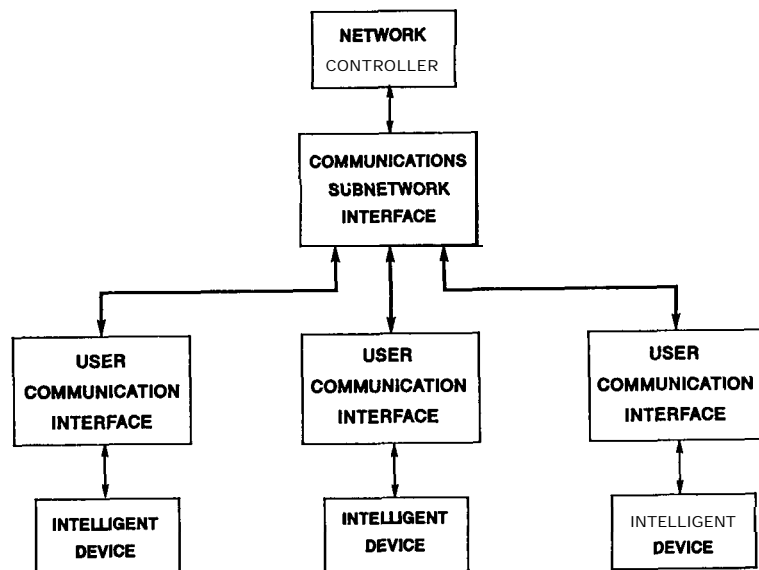

Figure 9-5. Centralized Configuration

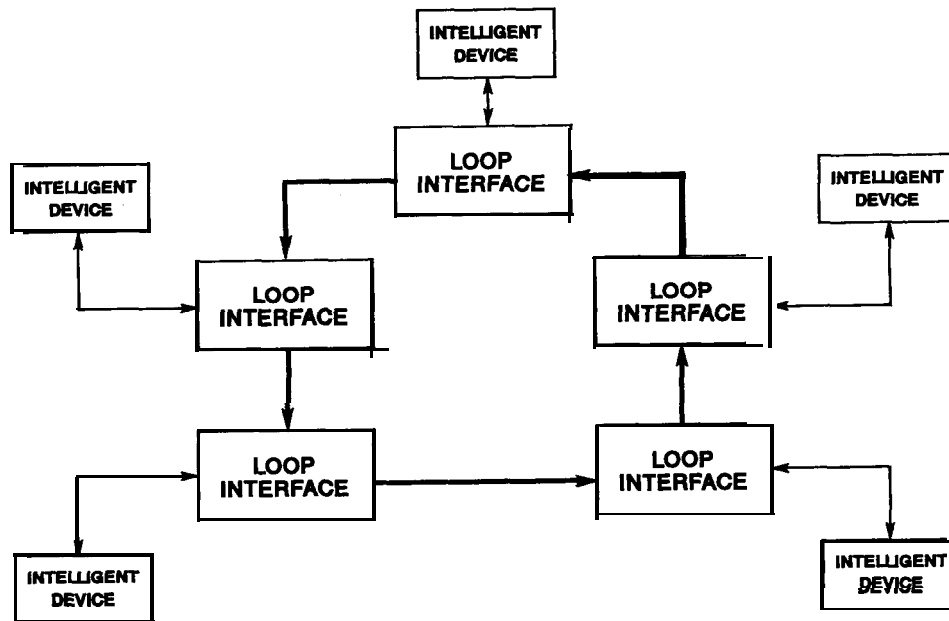

Figure 9-6. Loop Configuration

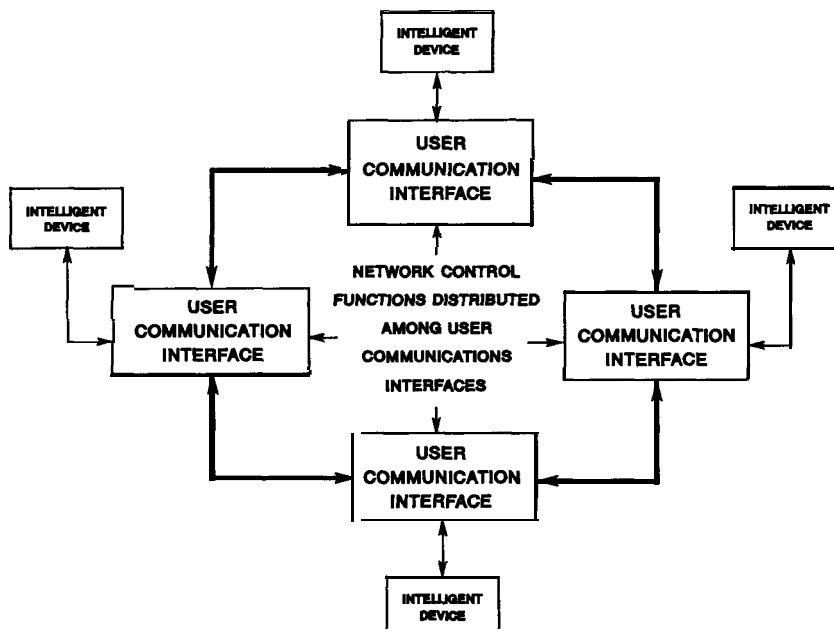

Figure 9-7. Distributed Configuration

*

* 9-32. Transmission Techniques.

a. Cable. The most common and inexpensive form of transmission for short (one kilometer or less) links is electrical cable. Two types of commonly used cables are parallel wire and coaxial. Parallel wire cables are used for low-to-midfrequency and balanced line applications. Using twisted pair (signal and return) and/or an outer conductive shield reduces noise and interference. Coaxial cable is used for frequencies up to 18 GHz in unbalanced line applications. High-frequency transmission factors are: losses due to radiation and reflected power, characteristic impedance, and signal attenuation. Signals may be transmitted over cables in single-ended or differential modes. In the single-ended mode, the signal return is referenced to ground. In the differential mode, the receiver detects the difference between signal and return. Analog or digital signals may be transmitted in either mode. Analog signals can be corrupted by noise and the response characteristics of the transmission line. Digital transmission systems are not as easily corrupted and have the advantage of error detection and/or correction.

b. Fiber-optics. When noise or interference become intolerable, a fiber-optic link may be used. Fiber-optic links also provide electrical isolation. These are very high-speed links and have a wide bandwidth.

c. Radiotelemetry. When interconnecting cables are not possible or desirable, signals may be transmitted by radio. Radio signals may be amplitude, frequency or pulse modulated and may be analog or digital. Since radiotelemetry can become quite complex with problems associated with transmitters, antenna location and orientation, and noise interference; other forms of data transmission should be investigated first.

d. Satellite Transmission. A recent innovations in data transfer is the use of satellites to transfer information from one spot in the country to another. Data is transmitted from the site to the satellite via a radio transmitter. The data is then transferred to a ground receiving station where it can be further reduced and used for monitoring the remote operations. The equipment that is necessary to accomplish this transfer is called a data collection platform. It consists of a data collection unit, usually of an intelligent nature capable of making decisions under the control of a computer program, a transmitter, and a transmitting antenna.

9-33. Transfer Rate (resolution and accuracy). Transfer rate, sometimes referred to as throughput, is the number of readings or signals which can be transferred per unit of time, usually per second. If a serial digital transmission is used and has a 10K throughput (10,000 readings per second) with a 16-bit resolution, the transmission line must be able to support *

EM 1110-2-4300
Change 1
30 Nov 87

* more than 160 kbaud (adding control, error, and synchronization bits). Transfer rate is a controlling factor in the selection of a transmission method and usually has a direct relationship to cost. Usually, the higher the resolution, the higher the cost.

Section VII. Data Processing, Display, and Recording

9-34. Complexity. Data processing, display, and recording functions range from simple systems to very complex software-intensive computer systems. A simple system is a strip chart recorder. The data signal is conditioned, displayed and recorded in a single unit. Most low-end systems, such as strip chart recorders, supply raw data or data in a form which may not be used in other systems. Computer systems give the highest degree of flexibility for data processing, manipulation, display, recording, and storage.

9-35. Data Processing.

a. The vast majority of data processing is digital processing, analog processing is rare. Once digitized, the analog signal is input to the computer or data system as raw data.

b. At this point, the data volume is at its maximum. The raw data may be stored and/or recorded at this point. If the raw data are stored and then processed, this is called batch processing. If the data are processed as they are read, this is called real-time processing. Where speed is important, real-time processing is necessary.

c. The first step in processing raw data is usually to convert the data to engineering units. In this conversion process, calibration factors are often used to compensate for inaccuracies, and conversion factors are added to change electronic signals to readable, engineering values. The speed and flexibility of this process are influenced by the computer language used.

d. The following is a quick overview of the advantages and disadvantages of different languages for basic understanding.

(1) Machine Language. All other languages are ultimately converted to this type of code. It is machine dependent, very fast, but is an extremely difficult language in which to program.

(2) Assembly Language. The next highest level of language consists of acronyms which represent machine functions. It is called ASSEMBLY language. It is also a fast language, somewhat easier to interpret, but also cumbersome and difficult to code. *

* (3) High Level Languages. The high level languages are so called because they use English-like text for programming. These languages, although they are easy to program, are slow because they must be compiled or interpreted before they can be understood by the computer. BASIC is one of these languages, it is used quite frequently with personal computers. The most frequently used high level languages are COBOL, FORTRAN, and PASCAL. COBOL is a business language designed to handle large amounts of data with very little manipulation. FORTRAN is a scientific language designed to handle small amounts of data with a great deal of manipulation. PASCAL is designed to be a fast running language with some of the advantages of both COBOL and FORTRAN.

9-36. Display. Once data have been acquired and reduced, they must be displayed. The most common types of data display are as follows:

- a. Printers:

Line printers	Dot matrix printers
Character printers	Daisy wheel printers
Letter quality printers	Electrostatic printers
- b. Plotters:

Flat bed plotters	Multipen plotters
Moving paper plotters	Electrostatic plotters
- c. Cathode Ray Tubes:

Monochrome	Color
High resolution	
- d. Alphanumeric Displays:

Gas discharge displays	Light emitting diodes (LED)
Liquid crystal display (LCD)	Dot matrix displays

9-37. Recording/Storage.

a. Data that must be kept for later use needs to be stored when not in use. There are several types of storage, and each has its appropriate advantages. Random access memory (RAM) is storage that is meant for short term use. It is only a viable means of storage while the computer is on. When power is removed from the system, its contents are lost. For more long term storage magnetic media must be used. There are two types which are most frequently used. Floppy disk and hard (Winchester technology) disk allow for random access to data which is not lost when the system is turned off. Magnetic tape also retains data when power is removed, but in *

* order to get to information on the tape, all the data before it on the tape must be read. This makes it a slower method of retrieving stored data. The magnetic tape is also the less expensive type of storage.

b. Although magnetic tape and disk are the most commonly used methods of data recording and storage, other methods are available. These include punched cards, paper tape, and bubble memory. All of these methods are sequential and have advantages for specific applications.

Section VIII. System Design Document and Design Review

9-38. System Development. System development should start with two elements: a system design document and a design review process. Both these elements cause the development of the system to be well thought out and designed for the instrumentation purpose it was intended. System strength, capability, budget, space, and environment are all areas which need consideration. The system design document establishes the level of need and the constraints of the system. The design review process reviews what has been developed, refines the parameters, and prevents the occurrence of design oversights.

9-39. Guidelines for Preparation of a System Design Document.

a. After the system requirements document is complete, a block diagram and list of all hardware and software should be drawn. The list should contain at least those items given in Table 9-2.

Table 9-2

Items on Hardware and Software List

Part and model numbers	Number of units required
Description of the unit(s)	Options required
Accessories required	costs
Manufacturer or vendor with address and phone number.	

b. A site plan showing the placement of electronic cabinets, sensors, tables, etc., should be drawn. A detailed drawing of each cabinet with installed equipment should be included. Cable details should be prepared, showing signal line designation, cable type, length, connector types, and connector pin designations.

c. Power requirements for the system should be determined and a drawing prepared to show power boxes, breakers, cable routing, and line

*

* conditioners or motor generator sets. Grounding details should be defined and drawn.

d. A form showing the type and format of data transfers between units should be prepared to save time in software development.

9-40. Guidelines for Conducting a Design Review.

a. The purpose of the design review is to determine if the design meets the design requirements set forth in the "System Requirements Document." The design review process should not be a new design definition session, it should nevertheless be flexible enough to incorporate legitimate changes and omissions.

b. The design review should cover the entire system. Every component should be examined to verify that it will perform its intended function, without interfering with other system functions. The more "what ifs" discussed, the better the chances that the system will operate properly. Control and alarm functions of the system should be carefully examined to determine if they sufficiently cover the needs of the entire system.

c. System hardware discussions should include the following:

- (1) The number and type of sensors
- (2) Type and location of signal conditioning
- (3) Multiplexing
- (4) Transmission techniques
- (5) Signal conversions
- (6) System interfaces
- (7) Data storage and recording devices
- (8) System capabilities
- (9) System control and indication functions
- (10) Electrical and physical environment
- (11) Power requirements

d. System software discussions should include the following:

- (1) Input data formats and polarity
- (2) Operating system functions
- (3) Languages used
- (4) Memory management
- (5) Memory capacity
- (6) Data processing and storage
- (7) Data storage formats

- (8) Data recording and recording formats
- (9) Operator interfacing with the system
- (10) Overall system speed

Section IX. System Implementation

9-41. Detailed Design.

a. Those facts gathered from the system design document should be reviewed and incorporated into the detailed design. Design emphasis should be placed on site plans, power requirements, grounding plans, rack layouts, and cabling.

b. When required instruments must be fabricated in-house, fabrication drawings, wire lists, and assembly instructions should be prepared. Documentation of nonstandard instruments is critical, whether they are designed in-house or not.

c. Documentation of nonstandard units should be specifically detailed in a design document. The design document should include detailed specifications of the item to be fabricated. Specifications should include all constraints such as size, weight, power requirements, mounting, electrical, environmental, controls, speed, etc. An assembly manual should be prepared to assist in fabrication of the system. A technical description of the system should be prepared. It must include all information necessary for the operation and maintenance of the unit. This usually consists of electrical and mechanical drawings, a theory of operation, operating instructions, installation instructions, programming instructions, a parts list, and any other pertinent information.

9-42. Procurement and Receiving Inspection. The final system configuration will have an impact on the procurement and inspection process. If the final system configuration is purchased from a single manufacturer, the purchase agreement should include an on-site demonstration by the manufacturer to ensure that the equipment meets all applicable specifications. Trade-offs are involved in the procurement/inspection process and should be resolved before procurement arrangements are concluded. For some systems, an inspection at the manufacturer's plant and an on-site inspection may be desirable, others may only require an on-site inspection, while still others can be done by in-house personnel. Purchasing standard systems, subsystems, or components is recommended whenever feasible to reduce costs, and improve on documentation, maintenance, and spare part availability.

a. Procurement. The procurement cycle normally commences with the final approval of system design. After design approval, a determination of *

* long lead time items should be made in order to establish an ordering priority list. When standard components are ordered by manufacturer, model number, etc., the technical specifications need not be stated on the procurement document. However, when nonstandard equipment is procured or competitive bidding is required, all specifications must be stated on the procurement document. Other requirements on the procurement document include:

(1) The need for a source (manufacturer's plant) inspection. A more reasonable approach is to have an on-site inspection for larger systems and an in-house inspection for small systems and components.

(2) All system options. Some manufacturers tend to offer several versions of a system to accommodate multiple-user requirements.

b. Receiving Inspection. An inspection plan should be prepared to delineate the type of inspection to be performed. It should define the type of documentation to be maintained; the procedure to be followed when material or articles do not conform to applicable drawings, specifications, or other requirements; and the acceptance/rejection criteria.

(1) A physical inspection of all incoming equipment should be made. Those articles which require no further inspection should be sent to the designated system assembly storage area; those articles which require acceptance testing and/or calibration should be sent to the responsible testing authority. All articles damaged by the common carrier should be documented, and the carrier should be notified so that remedial action can be taken.

(2) All sensors, instruments, and subsystems which contribute to the overall system accuracy and operation should be acceptance tested and/or calibrated. All nonfunctional hardware, such as cabinets, etc., may be visually inspected. Records of all inspections and tests performed should be maintained. These records show the initial status of an instrument and substantiate nonconformance or failure during the warranty period.

9-43. Acceptance Tests. The objective of acceptance tests is to verify that material and articles meet the supplier's stated specifications or the actual application requirements. Generally, the manufacturer's test/calibration procedures are followed to verify that specifications are met. When applicable, test data should be recorded and retained. When material or an article fails the acceptance test(s), it should be so noted and a determination made as to whose responsibility it is to make repairs *

- * and/or adjustments. In some special cases, a supplier or his representative makes on-site corrections, especially when large single source systems are involved or when specifically stated on the procurement documents.

9-44. Metrology Controls.

a. Generally, there are components within an instrumentation system which should be calibrated and placed in a documented metrology control/recall system. The documented metrology system should provide evidence of quality conformance. Components normally placed in a metrology control/recall system are: sensors, amplifiers, filters, voltmeters, analog-to-digital converters, and calibration standards. These components should be assigned calibration intervals based upon manufacturers' recommendations, or the recommendations established in standard Government manuals. The calibration intervals should be reviewed periodically and adjusted to insure recalibration on a timely basis. In establishing intervals, consideration should be given to the use, accuracy, type of standard, required precision, and other conditions adversely affecting quality.

b. All standards and equipment used in measurement processes should be in a recall system. Controls should be established to ensure that those instruments which are not calibrated within the established interval be immediately recalibrated or removed from service. All equipment in the recall system should have a label or tag affixed to indicate the calibration status and due date of the next calibration. The calibration record system should provide sufficient information to determine calibration results, traceability to the NBS, date of calibration and the interval or next calibration date.

9-45. System Fabrication.

a. If turnkey systems are not procured, the decision to make or buy a piece of equipment should be made promptly so that system integration and installation is not delayed. If fabricated in-house, several categories of component devices are likely to need special attention. They are mounting brackets, cables and wiring, cable troughs, and electronic interface devices. The quality of materials used, clarity of panel markings, routing of cable harnesses and the placement of clamps, and general workmanship during the fabrication process need attention.

b. Detailed electrical and mechanical drawings should be prepared before fabrication commences. Other documentation, such as hardware and electronic component specifications, input/output voltage levels, and

*

* impedances should be specified. The documentation will be required regardless of the source of fabrication.

9-46. System Integration.

a. Hardware integration consists primarily of cabling all units together. Problems with missing cables or cables with the wrong size or type connectors are found and corrected. At this time each cable should be tagged, so that when the system is packaged for delivery to its permanent location, all cables will be properly identified. Regarding warranties, each manufacturer has specific rules regarding what voids a warranty. Therefore, before opening a unit or removing its covers, the owner's manual or warranty card should be checked.

b. The application of AC power to the system should be done slowly, carefully, and unit by unit. Although each unit was verified as operating properly during acceptance testing, it may have developed problems or the interface cabling may be incorrect. After power is applied to all units of the system, each unit should be verified as being operational.

c. Software integration is very similar to hardware integration. First, the computer is verified as operational by running the appropriate CPU and memory diagnostic. Then each standard peripheral such as disks, tape drives, and printers, should be verified using standard diagnostics. The nonstandard devices such as A/D converters, multiplexers, and other signal conditioning equipment must be verified with purchased or self-written diagnostics. Next, the computer operating system (OS) should be loaded, with drivers to operate all peripherals ready for testing.

d. The final checkout phase of system integration consists of verifying the proper operation of the data acquisition program with all system hardware. This verification should closely simulate the site-installed configuration. Interface cables of the same length as those to be installed at the site should be used. A complete set of sensors similar to those at the actual site should also be used or simulated as closely as possible. As the last step in the system integration phase, the final hardware and software configuration should be documented in the system installation manual.

9-47. System Installation.

a. System installation actually begins during the system design phase when the physical layout or site plan is drawn. Corps sites are often environmentally harsh and hazardous to automated instrumentation. The area which houses the main components of the system should be thoroughly

*

* cleaned and the cooling/heating systems verified just before the arrival of the system. Dust, especially concrete or cement dust, from construction or renovation causes air flow filters to clog and magnetic media to be severely damaged.

b. In areas that are subjected to wide temperature variations and water/moisture exposure, instruments should be enclosed in environmentally-conditioned cabinets or rooms. To reduce moisture condensation and corrosion damage and limit temperature excursions, simple electrical heater strips or light bulbs may be installed within the instrument enclosure or room. A commercial-grade electrical insulating varnish or equivalent coating should be sprayed over all exposed electrical connections to protect them from corrosive moisture.

c. To preclude physical damage to instruments and equipment, they should be installed in metal cages, cabinets, or equally sturdy enclosures or shelters. To limit the damage by vandalism, all equipment (instrumentation and cables) should be enclosed in protective shelters and, if possible, hidden from normal view. All enclosures that are exposed to weather and public access should be environmentally protected, and fabricated with steel plating and padlocks.

d. Upon arrival at the site, the equipment should be physically placed in accordance with the site plan. Before connecting cables between units, and applying primary power to each unit; the outlet or junction box should be checked for proper wiring and grounding.

e. After all equipment is in place and all cables are connected, power may be applied to the system and the check-out phase of the installation may commence.

f. Final acceptance of the system also affords a good opportunity for user training. Having the system user perform all functions and tests that are to be implemented, not only tests the operability of the system, but also allows the user actual hands-on training.

g. As the last step in system installation, the system installation manual should be verified against the installed configuration. Any discrepancies should be resolved so that the information in the manual reflects the actual installation. Any changes that have been made during the installation must be properly noted.

*

* 9-48. Documentation.

a. All system documentation must be maintained and updated throughout the life of the system. Documentation for individual units of the system is covered in Section X, Maintenance.

b. System documentation, unlike unit documentation provided by the equipment manufacturer, normally must be written specifically for each system. The primary purposes of system documentation are: how to operate the system; how to modify the system to add more hardware or changing the software; and how to maintain the individual components of the system.

c. The operations manual should include step-by-step procedures for all functions normally performed by a system operator. It should include what to do when things are working correctly, and also what to do when things are not progressing according to the procedures.

d. The system theory manual may in fact be more than one manual as both the hardware and software that make up the system need to be addressed. The hardware manual or section should, as a minimum, include the final system requirements, system design documents, a system level block diagram, and a written theory of its overall system operation. The software manual or section should contain a system level flow chart depicting the major software activities, a brief theory on the major portions of the program, and a table or tables depicting error messages, alarms, and predetermined set points or interrupts that automatically modify system operation. It should also include complete program listings containing comment statements for clarity of meaning.

e. At least two complete sets of documentation should be supplied with the system. One set should remain with the system; the other set should be maintained at a central location for reference by engineers who have responsibility for system maintenance or modification.

Section X. Maintenance

9-49. Maintenance philosophy. Developing a system maintenance philosophy is an intricate process requiring forethought and planning. Some of the elements which must be resolved are: the complement of maintenance technicians, a centralized or decentralized program, number of spare units or components to be maintained, and the amount of system downtime that can be tolerated. Once these answers are found, the overall maintenance program can be developed. A well-planned maintenance program results in a system which performs as expected and remains operational for many years. *

* a. Establishing a Philosophy. A maintenance philosophy should be undertaken early in the system design stage, and funds for its maintenance budgeted. A well-designed, automated system is of little use if it fails and can't be repaired due to a lack of manpower or material budget.

b. Types of Maintenance. Maintenance can be of three types: contract maintenance, self-maintenance, or some combination of the two. The decision must be based upon cost, in-house knowledge and manpower. Total contract maintenance requires the least amount of in-house skilled manpower, but may be the most expensive solution. Total self-maintenance requires the greatest complement of skilled manpower, and may lower maintenance costs. A combination of the two offers the technical skill of others, with the lower costs of self maintenance, and can produce a balanced product of experience and reasonable cost

c. Repair Philosophy. Repair can be centralized or localized. The chosen repair philosophy will depend upon criticality of the measurement being taken, cost, in-house expertise, and the level of replacement parts that the organization is willing to keep on hand. Board or subassembly "swapping" is the fastest method of achieving repair, and requires very little technical knowledge or equipment to achieve. The bad board is merely swapped out for a good one and the defective board repaired. However, it does require a large inventory of spare parts to be kept on hand. Choosing the alternative, fixing the unit in-house or sending it to a repair service, means taking the equipment out of service for a length of time. On site repair requires the most manpower, level of training, and inventory of parts. Sending the part or unit to a regional, or national repair service relieves the need for these items, but necessitates more time out of service for the unit.

9-50. Preventive Maintenance.

a. Each manufacturer normally includes, as part of the operations or maintenance manual, a section on the frequency schedule and activities that should be performed to verify proper operation and to prevent failures. These should be used to develop good preventive maintenance (PM) habits. A "master" or system PM schedule must be developed which includes recommended PM on each component of the system. The manufacturer's recommended frequencies must then be reviewed, modified, and checked against performance histories of the instruments in similar conditions to determine the frequency of maintenance for the environment in which the system is operating, i.e., increasing the PM frequency on a component if its environment warrants the extra protection. Providing an idealized environment for a system will reduce the frequency of maintenance required. These schedules should be checked periodically to insure that they are sufficient.

*

* b. In the absence of manufacturers guidance on PM, reference to the recommendations for similar instruments under similar environments is advisable. The type of PM depends upon the instrument. A totally electronic instrument requires only an occasional cleaning; however, one with fans and filters must be cleaned and checked for proper air flow at a frequency dependent upon the operating environment. Electromechanical and mechanical instruments however, require periodic cleaning and lubrication. If there is doubt about the frequency of a PM check, a conservative stance, with more frequent PM checks is recommended.

c. The installation of data acquisition systems at unmanned remote sites presents entirely different problems. The previously developed PM schedule may be totally impractical because of manpower shortages or extremely difficult access. Under such circumstances, a trade-off between manpower and the loss of all or a part of the system must be made. Therefore, any visit to a remote site to correct a known problem or to collect data, etc., should be combined with a PM visit.

9-51. Calibration.

a. To assure that accurate data are collected by the data acquisition system, the various units of the system and the system as a whole require calibration. The type, accuracy, and frequency of calibrations must be addressed during the system design.

b. During the acceptance process, each unit should undergo precision calibration. All sensors, especially those that are inaccessible after installation, should be verified for proper operation and accuracy by a competent calibration laboratory. All sensors should come with calibration data sheets, and digital instruments need only be verified for correct operation.

c. Once the system is put together, it should be calibrated by using an electronic voltage standard in place of the actual sensors. At this time, true system operation and accuracy may be tested and verified.

d. Periodic calibration of the system should be done. Manual calibration requires that a standard voltage be substituted for the sensor output. This known input used with a software calibration program allows verification and adjustment of the system for proper readings.

e. Automatic system calibration requires the installation of a programmable voltage standard, associated calibration relays, and a calibration program. This method allows calibration of the system by the repair technician after a repair or PM and without additional test equipment. Ef- *

* ports should be made to inject the calibration signal as close to the sensor output as possible. This will give the highest level of confidence in the overall level of system performance. The frequency at which an automatic calibration can be run is practically unlimited, as it may be programmed to require no operator/technician intervention. The output of the calibration program may be evaluated by the processing unit, and failures or out-of-tolerance readings can be used to trigger either local or remote alarms.

f. Signal conditioning equipment returned from repair requires recalibration. Each unit must be calibrated or aligned to meet the manufacturer's specifications.

9-52. Documentation.

a. The purchase agreement should require each equipment manufacturer to provide sufficient documentation to facilitate the component level repair, alignment, and calibration of their respective instrument. Three major categories of documentation are required to properly maintain any unit of electronic or electromechanical equipment.

(1) The Reference Manual. This document should contain basic information on the functional use, programming, and basic input and output parameters of the unit. This manual is to assist the maintenance technician during the problem identification phase of repair. It answers many important questions such as: how the unit operates, its correct input and output format, and if it is functioning properly.

(2) The Service Manual. This describes the causes for certain failures, and how the technician isolates and repairs these problems. This manual normally contains a unit theory of operation, calibration information, as well as a breakdown of the major assemblies and subassemblies and a theory of operation for each. Depending upon the type of unit covered by the service manual, there are other helpful hints for the repair technician such as: troubleshooting procedures, signal and test patterns, spare parts lists, PM procedures, and manufacturer assistance procedures.

(3) The Drawing Package. Schematic or logic diagrams which are absolutely necessary for component-level repair of assemblies and subassemblies are contained here. Also, this package usually contains an illustrated parts breakdown (IPB) and the mechanical drawings of all component hardware.

b. The system integrator, vendor, or controlling engineer should be required to provide a system installation or system configuration manual. *

- * This must be updated to reflect the actual configuration of the system after installation and acceptance. Additions, deletions, and any modifications to the system should be documented in the system installation manual. The system installation or configuration manual should contain as a minimum the following:

- (1) Site plan (equipment locations).
- (2) Power wiring and power source drawings.
- (3) Cable routing and identification drawings.
- (4) Computer bus priority scheme.
- (5) Computer bus addressing, or unit recognition scheme.
- (6) Unit identification (manufacturer, model, and available documentation for the unit).
- (7) List of applicable software tests and diagnostic programs with instructions on how to run them.

C. The permanent location of each manual will depend on the maintenance philosophy chosen. Reference, service, and site installation manuals should be at the equipment site or carried to remote sites by a technician. If site, regional, and national centers are used for repair, copies of each manual should be located at each center. This documentation also provides quick reference for the engineer who is tasked with upgrading or modifying an existing system.

9-53. Maintenance Software (diagnostic).

a. Diagnostic software of different levels is required for maintenance troubleshooting of computer system hardware. The first level of on-site diagnostics should be developed or modified for each specific system and used as an operational readiness test. First level software only needs to verify basic communications between units, and fundamental operations of each device such as: 1) Are the sensors connected to the system? 2) Are the sensor readings reasonable for existing conditions? 3) Can the magnetic medium write, read, etc? Additionally, an on-line/off-line calibration diagnostic program should be incorporated into the system software. Although it is more time-consuming to run than the operational readiness test, a thorough system calibration program is used to find units which, although functional, are not operating within specifications and require replacement, alignment, or recalibration.

b. Diagnostics for subassembly or module level maintenance and troubleshooting are very complex and time consuming to run. They are device-specific and must verify all functions of a device. This type of diagnostic program is normally available from the equipment manufacturer and should be purchased simultaneously with the equipment. *

* C. Software for automated calibration of sensors and signal conditioning devices is also a necessity if the devices are to be calibrated on site. This software may be purchased from equipment manufacturers and customized for specific system configurations, or developed from "scratch".

d. If the data acquisition systems are on-line to central points of data collection, a remote diagnostic feature may be used to save a significant amount of time and effort. A remote diagnostic permits the technician to run and evaluate the operational readiness test and the system calibration program. This procedure informs the repair technician about a problem before leaving the central site and helps in preventive and corrective maintenance situations.

9-54. Spare Parts. The establishment of a spare parts inventory, whether at the component, subassembly, assembly, or unit level of maintenance, or at some combination of these, is a must. The depth of the spare parts inventory is governed mainly by the budget available and the failure history of the parts. However, false economies in the establishment and maintenance of a spare parts inventory can result in significant costs in manpower and lost system availability. At all but the component level of repair, it is far more economical for the person troubleshooting a problem to "swap out" a suspected faulty part than to take the time to isolate the malfunction with elaborate test equipment. The decision on what should be included in the initial inventory of spare parts to support a data acquisition system should be made based upon a combination of each equipment manufacturer's recommendation; the known history of the equipment, if available; and experience gained in maintaining similar equipment.

9-55. Test Equipment.

a. The choice of test equipment depends largely upon the level of maintenance to be performed. For assembly or unit level of maintenance, where diagnostic software and operational readiness tests are used to locate an inoperative unit, only the very basic test equipment is required. A complete electronic technician's tool kit, which includes a hand-held multimeter and a data communications tester, is sufficient.

b. For subassembly- or module-level maintenance, several more sophisticated pieces of test equipment are required in addition to those previously specified. These tools are shown in Table 9-3. Most of these repairs are done at the regional or central repair facility. *

* 9-56. Training.

a. Training is a basic requirement regardless of maintenance philosophy. An untrained technician can cause more delay and damage than there is actually present. There are several levels and types of training. The most basic level of training is knowledge of unit "swapping".

Table 9-3.

Necessary Maintenance Test Equipment.

<u>Assembly/Unit Level Repair</u>	<u>Subassy/Module Level Repair</u>	<u>Component Level Repair</u>
1. Complete ET tool kit	1. All of Assembly level equipment plus	1. All Assembly and Subassy level equipment plus
2. Hand-held VOM	2. Portable 35-MHz dual-trace oscilloscope	2. Bench type 100-MHz oscilloscope
3. Data communications tester as appropriate	3. Bus exerciser/analyzer (type depends upon bus)	3. Logic analyzer (time & logic state)
	4. Portable voltage standard	4. Microprocessor troubleshooter
	5. Digital multimeter	5. One of each unit to be maintained to be used as a test fixture for troubleshooting & verifying repair
	6. Master skew tape & master output tape for systems using magnetic tapes	
	7. Disk exerciser, alignment disk, & scratch disks for systems having disk drive units	

b. Of primary importance, the technician should be able to remove and apply source power to the system and to the individual units that make up the system. The second item is how to load and unload the storage media, magnetic tapes, or disks. This includes performing the actual physical act and informing the system that the recording media is replaced. Also, the first level maintenance technician should know all system operator functions for the specific system, as well as preventive maintenance functions. For a computerized system, the operator/technician also needs to receive training on the software operating system, system operating corn- *

* mands, the system operational readiness test, calibration programs, and hardware diagnostic programs.

c. The second level of training should cover assembly and subassembly level of repair. This requires an electronic technician who has received training in the fundamentals of electricity, basic electronics, digital theory, use of general electronic test equipment, and the fundamentals of computer systems and peripherals. Specific unit level training should cover special alignment, adjustment, field calibration procedures and use of diagnostic software for each unit.

d. The final level of repair, circuit component isolation and replacement requires the theory of operation of all electronic circuits and electromechanical and mechanical components in each unit. Advanced-level training in electronics, digital theory, computer systems, and in the use of advanced-level electronic test equipment should also be given.

e. System maintenance training, regardless of the level, must be customized for the specific system. The simplest and by far the most economical method of conducting this type of training, especially when turnover of personnel is high, is by the use of video training tapes. This method of training is also ideally suited to both preventive and corrective maintenance procedures. It allows the viewer to see the procedure actually being performed, and demonstrates techniques in minutes that would take chapters in a manual to describe.

f. The most formal and overall the most expensive type of training is the manufacturer's factory school. It generally takes place at the equipment manufacturer's facility. It is normally taught by a trained professional instructor and normally delves deeply into the theory of operation of the equipment. If the course includes laboratory time, actual hands-on training accompanies the theory training. This type of training also requires the loss of availability of the technician(s) for the duration of the course.

Section XI Retrofitting

9-57. Definition. In terms of instrumentation automation, retrofitting represents any effort to modify existing instruments so that they may be monitored completely under automated control, or such that the modification will aid instrumentation personnel in collecting the instrument data.

9-58. Need. The Corps has one of the largest investments in structural safety related and design related instruments in the entire country. Over the years, this investment has accumulated into the hundreds of millions of *

* dollars in instrumentation. Although some of these instruments are over fifty years old, they are still in working condition and still serving a useful purpose. Keeping these instruments working rather than replacing them is in the best interests of overall economy of the cost of maintaining a structure.

a. Retrofitting instrumentation that is already in place is beneficial in a number of respects. The cost of installing the instruments themselves is a large part of the cost of automating a monitoring task, making use of existing instrumentation, in this respect, will greatly reduce the overall cost of any automation operation.

b. The conditions under which the retrofit will be made bear heavily on the decision to proceed in this direction. If the instruments, or the structure in which they are installed only have a limited remaining useful life, then retrofitting will provide the needed benefits at the smallest cost. Installation of new instruments usually would not be economical.

9-59 Degrees of Retrofit. With the large diversity of instruments which the Corps uses, it is impossible to be able to apply retrofitting techniques to all of them. Some currently installed instruments, such as the inexpensive crack and joint measuring devices (Monolith joint displacement indicator, Relative movement indicator, Ball-n-box gage, scratch gage, etc.) cannot be retrofitted, or would be prohibitively expensive to do so. These instruments cannot be automated, and should be replaced with instruments which lend themselves to automation if the action is necessary.

a. Other instruments can be automated, but in order to use them the physical presence of an operator is necessary. A typical example of this class of instrument is the optical plummet. The method of reading an optical plummet requires an operator to sight, through the plummet telescope, at a target somewhere along the length of the vertical plummet shaft. In order to make the reading the operator must move the telescope to coincide with the center of the target. The movement of the telescope is then recorded. At present there is no mechanism which can determine that the telescope is aligned with the center of the target; and as such, an operator is necessary. However, there are electronic recording devices which can record the changes in movement of the telescope which the operator has made, and thereby help the operator make accurate measurements, help eliminate misrecorded data, and generally speed up the data collection process. These types of changes to a manual data collection system will partially automate the process.

*

- * b. The majority of the instruments used by the Corps produce some form of electrical output which can be measured by an electronic recording device. In most cases, these types of instruments can be fully automated by the addition of electronic data acquisition equipment, and in certain cases, by mechanical apparatus which perform the duties of an operator.

9-60. Retrofitting Analysis. Before considering a retrofitting operation, an analysis of whether the instrument retrofitting would be more cost effective than purchasing new equipment should be made. Cost factors such as age of the equipment to be retrofitted, cost of peripheral equipment which must be purchased to make the retrofit possible, as well as their installation costs must be weighed against the cost of new equipment and their installation costs before a wise decision regarding automation can be made. It is also important to consider accuracy and resolution of the older instruments, frequency of the data collection operation, and the information which is needed about the structure before making the decision on how to proceed.

9-61. Necessary Components. Sections II, III, V, VI and VII of this chapter give detailed information about the components which must be put together to design an automated data acquisition system. Retrofitting is an identical procedure, except that the instrument to be automated already exists, and must be supplemented to automatically collect its measurement. All other components of the automation process remain the same.

a. With respect to instrument output, there are two types of instruments the Corps uses. Either the instrument produces a change which must be physically measured, or it produces an electrical response to the change being measured. As mentioned before, the electrical response type instruments can be completely automated. However, those instruments which require a physical measurement in order to get the final data, generally require the interaction of an operator. In the cases where it is not possible to replace the operator, either the gage must be replaced to one which can be automated, or a partial automation must be sought.

b. Gage replacement requires the abandonment of the old gages and installation of new gages which give an electronic signal as output. A typical example would be to replace a crack measuring gage which requires an operator, with a surface mounted strain meter that outputs change in resistance or change in signal frequency as a function of strain. This type of instrument could then be automated completely.

c. In the event that the instrument is not to be replaced, and a partial automation alternative chosen, the operator would still be necessary to make the reading of the gage. Generally, some type of

*

* electronic recording device which the operator could use as an electronic notepad would be used to aid in the automation. Rather than writing the measured output down on paper, the collected data could be entered into the electronic notepad. These types of devices can generally be programmed such that the information entered can be checked against historical data and a warning given if there are gross mismatches; or the data entered can be reduced to engineering values. The data which is now temporarily stored in the recording device can be electronically input into a computer in the engineering office through a standard serial or parallel interface.

d. Some instruments which require the presence of an operator come equipped with the capability to automatically store the data they collect. An example is some of the newer theodolites. These instruments must be aimed by an operator, but the output is automatically stored or transferred to a computer. This eliminates the mistakes which can be made in manually transferring the data to output sheets.

e. Partial replacement of some types of instruments which the Corps uses will allow them to be completely automated. The addition of a transducer which monitors some physical change and produces an electrical output can be used to automate an instrument. Piezometer standpipes are a typical example. Standpipe type cells may be measured by one of two methods. In one case, the water head at the cell is less than the elevation of the reading station. To retrofit this type of situation, a pressure sensor would be lowered in the standpipe to a level below the lowest expected water level. The pressure head on this sensor would then be an indicator of the elevation of the water in the standpipe.

f. The other method for measuring standpipe pressure may be used when a water pressure exists at all times at the reading station. Currently, dial type gages are used for measuring this pressure. The water pressure at this station may be diverted to a pressure transducer and the electrical output from the transducer monitored.

g. Those instruments which give electrical output, but were designed to be manually operated can be automated by devising a means of mechanically reproducing the actions supplied by the operator. For example, certain types of inclinometers are designed to be manually lowered down a casing and held at different elevations while an electrical signal is recorded. The first step in automating this type of instrument is to build a device which will lower (and raise) the inclinometer to predefined elevations at regular time intervals. A properly geared stepping motor attached to the reel containing the inclinometer cable could be devised which would lower the inclinometer into the casing. The stepper motor would halt the inclinometer at the predefined location and a signal could

EM 1110-2-4300
Change 1
30 Nov 87

* be sent to a data acquisition system to make a reading. The procedure would then be repeated until the entire casing had been read. This type of retrofitted instrument would be connected to a data acquisition system just as if it had been designed to be automatically monitored. *

APPENDIX A

SELECTED BIBLIOGRAPHY

"Manual for the Use of Strain Meters and Other Instruments for Embedment in Concrete Structures," by R. W. Carlson, Campbell, California, Fourth Edition, 1975.

"Measurement of Structural Action in Dams," by J. M. Raphael and R. W. Carlson, Berkeley, California, James J. Gillick and Co., Third Edition, 1965.

"Temperature Measurement in Engineering," by H. D. Baker, E. A. Ryder, and N. H. Baker, New York, John Wiley and Sons, Inc., 1953, Vol 1.

"Measurement of the Structural Behavior of Norris and Hiwassee Dams," by Tennessee Valley Authority, Division of Engineering and Construction, Aug 1950 (Technical Monograph No. 67).

"Measurements of the Structural Behavior at Fontana Dam," by Tennessee Valley Authority, Division of Engineering and Construction, Jun 1953, (Technical Monograph No. 69).

"Calculation of Stress from Strain in Concrete," by Keith Jones, Engineering Monograph No. 25, Bureau of Reclamation, 29 Oct 1961.

"Preparation and Installation of Special Measuring Instruments," by Tennessee Valley Authority, Engineering and Construction Department, Fontana Dam Division, (Unpublished report), 27 Nov 1945.

"Pressure Cells for Field Use," by US Army Corps of Engineers, Waterways Experiment Station, Vicksburg, Mississippi, Waterways Experiment Station, Jan 1955 (WES Bulletin No. 40).

"Structural Behavior Analysis of Monticello Dam for the Period September 1955 to September 1963," by L. H. Roehm, and Keith Jones, Technical Memorandum No. 622, with Appendixes I and II, Bureau of Reclamation, Sep 1964.

"Comparison of the Measured and Computed Behavior of Monticello (Arch) Dam," by M. D. Copen and J. T. Richardson, Question No. 29, Report 5, 8th Congress on Large Dams, ICOLD, Edinburgh, Scotland, 1964.

"Deformation Measurements of Flaming Gorge Dam," by L. H. Roehm, Proceedings, ASCE, Journal of the Surveying and Mapping Division, Vol 94, No. SU1, pp 37-48, Jan 1968.

"Technical Bulletin Series," Bulletins 16 through 23, Terrametrics Division of Earth Sciences, Teledyne Co., Golden, Colorado, 1972.

EM 1110-2-4300
Change 1
30 Nov 87

"Technical Record of Design and Construction, Glen Canyon Dam and Power-plant," by Bureau of Reclamation, pp 117-138 and 449-453, and p 464, Dec 1970.

"Technical Record of Design and Construction, Flaming Gorge Dam and Power-plant," by Bureau of Reclamation, 1968.

"Strain Meters and Stress Meters for Embedment in Models of Mass Concrete Structures," by H. G. Geymayer, Report No. 1, Summary of Information Available as of March 1967, TR 6-811, US Army Engineer Waterways Experiment Station, Vicksburg, Mississippi, Jan 1968.

"Investigation of Instruments for Measuring Pore Pressure in Concrete - Literature Review and Preliminary Laboratory Tests," by E. E. McCoy and E. C. Roshore, TR No. 6-654, Report 1, US Army Engineer Waterways Experiment Station, Vicksburg, Mississippi, Aug 1964.

"Investigation of Instruments for Measuring Pore Pressure in Concrete - Instruments Installed at Hartwell Dam, Georgia," by E. C. Roshore, TR No. 6-654, Report 2, US Army Engineer Waterways Experiment Station, Vicksburg, Mississippi, Mar 1970.

"Calculations of Deflections Obtained by Plumblines," Electronic Computer Description No. C-114, Bureau of Reclamation, 1961.

"Investigation of Temperature Stresses and Deflections in Flaming Gorge Dam," by L. H. Roehm, Technical Memorandum 667, Bureau of Reclamation, 1967.

"Measured Deformation Behavior of Glen Canyon Dam," by J. T. Richardson, Proceedings, ASCE, Journal of the Surveying and Mapping Division, Vol 94, No. SU2, pp 149-168, Sep 1968.

"Manual of Geodetic Leveling," Special Publication No. 239, Coast and Geodetic Survey, Department of Commerce, Washington, DC, 1948.

"Manual of Geodetic Triangulation," Special Publication No. 247, Coast and Geodetic Survey, Department of Commerce, Washington, DC, 1950.

"The Use and Calibration of Distance Measuring Equipment for Precise Mensuration of Dams," by Kenneth D. Robertson, Report No. ETL-0048, US Army Engineer Topographic Laboratories, Ft. Belvoir, Virginia, Mar 1976.

"Precise Dam Surveys, Los Angeles Flood Control District," by Don F. Keene, ASCE National Meeting on Water Resources Engineering, Los Angeles, California, 21-25 Jan 1974.

"Development of a High Precision Capability for Monitoring Structural Movement of Locks and Dams," by Kenneth D. Robertson, Report No. ETL-0121, US Army Engineer Topographic Laboratories, Ft. Belvoir, Virginia, Sep 1977.

"Report on Monumentation, Techniques, Equipment, and Installation," US Army Engineer District, Nashville, Corps of Engineers, Jul 1974.

"Structural Behavior Measurements on Concrete Gravity Dams," J. A. Rhodes, Question No. 29, Report 7, 8th Congress on Large Dams, ICOLD, Edinburgh, Scotland, 1964.

"Cracking in Norfork Dam," by F. W. Sims, J. A. Rhodes, and R. W. Clough, Journal of the American Concrete Institute, Vol 61, No. 3, Mar 1964, pp 265-285.

"Glotzl Pressure Cells," Bulletin on Terrametrics, by Terrametrics, Inc., Golden, Colorado.

* "Instrumentation Automation for Concrete Structures, Report 1, Instrumentation Automation Techniques", by John Lindsey, et. al., Technical Report No. REMR-CS-5, US Army Engineer Waterways Experiment Station, Vicksburg, MS, December 1986

"Instrumentation Automation for Concrete Structures, Report 2, Automation Hardware and Retrofitting Techniques", by Aubrey Keeter, et. al., Technical Report No. REMR-CS-5, US Army Engineer Waterways Experiment Station, Vicksburg, MS, December 1986

"Instrumentation Automation for Concrete Structures, Report 3, Available Data Collection and Reduction Software", by Brian Currier and M. H. Fenn, Technical Report No. REMR-CS-5, US Army Engineer Waterways Experiment Station, Vicksburg, MS, December 1986

"Transducer Interfacing Handbook," edited by D. H. Sheingold, Analog Devices, Inc., Norwood, MA, 1980.

"Transducers, Sensors, and Detectors," by R. G. Seippel, Reston Publishing Company, Inc., Reston, VA, 1983.

"Instrumentation Fundamentals and Applications," by R. Morrison, John Wiley and Sons, New York, 1984, p. 90.

"Instrumentation and Control Systems Engineering Handbook," by the editors of Instrument Technology, TAB Books, Blue Ridge Summit, PA, 1978.

EM 1110-2-4300
Change 1
30 Nov 87

* "Electronic Communications Systems," by G. Kennedy, McGraw-Hill, New York, 1970.

"Reliability and Quality Assurance Publication," National Aeronautics and Space Administration (NASA), NHB 5300.4(1(Z), July 1971 Edition, par 1C302. *

APPENDIX B

SPLICING TECHNIQUE

B-1. General. Splices should be avoided if at all possible. They are sources of deterioration, error, and additional work in the installation of any electrical work. To avoid their use, the meters should be purchased with adequate lengths of cable attached at the factory by the manufacturer. This method is faster and takes advantage of the laboratory like conditions that are available for attaching cable to meters at the factory.

B-2. Personnel. Splicing should be done by experienced instrumentation personnel who are familiar with the instruments to which the wires are to be spliced. Since the splice is generally to be embedded in concrete, it must be done correctly the first time and done in a manner that will last the lifetime of the structure. For these reasons it is recommended that experienced instrumentation personnel perform the splice.

B-3. Splicing Operation. Making the splice to attach the added cable lead to the instrument is an important and exacting operation, but not necessarily complicated or difficult. In making a splice three primary objectives must be achieved; first, the individual conductors must be properly matched and securely connected to insure proper functioning of the electrical circuits; second, the soldered connection of individual conductors must not deteriorate chemically during the life of the embedded instrument; and third, the splice must be moisture-proof. The aluminum pipe splice is considered the most satisfactory method for producing permanently moisture-proof splices. In order to realize the objectives stated above, the following step-by-step procedures should be observed. To accomplish the desired results, the materials and working conditions must be clean, since dust, dirt, oil, or grease on the splicing components will likely prevent proper electrical connections.

Step 1. Remove the cable sheath on the lead to be added and on the lead attached to the instrument for 4 in. and stagger the individual conductors by 1-in. lengths as shown in view 1 on Figure B-1 so that the finished conductor splices will not overlap. In removing the sheath take care not to cut or otherwise damage the insulation on the conductors.

Step 2. Slip a Pyle-National cord and Cable Grip assembly over the lead coming from the instrument, and an identical assembly along with a piece of threaded aluminum pipe over the other lead of the cable. The aluminum pipe should be of sufficient length and diameter to house the entire wrapped splice and the Pyle-National Cord and Cable Grip should be sized with a grommet to fit the cable and have diameter and threading to fit the aluminum pipe. This connector assembly is available from Pyle-National Company, 1334 North Kostner Avenue, Chicago, Illinois 60651.

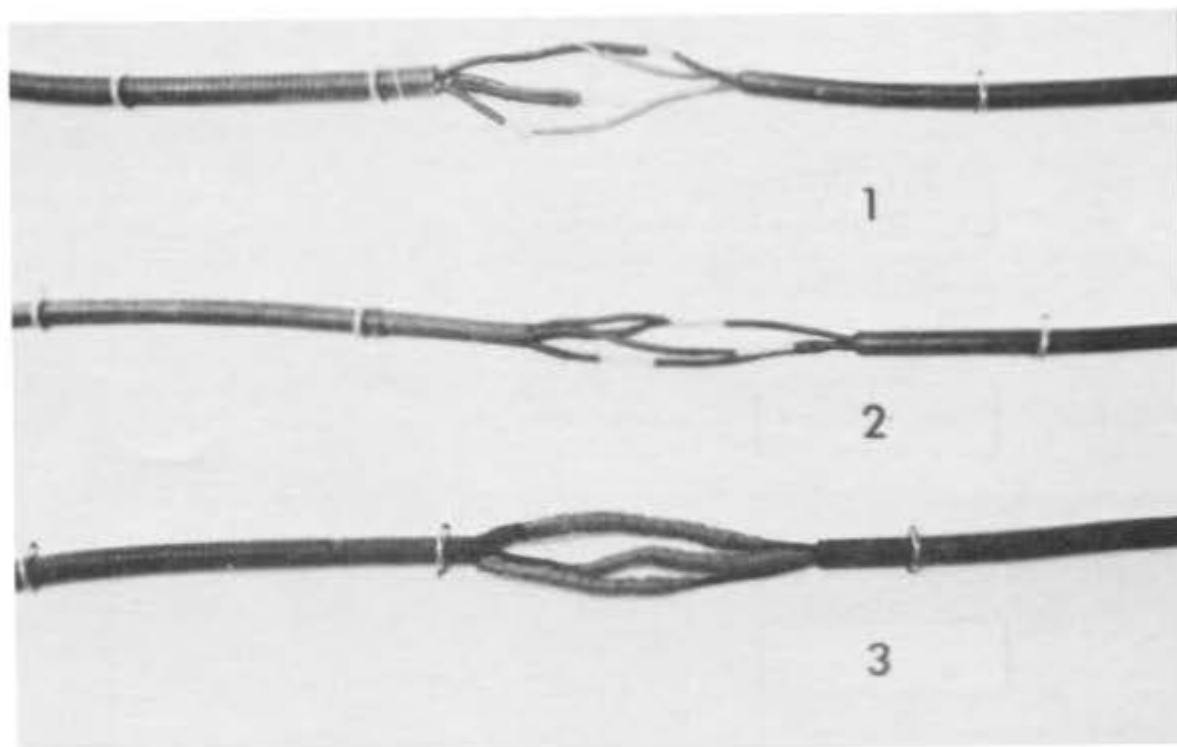

Figure B-1. Interior Stages of Splice. (Photo by WES)

15 Sep 80

Step 3. Strip 1/2 in. of insulation from each conductor, taking care not to cut any of the strands or otherwise damage the conductors.

Step 4. Tin the stripped ends of each conductor by dipping melted solder using a rosin flux. Because of subsequent corrosive effects, acid-fluxed solder must not be used.

Step 5. Connect the conductors by sweating on telephone connectors or soldering sleeves as in view 2 of Figure B-1.

Step 6. Wash soldered splices thoroughly with 1, 1, 1-trichloroethane.

Step 7. Coat the individual conductors (exposed insulation and splice) with Joy Manufacturing Co. No. 319756-3 bonding cement, available from Joy Manufacturing Co., Route 4, Box 156, La Grange, North Carolina 28551.

Step 8. After the cement has become tacky, wrap each individual conductor with a single layer of half-lapped prevulcanized gray insulating rubber (Joy Manufacturing Co. No. 319776), lapping well over the original insulation at each end of the wire splice. Cover with one layer of rubber tape to hold the insulating rubber in place as in view 3 of Figure B-1.

Step 9. Twist the splice slightly, group the conductors into shape, and bind together with a single layer of Joy Manufacturing Co. rubber tape. Slip the length of pipe along the cable until the spliced joint is positioned midway between the ends of the tube.

Step 10. Move the two Pyle-National Cord and Cable grips over the cable to the ends of the pipe and attach them to the pipe. Tighten the connectors securely such that the pipe becomes a watertight chamber containing the splice. The end fittings and grommet should grab the electrical cable such that the pipe will not slip with respect to the cable and that any tensile stress put on the cable will be transferred across the splice through the pipe and not the splice itself. Figure B-2 shows the completed splice.

B-4

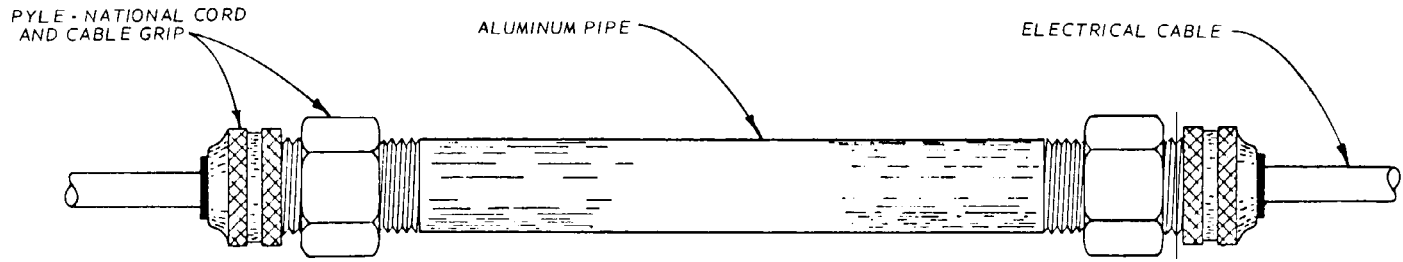

Figure B-2. Completed Aluminum Pipe Splice. (Prepared by WES)

15 Sep 80

APPENDIX C

EMBEDMENT TECHNIQUES FOR
CARLSON TYPE TRANSDUCER INSTRUMENTS

C-1. General. The following techniques are those that should be followed to insure an adequate installation of Carlson type transducers.

C-2. Strain Meter. A successful strain meter installation requires that each meter be aligned with reference to the structure axis or center-line as specified on the drawings, and that the concrete surrounding the meters be identical with that in the remainder of the structure. Obviously these goals cannot be achieved completely, but every effort should be made during placement operations to satisfy the conditions so far as practicable.

a. Single Strain Meters. Single strain meters are usually embedded near the top of a lift. In this case let the lift be topped off and the placing crew move away.

Step 1. Dig into the area for the full depth of the instrument and discard all aggregate over 3-in. size.

Step 2. Backfill sufficiently to provide a bed for the instrument.

Step 3. Make a hole for vertical or diagonal meters, using an electric laboratory vibrator or by driving a pointed 1-1/2-in. diameter steel pipe into the backfilled concrete, and insert meter in the hole. Horizontal meters are merely laid flat on the prepared bed.

Step 4. Check angles, direction and depth, using the machinist's protractor and level, held against the end flange.

Step 5. Carefully vibrate or hand-puddle around the meters. If job vibrators are used, care should be taken to avoid violent or excessive vibration which might disturb the meter alignment or overvibrate the backfilled concrete.

Step 6. Complete backfilling by hand with 3-in. maximum aggregate concrete, and hand-puddling up to grade.

b. Interior Groups of Meters. More elaborate preparations and facilities are required on interior groups of meters to assure proper installations in the limited time available before the concrete attains its initial set. It is desirable that prior to the time concrete is placed in the intended meter location the meters be brought into the block and grouped according to their arrangement in the monolith, and that tools, equipment, templates, and spare meters be placed in a conveniently accessible location. One procedure for placement of a meter group is as follows:

Step 1. Place the temporary block-out frame on top of the lift concrete when it has reached an elevation about 12 in. below final grade.

Step 2. Finish off remainder of lift outside the frame.

Step 3. Explore the bed with shovels and remove cobbles over 3 in. in size to a depth of 4 in.

Step 4. Set template, using survey points previously marked, and place meters in approximate location, running cables out beneath block-out frame and template.

Step 5. Using an electric laboratory vibrator or a pointed 1-1/2-in. diameter steel pipe, punch holes at the proper location in the prepared bed to receive the vertical and inclined meters. The holes should be made sufficiently deep so as to contain all but about 2 in. of the instrument, and the instrument checked for vertical or slope by placing the protractor level across the flanged end of the meter. The space between the meter case and the sides of the hole is carefully filled with stiff concrete containing little or no coarse aggregate, and thoroughly compacted. Inclination of the meter should be checked with the protractor during this operation. Horizontal meters are placed in their proper location on top of the prepared bed and aligned and levelled. This is the stage of the installation shown in Figure C-1.

Step 6. Cover each instrument immediately with hand-placed 3-in. maximum aggregate concrete until a 3-in. thick cushion is built over and around each meter.

Step 7. After the concrete has been allowed to stiffen slightly, remove the template and block-out frame, and fill the remainder of the hole with regular fresh concrete. The concrete should not be dumped or thrown into the hole, but should be placed carefully with shovels to avoid disturbing the embedded meters or damaging them.

Step 8. After the hole is filled, it may be lightly vibrated or hand-puddled to consolidate the covering concrete, extreme care being taken to avoid walking over the area or otherwise disturbing the instruments. A board cover or barrier will serve to protect the area during the lift exposure period.

c. Alternate Procedure for Interior Groups. A second procedure for embedding strain meters, particularly useful for groups of 10 or more instruments, involves the use of a special spider mounting frame, Figures C-2 and C-3, which simplifies alignment of the meters. Details are as follows:

Step 1. Level off a concrete bed 2 ft below the ultimate elevation of the lift.

Step 2. Mark the meter group location with a light board framework and finish up the lift around this location.



Figure C-1. Strain Meter Group Ready to be Covered (Courtesy of the Bureau of Reclamation).

Step 3. Make final assembly of strain meters on the spiders on a plywood or wood working platform nearby the location, and lay out and bunch cables ready for embedment.

Step 4. Explore the levelled-off bed with shovels and remove cobbles over 3 in. in size near the bedding surface. Consolidate lightly with vibrator.

Step 5. Place spider and attached meters in position, and check orientation and level.

Step 6. Carefully place concrete by hand around meters, and hand-puddle or carefully vibrate within the spider with a small laboratory vibrator. As covering of the meters begins, the shoulders of the surrounding finished lift should be lightly vibrated to avoid the possibility of sudden sloughing of the sides onto the spider assembly.

Step 7. Erect a protecting wood barrier to protect the area during the lift exposure period.

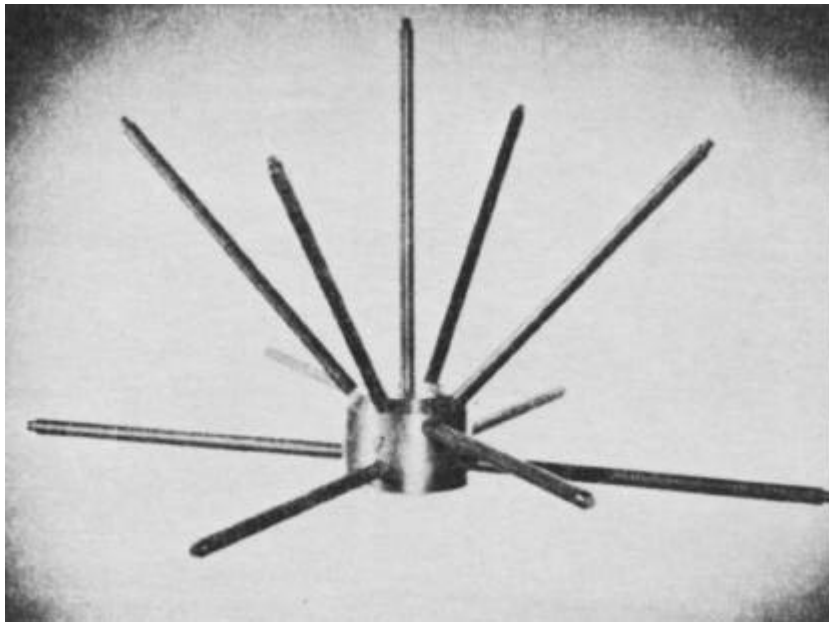

Figure C-2. Carlson Strain Meter Spider. From "Measurement of Structural Action in Dams" by J. M. Raphael and R. W. Carlson.



Figure C-3. Strain Meters Mounted on Spider (courtesy of the Bureau of Reclamation).

d. Surface Strain Meters. Boundary groups, or surface strain meters, consist of several meters (from three to six) placed at distances varying from 3 in. to 3 ft from a surface of the structure with each meter arranged parallel to the concrete face and in a vertical plane. The positioning of the meters at the required distance from the face, in a vertical plane and at the proper slope can be satisfactorily attained by utilizing special pipe brackets bolted or fastened to the top of the forms. A set of such brackets in place ready for concreting is shown in Figure C-4. Each bracket holds a length of 1-1/2-in. pipe, swedged shut at the bottom end, at the proper distance from and parallel to the form surface. When the concrete is placed, as in Figure C-5, each pipe forms a hole slightly larger than the meter diameter. A shallow hole about 8-in. deep is dug around each pipe; and after the concrete has stiffened slightly the bracket screws are removed, the pipes pulled out and the meters placed in the holes. The space between the meter case and the sides and bottom of the hole is filled with mortar and carefully tamped to insure complete contact with the instrument. Figure C-6 shows the installation at this stage, The depressions around each meter are brought up to grade by carefully placing concrete with shovels and hand-tamping. A board cover or barrier will protect the area while the concrete is hardening.

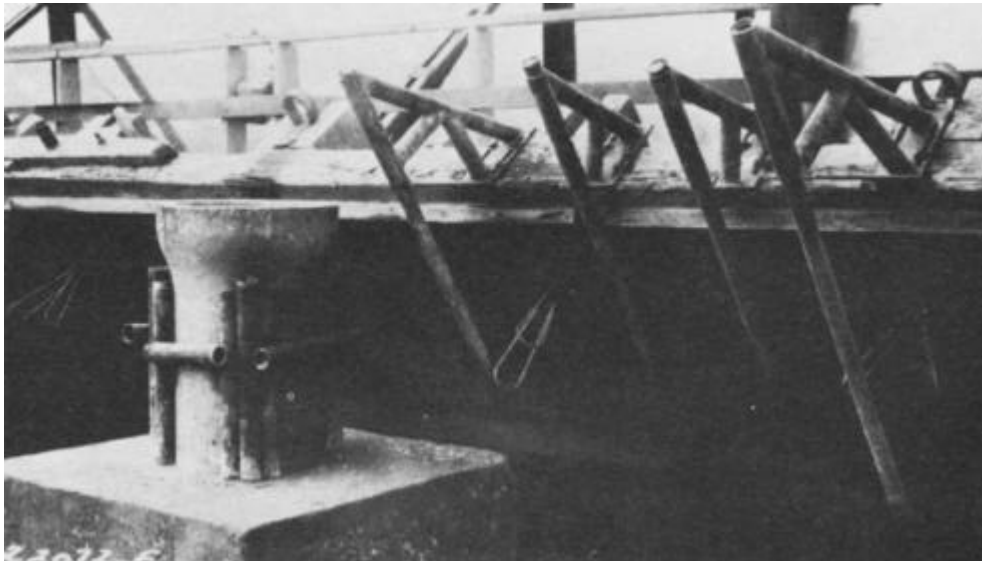

Figure C-4. Pipe Brackets for Locating Boundary Strain Meters - Prior to Placing Concrete (courtesy of the Tennessee Valley Authority).



Figure C-5. Pipe Brackets for Locating Boundary Strain Meters - After Concrete is Placed (courtesy of the Tennessee Valley Authority).



Figure C-6. Boundary Strain Meters in Place (courtesy of the Tennessee Valley Authority).

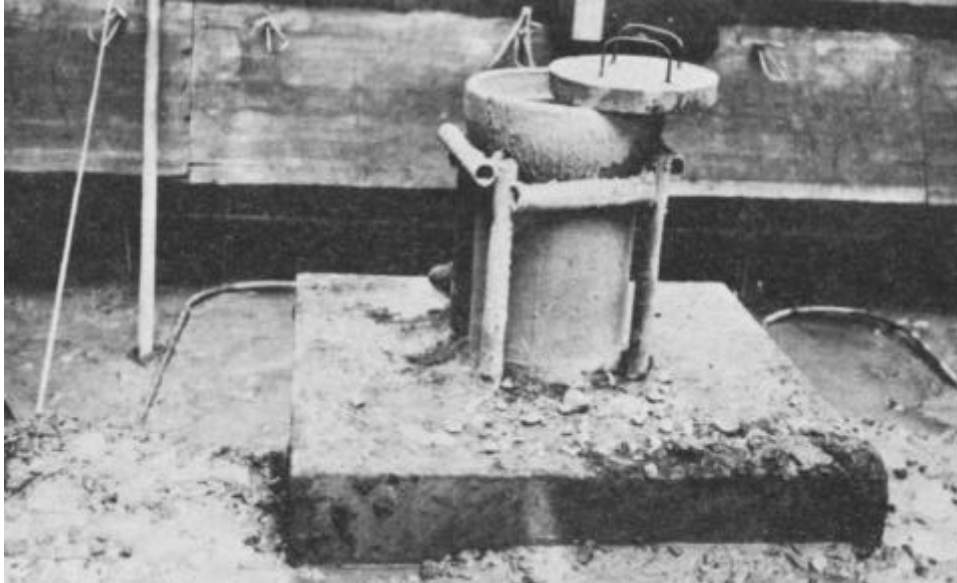

Figure C-7. No-Stress Test Specimen Pipe Containter (courtesy of the Tennessee Valley Authority).

C-3. "No-Stress" Strain Meters.

a. Purpose. For the purpose of measuring independently the volumetric effects of temperature and moisture changes and chemical action within a large structure, "no-stress" strain meters are frequently provided in conjunction with strain meter groups. This can be accomplished by embedding an ordinary strain meter in typical mass concrete which is isolated from deformations due to loading, but is responsive to the temperature, moisture, and growth changes prevailing in the mass concrete of the structure.

b. Typical Installation. One arrangement, used successfully on previous installations, is to provide a cavity in the lift near the strain meter group by embedding a 3- or 4-ft length of 15-in. diameter concrete pipe so that the flange extends about 3 in. above the lift surface. A concrete pedestal is constructed around the bottom of the pipe to support it and hold it in place during placement of the concrete lift, and a precast concrete cover is provided. The pipe and upper portion of the pedestal are shown in Figure C-7. The strain meter is suspended in the center of a 12- by 24-in. cylinder specimen mold (of a type which will permit easy stripping), and the mold filled with fresh concrete taken from a typical lift batch adjacent to the strain meter group. The 12-in. diameter mold permits the use of up to 3-in. aggregate concrete, so that the no-stress cylinders will closely represent the concrete in the lift. At locations where 6-in. aggregate concrete is being used, cobbles larger than 3 in. are removed from the concrete placed in the cylinder mold. Figures C-8 and C-9 show details of the no-stress cylinder cavity. The day after the cylinders are cast, the molds are removed, the cavity cleaned and water removed, the cylinder placed in the cavity, and the precast cover placed and sealed.

c. Alternate Installations. A second scheme, used by the Bureau of Reclamation, is to embed two strain meters, one vertically and one horizontally, near the top of a concrete lift, and then place a 3-ft diameter 3/8-in. thick steel plate over the lift surface. The plate is held 2 or 3 in. above the concrete surface by a circumferential rim or lip, which isolates the meters from the effects of vertical load. The length change indicated by the vertical meter includes the deformation resulting from the horizontal strains modified by Poisson's ratio, while the horizontal strain meter aids in the evaluation of the Poisson ratio effect. A third scheme, developed by Serafim, involves the use of a double-walled, double-bottom copper container which serves to protect the concrete containing the meter from strains due to load, yet provides continuity of the concrete so that other volumetric changes may take place without restraint.



Figure C-8. No-Stress Meter Cylinder with Mold Partially Removed
(courtesy of the Tennessee Valley Authority).

C-4. Joint Meter.

a. Arrangement. Whenever possible the joint meter installation should be so arranged that the meter unit and the cable lead are placed in a following block. While other arrangements are possible, they require more care in placement and frequently involve field splicing of the cable and/or special protection facilities for cable and meter. The most convenient location for the meters is from 6- to 10-in. below the top of a lift.



Figure C-9. No-Stress Meter Cavity and Cover (Courtesy of the Tennessee Valley Authority).

b. Meter and Cable in Following Block. The socket plug is nailed, with its slotted side against the form, to the interior surface of the form at the desired location, as shown in Figure C-10. The meter socket is then screwed onto the plug, completing the preliminary step in the meter installation, Figure C-11. A joint meter socket being covered by concrete in a leading monolith is shown in Figure C-12. Should it be found that the bond between the socket and surrounding concrete is not adequate to prevent displacement during form removal operations, short metal anchors may be welded onto the socket prior to placement. After concrete in the following block has been brought up to elevation of the joint meter location, remove about 1 sq ft of the fresh concrete to a depth necessary to expose the plug in the end of the socket embedded in the leading block. Remove the plugs as shown in Figure C-13 and insert the joint meter unit, screwing it in tightly, as in Figure C-14. The meter should then be manually forced into position which will provide sufficient available operational range in the meter to cover the magnitude and direction of the expected joint movement. Normally a completely closed position or a midrange position will be satisfactory. The initial meter position is determined by making ratio readings with the portable test set. Backfill with concrete around the meter, tamping carefully to obtain a good embedment without displacing the meter. Several boards laid on the completed lift surface at the meter location will serve to protect the installation until the concrete has hardened.



Figure C-10. Joint Meter Socket Plug (Courtesy of the Tennessee Valley Authority).



Figure C-11. Joint Meter Socket Screwed onto Plug (Courtesy of the Tennessee Valley Authority).



Figure C-12. Joint Meter Socket in Place (Courtesy of the Tennessee Valley Authority).

c. Meter in Following Block, Cable in Leading Block. When it is necessary or desirable that the cable lead be located in the leading block, the most satisfactory arrangement is to embed the required length of cable (prior to attachment to the joint meter) in the lift immediately above that containing the meter socket, terminating the cable end to be attached to the instrument in a 1-ft square block-out near the socket location. At least 5 ft of free cable should be coiled into this recess. After the meter unit is installed, as described in the preceding paragraph, the short cable lead attached to the instrument is run vertically to above the lift surface, and concrete is carefully placed around the meter unit. The following day, after the concrete has hardened, the short instrument lead projecting above the lift surface is joined to the free end of the previously embedded cable with a wrapped field splice. Since the embedded cable crosses a contraction joint, provision must be made at the crossing point to permit the embedded cable to accommodate the expected differential monolith movements. This is done by coiling one or two loops of slack cable in the block-out, and providing a cover for the recess when concrete is placed in the adjacent lift. Figure C-15 shows the meter and cable arrangement for this scheme.



Figure C-13. Embedded Joint Meter Socket with Plug Removed (Courtesy of the Tennessee Valley Authority).



Figure C-14. Joint Meter Unit Screwed into Socket (Courtesy of the Tennessee Valley Authority).

15 Sep 80

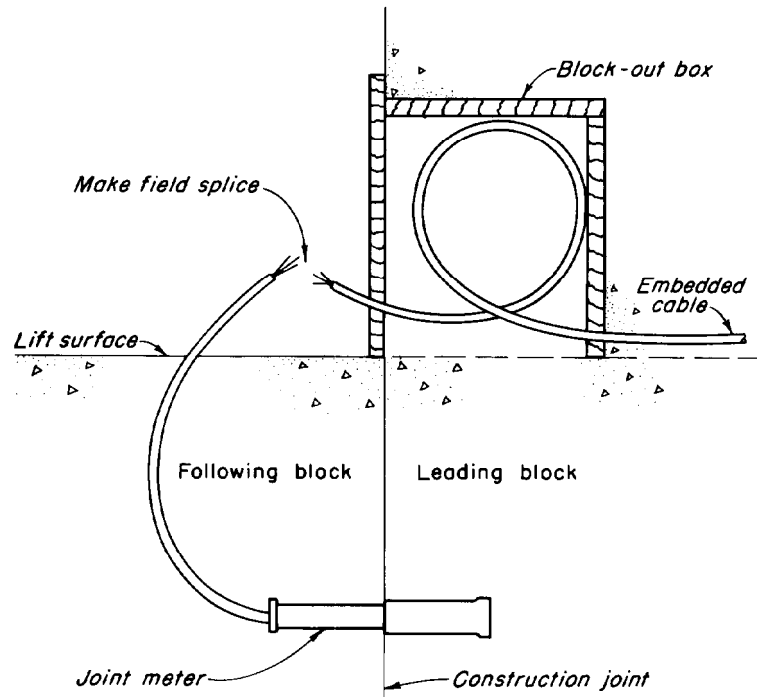

Figure C-15. Joint Meter in Following Block, Cable in Leading Block.
(Prepared by WES)

d. Meter and Cable in Leading Block. The necessity for field-splicing the instrument cable in the following block to the embedded cable in the leading block can be avoided by turning the joint-meter end-for-end and embedding the meter unit and cable lead in the leading block and the socket in the following monolith. To accomplish this, a hole slightly larger in diameter than the meter case at the bellows section is drilled through the lift form of the leading monolith at the desired location, and the meter unit inserted for one-half its length with the cable end inside the forms. The socket is screwed onto the end of the meter projecting from the exterior face of the form, and fastened to the exterior of the form so as to hold the meter securely during concrete placement. The socket is removed to permit form removal, which must be done carefully to avoid displacing the partially embedded meter. The socket is then replaced, and suitable provisions made to protect the projecting socket during subsequent operations. While this procedure eliminates the field splice, considerable opportunity exists for damage to the sensitive meter unit during form removal operations and during the period while concrete is being placed in the following block.

15 Sep 80

C-5. Stress Meter.

a. Embedment Procedure. Proper and satisfactory operation of the stress meter is dependent almost entirely upon obtaining a perfect contact between the meter plate and the adjacent concrete. An embedment procedure, to be acceptable, must avoid the formation of air pockets and eliminate so far as practical the collection of water beneath the meter which always occurs during bleeding.

b. Meter on Horizontal Plane. Placement of the stress meter in horizontal (stem vertical) and diagonal (stem sloping) positions may be accomplished by providing a hole or depression in the top of the lift, as shown in Figure C-16 and bedding the meter the following day after the lift concrete has hardened. The complete step-by-step procedure recommended is as follows:

Step 1. Prior to starting concrete placement in the lift, the meter and about 4 ft of attached cable is placed in a wooden box only slightly larger than the plate and about 12- to 15-in. deep. When concrete has reached an elevation about 12 in. below the top of the lift, the box containing the meter is placed at the desired location, and lift placement completed. The meter cable leads are placed and buried during this period in the usual manner, except for the 4 ft of surplus cable which remains in the box. This cable slack is necessary in order to allow some freedom in placing the meter during embedment operations.

Step 2. When the lift has been completed, the box containing the meter is removed from the concrete and a conical cavity left in the lift surface. The side slopes and bottom should be sloped or levelled as required, and left in a reasonably smooth plane condition. Avoid excessive trowelling or floating. A diagrammetric sketch of a prepared cavity, with 45° slopes suitable for diagonal meters, is shown in Figure C-16. The boxed meter is replaced in the cavity, and a heavy wooden box or cover is placed over the hole to protect against damage.

Step 3. The following day, after the concrete has hardened, the hole is cleaned to remove all laitance and loose material so as to provide a good bond with the new concrete. The areas upon which the meters are to be placed should be chipped to remove projecting corners of aggregate, and wire brushed to expose a good bonding surface. All water should be removed from the hole, and provisions made to prevent curing water from entering the cavity during the meter placement operation.

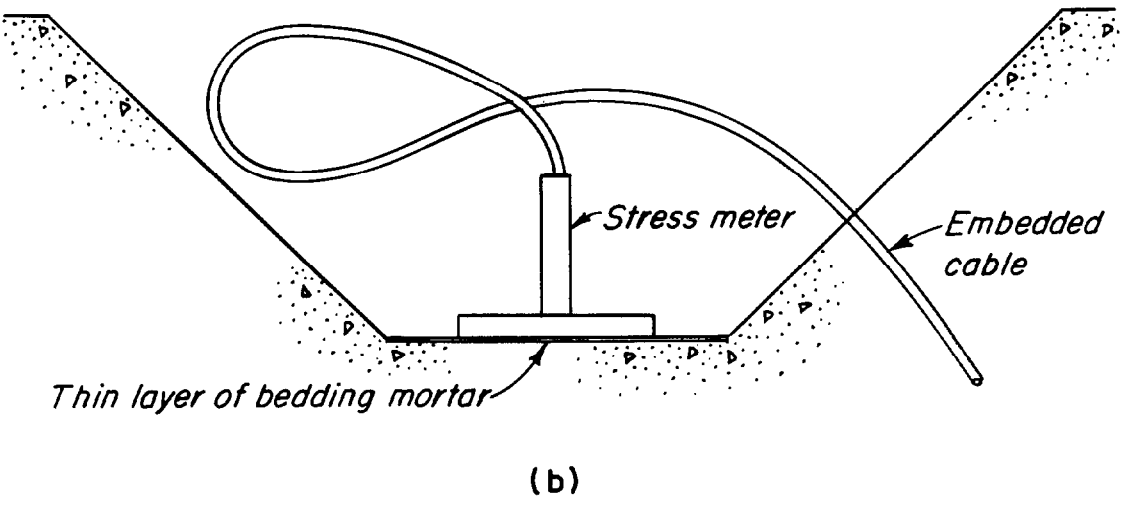
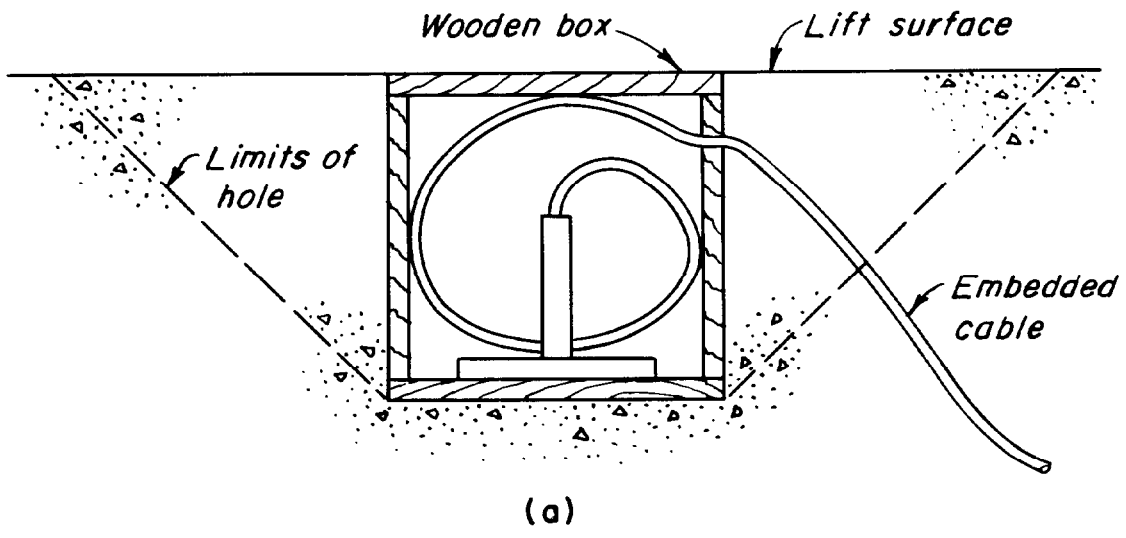

Figure C-16. Cavity in Lift Surface for Installation of Stress Meter.
(Prepared by WES)

15 Sep 80

Step 4. About 1 hr before placing the stress meter, a sanded grout is prepared, consisting of 80 g of cement and 120 g of sand passing the No. 30 sieve with only enough water to produce a plastic consistency. It is recommended that one or more trial mixes be made to establish the amount of water required for the mortar. Just before placing the meter, a thin film of grout, made by adding water to a small amount of the prepared mortar, is brushed over the smoothed concrete surface in order to dampen and lubricate it. The remaining mortar is reworked without additional water, placed on the dampened surface where the meter is to be located, and shaped into a rough cone. Then, with a reciprocal rotary motion, the meter is pressed down on this mortar cone causing it to squeeze outward and appear around the rim of the meter. The mortar bed, after the meter has been pressed into its final position, should be not more than 1/8 in. in thickness (preferably 1/16 in.). Weights totaling 15 to 20 lb should be uniformly distributed over the upper surface of the meter plate, as shown in Figure C-17, to hold the meter in close contact with the mortar. A small tripod table carrying the proper weight load has been found convenient and assures a uniform applied pressure.



Figure C-17. Stress Meter in Place (Courtesy of the Tennessee Valley Authority).

Step 5. After the mortar has set slightly (from 2 to 3 hr), fresh concrete similar to that in the remainder of the lift should be carefully placed in thin layers and thoroughly hand-compacted. The tripod and weights may be removed after the first or second layer has been placed. Care should be taken in placing the concrete to avoid displacing the meter. After the hole is completely back-filled, it should be covered with a layer of boards for protection until the concrete has hardened. Normal curing operations should be resumed as soon as the fresh concrete has hardened sufficiently.

c. Meter on Vertical Plane. Placement of stress meters in a vertical position (stem horizontal) is done in fresh concrete of the lift and presents no difficult problem. After concrete placement in the lift has been completed, a hole about 12 in. in depth is dug at the meter location. The meter is laid in place and concrete, with the large cobbles removed, placed in thin layers around the instruments and thoroughly tamped into place, as in Figure C-18. Alignment and position of the meter should be checked and maintained during placement of the concrete backfill. A temporary board cover over the meter location will protect the installation until the concrete has hardened.

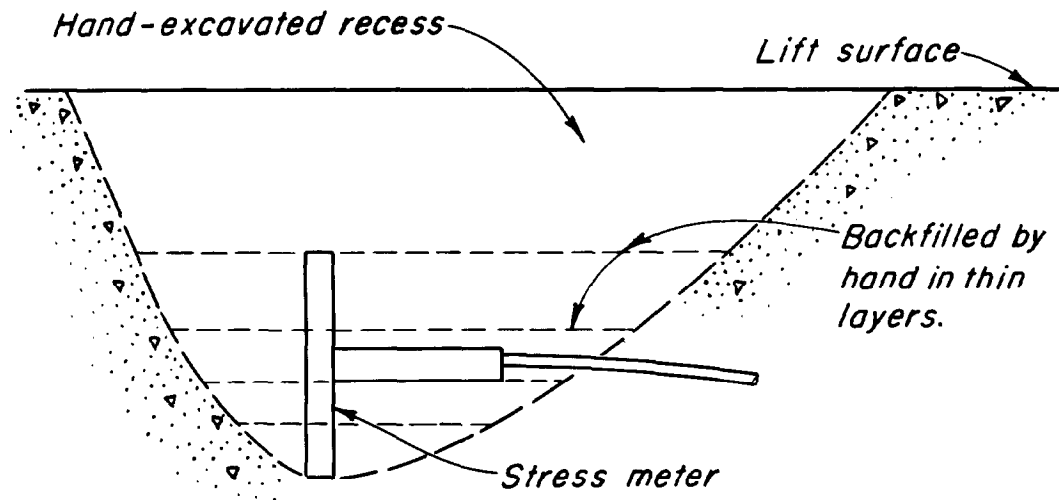

Figure C-18. Position of Stress Meter for Measuring Stress on Vertical Plane. (Prepared by WES)

15 Sep 80

C-6. Pore Pressure Cell. The pore pressure cells are usually located near the top of a lift, where placement can be accomplished after concreting in the area has been completed. A hole just large enough to accommodate the instrument and about 12 in. deep is dug at the desired location. The meter is laid horizontally in the hole, normal to the exterior surface of the concrete, and with the porous plug at the desired distance from the water-concrete contact plane. Frames or brackets to hold the meters in position during embedment should not be used, since they would possibly provide a leakage path directly to the cell. Concrete is placed by hand around the instrument and tamped sufficiently so as to obtain a good contact between the body of the meter and the surrounding concrete. Avoid excessive tamping or working of the concrete which would result in a highly impermeable zone around the meter and adversely affect the normal buildup of hydrostatic pressures being measured. Where several cells are located in a lift at different distances from the water-concrete contact surface, the meters should be arranged in echelon formation, at least 3 ft apart, in order that the instruments near the surface will not interfere with the development of hydrostatic pressures at the instruments farther from the face. After embedment, a temporary cover of boards laid over the meter locations will afford protection until the concrete has hardened.

C-7. Resistance Thermometer.

a. Instrument Location. Embedment of the resistance thermometer is a simple procedure since orientation is usually not important and careful placement of concrete around the meter is not a requirement. When the location of the instrument relative to the top or bottom of a lift is not important, the thermometer is simply laid in a shallow (6 or 8 in.) hole, covered immediately by shovelling or pushing fresh concrete over it and the area lightly vibrated. Installation of several thermometers or thermometer groups on a single horizontal plane within a lift is most easily done by placing them at the bottom of the lift. The meters should be taped or tied securely by means of wires or wire loops embedded in the top of the previous lift at approximately the proper locations.

b. Spacing. For accurate spacing of thermometers at various heights in a lift, the meters may be taped to a pole or rod which is embedded in the previous lift or otherwise maintained in a vertical position. Wood poles or 1/2-in. diameter bakelite tubes are recommended because of their favorable thermal properties. Other materials of low heat conductivity may be satisfactory, if in the form of thin-walled tubes. Reinforcing bars should not be used for this purpose.

c. Locations near Exposed Surfaces. Thermometers located within approximately 3 ft of exposed concrete surfaces or bulkhead faces subject to daily temperature variations must be placed accurately at their intended distance from the surface or face. Instruments must be secured firmly in position in some manner, since the placement of adjacent fresh concrete and manipulation of the vibrator equipment frequently will cause a relatively large displacement of a "free-floating" thermometer. The preferred method is to embed tie wires in the surface of the previous lift, place the thermometers on the hardened concrete lift surface and fasten them securely in their proper location by means of the tie wires. A second method, used when it is desired to place the thermometers within a concrete lift, consists of a light-weight bracket of low heat conductivity material fastened to the interior form surface holding the thermometer at the desired distance from the form. Care is required in removing the forms and detaching the brackets therefrom to avoid dislodging the embedded meter. The brackets should be as small as feasible so as not to interfere with the normal movement of heat between the surface and the thermometer location, and of a material whose specific heat and thermal conductivity are of the same general magnitude as those of concrete. Thermometers in groups should be arranged in echelon formation in order that each meter will not interfere with the movement of heat between the surface and other instruments in the group.

*

APPENDIX D

SAMPLE FORM OF SYSTEM REQUIREMENTS DOCUMENT

D-1. Description. The following is a sample form of the System Requirements Document. It is intended to aid in the specifying of the system requirements. A completed version of this document, representing the requirements of a fictitious data acquisition system, can be found in REMR Technical Report REMR-CS-5, Report 1 Instrumentation Automation Techniques.

SYSTEM REQUIREMENTS DOCUMENT

(Facility)

(Contract)

(System Name)

(System Designer)

(Date)

GENERAL FACILITY MISSION AND SYSTEM OBJECTIVES

*

*

FUNCTIONAL AND ENVIRONMENTAL REQUIREMENTS

1. Physical phenomena/measurements. _____
 - a. Range _____
 - b. Accuracy (total system) _____
 - c. Resolution (total system) _____
 - d. Sample/interest rate: _____ Continuous
_____ Intermittent _____ Frequency
 - e. Display (real-time): _____ Yes _____ No
 - f. Store/record: _____ Yes _____ No
 - g. Number of measurements _____
 - h. Alarm: _____ Yes _____ No
Limits: _____ Low _____ High
 - i. Criticality: _____ High _____ Average _____ Low
2. Sensor/detector/transducer.
Type _____
Sensitivity Nonlinearity _____ Hysteresis _____
Accuracy _____ Resolution _____ Range _____
Maximum Residual Unbalance (zero offset) _____
Temperature Compensation: _____ Yes _____ No
Excitation Power: _____ V _____ AC _____ DC
_____ A _____ Reg. _____ Unreg. _____ Hz
Number of Instruments _____

*

Environmental

Operating temp _____ Humidity _____

Shock/Vibration _____ Other hazards _____

Protective enclosure: _____ Yes _____ No

Mechanical

Physical dimensions _____

Mounting _____ Spatial _____

3. Signal Conditioner/Converter

a. Amplifier

No. of channels _____

Single-ended _____ Differential _____

Gain-Fixed _____ Variable _____ Range _____

Automatic/Manual _____

Accuracy _____ Bandwidth _____

Environmental

Operating temp _____ Humidity _____

Shock/Vibration _____ Other hazards _____

Protective enclosure: _____ Yes _____ No

Mechanical

Physical dimensions _____

Mounting _____ Spatial _____

*

*

b* Filter

Type: Low-pass _____ High-pass _____ Band-pass _____

Cut-off Frequency _____ Fixed _____ Variable _____

No. of channels _____

Environmental

Operating temp _____ Humidity _____

Shock/Vibration _____ Other hazards _____

Protective enclosure: _____ Yes _____ No

Mechanical

Physical dimensions _____

Mounting _____ Spatial _____

c. Balance _____ Offset _____ Compensation _____

d. Multiplexer

1. Analog: Low level _____ High level _____

No. of inputs per output _____

Input: Single-ended _____ Differential _____

Input voltage range _____ Sample rate _____

2. Digital: Parallel _____ Serial _____

Bits/word _____ No. of channels _____

Address code type _____ (BCD, binary, etc.)

Logic levels: High _____ v Low _____ V

Logic convention: Positive _____ Negative _____

Sample rate _____

*

Environmental

Operating temp _____ Humidity _____

Shock/Vibration _____ Other hazards _____

Protective enclosure: _____ Yes _____ No

Mechanical

Physical dimensions _____

Mounting _____ Spatial _____

e. Signal Converter

Type: Analog-to-Digital (A/D) _____

Input range _____ V Conversion speed _____ usec

Bits of resolution _____

Digital-to-Analog (D/A) _____

Bits of resolution _____ Conv speed _____ usec

Output Range _____

Environmental

Operating temp _____ Humidity _____

Shock/Vibration _____ Other hazards _____

Mechanical

Physical dimensions _____

Mounting _____ Spatial _____

f. Sensor Power Source: _____ Yes _____ No

AC _____ DC _____ Hz _____ Reg _____ Unreg _____

*

EM 1110-2-4300
Change 1
30 Nov 87

*

Voltage _____ Amperage _____ Backup: _____ Yes _____ No

Battery _____ UPS _____ Solar _____

Environmental

Operating temp _____ Humidity _____

Shock/Vibration _____ Other hazards _____

Mechanical

Physical dimensions _____

Mounting _____ Spatial _____

g. Transmission Link

Wire/cable _____ Telemetry _____ Telephone Modem _____

Fiber-optic _____ Other _____

Environmental

Operating temp _____ Humidity _____

Shock/Vibration _____ Other hazards _____

Mechanical

Physical dimensions _____

Mounting _____ Spatial _____

4. Data Processor/Storage/Monitor

a. Computer

Purpose: Data acquisition _____ Process control _____

Data reduction _____ Computation _____

Other _____

*

*

1. Peripherals: Monitor _____ Plotter _____
Printer _____ Mag. tape _____ Modem _____
Terminal _____ Disk drive _____ Floppy disk _____
Hard disk _____
 2. No. of input data channels _____
Analog _____ Digital _____
 3. Main Memory: Type _____ Capacity _____
 4. Communications: I/O port(s); 4-20mA _____
IEEE-488 _____ RS-232-C _____ RS-422 _____ RS-449 _____
16-bit parallel _____
 5. Power: Primary _____ Backup _____
_____ V AC _____ DC _____ Amps _____ Freq _____
Backup: Battery _____ UPS _____ Solar _____
Available: _____ Yes _____ No
 6. Grounding scheme _____
 7. Network configuration _____
- Environmental
- Operating temp _____ Humidity _____
- Shock/Vibration _____ Other hazards _____
- Cooling reqmnts _____ Dehumidification _____
- Mechanical
- Physical dimensions _____

*

EM 1110-2-4300
Change 1
30 Nov 87

*

Mounting _____ Spatial _____

Portable _____ Fixed _____

b. Data Logger

Data input: Analog __ Digital __ Sample rate _____

Hard copy _____ Internal storage _____ Memory cap. _____

Resolution _____

Remote communications: Modem _____ RF _____ I/O _____

Alarm: Audible _____ Visual _____

Power: Primary _____ Backup _____

_____ V _____ AC _____ DC _____ Amps _____ Hz

Backup: Battery _____ UPS _____ Solar _____

Available: _____ Yes _____ No

Grounding scheme _____

Environmental

Operating temp _____ Humidity _____

Shock/Vibration _____ Other hazards _____

Mechanical

Physical dimensions _____

Mounting _____ Spatial _____

Portable _____ Fixed _____

c. Storage Devices: Disk drives _____ Mag tape units _____

1. Disk drives: Avg access time _____

Unit capacity _____ Controller _____

*

*

Floppy _____ Hard _____ Fixed _____ Removable _____

Power: Primary _____ Backup _____

_____ V _____ AC _____ DC _____ Amps _____ Hz

Backup: Battery _____ UPS _____ Solar _____

Available _____ Yes _____ No _____

Grounding scheme _____

Environmental

Operating temp _____ Humidity _____

Shock/Vibration _____ Other Hazards _____

Mechanical

Physical dimensions _____

Mounting _____ Spatial _____

Portable _____ Fixed _____

2. Magnetic tape unit:

Bits per inch (BPI) _____ Tape speed _____ ips

7-track _____ g-track _____ Reel Size _____

Tape width _____

Power: Primary _____ Backup _____

_____ V _____ AC _____ DC _____ Amps _____ Hz

Backup: Battery _____ UPS _____ Solar _____

Available _____ Yes _____ No _____

Grounding scheme _____

*

*

Environmental

Operating temp _____ Humidity _____

Shock/Vibration _____ Other hazards _____

Mechanical

Physical dimensions _____

Mounting _____ Spatial _____

Portable _____ Fixed _____

5. Displays/Alarms

a. Cathode Ray Tube (CRT)

1. Resolution: _____ High _____

Video: _____ Composite _____ RGB

Screen size _____ Color _____ Monochrome _____

Power: Primary _____ Backup _____

_____ V _____ AC _____ DC _____ Amps _____ Hz

Backup: Battery _____ UPS _____ Solar _____

Environmental

Operating temp _____ Humidity _____

Shock/Vibration _____ Other hazards _____

Mechanical

Physical dimensions _____

Mounting _____ Spatial _____

Portable _____ Fixed _____

*

*

b. Printer

Type: Character _____ Line _____

Letter quality _____ Dot matrix _____

Communications port: Serial _____ Parallel _____

Data buffer: _____ Yes _____ No _____

Paper: _____ Tractor feed _____ Friction feed _____

Fan fold _____ Roll _____ Size _____

Type font(s) _____

Power: Primary _____ Backup _____

_____ V _____ AC _____ DC _____ Amps _____ Hz

Environmental

Operating temp _____ Humidity _____

Shock/Vibration _____ Other hazards _____

Mechanical

Physical dimensions _____

Mounting _____ Spatial _____

Portable _____ Fixed _____

c. Plotter(s)

Type: Roll _____ Flat bed _____

Plot size _____ No. of pens _____

Communications port: Serial _____ Parallel _____

Data buffer: _____ Yes _____ No _____

*

Paper size _____ Fonts _____

Power: Primary _____ Backup _____

_____ V _____ AC _____ DC _____ Amps _____ Hz

Environmental

Operating temp _____ Humidity _____

Shock/Vibration _____ Other hazards _____

Mechanical

Physical dimensions _____

Mounting _____ Spatial _____

Portable _____ Fixed _____

d. Strip chart recorder(s)

Type: Pen & ink _____ Heated stylus _____ Point plot

Signal input: Sensitivity _____ Freq. response _____

No. of channels _____

Power: Primary _____ Backup _____

_____ V _____ AC _____ DC _____ Amps _____ Hz

Environmental

Operating temp _____ Humidity _____

Shock/Vibration _____ Other hazards _____

Mechanical

Physical dimensions _____

Mounting _____ Spatial _____

Portable _____ Fixed _____

* e. Indicators

Type: 1. Status: LED ____ Incandescent ____
Other ____
2. Information: Digital ____ Analog ____
LED ____ LCD ____ Dial/Meter ____
Gas discharge ____ Pointer/Scale ____
Other _____
Power: Primary _____ Backup _____
____ V ____ AC ____ DC ____ Amps ____ Hz

Environmental

Operating temp _____ Humidity _____
Shock/Vibration _____ Other hazards _____

f. Alarms

Type: Audible _____ Visual _____ Remote _____
Local _____
Power: Primary _____ Backup _____
____ V ____ AC ____ DC ____ Amps ____ Hz

Environmental

Operating temp _____ Humidity _____
Shock/Vibration _____ Other hazards _____

*