

ETSI TS 102 361-2 V2.1.1 (2012-04)



**Electromagnetic compatibility
and Radio spectrum Matters (ERM);
Digital Mobile Radio (DMR) Systems;
Part 2: DMR voice and generic services and facilities**

Reference

RTS/ERM-TGDMM-304

Keywords

air interface, digital, PMR, protocol, radio

ETSI

650 Route des Lucioles
F-06921 Sophia Antipolis Cedex - FRANCE

Tel.: +33 4 92 94 42 00 Fax: +33 4 93 65 47 16

Siret N° 348 623 562 00017 - NAF 742 C
Association à but non lucratif enregistrée à la
Sous-Préfecture de Grasse (06) N° 7803/88

Important notice

Individual copies of the present document can be downloaded from:

<http://www.etsi.org>

The present document may be made available in more than one electronic version or in print. In any case of existing or perceived difference in contents between such versions, the reference version is the Portable Document Format (PDF). In case of dispute, the reference shall be the printing on ETSI printers of the PDF version kept on a specific network drive within ETSI Secretariat.

Users of the present document should be aware that the document may be subject to revision or change of status. Information on the current status of this and other ETSI documents is available at

<http://portal.etsi.org/tb/status/status.asp>

If you find errors in the present document, please send your comment to one of the following services:

http://portal.etsi.org/chaicor/ETSI_support.asp

Copyright Notification

No part may be reproduced except as authorized by written permission.
The copyright and the foregoing restriction extend to reproduction in all media.

© European Telecommunications Standards Institute 2012.
All rights reserved.

DECT™, **PLUGTESTS™**, **UMTS™** and the ETSI logo are Trade Marks of ETSI registered for the benefit of its Members.
3GPP™ and **LTE™** are Trade Marks of ETSI registered for the benefit of its Members and of the 3GPP Organizational Partners.
GSM® and the GSM logo are Trade Marks registered and owned by the GSM Association.

Contents

Intellectual Property Rights	7
Foreword.....	7
1 Scope	8
2 References	8
2.1 Normative references	8
2.2 Informative references.....	8
3 Definitions and abbreviations.....	9
3.1 Definitions.....	9
3.2 Abbreviations	11
4 Overview	12
4.1 Protocol architecture.....	12
4.1.1 Air Interface Physical Layer (layer 1).....	14
4.1.2 Air Interface Data Link Layer (layer 2).....	14
4.1.3 Air Interface layer 3 (CCL).....	14
4.2 Overview of voice and generic services and facilities.....	15
4.3 Feature interoperability	16
5 DMR services	16
5.1 Generic services	16
5.1.1 Generic BS services	16
5.1.1.1 BS outbound activation	18
5.1.1.1.1 BS Outbound Activation SDL.....	19
5.1.1.1.2 BS MSCs	19
5.1.1.1.3 BS_Outbound_Activation	19
5.1.1.2 Voice call repeating.....	20
5.1.1.3 Voice call hangtime.....	21
5.1.1.4 CSBK repeating	23
5.1.1.5 BS outbound deactivation	24
5.1.2 Feature Not Supported (FNS) signalling	24
5.1.2.1 FNS Data Bursts/Fields.....	25
5.1.2.2 MS FNS MSC	26
5.2 Primary voice services.....	27
5.2.1 Group call service	27
5.2.1.1 Service description	27
5.2.1.2 Group call data bursts/fields.....	27
5.2.1.2.1 Direct mode	27
5.2.1.2.2 Repeater mode.....	28
5.2.1.3 MS group call control.....	28
5.2.1.3.1 MS group call SDL.....	28
5.2.1.3.2 MS group call HMSC	29
5.2.1.3.3 MS group call MSCs	30
5.2.2 Individual call service	40
5.2.2.1 Service description	40
5.2.2.2 Individual call data bursts/fields	41
5.2.2.2.1 Direct mode	41
5.2.2.2.2 Repeater mode.....	41
5.2.2.3 MS Individual call channel access	41
5.2.2.3.1 UU_V_Req channel access SDL.....	42
5.2.2.3.2 UU_Ans_Rsp channel access SDL.....	43
5.2.2.4 MS Individual call control	44
5.2.2.4.1 MS OACSU Individual call source CCL SDL	44
5.2.2.4.2 MS OACSU Individual call setup MSCs	45
5.3 Supplementary voice services	47
5.3.1 Unaddressed voice call service	47

5.3.1.1	Unaddressed voice call data burst/fields	47
5.3.1.2	MS Unaddressed voice call control.....	47
5.3.2	All call voice service.....	47
5.3.2.1	All call data bursts/fields.....	47
5.3.2.2	MS All call control.....	47
5.3.2.3	BS All call control.....	48
5.3.2.3.1	All call voice repeating.....	48
5.3.2.3.2	All call end of transmission	48
5.3.3	Broadcast call voice service.....	49
5.3.3.1	Broadcast call data bursts/fields.....	49
5.3.3.2	MS Broadcast call control.....	49
5.3.3.3	BS Broadcast call control.....	49
5.3.3.3.1	Broadcast call voice repeating	49
5.3.3.3.2	Broadcast call end of transmission	49
5.3.4	Open voice channel mode service.....	49
5.3.4.1	OVCN service description.....	50
6	DMR facilities	50
6.1	Transmit timeout	50
6.2	TDMA direct mode wide area timing.....	51
6.2.1	Facility description	51
6.2.1.1	Leader_and_Timing_Unknown	51
6.2.1.2	Leader_Unknown.....	51
6.2.1.3	Leader_and_Timing_Known	51
6.2.1.4	Leader	51
6.2.2	TDMA direct mode data bursts/fields.....	52
6.2.2.1	Synchronization	52
6.2.2.2	Colour Code	52
6.2.2.3	Channel Timing CSBK	52
6.2.2.3.1	CT_CSBK_Beacon.....	52
6.2.2.3.2	CT_CSBK_Prop.....	52
6.2.2.3.3	CT_CSBK_Term.....	53
6.2.2.3.4	CT_CSBK_Req.....	53
6.2.2.3.5	CT_CSBK_Resp.....	53
6.2.3	TDMA direct mode SDL	54
6.2.3.1	Power up and channel change SDL.....	54
6.2.3.2	Leader and timing unknown SDL	54
6.2.3.3	Leader unknown SDL	55
6.2.3.4	Leader and timing known SDL	56
6.2.3.5	Leader SDL.....	57
6.2.3.6	Leader identifier conflict SDL	58
6.2.3.7	CT_CSBK evaluation SDL.....	59
6.2.3.8	Send correction SDL.....	60
6.2.3.9	Accept leader SDL.....	61
6.2.3.10	Appoint new leader SDL.....	62
6.2.3.11	Timing push SDL.....	63
6.2.3.12	Transmit procedure SDL.....	64
7	PDU description	65
7.1	Layer 3 PDUs	65
7.1.1	Full Link Control PDUs.....	66
7.1.1.1	Group Voice Channel User LC PDU	66
7.1.1.2	Unit to Unit Voice Channel User LC PDU	66
7.1.2	Control Signalling BlocK (CSBK) PDUs.....	67
7.1.2.1	BS Outbound Activation CSBK PDU.....	67
7.1.2.2	Unit to Unit Voice Service Request CSBK PDU.....	67
7.1.2.3	Unit to Unit Voice Service Answer Response CSBK PDU	68
7.1.2.4	Negative Acknowledge Response CSBK PDU.....	68
7.1.2.5	Preamble CSBK PDU	68
7.1.2.6	Channel Timing CSBK PDU	69
7.1.3	Short Link Control PDUs	70
7.1.3.1	Null Message.....	70

7.1.3.2	Activity Update	71
7.2	Layer 3 information element coding	72
7.2.1	Service Options.....	72
7.2.2	Answer Response.....	72
7.2.3	Reason Code	72
7.2.4	Service Type	73
7.2.5	Source Type	73
7.2.6	Additional Information Field	73
7.2.7	CSBK Blocks to Follow (CBF)	73
7.2.8	Identifier (ID).....	73
7.2.9	Dynamic Identifier (DI)	74
7.2.10	Wide Area Timing Identifier (WATID).....	74
7.2.11	Channel Timing Opcode (CTO)	74
7.2.12	New Leader (NL).....	74
7.2.13	Generation (Gen)	75
7.2.14	Sync Age (SA).....	75
Annex A (normative): Timers and constants in DMR.....		76
A.1	Layer 3 timers.....	76
A.2	Layer 3 constants.....	77
Annex B (normative): Opcode Reference Lists.....		78
B.1	Full Link Control Opcode List.....	78
B.2	CSBK Opcode List.....	78
B.3	Short Link Control Opcode List.....	78
Annex C (informative): Numbering and dialling plan.....		79
C.1	Introduction to the numbering and dialling plan	79
C.2	Subscriber mapping.....	80
C.2.1	User Interface - Air Interface	80
C.2.1.1	Mapping for MS individual address space.....	81
C.2.1.1.1	Mapping for diallable addresses (prefix 0 to 9).....	82
C.2.1.1.2	Mapping for non-diallable individual addresses (prefix 10 to 14)	82
C.2.1.1.3	Examples of individual address mapping.....	83
C.2.1.2	Mapping for MS talkgroup address space.....	83
C.2.1.2.1	The concept of the wildcard character	83
C.2.1.2.2	The concept of stored parameters.....	83
C.2.1.2.3	The concept of ad-hoc arrangement	84
C.2.1.2.4	The rules for the sender.....	84
C.2.1.2.5	The rules for the recipient	84
C.2.1.2.6	Mapping of dialled strings to the AI talkgroup address space	85
C.2.1.2.6.1	Mapping of numeric dialled strings to the AI talkgroup address space.....	85
C.2.1.2.6.2	Mapping for non-diallable talkgroup addresses (prefix 10 to 14)	87
C.2.1.2.6.3	Examples of talkgroup non-diallable address mapping	87
C.2.1.2.7	The concept of the prefix	87
C.2.2	Addresses	89
C.2.3	Conversion rules.....	89
C.2.3.1	MS addresses	89
C.2.3.2	Limiting the length of the destination address	89
C.2.3.3	All talkgroup address	89
C.2.3.4	Gateways	90
C.3	User dialling plan	90
C.3.1	User numbering	90
C.3.1.1	Dialling method	90
C.3.1.2	Call Type determination	90
C.3.1.3	Call modifier strings	90
C.3.2	Dialled digits to address mapping	91

C.3.3	Storage requirements	91
C.3.3.1	MS individual address	91
C.3.3.2	Talkgroups	91
C.3.3.3	All MSs.....	91
C.3.3.4	Non-diallable numbers.....	91
C.3.3.5	Talkgroup recognition.....	92
C.3.3.5.1	All numeric talkgroups.....	92
C.3.3.5.2	Talkgroups defined by wildcards	92
C.3.3.5.3	MS receives a talkgroup call	92
C.3.4	Dialling procedures	93
C.3.4.1	MS calls	93
C.3.4.1.1	Seven digit dialling	93
C.3.4.1.2	Abbreviated dialling.....	93
C.3.4.1.3	Individual call	94
C.3.4.1.4	Talkgroup Call	94
C.3.4.1.5	All Call.....	94
C.3.4.2	Gateway calls.....	94
C.3.4.2.1	Telephone call	94
C.3.4.2.1.1	Telephone numeric padding format.....	94
C.3.4.2.1.2	Telephone star modifier format	95
C.3.4.2.2	PABX call	95
C.3.4.2.2.1	PABX numeric padding format.....	95
C.3.4.2.2.2	PABX star modifier format	95
C.3.4.2.3	IP call	95
C.3.4.3	Call modifiers	96
C.3.4.3.1	Broadcast call.....	96
C.3.4.3.2	Priority call.....	96
C.3.4.3.3	Emergency call.....	96
C.3.4.3.4	Status call.....	96
C.3.4.3.5	Divert own call.....	97
C.3.4.3.6	Open channel voice mode call	97
C.3.4.3.7	Force talkgroup service	97
C.3.4.3.8	Multiple call modifiers.....	97
C.3.4.4	MS behaviour commands	97
C.3.4.4.1	Edit the talkgroup table	97
C.3.4.4.2	Queue Incoming call	98
C.3.4.4.3	Display own identity	98
C.3.4.4.4	Display Own talkgroup table.....	98
C.3.4.5	Call set-up abandon or call complete.....	98
Annex D (informative):	Change requests	99
Annex E (informative):	Bibliography.....	100
History		101

Intellectual Property Rights

IPRs essential or potentially essential to the present document may have been declared to ETSI. The information pertaining to these essential IPRs, if any, is publicly available for **ETSI members and non-members**, and can be found in ETSI SR 000 314: "*Intellectual Property Rights (IPRs); Essential, or potentially Essential, IPRs notified to ETSI in respect of ETSI standards*", which is available from the ETSI Secretariat. Latest updates are available on the ETSI Web server (<http://ipr.etsi.org>).

Pursuant to the ETSI IPR Policy, no investigation, including IPR searches, has been carried out by ETSI. No guarantee can be given as to the existence of other IPRs not referenced in ETSI SR 000 314 (or the updates on the ETSI Web server) which are, or may be, or may become, essential to the present document.

Foreword

This Technical Specification (TS) has been produced by ETSI Technical Committee Electromagnetic compatibility and Radio spectrum Matters (ERM).

The present document is part 2 of a multi-part deliverable covering the Technical Requirements for Digital Mobile Radio (DMR), as identified below:

- Part 1: "DMR Air Interface (AI) protocol";
- Part 2: "DMR voice and generic services and facilities";**
- Part 3: "DMR data protocol";
- Part 4: "DMR trunking protocol".

1 Scope

The present document contains technical requirements for Digital Mobile Radio (DMR) operating in the existing licensed land mobile service frequency bands, as identified in CEPT/ERC/T/R 25-08 [2].

The present document describes the voice and generic services and facilities of a scalable Digital Mobile Radio system which covers three tiers of possible products:

- Tier I: DMR equipment having an integral antenna and working in direct mode (communication without infrastructure) under a general authorization with no individual rights operation.
- Tier II: DMR systems operating under individual licences working in direct mode (unit-to-unit) or using a Base Station (BS) for repeating.
- Tier III: DMR trunking systems under individual licences operating with a controller function that automatically regulates the communications.

NOTE 1: Tier II and Tier III products encompass both simulcast and non-simulcast systems.

NOTE 2: The three tiers of possible products will work only independently and not interoperable.

The present document specifies the voice and generic services and facilities of DMR that has been specifically developed with the intention of being suitable for all identified product tiers. The DMR protocol is intended to be applicable to the land mobile frequency bands, physical channel offset, duplex spacing, range assumptions and all other spectrum parameters without need for any change.

2 References

References are either specific (identified by date of publication and/or edition number or version number) or non-specific. For specific references, only the cited version applies. For non-specific references, the latest version of the reference document (including any amendments) applies.

Referenced documents which are not found to be publicly available in the expected location might be found at <http://docbox.etsi.org/Reference>.

NOTE: While any hyperlinks included in this clause were valid at the time of publication, ETSI cannot guarantee their long term validity.

2.1 Normative references

The following referenced documents are necessary for the application of the present document.

- [1] ETSI TS 102 361-1: "Electromagnetic compatibility and Radio spectrum Matters (ERM); Digital Mobile Radio (DMR) Systems; Part 1: DMR Air Interface (AI) protocol".
- [2] CEPT/ERC/T/R 25-08: "Planning criteria and co-ordination of frequencies in the Land Mobile Service in the range 29,7-921 MHz".
- [3] ETSI TS 102 361-3: "Electromagnetic compatibility and Radio spectrum Matters (ERM); Digital Mobile Radio (DMR) Systems; Part 3: DMR data protocol".

2.2 Informative references

The following referenced documents are not necessary for the application of the present document but they assist the user with regard to a particular subject area.

Not applicable.

3 Definitions and abbreviations

3.1 Definitions

For the purposes of the present document, the following terms and definitions apply:

1:1-mode: 1 traffic channel mode

NOTE: 1:1-mode supports one "MS to fixed end" duplex call or one simplex call with an optional inbound Reverse Channel using a two frequency BS.

2:1-mode: 2 traffic channel mode

NOTE: 2:1-mode supports two independent calls which may be either "MS to fixed end" duplex calls, simplex calls using a two frequency BS or simplex calls between MS units on a single frequency.

Base Station (BS): fixed end equipment that is used to obtain DMR services

bearer service: telecommunication service providing the capability for information transfer between access points

burst: elementary amount of bits within the physical channel

NOTE 1: Three different bursts exist with different number of bits. The Traffic burst contains 264 bits, the CACH burst contains 24 bits and the RC burst contains 96 bits.

NOTE 2: The burst may include a guard time at the beginning and end of the burst used for power ramp-up and ramp-down.

NOTE 3: For detailed burst definition see clause 4.2.1.

call: complete sequence of related transactions between MSs

NOTE: Transactions may be one or more bursts containing specific call related information.

channel slot timing: time slot 1 and time slot 2 timing boundaries established by a TDMA direct mode leader

Control plane (C-plane): part of the DMR protocol stack dedicated to control and data services

Digital Mobile Radio (DMR): physical grouping that contains all of the mobile and/or fixed end equipment that is used to obtain DMR services

direct mode: mode of operation where MSs may communicate outside the control of a network

NOTE 1: This is communication technique where any radio unit (MS) may communicate with one or more other radio units (MSs) without the need for any additional equipment (e.g. BS).

NOTE 2: Supports one transmission per 12,5 kHz frequency; 12,5 kHz equivalent (12,5e) spectral efficiency.

duplex: a mode of operation by which information can be transferred in both directions and where the two directions are independent

NOTE: Duplex is also known as full duplex.

frame: two contiguous time slots labelled 1 and 2

NOTE: A frame has a length of 60 ms.

inbound: MS to BS transmission

logical channel: distinct data path between logical endpoints

NOTE: The logical channels are labelled 1 and 2. The logical channel may consist of sub-channels, e.g. SYNC, embedded signalling, etc.

Mobile Station (MS): physical grouping that contains all of the mobile equipment that is used to obtain DMR mobile services

outbound: BS to MS transmission

payload: bits in the information field

personalization: address and configuration information that characterizes a particular DMR MS

NOTE: This information may be programmed by the installer before putting an MS into service.

physical channel: RF carrier that is modulated with information bits of the bursts

NOTE: The RF carrier may be a single frequency or a duplex pair of frequencies. The physical channel of a DMR subsystem is required to support the logical channels.

polite protocol: "Listen Before Transmit" (LBT) protocol

NOTE: This is a medium access protocol that implements a LBT function in order to ensure that the channel is free before transmitting.

prefix: most significant digit of a MS address in the user domain

privacy: secret transformation

NOTE: Any transformation of transmitted information that is derived from a shared secret between the sender and receiver.

Protocol Data Unit (PDU): unit of information consisting of protocol control information (signalling) and possibly user data exchanged between peer protocol layer entities

Radio Frequency channel: Radio Frequency carrier (RF carrier)

NOTE: This is a specified portion of the RF spectrum. In DMR, the RF carrier separation is 12,5 kHz. The physical channel may be a single frequency or a duplex spaced pair of frequencies.

repeater mode: mode of operation where MSs may communicate through a BS

NOTE: This is a communication technique where any radio unit (MS) may communicate with one or more other radio units (MSs) with the need for an intermediate BS.

signalling: exchange of information specifically concerned with the establishment and control of connections, and with management, in a telecommunication network

simplex: mode of working by which information can be transferred in both directions but not at the same time

superframe: 6 continues traffic bursts on a logical channel labelled "A" to "F"

NOTE: A superframe has a length of 360 ms and is used for voice traffic only.

TDMA direct mode: direct mode operation that supports two transmissions per 12,5 kHz frequency

NOTE: Supports 6,25 kHz equivalent (6,25e) spectral efficiency.

time slot (or slot): elementary timing of the physical channel

NOTE: A timeslot has a length of 30 ms and will be numbered "1" or "2".

transmission: transfer period of bursts containing information or signalling

NOTE: The transmission may be continuous, i.e. multiple bursts transmission without ramp-up, ramp-down, or discontinuous, i.e. single burst transmission with ramp-up and ramp-down period.

trunking: network controlled communication

NOTE: This is a communication technique where any radio unit (MS) may communicate with one or more other radio units (MSs) using a trunking protocol and all MSs will be under control of a network.

user numbering: decimal representation of DMR air interface addresses

NOTE: The user numbering is that visible to a user or seen by the user.

User plane (U-plane): part of the DMR protocol stack dedicated to user voice services

wildcard: character in the user domain that represents all digits 0 to 9

3.2 Abbreviations

For the purposes of the present document, the following abbreviations apply:

AI	Air Interface
AIF	Additional Information Field
AR	Answer Response
AT	Access Type
BOC	Beginning Of Call
BOR	Beginning Of Repeat
BOT	Beginning Of Transmission
BS	Base Station
CACH	Common Announcement CHannel
CC	Colour Code
CCITT	Consultative Committee on International Telegraphy and Telephony
CCL	Call Control Layer
CCL_1	Call Control Layer: Slot 1 process
CCL_2	Call Control Layer: Slot 2 process
CCL_BS	Call Control Layer: Both Slot process
C-plane	Control-plane
CRC	Cyclic Redundancy Checksum for data error detection
CSBK	Control Signalling BloCk
CSBKO	CSBK Opcode
CT_CSBK	Channel Timing CSBK
CTO	Channel Timing Opcode
DLL	Data Link Layer
DMR	Digital Mobile Radio
EOC	End Of Call
EOR	End Of Repeat
EOT	End Of Transmission
FEC	Forward Error Correction
FID	Feature set ID
FLCO	Full Link Control Opcode
FNS	Feature Not Supported
Gen	Generation
Grp_V_Ch_Usr	Group Voice Channel User
HMSC	High level Message Sequence Chart
ID	IDentifier
LBT	Listen Before Transmit
LC	Link Control
LDI	LeaderDynamic Identifier
LDR	LeaDeR CT_CSBK evaluation
LID	Leader Identifier
LSB	Least Significant Bit
LWATID	Leader Wide Area Timing IDentifier
MAC	Medium Access Control
MFID	Manufacturer's FID
MMI	Man Machine Interface
MS	Mobile Station (either portable or mobile unit)
MSB	Most Significant Bit
MSC	Message Sequence Chart
N_xxxx	Layer 3 constant

NOTE: As defined in clause A.2.

NL	New Leader
OACSU	Off Air Call SetUp
Octet	8 bits grouped together, also called a byte
OVCN	Open Voice Channel Mode service
PABX	Private Automatic Branch eXchange
PATCS	Press And Talk Call Setup
PDU	Protocol Data Unit
PL	Physical Layer
PSTN	Public Switched Telephone Network
PTT	Push-To-Talk
RC	Reason Code
RC	Reverse Channel
RF	Radio Frequency
SA	Sync Age
SC	Send Correction
SDI	SourceDynamic Identifier
SDL	Specification and Description Language
SFID	Standards FID
SID	Source IDentifier
SO	Service Options
ST	Service Type
ST	Source Type
SWATID	Source Wide Area Timing IDentifier
SYNC	Synchronization
T_xxxx	Layer 3

NOTE: Timer as defined in clause A.1.

TDMA	Time Division Multiple Access
U-plane	User-plane

4 Overview

The present document describes a Digital Mobile Radio (DMR) system for Tier II and Tier III products which employ a Time Division Multiple Access (TDMA) technology with a 2-slot TDMA solution and RF carrier bandwidth of 12,5 kHz (see note 1).

NOTE 1: DMR system for Tier I products employ a continuous transmission variation of the previously mentioned technology.

The present document describes the Call Control Layer (CCL) of the DMR Air Interface (AI). Radio equipments (fixed, mobile or portable) which conform to the present document shall be interoperable at the Air Interface with equipment from other manufacturers. Radio equipment of the present document shall also comply with TS 102 361-1 [1].

The present document will not provide the specification or operational detail for system implementations which include but are not limited to trunking, roaming, network management, vocoder, security, data, subsystems interfaces and data between private and public switched telephone networks. It describes only the appropriate access requirements compatible with the Air Interface.

NOTE 2: The DMR standard consists of a multi-part deliverable, which will be referred to in the present document if needed.

4.1 Protocol architecture

The purpose of this clause is to provide a model where the different functions and processes are identified and allocated to different layers in the DMR protocol stack.

The protocol stack in this clause and all other related clauses describe and specify the interfaces, but these stacks do not imply or restrict any implementation.

The DMR protocol architecture which is defined herein follows the generic layered structure, which is accepted for reference description and specification of layered communication architectures.

The DMR standard defines the protocols for the following 3 layered model as shown in figure 4.1.

The base of the protocol stack is the Physical Layer (PL) which is the layer 1.

The Data Link Layer (DLL), which is the layer 2, shall handle sharing of the medium by a number of users. At the DLL, the protocol stack shall be divided vertically into two parts, the User plane (U-plane), for transporting information without addressing capability (e.g. voice), and the Control plane (C-plane) for signalling information, both control and data, with addressing capability, as illustrated by figure 4.1.

NOTE 1: It is appropriate to bear in mind the different requirements of C-plane and U-plane information. C-plane information needs only a discrete (or non-continuous) physical link to pass information although it needs a continuous virtual link to support the service. This may also be called signalling or packet mode service. Acknowledgements may or may not be requested. U-plane information, on the other hand, requires a regular physical link to be available so that a constant delay service can be supported. This may also be called circuit mode service.

NOTE 2: The DLL identified in figure 4.1 may be further sub-divided in the air interface protocol to separate the functionality of Medium Access Control (MAC) and Logical Link Control (LLC), which is often performed in radio air interface protocols due to the specialized nature of these two tasks. Such separation is not presented in the present document and is implementation specific. It is further implementation specific if layer 2 at U-plane offers only MAC for the service.

The Call Control Layer (CCL), which is layer 3, lies in the C-plane and is responsible for control of the call (addressing, features, and etc.), provides the services supported by DMR, and supports Short Data and Packet Data service. U-plane access at layer 2 (DLL) supports voice service which is available in DMR. The Control Layer and the features and services offered by DMR are described in the present document. The Short Data and Packet Data Protocol offered by DMR are described in TS 102 361-3 [3].

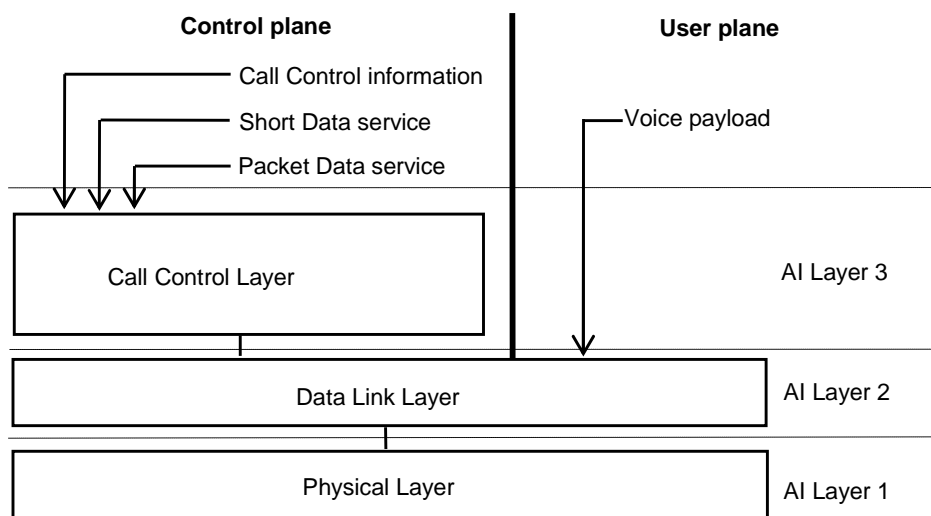

Figure 4.1: DMR protocol stack

4.1.1 Air Interface Physical Layer (layer 1)

The Air Interface layer 1 shall be the physical interface. It shall deal with the physical burst, composed of bits, which is to be sent and/or received. The Physical Layer is described in TS 102 361-1 [1].

The Air Interface layer 1 contains the following functions:

- modulation and demodulation;
- transmitter and receiver switching;
- RF characteristics;
- bits and symbol definition;
- frequency and symbol synchronization;
- burst building.

4.1.2 Air Interface Data Link Layer (layer 2)

The Air Interface layer 2 shall handle logical connections and shall hide the physical medium from the upper layers. The Data Link Layer is described in TS 102 361-1 [1].

The main functions are as follows:

- channel coding (FEC, CRC);
- interleaving, de-interleaving and bit ordering;
- acknowledgement and retry mechanism;
- media access control and channel management;
- framing, superframe building and synchronization;
- burst and parameter definition;
- link addressing (source and/or destination);
- interfacing of voice applications (vocoder data) with the PL;
- data bearer services;
- exchanging signalling and/or user data with the CCL.

4.1.3 Air Interface layer 3 (CCL)

Air Interface layer 3 (CCL) is applicable only to the C-plane, and shall be an entity for the services and features supported by DMR on top of the layer 2 functionality. The Call Control Layer is described in the present document and may have embedded intrinsic services associated to it.

The CCL provides the following functions:

- BS activation;
- establishing, maintaining and terminating of calls;
- individual or group call transmission and reception;
- destination addressing (DMR IDs or gateway as appropriate);
- support of intrinsic services (emergency signalling, pre-emption, late entry, etc.);
- announcement signalling.

4.2 Overview of voice and generic services and facilities

The facilities described for DMR are related to user initiated call procedures, e.g. group speech call, individual speech call, data call etc. The services defined for DMR contains intrinsic (embedded) signalling or procedures which may relate to one or more user initiated call procedures.

Some services are visible to users others are not and will be processed by the MS itself. All user related signalling or presentation above layer 3 is not part of the present document and is implementation specific.

The services and facilities defined in the present document may be used for Tier I and Tier II products and is called the "default feature set" which is allocated to the "Standards Feature ID (SFID)". There is a possibility in the DMR standard which allows manufacturers to define and implement "private" feature sets which contain additional "private" services and facilities, which may possibly not be understood by products not supporting this "private" feature set.

The "standard feature set" contains the following services and facilities:

- a) Generic services:
 - generic BS services:
 - BS outbound activation;
 - voice call repeating;
 - voice call hangtime;
 - CSBK repeating;
 - BS outbound deactivation;
 - feature not supported signalling.

All MSs shall implement the "feature not supported signalling". All other services and facilities are optional.

- b) Primary voice services:
 - group call service;
 - individual call service.
- c) Supplementary voice services:
 - unaddressed voice call service;
 - all call service;
 - broadcast voice call service;
 - open voice channel call service.
- d) DMR facilities:
 - transmit timeout;
 - TDMA direct mode wide area timing.

The description of the services and features uses SDL diagrams where necessary to illustrate and highlight specific points in both direct mode and repeater mode. Other aspects of the DMR radio system required are the High Level MS SDL, the High Level BS SDL, HMSC and MSC diagrams. For the High Level SDL diagrams and state description refer to TS 102 361-1 [1], clause G. The HMSC and MSC diagrams are described in the present document.

4.3 Feature interoperability

The FID identifies one of several different feature sets.

The FLCO identifies the "over-air" feature within the given feature set.

To ensure interoperability at the air interface, features that are standardized in the present document and available in the equipment shall be accessible only via the combination of default SFID and corresponding FLCO.

Features that are not standardized in the present document are only available via an alternative MFID.

5 DMR services

5.1 Generic services

5.1.1 Generic BS services

Figure 5.1 illustrates the HMSC for both BS slots. For descriptions of various states in this diagram refer to clause G.2 of TS 102 361-1 [1].

The Mobile Station Inactivity Timer $T_{MSInactive}$ is defined in clause F.1 of TS 102 361-1 [1]. Also, in the following diagrams the slot number refers to the outbound slot. Therefore, outbound slot 1 implies inbound slot 1 for offset mode and inbound slot 2 for aligned mode, as defined in clause 5.1 of TS 102 361-1 [1].

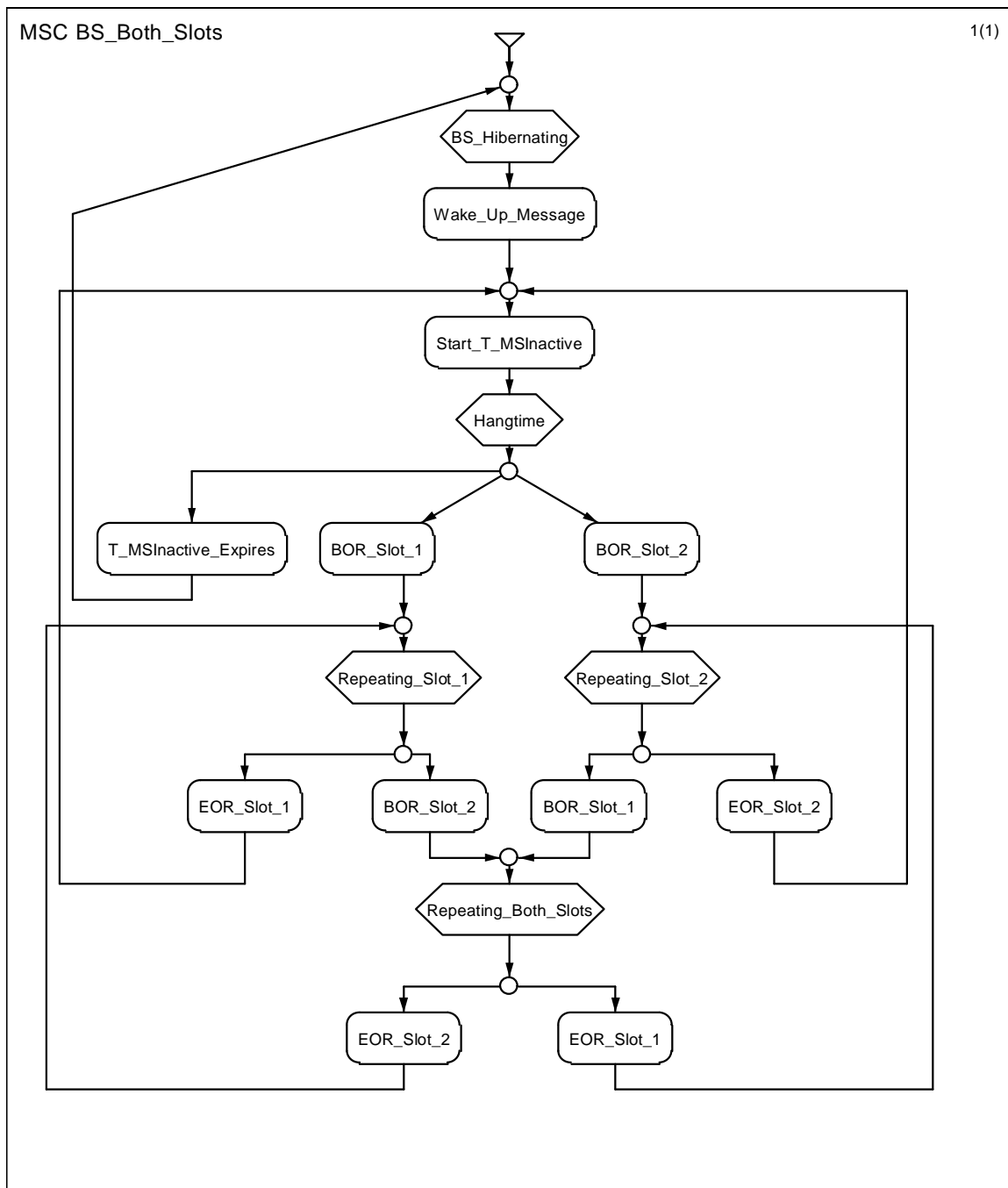

Figure 5.1: BS Both Slots HMSC

Figure 5.2 illustrates the HMSC for a single BS slot. For descriptions of various states in this diagram refer to clause G.2 of TS 102 361-1 [1].

NOTE: This HMSC is valid only when the BS is not in the BS_Hibernating state.

The single slot processes are started when the BS transitions out of the BS_Hibernating state and stopped when the BS transitions to the BS_Hibernating state.

Upon reception of a CSBK, the CACH AT bit may be left as idle as there are no more inbound bursts to follow.

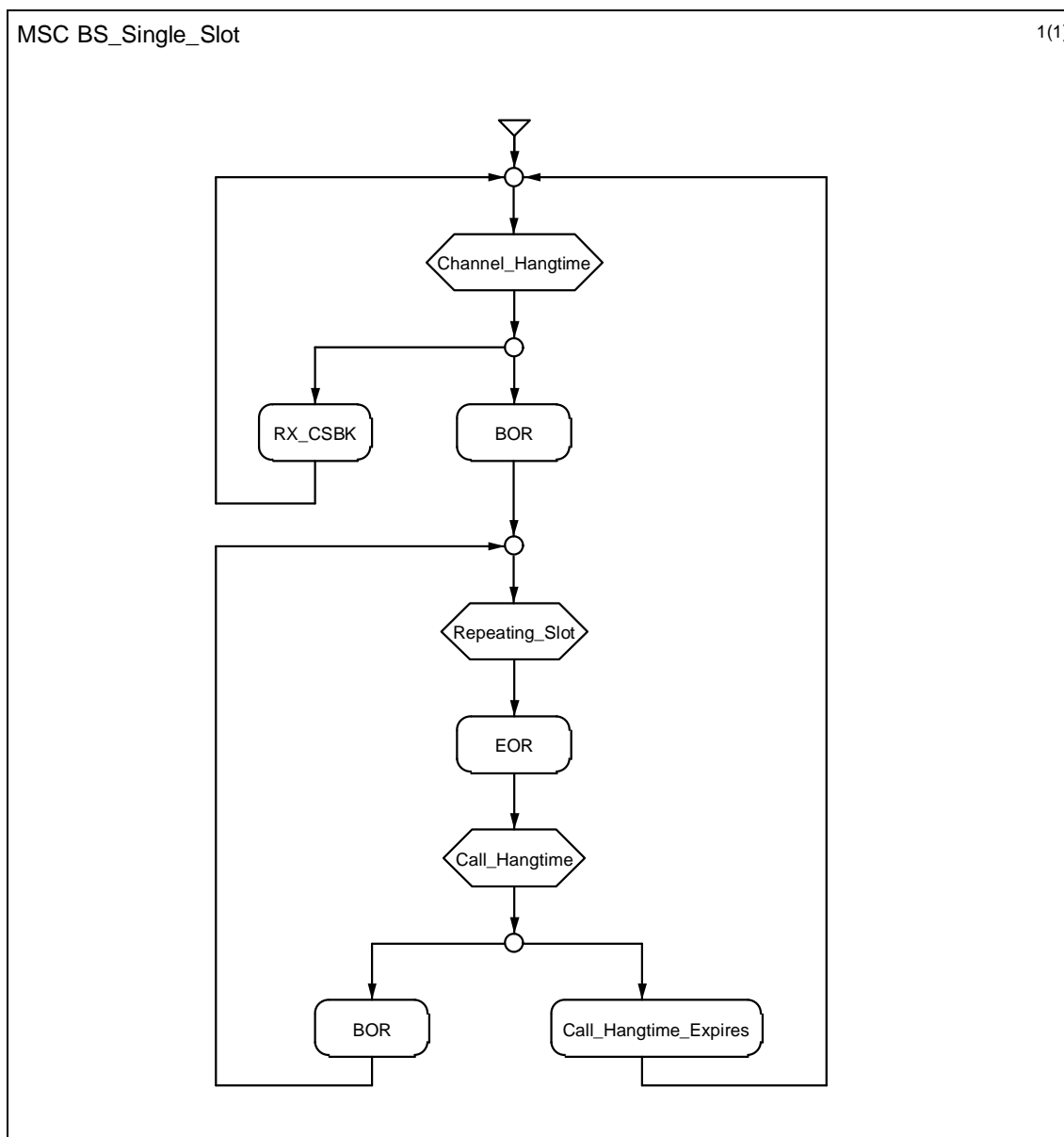

Figure 5.2: BS Single Slot HMSC

5.1.1.1 BS outbound activation

This clause describes the BS activation and deactivation facility.

If "Repeater Mode BS established timing" is used, there is one MS sourced data burst required for channel access in repeater mode. This is a BS_Dwn_Act PDU which is used to wakeup or activates the BS outbound. Details are listed in table 5.1. Contents of the BS_Dwn_Act PDU are found in clause 7.1.3. Details of when it is transmitted are found in clauses 4.4.1 and 5.2 of TS 102 361-1 [1].

Table 5.1: Channel access data burst

Data Type	Value	Function	Data Contents	CSBKO
CSBK	0011 ₂	Activate BS Outbound	BS_Dwn_Act	111000 ₂

If "Repeater Mode MS established timing" is used, the BS may activate its outbound channel directly at the Physical Layer PL at the reception of a MS_Sourced_Sync. In this case the BS acts in such way that the MS inbound channel is frame synchronized to the outbound one. Details are found in clauses 4.4.3 and 5.2 of TS 102 361-1 [1].

5.1.1.1.1 BS Outbound Activation SDL

Figure 5.3 illustrates the BS decision process when its receiver synchronizes to an MS sourced sync pattern while in the BS_Hibernating state. This figure is informative with respect to the order of qualification.

If either the Colour Code does not match or the slot type is not CSBK the BS shall stay in the BS_Hibernating state. If both the Colour Code matches and the slot type is CSBK the BS shall start Mobile Station Inactivity timer T_MSInactive, which is defined in clause F.1 of TS 102 361-1 [1], and shall transition to the Hangtime state.

Figure 5.3 illustrates the minimum requirement for BS activation. Additionally, manufacturers may also validate any and or all of the following:

- CSBKO;
- SFID;
- Destination (BS) Address and Source Address.

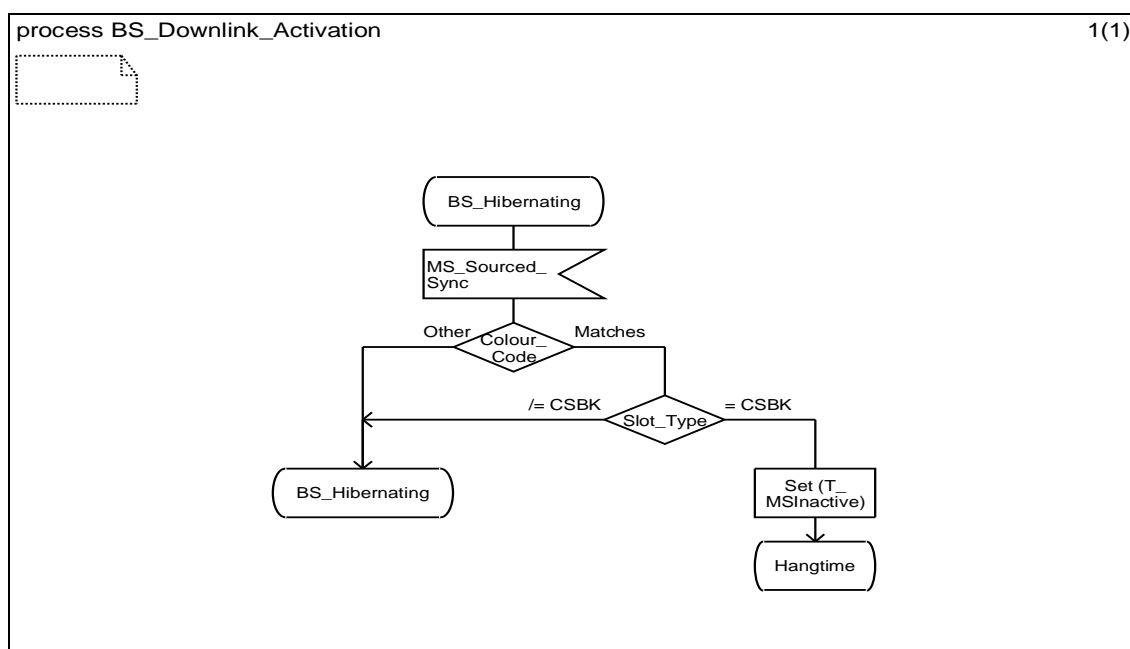

Figure 5.3: BS Activation SDL

5.1.1.1.2 BS MSCs

The following MSCs attempt to show a decomposition of the BS functional layers as defined in clause 4.1 of TS 102 361-1 [1].

NOTE: A CCL_BS process is used to describe the state of both slots while CCL_1 and CCL_2 processes are used to describe the state of slot 1 and slot 2 respectively. This is used for clarification purposes and is purely informative.

5.1.1.1.3 BS_Outbound_Activation

Figure 5.4 illustrates BS actions when it receives a valid wakeup PDU while the CCL_BS is in the BR_Hibernating state.

The CCL_BS starts both the CCL_1 and CCL_2 processes, shall start T_MSInactive and transition to the Hangtime state. CCL_1 and CCL_2 send Generate_Idles primitive to the DLL and both transition to the Channel_Hangtime state.

The DLL starts the outbound and the BS shall transmit Idle PDUs with a Data Type of "Idle" in both slots. Also the CACH AT bit for both slots shall be set to "Idle".

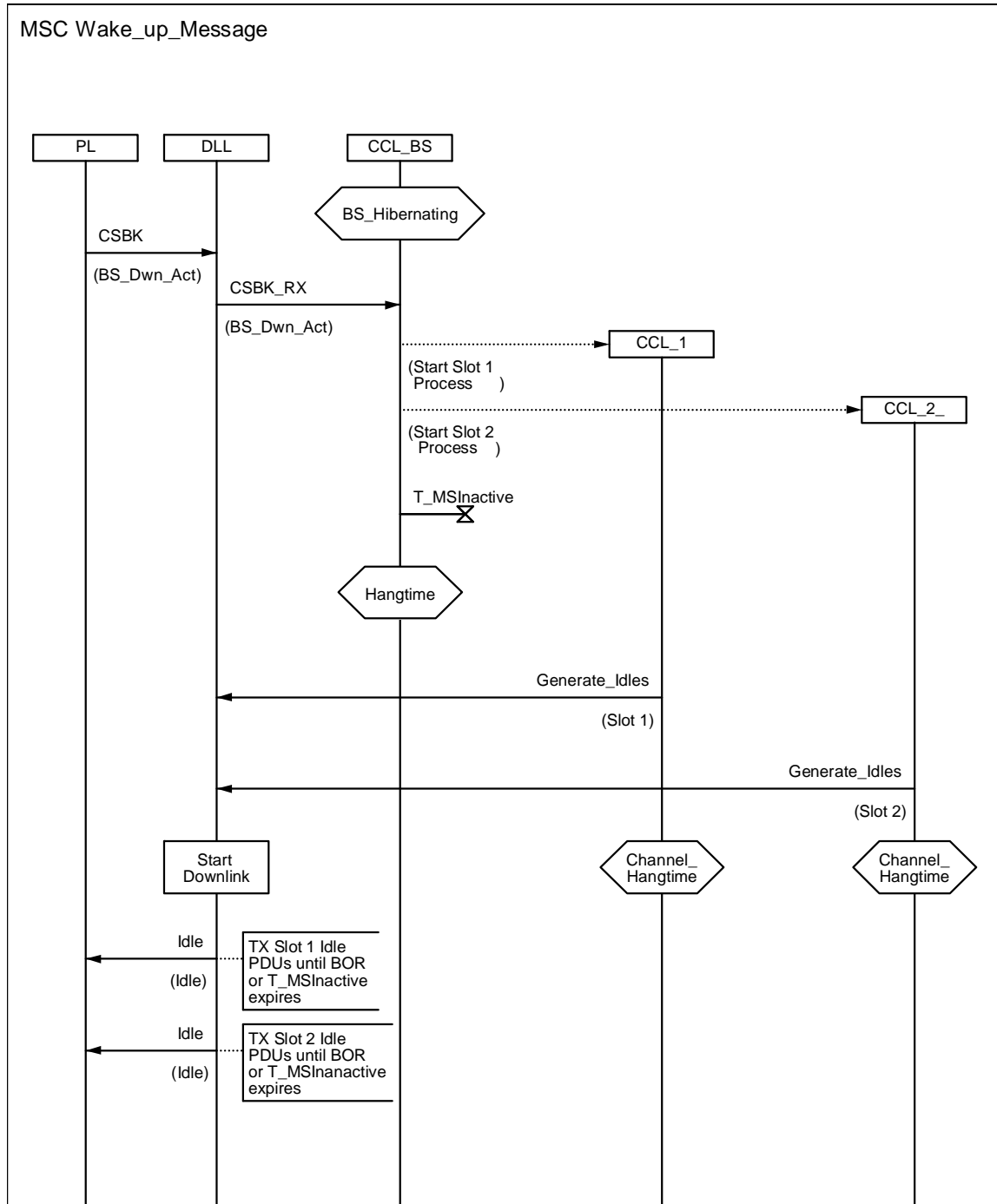

Figure 5.4: BS_Outbound_Activation

5.1.1.2 Voice call repeating

Figure 5.5 illustrates BS actions when it receives a Voice_LC_Header on slot 1 while CCL_1 is in the Channel_Hangtime state. The figure uses the Group Call PDU (Grp_V_Ch_Usr) in this example.

The DLL sends a BOR primitive to the CCL_1 process and stops generating idle messages. CCL_1 transitions to the Repeating_Slot state. The DLL also sends a BOR_Slot_1 primitive to the CCL_BS process. If slot 2 is in Channel_Hangtime or Call_Hangtime states, it transitions to Repeating_Slot_1 state. If slot 2 is in Repeating_Slot state, then CCL_BS transitions to Repeating_Both_Slots state. The DLL shall repeat the Voice_LC_Header and then shall repeat slot 1 voice bursts continuously in this state. While the BS is repeating it should set the CACH AT bit to "busy". The DLL also sends LC information to the CCL_1, which is used for the generation of call hangtime PDUs.

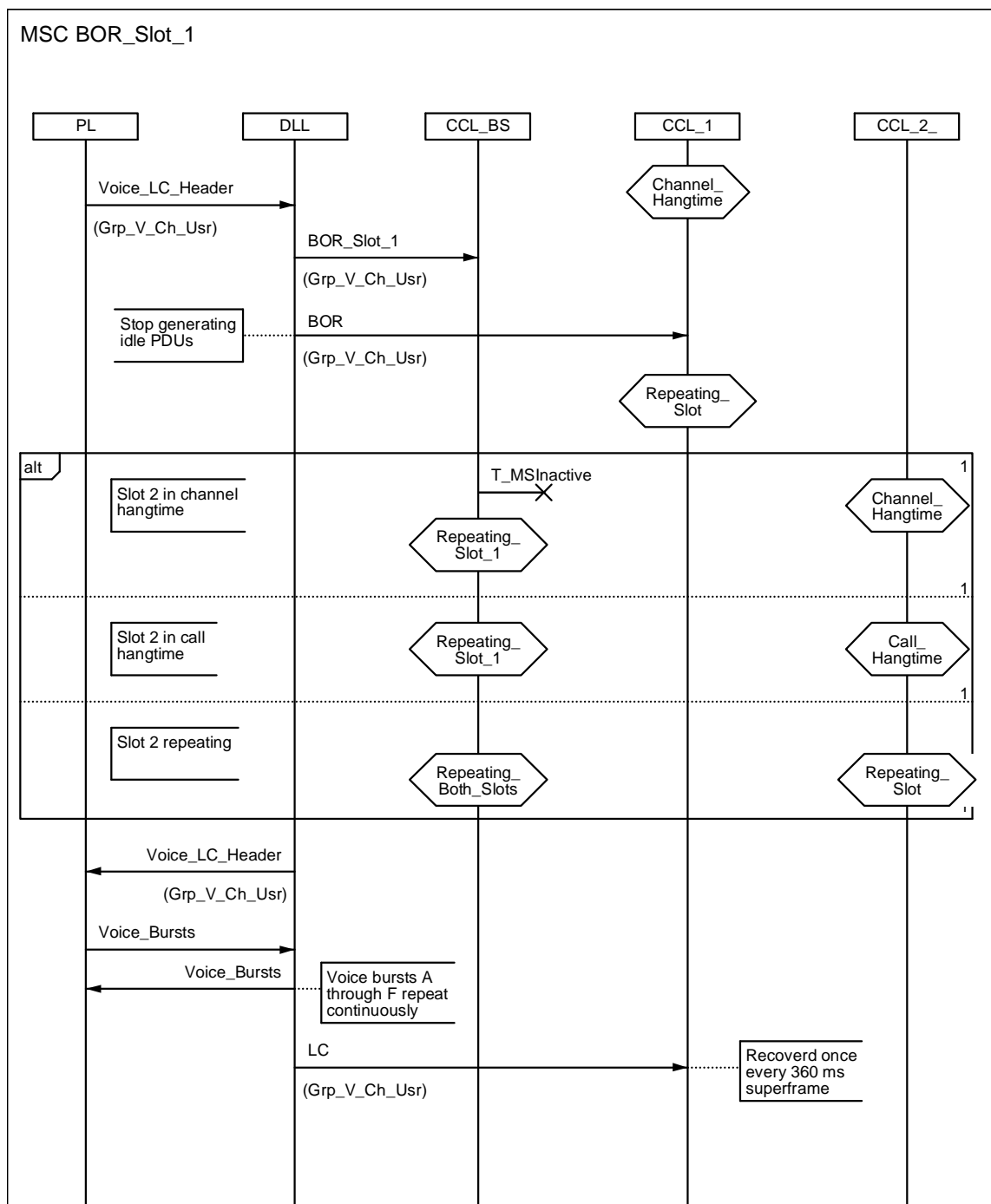

Figure 5.5: BS BOR_Slot_1

5.1.1.3 Voice call hangtime

Figure 5.6 illustrates BS actions when it receives a Terminator_with_LC on slot 1 while CCL_1 is in the Repeating_Slot_1 state. The figure uses the Group Call PDU (Grp_V_Ch_Usr) in this example.

The DLL sends an EOR primitive to the CCL_1 process which starts Call Hangtime Timer (T_CallHt) and transitions to the Call_Hangtime state. The DLL also sends an EOR_Slot_1 primitive to the CCL_BS process. If slot 2 is in Channel_Hangtime or Call_Hangtime states, it transitions to Hangtime state. If slot 2 is in Repeating_Slot state, then CCL_BS transitions to Repeating_Slot_2 state. The CCL_1 sends Generate_Terminators primitive to the DLL for call hangtime messages. The BS shall transmit call hangtime PDUs in this state and set the CACH AT bit to "busy". When the T_CallHt expires, the CCL_1 transitions to the Channel_Hangtime state and sends Generate_Idles primitive to the DLL. The BS shall transmit Idle message PDUs as defined in clause D.2 of TS 102 361-1 [1] with a Data Type of "Idle" and the CACH AT bit set to "idle" in this state.

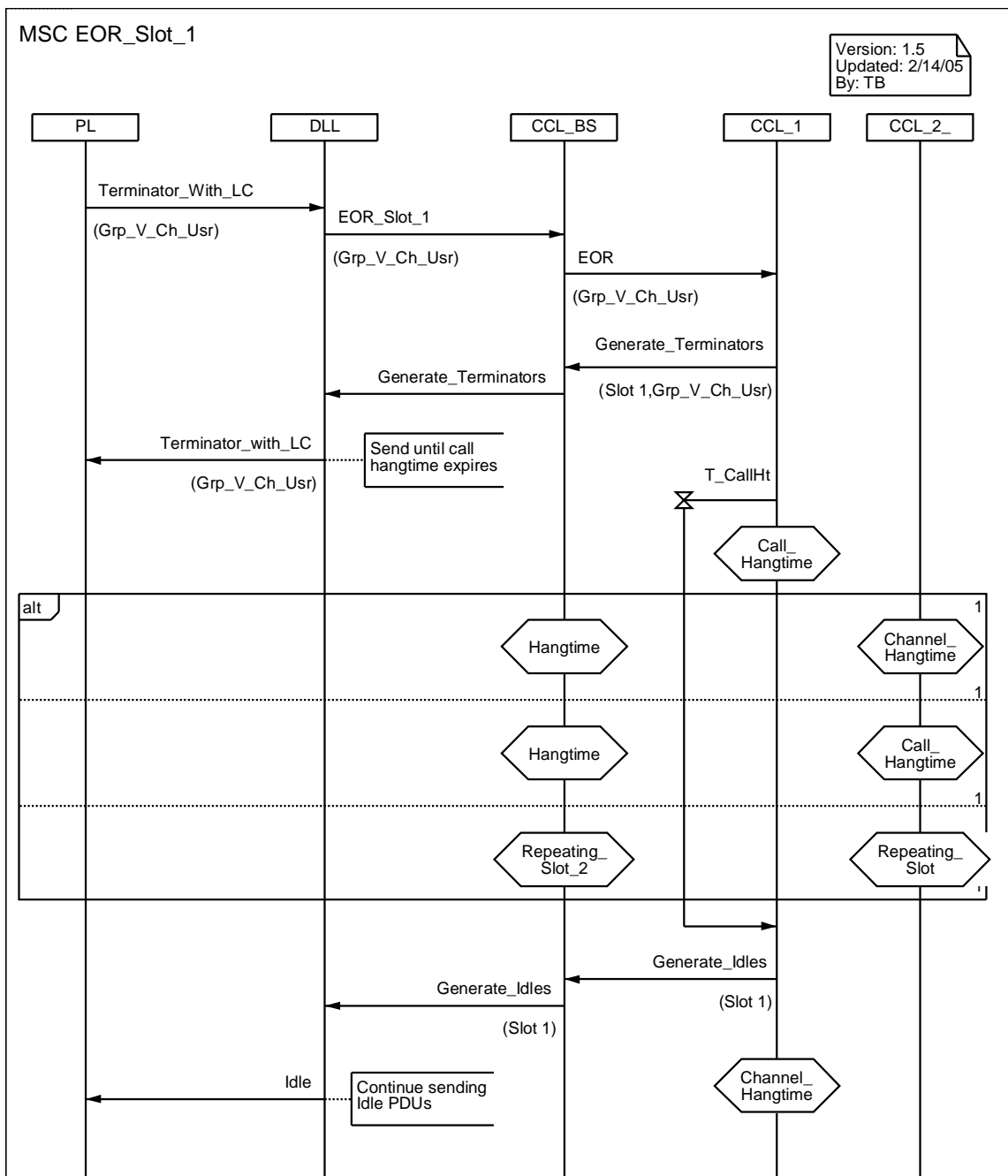

Figure 5.6: BS EOR_Slot_1

5.1.1.4 CSBK repeating

Figure 5.7 illustrates BS actions when it receives a CSBK on slot 1 while in the Channel_Hangtime state.

The BS CCL_1 sends a TX_CSBK_Slot_1 primitive to the DLL to repeat the CSBK and stays in the Channel_Hangtime state. The BS shall repeat the received CSBK.

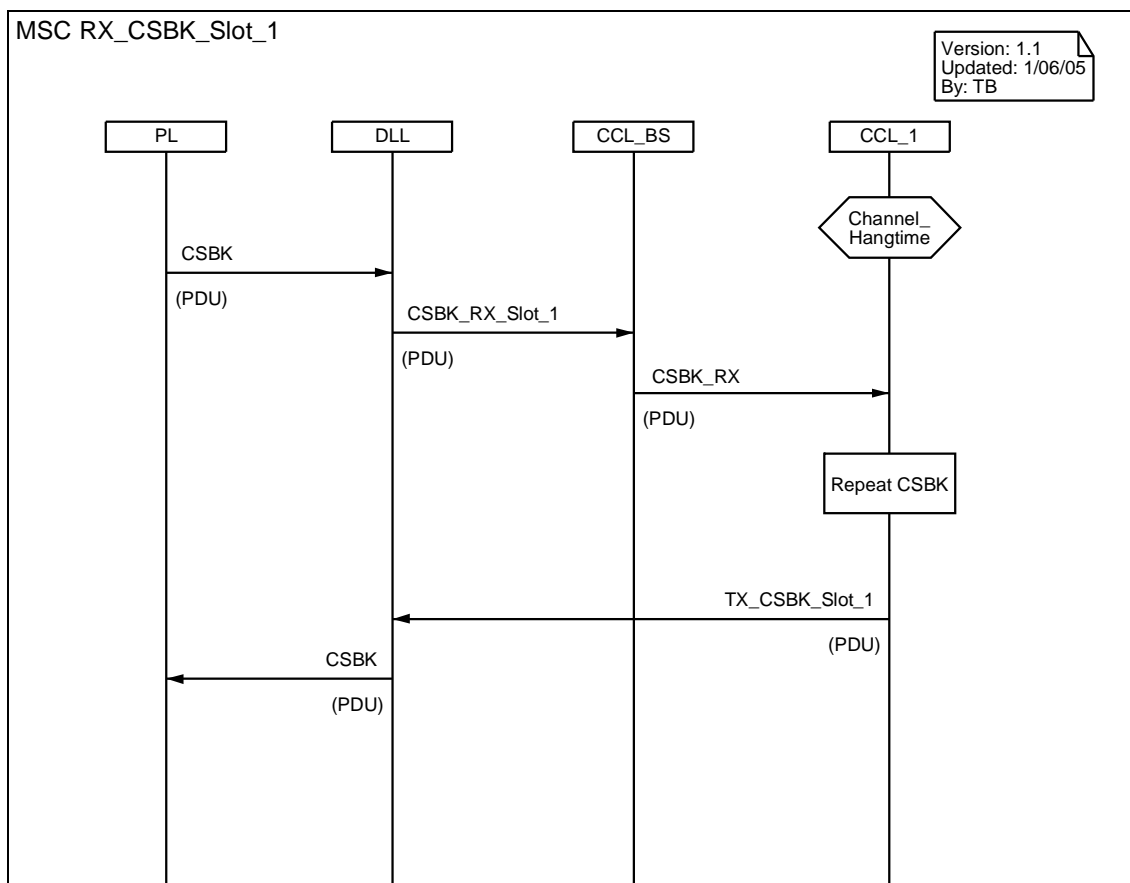

Figure 5.7: CSBK Repeating

5.1.1.5 BS outbound deactivation

Figure 5.8 illustrates BS actions when its Mobile Station Inactivity Timer ($T_{MSInactive}$) expires.

The CCL_BS sends Kill_Slot Process primitive to CCL_1 and CCL_2 and transitions to the BS_Hibernating state. Here the BS shall cease transmitting, which deactivates the outbound.

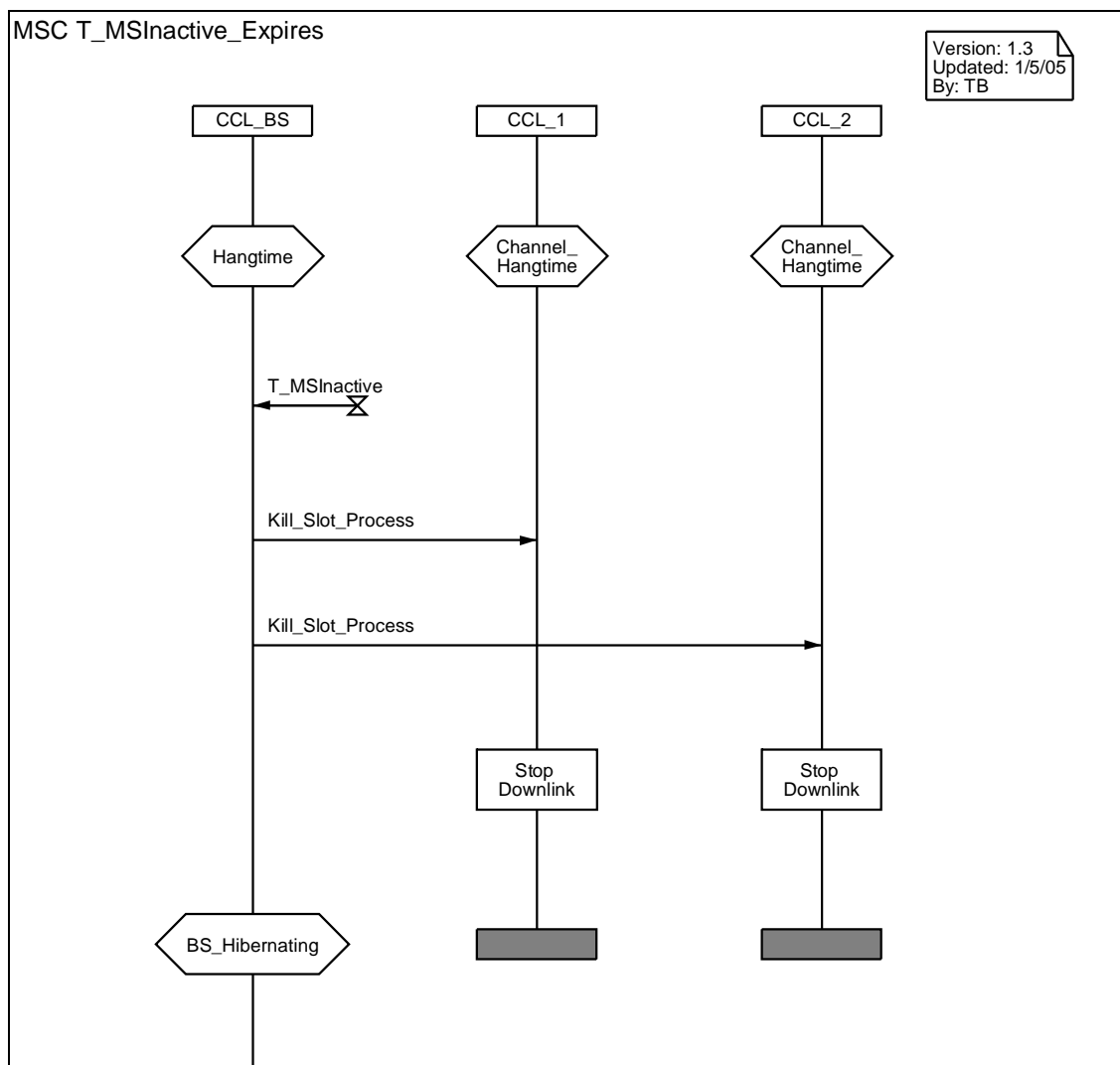

Figure 5.8: BS_Outbound_Deactivation

5.1.2 Feature Not Supported (FNS) signalling

The Feature Not Supported (FNS) signalling shall be used when an MS is individually addressed with feature signalling it does not support. The non-supported feature signalling received by the MS occurs through a PDU that contains a Standard FID (SFID) and a CSBKO that it does not support.

The MS may use either impolite or polite non-time critical CSBK ACK/NACK channel access procedure as defined in clause 5.2.2.3 of TS 102 361-1 [1], to transmit the FNS signalling PDU.

5.1.2.1 FNS Data Bursts/Fields

When a feature is not supported, the target MS shall attempt to respond to the source MS with a negative Acknowledgement Response (NACK_Rsp) CSBK PDU. Details are listed in table 5.2. Contents of the NACK_Rsp PDU are found in clause 7.1.2.4.

Table 5.2: Feature Not Supported data burst

Data Type	Value	Function	Data Contents	CSBKO
CSBK	0011 ₂	FNS Signalling	NACK_Rsp	100110 ₂

5.1.2.2 MS FNS MSC

Figure 5.9 illustrates the MSC for a NACK_Rsp with polite channel access. Here the DLL, after receiving the TX_Request primitive, sets Idle Search Timer (T_IdleSrch) as defined in TS 102 361-1 [1] and determines the channel status. If the channel status is idle then the NACK_Rsp PDU shall be transmitted. Alternatively, if the channel is busy the DLL starts the Random_Holdoff timer (T_Holdoff), as defined in TS 102 361-1 [1]. If the channel is busy the MS shall complete at least one holdoff cycle in its attempt to transmit the NACK_Rsp.

In this example at the expiration of the timer, if the channel is idle the PDU is transmitted and if the channel is busy the timer is restarted. It is the responsibility of the DLL to transmit the message. The only role of the CCL is to determine the feature is not supported and to instruct the DLL to transmit the NACK_Rsp PDU.

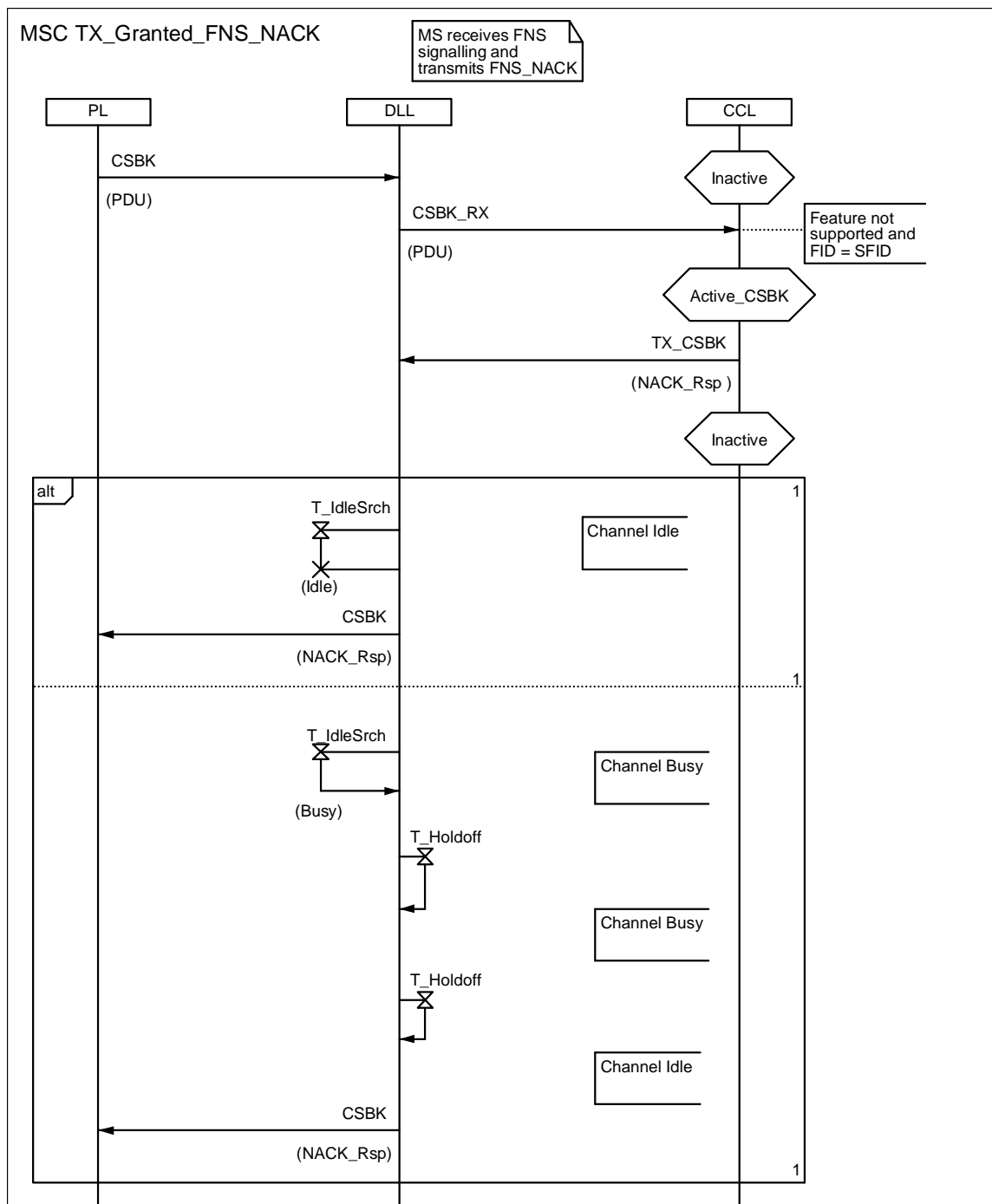

Figure 5.9: TX Granted for FNS_NACK

5.2 Primary voice services

5.2.1 Group call service

The group call service provides voice call service between one individual user and a predetermined group of users. All parties in the group can hear each other. The group call is initiated at the user level by selecting the desired group via a predefined selection procedure (see note) and then activating a mechanism to talk, such as pressing the PTT button.

NOTE: The selection procedure is implementation specific and is not part of the present document.

5.2.1.1 Service description

Group call initiation or Beginning Of Call (BOC) follows a predetermined channel access mechanism. This access procedure may use any of the standard channel access procedures. These procedures are impolite, polite to own Colour Code and polite to all.

The first burst at the Beginning Of Transmission (BOT), which may be the BOC, carries the necessary information to allow the selected group to be notified of that call. This is accomplished with the Group Voice Channel User (Grp_V_Ch_Usr) LC Message using the Voice LC Header Data Type burst. The first voice burst is preceded by a Voice LC Header in the appropriate slot. This is illustrated in figure 5.4 of TS 102 361-1 [1].

Group call supports late entry into a call by embedding the LC information into the voice bursts. This helps support scanning, radios being powered on during a transmission addressed to that particular unit and units that do not correctly decode the voice header. This is accomplished with the Group Voice Channel User (Grp_V_Ch_Usr) LC message.

A Group Call End Of Transmission (EOT) shall be accomplished by transmitting the entire last voice superframe (through voice burst "F"), and then sending the Group Voice Channel User (Grp_V_Ch_Usr) LC Message using the Terminator with LC Data Type burst. This is illustrated in figure 5.8 of TS 102 361-1 [1].

Call hangtime is used in order to extend a call past the End of Transmission. End Of Call (EOC) occurs at the expiration of call hangtime.

5.2.1.2 Group call data bursts/fields

5.2.1.2.1 Direct mode

The Group call service requires two data type bursts and two embedded field messages. These are listed in tables 5.3 and 5.4 respectively. The contents of the embedded LC, Grp_V_Ch_Usr PDU, are defined in clause 7.1.1.1. Contents of the embedded Null message are defined in clause D.1 of TS 102 361-1 [1]. The Null message is embedded in the "F" burst of the voice superframe on the forward channel.

Table 5.3: Group call data bursts

Data Type	Value	Function	Data Contents	FLCO
Voice LC Header	0001 ₂	Transmission Addressing	Grp_V_Ch_Usr	000000 ₂
Terminator with LC	0010 ₂	End of Transmission	Grp_V_Ch_Usr	000000 ₂

Table 5.4: Group call embedded field messages

Link Control (LC) Message	FLCO	Function	Bursts
Grp_V_Ch_Usr	000000 ₂	Late Entry	4
Null	NA	Filler	1

5.2.1.2.2 Repeater mode

Repeater mode uses the same data bursts or fields as direct mode as defined in clause 5.2.1.2.1. However, the BS also generates Grp_V_Ch_Usr LC PDUs using the Terminator with LC data type burst to signal call (reserved) hangtime. The Null message is always embedded in the F burst of the voice superframe on the inbound channel and embedded in the reverse channel location on the outbound channel when no reverse channel signalling is required.

5.2.1.3 MS group call control

5.2.1.3.1 MS group call SDL

Figure 5.10 illustrates the MS CCL when a group call transmission is requested and is informative.

The Inactive state is any CCL state with the exception of My_Call or In_Session. The CCL sends a TX_Request primitive to the DLL and transitions to the Wait_for_TX_Response state. If the TX_Denied primitive is received from the DLL, the CCL transitions to the inactive state. If the TX_Granted primitive is received from the DLL, the CCL sends the BOTx primitive and transitions to the TX_Voice state. When the transmission ends, the CCL transitions to the In_Session state.

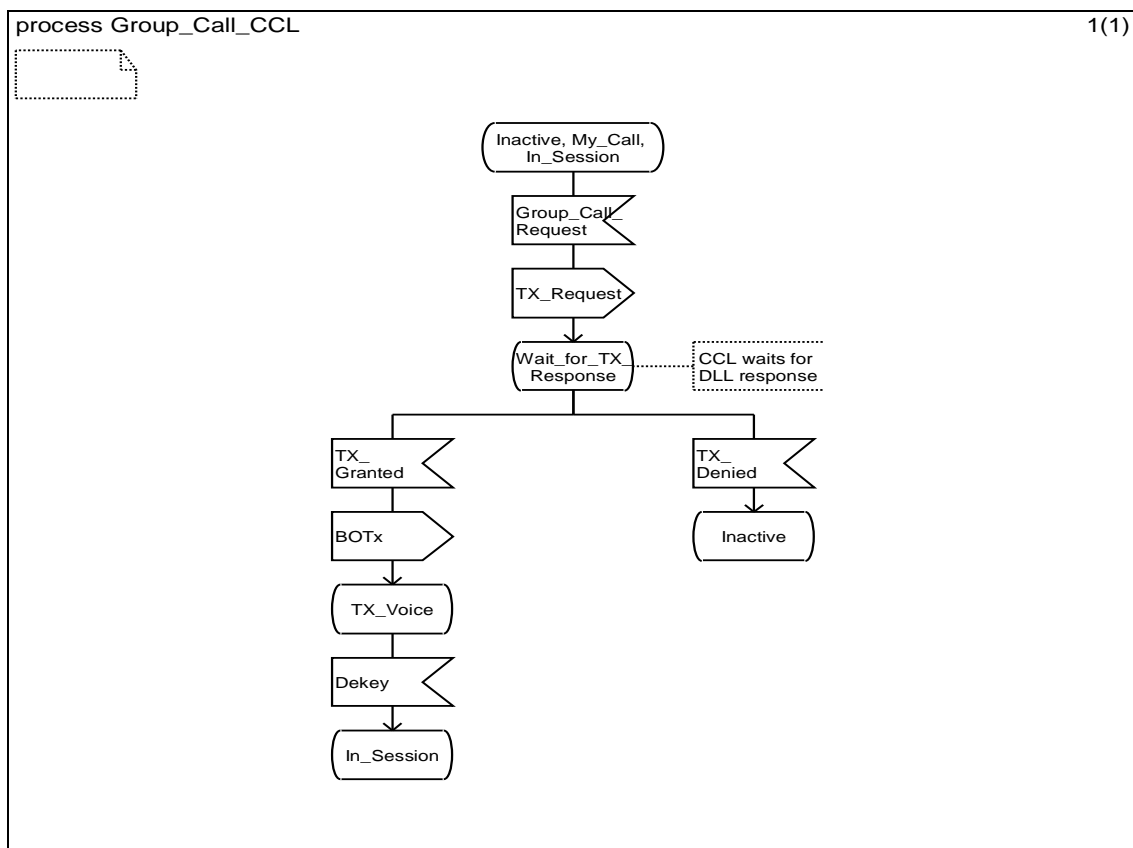

Figure 5.10: Group Call CCL SDL

5.2.1.3.2 MS group call HMSC

Figure 5.11 illustrates the HMSC for a group call.

For descriptions of various states in this diagram refer to clause G.1 of TS 102 361-1 [1].

Figure 5.11 shows two entry points. The entry point into PTT is for transmission and the entry point into Not_in_Call is for reception. The illustration is the same for direct mode and repeater mode. A minor difference between the two modes occurs because the In_Session state does not exist in direct mode. In this case the MS shall immediately transition to the Out_of_Sync state since the outbound cannot be found.

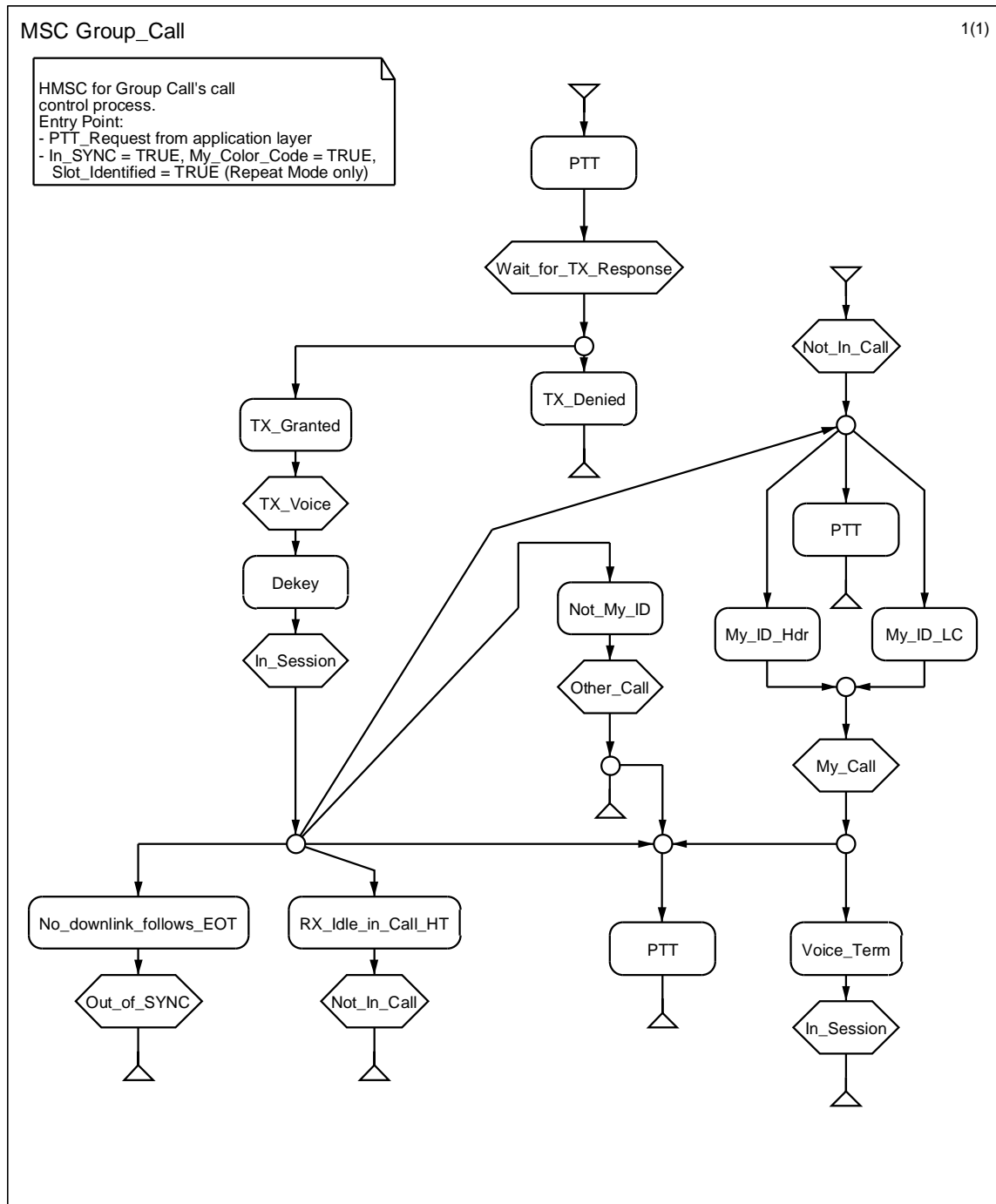

Figure 5.11: Group Call HMSC

5.2.1.3.3 MS group call MSCs

The following MSCs attempt to show a decomposition of the MS functional layers as defined in clause 4.1.

5.2.1.3.3.1 MS MSC PTT

Figure 5.12 illustrates the MS CCL receiving a PTT_Request primitive. Though the action boxes in figure 5.12 indicate this is a BOC, the MSC with respect to the primitives is the same if the MS is in one of the following states:

- My_Call;
- Not_in_Call;
- In_Session; or
- Other_Call.

The CCL sends a TX_Request primitive to the DLL and transitions to the Wait_for_TX_Response state. In this state the CCL waits for a TX_Granted or TX_Denied primitive from the DLL channel access process.

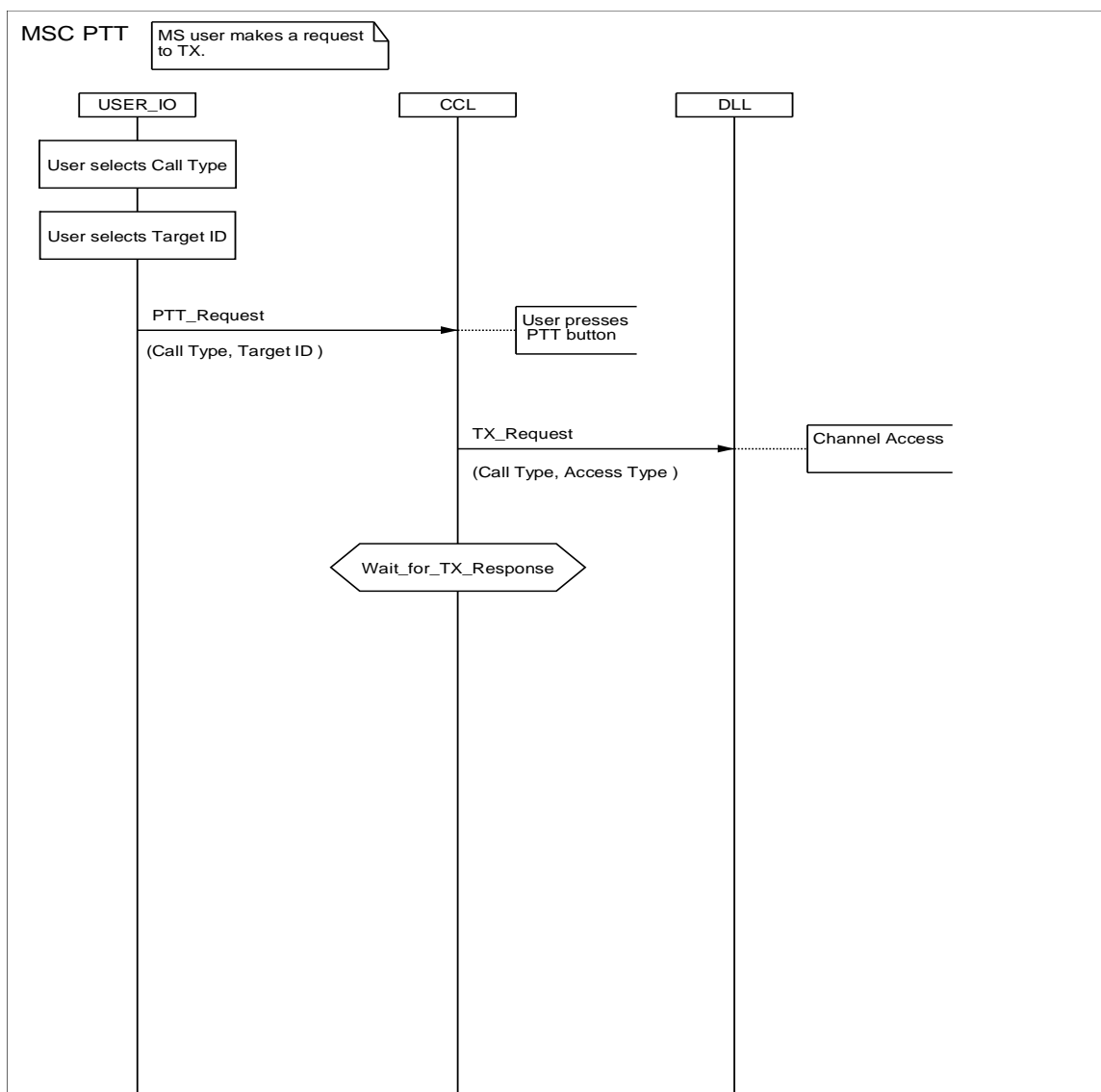

Figure 5.12: MSC PTT

5.2.1.3.3.2 MS MSC TX_Denied

Figure 5.13 illustrates MS actions when the DLL sends a TX_Denied primitive to the CCL.

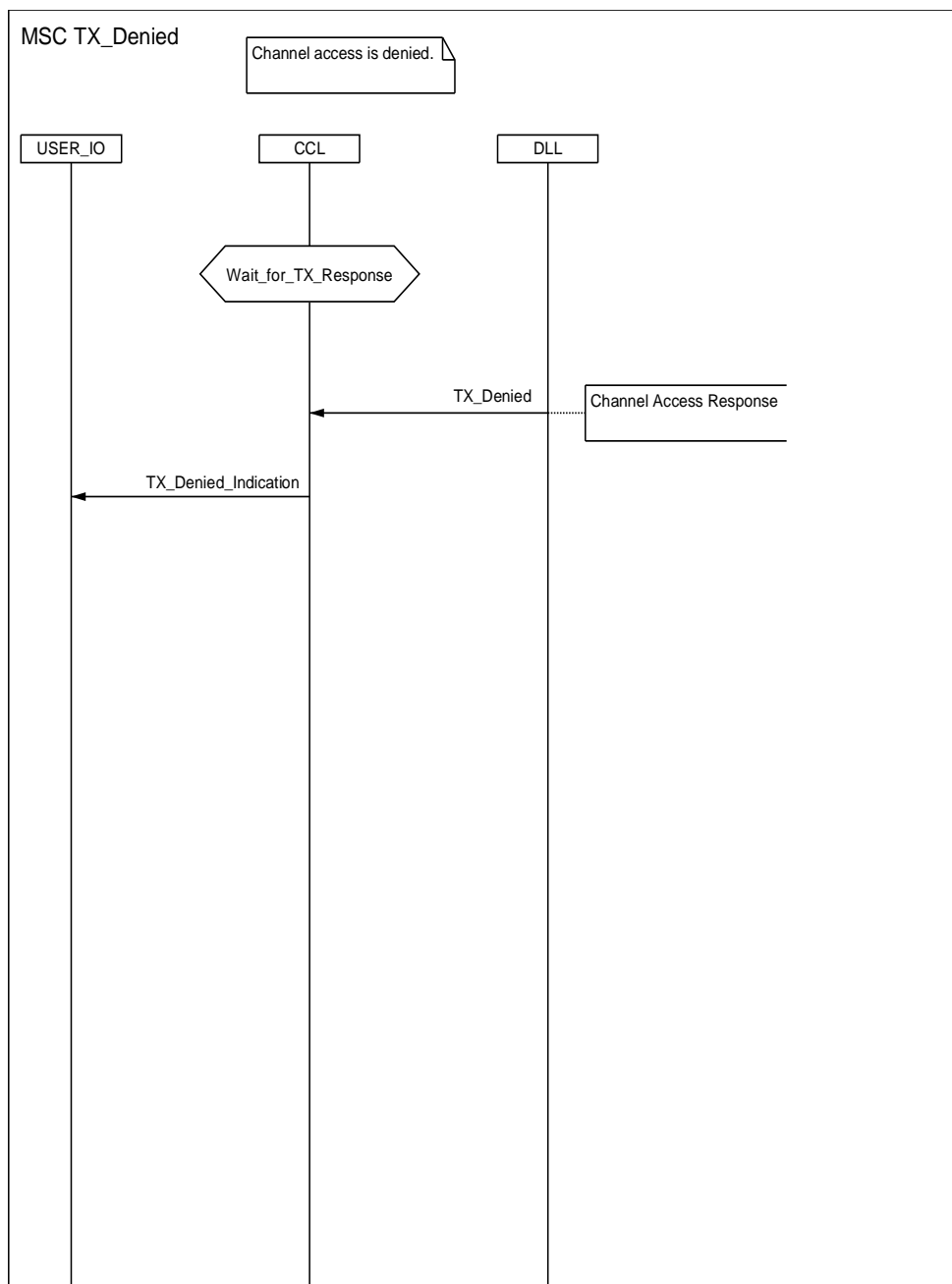

Figure 5.13: MSC TX_Denied

5.2.1.3.3.3 MS MSC TX_Granted

Figure 5.14 illustrates MS actions when the DLL sends a TX_Granted primitive to the CCL.

After receiving the TX_Granted primitive the CCL sends a BOTx primitive to the DLL to indicate beginning of transmission and then transitions to the TX_Voice state. The DLL proceeds by sending the Voice_LC_Header (Grp_V_Ch_Usr) PDU followed by a voice burst stream on the appropriate slot.

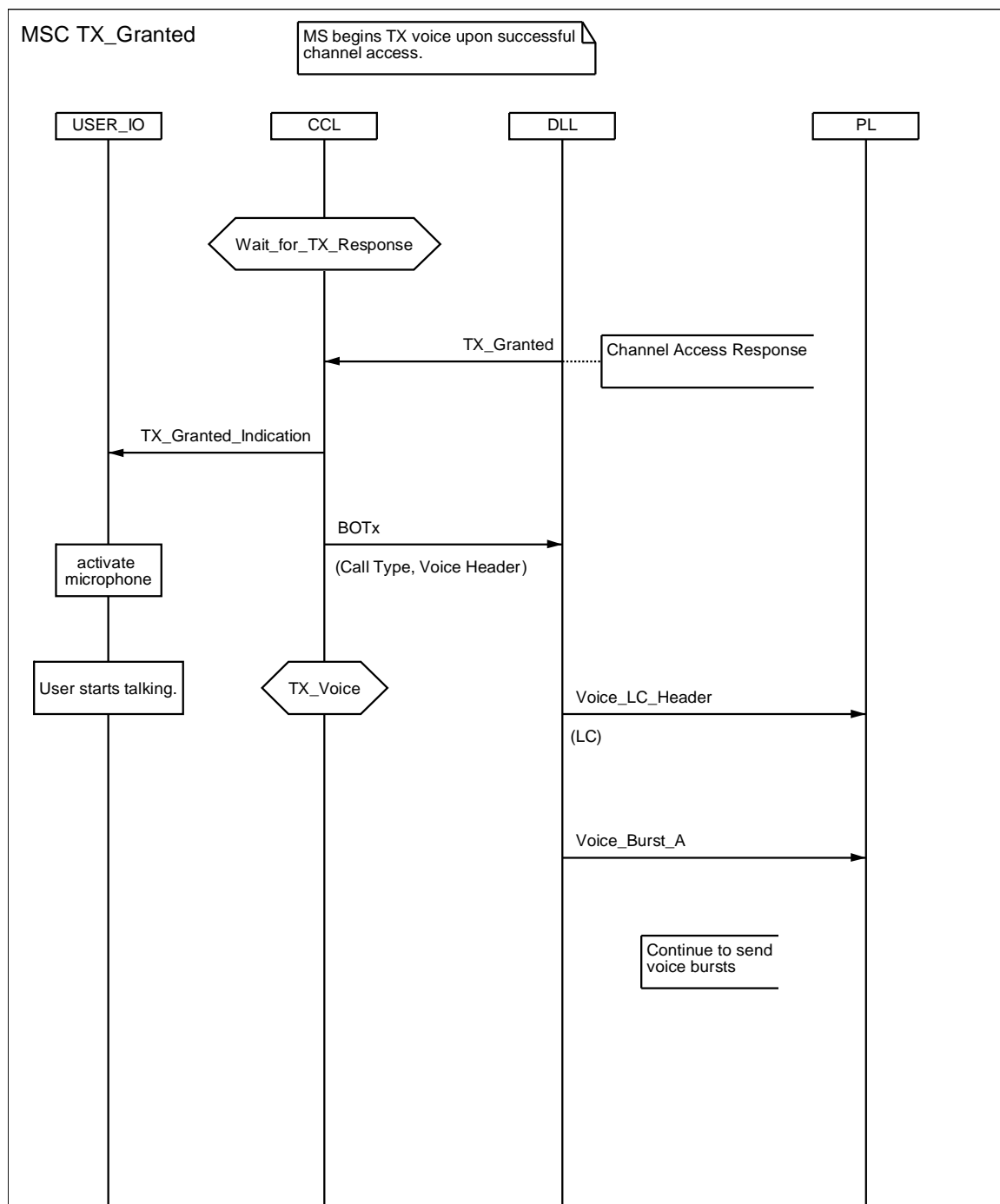

Figure 5.14: MSC TX_Granted

5.2.1.3.3.4 MS MSC My_ID_Header

Figure 5.15 illustrates MS actions when its CCL receives an address match in the DLL transmitted BORx primitive while in either the In_Session (call hangtime) or Not_in_Call (channel hangtime) states. This occurs when the MS receives the Grp_V_Ch_Usr PDU that contains a matching address.

The CCL transitions to the My_Call state when the destination ID matches. Voice is sent directly from the DLL to the User_IO.

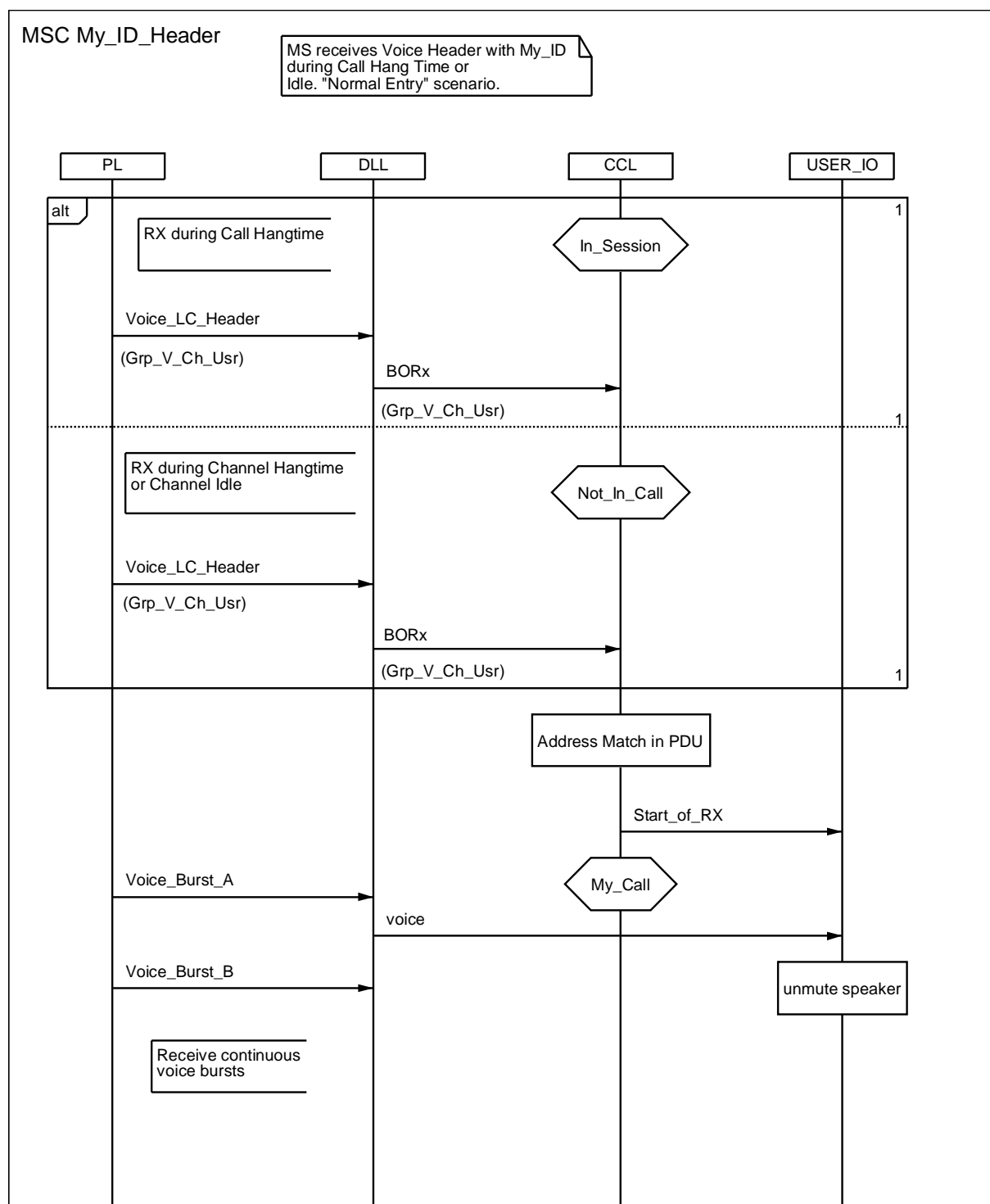

Figure 5.15: MSC My_Header_LC

5.2.1.3.3.5 MS MSC My_ID_LC

Figure 5.16 illustrates MS actions when its CCL receives an address match in the DLL transmitted LC primitive while in either the In_Session (call hangtime) or Not_in_Call (channel hangtime) states. This occurs when the MS receives the Grp_V_Ch_Usr PDU that contains a matching address via the embedded LC PDU in the voice superframe.

This is a late entry scenario. The CCL transitions to the My_Call state and the speaker is un-muted. Voice is sent directly from the DLL to the User_IO.

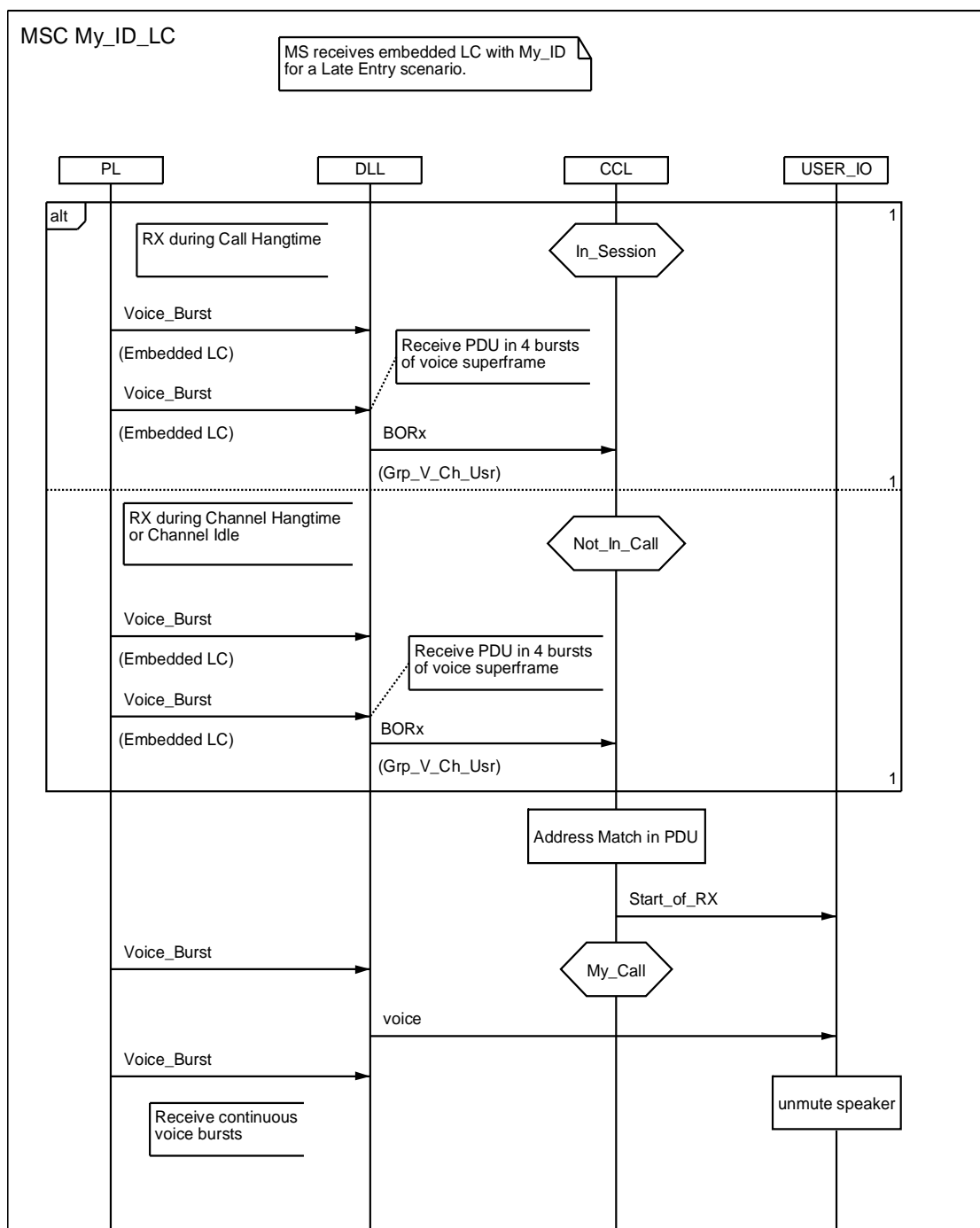

Figure 5.16: MSC My_ID_LC

5.2.1.3.3.6 MS MSC Dekey

Figure 5.17 illustrates MS actions when PTT is released.

The CCL receives a Dekey_Indication primitive and sends an EOTx primitive to the DLL. The MS shall pad out the superframe through voice burst "F" and then shall send a Terminator_with_LC (Grp_V_Ch_Usr) PDU. The CCL transitions to the In_Session state.

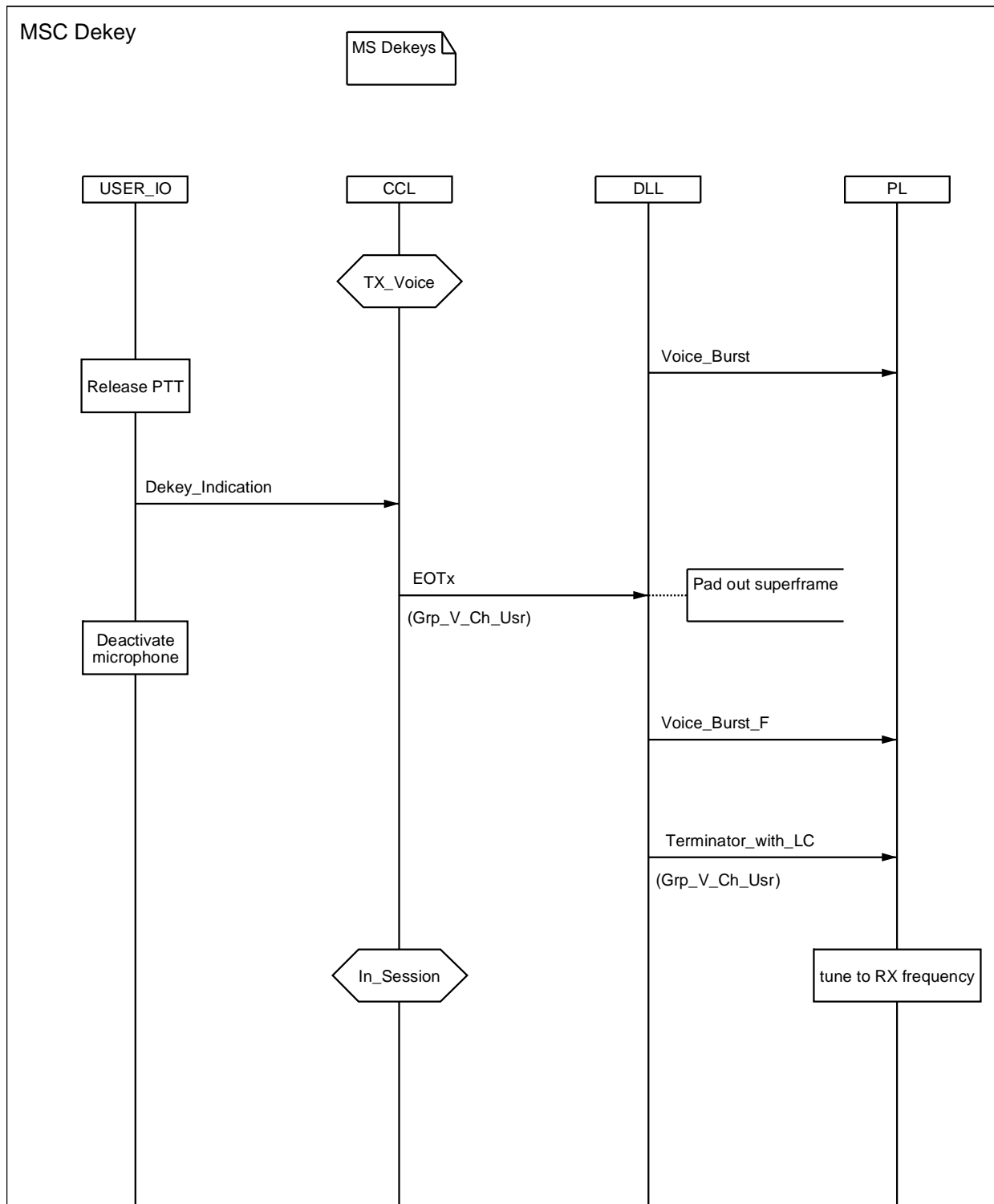

Figure 5.17: MSC Dekey

5.2.1.3.3.7 MS MSC terminator

Figure 5.18 illustrates MS actions when it receives a terminator while the CCL is in the My_Call state.

The DLL sends an EORx primitive to the CCL. The CCL sends an End_of_RX primitive, which mutes the speaker, and transitions to the In_Session state. In direct mode, since there is no hangtime, the MS will then quickly transition to the Out_of_Sync state. See figure 5.21 for details.

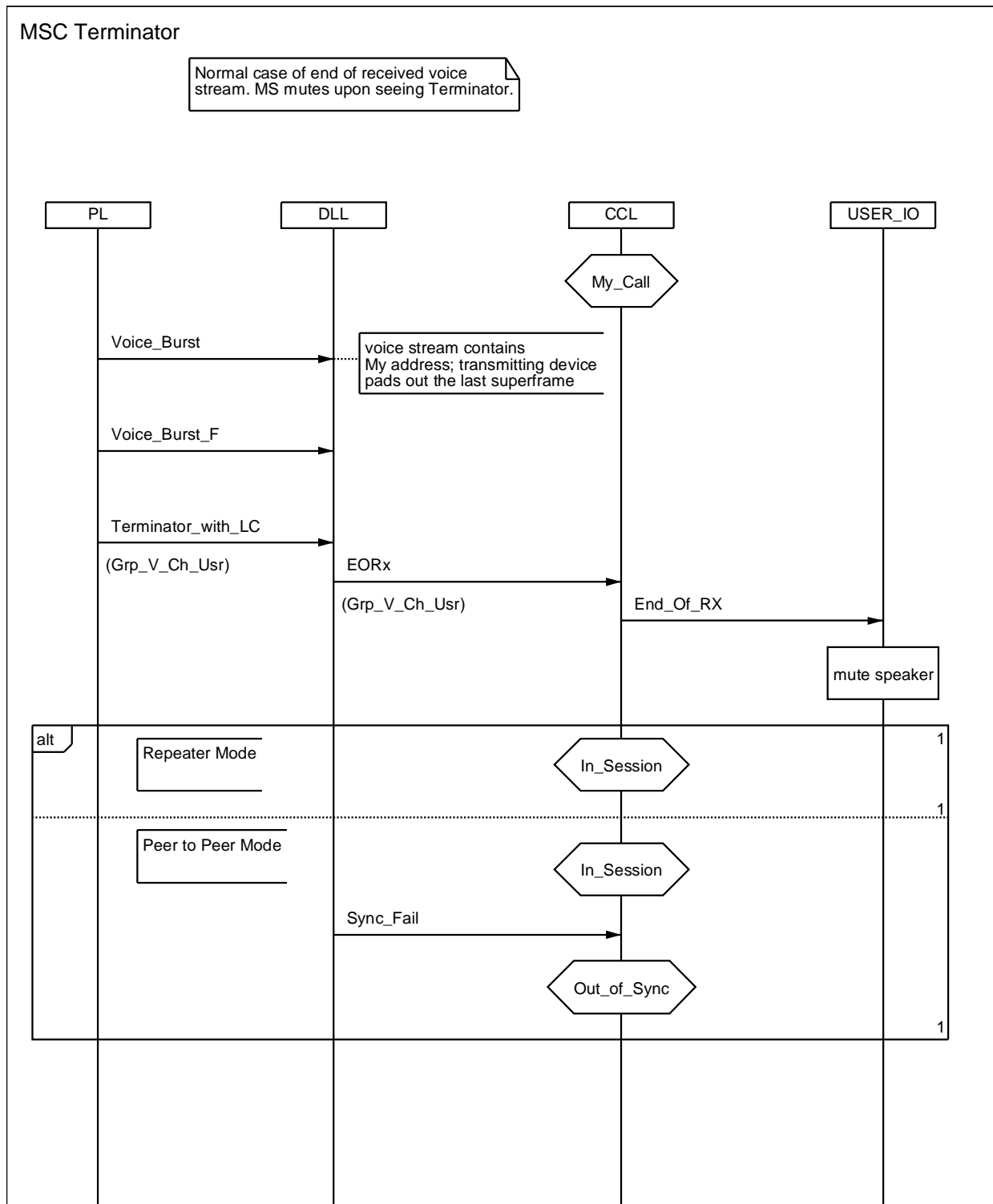

Figure 5.18: MSC Terminator

5.2.1.3.3.8 MS MSC RX_Idle_SYNC_in_Call_HT

Figure 5.19 illustrates MS actions when an Idle PDU is received while the CCL is in the In_Session state.

The DLL sends an Idle_Data primitive to the CCL, which ends the call, and transitions to the Not_in_Call state.

NOTE: This is for repeater mode only and indicates the end of call hangtime.

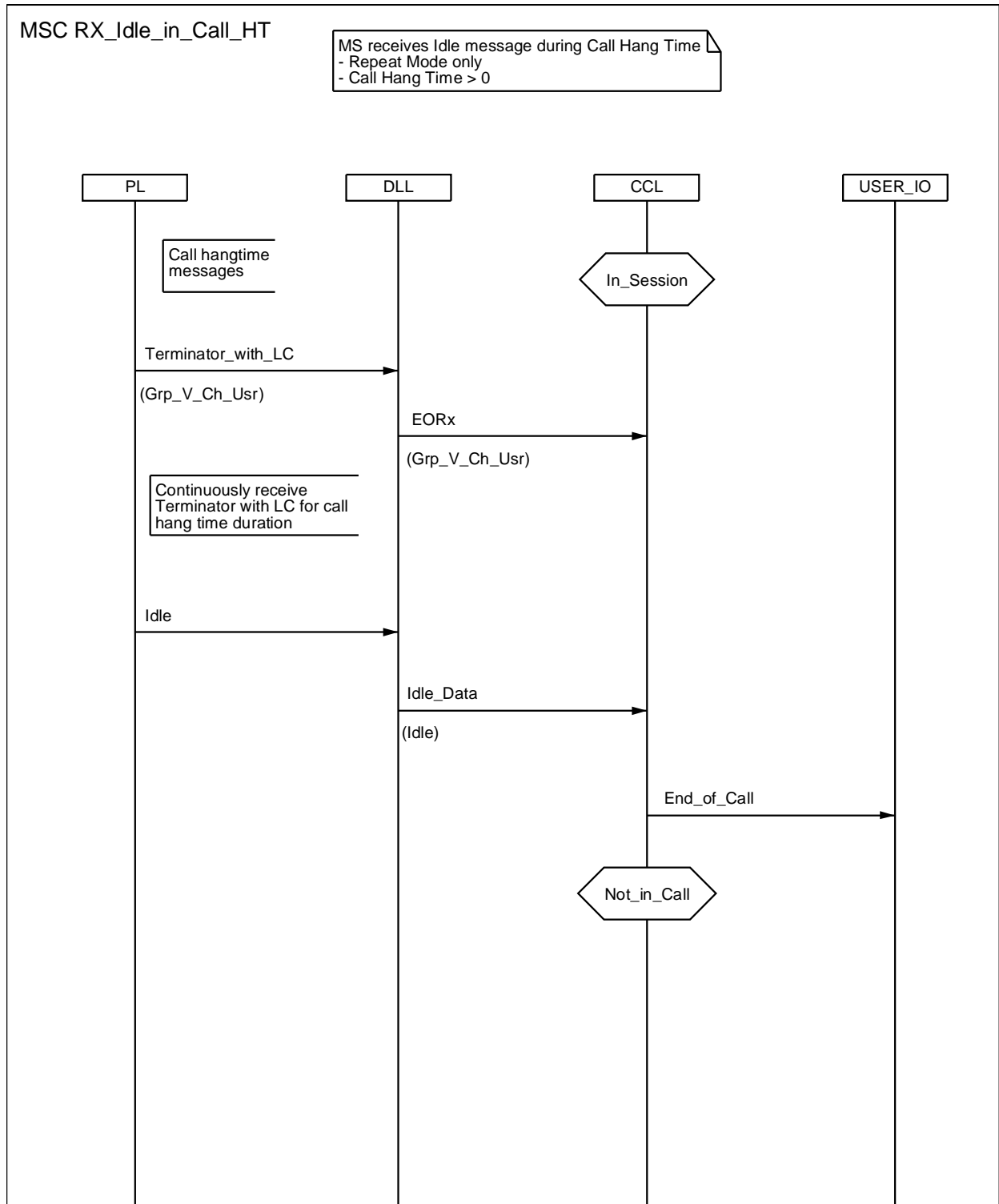

Figure 5.19: MSC RX_Idle_SYNC_in_Call_HT

5.2.1.3.3.9 MS MSC Not_My_ID

Figure 5.20 illustrates MS actions when it receives a mismatched address while the in Call Hangtime.

In Call Hangtime the MS CCL is in the In_Session state. The DLL sends the CCL an EOC primitive when the address is determined to not match the address in Call Hangtime. This can be decoded from either a Voice_LC_Header or an Embedded_LC containing a voice call PDU. In this example the PDU is Grp_V_Ch_Usr which indicates another Group Call is on the channel. The CCL ends the call and transitions to the Other_Call state.

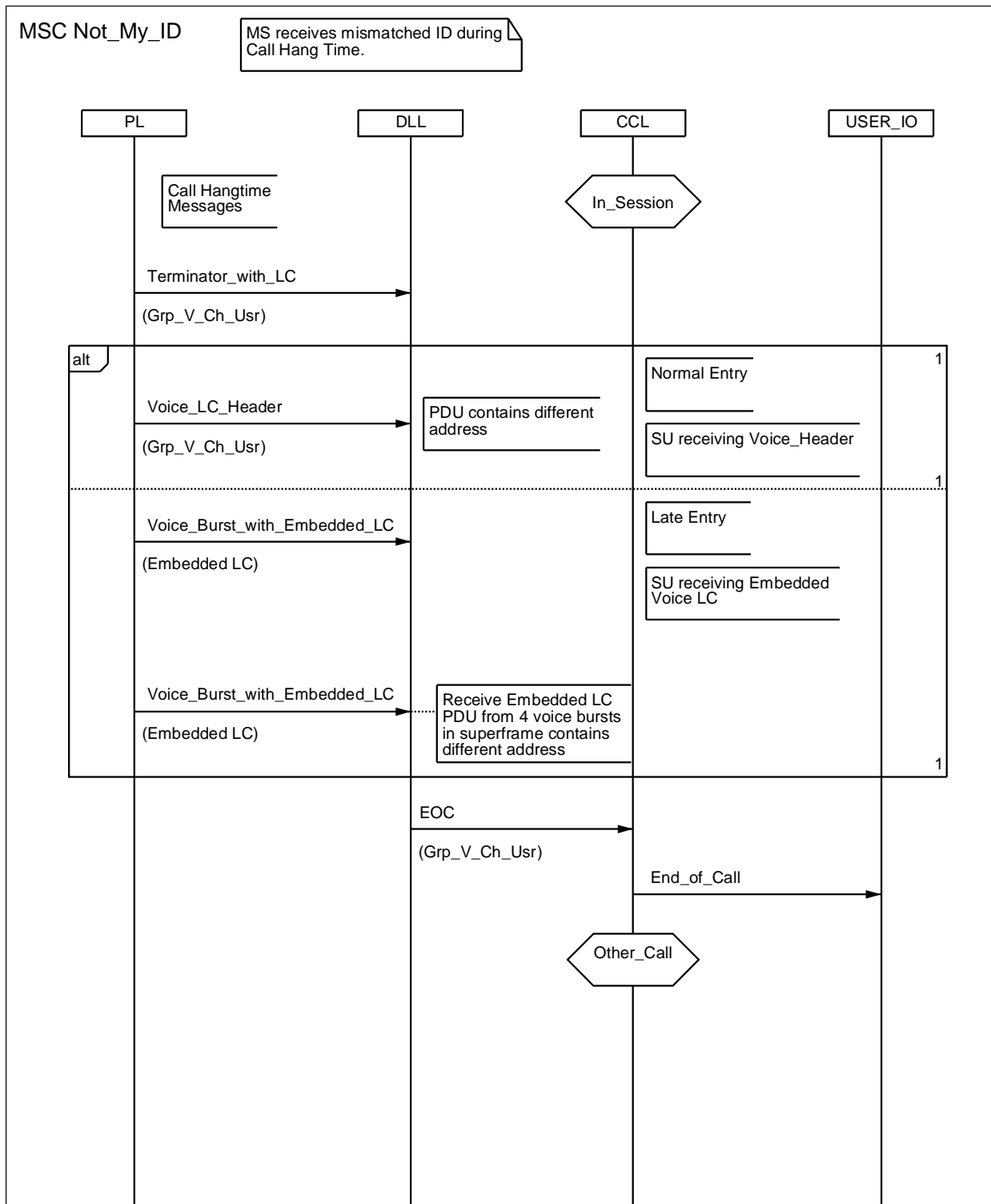

Figure 5.20: MSC Not_My_ID

5.2.1.3.3.10 MS MSC No_outbound_follow_EOT

Figure 5.21 illustrates MS actions when it does not find sync while in the In_Session state.

The DLL sends a Sync_Fail primitive to the CCL. The CCL ends the call and transitions to the Out_of_Sync state, which can occur after it stops transmitting.

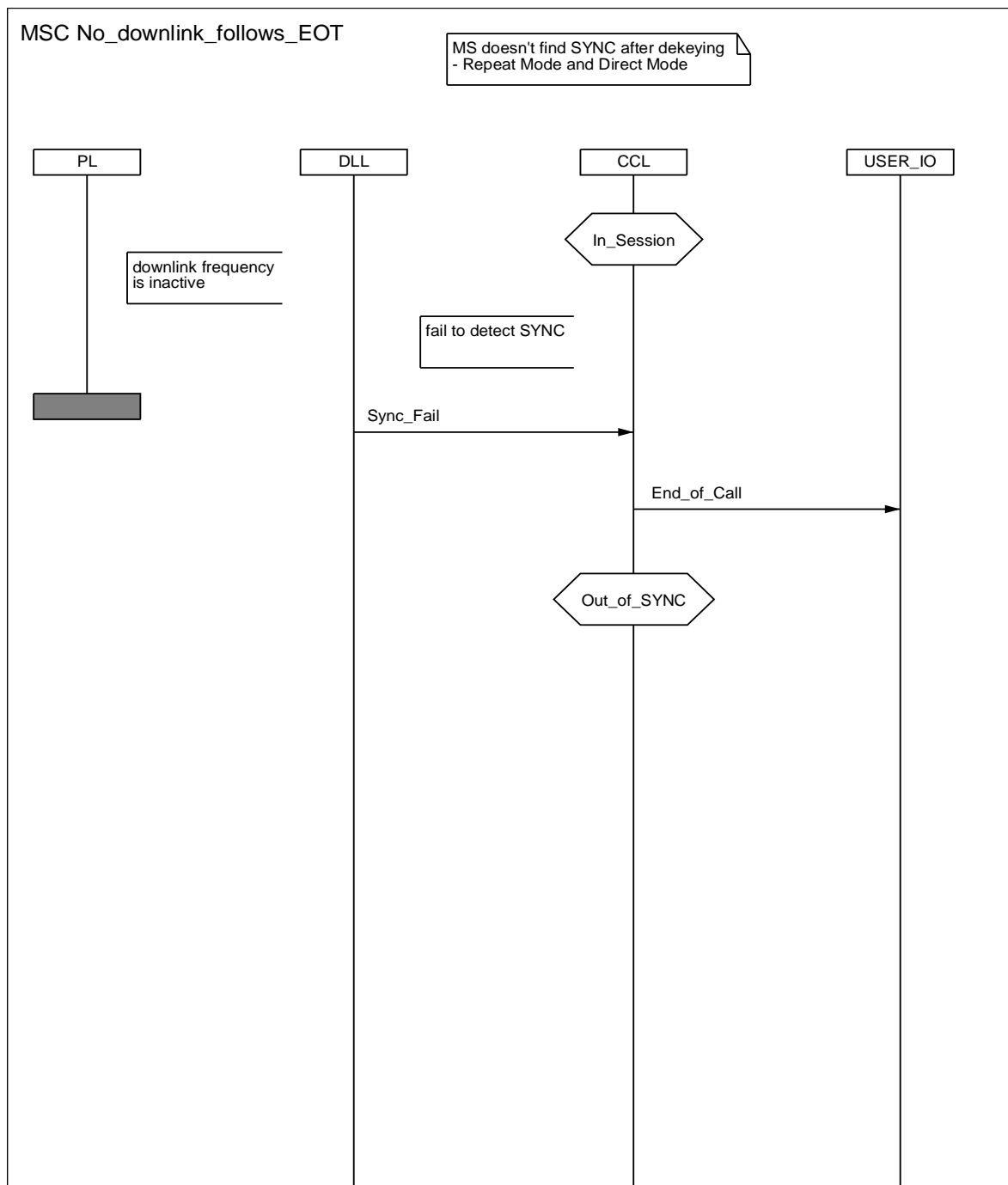

Figure 5.21: MSC No_Outbound_Follow_EOT

5.2.2 Individual call service

The Individual Call service provides voice service between one individual user and another individual user. The Individual Call facility is initiated at the user level by selecting the desired individual via a predefined selection procedure (see note) and then activating a mechanism, such as pressing the PTT button.

NOTE: The selection procedure is implementation specific and is not part of the present document.

5.2.2.1 Service description

Individual Call initiation or Beginning Of Call (BOC) may occur in one of two defined call setup methods:

- the first method is a Press And Talk Call Setup (PATCS); and
- the second method is an Off Air Call SetUp (OACSU).

The PATCS method may employ Impolite, Polite to Own Colour Code or Polite to All Channel Access, whereas the OACSU method may only employ Polite to Own Colour Code or Polite to All Channel Access. An MS in either the In_Session or My_Call High Level states shall use an impolite Channel Access mechanism.

In the OACSU method the source MS attempts a presence check of the target MS. This is accomplished with the Unit to Unit Voice Channel User (UU_V_Req) CSBK message. When the target MS receives the request message, it shall respond automatically with an acknowledgement. This shall be accomplished with the Unit to Unit Answer Response (UU_Ans_Rsp) CSBK message for an accept response and shall be accomplished with either the Unit to Unit Answer Response (UU_Ans_Rsp) CSBK or the Negative Acknowledgement Response (NACK_Rsp) CSBK for a reject response. The response message may employ either Impolite, Polite to All or Polite to Own Colour Code channel access mechanism. Upon receiving an acknowledgement that rejects the call, the source MS should not proceed with the call. Upon receiving an acknowledgement that accepts the call, the source MS follows the PATCS method with impolite channel access. Therefore, the PATCS method is a subset of the OACSU method.

In the PATCS method the first burst at the Beginning Of Transmission (BOT), which may be the BOC carries the necessary information to allow the target MS to be notified of the incoming call. This is accomplished with the Unit to Unit Voice Channel User (UU_V_Ch_Usr) LC message using the Voice LC Header Data Type burst. The first voice burst shall be preceded by a Voice LC Header in the appropriate slot. This is illustrated in figure 5.4 of TS 102 361-1 [1].

Individual Call supports late entry into a call by embedding the LC information into the voice bursts. This helps support scanning and radios being powered on during a transmission addressed to that particular unit when the PATCS method is used. It also supports units that do not correctly decode the voice header when either the PATCS or the OACSU method is used. This is accomplished with the Unit to Unit Voice Channel User (UU_V_Ch_Usr) LC message.

An Individual Call End Of Transmission (EOT) is accomplished by transmitting the entire last voice superframe (through voice burst F), and then sending the Unit to Unit Voice Channel User (UU_V_Ch_Usr) LC Message using the Terminator with LC Data Type burst. This is illustrated in figure 5.8 of TS 102 361-1 [1].

Call hangtime is used in order to extend a call past the End of Transmission. End Of Call (EOC) occurs at the expiration of call hangtime. For OACSU individual calls, subsequent transmissions before the End of Call should be PATCS method.

5.2.2.2 Individual call data bursts/fields

5.2.2.2.1 Direct mode

The Individual Call service requires four Data Type bursts and two embedded field messages. These are listed in tables 5.5 and 5.6 respectively. The contents of all messages with the exception of the embedded Null are defined in clause 7.1. Contents of the embedded Null message are defined in clause D.1 of TS 102 361-1 [1]. The Null message is embedded in the "F" burst of the voice superframe on the forward channel.

Table 5.5: Individual call data bursts

Data Type	Value	Function	Data Contents	Opcode
CSBK	0011 ₂	Presence check	UU_V_Req	000100 ₂
CSBK	0011 ₂	MS Initiated Acknowledgement	UU_Ans_Rsp	000101 ₂
Voice LC Header	0001 ₂	Transmission Addressing	UU_V_Ch_Usr	000011 ₂
Terminator with LC	0010 ₂	End of Transmission	UU_V_Ch_Usr	000011 ₂

Table 5.6: Individual call embedded field messages

Link Control (LC) Message	FLCO	Function	Bursts
UU_V_Ch_Usr	000011 ₂	Late Entry	4
Null	NA	Filler	1

5.2.2.2.2 Repeater mode

Repeater mode uses the same data bursts/fields as direct mode as defined in clause 5.2.2.2.1. However, the BS also generates UU_V_Ch_Usr LC PDUs using the Terminator with LC Data Type burst to signal call (reserved) hangtime. The Null message is always embedded in the "F" burst of the voice superframe on the inbound channel and embedded in the reverse channel location on the outbound channel when no reverse channel signalling is required.

5.2.2.3 MS Individual call channel access

Individual call Service via the PATCS method shall follow the same channel access rules as group call. However, the CSBK PDUs used to perform the presence check (UU_V_Req) and to answer the presence check (UU_Ans_Rsp) for the individual call service via the OACSU method require some application specific rules. These specific rules are defined in the following clauses and compliment the channel access diagrams in clause 5.2.2 of TS 102 361-1 [1].

5.2.2.3.1 UU_V_Req channel access SDL

The specific channel access rules for the transmission of the UU_V_Req CSBK are illustrated in SDL in figure 5.22. The DLL receives a TX_CSBK primitive from the CCL while in the TX_Idle state. The DLL starts the Idle_Search timer (T_IdleSrch), initializes the Retry_Counter to 0 and transitions to the Qualify_Idle state. If the channel is busy the transmission is immediately denied. If the channel is idle the UU_V_Req CSBK PDU is transmitted, an Ack_Wait timer (T_AckWait) is started and the DLL transitions to the Wait_for_ACK state.

While in the Wait_for ACK state, if the UU_Ans_Rsp CSBK PDU is received the DLL informs the CCL. If the ACK_Wait timer (T_AckWait) expires and Retry_Counter equals the CSBK_Retry_Limit (N_CSBKRetry), then a retry transmission is not attempted and the CCL is informed. If the number of attempts is less than the CSBK_Retry_Limit then the MS returns to the Qualify_Idle state to attempt to retransmit the CSBK PDU.

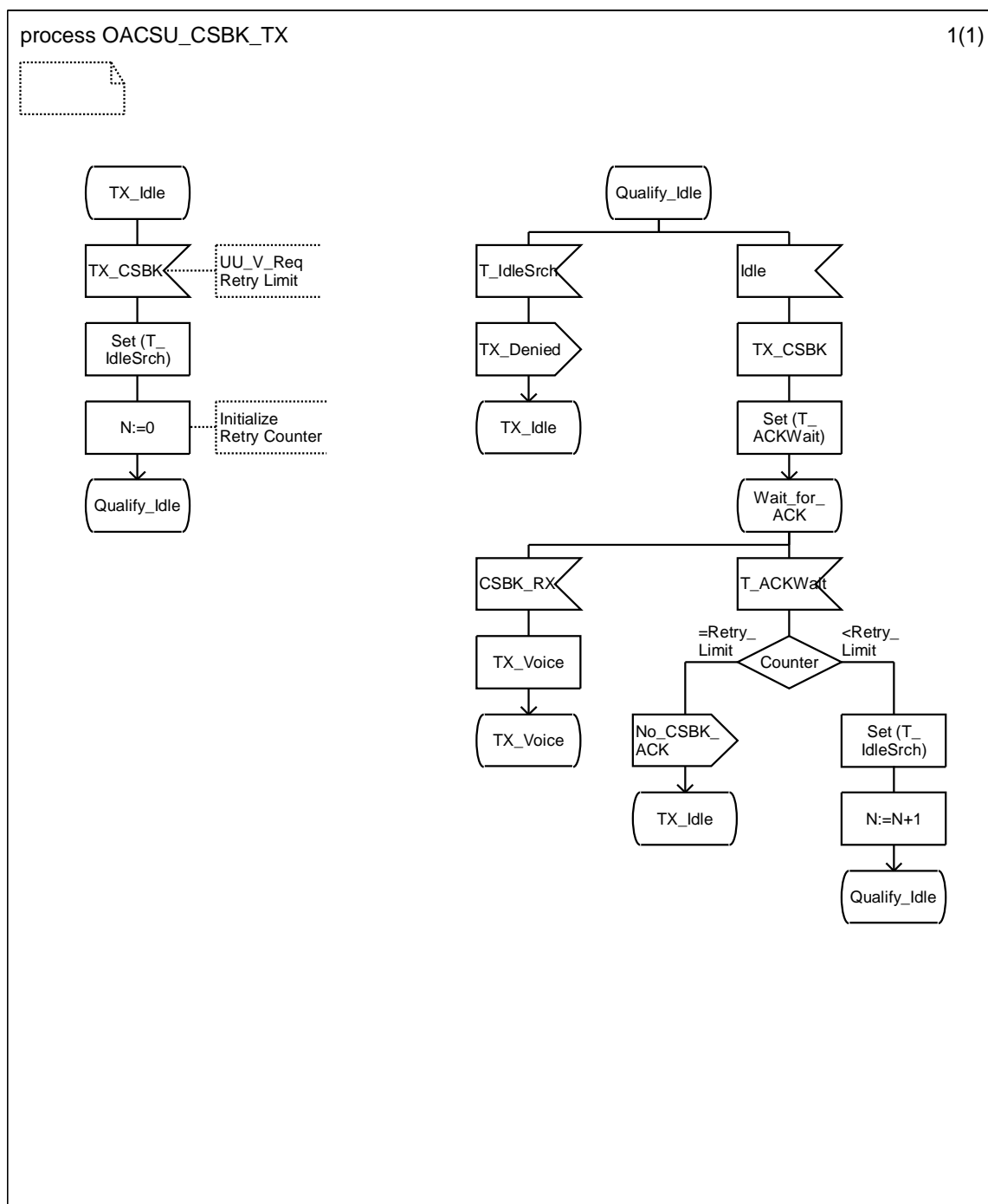

Figure 5.22: UU_V_Req Channel Access SDL

5.2.2.3.2 UU_Ans_Rsp channel access SDL

The specific channel access rules for the transmission of the UU_Ans_Rsp CSBK when the MS is designed for polite CSBK responses are illustrated in SDL in figure 5.23.

NOTE: If an MS is designed for impolite transmission of CSBK responses, it will follow the channel access rules as defined in clause 5.2.2 of TS 102 361-1 [1].

The DLL receives a TX_CSBK primitive from the CCL while in the TX_Idle state. While the DLL is in the Qualify_Idle state, if the channel is idle the CSBK PDU is transmitted and if the channel is busy the transmission is denied. There are no retries or holdoff times for this time critical response.

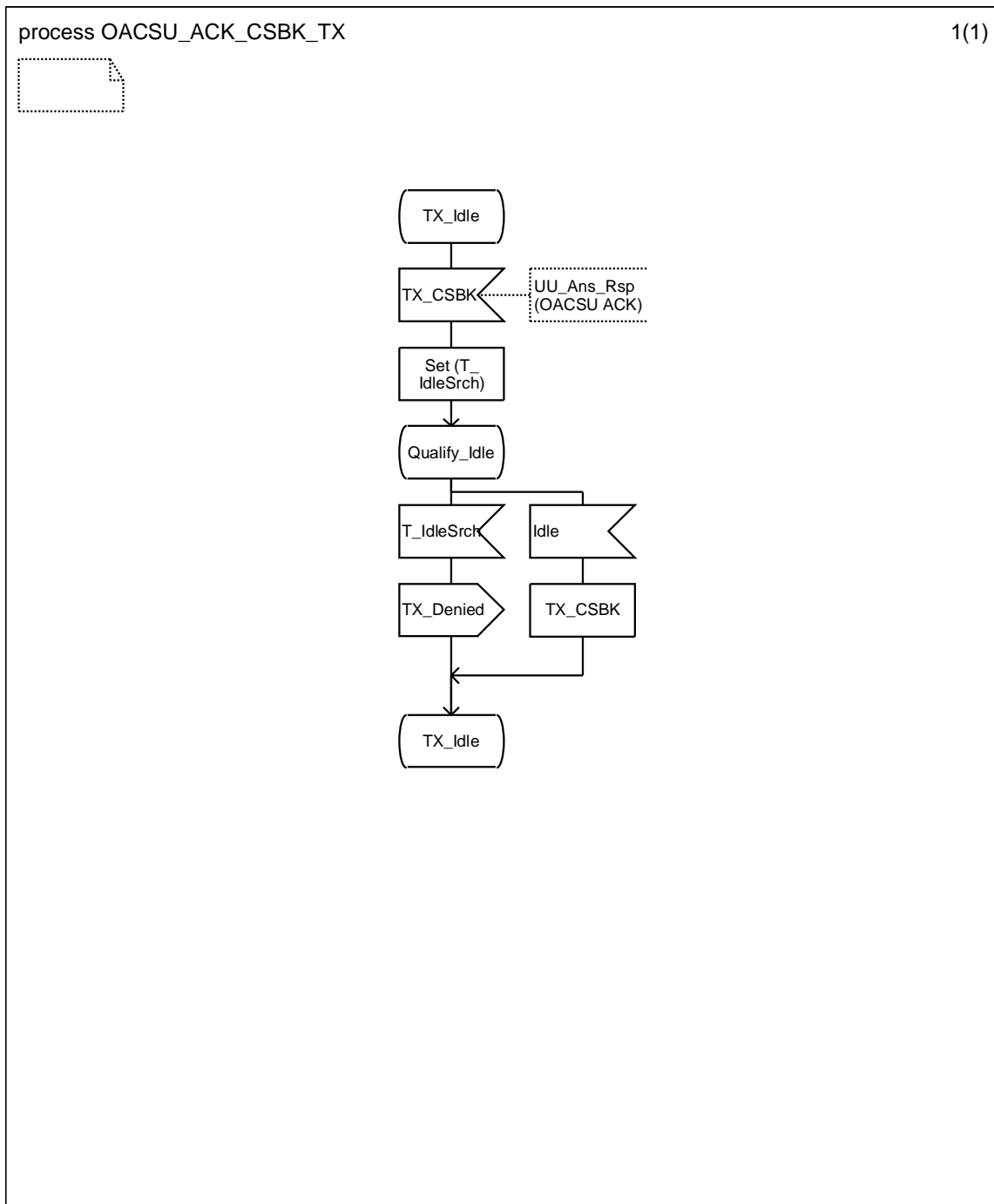

Figure 5.23: UU_Ans_Rsp Channel Access SDL

5.2.2.4 MS Individual call control

The individual call service via the PATCS method shall follow the same rules as group call, while using the individual call specific messages. The individual call service via the OACSU method shall follow the same rules as an impolite group call once the presence check is accomplished. Therefore this clause only defines the presence check sequence of an OACSU call. Refer to clause 5.2.2 for PATCS rules.

5.2.2.4.1 MS OACSU Individual call source CCL SDL

Figure 5.24 illustrates the source MS CCL when an OACSU individual call transmission is requested.

The inactive state is any CCL state with the exception of My_Call or In_Session. The CCL sends a TX_CSBK primitive to the DLL and transitions to the Wait_for_ACK state. The DLL may use either a Polite to All or Polite to Colour Code channel access mechanism for voice CSBKs. If the TX_Denied primitive or the No_CSBK_ACK primitive is received from the DLL, the CCL transitions to the inactive state. If the CCL receives the UU_Ans_Rsp CSBK PDU with the deny Reason Code then the call is denied and the CCL transitions to the Inactive state. If the CCL receives the UU_Ans_Rsp CSBK PDU with the proceed Reason Code then it sends a Transmit_Request primitive for impolite access to the DLL. Further transitions are shown for completeness and follow the rules of the Group Call feature.

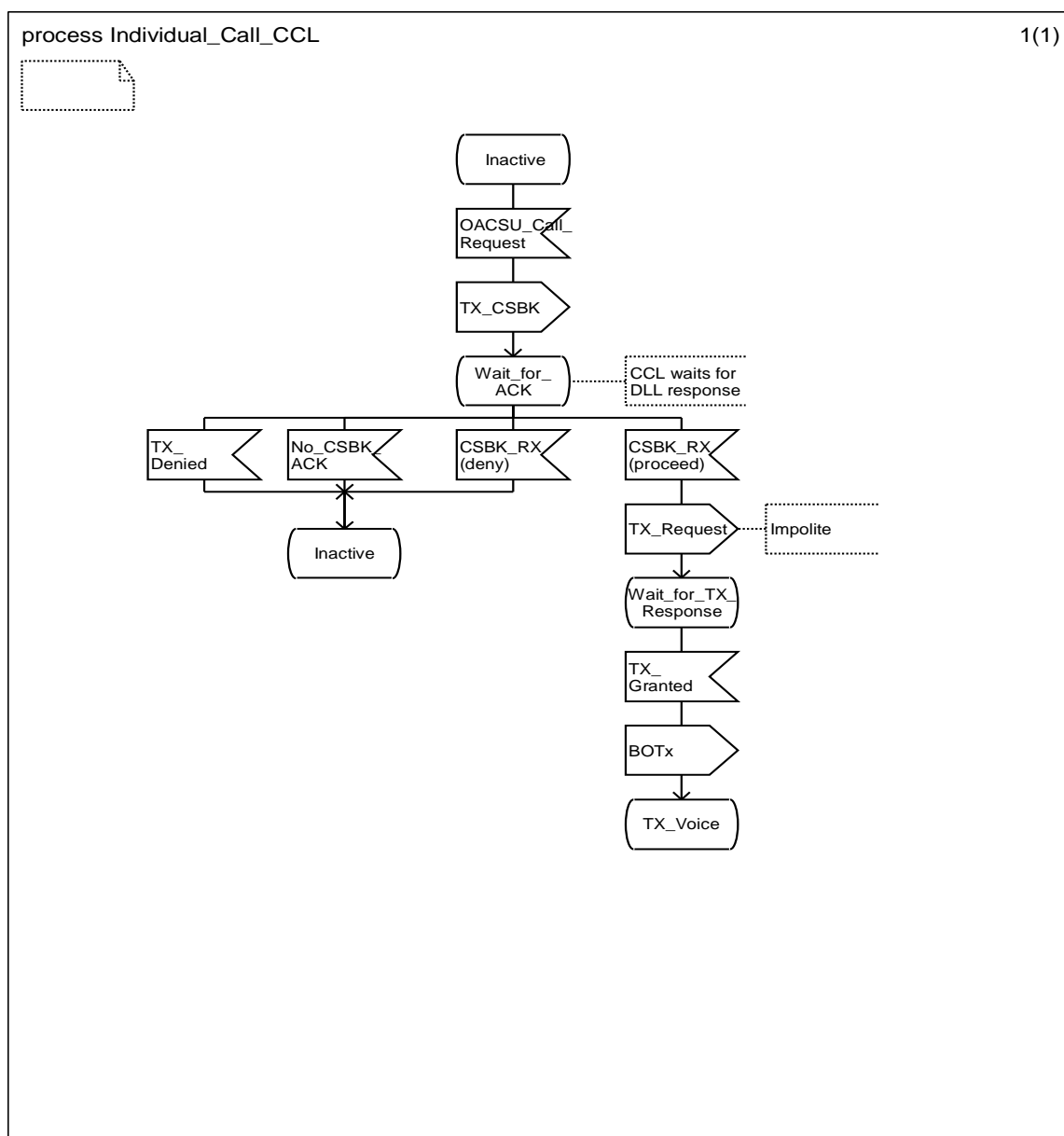

Figure 5.24: OACSU Individual call source CCL SDL

5.2.2.4.2 MS OACSU Individual call setup MSCs

5.2.2.4.2.1 MS OACSU no ACK RX

Figure 5.25 illustrates source MS actions when the UU_V_Req CSBK PDU is transmitted and the UU_Ans_Rsp CSBK PDU is not received and the ACK_Wait timer (T_AckWait) expires.

This shows the case when the MS is not programmed for additional DLL retries and one additional DLL retry.

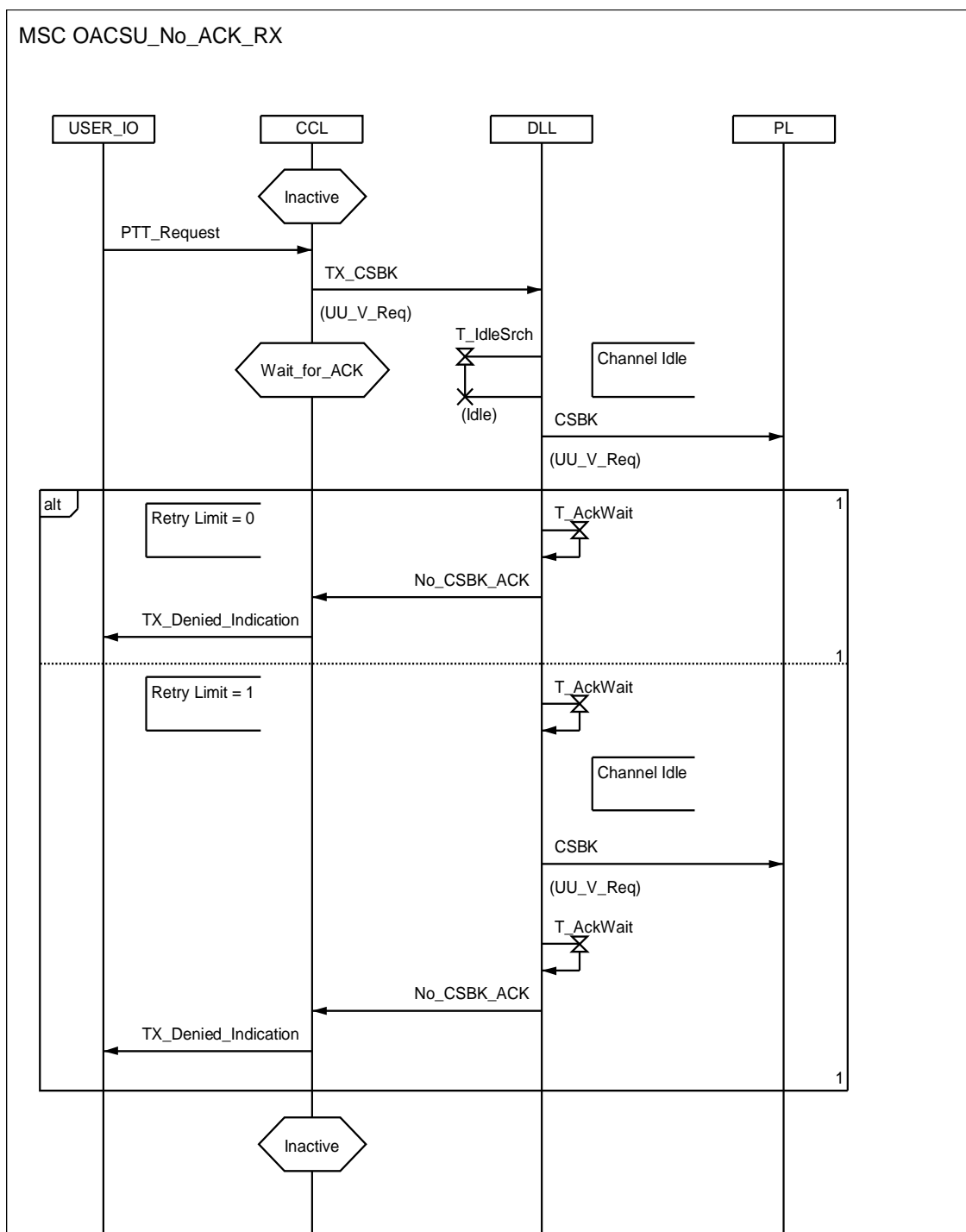

Figure 5.25: OACSU Individual Call No ACK Received

5.2.2.4.2.2 MS OACSU ACK RX

Figure 5.26 illustrates source MS actions when the UU_V_Req CSBK PDU is transmitted and the UU_Ans_Rsp CSBK PDU is received before the Wait_for_ACK timer expires.

If the Reason Code is "deny" in the received CSBK, then the call will not proceed and the CCL transitions to the Inactive state. However, if the Reason Code in the received CSBK is "proceed" the CCL sends a TX_Request primitive to the DLL specifying impolite channel access. The DLL replies with a TX_Granted primitive and the CCL sends a BOTx primitive to the DLL and transitions to the TX_Voice state. The DLL responds by transmitting the UU_Ch_Usr PDU Voice LC Header followed by voice superframes.

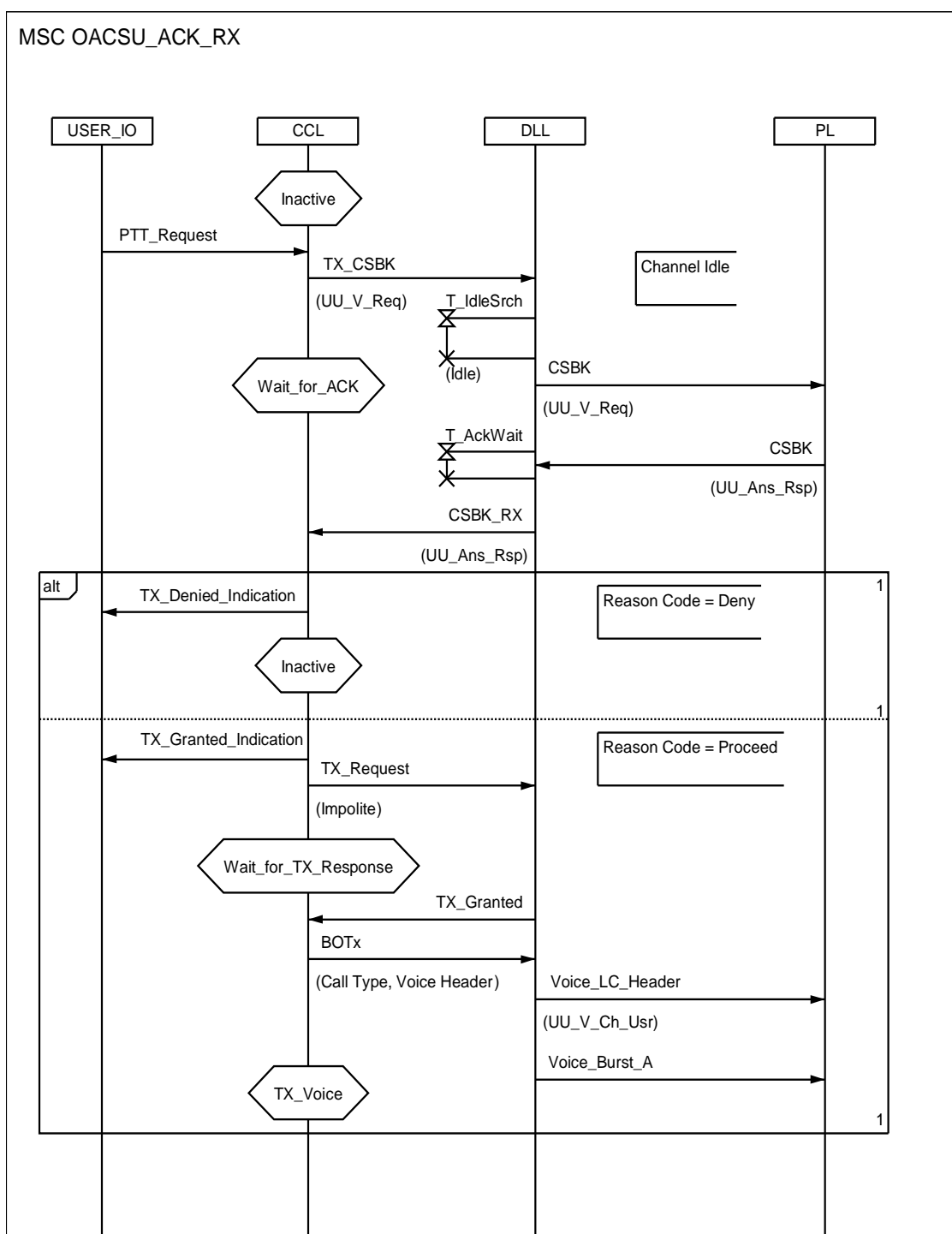

Figure 5.26: OACSU Individual call ACK received

5.3 Supplementary voice services

5.3.1 Unaddressed voice call service

The unaddressed voice call is a group voice call that uses one of a set of defined destination addresses as defined in annex A of TS 102 361-1 [1]. One of these addresses is the default unaddressed voice call address. Usage of the other Unaddressed Voice Call addresses is out of the scope of the present document.

NOTE: Using an unaddressed voice call gives the users the possibility to define an MS behaviour which may be different to a normal group call. For example special alert tones. This also provides basic out-of-the box MS configuration possibilities and could be used for communications between different user organizations, each of which has its own group definitions.

5.3.1.1 Unaddressed voice call data burst/fields

The unaddressed voice call requires the same bursts as group call, which is defined in clause 5.2.1. For an unaddressed call the group address of Grp_V_Ch_Usr shall be set to one of the reserved Unaddressed Call values, as defined in annex A of TS 102 361-1 [1].

5.3.1.2 MS Unaddressed voice call control

The unaddressed voice call control follows the SDL, HMSC and MSC schemes of group call, shown in clause 5.2.1.

5.3.2 All call voice service

The all call voice service provides a one-way voice call from any user to all users on a channel. Due to the large target audience, there is no call hangtime associated with this call in repeater mode. This effectively ends the call at the end of the transmission. Ending the call at the end of transmission minimizes potential collisions from multiple MSs attempting to respond to the call.

The all call may be placed by the user with the simple pressure of the PTT button. It starts with the transmission of a voice header, which is followed by voice and ends with the transmission of a Terminator with LC. Late entry is provided for in this service.

The all call is made in the same manner as a group voice call using one of a set of reserved destination addresses as defined in annex A of TS 102 361-1 [1]. Of these reserved addresses, one is the default all unit ID address while the others are alternative All Unit ID addresses.

5.3.2.1 All call data bursts/fields

The all call requires the same bursts as group call service, which is defined in clause 5.2.1. For an all call the group address of Grp_V_Ch_Usr PDU shall be set to one of the reserved All Unit IDs values, as defined in annex A (DMR addressing scheme) of TS 102 361-1 [1]. Additionally the Service Options Broadcast Field of the Grp_V_Ch_Usr PDU shall be set to 1₂. This indicates to the BS that this is a one way voice call and no call hangtime is to be generated.

5.3.2.2 MS All call control

The all call control follows the SDL, HMSC and MSC schemes of Group Call, shown in clause 5.2.1 with the following exceptions:

- the absence of call hangtime will move the MS from the My_Call state to the Not_in_Call state in repeater mode; and
- the In_Session state is not relevant to all call in repeater mode as there is no call hangtime.

5.3.2.3 BS All call control

5.3.2.3.1 All call voice repeating

The BS shall follow the voice call repeating rules as defined in clause 5.1.1.2.

5.3.2.3.2 All call end of transmission

Figure 5.27 illustrates the BS actions when the end of transmission of an all call occurs. The end of transmission is signalled by the source MS with a Grp_V_Ch_Usr PDU using a Terminator with LC data slot type after transmitting the entire last superframe through voice burst F. The DLL passes this up to the CCL_BS with an EOR_Slot_1 primitive. This is then passed to CCL_1 with the EOR primitive. CCL_1 recognizes the Service Options Broadcast Field is set to 1₂ and sends a Generate_Idles primitive to the CCL_BS and transitions to the Channel_Hangtime state. The CCL_BS then sends a Generate_Idles primitive to the DLL. The BS then transmits Idle PDUs on the outbound channel and sets the CACH AT bit to 0₂ to indicate the channel is idle. The CCL_BS states are defined in clause G.2.1 of TS 102 361-1 [1] and the CCL_1 and CCL_2 states are defined in clause G.2.2 of TS 102 361-1 [1].

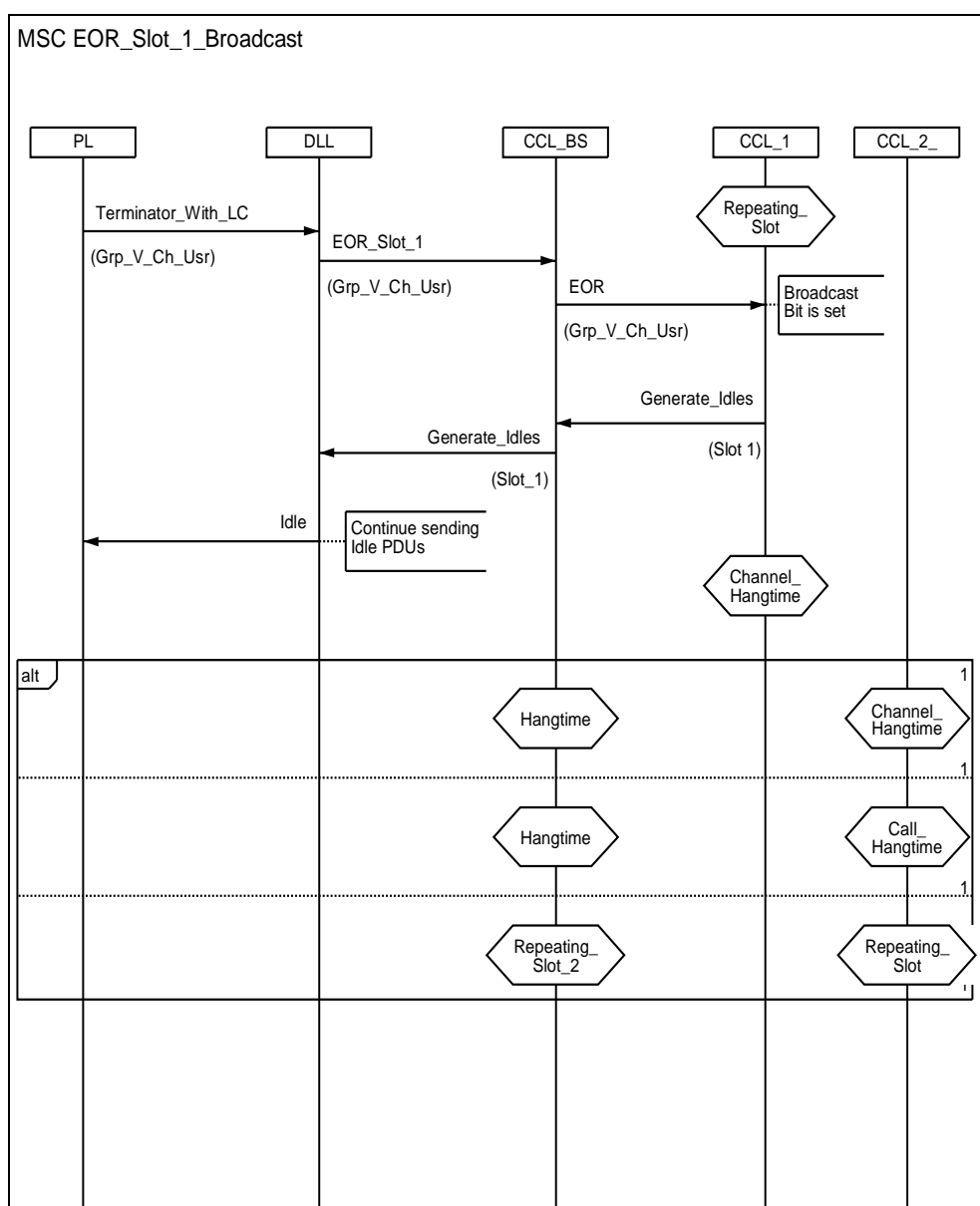

Figure 5.27: BS All call end of transmission

5.3.3 Broadcast call voice service

The broadcast call voice service provides a one-way voice call from any user to a predetermined large group of users. Due to the large target audience, there is no call hangtime associated with this call in repeater mode. This effectively ends the call at the end of the transmission. Ending the call at the end of transmission minimizes potential collisions from multiple MSs attempting to respond to the call.

The broadcast call is made in the same manner as a group voice call. The broadcast call may be placed by the user with the simple pressure of the PTT button. It starts with the transmission of a voice header, which is followed by voice and ends with the transmission of a Terminator with LC. Late entry is provided for in this service.

5.3.3.1 Broadcast call data bursts/fields

The broadcast call requires the same bursts as group call service, which is defined in clause 5.2.1. For a broadcast call the Service Options Broadcast Field of the Grp_V_Ch_Usr PDU shall be set to 1₂. This indicates to the BS that this is a one way voice call and no call hangtime is to be generated.

5.3.3.2 MS Broadcast call control

The broadcast call control follows the SDL, HMSC and MSC schemes of group call, shown in clause 5.2.1 with the following exceptions. The absence of call hangtime will move the MS from the My_Call state to the Not_in_Call state in repeater mode. The In_Session state is not relevant to broadcast call in repeater mode as there is no call hangtime.

5.3.3.3 BS Broadcast call control

5.3.3.3.1 Broadcast call voice repeating

The BS shall follow the voice call repeating rules as defined in clause 5.1.1.2.

5.3.3.3.2 Broadcast call end of transmission

The BS shall follow the End of transmission rules as defined in clause 5.3.2.3.2.

5.3.4 Open voice channel mode service

The open voice channel mode service allows users to monitor and participate to the voice channel activity. This call modification is possible only on voice activity originator basis that is to say that if a user is not an explicitly addressed target of the call it can take part to it only if the originator has properly set the OVCM attribute.

From the voice activity originator's point of view the OVCM gives the opportunity to place group and individual calls that are listened from third party users that are not the targeted users of the call. In addition these third party users are part of the conversation in progress and they can also talk.

Third party users are those that have radios configured to take part to calls set as OVCM and not addressed explicitly to them.

Both in direct mode and repeater mode, OVCM call modifier applies to the following half duplex voice calls:

- Group Calls (see clause 5.2.1);
- Individual Calls (see clause 5.2.2).

OVCM service does not apply to the following calls:

- Unaddressed Voice calls;
- All talkgroup ID calls;

- All unit ID calls;
- other "system gateway" calls such as PABX, PSTN;
- full duplex voice calls;
- data calls.

5.3.4.1 OVCM service description

To achieve the OVCM service a bit is used in the service options information element in order to set the call as OVCM or not. This is illustrated in table 7.10.

Service options information element is present in call set-up signalling, Voice LC Header and Terminator with LC for each type of voice call (Group and Individual).

The behaviour of OVCM is summarized in table 5.7.

Table 5.7

Feature	OVCM bit	Description	Targeted users rights	Third party user rights
Group Voice Call	1	The users that are the recipients for the call are alerted for the incoming call and are part of the call The users that are not the recipients for the call are not alerted but they can take part to the conversation.	talk listen	talk listen
	0	The users that are the recipients for the call are alerted for the incoming call and are part of the call The users that are not the recipients for the call are not alerted and they are not part of the conversation.	talk listen	the channel is busy
Individual Voice Call	1	The user that is the recipient for the call is alerted for the incoming call and is part of the call. The other users that are not the recipients for the call are not alerted but they are part of the conversation.	talk listen	talk listen
	0	The user that is the recipient for the call is alerted for the incoming call and is part of the call. The users that are not the recipients for the call are not alerted and they are not part of the conversation.	talk listen	the channel is busy

In the table above user's permission to participate in an OVCM service as a third party is not taken into account. User's permission to participate in an OVCM service in progress and possible differences in user alerting are implementation dependent and not covered by the present document.

6 DMR facilities

6.1 Transmit timeout

DMR MSs shall have a transmit TimeOut timer (T_TO) which limits the time of a single transmission item. This timer shall be set to the value T_TO (see annex A) whenever the PTT key is pressed and counts down to zero.

The value of this timer is fixed for Tier I MSs (see annex A).

For Tier II and Tier III MSs the value of this timer is variable and may be changed (see annex A).

If the transmit TimeOut timer expires during a voice transmission, then the MS will stop transmitting between immediately and after the end of the current superframe plus one burst and may not re-transmit until PTT has been released and pressed again. If the transmit TimeOut timer expires during a data transmission, then the MS will stop transmitting immediately.

NOTE: Stopping a voice transmission after the end of the current superframe plus one burst allows the MS to end its voice transmission with its normal mode of operation by completing the superframe and sending a Terminator with LC.

6.2 TDMA direct mode wide area timing

6.2.1 Facility description

With independent TDMA MS transmissions sharing a channel, one must be concerned about keeping the two MS transmissions within the assigned timeslot boundaries to avoid inter-timeslot interference. To minimize interference opportunities, it is important that all MS units in the wide area system are transmitting with the same channel slot timing. One MS in the wide area system is appointed as the wide area timing leader and sets the channel slot timing. MS units share their TDMA direct mode timing information with one another. This spreads the timing information from the leader MS all the way to the MS units at the edge of the system.

The solution is comprised of 4 high level states. The 4 high level states are Leader_and_Timing_Unknown, Leader_and_Timing_Known, Leader_Unknown and Leader. The roles of the MS in each of these states is defined below.

6.2.1.1 Leader_and_Timing_Unknown

In the Leader_and_Timing_Unknown state the MS does not know the channel slot timing, which is the actual slot 1 vs. slot 2 channel timing. This can occur at power up or upon channel change to a different frequency. An MS changing channels from slot 1 to slot 2 of the same frequency shall stay in its current timing state. Additionally, the MS does not know the channel timing leader either. In this state the MS has the following three roles; learn leader and channel slot timing, appoint a leader and be appointed as a leader.

6.2.1.2 Leader_Unknown

In the Leader_Unknown state the MS once knew the channel timing but it has since expired. Additionally the MS does not know the channel timing leader and can no longer assume that the former channel timing leader is the current channel timing leader. In this state the MS has the same roles as it does in the Leader_and_Timing_Unknown state. When transmitting, the MS shall transmit with the last known channel slot timing in a best effort to minimize interfering with multiple slots.

6.2.1.3 Leader_and_Timing_Known

In the Leader_and_Timing_Known state the MS knows both the channel slot timing, which is the actual slot 1 vs. slot 2 channel timing and the channel timing leader. In this state the MS has the following five roles; appoint a leader, be appointed as a leader, accept a new leader, send leader timing push and send leader timing correction. The roles of appointing a leader and being appointed a leader are similar to those in the Leader_and_Timing_Unknown state.

6.2.1.4 Leader

In the Leader state the MS is the leader and sets the channel slot timing. In this state the MS has the following five roles; appoint a new leader, accept a new leader, resolve leader ID conflicts, send beacon timing and send leader timing correction. The role of appointing a leader is similar to that described in the Leader_and_Timing_Unknown state. The roles of accepting a new leader and sending leader timing corrections are similar to those in the Leader_and_Timing_Known state.

6.2.2 TDMA direct mode data bursts/fields

6.2.2.1 Synchronization

When transmitting wide area timing information, the MS shall use the sync patterns associated with the MS unit's provisioned time slot. These are defined in TS 102 361-1 clause 9.1.1 [1].

6.2.2.2 Colour Code

TDMA direct mode channels shall be provisioned with a colour code, similar to other modes of operation. Both timeslots operating on a particular carrier frequency may or may not use the same colour code. Additionally an "All Site" colour code is defined (F_{16}) for use in TDMA direct mode systems. Receiving colour code F_{16} on a TDMA Direct mode channel shall be considered a qualified colour code. The "All Site" color code shall only be used when transmitting channel timing CSBKs on the MS unit's provisioned time slot, which may be either Timeslot 1 or Timeslot 2. An MS shall decode a channel timing CSBK with the "All Site" colour code in its provisioned time slot and its non provisioned time slot. This reduces the number of CSBK transmissions required to support wide area timing on an RF channel.

6.2.2.3 Channel Timing CSBK

The channel timing information is sent via a Channel Timing CSBK (CT_CSBK). Upon reception of a CT_CSBK the MS shall evaluate the CT_CSBK information elements (clause 6.2.3), Leader Dynamic Identifier (LDI), Leader Identifier (LID) Generation (Gen), Sync Age (SA), Channel Timing Opcode (CTO), New Leader (NL), Source Dynamic Identifier (SDI) and Source Identifier (SID), to determine if the sync pattern contained in the CT_CSBK sets the channel slot timing of the frequency, as illustrated in clause 10.2.3.1.2 in [1]. However, since all transmissions might not fall within these timing boundaries, an MS shall decode transmissions that do not align with its channel slot timing.

If the MS determines that the received channel timing information in the CT_CSBK indicates better timing information, the MS shall use the sync pattern contained in the newly received CT_CSBK to set the channel slot timing of the frequency (clause 6.2.3). If the MS determines the received channel timing information in the CT_CSBK does not indicate better timing information, the MS shall continue to use its current channel slot timing. The CT_CSBK may be received on either the MS unit's provisioned time slot or its non-provisioned time slot. Therefore the MS shall decode the CT_CSBK on either time slot. This helps minimize the required number of CT_CSBK transmissions. The solution utilizes 5 different CT_CSBK types.

6.2.2.3.1 CT_CSBK_Beacon

The CT CSBK is periodically transmitted by the timing leader MS as a beacon (CT_CSBK_Beacon). The CT_CSBK_Beacon shall be transmitted via 12,5e direct mode Polite to All channel access rules (see clause 5.2.2.1 of TS 102 361-1 [1]) in the leader's provisioned slot with the appropriate time slot sync pattern and the all site color code. The CT_CSBK_Beacon shall not be immediately transmitted if the channel contains any RF activity, including a TDMA direct mode transmission on either slot. This helps to ensure that the CT_CSBK_Beacon is sent with the proper channel slot timing. If the channel contains RF activity, the MS shall queue the CT_CSBK Beacon and retry at a later time. A MS that receives a CT_CSBK_Beacon shall use this to set its own channel slot timing when it determines that the transmitting MS is the wide area timing leader. The transmission duration of the CT_CSBK_Beacon shall be the BeaconDuration.

6.2.2.3.2 CT_CSBK_Prop

In response to receiving either a CT_CSBK_Beacon or a CT_CSBK_Prop, the transmission of a CT_CSBK_Prop shall be scheduled by non-leader MS units as a means to diffuse the proper wide area timing information to all MS units within an extended geographical area. The CT_CSBK_Prop shall be transmitted via 12,5e direct mode Polite to All channel access rules (see clause 5.2.2.1 of TS 102 361-1 [1]) in the MS's provisioned slot with the appropriate time slot sync pattern and the all site color code. The CT_CSBK_Prop shall not be immediately transmitted if the channel contains any RF activity, including a TDMA direct mode transmission on either slot. This helps to ensure that the CT_CSBK_Prop is sent with the proper channel slot timing. If the channel contains RF activity, the MS shall queue the CT_CSBK Prop and retry at a later time. A MS that receives a CT_CSBK_Prop shall use this to set its own channel slot timing when it determines that the indicated leader MS is the wide area timing leader. The transmission duration of the CT_CSBK_Prop shall be the BeaconDuration.

In order to minimize the number of CT_CSBKs on a channel, the scheduled CT_CSBK_Prop may be cancelled under certain conditions (see clause 6.2.3.1.1). A sliding window CT_RHOT strategy is implemented to propagate CT_CSBK_Prop messages out via different paths (different MS units), so that channel slot timing is more likely to be achieved over the wide area. The idea is for MS units that have recently transmitted a CT_CSBK_Prop, to have a lower probability of transmitting than MS units that have not transmitted recently. After a MS has transmitted a CT_CSBK_Prop, the next time it is to transmit a CT_CSBK_Prop it uses a uniform distribution of 2,160 to 3,240 seconds with 60 ms increments for the CT_RHOT value. It is possible that the MS will not send the CT_CSBK_Prop, as there are instances where it will cancel its request when it receives a CT_CSBK from another MS (see clause 6.2.3.1.1). In these cases, the MS will decrement CT_RHOT upper and lower range values by 120 ms for the next transmission request. This gives the MS a slightly higher probability of transmitting the CT_CSBK_Prop than the previous time. This 120 ms decrementing occurs until a scheduled CT_CSBK_Prop is transmitted or the lower range value equals 0, at which time the CT_RHOT range is set back to 2,160 to 3,240 seconds.

6.2.2.3.3 CT_CSBK_Term

The CT_CSBK shall be transmitted by all subscribers in TDMA direct mode, immediately following certain transmissions, as a terminator. A MS shall transmit a CT_CSBK_Term immediately following a voice transmission, a data transmission or a CSBK transmission, with the following two exceptions: the CT_CSBK_Term shall not be sent after a confirmed data Response Data Header or an Acknowledgement to a CSBK; i.e. UU_Ans_Rsp for OACSU Individual voice call. To facilitate new timing leader elections, the subscriber shall transmit the CT_CSBK even if the subscriber does not know the current timing leader. Figure 6.1 illustrates the rules for terminating 6.25e Direct Mode transmissions with a CT_CSBK_Term. Note that for confirmed Data the CT_CSBK_Term shall replace the Terminator Data Link Control (TD_LC) which is required in TS 102 361-3, clause 5.4 [3].

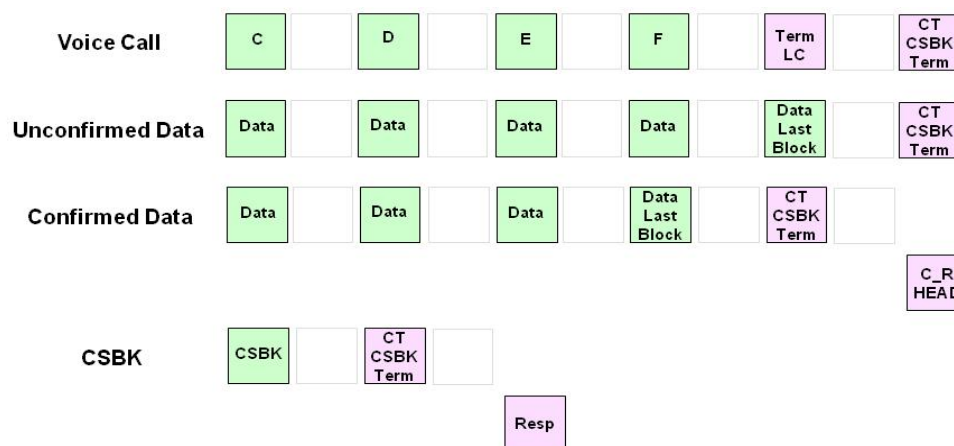

Figure 6.1: Channel Timing CSBK Terminator

6.2.2.3.4 CT_CSBK_Req

The CT_CSBK is transmitted as a request for current leader and channel timing information. Before transmitting a CT_CSBK_Req, a MS waits for a random holdoff amount of time, CT_RHOT. CT_CSBK_Req is transmitted only when RF channel is free of any transmissions using the 12,5e direct mode Polite to All channel access rules (see clause 5.2.2.1 of TS 102 361-1 [1]). The transmission duration of the CT_CSBK_Req shall be the CTDuration.

6.2.2.3.5 CT_CSBK_Resp

The CT_CSBK_Resp is transmitted as a response to requests for current leader and channel timing information and also as a correction when a MS is observed to be using incorrect channel timing information. Before transmitting a CT_CSBK_Resp as a response or correction, a non-leader subscriber waits for a random holdoff amount of time using the CT_RHOT process. The CT_CSBK_Prop shall be transmitted via 12,5e direct mode Polite to All channel access rules (see clause 5.2.2.1 of TS 102 361-1 [1]) in the MS's provisioned slot with the appropriate time slot sync pattern and the all site color code. The CT_CSBK_Prop shall not be immediately transmitted if the channel contains any RF activity, including a TDMA direct mode transmission on either slot. This helps to ensure that the CT_CSBK_Prop is sent with the proper channel slot timing. If the channel contains RF activity, the MS shall queue the CT_CSBK Prop and retry at a later time. The transmission duration of the CT_CSBK_Resp shall be the CTDuration.

6.2.3 TDMA direct mode SDL

The following SDL figures are informative and serve as a guide, because there are a number of ways to arrive at the same results. However, the text preceding each diagram includes normative points. When receiving a CT_CSBK in the diagrams, there are two sets of information elements that are used in the decision process:

- Information elements that are preceded by MS_ (e.g. MS_LWATID) are the channel timing information elements of the receiving MS.
- Information elements that are not preceded by MS_ (e.g. LWATID) are the channel timing information elements received by the MS in the CT_CSBK.

6.2.3.1 Power up and channel change SDL

Figure 6.2 illustrates MS actions when it arrives on a TDMA direct mode channel, which includes power up and channel change. However, it does not include changing to the other slot on the same frequency as the leader MS sets the timing for both slots. The SDL in figure 6.2 defines the following requirements:

- The MS shall initialize its own Wide Area Timing Identifier (MS_WATID), which is composed of the MS Dynamic Identifier (MS_DI) and the MS Identifier (MS_ID) as well as its Generation (MS_Gen), Sync Age (MS_SA) and its Leader WATID (MS_LWATID).

NOTE: An individual MS unit's MS_DI may be provisionable in order to support a particular MS unit being elected or excluded from being elected as the leader.

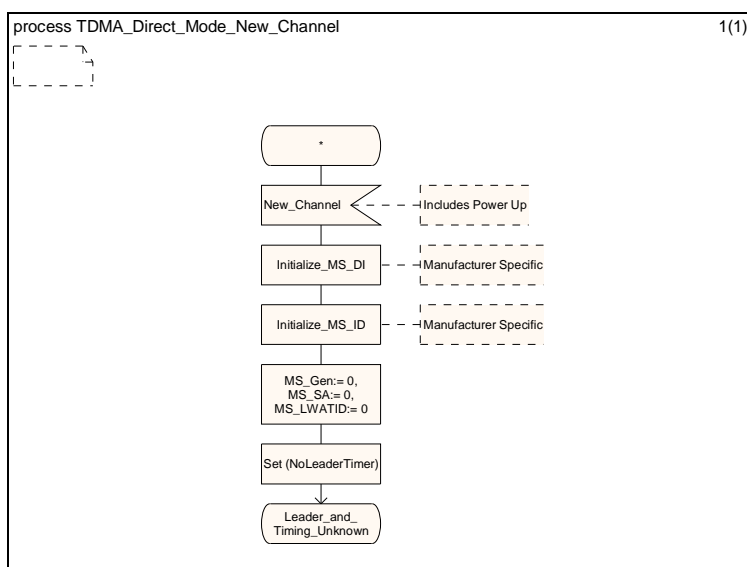

Figure 6.2: Power up and channel change SDL

6.2.3.2 Leader and timing unknown SDL

Figure 6.3 illustrates MS actions from the Leader_and_Timing_Unknown state when the NoLeaderTimer expires or the MS is requested to transmit voice, data or CSBKs other than a CT_CSBK. The SDL in figure 6.3 defines the following requirements:

- When MS requested to transmit, the MS shall set Source DI (SDI) bits to 00₂ in the transmitted CT_CSBK_Term.
- When NoLeaderTimer expires MS shall use its MS_DI bits for SDI in the CT_CSBK transmission.

- After NoLeaderTimer expiration and the MS is waiting to transmit a CT_CSBK_Req, if the MS receives a CT_CSBK then:
 - If received CT_CSBK does not contain a leader or it contains a leader with a lower DI than the receiver's MS_DI, then the receiving MS shall accept the channel slot timing and continue to attempt to send the CT_CSBK_Req.
 - If received CT_CSBK contains a leader with a greater than or equal to DI than receiver's MS_DI, then the receiving MS shall cancel the request to TX and evaluate the received CT_CSBK.
- When CT_RHOT expires and the channel is busy, the MS shall continue to attempt to send the CT_CSBK_Req:
 - The MS may attempt to send for up to 2 minutes (Not shown in SDL) before cancelling.

NOTE: CT_CSBK Evaluation (CCE) and Transmit procedure are defined in clauses 6.2.3.8 and 6.2.3.12.

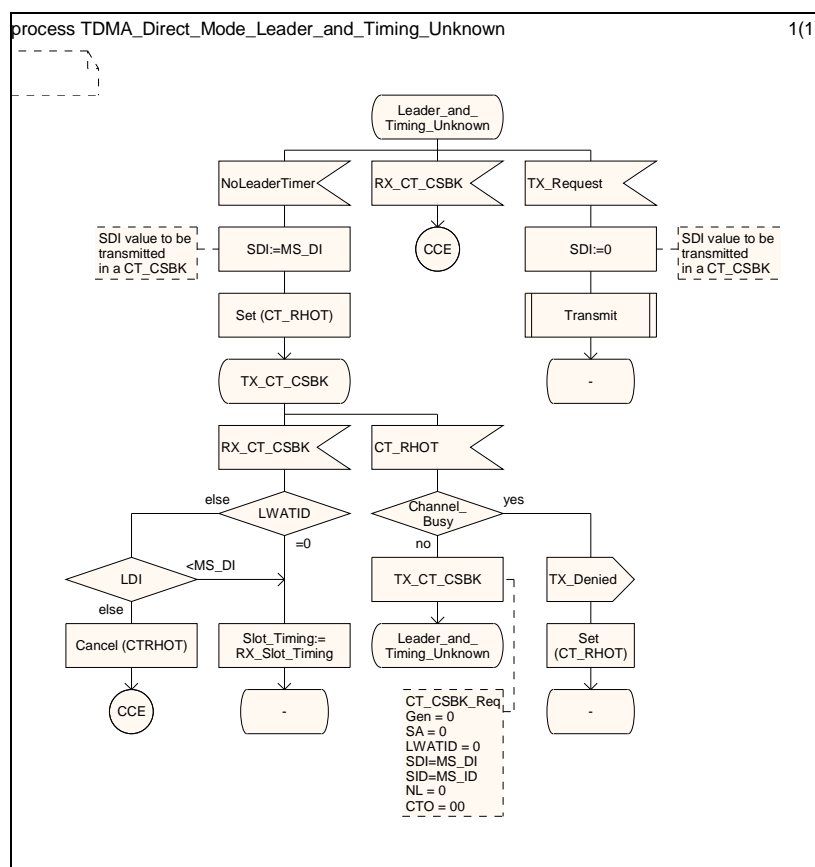

Figure 6.3: Leader and timing unknown SDL

6.2.3.3 Leader unknown SDL

Figure 6.4 illustrates MS actions from the Leader_and_Timing_Unknown state when the NoLeaderTimer expires or the MS is requested to transmit voice, data or CSBKs other than a CT_CSBK. The SDL in figure 6.4 defines the following requirements:

- After NoLeaderTimer expiration and the MS is waiting to transmit a CT_CSBK_Req, if the MS receives a CT_CSBK then:
 - If received CT_CSBK does not contain a leader or it contains a leader with a lower DI than the receiver's MS_DI, then the receiving MS shall accept the channel slot timing and continue to attempt to send the CT_CSBK_Req.
 - If received CT_CSBK contains a leader with a greater than or equal to DI then the receiver's MS_DI, then the receiving MS shall cancel the request to TX and evaluate the received CT_CSBK.

- When CT_RHOT expires and the channel is busy, the MS shall continue to attempt to send the CT_CSBK_Req:
 - The MS may attempt to send for up to 2 minutes (not shown in SDL) before cancelling.

NOTE: CT_CSBK Evaluation (CCE) and Transmit procedure are defined in clauses 6.2.3.8 and 6.2.3.12.

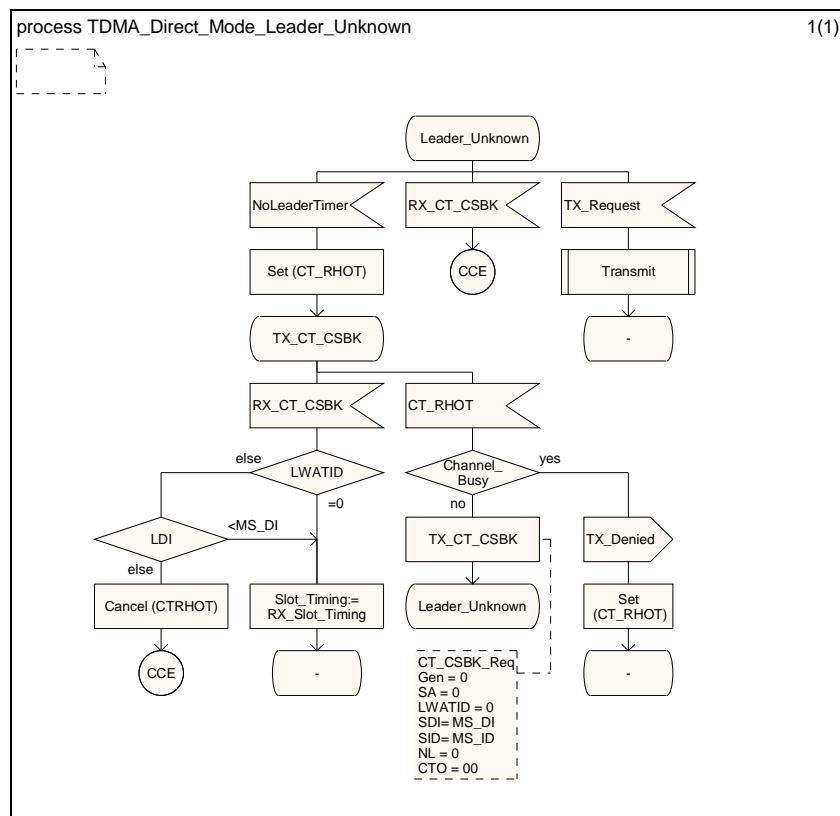

Figure 6.4: Leader unknown SDL

6.2.3.4 Leader and timing known SDL

Figure 6.5 illustrates MS actions from the Leader_and_Timing_Known state when either the SyncAge or SyncAgeWarning timers expire or the MS is requested to transmit voice, data or CSBKs other than a CT_CSBK. The SDL in figure 6.5 defines the following requirements.

- After SyncAgeWarning expiration and MS is waiting to transmit a CT_CSBK_Req, if the MS receives a CT_CSBK then:
 - If the CTO is 00 or 01, the received leader has a lower LWATID than the receiver's leader MS_WATID, or the received leader is equal to the MS_LWATID of the receiver and the SA is higher, then the MS shall continue to attempt to send the CT_CSBK_Req.
 - Otherwise the attempt to send the CT_CSBK_Req is cancelled.
- When CT_RHOT expires and the channel is busy, the MS shall continue to attempt to send the CT_CSBK_Req.
 - The MS may attempt to send for up to 2 minutes (not shown in SDL) before cancelling.
- When the SyncAge Timer expires, the MS shall re-initialize timing parameters and start the NoLeaderTimer.

NOTE: CT_CSBK Evaluation (CCE) and Transmit procedure are defined in clauses 6.2.3.8 and 6.2.3.12.

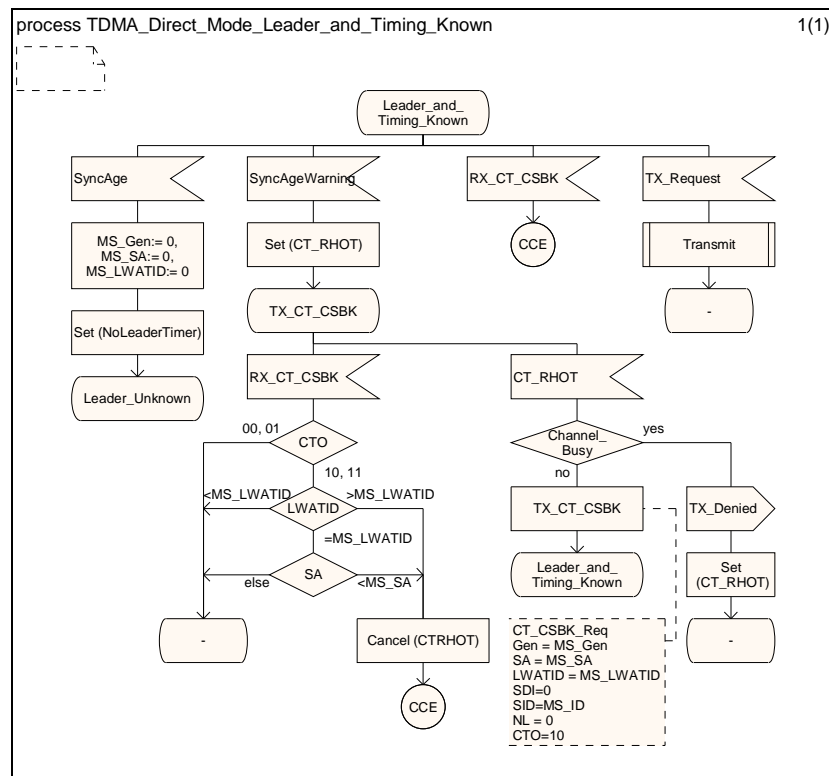

Figure 6.5: Leader and timing known SDL

6.2.3.5 Leader SDL

Figure 6.6 illustrates MS actions when the MS is the Leader and the BeaconInterval timer expires or it receives a CT_CSBK. The SDL in figure 6.6 defines the following requirements:

- The MS shall attempt to send a CT_CSBK_Beacon when the BeaconInterval timer expires or it receives a message to TX a beacon when it was appointed the leader.
- When CT_RHOT expires and the channel is busy, the MS shall continue to attempt to send the CT_CSBK_Beacon:
 - The MS may attempt to send for up to 2 minutes (not shown in SDL) before cancelling.
- The MS shall attempt to send a correction (SC) when a received CT_CSBK:
 - Identifies a leader with a lower LWATID than the receiver's MS_LWATID.
 - Does not identify a leader and the received SDI is less than or equal to the receiver's MS_LDI.
- The MS shall attempt to appoint a new leader (ANL) when a received CT_CSBK:
 - Identifies a leader with a larger LWATID than the receiver's MS_LWATID and the received SDI is greater than the received LDI in the CT_CSBK.
 - Does not identify a leader and the received SDI is greater than the receiver's MS_LDI.
- The MS shall attempt to resolve a leader identifier conflict (ID) when a received CT_CSBK:
 - Identifies a leader with the same LWATID than the receiver's MS_LWATID and the received SDI is less than or equal to the receiver's MS_LDI.
- The MS shall attempt to accept a leader when a received CT_CSBK:
 - Identifies a leader with a greater LWATID than the receiver's LWATID and the received SDI is less than or equal to the receiver's LDI.

NOTE: Identifier Conflict (ID) is described in clause 6.2.3.6, Send Correction (SC) is described in clause 6.2.3.8, Accept Leader (AL) is described in clause 6.2.3.9, and Appoint New Leader (ANL) is described in clause 6.2.3.10.

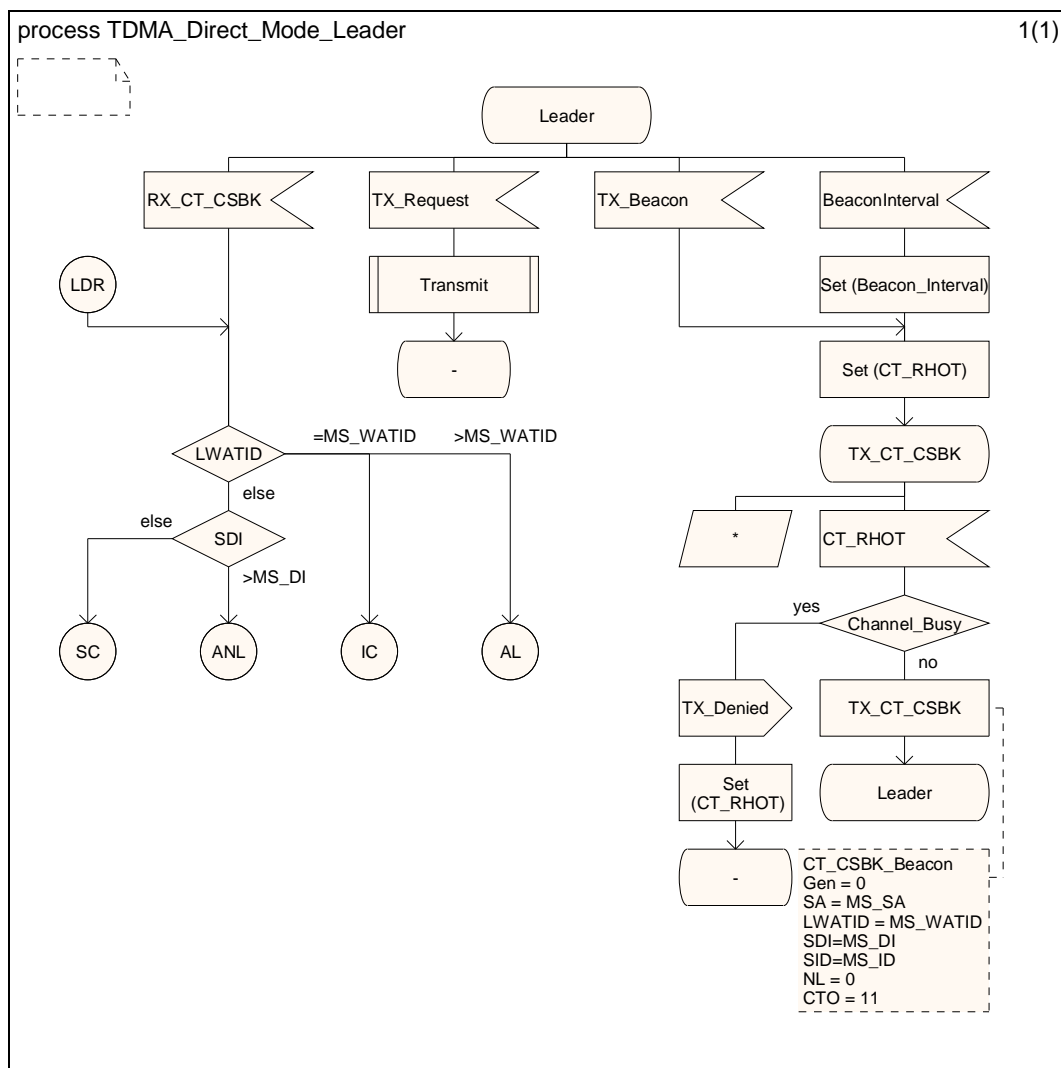

Figure 6.6: Leader SDL

6.2.3.6 Leader identifier conflict SDL

Figure 6.7 illustrates MS actions while it is the leader and has received a CT_CSBK with the same leader Dynamic Identifier (DI) and leader Identifier (ID) as its MS DI and MS ID. The SDL in figure 6.7 defines the following requirements:

- If the received SyncAge (SA) is within +/- 10 SAIncr of the MS unit's SyncAge (MS_SA), the leader shall assume it is still the leader.
- If the received SyncAge (SA) is a multiple of the MS unit's SyncAge (MS_SA) to within ± 10 SAIncr, the leader shall assume it is still the leader and proceeds to send out a channel timing correction (SC).
- If the received SyncAge is different than either of the two previous conditions, then the MS assumes there is another leader in the system using the same LWATID and this conflict must be resolved:
 - The MS selects a new MS ID and if the new MS ID is greater than the received LID, the MS shall stay as the leader.
 - The MS selects a new MS ID and if the new MS ID is less than the received LID, the MS shall accept the other MS as the leader (AL).

NOTE: Send Correction (SC) is described in clause 6.2.3.8 and Accept Leader (AL) is described in clause 6.2.3.9.

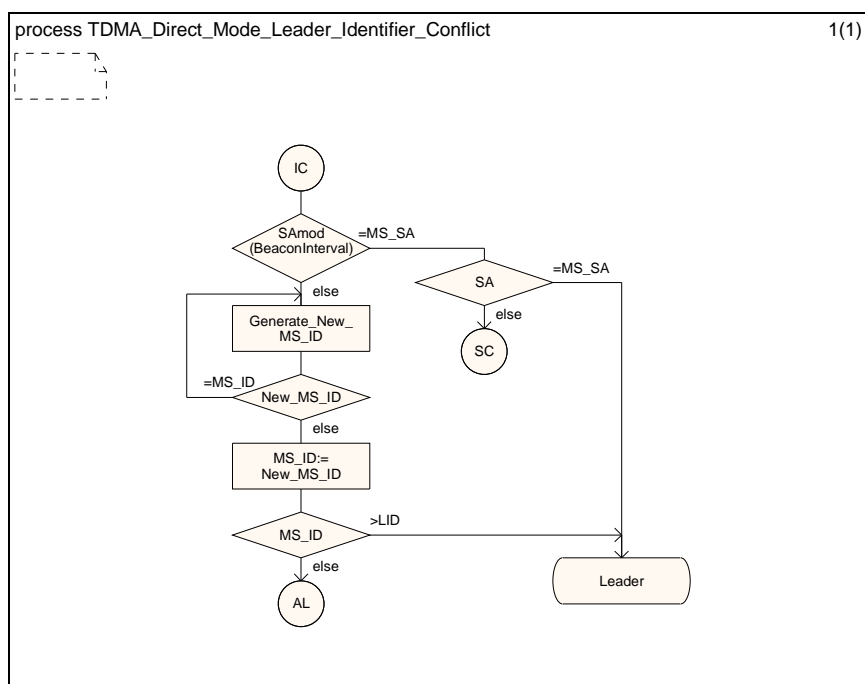

Figure 6.7: Leader identifier conflict SDL

6.2.3.7 CT_CSBK evaluation SDL

Figure 6.8 illustrates MS actions while a non-leader MS evaluates a received CT_CSBK. The SDL in figure 6.8 defines the following requirements:

- If the MS receives a CT_CSBK appointing it as the leader (LWATID = MS_WATID and NL = 1) the MS sets its Generation to 0, assumes the SyncAge in the CT_CSBK, sets the BeaconInterval timer and transitions to the Leader state to immediately transmit a beacon.
- If the received LWATID equals the receiver's MS_WATID and it is not appointed leader (NL=0) or the received SID in the CT_CSBK matches the receiver's MS ID, then the MS generates a new MS ID.
- If the receiving MS does not have a leader it shall accept the channel slot timing and:
 - If received LWATID = 0 then MS shall attempt to appoint new leader (ANL).
 - If received LWATID ≠ 0 then MS shall attempt to accept leader (AL).
- If the receiving MS has a leader and an unaligned terminator is received (CTO=01), the MS shall not accept the timing or update the leader information:
 - If the received LWATID is less than the receiver's MS_LWATID, the MS shall attempt to send a correction (SC).
- If the received LWATID is less than the receiver's MS_LWATID or they are equal and the received SA is greater than the receiver's MS_SA then the MS shall attempt to send a timing correction (SC).
- If the received LWATID is greater than the receiver's MS_LWATID and the received CTO = 11 then the MS shall accept the channel slot timing and attempt to send a Timing Push (TP).
- If the received LWATID is greater than the receiver's MS_LWATID and the received CTO = 01 then the MS shall accept the channel slot timing and accept the leader (AL).
- If the received LWATID equals the receiver's MS_LWATID, the received SA equals the receiver's MS_SA and the received Gen is < the receiver's MS_Gen, then the MS shall accept the channel slot timing and set MS_Gen to one more than the received Gen.

NOTE: Send Correction (SC) is described in clause 6.2.3.8, Accept Leader (AL) is described in clause 6.2.3.9, Appoint New Leader (ANL) is described in clause 6.2.3.10 and Timing Push (TP) is described in clause 6.2.3.11.

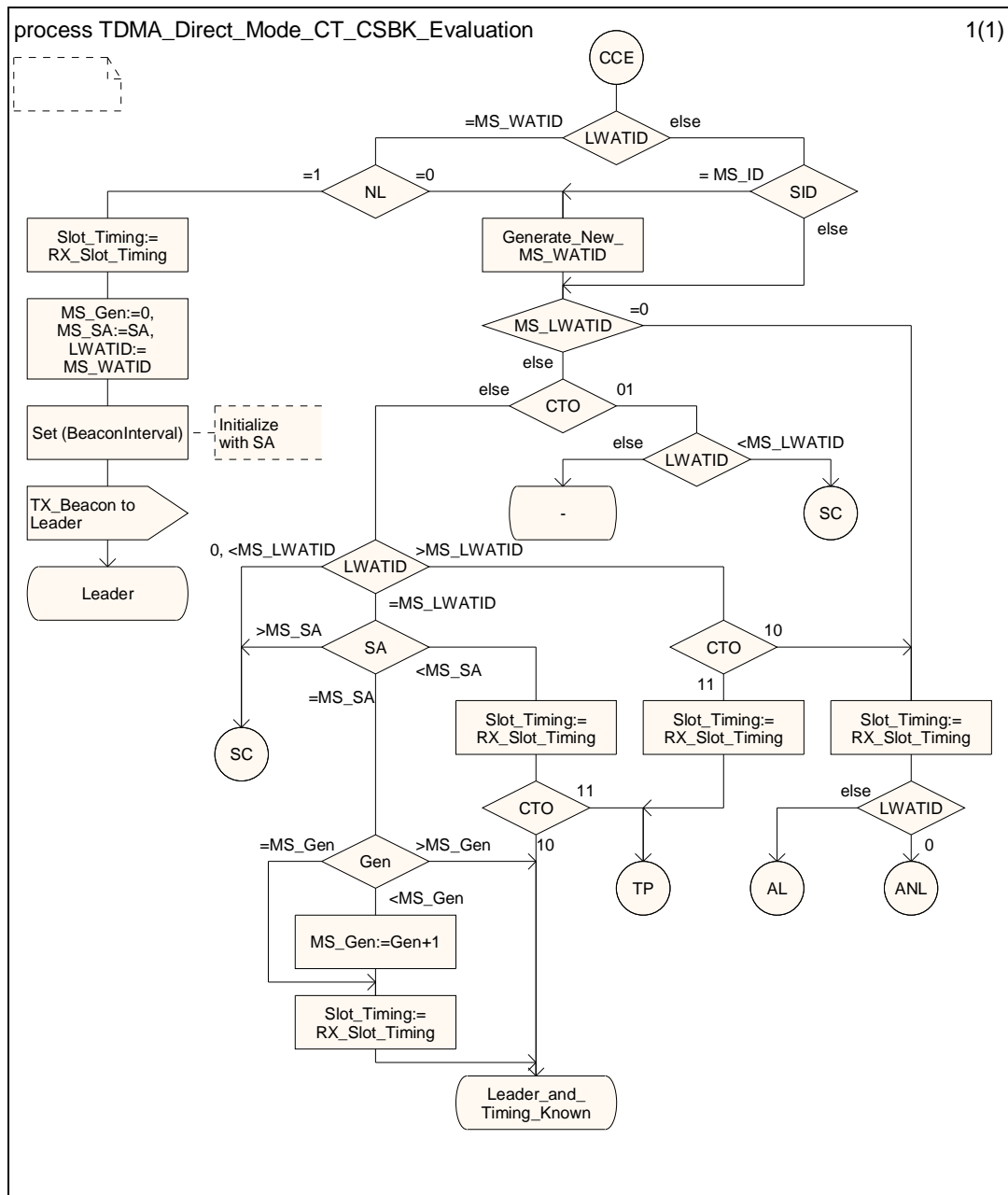

Figure 6.8: CT_CSBK evaluation SDL

6.2.3.8 Send correction SDL

Figure 6.9 illustrates MS actions for sending a channel timing correction. The SDL in figure 6.9 defines the following requirements:

- The MS shall attempt to send a CT_CSBK when CT_RHOT expires.
- When CT_RHOT expires and the channel is busy, the MS shall continue to attempt to send the CT_CSBK:
 - The MS may attempt to send for up to 2 minutes (not shown in SDL) before cancelling.

- When attempting to transmit a CT_CSBK and the MS receives a CT_CSBK with CTO of 00 or 01, the LWATID is less than the receiver's MS_LWATID or the LWATID is \geq the receiver's MS_LWATID and the SWATID is less than the receiver's MS_LWATID then the MS shall continue to send the CT_CSBK.

NOTE: CT_CSBK Evaluation (CCE) is described in clause 6.2.3.7, and LDR is the Leader CT_CSBK evaluation portion in clause 6.2.3.5.

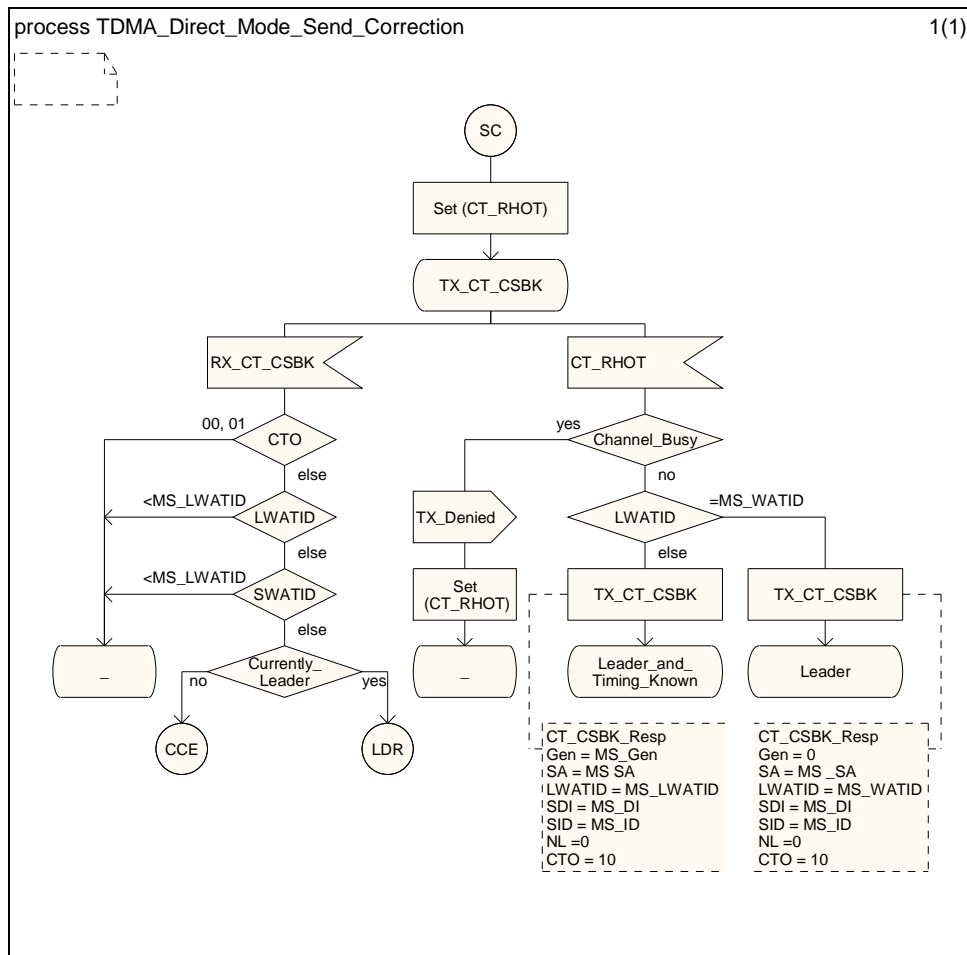

Figure 6.9: Send correction SDL

6.2.3.9 Accept leader SDL

Figure 6.10 illustrates MS actions when accepting a new leader. The SDL in figure 6.10 defines the following requirements:

- If the CTO is 00 or 01 the receiving MS does not accept the leader.
- If the CTO is 10 or 11 the receiving MS accepts the channel slot timing and the channel timing parameters, sets both SyncAgeWarning and SyncAge timers initialized with the received SA value.

NOTE: CT_CSBK Evaluation (CCE) is described in clause 6.2.3.7.

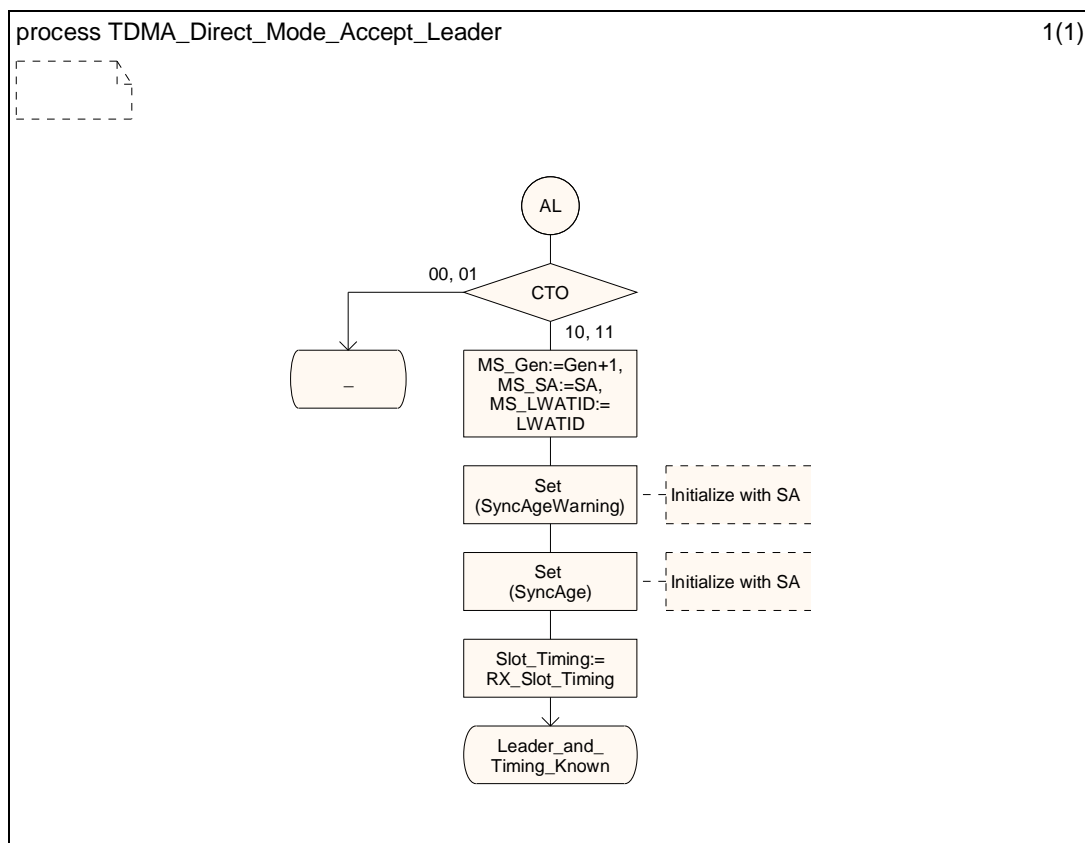

Figure 6.10: Accept leader SDL

6.2.3.10 Appoint new leader SDL

Figure 6.11 illustrates MS actions when appointing a new leader. The SDL in figure 6.11 defines the following requirements:

- The MS shall attempt to send a CT_CSBK when CT_RHOT expires.
- When CT_RHOT expires and the channel is busy, the MS shall continue to attempt to send the CT_CSBK.
 - The MS may attempt to send for up to 2 minutes (not shown in SDL) before cancelling.
- While attempting to send the CT_CSBK and the MS receives a CT_CSBK
 - The MS shall cancel sending the CT_CSBK if the received CT_CSBK has a LWATID greater than the receiver's MS_LWATID or the received SWATID is greater than the receiver's MS_LWATID.

NOTE: CT_CSBK Evaluation (CCE) is described in clause 6.2.3.7.

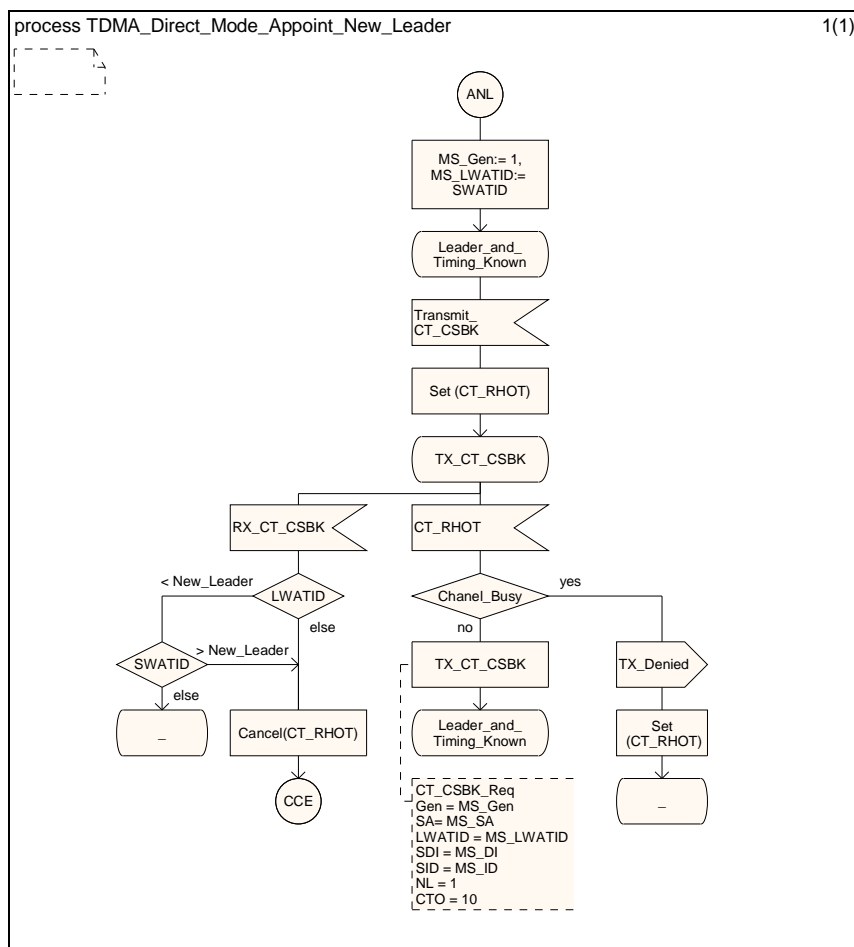

Figure 6.11: Appoint new leader SDL

6.2.3.11 Timing push SDL

Figure 6.12 illustrates MS actions when pushing out the channel timing information. Important points are:

- The MS accepts the timing parameters in the received CT_CSBK.
- The MS shall attempt to send a CT_CSBK when CT_RHOT expires.
- When CT_RHOT expires and the channel is busy, the MS shall continue to attempt to send the CT_CSBK:
 - The MS may attempt to send for up to 2 minutes (not shown in SDL) before cancelling.
- While attempting to send the CT_CSBK and the MS receives a CT_CSBK:
 - The MS shall cancel sending the CT_CSBK if the received CT_CSBK has a LWATID greater than the receiver's MS_WATID or the SWATID is greater than the receiver's MS_WATID.
 - The MS shall cancel sending the CT_CSBK if the received CT_CSBK has a LWATID equal to the receiver's MS_WATID, the CTO is 11 and the received SA is equal to the MS_SA.

NOTE: CT_CSBK Evaluation (CCE) is described in clause 6.2.3.6.

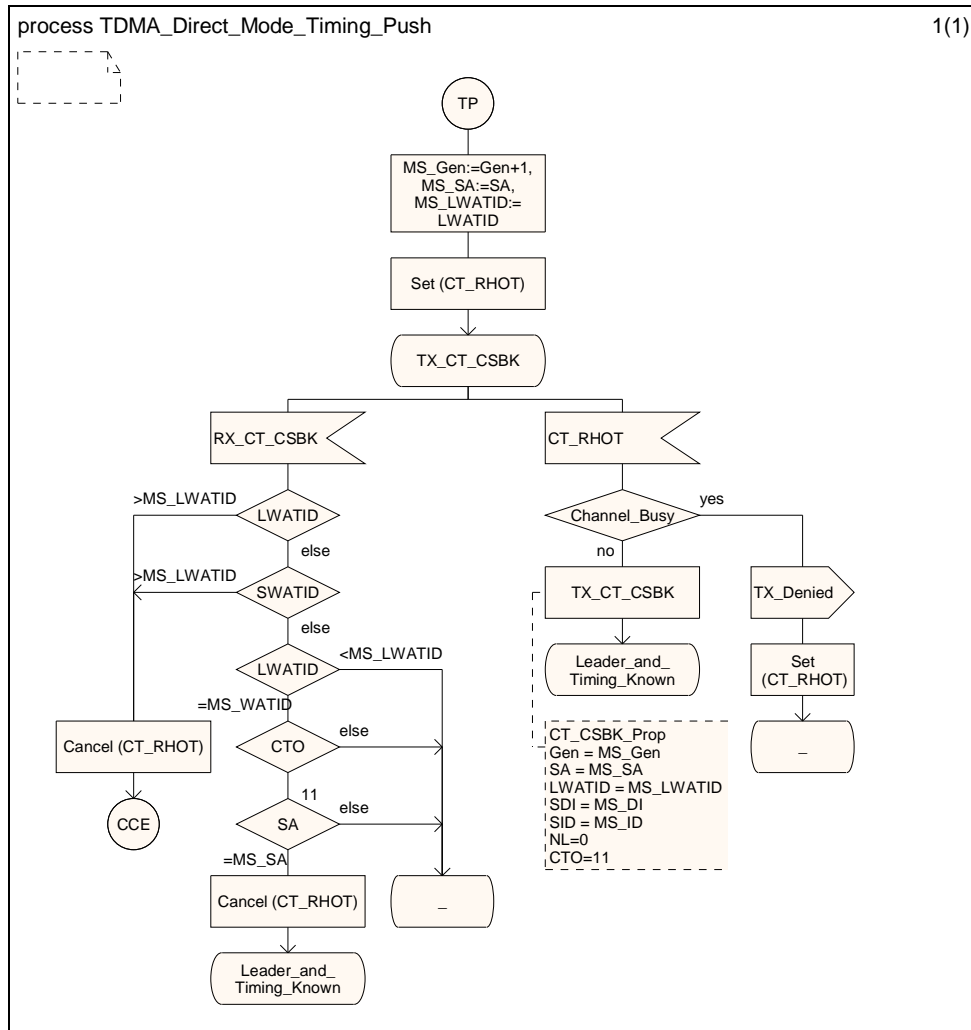

Figure 6.12: Timing push SDL

6.2.3.12 Transmit procedure SDL

Figure 6.13 illustrates how the MS sets the CTO information element in the CT_CSBK_Term at the end of a transmission. The SDL in figure 6.12 defines the following requirements:

- If the MS does not have a leader it shall use CTO = 00 in the CT_CSBK_Term.
- If the MS has a leader and there is no DMR TDMA direct mode activity on the frequency the MS shall use CTO = 10 in the CT_CSBK_Term.
- If the MS has a leader and there is DMR TDMA direct mode activity on the channel the MS shall use CTO = 01 in the CT_CSBK_Term.

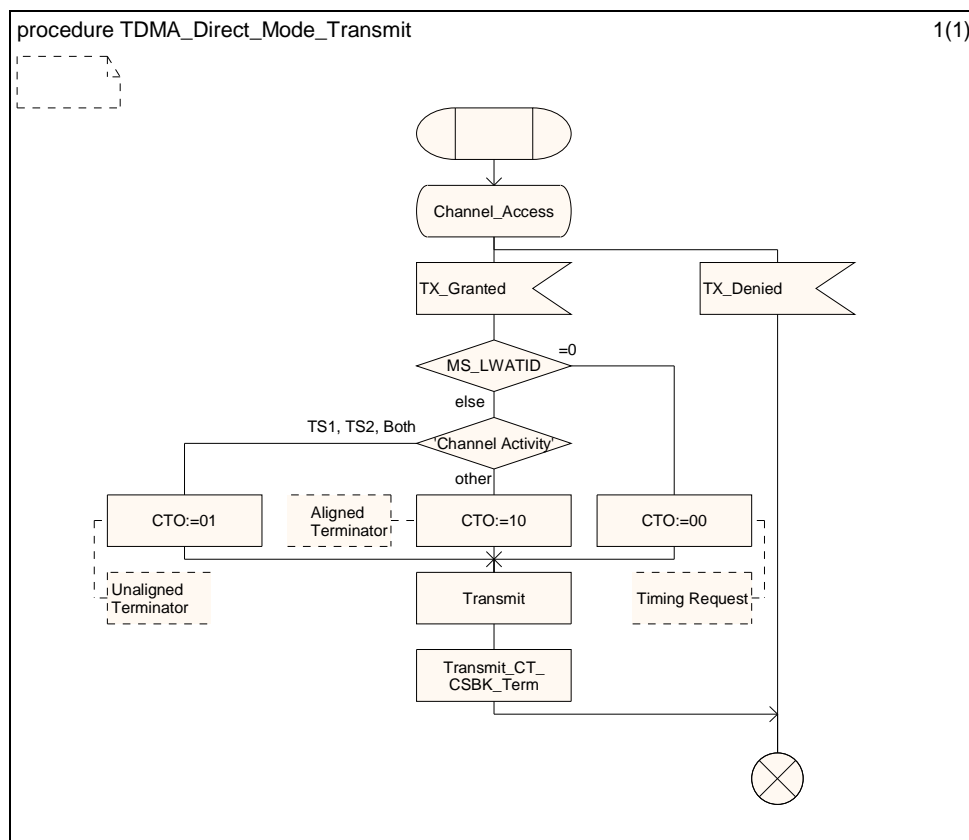

Figure 6.13: Transmit procedure SDL

7 PDU description

This clause describes the PDUs which apply to the DMR layer 3, the voice and generic services and facilities protocol.

The following clauses contain descriptions of the PDUs and the information elements contained within them. The structure of the PDU definition represented by the tables is as follows:

- the information element column gives the name of the contained element(s);
- the element length column defines the length of the element in bits;
- the remarks column contains other information on the information element.

The elements shall be transmitted in the order specified by TS 102 361-1 [1].

7.1 Layer 3 PDUs

Due to the nature of DMR, with close interaction between layers 2 and 3, and with a high degree of information about the state of the channel being needed, the layer 3 PDUs detailed in the following clauses may include two element types:

- **Message dependent elements:**
 - These elements are visible to layer 2 and may be used by any MS (that is able to decode them), irrespective of addressing. These elements depend on the message type element. Some are generated by layer 2 when it constructs the complete message whereas others are generated by layer 3.
- **Feature elements:**
 - These are "true" layer 3 elements. They are only processed by the MSs to which they are addressed.

Where both types exist in the PDU they are shown separately.

7.1.1 Full Link Control PDUs

7.1.1.1 Group Voice Channel User LC PDU

Octet 0 and 1 of the Group Voice Channel User (Grp_V_Ch_Usr) LC PDU conform to the LC format structure as defined in figure 7.1 of TS 102 361-1 [1]. Octets 2 to 8 contain the Group Voice Channel User specific information.

The Grp_V_Ch_Usr PDU is shown in table 7.1.

Table 7.1: Grp_V_Ch_Usr PDU content

Information element	Length	Remark
Message dependent elements		
Protect Flag (PF)	1	
Reserved	1	This bit shall be set to 0 ₂
Feature elements		
Full Link Control Opcode (FLCO)	6	Shall be set to 000000 ₂
Feature set ID (FID)	8	Shall be set to 00000000 ₂
Service Options	8	
Group address	24	
Source address	24	

7.1.1.2 Unit to Unit Voice Channel User LC PDU

Octet 0 and 1 of the Unit to Unit Voice Channel User (UU_V_Ch_Usr) LC PDU conform to the LC format structure as defined in figure 7.1 of TS 102 361-1 [1]. Octets 2 to 8 contain the Unit to Unit Voice Channel User specific information. The UU_V_Ch_Usr PDU is shown in table 7.2.

Table 7.2: UU_V_Ch_Usr PDU content

Information element	Length	Remark
Message dependent elements		
Protect Flag (PF)	1	
Reserved	1	This bit shall be set to 0 ₂
Feature elements		
Full Link Control Opcode (FLCO)	6	Shall be set to 000011 ₂
Feature set ID (FID)	8	Shall be set to 00000000 ₂
Service Options	8	
Target address	24	
Source address	24	

7.1.2 Control Signalling Block (CSBK) PDUs

7.1.2.1 BS Outbound Activation CSBK PDU

Octet 0 and 1 of the BS Outbound Activation (BS_Dwn_Act) CSBK PDU conform to the CSBK format structure as defined in figure 7.8 of TS 102 361-1 [1]. Octets 2 to 9 contain the BS Outbound Activation specific information. The BS_Dwn_Act PDU is shown in table 7.3.

Table 7.3: BS_Dwn_Act PDU content

Information element	Length	Remark
Message dependent elements		
Last block (LB)	1	This bit shall be set to 1 ₂
Protect Flag (PF)	1	
Feature elements		
CSBK Opcode (CSBKO)	6	Shall be set to 111000 ₂
Feature set ID (FID)	8	Shall be set to 00000000 ₂
Reserved	16	All bits shall be set to 0 ₂
BS address	24	
Source address	24	

7.1.2.2 Unit to Unit Voice Service Request CSBK PDU

Octet 0 and 1 of the Unit to Unit Voice Service Request (UU_V_Req) CSBK PDU conform to the CSBK format structure as defined in figure 7.8 of TS 102 361-1 [1]. Octets 2 to 9 contain the Unit to Unit Voice Service Request specific information. The UU_V_Req PDU is shown in table 7.4.

Table 7.4: UU_V_Req PDU content

Information element	Length	Remark
Message dependent elements		
Last Block (LB)	1	This bit shall be set to 1 ₂
Protect Flag (PF)	1	
Feature elements		
CSBK Opcode (CSBKO)	6	Shall be set to 000100 ₂
Feature set ID (FID)	8	Shall be set to 00000000 ₂
Service Options	8	
Reserved	8	All bits shall be set to 0 ₂
Target address	24	
Source address	24	

7.1.2.3 Unit to Unit Voice Service Answer Response CSBK PDU

Octet 0 and 1 of the Unit to Unit Voice Service Answer Response (UU_Ans_Rsp) CSBK PDU conform to the CSBK format structure as defined in figure 7.8 of TS 102 361-1 [1]. Octets 2 to 9 contain the Unit to Unit Voice Service Answer Response specific information. The UU_Ans_Rsp PDU is shown in table 7.5.

Table 7.5: UU_Ans_Rsp PDU content

Information element	Length	Remark
Message dependent elements		
Last Block (LB)	1	This bit shall be set to 1 ₂
Protect Flag (PF)	1	
Feature elements		
CSBK Opcode (CSBKO)	6	Shall be set to 000101 ₂
Feature set ID (FID)	8	Shall be set to 00000000 ₂
Service Options	8	
Answer Response	8	
Target address	24	
Source address	24	

7.1.2.4 Negative Acknowledge Response CSBK PDU

Octet 0 and 1 of the Negative Acknowledge Response (NACK_Rsp) CSBK PDU conform to the CSBK format structure as defined in figure 7.8 of TS 102 361-1 [1]. Octets 2 to 9 contain the Negative Acknowledge Response specific information. The NACK_Rsp PDU is shown in table 7.6.

Table 7.6: NACK_Rsp PDU content

Information element	Length	Remark
Message dependent elements		
Last block (LB)	1	This bit shall be set to 1 ₂
Protect Flag (PF)	1	
Feature elements		
CSBK Opcode (CSBKO)	6	Shall be set to 100110 ₂
Feature set ID (FID)	8	Shall be set to 00000000 ₂
Additional Information Field	1	This bit shall be set to 1 ₂
Source Type	1	
Service Type	6	
Reason Code	8	
Source address	24	Source Address is the Additional Information Field
Target address	24	

7.1.2.5 Preamble CSBK PDU

Octet 0 and 1 of the Preamble CSBK (Pre_CSBK) PDU conform to the CSBK format structure as defined in figure 7.8 of TS 102 361-1 [1]. Octets 2 to 9 contain the Preamble CSBK specific information. The Pre_CSBK PDU is shown in table 7.7. This PDU may be used to increase robustness of non-voice (data, CSBK, etc.) delivery for scanning radios.

NOTE: The CSBK preamble may be used to improve successful delivery of DMR services to MSs that are scanning or improving battery life by implementing a sleep mode.

Table 7.7: Pre_CSBK PDU content

Information element	Length	Value	Remark
Message dependent elements			
Last Block (LB)	1	1 ₂	
Protect Flag (PF)	1		
Feature elements			
CSBK Opcode (CSBKO)	6	111101 ₂	
Manufacturers Feature ID	8	00000000 ₂	
Data/CSBK	1	0 ₂	CSBK content follows preambles
		1 ₂	Data content follows preambles
Group/Individual	1	0 ₂	Target address is an individual
		1 ₂	Target address is a group
Reserved	6	000000 ₂	
CSBK Blocks to Follow (CBF)	8		
Target address	24		
Source address	24		

7.1.2.6 Channel Timing CSBK PDU

Octet 0 and 1 of the Channel Timing CSBK (CT_CSBK) PDU conform to the CSBK format structure as defined in figure 7.8 of TS 102 361-1 [1]. Octets 2 to 9 contain the Channel Timing CSBK specific information. The CT_CSBK PDU is shown in table 7.8 and figure 7.1. This PDU is used to propagate slot timing information to all TDMA direct mode MS units in a wide area system.

Table 7.8: CT_CSBK PDU content

Information element	Length	Value	Remark
Message dependent elements			
Last Block (LB)	1	1 ₂	
Protect Flag (PF)	1		
Feature elements			
CSBK Opcode (CSBKO)	6	000111 ₂	
Manufacturers Feature ID	8	00000000 ₂	
Sync Age	11		
Generation	5		
Leader Identifier	20		
New Leader	1		
Leader Dynamic Identifier	2		
Channel Timing Op1	1		Channel Timing Opcode MSB
Source Identifier	20		
Reserved	1		Shall be set to 0 ₂
Source Dynamic Identifier	2		
Channel Timing Op0	1		Channel Timing Opcode LSB

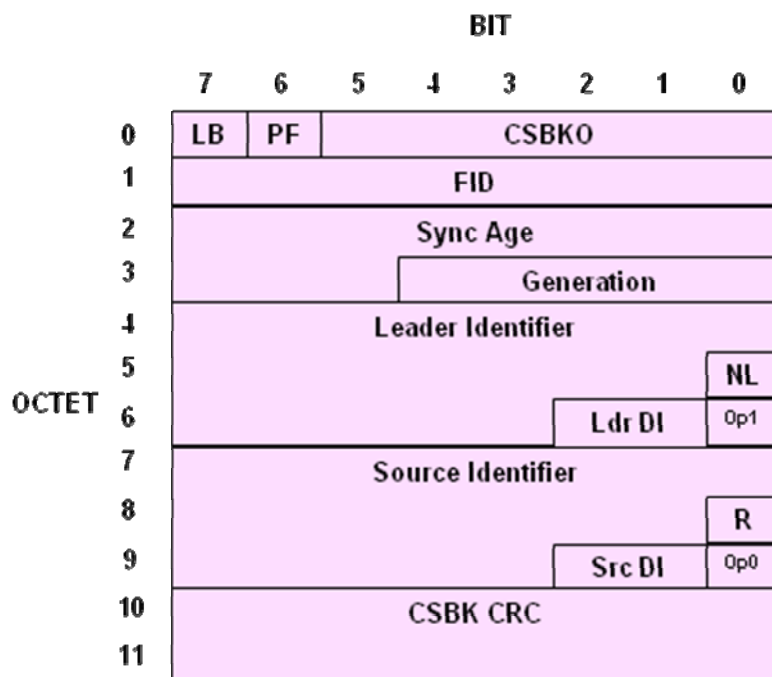

Figure 7.1: CT_CSBK PDU content

The Leader Identifier MSB is located in octet 4 bit 7 and the LSB is located in octet 6 bit 3. The Source Identifier MSB is located in octet 7 bit 7 and the LSB is located in octet 9 bit 3.

7.1.3 Short Link Control PDUs

7.1.3.1 Null Message

Bits 0 to 3 of Octet 0 of the Null Message (Nul_Msg) Short LC PDU conform to the Short LC format structure as defined in figure 7.2 of TS 102 361-1 [1]. Octets 1 to 3 contain the Null Message specific information. The Nul_Msg PDU is shown in table 7.9. This PDU is available for use in the CACH when there is no other PDU to be sent.

Table 7.9: Nul_Msg PDU content

Information element	Length	Remark
Feature elements		
Short LC Opcode (SLCO)	4	Shall be set to 0000 ₂
Reserved	24	All bits shall be set to 0 ₂

7.1.3.2 Activity Update

Bits 0 to 3 of Octet 0 of the Activity Update (Act_Updt) Short LC PDU conform to the Short LC format structure as defined in figure 7.2 of TS 102 361-1 [1]. Octets 1 to 3 contain the Activity Update specific information. The Act_Updt PDU is shown in table 7.10.

Table 7.10: Act_Updt PDU content

Information element	Length	Value	Remark
Feature Elements			
Short LC Opcode (SLCO)	4	0001 ₂	
Time Slot 1 Activity ID	4	0000 ₂	No activity on BS time slot 1
		0001 ₂	Reserved
		0010 ₂	Group CSBK activity on BS time slot 1
		0011 ₂	Individual CSBK activity on BS time slot 1
		0100 ₂	Reserved
		0101 ₂	Reserved
		0110 ₂	Reserved
		0111 ₂	Reserved
		1000 ₂	Group voice activity on BS time slot 1
		1001 ₂	Individual voice activity on BS time slot 1
		1010 ₂	Individual data activity on BS time slot 1
		1011 ₂	Group data activity on BS time slot 1
		1100 ₂	Emergency group voice activity on BS time slot 1
		1101 ₂	Emergency individual voice activity on BS time slot 1
		1110 ₂	Reserved
1111 ₂	Reserved		
Time Slot 2 Activity ID	4	0000 ₂	No activity on BS time slot 2
		0001 ₂	Reserved
		0010 ₂	Group CSBK activity on BS time slot 2
		0011 ₂	Individual CSBK activity on BS time slot 2
		0100 ₂	Reserved
		0101 ₂	Reserved
		0110 ₂	Reserved
		0111 ₂	Reserved
		1000 ₂	Group voice activity on BS time slot 2
		1001 ₂	Individual voice activity on BS time slot 2
		1010 ₂	Individual data activity on BS time slot 2
		1011 ₂	Group data activity on BS time slot 2
		1100 ₂	Emergency group voice activity on BS time slot 2
		1101 ₂	Emergency individual voice activity on BS time slot 2
		1110 ₂	Reserved
1111 ₂	Reserved		
Hashed address time slot 1	8	Destination	Compressed time slot 1 destination address (see note 1)
Hashed address time slot 2	8	Destination	Compressed time slot 2 destination address (see note 1)
NOTE 1: Hashed algorithm uses the 8-bit CRC calculation algorithm as defined in clause B.3.7 of TS 102 361-1 [1].			
NOTE 2: When BS receives a CSBK preamble, it announces the type of activity that follows the preambles.			

7.2 Layer 3 information element coding

The following clauses contain descriptions of the information elements contained within layer 3 PDUs, and provide a description of what the elements represent in relation to their bit representation. The structure of the tables is as follows:

- the information element column gives the name of the element;
- the element length column defines the length of the element in bits;
- the value column denotes fixed values or a range of values;
- the remarks column defines the meaning of the information element against each of its bit represented values.

7.2.1 Service Options

The Service Options information element has a length of 8 bits and is shown in table 7.11.

Table 7.11: Service Options

Information element	Length	Value	Remark
Emergency	1	0 ₂	Non-emergency service
		1 ₂	Emergency service
Privacy	1	0 ₂	See note 1
Reserved	2	00 ₂	Reserved for future use
Broadcast	1	0 ₂	Non-broadcast service
		1 ₂	Broadcast service (see note 2)
Open Voice Call Mode (OVCM)	1	0 ₂	Non-OVCM call
		1 ₂	OVCM call
Priority level	2	00 ₂	No priority
		01 ₂	Priority 1 (see note 3)
		10 ₂	Priority 2 (see note 3)
		11 ₂	Priority 3 (see note 3)
NOTE 1: Privacy is not defined in the present document.			
NOTE 2: Broadcast service is only defined for group calls.			
NOTE 3: Priority 3 is the highest priority.			

7.2.2 Answer Response

The Answer Response information element has a length of 8 bits and is shown in table 7.12.

Table 7.12: Answer Response

Information element	Length	Value	Remark
Answer Response	8	00100000 ₂	Proceed
		00100001 ₂	Deny

7.2.3 Reason Code

The Reason Code information element has a length of 8 bits and is shown in table 7.13.

Table 7.13: Reason Code

Information element	Length	Value	Remark
Reason Code	8	00100001 ₂	MS does not support this service or feature

7.2.4 Service Type

The Service Type information element has a length of 6 bits and indicates the service which is being identified. This is set equal to the appropriate CSBK Opcode value for the identified service.

7.2.5 Source Type

The Source Type information element has a length of 1 bit and is shown in table 7.14.

Table 7.14: Source Type

Information element	Length	Value	Remark
Source Type	1	0 ₂	BS sourced
		1 ₂	MS sourced

7.2.6 Additional Information Field

The Additional Information Field element has a length of 1 bit and is shown in table 7.15.

Table 7.15: Additional Information Field

Information element	Length	Value	Remark
Additional Information Field	1	0 ₂	Ignore Additional Information Field
		1 ₂	Additional Information Field valid
NOTE: PDUs without Additional Information Field is not defined in the present document and is for future use.			

7.2.7 CSBK Blocks to Follow (CBF)

The CSBK Blocks to Follow information element has a length of 8 bits and indicates the number of Preamble CSBK PDUs and either the following CSBK or data message that will be sent. The CBF information element is shown in table 7.16.

Table 7.16: CSBK Blocks to Follow information element content

Information element	Length	Value	Remark
Blocks to Follow	8	any	Number of blocks to follow
NOTE: CBF does not include the current block (i.e. the CSBK preamble) in the count of the number of blocks being sent.			

7.2.8 Identifier (ID)

The Identifier information element is part of the TDMA direct mode Wide Area Timing Identifier and has a length of 20 bits. The ID information element is shown in table 7.17.

Table 7.17: Identifier information element content

Information element	Length	Value	Remark
Identifier	20	00000000000000000000 ₂	(see note)
		All other values	MS derived ID
NOTE: If Source Identifier (SID) then initial value at power up and channel change. If Leader Identifier (LID) then leader unknown.			

7.2.9 Dynamic Identifier (DI)

The Dynamic Identifier information element is part of the TDMA direct mode Wide Area Timing Identifier, has a length of 2 bits and characterizes a MS units ability and preference to serve as a TDMA direct mode timing leader. The ID information element is shown in table 7.18.

Table 7.18: Dynamic Identifier information element content

Information element	Length	Value	Remark
Dynamic Identifier	2	00 ₂	(see note)
		01 ₂	Leader Preference: Low
		10 ₂	Leader Preference: Medium
		11 ₂	Leader Preference: High
NOTE: If Source Dynamic Identifier (SDI) then initial value at power up and channel change. If Leader Dynamic Identifier (LDI) then leader unknown. MS may change DI value (MS_DI) over time to relinquish leader role in order to conserve battery.			

7.2.10 Wide Area Timing Identifier (WATID)

The Wide Area Timing Identifier information element has a length of 22 bits. The WATID information element is shown in table 7.19.

Table 7.19: Wide Area Timing Identifier information element content

Information element	Length	Value	Remark
Wide Area Timing Identifier	2		Dynamic Identifier (see note)
	20		Identifier (see note)
NOTE: If Source WATID, both information elements are for the transmitting MS. If Leader WATID, both information elements are for the timing leader of the transmitting MS.			

7.2.11 Channel Timing Opcode (CTO)

The Channel Timing Opcode information element has a length of 2 bits and identifies the purpose of a CT_CSBK. The CTO information element is shown in table 7.20.

Table 7.20: Channel Timing Opcode information element content

Information element	Length	Value	Remark
CT Opcode	2	00 ₂	Unaligned request
		01 ₂	Unaligned terminator
		10 ₂	Aligned channel timing status (see note 1)
		11 ₂	Aligned channel timing push (see note 2)
NOTE 1: Use cases include aligned requests, terminators, responses and corrections without push.			
NOTE 2: Use cases include leader beacon, beacon propagation and aligned correction with push.			

NOTE 1: When CTO MSB is 1, the CT_CSBK indicates the transmission is following the wide area timing leader and when CTO MSB is 0, the CT_CSBK indicates the transmission is not following the wide area timing leader.

NOTE 2: Detailed rules reside in clause 6.2.3.

7.2.12 New Leader (NL)

The New Leader information element has a length of 1 bit. The NL information element is shown in table 7.21.

Table 7.21: New Leader information element content

Information element	Length	Value	Remark
New Leader	1	0 ₂	MS accepts current leader
		1 ₂	(see note)
NOTE: When transmitting, MS appoints a MS as the new wide area timing leader. When receiving, targeted MS is appointed the new wide area timing leader.			

7.2.13 Generation (Gen)

The Generation information element has a length of 5 bits. The Generation information element is shown in table 7.22.

Table 7.22: Generation information element content

Information element	Length	Value	Remark
Generation	5	00000 ₂	(see note)
		All other values	Number of timing hops from leader
NOTE: MS is the wide area timing leader or wide area timing leader is unknown.			

7.2.14 Sync Age (SA)

The Sync Age information element has a length of 11 bits. The Sync Age information element is shown in table 7.23. It is used to reject received channel timing when the source MS has not been refreshed directly or indirectly for the wide area channel timing leader within a prescribed amount of time. The SyncAge increment (SAIncr) is 500 ms.

Table 7.23: Sync Age information element content

Information element	Length	Value	Remark
Sync Age	11	00000000000 ₂	(see note)
		All other values	Time since last beacon in Sync Age Increments
NOTE: Value in MS beacon when transmitting MS is the wide area timing leader or when the wide area timing leader is unknown.			

Annex A (normative): Timers and constants in DMR

This annex lists the timers and constants in a DMR MS.

Where indicated, a value should be chosen by the MS/BS designer from within the specified range. For other timers and constants, a default value may be specified and the value of these timers and constants shall be configurable within the DMR entity (MS or BS).

A.1 Layer 3 timers

T_AckWait ACKWait timer
Value chosen by MS designer.
Recommended value = 360 ms for UU_Ans_Rsp.

Recommended minimum value (simulcast systems) = 2,0 seconds

NOTE 1: T_AckWait is used when an MS transmits a CSBK and is waiting for a response from the target. Upon expiration of this timer, the MS attempts to retransmit the CSBK if the CSBK_Retry_Limit has not been exceeded.

T_TO Timeout timer
Value = 180 s for DMR Tier I.
Value chosen by MS designer between 0 (see note) and 180 s for DMR Tier II and Tier III.

NOTE 2: Timer is disabled if T_TO is 0 s.

CT_RHOT CT_CSBK transmission Random HoldOff Timer
Used to minimize CT_CSBK transmission collisions.

Leader timing unknown
Uniform distribution between 0 and 3,24 seconds with an increment of 60 ms.
Leader timing known
After a CT_CSBK transmission: 2,16 to 3,24 seconds with an increment of 60 ms.
Decrement range by 120 ms for each scheduled CT_CSBK that is cancelled.

NoLeader Upon power up or channel change, the amount of time MS will monitor channel for wide area timing information before transmitting a request.
Value = 4,5 minutes.

SyncAge Amount of time wide area timing sync information is valid before MS requires updated sync information.
Value = 10 minutes, increment (SAIncr) = 500 ms.

NOTE 3: The SyncAge value is linked to the TDMA direct mode time base clock drift error requirements as stated in clause 10.1.4.

SyncAgeWarning Amount of time MS will go without updated sync information before requesting updated sync information.
Value = 9 minutes (2*BeaconInterval).

NOTE 4: The SyncAgeWarning value is linked to the TDMA direct mode time base clock drift error requirements as stated in clause 10.1.4.

A.2 Layer 3 constants

N_CSBKRetry	CSBK Retry limit Value chosen by MS designer and application specific. Recommended value = 1 for UU_V_Req.
BeaconDuration	Duration of a CT_CSBK_Beacon and CT_CSBK_Prop transmission. Minimum value = 600 ms.
BeaconInterval	Time between start of two consecutive CT_CSBK_Beacon transmissions by the wide area timing leader MS. Value = 4,5 minutes.
CTDuration	Duration of a CT_CSBK_Req and CT_CSBK_Resp transmission. Minimum value = 180 ms.

Annex B (normative): Opcode Reference Lists

B.1 Full Link Control Opcode List

Table B.1: FLCO List

FLCO	Description	Alias
000000 ₂	Group Voice Channel User	Grp_V_Ch_Usr
000011 ₂	Unit to Unit Voice Channel User	UU_V_Ch_Usr

B.2 CSBK Opcode List

Table B.2: CSBKO List

CSBKO	Description	Alias
000100 ₂	Unit to Unit Voice Service Request	UU_V_Req
000101 ₂	Unit to Unit Voice Service Answer Response	UU_Ans_Rsp
000111 ₂	Channel Timing CSBK	CT_CSBK
100110 ₂	Negative Acknowledgement Response	NACK_Rsp
111000 ₂	BS Outbound Activation	BS_Dwn_Act
111101 ₂	Preamble CSBK	Pre_CSBK

B.3 Short Link Control Opcode List

Table B.3: SLCO List

SLCO	Description	Alias
0000 ₂	Null Message	Nul_Msg
0001 ₂	Activity Update	Act_Updt

Annex C (informative): Numbering and dialling plan

C.1 Introduction to the numbering and dialling plan

It is recognized that manufacturers of MSs will wish to exercise design independence in their products and, accordingly, the requirements of this annex are informative only.

This annex is intended to:

- define the user visible numbering (User Interface domain); and
- dialling in a MS for accessing other MS(s) or other entity(ies) over the AI; and
- to describe how the visible user numbering and dial strings may be mapped on to the AI.

The Man Machine Interface (MMI) issues have been addressed in these annex only to the extent of those strictly related to numbering and dialling.

It should be ensured in the MS implementation, that no non-deterministic user input results in an ambiguous call set-up attempt over the Air Interface. For example, if a user inputs a dialled string of digits that is not assigned to any of the presented dialling algorithms, then the MS should not try to establish the call and appropriate feedback or alert should be given to the user.

As not to restrict manufacturer's independence, it is envisaged that dialling selection may be initiated in many ways. Some methods are:

- direct number entry via a keypad;
- mode selection buttons; and
- soft key menu selection.

The dialling method may vary according to the MS terminal type. This annex is applicable to MSs with a basic CCITT number keypad, as shown in figure C.1 and/or with a display capable of displaying the decimal numbers "0" to "9" and the keys "*" and "#". However, manufacturers may employ other keypad layouts.

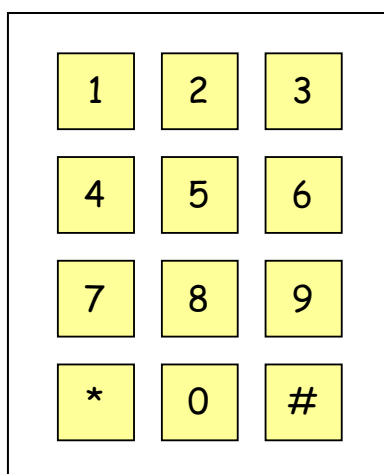

Figure C.1: CCITT keypad layout

The primary use for the keypad is to enable the user to select the destination address, the type of service, and to initiate calls from the MS. The destination may be other MS(s), to line connected entities via gateways (e.g. a PABX exchange) and to subscribers on the Public Switched Telephone Network (PSTN). Other services may be requested by dialling "call modifier" strings prior to entering the destination address.

The user input in case of establishing a call is defined for the purposes of this annex as two sequential events:

- a) user dials digits, and
- b) user initiates call.

The call initiation is the event, which terminates the user input related to the digits and normally causes a call set-up. The call initiation event itself may be either when the user presses the "#" key or Push-To-Talk (PTT) or other method that may be manufacturer or implementation specific.

NOTE: This definition of the user input for call establishment is valid only for the cases when a user dials a number using the number keypad or selects a number e.g. from a list of predefined numbers. There may be methods to combine all the three events so that e.g. PTT causes a call establishment using a predefined dialling algorithm to a predefined address requiring no explicit dialling event.

Manufacturers may implement barring of certain types of call or restrict calls to certain addresses. However, such constraints are outside the scope of this annex. It should be noted that some of the DMR services that may be initiated in this annex are only applicable to MSs that are communicating through a DMR repeater.

The MS may contain predefined parameters prescribing the minimum and maximum length of the user dial string. By limiting the length of the dialled string the address range the MS is able to dial is restricted. The minimum length parameter may be set according to the user needs, e.g. to disable accidental 1-digit dialling.

The (User Interface) address that an individual MS is assigned (its own address) may be defined by the dialled digits another MS would dial to reach that MS rather than the Air Interface binary number. If the algorithm specified in this annex were implemented, an MS individual address would be fully specified by seven decimal digits. Similarly, if a MS was personalized with one or more talkgroup addresses, they may be specified at the user interface by seven decimal digits.

C.2 Subscriber mapping

C.2.1 User Interface - Air Interface

Dialled digits are represented in decimal notation and utilize the numbers "0" to "9" and the keys "*" and "#". For an MS fitted with a keypad, the "#" key may initiate a call (although other initiate methods may be implemented by a manufacturer). Dialled digits that represent a destination address are translated to a form for the Air Interface by one of two algorithms specified in clauses C.2.1.1 and C.2.1.2. This is illustrated in figure C.2.

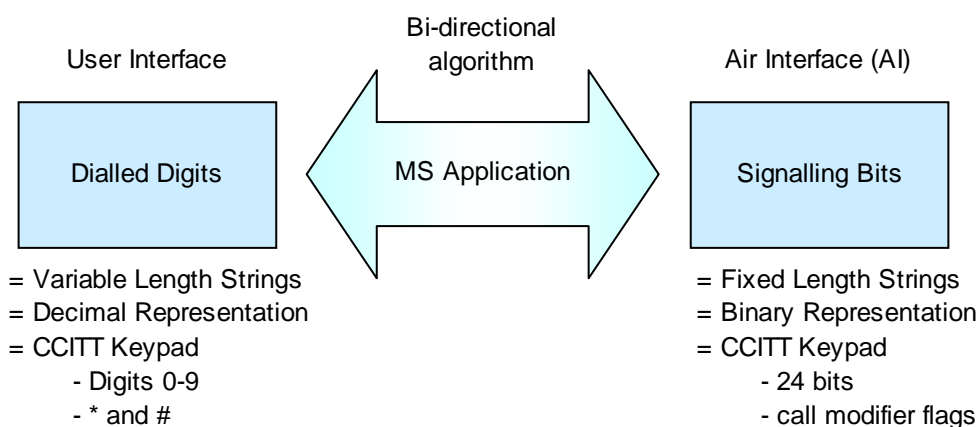

Figure C.2: Number conversion

Address fields in the Air-Interface domain structure has a length of 24 bits.

The content of a 24-bit AI MS address field may represent:

- an MS individual address;
- an MS group address;
- a gateway address; or
- a special identifier.

The Air Interface provides call services for voice and data. The AI also permits the call services to be modified to (for example) provide priority and emergency calling. The application that converts the User Interface to the Air Interface recognizes the "call modifier" and requests the lower layers to set appropriate bits in the PDUs carried between the entities. At the User Interface, the "call modifier" is indicated by preceding the destination address digits with additional "call modifier" digits.

C.2.1.1 Mapping for MS individual address space

The mapping between the User Interface and individual AI address space for diallable digits is shown in figure C.3.

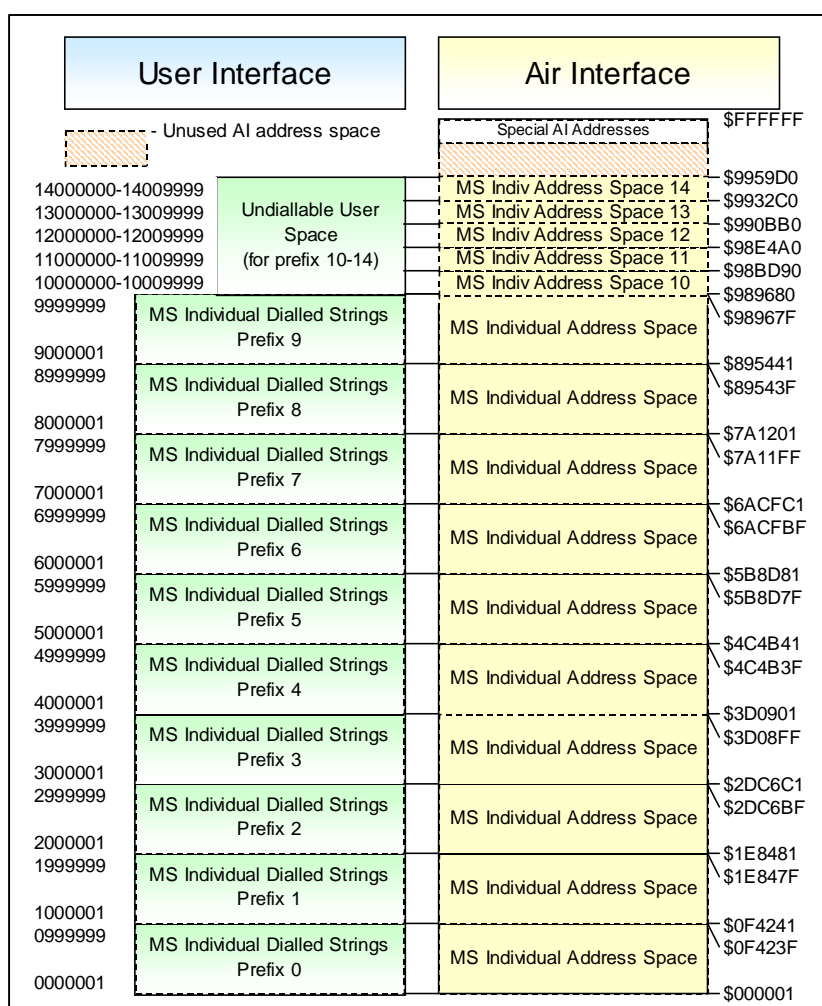

Figure C.3: User domain mapping for calls in the individual addresses space

Figure C.3 illustrates the individual address space domain mapping. It can be seen that there is un-diallable address space within prefixes 10 to 14. These addresses are not reachable by user dialling and are available for devices with fixed addresses (for example telemetry devices could use these addresses. They would never be addressed by an MS in error because they are not reachable by dialling).

C.2.1.1.1 Mapping for diallable addresses (prefix 0 to 9)

A MS individual address is a 7 character numeric string in the range "0000001" to "9999999", these characters are mapped to the Air Interface domain structure bits by the reversible function B_1 .

Individual dialled addresses do not contain the symbol "*" which would be interpreted as a call to an MS talk-group.

Table C.1: 7-number diallable address mapping by B_1

Character							B_1	Air Interface ID
1	2	3	4	5	6	7		24 bits
K_1	K_2	K_3	K_4	K_5	K_6	K_7		

If the dialled string is considered as a string array K_1 to K_7 :

$$B_1 = \sum 10^6 \times K_1, 10^5 \times K_2, 10^4 \times K_3, 10^3 \times K_4, 10^2 \times K_5, 10 \times K_6, K_7$$

The seven user dialled digits K_1 to K_7 in the range "0000001" to "9999999" are converted to the 24 bits of the AI ID using true decimal to binary conversion.

C.2.1.1.2 Mapping for non-diallable individual addresses (prefix 10 to 14)

Table C.2: Non-diallable address mapping by B_3

Character							B_3	Air Interface ID
1	2	3	4	5	6	7		24 bits
K_1	K_2	$K_3=0$	$K_4=0$	K_5	K_6	K_7		

The B_3 algorithm provides a numeric User Interface for the non-diallable individual address space. Each prefix has the capacity for 10 000 individual addresses.

If the MS individual address is represented by 8 digits K_1 to K_8 (K_3 and K_4 are always 0).

$$B_3 = \sum 9\,900\,000, 10^5 \times K_1, 10^4 \times K_2, 10^3 \times K_5, 10^2 \times K_6, 10 \times K_7, K_8$$

The following steps are needed to convert the dialled digits to an ID in the AI domain using the B_3 algorithm:

- 1) start with the number 9 900 000;
- 2) take the first digit (0 to 9) and multiply by 100 000;
- 3) take the second digit (0 to 9), multiply by 10 000;
- 4) take the fifth digit (0 to 9), multiply by 1 000;
- 5) take the sixth digit (0 to 9), multiply by 100;
- 6) take the seventh digit (0 to 9), multiply by 10;
- 7) take the eighth digit (0 to 9); and
- 8) add a) to g).

C.2.1.1.3 Examples of individual address mapping

Examples of individual MS numbers in the user domain and AI domain are given in table C.3 (B_7 algorithm).

Table C.3: Examples of diallable individual address translation

User-Interface	Air-Interface (Hex)	Air Interface (Binary)
1234567	12D687 ₁₆	0001 0010 1101 0110 1000 0111 ₂
9876543	96B43F ₁₆	1001 0110 1011 0100 0011 1111 ₂

For non-diallable address space and prefixes in the range 10 to 14 the address in the user domain may be specified using 8 digits as shown in the table C.4 (B_3 algorithm).

Table C.4: Examples of non-diallable individual address translation

Non dilatable User-Interface	Air-Interface (Hex)	Air Interface (Binary)
10000000	989680 ₁₆	1001 1000 1001 0110 1000 0000 ₂
13004567	991D87 ₁₆	1001 1001 0001 1101 1000 0111 ₂
14009876	995954 ₁₆	1001 1001 0101 1001 0101 0100 ₂

NOTE: For non-diallable individual addressing, digits K_3 and K_4 are always zero.

C.2.1.2 Mapping for MS talkgroup address space

A talkgroup call is a separate DMR service to an individual call (see TS 102 361-1 [1], clause 4.2). The mapping between the User-Interface domain and the Air Interface uses a different algorithm to the MS individual address.

There is no ambiguity if the initiator wishes to setup a talkgroup call (i.e. the MS should be able to differentiate between an individual call request and a talkgroup call request). There are a number of methods by which a MS may distinguish a talkgroup call described in the following clauses.

C.2.1.2.1 The concept of the wildcard character

The MS may discriminate a talkgroup call from an individual call by the use of the "wildcard".

In the User Interface domain structure, if the dialled string represents an MS address, and contains a "*" in any of the four least significant characters, then that MS address represents a group of MSs. The "*" character is the "wildcard" and represents all numeric values in that digit position, as defined in example 1 to 3.

EXAMPLE 1: The user dials "012345*" means that the MS is addressing 10 separate MSs whose individual addresses are "0123450", "0123451", "0123452", "0123453", "0123454", "0123455", "0123456", "0123457", "0123458" and "0123459".

EXAMPLE 2: The user dials "01234*6" means the MS is addressing 10 separate MSs whose individual addresses are "0123406", "0123416", "0123426", "0123436", "0123446", "0123456", "0123466", "0123476", "0123486" and "0123496".

EXAMPLE 3: Wildcards may be combined. The user dials "01234**" represents 100 MSs in the range "0123400" to "0123499".

For operators who have no interest in this method of defining talkgroups, the "wildcard" feature may be disabled by MS programming.

C.2.1.2.2 The concept of stored parameters

The MS equipment may contain predefined parameters prescribing the MS addresses that will be interpreted as talkgroup addresses. These addresses may be stored as a list programmed during manufacture or before connecting an MS into service.

C.2.1.2.3 The concept of ad-hoc arrangement

The MS equipment may simply rely on a range of addresses that all equipment is known to be talkgroup addresses.

C.2.1.2.4 The rules for the sender

The following rules may determine if the call is to a talkgroup:

IF dialled_string

contains a "*" in any of the least significant four characters

OR

matches a string of numeric digits that are stored in the MS specifically indicating a talkgroup

OR

can be determined as a talkgroup by any other method chosen by the manufacturer

THEN

the address represents a talkgroup. Initiate the talkgroup service

ELSE

the address represents an individual call. Initiate the individual call service

ENDIF

C.2.1.2.5 The rules for the recipient

These rules determine a call is to a talkgroup and will be accepted by a MS. (All reference to MS in this clause refer to the recipient.)

MS receives a DMR service addressed to a talkgroup.

MS uses the reverse of the B_2 function specified in clause C.2.1.2.6 to translate the AI talkgroup address to the User Interface domain.

IF digits (User Interface)

contains a "*" in any of the least significant four characters

THEN

each digit received is compared with each corresponding digit of the MS individual address except where the received digit is a "*". If there is a match on all applicable digits then this MS is party to the talkgroup call.

ELSE

(consists of numeric characters only)

THEN

EITHER

The string of digits received is compared with each corresponding string of talkgroup digits that the MS has stored (specifically indicating a talkgroup).

If there is a match then this MS is party to the talkgroup call.

OR

The MS is party to the talkgroup call by any other method chosen by the manufacturer

ENDIF

C.2.1.2.6 Mapping of dialled strings to the AI talkgroup address space

A MS talkgroup address is a 7-character numeric string in the range "0000001" to "999****", these characters are mapped to the Air Interface domain structure bits by the reversible function B_2 .

Talkgroup addresses may consist of all numeric characters (but the MS should be able to ascertain the address is a talkgroup address rather than an individual address). Alternatively any of the last four characters may contain one or more "*" characters that explicitly signifies the address is a talkgroup address.

The algorithm to convert from the user is slightly more complex for talkgroups in order to accommodate the extra "*" character.

C.2.1.2.6.1 Mapping of numeric dialled strings to the AI talkgroup address space

Table C.5: Diallable talkgroup address mapping by B_2

Character							B_2	Air Interface ID
1	2	3	4	5	6	7		24 bits
K_1	K_2	K_3	K_4	K_5	K_6	K_7		

K_1, K_2, K_3 represent decimal symbols in the range 0 to 9.

K_4, K_5, K_6, K_7 represent symbols to base 11 using the digits 0, 1, 2, 3, 4, 5, 6, 7, 8, 9, *.

The "*" is a symbol that has the value of 10.

The six least significant user dialled digits K_2 to K_7 in the range "000001" to "999999" are converted to the 20 least significant 20 bits of the AI ID using true decimal to binary conversion. The most significant user dialled digit K_1 is converted to the most significant 4 bits of the AI ID using a true decimal to binary conversion.

$$B_2 = \sum K_1 \times 1\,464\,100, K_2 \times 146\,410, K_3 \times 14\,641, K_4 \times 1\,331, K_5 \times 121, K_6 \times 11, K_7$$

To following steps are needed to convert the dialled digits to an ID in the AI domain:

- 1) take the first digit (0 to 9) and multiply by 1 464 100;
- 2) take the second digit (0 to 9), multiply by 146 410;
- 3) take the third digit (0 to 9) and multiply by 14 641;
- 4) take the fourth digit (0 to 9) or * (* has a value of 10) and multiply by 1 331;
- 5) take the fifth digit (0 to 9) or * (* has a value of 10) and multiply by 121;
- 6) take the sixth digit (0 to 9) or * (* has a value of 10) and multiply by 11;
- 7) take the seventh digit (0 to 9) or * (* has a value of 10);
- 8) add a) to g); and
- 9) convert the sum to a 24-bit binary number.

Figure C.4 illustrates the talkgroup address space domain mapping.

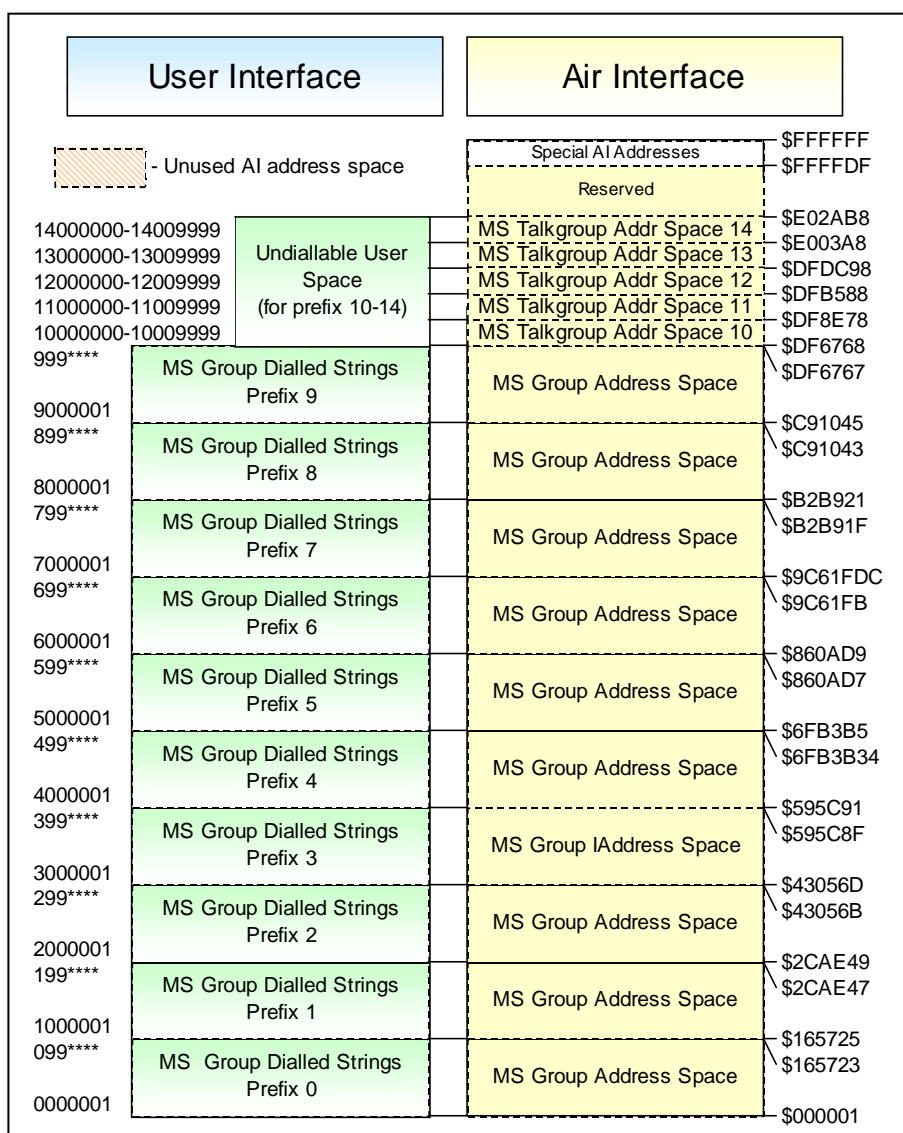

Figure C.4: Domain mapping for calls in the talkgroup addresses space

Examples are shown in table C.6.

Table C.6: Examples of talkgroup address translation

User-Interface	Air-Interface (Hex)	Air Interface (Binary)
1234567 (see note)	1B91FD ₁₆	0001 1011 1001 0001 1111 1101 ₂
468956*	68BF08 ₁₆	0110 1000 1011 1111 0000 1000 ₂
012345*	02C00A ₁₆	0000 0010 1100 0000 0000 1010 ₂
0123460 (see note)	02C00B ₁₆	0000 0010 C000 0000 0000 1011 ₂
999****	DF6767 ₁₆	1101 1111 0110 0111 0110 0111 ₂
NOTE:	The MS must have already distinguished the dialed string as a talkgroup address using the rules defined in clauses C.2.1.2.1 to C.2.1.2.4.	

C.2.1.2.6.2 Mapping for non-diallable talkgroup addresses (prefix 10 to14)

Table C.7: Non-diallable talkgroup address mapping by B_4

Character							B_4	Air Interface ID
1	2	3	4	5	6	7		24 bits
K_1	K_2	$K_3=0$	$K_4=0$	K_5	K_6	K_7		

The B_4 algorithm provides a numeric User Interface for the non-diallable individual address space. Each prefix has the capacity for 10 000 individual addresses.

If the MS talkgroup address is represented by 8 digits K_1 to K_8 (K_3 and K_4 are always 0).

$$B_4 = \sum 14\,541\,000, 10^5 \times K_1, 10^4 \times K_2, 10^3 \times K_5, 10^2 \times K_6, 10 \times K_7, K_8$$

The algorithms result in unique unambiguous translation between the User Interface domain and the Air Interface, are reversible and result in no lost codes.

To following steps are needed to convert the dialled digits to an ID in the AI domain using the B_4 algorithm:

- 1) start with the number 14 541 000;
- 2) take the first digit (0 to 9) and multiply by 100 000;
- 3) take the second digit (0 to 9), multiply by 10 000;
- 4) take the fifth digit (0 to 9), multiply by 1 000;
- 5) take the sixth digit (0 to 9), multiply by 100;
- 6) take the seventh digit (0 to 9), multiply by 10;
- 7) take the eighth digit; and
- 8) add a) to g).

C.2.1.2.6.3 Examples of talkgroup non-diallable address mapping

Examples of non-diallable talkgroup in the user domain and AI domain are given in table C.8 (B_4 algorithm).

Table C.8: Examples of non-diallable talkgroup address translation

User-Interface	Air-Interface (Hex)	Air Interface (Binary)
12005678	\$DFCBB6	1101 1111 1100 1011 1011 0110
13001234	\$DFE16A	1101 1111 1110 0001 0110 1010

NOTE: For non-diallable individual addressing, Digits K_3 and K_4 are always zero.

C.2.1.2.7 The concept of the prefix

A Colour Code (CC) is defined in the AI to provide a simple means of distinguishing overlapping radio sites, in order to detect co-channel interference.

The Colour Code may be combined with the prefix to separate differing system operators using shared channels. The prefix separates the total address space into non-overlapping bands. This may be specified using the syntax:

cc.pp,

where:

- "cc" is the decimal value of the Colour Code; and
- "pp" is the decimal value of the prefix.

The prefix bands illustrated in figure C.5 show how the total DMR address space is split into bands.

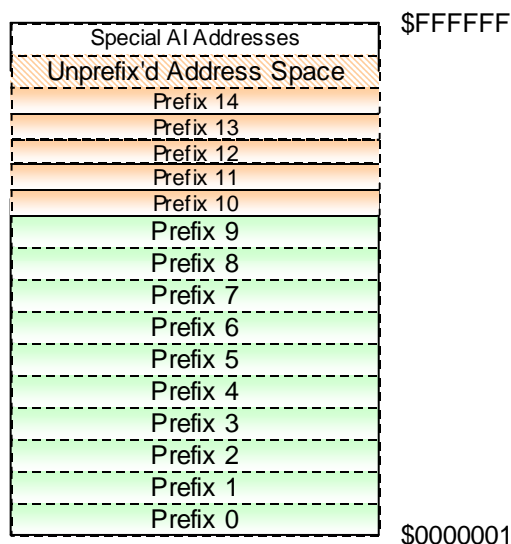

NOTE: The prefix exists in the User Domain although the effect is to split up the address space in the AI domain.

Figure C.5: Illustration showing how the prefix separates the address space

In the user domain a full MS address is defined using 7 digits, $K_1, K_2, K_3, K_4, K_5, K_6,$ and K_7 for the diallable addresses.

The non-diallable addresses use a two digit prefix so the full MS address is defined using 8 digits, $K_1, K_2, K_3, K_4, K_5, K_6, K_7,$ and K_8 .

The prefix is selected by the most significant digit in the full 7 digit string (K_1).

NOTE: Only prefixes 0 to 9 may be dialled by a user. Prefixes 10 to 14 provide a sub-set of the address space just as prefixes 0 to 9, but those addresses are not diallable by users.

If a system uses the prefix to separate autonomous operators, special arrangements need to be made for certain Air Interface Addresses. These are:

- for the MS talkgroup service:
 - Unaddressed talkgroup IDs;
 - special talkgroups containing all MSs;
 - gateways to system (e.g. repeater) and system interfaced devices not addressable via the ID (e.g. PABX, PSTN, SMS router).
- for the MS individual call service:
 - special IDs used to address all MSs.

The services specified above, each have sixteen addresses. Fifteen of the addresses ($n=0-14$) are provide a service that is specific to a prefix- n . The address for $n=15$ is the default if prefixes are not employed, or if a service to "ALL prefixes" if prefixes are employed. An example is given below. For a detailed definition of the addressing scheme, refer to TS 102 361-1 [1], annex A.

EXAMPLE: To address all MSs in prefix 5 with an ALLCALL, the sender may set the recipients address as "All Talkgroup ID5" ($FFFFF5_{16}$). In this example only the MSs programmed as prefix 5 will take any action. If the sender wished to address all MSs irrespective of their prefix the recipient address may be set to "All Talkgroup ID15" ($FFFFF15_{16}$).

The default special Air Interface addresses use the address indexed by $n=15$ and marked "default" in annex A of TS 102 361-1 [1].

C.2.2 Addresses

An MS is pre-programmed with at least one individual or one talkgroup identity.

An MS is permitted to have multiple individual identities and multiple talkgroup identities.

An MS may contain a list of talkgroup identities, which may be pre-programmed or dynamically updated (manually or over the AI).

The User Interface domain maps to the AI individual diallable address space by the B_1 algorithm.

The User Interface domain maps to the AI talkgroup diallable address space by the B_2 algorithm.

C.2.3 Conversion rules

C.2.3.1 MS addresses

An MS address in the User-Interface structure is defined as 7 characters of which for an individual MS address contain the characters "0" to "9". This is converted to the Air-Interface Domain by the B_1 function. For a talkgroup address the three most significant contain the characters "0" to "9" and least significant four characters contain the characters "0" to "9" or "*". This is converted to the Air-Interface Domain by the B_2 function.

C.2.3.2 Limiting the length of the destination address

The MS equipment may contain predefined parameters prescribing the minimum and maximum length of the user dial string. By limiting the length of the dialled string, the address range that the MS is able to dial is restricted.

C.2.3.3 All talkgroup address

The All Call dialled string "n*****" (All Call within a prefix) is mapped as shown in table C.9.

Table C.9: Mapping of prefixed All Call to the AI

User dialled string	Air Interface ID	Remark
"0*****"	$FFFFF0_{16}$	All Talkgroup ID0
"1*****"	$FFFFF1_{16}$	All Talkgroup ID1
etc.	etc.	etc.
"9*****"	$FFFFF9_{16}$	All Talkgroup ID9

The All Call dialled string: "*****" is mapped to the All Talkgroup ID15 and addresses all MSs irrespective of their prefix.

Table C.10: Mapping of all prefix call to the AI

User dialled string	Air Interface ID	Remark
"*****"	FFFFFF ₁₆	All Talkgroup ID15

C.2.3.4 Gateways

When calls are made to destinations other than MSs, the calling MS uses appropriate FID/FLCO (see TS 102 361-1 [1]) signalling to indicate that this is a call to be connected via a gateway (such as a PSTN destination or PABX extension). Extended signalling may be needed to convey the destination digits through the gateway.

C.3 User dialling plan

C.3.1 User numbering

A unified dialling plan is defined for both peer-to-peer and networked modes. The plan provides up to 9 999 990 diallable individual user addresses and 14 640 990 diallable talkgroups.

All dialled strings, as defined in the clause C.3 , are read from left to right and are dialled in the sequence in which they are read. Throughout this clause all representations of dialled strings are underlined>.

MSs may only be required to dial sufficient numbers of characters unambiguously define the destination and service required.

C.3.1.1 Dialling method

To maximize channel utilization, the user should enter a string of digits and then press a button to initiate the call.

The "#" key or a dedicated "send" key is used to initiate the call. The "#" key has an additional purpose of modifying the call type or priority.

C.3.1.2 Call Type determination

Underlying signalling and system functionality is hidden from the user. MSs determine the call type and function from the length and content of the dialled string.

C.3.1.3 Call modifier strings

Dialled strings that commence with a hash "##" provide secondary uses for the keypad.

Secondary dialling functions may be as follows:

- Telephone hash modifier format, see clause C.3.4.2.1.2;
- PABX hash modifier format, see clause C.3.4.2.2.2;
- Call priority setting, see clause C.3.4.3.2;
- Call Diversion, see clause C.3.4.3.5;
- Broadcast Call, see clause C.3.4.3.1;
- Emergency Call, see clause C.3.4.3.3.

Secondary dialling is achieved by the use of call modifier strings in front of the dialled number. These call modifier sequences utilize the "##" and "*#" keys in a similar manner to that used in PABX telephone exchanges.

C.3.2 Dialed digits to address mapping

The User-Interface employs 11 symbols "0" to "9" and "*" and "#".

In the User-Interface domain structure, if the string represents an MS address, and contains a "*" in any of the four least significant characters, then that MS address represents a group of MSs.

The length of destination MS address dialed digits is in the range from 1 to 7, and is interpreted as the right most digits of the recipient's number. The MSs individual address is used as a base address, and the right-most digits of that number are replaced by the user dialed digits, as shown in example 1 and 2. The resulting number is then converted to the AI ID using the algorithm presented in the annex C.

EXAMPLE 1: An MS whose individual address is "1234567" (in the user domain), dials "43".

MS source address	1	2	3	4	5	6	7
Dialed destination						4	3
Full destination address, see note	1	2	3	4	5	4	3
NOTE: Destination address after processing.							

EXAMPLE 2: This example is a call to a talkgroup, described in clause C.2.1.2.1.

MS source address	1	2	3	4	5	6	*
Dialed destination							*
Full destination address, see note	1	2	3	4	5	6	*
NOTE: Destination address after processing.							

C.3.3 Storage requirements

C.3.3.1 MS individual address

An MS is allocated a numeric address in the range in the range "000001" to "9999999", see note. MSs may be programmed with more than one individual address.

NOTE: The addresses "1000000", "2000000", "3000000", "4000000", "5000000", "6000000", "7000000", "8000000", and "9000000" are not valid.

C.3.3.2 Talkgroups

Talkgroups may be both all numeric numbers, or contain a "*" in any of the least significant four digits.

C.3.3.3 All MSs

All units respond to All MSs address "*****#".

All units with prefix "n" respond to the prefixed All MS address "n*****#" with n=0 to 9.

See clause C.2.3.3 for the mapping of MS dialed digits "n*****#".

C.3.3.4 Non-diallable numbers

MS Addresses "0000000", "1000000", "2000000", "3000000", "4000000", "5000000", "6000000", "7000000", "8000000", "and 9000000" are not diallable. If the user inputs a dialed string of digits that is not assigned to any of the dialling algorithms, then the MS should not try to establish the call and appropriate feedback given to the user.

C.3.3.5 Talkgroup recognition

C.3.3.5.1 All numeric talkgroups

Each MS has storage allocated for a minimum of 16 numeric talkgroup addresses. The table is populated during MS personalization by the user, or over the AI. The sender (MS) may use entries in this table to establish that the destination address is a talkgroup rather than an individual address.

The talkgroup table contains entries consisting of the full talkgroup address consisting of 7 characters as shown in the example.

EXAMPLE: The sender (MS) whose individual address is "1234561" has the destination "12345567" stored in its talkgroup table. The user enters a single digit "7" as the destination address.

The full destination address is formed from the dialled digit(s) and the MS own individual address.

MS source address	1	2	3	4	5	6	1
Dialled destination							7
Full (Talkgroup), see note	1	2	3	4	5	6	7
NOTE: Destination address after processing.							

The talkgroup table is searched for a match. In this example there is a match so the destination address is a talkgroup addresses

C.3.3.5.2 Talkgroups defined by wildcards

The dialled string is examined by the initiating MS. If the destination is identified as a talkgroup because the address contains a "wildcard" character in one of the four least significant digits then call set-up procedure is to a talkgroup as shown in the example. Abbreviated dialling minimizes the number of dialled digits. An advantage of using "wildcard" to define talkgroups is that no pre-arrangement is necessary, i.e. there is no need for a talkgroup table or other MS configuration to recognize an address as a talkgroup.

EXAMPLE:

MS source address	1	2	3	4	5	6	1
Dialled destination							*
Full destination address, see note	1	2	3	4	5	6	*
NOTE: Destination address after processing.							

C.3.3.5.3 MS receives a talkgroup call

The recipient MS applies the reverse B_2 to recover the dialled digits K_1 to K_7 .

- If the received digits contain a "*" in the digits K_4 to K_7 then:
 - each digit is compared in turn with the corresponding digit of the MS individual identity looking for a match. If an "*" is encountered then a match for that digit is assumed.
- If the received digits are all numeric then:
 - the digits K_1 to K_7 are compared with each of the entries in the talkgroup table looking for a match (after each entry in the table has been expanded to the full 7 address digits as described in clause C.3.3.5.1.

A match should exist for the MS to respond to the talkgroup call.

C.3.4 Dialling procedures

C.3.4.1 MS calls

C.3.4.1.1 Seven digit dialling

The user may enter the whole seven digit address to complete the dialled string prior to transmission. The number of digits within an address may be restricted by MS programming to restrict the number range over which the MS may access. For example the MS may be restricted to six digits to prevent the MS from reaching other MSs outside its own prefix.

C.3.4.1.2 Abbreviated dialling

Where abbreviated keypad dialling is used in the MS, the MS should insert the more significant characters from the MS individual address to complete the dialled string prior to transmission.

If all digits are not dialled the more significant digits from the MS individual address are copied to the dialled string to build a seven digit address so:

For the MS individual address "2112345":

- if the user dials 6#, the destination address should be 2112346;
- if the user dials 56#, the destination address should be 2112356;
- if the user dials 958#, the destination address should be 2112958;
- if the user dials 1385#, the destination address should be 2111385;
- if the user dials 13*5#, the destination address should be 21113*5 (talkgroup).

(The double underlined characters represent those that have been copied from the MS individual address.)

At the Air Interface the calling party address is transferred to the called party. The abbreviated dialling may be applied to display only an abbreviated calling party address on the display of the called party.

Figure C.6 shows abbreviated dialling applied to the calling party and shows how the recipient may display the abbreviated calling party address.

- 1) The calling party dials a single digit "2".
- 2) The MS inserts the more significant digits from its individual address to complete the dialled string prior to transmission - i.e. the destination address becomes "1234562".
- 3) The called and calling party addresses are passed across the Air Interface.
- 4) The "B" party decodes the called party address and there is a match and the "B" party receives the call.
- 5) The "B" party decodes the calling party address and may display only an abbreviated digit(s). In this case a single digit "1".

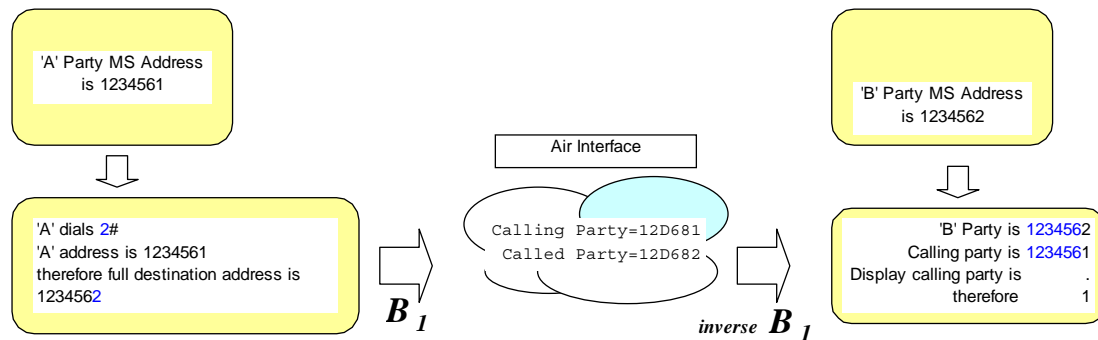

Figure C.6: Example of abbreviated dialling

The abbreviated display is sufficient for the "B" party to know who has called because the "B" party could call the "A" party by the same abbreviated dialling.

By using abbreviated dialling, the DMR dialling plan is appropriate for the smallest and largest fleets.

C.3.4.1.3 Individual call

Individual calls can be initiated by another MS user entering the full seven digit number followed by the "#" character to indicate that dialling is complete and that the call is to be initiated. Abbreviated dialling should be allowed.

EXAMPLE: The dialled digits "2164324#" should initiate an individual call to MS "2164324".

C.3.4.1.4 Talkgroup Call

Talkgroup calls can be initiated by another MS user entering the full seven digit number, with any of the only four least significant characters contains a "*", followed by the "#" character to indicate that dialling is complete and that the call is to be initiated. Abbreviated dialling should be allowed.

C.3.4.1.5 All Call

All units respond to All MSs address "*****#".

All units within a prefix respond to All MSs address "n*****#":

- in direct mode if permitted during MS personalization;
- in a networked system, if permitted by personalization and if permitted by the system.

C.3.4.2 Gateway calls

C.3.4.2.1 Telephone call

PSTN telephone numbers may be dialled using two alternative methods.

C.3.4.2.1.1 Telephone numeric padding format

PSTN telephone numbers are called by entering the "9" or a "0" followed by a 7 to 20 digit telephone number followed by the "#" character to indicate that dialling is complete and that the call is to be initiated.

EXAMPLE 1: "91234530#" should initiate a telephone call to the telephone subscriber "1234530". Likewise dialling "001256484530#" should dial telephone subscriber "01256484530".

Telephone numbers can be of length 7 to 20 digits and can have any digit 0 to 9 in any position in the dialled string.

Any telephone numbers that are outside this range (e.g. four digit PSTN numbers) should require to be padded with leading digits to a length that can be dialled. This padding may be stripped by the telephone interconnect (at the physical gateway) to ensure correct dialling.

If the first dialled digit is the "#" key and the key is held for more than *DIALn* seconds, the international dialling symbol "+" should be inserted into the dialled string, replacing the "*" character. For a MS employing a display, the "+" character should be shown.

EXAMPLE 2: "+441253123456#" should initiate a telephone call to the U.K. The number is compiled as follows:

"+"	international gateway
"44"	U.K
"1253"	National Code
"123456"	Local Number

C.3.4.2.1.2 Telephone star modifier format

PSTN telephone numbers are called by entering "*9" or "*0" followed by a 3 to 20 digit telephone number followed by the "#" character to indicate that dialling is complete and that the call is to be initiated.

EXAMPLE: "*9845#" should initiate a PSTN telephone call to the telephone subscriber "845". Likewise dialling "*035276#" should dial telephone subscriber "35276".

Telephone numbers can be of length 3 to 20 digits and can have any digit 0 to 9 in any position in the dialled string.

C.3.4.2.2 PABX call

PABX telephone numbers may be dialled using two alternative methods.

C.3.4.2.2.1 PABX numeric padding format

PABX numbers are called by entering "8" followed by a 7 to 20 digit extension number followed by the "#" character to indicate that dialling is complete and that the call is to be initiated.

EXAMPLE: "81234530#" should initiate a PABX call to the extension "1234530". Likewise dialling "81256484530#" should dial PABX extension "1256484530".

Extension numbers can be of length 7 digits to 20 digits and can have any digit 0 to 9 in any position in the dialled string.

Any extension numbers that are outside this range (e.g. three digit PABX numbers) should require to be padded with leading digits to a length that can be dialled. This padding should have to be stripped by the PABX interconnect to ensure correct dialling. In addition part of the dialled string may also define a particular PABX. It is the responsibility of the PABX gateway to route the call correctly.

C.3.4.2.2.2 PABX star modifier format

PABX numbers are called by entering "*8" followed by a 3 to 20 digit extension number followed by the "#" character to indicate that dialling is complete and that the call is to be initiated.

EXAMPLE: "*8234#" should initiate a PABX call to the extension "234". Likewise dialling "*81234#" should dial PABX extension "1234".

Extension numbers can be of length 3 to 20 digits and can have any digit 0 to 9 in any position in the dialled string.

C.3.4.2.3 IP call

IP addresses are called by entering "*7" followed by an IPV4 or IPV6 dotted address followed by the "#" character to indicate that dialling is complete and that the call is to be initiated. Since the dot cannot be dialled the "*" key is a substitute for the dots.

EXAMPLE: "*7213*48*132*2#" should call IP address "213.48.132.2".

C.3.4.3 Call modifiers

Functions such as the modification of call requests to change to priority or type of service request, and the implementation of other facilities (status, diversion, etc), are initiated using the syntax in the following clauses. The call modifier is defined by the dialled string by adding extra digits to the dialled destination in the form:

<call modifier code> * destination as defined in clauses C.3.4.3.1 to C.3.4.3.7.

Table C.11: Summary of call modifiers

Dialled Digits	Call Modifier
#1*nn...#	Broadcast call, clause C.3.4.3.1
#8*nn...#	Priority call, clause C.3.4.3.2
#9*nn...#	Emergency call, clause C.3.4.3.3
#0ss*nn...#	Status call, clause C.3.4.3.4
#41*nn...#	Divert Own call, clause C.3.4.3.5
#5*nn...#	Open Channel Voice Mode call, clause C.3.4.3.6
#6*nnn..#	Force talkgroup service, clause C.3.4.3.7

C.3.4.3.1 Broadcast call

The MS should set-up a broadcast call to the destination talkgroup nn by dialling "#1*nn#".

EXAMPLE 1: "#1*112345*#" should make a broadcast talkgroup call to MS address "112345*".

NOTE: The dialled string "#1*nnn". "#" should generate an error if the address is not a talkgroup address.

EXAMPLE 2: If the MS calling party address is "1234567". "#1**#" should make a broadcast talkgroup call to "123456*" (i.e. to "1234560", "1234561", etc., "1234569").

C.3.4.3.2 Priority call

The MS should set up a high priority call to the destination address nn by dialling "#8*nn#".

EXAMPLE 1: To make a high priority call from MS 1122345 to MS 1122346 dial "#8*6#".

EXAMPLE 2: To make a high priority talkgroup call from MS 1122345 to MSs fleet 112234* dial "#8**#".

EXAMPLE 3: To make a high priority individual call to PABX extension 234 using start modifier format dial "#8**8234#".

C.3.4.3.3 Emergency call

The MS should set-up an emergency priority call to the destination address nn dialling "#9*nn#".

EXAMPLE 1: To make an emergency call from MS 1122345 to talkgroup MSs 11223*6 dial "#9**6#".

EXAMPLE 2: To make an emergency call to telephone number 456 (using telephone star modifier format) dial "#9**9456#".

EXAMPLE 3: To make an emergency call to telephone number 01772123456 (using telephone numeric padding format) dial "#9*901772123456#".

C.3.4.3.4 Status call

The string "#0ss*nnn#" causes the MS to set up a status call to the destination address nnn. The status digits "ss" are numeric in the range 0 to 99.

C.3.4.3.5 Divert own call

The string "#41*nn#" instructs a repeater BS to offer the number "nn.n" back to any caller who is attempting to make a call to the originating MS as an alternative destination for the call. The number to which calls are to be diverted, and which follows the code, should be any number which the user is able to dial between 0 and 99.

The MS should instruct the repeater BS to cancel the diverted state dialling "#41#" or "#41*#".

C.3.4.3.6 Open channel voice mode call

The string "#5*nnn.....#" causes the MS to set up a call using OVCM to the destination address nnn. The OVCM allows all MSs to be involved in the voice traffic, even if not explicitly addressed to them.

The string "#51#" or "#51*#" instructs the MS to set-up all voice calls using Open Channel Voice Mode working.

The MS should cancel the OVCM state dialling "#52#" or "#52*#".

C.3.4.3.7 Force talkgroup service

The string "#6*nnn.#" causes the MS to set up a talkgroup call to destination talkgroup nnn. where nnn. is a numeric string of length from 1 to 7 digits.

EXAMPLE: To make a talkgroup call from MS 1122345 to talkgroup MSs 1122356 dial "#6*1122356#". In this case dialling "#6*56#" would achieve the same result.

C.3.4.3.8 Multiple call modifiers

The call modifier strings "1", "5", "6", "8" and "9" may be combined as follows:

- "#81*nnn,,," should set up a high priority broadcast call;
- "#915*nnn...." should set up an emergency broadcast call in OVCM mode.

NOTE: Call modifiers 8 and 9 are mutually exclusive.

C.3.4.4 MS behaviour commands

Functions such as the changes to the MS configuration or display of MS parameters are instigated using the syntax in the following clauses.

Table C.12: Summary of MS behaviour commands

Dialled Digits	MS Behaviour Command
	Edit the talkgroup table, clause C.3.4.4.1
#42*nnnnnnn#	Add entry
#43*nnnnnnn#	Delete Entry
#43*# or #43#	Delete All
	Queue incoming call, clause C.3.4.4.2
#46*# or #46#	Queue all incoming calls
#47*# or #47#	Cancel queuing of incoming calls
#48*# or #48#	Display Own identity, clause C.3.4.4.3
#49*# or #49#	Display Own talkgroup table, clause C.3.4.4.4

C.3.4.4.1 Edit the talkgroup table

The string "#42*nnnnnnn#" causes the MS to add an entry to the talkgroup table. "nnnnnnn" should be the full 7 digit user domain address. If the talkgroup table is full an appropriate error indication is provided to the user.

The string "#43*nnnnnnn#" causes the MS to delete an entry from the talkgroup table. "nnnnnnn" should be the full 7 digit user domain address. If a match is not found between "nnnnnnn" and a talkgroup table entry an appropriate error indication is provided to the user.

The string "#43*#" or "#43#" causes the MS to delete all entries from the talkgroup table.

C.3.4.4.2 Queue Incoming call

The dialled digits "#46*#" or "#46#" causes the MS to respond to an incoming call with a message indicating that the MS does not wish to accept the call at this time. The MS should store the address of the calling party and indicate the event to the user.

The MS should cancel the Queue Incoming Calls state dialling "#47*#" or "#47#".

C.3.4.4.3 Display own identity

For an MS that is fitted with a display, the dialled digits "#48*#" or "#48#" causes the MS to display its own Identity.

C.3.4.4.4 Display Own talkgroup table

For an MS that is fitted with a display, the dialled digits "#49*#" or "#49#" causes the MS to display each entry in its talkgroup table.

C.3.4.5 Call set-up abandon or call complete

"##" may be dialled after digits and a terminator have been entered on the keyboard. If the radio unit has not transmitted a call request, it should abandon the call and resume an idle state on the control channel.

If the radio unit has started to set up a call, it should transmit a call cancel request.

If "##" is dialled whilst the unit is in the payload domain, the MS unit terminates the call.

Annex D (informative): Change requests

The present document contains change requests as described in table E.1.

Table E.1: Change request

No	Standard Version	Clauses affected or description	Title
001	1.1.1	7.1.1.1	Grp_V_Ch_Usr PDU does not match Full Link Control
002	1.2.1	1, 2, 3.1, 3.2, 4, 4.1, 4.2	Clarifications and editorial
003	1.2.1	5.1.1.1, 5.1.1.1.3, 5.1.1.2, 5.1.1.3, 5.1.2.2, 5.2.1.1, 5.2.1.2.1, 5.2.1.2.2, 5.2.1.3.3.4, 5.2.1.3.3.6 to 5.2.1.3.3.9, 5.2.2.1, 5.2.2.2.1, 5.2.2.2.2, 5.2.2.4.2.2, 5.3.2, 5.3.3, 5.3.4.1	Modifications in clause 5
004	1.2.1	6.1, 7.1, 7.1.3.2, 7.2.7	Modifications in clause 6 and 7
005	1.2.3	7.2.7 and 7.1.2.5	CSBK Blocks to Follow Information Element
006	1.2.3	7.1.3.2	CACH Activity Update modification
007	1.2.3	5.2.2.1 and 5.2.2.3.2	Impolite CSBK responses
008	1.2.3	5.1.1.1	BS Activation clarification
009	1.2.3	5.2.2.4, 5.2.2.4.1, 5.2.2.4.2.2, 7.2.1.1 – 7.2.1.5 and 7.2.2	OACSU Individual Call CSBK responses
010	1.2.3	7.1.2.1, 7.1.2.5	CSBK PDU
011	1.2.3	5.2.2.2.2, 5.2.2.4, 5.3.1.1, 5.3.1.2, 5.3.3.2 and 5.3.4	Voice Call References
012	1.2.3	5.2.1.1, 5.2.2.1 and 5.3.2.3.2	Voice Call End of Transmission clarification
013	1.2.3	A.1	CSBK Response Wait Timer
014	1.2.3	5.1.2 and 5.1.2.2	FNS Response
015	1.2.5	5.2.1.3.3.9	MS MSC Not_My_ID description correction
017	1.2.5	7.1.2.4, 7.2.6	Negative Acknowledge Response CSBK PDU content

Annex E (informative): Bibliography

ETSI TR 102 335-1: " Electromagnetic compatibility and Radio spectrum Matters (ERM); System reference document for harmonized use of Digital Mobile Radio (DMR); Part 1: Tier 1 DMR#, expected to be for general authorization with no individual rights operation".

ETSI TR 102 335-2: "Electromagnetic compatibility and Radio spectrum Matters (ERM); System reference document for harmonized use of Digital Mobile Radio (DMR); Part 2: Systems operating under individual licences in the existing land mobile service spectrum bands".

History

Document history		
V1.1.1	April 2005	Publication
V1.2.1	January 2006	Publication
V1.2.3	September 2006	Publication
V1.2.6	December 2007	Publication
V2.1.1	April 2012	Publication