



New Jersey Back Bays Coastal Storm Risk Management Interim Feasibility Study And Environmental Scoping Document:

MAIN REPORT

March 2019



US Army Corps
of Engineers®
Philadelphia District



**NEW JERSEY BACK BAYS
COASTAL STORM RISK MANAGEMENT
INTERIM FEASIBILITY STUDY AND
ENVIRONMENTAL SCOPING DOCUMENT**

MARCH 2019

NEW JERSEY BACK BAYS COASTAL STORM RISK MANAGEMENT INTERIM FEASIBILITY STUDY AND ENVIRONMENTAL SCOPING DOCUMENT

Table of Contents

1	Preface	1
2	Executive Summary.....	3
2.1	Document Overview	3
2.2	Study Area & Existing Conditions Overview	3
2.3	Focused Array of Alternative Plans Overview	4
2.4	Environmental Impacts Overview	5
2.5	Next Steps for the NJBB Study	6
3	Introduction.....	8
3.1	Study Approach, Purpose and Scope	8
3.2	Study Authorization and Policy Guidance	8
3.3	Non-Federal Sponsor and Study Milestones.....	9
3.4	Federal Interest	10
3.5	Stakeholder Coordination.....	10
3.6	Study Area.....	12
3.6.1	Coastal Lakes Region	14
3.6.2	Shark River Region	14
3.6.3	North Region	14
3.6.4	Central Region	15
3.6.5	South Region.....	15
3.7	Risk-Informed Decision Framework	15
4	Planning Considerations.....	17
4.1	Goals	17
4.2	Problems and Opportunities	17
4.2.1	Problems	17
4.2.2	Opportunities.....	19

4.3	Objectives.....	19
4.4	Constraints	20
4.5	Period of Analysis.....	21
4.6	Critical Assumptions	22
5	Existing Conditions	24
5.1	Introduction.....	24
5.2	General Setting.....	24
5.3	Existing Studies and Projects	25
5.4	Shoreline Types.....	28
5.5	Economics	30
5.6	Existing Coastal Storm Risk	32
5.6.1	Tides.....	32
5.6.2	Storm Surge	36
5.7	Historical Flooding	38
5.8	Historical Shoreline Change	39
5.9	Exposure and Vulnerability Assessment (Including Critical Infrastructure)	39
6	Affected Environment and Cultural Resources.....	53
6.1	Affected Environment	53
6.1.1	Land Use	53
6.2	Protected Lands	54
6.2.1	NJ State Coastal Zone	54
6.2.2	Coastal Barrier Resources Act Areas.....	54
6.2.3	National Wildlife Refuges	55
6.2.4	Parks and Wildlife Management Areas	55
6.2.5	State Natural Areas	56
6.2.6	National Reserves	56
6.2.7	Wild and Scenic Rivers	56
6.2.8	National Estuary Programs	56
6.3	Floodplains	57
6.4	Geology and Soils	57
6.5	Watersheds	58
6.6	Water Quality.....	59
6.6.1	Temperature and Salinity	62

6.6.2	Turbidity.....	63
6.6.3	Dissolved Oxygen	63
6.6.4	Nutrients	63
6.7	Plankton.....	64
6.8	Submerged Aquatic Vegetation.....	64
6.9	Wetland and Tidal Flats.....	65
6.10	Terrestrial Habitats	65
6.11	Wildlife	65
6.12	Fisheries Resources.....	67
6.12.1	Essential Fish Habitat.....	68
6.12.2	Shellfish.....	68
6.13	Invertebrates.....	69
6.14	Special Status Species.....	70
6.15	Coastal Lakes.....	72
6.16	Cultural Resources	72
6.17	Recreational Resources	73
6.18	Visual Resources and Aesthetics	73
6.19	Air Quality	74
6.20	Greenhouse Gases	74
6.21	Climate and Climate Change.....	74
7	Future Without Project Conditions	78
7.1	Economic and Social Without Project Conditions.....	79
7.1.1	Model Results.....	80
8	Hydrodynamic Analyses	85
8.1	Vertical Datum	85
8.2	Sea Level Change	85
8.2.1	Sea Level Change Guidance	85
8.2.2	Historical and Projected SLC	86
8.3	High Frequency Flooding	87
8.3.1	National Weather Service Flood Stages	87
8.3.2	Historical and Future High-Frequency Flooding.....	88
8.4	Storm Surge Modeling.....	90
8.4.1	NACCS.....	90

8.4.2	Modifications for NJBB	90
8.4.3	NACCS Water Levels	91
8.5	Total Water Level and Crest Elevations	94
8.5.1	Total Water Level Components	94
8.5.2	Design Crest Elevations	94
9	Plan Formulation Process	97
9.1	Plan Formulation Synopsis	97
9.2	Coastal Storm Risk Management Measure Inventory and Screening	98
9.2.1	No Action	102
9.2.2	Nonstructural Measures	102
9.2.3	Structural Measures	108
9.2.4	Natural and Nature-Based Features (NNBF)	111
9.3	Management Measure Screening Process	112
9.4	NED Hybrid Plan Screening Process	119
9.4.1	Perimeter Strategy Formulation	122
9.4.1.1	Perimeter Strategy Screening – Cycle 0	122
9.4.1.2	Perimeter Strategy Screening – Cycle 1	124
9.4.1.3	Perimeter Strategy Screening – Cycle 2	129
9.4.1.3.1	Cycle 2 Design Considerations and Assumptions	129
9.4.1.3.2	Cycle 2 Cost and Contingency Considerations and Assumptions	131
9.4.1.3.3	Cycle 2 Screening Results	132
9.4.2	Nonstructural Measures	137
9.4.2.1	Introduction	137
9.4.2.2	Methodology	137
9.4.2.3	Cost Estimates	138
9.4.2.4	Structure Identification	140
9.4.2.5	Benefits Analysis	146
9.4.3	Storm Surge Barrier Measures	147
9.4.3.1	Hydrodynamic Modeling	149
9.4.3.2	Design	154
9.4.3.3	Costs	155
9.4.3.4	Economics	159
9.4.3.4.1	Shark River Region	159

9.4.3.4.2	North Region	161
9.4.3.4.3	Central Region	165
9.4.3.4.4	South Region	169
9.5	Multi-Strategy Formulation	173
9.5.1	Alternative Screening	175
9.5.1.1	National Economic Development (NED) Criteria Screening	176
9.5.1.2	Environmental Quality (EQ) Criteria Screening.....	179
9.5.1.3	Planning Criteria Screening Analyses.....	183
9.5.2	Other Social Effects Analysis	188
10	The Preliminary Focused Array of Alternative Plans.....	194
10.1	Introduction and Overview	194
10.2	Natural and Nature Based Features in the Preliminary Focused Array.....	195
10.3	Preliminary Focused Array Description by Region	196
10.3.1	No Action.....	196
10.3.2	Coastal Lakes Region	197
10.3.3	Shark River Region	200
10.3.4	North Region	201
10.3.5	Central Region	205
10.3.6	South Region.....	213
10.4	Preliminary Focused Array Assumptions.....	216
10.5	Future Planning Analyses.....	216
10.6	Environmental Considerations of the Preliminary Focused Array	218
10.7	Environmental Mitigation	227
10.7.1	Historic and Cultural Resources.....	228
11	Environmental Laws and Compliance.....	229
11.1	National Environmental Policy Act (NEPA) of 1970, As Amended, 42 U.S.C. 4321, <i>et seq.</i>	229
11.2	Clean Air Act, As Amended, 42 U.S.C. 7401, <i>et seq.</i>	232
11.3	Clean Water Act (CWA), 33 U.S.C. 1251, <i>et seq.</i>	232
11.4	Rivers and Harbors Act, 33 U.S.C. 401, <i>et seq.</i>	232
11.5	Endangered Species Act (ESA), As Amended 16 U.S.C. 1531, <i>et seq.</i>	233
11.6	Magnuson-Stevens Fishery Conservation and Management Act (MSA), 16 U.S.C. 1801, <i>et seq.</i>	233

11.7	Federal Coastal Zone Management Act (CZMA), 16 U.S.C. 1451, et seq	233
11.8	Fish and Wildlife Coordination Act (FWCA), 16 U.S.C. 661, et seq.	234
11.9	Migratory Bird Treaty Act (MBTA), 16 U.S.C. 715-715s, and Executive Order 13186 Responsibilities of Federal Agencies to Protect Migratory Birds	234
11.10	Marine Mammal Protection Act (MMPA) of 1972, 16 U.S.C. 1631, et seq.	235
11.11	National Historic Preservation Act (NHPA) of 1966, 16 U.S.C. 6901, et seq.....	235
11.12	Coastal Barrier Improvement Act (CBIA) of 1990	235
11.13	Wild and Scenic Rivers Act of 1968 (Public Law 90-542; 16 U.S.C. 1271, et seq..	236
11.14	Marine Protection Research and Sanctuaries Act (MPRSA)	236
11.15	Resource Conservation and Recovery Act, As Amended, 42 U.S.C. 6901, et seq.	236
11.16	Comprehensive Environmental Response, Compensation and Liability Act, 42 U.S.C. 9601, et seq.....	237
11.17	Farmland Protection Policy Act of 1981 and the CEQ Memorandum Prime and Unique Farmlands	237
11.18	Executive Order 11990, Protection of Wetlands	237
11.19	Executive Order 11988, Floodplain Management.....	237
11.20	Executive Order 12898, Environmental Justice	238
11.21	Executive Order 13045, Protection of Children from Environmental and Safety Risks 238	
11.22	Executive Order 13807, Establishing Discipline and Accountability in the Environmental Review and Permitting Process for Infrastructure Projects	238
12	Agency Coordination and Public Involvement (NEPA Requirement).....	239
12.1	Agency Coordination	239
12.2	Public Involvement	240
13	Conclusions and Recommendations.....	242
13.1	Path Forward	242
13.1.1	Feasibility Phase	242
13.1.2	Plan Implementation.....	242
13.1.3	Operation, Maintenance, Repair, Replacement and Rehabilitation (OMRR&R) .	243
13.2	Interagency Alignment.....	243
13.3	Systems / Watershed Context	244
13.4	Separable and Complementary Measures	244
13.5	Sustainability/Adaptability	245
13.6	Environmental Operating Principles	245

13.7 Views of the Non-Federal Sponsor.....246
13.8 Points of Contact246
14 References.....247

List of Figures

Figure 3-1: NJBB Study Area.....	13
Figure 5-1: Constructed NJ Intracoastal Waterway, Inlet Navigation and Oceanfront CSRM Projects in the NJBB Study Area	26
Figure 5-2: NJBB State, US Department of Interior (DOI), and USACE Projects.....	27
Figure 5-3: Developed vs. Undeveloped Shoreline	29
Figure 5-4: USGS Tide Gauges (RED) and NOAA/NOS Tide Gauges (GREEN)	33
Figure 5-5: Non-storm tides for the South (a) and North (b) portions of the NJBB Study Area ..	35
Figure 5-6: Storm water levels for the South (a) and North (b) portions of the NJBB Study Area	37
Figure 5-7: NJBB Study Area, Category 4 MOM and FEMA 100yr Flood Plain	40
Figure 5-8: NJBB Study Area, Hurricane Sandy impacted area, and FEMA 100yr Flood Plain plus Sea Level Change with USACE Intermediate Curve to 2080	41
Figure 5-9: NOAA Moderate (MOD) Inundation Area for the Coastal Lakes and Shark River Study Region.....	42
Figure 5-10: NOAA Moderate Inundation Area for the North Study Area	43
Figure 5-11: NOAA Moderate Inundation Area for the Central Study Region	44
Figure 5-12: NOAA Moderate Inundation Area for the South Study Region.....	45
Figure 5-13: NJBB Study Area, Composite Exposure Index CAT 4 MOM.....	47
Figure 5-14: Impacted Critical Infrastructure in the Coastal Lakes and Shark River Study Regions within the CAT 4 MOM and FEMA 1% Probability Inundation Limits.....	49
Figure 5-15: Impacted Critical Infrastructure in the North Study Region within the CAT 4 MOM and FEMA 1% Probability Inundation Limits.....	50
Figure 5-16: Impacted Critical Infrastructure in the Central Study Region within the CAT 4 MOM and FEMA 1% Probability Inundation Limits.....	51
Figure 5-17: Impacted Critical Infrastructure in the South Study Region within the CAT 4 MOM and FEMA 1% Probability Inundation Limits.....	52
Figure 6-1: Number of AU's Fully Supporting Uses, Statewide (Source: NJDEP, 2017).....	60
Figure 7-1: FWOP Damages - Heat Map (Cape May & Atlantic Counties). Red: High damages; Green: Low damages)	82
Figure 7-2: FWOP Damages - Heat Map (Burlington, Ocean and Monmouth Counties) Red: High damages; Green: Low damages).....	83
Figure 7-3: Comparison of Structure Count, Value and Average Annual Damage by Type	84
Figure 8-1: Relative Sea Level Change Projections for Study Area	86
Figure 8-2: Floodplain associated with NWS Stages at Atlantic City, NJ	88
Figure 8-3: Historical and Future High Frequency Flooding with USACE Low SLC.....	90

Figure 8-4: NACCS 1% ACE Peak Water Levels	93
Figure 9-1: Potential Individual Management Measures for Consideration	100
Figure 9-2: Examples of Management Measures across Coastal Landscape.....	101
Figure 9-3: Seabrook Floodgate Complex	109
Figure 9-4: Management Measure Rank and Score Against the Problems and Opportunities.	115
Figure 9-5: Management Measure Rank and Score Against the Problems and Opportunities and the 4 Planning Criteria	117
Figure 9-6: Advantages vs. Disadvantages	120
Figure 9-7: NJBB Component Plan Screening Process	121
Figure 9-8: Perimeter Measure–Analysis - Cycle 0	123
Figure 9-9: Perimeter Measure North Region Analysis - Cycle 1	126
Figure 9-10: Perimeter Measure Central Region Analysis - Cycle 1.....	127
Figure 9-11: Perimeter Measure South Region Analysis - Cycle 1.....	128
Figure 9-12: Typical Section – Levee – Type A	130
Figure 9-13: Typical Section – Concrete Cantilever Wall on Piles – Type B	130
Figure 9-14: Typical Section – Concrete Cantilever Wall – Type C.....	131
Figure 9-15: Perimeter Measure North Region Analysis - Cycle 2	134
Figure 9-16: Perimeter Measure Central Region Analysis - Cycle 2.....	135
Figure 9-17: Perimeter Measure South Region Analysis - Cycle 2.....	136
Figure 9-18: Nonstructural Return Period Interval Nomenclature and Building Retrofit Volume	141
Figure 9-19: Structures Within Respective ACE Floodplains for the Coastal Lakes and Shark River Regions.....	142
Figure 9-20: Structures Within Respective ACE Floodplains for the North Region	143
Figure 9-21: Structures Within Respective ACE Floodplains for the Central Region.....	144
Figure 9-22: Structures Within Respective ACE Floodplains for the South Region.....	145
Figure 9-23: Study Area Regions.....	148
Figure 9-24: Modeling Results for Storm Surge Barrier Alternative - Base.....	151
Figure 9-25: Modeling Results for Storm Surge Barrier Alternative All Closures Less 2	152
Figure 9-26: Modeling Results for Storm Surge Barrier Alternative All Closures - Less 2 - Base	153
Figure 9-27: Impact of Storm Surge Barrier on Ocean-Facing Beaches	154
Figure 9-28: Shark River Region Storm Surge Barrier Alternatives (Note: Approximate, preliminary locations)	160

Figure 9-29: North Region Storm Surge Barrier Alternatives (Note: Approximate, preliminary locations).....	162
Figure 9-30: North Region Storm Surge Barrier Alternatives (Note: Approximate, preliminary locations).....	163
Figure 9-31: North Region Storm Surge Barrier Alternatives (Note: Approximate, preliminary locations).....	164
Figure 9-32: Central Region Storm Surge Barrier Alternatives (Note: Approximate, preliminary locations).....	166
Figure 9-33: Central Region Storm Surge Barrier Alternatives (Note: Approximate, preliminary locations).....	167
Figure 9-34: Central Region Storm Surge Barrier Alternatives (Note: Approximate, preliminary locations).....	168
Figure 9-35: South Region Storm Surge Barrier Alternatives (Note: Approximate, preliminary locations).....	170
Figure 9-36: South Region Storm Surge Barrier Alternatives (Note: Approximate, preliminary locations).....	171
Figure 9-37: South Region Storm Surge Barrier Alternatives (Note: Approximate, preliminary locations).....	172
Figure 10-1: Coastal Lakes within the NJBB Study Area.....	198
Figure 10-2: Shark River Region Alternative 2A Management Measure Features (Note: Approximate, preliminary locations).....	200
Figure 10-3: North Region Alternative 3A Management Measure Features (Note: Approximate, preliminary locations).....	201
Figure 10-4: North Region Alternative 3D Management Measure Features (Note: Approximate, preliminary locations).....	202
Figure 10-5: North Region Alternative 3E(2) Management Measure Features (Note: Approximate, preliminary locations).....	203
Figure 10-6: North Region Alternative 3E(3) Management Measure Features (Note: Approximate, preliminary locations).....	204
Figure 10-7: Central Region Alternative 4A Management Measure Features (Note: Approximate, preliminary locations).....	205
Figure 10-8: Central Region Alternative 4D(1) Management Measure Features (Note: Approximate, preliminary locations).....	206
Figure 10-9: Central Region Alternative 4D(2) Management Measure Features (Note: Approximate, preliminary locations).....	207
Figure 10-10: Central Region Alternative 4E(2) Management Measure Features (Note: Approximate, preliminary locations).....	208
Figure 10-11: Central Region Alternative 4E(3) Management Measure Features (Note: Approximate, preliminary locations).....	209

Figure 10-12: Central Region Alternative 4E(4) Management Measure Features (Note: Approximate, preliminary locations).....210

Figure 10-13: Central Region Alternatives 4G(6) through 4G(8) Management Measure Features (Note: Approximate, preliminary locations)211

Figure 10-14: Central Region Alternatives 4G(9) through 4G(12) Management Measure Features (Note: Approximate, preliminary locations)212

Figure 10-15: South Region Alternative 5A Management Measure Features (Note: Approximate, preliminary locations)213

Figure 10-16: South Region Alternative 5D(1) Management Measure Features (Note: Approximate, preliminary locations).....214

Figure 10-17: South Region Alternative 5D(2) Management Measure Features (Note: Approximate, preliminary locations).....215

Figure 10-18: Preliminary Conceptual Model of NJBB Structural, Nonstructural and NNBF Measures226

Figure 11-1: Agency Coordination230

Figure 11-2: NJBB NEPA Compliance Plan231

List of Tables

Table 3-1: NJBB Study Milestones	9
Table 3-2: Public and Agency Coordination.....	10
Table 4-1: Critical Assumptions	23
Table 5-1: NJDEP 2012 Shoreline Mapping	28
Table 5-2: Structure Inventory Totals within Project Area.....	30
Table 5-3: Structure Inventory Summary Information	31
Table 5-4: Historic Damages (Hurricane Sandy) by County	32
Table 5-5: Top 10 Historical Storms at Cape May, Atlantic City, and Sandy Hook NOAA Tidal Stations	38
Table 5-6: Population, Housing Units, and Infrastructure included within CAT 4 MOM.....	48
Table 6-1: CBRs Units and OPAs in NJBB Study Area	55
Table 6-2: Use Assessment Results for Atlantic Coastal Region (ACR), Number and Percentage of Assessment Units (AUs)	61
Table 6-3: <i>Number of Assessment Units (AUs) Listed within Each Watershed Management</i>	62
Table 6-4: Special Status Species in NJBB Coastal Areas	71
Table 6-5: New Jersey Back Bay Areas Monthly Temperature Range Normals (Deg. F)	75
Table 6-6: New Jersey Monthly Precipitation Normals (Inches)	76
Table 7-1: Without Project Average Annual Damages by Municipality (2030-2080)	80
Table 8-1: Relative Sea Level Change Projections for Study Area	86
Table 8-2: High-Frequency Flood Occurrences (Per Year)	89
Table 8-3: Water Level ACE in Study Area.....	92
Table 8-4: Total Water Level Components	95
Table 9-1: Management Measure Cycle 1 Screening Results.....	114
Table 9-2: Management Measure Cycle 2 Screening Results.....	116
Table 9-3: Adaption Categories with Screened and Ranked Measures	118
Table 9-4: Perimeter Measure–Analysis - Cycle 1 Results.....	125
Table 9-5: Perimeter Measure Analysis – Cycle 2 Results	133
Table 9-6: Sea Level Rise Curve Table	138
Table 9-7: Building Retrofit Costs – Single Family Residential One Story.....	139
Table 9-8: Building Retrofit Costs – Single Family Residential Multi Story	139
Table 9-9; Nonstructural Measure Evaluation – 5% ACE Event Floodplain	146
Table 9-10: Storm Surge Barrier Cost Estimates (\$1000s).....	157

Table 9-11: Interior Bay Closure Cost Estimates (\$1000s).....	158
Table 9-12: North Region Storm Surge Barrier Alternatives.....	161
Table 9-13: Central Region Storm Surge Barrier Alternatives.....	165
Table 9-14: South Region Storm Surge Barrier Alternatives.....	169
Table 9-15: Comprehensive List of 51 Regional Alternatives.....	173
Table 9-16: Alternative Screening Criteria Matrix.....	175
Table 9-17: Economic Analysis Results for 51 Regional Alternatives – Study Wide (Baseline)	176
Table 9-18: Shark River and Coastal Lakes Region - NED Screening.....	177
Table 9-19: North Region - NED Screening.....	177
Table 9-20: Central Region - NED Screening.....	178
Table 9-21: South Region - NED Screening.....	179
Table 9-22: EQ Index Score.....	180
Table 9-23: EQ Screening for Individual Regions.....	181
Table 9-24: Four Planning Criteria Screening.....	9-184
Table 9-25: Alternative Qualitative Assessment.....	189
Table 10-1: Preliminary Focused Array of Alternative Plans.....	194
Table 10-2: Preliminary Environmental Considerations of the Preliminary Focused Array of Alternatives.....	220

New Jersey Back Bays Coastal Storm Risk Management Interim Feasibility Study and Environmental Scoping Document

1 Preface

This Interim Feasibility Study and Environmental Scoping Document presents preliminary findings of a study to identify comprehensive coastal storm risk management (CSRМ) strategies to increase resilience and to reduce risk from future storms and compounding impacts of sea level change (SLC) for the New Jersey Back Bays (NJBB) region. The objective of the NJBB CSRМ Study is to investigate CSRМ problems and solutions to reduce damages from coastal flooding that affect population, critical infrastructure, critical facilities, property, and ecosystems.

This feasibility study has been conducted in accordance with Engineering Regulation (ER) 1105-2-100, Planning Guidance Notebook, and will ultimately facilitate the development of a decision document providing the “consolidated documentation of technical and policy analyses, findings, and conclusions upon which the U.S. Army Corps of Engineers Philadelphia District Commander bases the recommendation to the Major Subordinate Command Commander to approve the recommended project for implementation;” however, the document described herein is not a complete “decision document.” This Document describes the engineering, economic, social and environmental analyses conducted to date towards developing a Draft Feasibility Report and Environmental Impact Statement and associated tentatively selected plan (TSP) in 2020, and a Final Feasibility Report and Environmental Impact Statement and associated recommended plan in 2021.

Per ER 1105-2-100, the feasibility study process to date is aligned with National Environmental Policy Act (NEPA). Specifically, a public notice was issued on October 31, 2016 announcing the initiation of scoping, and to invite the public, resource agencies and stakeholders to participate in the process. A scoping/public meeting was held on December 1, 2016. In addition, agency and stakeholder engagement was initiated via scoping letters at that time. A Notice of Intent to prepare an Environmental Impact Statement was published in the Federal Register on December 27, 2017 and subsequently will be rescinded in order to align the review with Cooperating Agencies in accordance with Executive Order 13807.

While this Interim Feasibility Study and Environmental Scoping Document is not an official part of the codified requirements of NEPA and ER 1105-2-100, USACE is soliciting public comments and questions on this report for 30 calendar days in order to promote continued collaboration and transparency. In addition, two public scoping meetings were held in December 2016, and two additional public scoping meetings were held in September 2018 to provide a status of the study and to solicit public comments and questions.

Interested parties can access further information at the USACE’s NJBB web Portal which is situated at <https://www.nap.usace.army.mil/Missions/Civil-Works/New-Jersey-Back-Bays-Coastal-Storm-Risk-Management/>

Questions and comments regarding the NJBB Study can be emailed to PDPA-NAP@usace.army.mil (reference “NJBB” in the subject heading of the email).

NOTE TO READER: As discussed further in Section 4.6 of this report, the findings to date have built-in assumptions that will be further evaluated and/or validated as the study progresses. While the critical assumptions were socialized with interested groups and decision makers through public meetings and events and with a risk register, there is inherent risk and potential uncertainty associated with these assumptions that will be continually analyzed and reduced as the study progresses.

2 Executive Summary

2.1 Document Overview

This U.S. Army Corps of Engineers (USACE) New Jersey Back Bays (NJBB) Coastal Storm Risk Management (CSRM) Interim Feasibility Study and Environmental Scoping Document presents a preliminary focused array of alternative plans that reduces risk to human life and flooding risk from coastal storms in the NJBB Region. These findings and associated analyses are consistent with study planning objectives in addition to minimizing environmental, social and economic impacts. The reduction of flood-related damages to residential structures, commercial structures, critical infrastructure, and industries is critical to the national and regional economy.

The long term strategy for resilience in the NJBB region is a scalable solution that integrates CSRM efforts included in this NJBB CSRM Study Document as well as CSRM efforts considered by the New Jersey Department of Environmental Protection (the NJBB Study non-Federal Sponsor), other Federal agencies, NGOs and municipal entities.

This Interim Feasibility Study and Environmental Scoping Document has been prepared in accordance with relevant laws and USACE guidance. This document does not inform Federal or USACE policy and is not considered a formal decision document, and is not a National Environmental Policy Act of 1970 (NEPA) compliant document.

The USACE will continue to coordinate with the NJDEP to implement the recommended project in accordance with current policy.

2.2 Study Area & Existing Conditions Overview

The study area has been subdivided into five regions based on problems and opportunities, geomorphology and hydraulic interconnectedness of water bodies. The preliminary focused array of alternative plans is presented by individual region in Chapter 10 of the Main Report. These alternative plans are compared to the No Action alternative (Future Without Project Condition) which includes no additional measures above the existing condition plus CSRM actions either constructed or currently under construction to manage coastal storm risk. This preliminary focused array of alternative plans and continued study analyses are necessary to determine the plan that reasonably maximizes National Economic Development (NED) benefits while not sacrificing environmental, regional, or social concerns, which will ultimately result in the selection of a recommended plan in subsequent phases of the feasibility study.

The study area includes the bays and river mouths located landward of the barrier islands and Atlantic Ocean-facing coastal areas in the State of New Jersey. The Atlantic Ocean Coast of New Jersey is fronted by an effective Federal CSRM program. However, the NJBB region currently lacks a comprehensive CSRM program. As a result, the NJBB region experienced major impacts and devastation during Hurricane Sandy and subsequent coastal storm events thus damaging property and disrupting millions of lives due to the combination of low-lying topography, sea level change, densely populated residential and commercial areas, extensive low-lying infrastructure, and degraded coastal ecosystems.

Further vulnerability to coastal storms and the potential for future, more devastating events due to changing sea level and climate change is significant. Rising sea levels represent an inexorable process causing numerous, significant water resource problems such as: increased widespread

flooding along the coast; changes in salinity gradients in estuarine areas that impact ecosystems; increased inundation at high tide; decreased capacity for storm water drainage; and declining reliability of critical infrastructure services such as transportation, power, and communications. Addressing these problems requires a paradigm shift in how we work, live, travel, and play in a sustainable manner as a large extent of the area is at a very high risk of coastal storm damage as sea levels continue to rise.

2.3 Focused Array of Alternative Plans Overview

The preliminary focused array of alternative plans was developed through a detailed hydrodynamic modeling and multi-criteria based iterative screening analysis process. Through this process, CSRM measures were combined into complete and implementable multi-measure alternative plans. Measures that would not contribute to the study's CSRM objectives were screened out. The remaining four major measure types identified for this Document include: storm surge barrier (inlet closures) and interior bay closures; perimeter (levees and floodwalls); nonstructural (residential building retrofits); and Natural and Nature Based Feature (NNBF) measures.

Preliminary results of the modeling and screening analyses indicate that storm surge barriers are viable options at Manasquan Inlet, Barnegat Inlet, Absecon Inlet, and/or Great Egg Harbor Inlet. Storm surge barriers were evaluated at the Little Egg/Brigantine Inlet complex, and at Hereford Inlet as well as at other inlets but many of these storm surge barriers have limited benefits as compared to costs and may present environmental impact obstacles. Interior bay closures inclusive of navigable gates at the Intracoastal Waterway are viable both north of Absecon Island and south of Ocean City.

Preliminary results indicate that floodwalls and levees are potentially viable at several locations including Cape May City, West Cape May, Wildwood Island, West Wildwood Island, Stone Harbor/Avalon, Sea Isle City, Ocean City, Absecon Island, Brigantine Island, Long Beach Island and the area just north of Manasquan Inlet.

Conceptual design of floodwalls, levees, and interior bay closures are based on a crest elevation of 13 ft. NAVD88. Conceptual design of storm surge barriers at inlets are based on a crest elevation of 20 ft. NAVD88. Additional refinement will be included in design crest elevations in subsequent phases of the feasibility study.

Nonstructural elements include only building retrofits (structure elevation) to residential structures at this point of the study due to availability of existing data such as structure inventory and cost information. Future analysis will address flood proofing and ring levees for commercial, public, and industrial structures, as well as managed coastal retreat including acquisition/relocation. Building acquisition and relocation could provide significant environmental benefit by increasing open space by converting existing privately owned and buildable properties into natural habitat. Future recommendations will also be made regarding land use management and early flood warning elements.

The primary focus of the NJBB study is managing risk associated with storm surge events rather than flooding associated with inadequate storm sewer systems and/or high frequency (i.e. nuisance) flooding. USACE policy (ER 1165-2-21) states that storm water systems are a non-Federal responsibility. While inundation from high frequency flooding events and inadequate

storm water systems is not the focus of the NJBB study, it is acknowledged that nonstructural and storm surge barrier measures may not provide flood risk management from high frequency flooding events. Therefore, complementary measures to address these problems will likely be investigated as part of the NJBB Study, and may be recommended as part of a comprehensive Federal project that could be implemented at the non-Federal level.

Natural and Nature Based Features (NNBFs) assist in the incorporation of natural approaches to develop regional climate change and sea level rise adaptation planning strategies and solutions in the NJBB study area. NNBFs help to meet the project objectives and provide coastal storm risk management attributes through the consideration of stand-alone measures including living shorelines, reefs, wetland restoration and submerged aquatic vegetation.

At this point in the NJBB Study, the preliminary focused array of alternative plans does not consider specific locations for NNBF implementation. Continuing evaluation for potential NNBF implementation includes locations in the study area with undeveloped shorelines showing shoreline erosion adjacent to infrastructure as well as adjacent to storm surge barriers or floodwalls/levees to pre-emptively address erosion near these structures. Specific modifications to structural measures include habitat benches to restore more natural slopes along shorelines and textured concrete to support colonization of algae and invertebrates. Additional analysis regarding NNBF implementation and consideration of the ancillary benefit of NNBFs to meet mitigation requirements will be performed in subsequent phases of the feasibility study as the recommended plan is developed.

2.4 Environmental Impacts Overview

Only general impacts and/or a range of impacts have been identified at this stage of the feasibility study and associated NEPA analysis. There is difficulty in accurately quantifying direct impacts to essential fish habitat, federally-listed threatened and endangered species, marine mammals, recreation, wetlands, cultural resources, navigation and visual resources based on analyses performed to date. Furthermore, quantification of indirect impacts is limited at this phase of the feasibility study owing to ongoing detailed environmental analyses including hydrodynamic and water quality modeling to determine the effects on flushing, salinity, dissolved oxygen and nutrients, and conceptual environmental impact decision modeling to guide the impact analyses for ultimate integration into the future phases of the study and the recommended plan.

Findings to date suggest that structural measures in the preliminary focused array of alternative plans may have some direct impacts such as habitat loss at wetlands and submerged aquatic vegetation, and aesthetics/views impairment. Floodwalls and levees are expected to have significant direct impacts particularly on wetlands and shallow aquatic habitats within the footprint of floodwalls and levees over long linear distances, which would have regional effects. Inlet storm surge barriers and interior bay closures would have moderate to significant direct impacts on aquatic habitats, but comparatively less than that of floodwalls and levees.

Storm surge barriers and interior bay closures may pose significant indirect impacts on hydrodynamics such as tidal flow, and tidal range, water quality, and shifts in flora and fauna abundance, distributions and migrations. These potential effects have a high level of uncertainty particularly with the unknown frequency of gate closures coupled with changes in tidal flooding events related to sea level rise. This would require further modeling efforts to inform the impact assessment associated with these measures.

There will likely be both temporary and permanent visual adverse effects associated with the construction of structural measures in the recommended plan. Construction equipment will be visible at locations included in the recommended plan during the construction phase. The storm surge barriers, interior bay closures, floodwalls and levees will be permanent and visible both on land and from the water.

Nonstructural structure elevation may have some temporary adverse direct and indirect effects related to earth disturbance. Building acquisition and relocation could provide significant environmental benefit by increasing open space by converting existing privately owned and buildable properties into natural habitat although there is a potential for significant adverse impacts to cultural resources.

NNBFs are expected to have temporary and minor impacts on aquatic resources and water quality during their construction, but would have a long-term beneficial effect on aquatic and some terrestrial habitats and the flora and fauna that inhabit these areas.

Cultural resource impacts may include impacts to historic districts and properties that are eligible in the National Register of Historic Properties as well as to sunken historical vessel sites. Further study is needed, and these potential impacts will likely be addressed through a Programmatic Agreement with the New Jersey State Historic Preservation Office.

The preliminary focused array of alternative plans identified in this Document will undergo a rigorous evaluation of compliance with environmental protection statutes and Executive Orders at subsequent phases of the feasibility study. A detailed examination of impact avoidance and minimization to better quantify both direct and indirect environmental impacts will also be performed in the future. Based on the scale of the preliminary focused array of alternative plans, it is possible that substantial compensatory mitigation will be required.

Environmental concerns will be evaluated in the EIS during subsequent phases of the feasibility study and through coordination and review by the resource agencies including the U.S. Environmental Protection Agency, the U.S. Fish and Wildlife Service, the U.S. Department of Commerce National Oceanic and Atmospheric Administration National Marine Fisheries Service and other agencies as part of the feasibility process.

2.5 Next Steps for the NJBB Study

Following this Interim Feasibility Study and Environmental Scoping Document, the continued feasibility phase of the study will develop: a Draft Integrated Feasibility Report and Environmental Impact Statement (EIS) with tentatively selected plan (TSP) in 2020; a Final Feasibility Report and EIS with recommended plan in 2021; and a Chief's Report in 2022 which concludes the feasibility phase of the Study. The completion of the Chief's Report is the first step toward implementing the design and construction of the NJBB Study. Following this feasibility phase, the pre-construction engineering and design (PED) phase of the project initiates the implementation process of the recommended plan including the development of plans and specifications. Funding by the Federal Government to support these activities would have to meet traditional civil works budgeting criteria. In order for the PED phase to be initiated, USACE must sign a Project Partnership Agreement (PPA) with the non-Federal sponsor to cost share the PED and construction phases. This project would require congressional authorization for both the PED and construction phases. PED and construction phases are cost shared 75%/25% and 65%/35%

Federal/non-Federal, respectively. Implementation would then occur provided that sufficient funds are appropriated to design and construct the project. Sequencing of project construction is dependent upon final study findings, congressional project authorization and appropriation of funds. The non-Federal cost share as discussed above would also be necessary to commence project design and construction.

The construction of scaled, incrementally implementable integrated USACE construction opportunities associated with the NJBB recommended plan to manage flooding risk in the region may be massive in scale and cost several billion dollars. A strategy for implementation and sequencing of the recommended plan will need to be prepared amongst team partners in order to identify and make available construction funds and to communicate the construction priority to stakeholders. It is anticipated that Federal/non-Federal sponsor project partnership agreements could be executed for individual construction opportunities rather than for one large project addressing the entire current study area. Project construction would start no earlier than 2030 and is dependent upon Federal congressional authorization and Federal and non-Federal partner appropriations.

Analyses have been conducted to address the specific requirements necessary to demonstrate that the preliminary focused array of alternative plans will form a recommended plan in a subsequent phase of the feasibility study that is technically feasible, economically justified, and environmentally compliant. Additional analyses will ultimately develop costs and cost-sharing to support a Project Partnership Agreement (PPA) between the non-Federal sponsor and the Federal government.

This document has considered and incorporated comments from the public, stakeholders, agencies, and NGOs through a series of workshops and meetings since the study commencement in 2016. Throughout the study, coordination was maintained with the State of New Jersey as well as counties and municipalities throughout the study area as well as academic institutions, environmental/resource agencies, and other key stakeholders. Continued NJBB analyses will incorporate Federal, State, local, NGOs and academic datasets and tools as applicable and will consider ways to coordinate with and leverage other Federal and state resilience projects. The development of relationships with cooperating agencies was and will continue to be critical in conducting future analyses.

3 Introduction

3.1 Study Approach, Purpose and Scope

The purpose of the U.S. Army Corps of Engineers (USACE) New Jersey Back Bays (NJBB) Coastal Storm Risk Management (CSRМ) Feasibility Study is to implement comprehensive CSRМ strategies to increase resilience and to reduce risk from future storms and compounding impacts of sea level change (SLC). The objective of the NJBB CSRМ Study is to investigate CSRМ problems and solutions to reduce damages from coastal flooding that affects population, critical infrastructure, critical facilities, property, and ecosystems.

The Atlantic Coast of New Jersey is fronted by an effective Federal CSRМ program (USACE, 2013). However, the NJBB region currently lacks a comprehensive CSRМ program. As a result, the NJBB region experienced major impacts and devastation during Hurricane Sandy and subsequent coastal events thus damaging property and disrupting millions of lives owing to the low elevation areas and highly developed residential and commercial infrastructure along the coastline.

The NJBB is one of nine focus areas identified in the North Atlantic Coast Comprehensive Study (NACCS), whose goals are to:

- a. Provide a risk management framework, consistent with NOAA/USACE Infrastructure Systems Rebuilding Principles; and
- b. Support resilient coastal communities and robust, sustainable coastal landscape systems, considering future sea level and climate change scenarios, to reduce risk to vulnerable populations, property, ecosystems, and infrastructure.

While the NACCS provides a regional scale analysis, the NJBB CSRМ Study will employ NACCS outcomes and apply the NACCS CSRМ Framework to formulate a more refined and detailed watershed scale analysis to include potential municipal or community level implementation opportunities, strategies and measures to assist in enabling communities to understand and manage their short-term and long-term coastal risk in a systems context.

3.2 Study Authorization and Policy Guidance

As a result of Hurricane Sandy in October 2012, Congress passed Public Law (P.L.) 113-2, Disaster Relief Appropriations Act, 2013 which authorized supplemental appropriations to Federal agencies for expenses related to the consequences of Hurricane Sandy. Chapter 4 of P.L. 113-2 identifies those actions directed by Congress specific to the USACE, including preparation of two interim reports to Congress, a project performance evaluation report, and a comprehensive study to address the flood risks of vulnerable coastal populations in areas affected by Hurricane Sandy within the boundaries of the North Atlantic Division of the U.S. Army Corps of Engineers (NAD).

The NACCS identified nine focus areas in the NACCS Study Area to more comprehensively identify problems, needs and opportunities including the development of CSRМ strategies to manage risk associated with coastal flooding and sea level rise in areas of need. The Back Bays of the State of New Jersey is one of these focus areas.

The New Jersey State Chapter within the State and District of Columbia Analyses Appendix of the NACCS discussed State-specific conditions, presented a risk analyses, developed focus areas and CSRSM strategies within New Jersey. The NJBB CSRSM Study aligns with the NACCS goals and purpose towards the conduct of a systems analysis/plan to better understand and manage coastal risk.

The study authority for the NJBB CSRSM Study was the New Jersey Shore Protection Authority (1987). The resolution reads as follows:

Resolutions adopted by the Committee on Public Works and Transportation of the U.S. House of Representatives and the Committee on Environment and Public Works of the U.S. Senate in December 1987, and by House resolution adopted by the Committee on Public Works and Transportation on December 10, 1987 offers specific authority for the conduct of study along the coast of New Jersey:

"that the Board of Engineers for Rivers and Harbors, created under Section 3 of the Rivers and Harbors Act, approved June 13, 1902, be, and is hereby requested to review existing reports of the Chief of Engineers for the entire coast of New Jersey with a view to study, in cooperation with the State of New Jersey, its political subdivisions and agencies and instrumentalities thereof, the changing coastal processes along the coast of New Jersey. Included in this study will be the development of a physical, environmental, and engineering database on coastal area changes and processes, including appropriate monitoring, as the basis for actions and programs to prevent the harmful effects of shoreline erosion and storm damage; and, in cooperation with the Environmental Protection Agency and other Federal agencies as appropriate, develop recommendations for actions and solutions needed to preclude further water quality degradation and coastal pollution from existing and anticipated uses of coastal waters affecting the New Jersey Coast. Site specific studies for beach erosion control, hurricane protection, and related purposes should be undertaken in areas identified as having potential for a Federal project, action, or response".

3.3 Non-Federal Sponsor and Study Milestones

The non-Federal sponsor for the study is the New Jersey Department of Environmental Protection (NJDEP). The Feasibility Cost Sharing Agreement (FCSA) of 2016 established that this study would be performed at a 50/50 cost-share. The total study costs are currently \$18,050,000.

Milestones to completion of the NJBB Study is provided in **Table 3-1**.

Table 3-1: NJBB Study Milestones

Milestone	Date
FCSA	11- April - 16
Alternative Milestone Meeting	14 - December - 16
FCSA Amended	18 - January - 18

<i>In Progress Review (IPR) Milestone</i>	<i>10- December - 18</i>
Interim Feasibility Report and Environmental Scoping Document	February - 19
Tentatively Selected Plan Milestone	January - 20
Draft Report Release	March - 20
Agency Decision Milestone	July - 20
Final Feasibility Report	November - 21
State and Agency Review	February - 22
Chief of Engineers Report	April - 22

* Items in italics have occurred.

3.4 Federal Interest

The New Jersey Back Bays region is extremely vulnerable to coastal storm events. Coastal storm risk management is an identified primary mission area of USACE. This feasibility study identifies a variety of solutions that have the potential to be economically justified, environmentally acceptable, addressable through engineering solutions, and consistent with USACE principles.

3.5 Stakeholder Coordination

Coordination with stakeholders is a critical component of the New Jersey Back Bays CSRM Study and the development of a regional vision for managing coastal storm risk. **Table 3-2** documents the meetings, workshops, and charrettes that have taken place since the commencement of the study in April of 2016. Stakeholders include but are not limited to citizens, elected municipal officials, federal agencies, state agencies, Non-Governmental Organizations (NGOs), local and regional planning commissions, and commercial and recreational interests.

Table 3-2: Public and Agency Coordination

Session	Date	Description	Stakeholders
Southern Counties Planning Workshop	06/17/2016	Obtain feedback about Problems, Objectives, and Potential Measures within the NJBB CSRM Study Area	Academia, Elected Officials, NGOs, Municipalities, Counties, State and Federal Agencies
Northern Counties Planning Workshop	06/21/2016		
Public Meeting	12/01/2016	First Public Meeting about the NJBB CSRM Feasibility Study	

NEPA Public Scoping	02/01/2017	Determining the scope of issues to be addressed by the study	Citizens, Interested Agencies
USACE/NJDEP Partnering Meeting	03/06/2018	NJBB Study overview with several NJDEP Divisions	USACE and NJDEP
USACE & NJDEP Outreach Meeting	05/18/2018	Cape May County Municipal Outreach	Academia, Elected Officials, NGOs, Municipalities, Counties, State and Federal Agencies
USACE & NJDEP Outreach Meeting	05/24/2018	Atlantic County Municipal Outreach	
USACE & NJDEP Outreach Meeting	05/31/2018	Monmouth County Municipal Outreach	
Interagency Regulatory Resource Meeting (#1)	06/06/2018	NJBB Status Update and Perimeter Plan Focus	State and Federal Agencies
USACE & NJDEP Outreach Meeting	06/19/2018	Ocean County Municipal Outreach	Academia, Elected Officials, NGOs, Municipalities, Counties, State and Federal Agencies
Southern Counties Public Meeting	09/12/2018	Update citizens about Problems, Objectives, and Potential Measures within the NJBB CSRSM Study Area	Academia, Elected Officials, NGOs, Municipalities, Counties, State, Federal Agencies and Media
Northern Counties Public Meeting	09/13/2018		
USACE Outreach Meeting	11/13/2018	Barnegat Bay Estuary Program	Academia, NGOs, State and Federal Agencies
Interagency Regulatory Resource Meeting (#2)	11/29/2018	NJBB Status Update and Perimeter Plan Focus	State and Federal Agencies

Detailed discussion of outreach activities of the NJBB CSRM Study can be found in the Correspondence and Communication Appendix E.

3.6 Study Area

The geographic limits of the study area include the footprint of the National Hurricane Center (NHC) Category 4 Maximum of Maximum (MOM)¹. This inundation boundary represents the storm surge floodplain associated with the maximum storm tide levels caused by extreme hurricane scenarios across the region, and, therefore, provides a reasonable approximation of the most extreme flooding extent (**Figure 3-1**). A detailed map with municipalities in the study area can be found in the Plan Formulation Appendix A.

The study area includes the bays and river mouths located landward of the barrier islands and Atlantic Ocean-facing coastal areas in the State of New Jersey. The study area covers more than 950 square miles, and 3,500 linear miles of shoreline from Long Branch at the northern study area boundary to Cape May Point at the southern boundary. It comprises portions of ninety municipalities and five counties including Monmouth, Ocean, Atlantic, Burlington and Cape May Counties. The New York-New Jersey Harbor and Tributaries Study (NYNJHATS) Focus Area addresses coastal risk and vulnerability for coastal areas in the State of New Jersey that lie to the north of the NJBB study area.

For the purposes of this study, the study area has been subdivided into five regions based on planning considerations (problems and opportunities), geomorphology and hydraulic interconnectedness of water bodies. These regions were used to develop and identify potential alternative plans for the study area. The following paragraphs offer a characterization of the current conditions and physical setting of each of the five regions.

¹ The inundation zones identified by the Sea, Lake, and Overland Surges from Hurricanes (SLOSH) model (www.nhc.noaa.gov/surge/slosh.php) depict areas of possible flooding from the maximum of maximum (MOM) event within the five categories of hurricanes by estimating the potential surge inundation during a high-tide landfall. Although the SLOSH inundation mapping is not referenced to a specific probability of occurrence (unlike FEMA flood mapping, which presents the 0.2-percent- and 1-percent-annual-chance flood elevation zones) nor does it include wave heights, the flooding inundation from a Category 4 hurricane making landfall during high tide represents an extremely low probability of occurrence but high-magnitude event.

The use of the SLOSH model MOM was necessary based on the very large spatial extent of the study area and the fact that it is currently the most advanced storm surge modeling available for the entire study area.

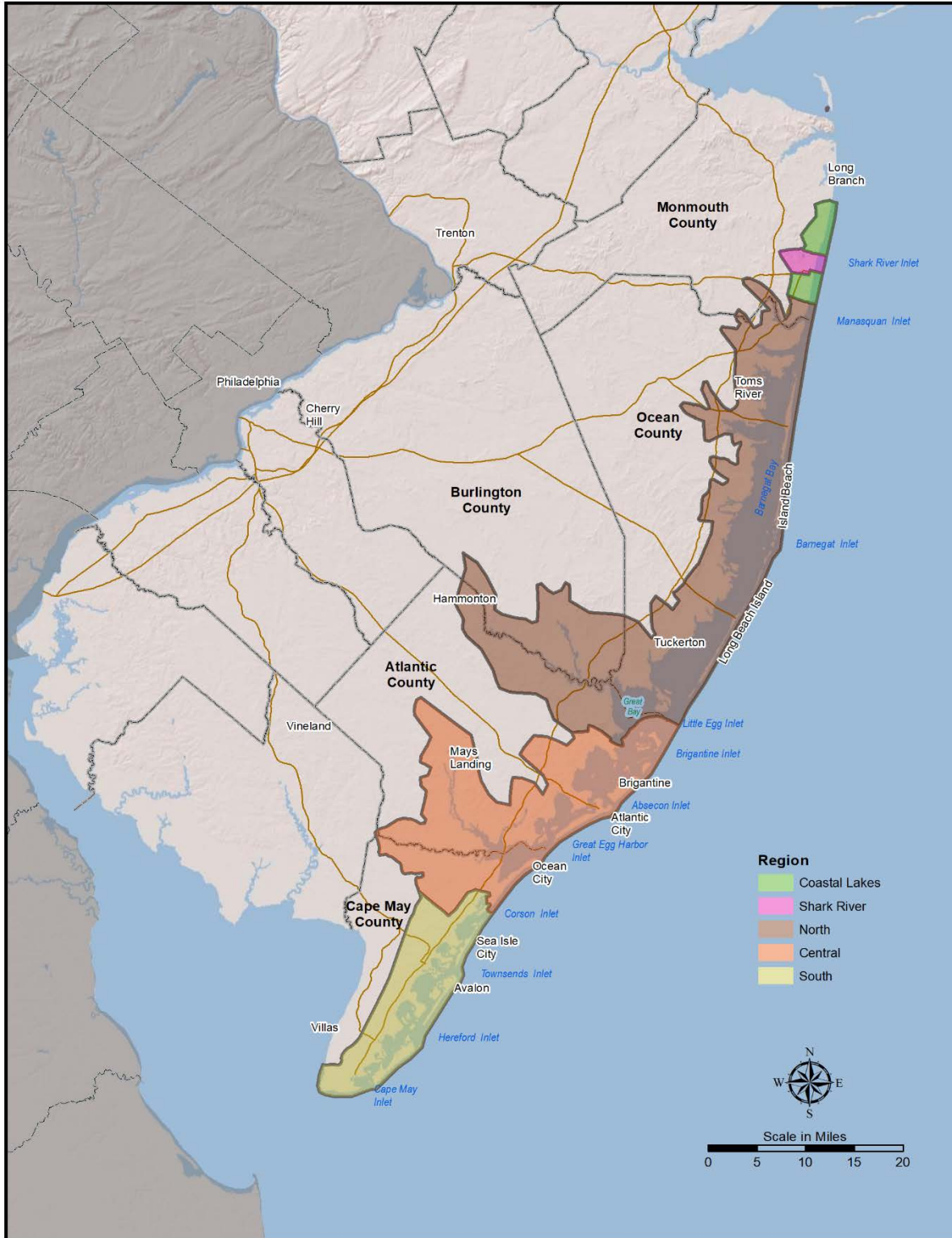

Figure 3-1: NJBB Study Area

3.6.1 Coastal Lakes Region

This region includes two discontinuous segments separated by the Shark River Region, which is discussed in the following paragraph. The Coastal Lakes region is almost entirely urbanized and includes all or portions of fifteen municipalities. In the Coastal Lakes region, four coastal lakes are in Ocean County and ten coastal lakes are in Monmouth County (an additional two coastal lakes in Monmouth County are in the Shark River Region discussed below). None of the lakes is presently connected to the Atlantic Ocean via a tidal inlet; however, 19th Century mapping shows that the lakes at the time were in fact small tidal estuaries, with each inlet subsequently closed by natural or human actions. Most of the lakes have some form of water level management that allows high lake levels to be reduced by discharge to the ocean. For example, Lake Takanassee drains to the Atlantic Ocean under “normal” tidal conditions through a buried culvert that is controlled by a tide gate. Because there are no tidal inlets connected to these lakes, they are subject to a different type of flood risk and will consequently require an alternate method of analysis. Potential flood pathways for these lakes include fluvial (precipitation) flooding, ocean wave and storm surge overtopping of the barrier beach, and ocean storm surge flooding that “backs up” from the ocean into the lake through the underground drainage conduits.

3.6.2 Shark River Region

The Shark River Region includes the Shark River estuary and all or portions of seven highly urbanized municipalities in Monmouth County. Sylvan and Silver Lakes are coastal lakes that are included in the Shark River Region. This region experienced some of the highest storm surge elevations within the study area during Hurricane Sandy. The storm flooding problem is principally related to the ability of elevated ocean water levels to pass through Shark River Inlet and inundate the adjoining land areas. Under ordinary tidal conditions, this is an isolated hydraulic reach; there is no tidal connection between the Shark River estuary and the Manasquan Inlet estuary to the south.

3.6.3 North Region

The north region of the Study Area extends from Manasquan Inlet and the Manasquan River Estuary south to Little Egg Harbor Inlet and the Mullica River/Great Bay estuary. This is the largest region established for the New Jersey Back Bays analyses. It covers 536 square miles and includes all or portions of 45 municipalities in Ocean, Burlington, and Atlantic Counties.

The boundaries of the North Region were chosen to reflect the relatively lower 1 percent annual chance exceedance (ACE) flood elevations within this zone compared to areas north and south of it. The lower flood elevations are due to the fact that there are only three inlets – Manasquan, Barnegat, and Little Egg – along a 45-mile long segment of the NJ coast. These three inlets are the only connections between the Atlantic Ocean and the large shallow back bays that include Barnegat Bay, Manahawkin Bay, Little Egg Harbor, and Great Bay. This contrasts with the much closer average spacing between inlets in the Central and Southern regions discussed in subsequent paragraphs.

The shorelines on the east side of the back bays, along the barrier spit extending from Manasquan Inlet to Barnegat Inlet and along Long Beach Island, are fully developed. The two exceptions to this generalization include the nine mile-long reach occupied by Island Beach State Park and the

three mile-long Holgate Spit at the southwest end of Long Beach Island. Both of these areas are either State or Federal protected land and are unlikely to ever be developed.

In contrast to the eastern shoreline of the back bays, the western shoreline on the mainland of New Jersey is much more heterogeneous. This area is characterized by medium density single family home developments surrounded by back bay wetlands. There are numerous "finger canal" communities, many of which were developed in the period following World War II by bulk heading, dredging, and filling in what were previously tidal wetlands. One example is Beach Haven West in Stafford Township, Ocean County. This community has about 50 miles of bulk-headed residential shoreline and about 5,000 residential structures. In between the finger canal communities are more extensive reaches of back bay shoreline with little or no development. These areas typically consist of intertidal marsh/wetlands.

3.6.4 Central Region

The Central Region extends from Little Egg Inlet south to Corson Inlet, with an area of 312 square miles and all or portions of 21 municipalities in Atlantic and Cape May Counties. The ocean shoreline length of this region is about 27 miles and includes five tidal inlets: Little Egg, Brigantine, Absecon, Great Egg, and Corson. The relatively shorter distance between inlets compared to those of the North Region makes the back bays of this reach susceptible to relatively higher 1% ACE storm surge elevations.

As in the North Region, the back bay shorelines of the barrier islands are essentially fully developed with medium density residential and business infrastructure. However, the western (mainland) shorelines of the Central Region are significantly less densely developed than is the case in the North Region.

3.6.5 South Region

The South Region extends from Corson Inlet south and west around Cape May Point to the west end of the Cape May Canal, with an area of 146 square miles. All or portions of 16 municipalities are included in the region, all of which are part of Cape May County. There are five inlets that connect this region to the Atlantic Ocean and Delaware Bay. They include Corson, Townsends, Hereford, and Cape May Inlets and the western entrance to the Cape May Canal on Delaware Bay. The South Region is similar to the Central region in that the most extensive and dense development is along the west (back bay) side of the barrier islands, with relatively less dense development on the mainland side of the back bays. The 1% ACE storm surge elevations in the South Region are comparable to those in the Central Region, and larger than those in the North Region.

3.7 Risk-Informed Decision Framework

In accordance with the Principles and Guidelines (ER 1105-2-100) (1983) where "planners should identify areas of risk and uncertainty in their analyses and describe them clearly", the NJBB study has included risk informed decision making in all aspects of the study. This includes: 1) SMART Planning imperatives such as balancing the level of uncertainty and risk with the level of detail of analysis of the study; 2) ensuring transparent and early vertical team engagement of decision

makers as the study process progresses; identifying the Federal role in resolving a problem up front; 3) recognizing there is no single best plan and that there are quantitative and qualitative methods of alternative comparison and analysis; and 4) iterative incorporation of the six-step planning process. In addition, the consideration of risk and uncertainty is built into technical analyses including: economic Monte Carlo simulation analyses; inclusion of a number of storm events and scenarios in hydrodynamic modeling to determine with project water levels with statistical confidence levels; and consideration of water level crest height analyses in floodwall design height analyses. Lastly, stakeholder, public and agency involvement has been a critical component of the NJBB CSRM Study and the development of a back bay region-wide vision for managing coastal storm risk throughout the area.

4 Planning Considerations

4.1 Goals

The primary goal of the NJBB CSRM Feasibility Study is to work within the Coastal Storm Risk Management business line to reduce risk to human life and promote a sustainable economy through the reduction of storm surge and damage to residential and commercial structures and industries critical to the nation's economy.

4.2 Problems and Opportunities

4.2.1 Problems

The Atlantic Ocean coast of New Jersey is fronted by a system of Federal CSRM projects that extend from Sea Bright on the north to Cape May Point on the south (USACE, 2013). However, the NJBB study area, which encompasses portions of five counties and includes about 950 square miles of land and water, currently lacks a comprehensive CSRM program. As a result, the NJBB region experienced major impacts and devastation during Hurricane Sandy and other coastal storm events, including extensive inundation from storm surge due to the combination of low-lying topography, densely populated residential and commercial areas, extensive low-lying infrastructure, and degraded coastal ecosystems.

The NJBB Region is a dynamic environment that supports densely populated areas with billions of dollars of largely fixed public, private, and commercial investment. Hurricane Sandy emphasized our vulnerability to coastal storms and the potential for future, more devastating events due to rising sea levels and climate change. Rising sea levels represent an inexorable process causing numerous, significant water resource problems such as: increased, widespread flooding along the coast; changes in salinity gradients in estuarine areas that impact ecosystems; increased inundation at high tide; decreased capacity for storm water drainage; and declining reliability of critical infrastructure services such as transportation, power, and communications. Addressing these problems requires a paradigm shift in how we work, live, travel, and play in a sustainable manner as a large extent of the area is at a very high risk of coastal storm damage as we move into the future of changing sea levels.

Individual system-wide problem statements are grouped within three categories to be carried forward to inform the plan formulation process, and include:

Coastal Storm Risk Management:

Inundation: The NJBB study area currently lacks a comprehensive CSRM program to protect against inundation (economic disruption to residential and infrastructure & life and safety risks).

SLC/Climate Change: The study area that is currently at risk will likely see an increase in future damages with the potential for sea level rise in the future without project condition.

Erosion: The study area experiences disruption of shoreline from wave attack, wind forces and other elements.

Municipal Jurisdiction Disconnect: The study area lacks a comprehensive, multi-jurisdictional, multi-agency effort that can integrate storm risk management efforts in a way that crosscuts Federal/State/Local business lines, study authorities and agency missions.

Environment:

Degraded Ecosystems: The study area's coastal ecosystems fail to provide their natural ecosystem services (provisioning, regulating, supporting and cultural).

Economy and Infrastructure:

High-Frequency Flooding: The study area experiences high-frequency flooding, also known as nuisance flooding, recurrent flooding, or sunny-day flooding, caused by tides and/or minor storm surge that mostly affects low-lying and exposed assets or infrastructure, such as roads, public storm-, waste- and fresh-water systems and is likely more disruptive (a nuisance) than damaging. However, the cumulative effects of high-frequency flooding may be a serious problem to residents who live and work in these low-lying areas.

Municipal Storm water Infrastructure: The study area experiences flooding from rainfall and inadequate municipal storm water infrastructure that mostly affects low-lying and exposed assets or infrastructure, such as roads, public storm-, wastewater- and fresh-water systems.

Flood Forecasting Inconsistencies: The study area lacks a clear, timely, comprehensive forecasting tool for local flood risk managers and Emergency Operations Officials for determining local evacuation priorities based on projected surge levels.

Floods have been and continue to be the most frequent, destructive, and costly natural hazard facing the State of New Jersey (New Jersey, 2011). The study area is vulnerable to damage from storm surge, wave attack, erosion, and rainfall-storm water runoff events that cause riverine and/or inland flooding. The State of New Jersey, in the state hazard mitigation plan, has documented the numerous, historic instances of flooding, Presidential disaster declarations, and damage estimates. Historic sea level change has exacerbated the problem over the past century, and the potential for accelerated sea level change in the future will only increase the magnitude and frequency of the problem. These forces constitute a threat to human life and increase the risk of flood damages to public and private property and infrastructure.

The shorelines of most of New Jersey's back bays are characterized by low elevation areas developed with residential and commercial infrastructure and are subject to tidal flooding during storms. Public and private property at risk involves densely populated sections of the barrier island back bay coastline and also mainland portions of the areas bordering the bays and tidal tributaries of the study area. It includes private residences, businesses, schools, infrastructure, roads, and evacuation routes for coastal emergencies. Additionally, the NJBB study area includes undeveloped areas that provide ecological, fishery, and recreational benefits. Healthy marshes in the back bay areas have the potential to reduce coastal flooding and storm surge. These areas are subject to erosion, loss and alteration due to coastal storms. Back bay dune, beach, marsh and estuarine ecosystems are quite fragile in some locations and are threatened by sea level change. Inundation of sites identified through the Comprehensive Environmental Response, Compensation, and Liability Act (CERCLA), otherwise referred to as Superfund sites, or other hazardous waste sites may also severely impact water quality.

Based on recorded history, the National Flood Insurance Program (NFIP) records, and analysis of engineering data about flood plains it is clear that New Jersey is one of the more flood-prone

States in the nation. The NOAA National Climatic Data Center (NCDC) database reported 1169 flood events just since 1996 (NOAA NCDC, 2011). According to NFIP statistics, flood claims payouts have totaled more than \$5.3 billion since the beginning of the NFIP program in 1978 through July 2013. Out of that, nearly \$2.9 billion was paid for flood damages to the coastal counties of Monmouth, Ocean, Atlantic and Cape May from Hurricane Sandy damages alone.

New Jersey's low-lying coastline, stretching from Raritan Bay in the north, along the Atlantic Coast to Delaware Bay is highly susceptible to coastal flooding. This region has experienced frequent coastal flooding events over the years, causing extensive beach erosion, marsh loss, damage to dunes and other coastal flood risk management structures. Recent events in the coastal region include floods associated with Tropical Storm Ida in November 2009, a nor'easter in December 2009, a severe storm in April 2010, Hurricane Irene in August 2011 and more recently Hurricane Sandy in October 2012. Since Hurricane Sandy, there have been additional severe coastal storm events, including Hurricane Joaquin in September-October 2015, and extra-tropical cyclone (nor'easter) Jonas in January 2016. Both of these events caused significant oceanfront erosion and back bay flooding.

A more detailed analysis of problems and opportunities for the NJBB study area on a regional basis is provided in the Plan Formulation Appendix A.

4.2.2 Opportunities

Opportunities associated with the NJBB Study include the following:

- a. Develop a CSRSM system that reduces coastal flood inundation damages as well as wave and erosion damages.
- b. Develop a CSRSM system that mitigates sea level change.
- c. Develop a CSRSM system that assists in managing flooding risk to localized tidal flooding.
- d. Integrate storm risk management efforts into the NJBB CSRSM Agency Coordination and Collaboration Plan to foster partnerships and collaborative goals.
- e. Apply adaptive and sustainable solutions through a quantified review of measures and alternatives with partners and stakeholders to promote economic community resilience.
- f. Assist and advance local efforts and resources through discussion and qualitative review of measures and alternatives designed to improve forecasting.
- g. Identify complementary measures to address high-frequency flooding and inadequate storm water systems that may be recommended as part of a comprehensive Federal project or recommended for implementation at the local non-federal level

4.3 Objectives

The objective of the New Jersey Back Bay CSRSM Feasibility Study is to investigate CSRSM problems and develop solutions to reduce damages from coastal flooding affecting population, critical infrastructure, critical facilities, property, and ecosystems. The study principles are based upon the authority for the NJBB Study (Resolutions adopted by U.S. House of Representatives

and U.S. Senate Committees in December 1987) which are broad in scope and application, and support NACCS outcomes.

Specific objectives for the Study are to:

- a. Reduce economic damages from coastal storm surge and inundation through CSRM risk management.
- b. Reduce risk to human life from coastal flooding and storms as well as other social effects including community cohesion and prevent post-storm displacement.
- c. Reduce the risk of inundation and effects on economic damages and future development owing to SLC through formulation analyses.
- e. Restore and prevent ecosystem degradation through nature-based infrastructure, alone and in combination with traditional measures.
- f. Support and advocate flood forecasting and evacuation plans and technology.

4.4 Constraints

Coastal communities face tough choices as they adapt local land use patterns while striving to preserve community cohesiveness and economic vitality. In some cases, this may mean that, just as ecosystems migrate and change functions, human systems may have to relocate in a responsible manner to sustain their economic viability and social resilience. Absent improvements to our current planning and development patterns that account for future conditions, the next devastating storm event will result in similar or worse impacts.

Planning constraints associated with the NJBB CSRM Feasibility Study include: a) resource; b) universal and c) study-specific constraints.

- a. Two distinctly different categories of planning constraints can be identified. First, there are Resource Constraints in the planning process. These include limits to our knowledge, expertise, experience, ability, data, information, money and time. These constraints limit the scope of a study in significant ways. A second category of planning constraints can be divided into Universal Constraints and Study-Specific Constraints. Universal Constraints are the legal and policy constraints that need to be included in every planning study. They may vary from study type to study type, but for a given type of study, there are some predictable constraints. The Corps' guidance, regulations, policies, and authorities define some of these constraints. Others are defined by the laws and regulations of the federal government and the applicable laws and regulations of the State and local governments. Study-Specific Constraints are statements of things unique to a specific planning study that alternative plans should avoid. While Universal Resource Constraints:
 1. Avoid non-sustainable solutions that cannot be maintained, whether due to expense or complicated technologies, by the non-Federal sponsor.
 2. Difficulty in funding long-term operation and maintenance costs.

- b. Universal Constraints:
 - 1. Comply with all Federal laws and executive orders, such as the National Environmental Policy Act (NEPA), the Clean Water Act, the Endangered Species Act, and Executive Order 11988.
 - 2. Mutual acceptance must be developed between the Secretary of the Army and the Secretary of the Interior, if the plan lies within jurisdictional boundaries of the National Park Service or U.S. Fish and Wildlife Service.
 - 3. Acquisition of real estate and easements.
 - 4. Avoid additional degradation of water quality, which would put additional stress on aquatic ecosystems.
 - 5. Avoid impacting or exacerbating existing hazardous, toxic, and radioactive wastes (HTRW) that have been identified within the project area.
 - 6. Minimize the impact to authorized navigation projects.
 - 7. Minimize effects on cultural resources and historic structures, sites, and features.
- c. Study-Specific Constraints:
 - 1. Avoid increasing the flood risk to surrounding communities and facilities.
 - 2. Consider local land use plans and regulations in developing the Federal plan.
 - 3. Many of the beaches within the study area are recognized as a recreational resource and it is important that this resource be maintained.
 - 4. Some areas within this study area are highly developed, and the density of population may limit the amount of space available for staging and constructing a project.
 - 5. Minimize the impact to other projects and areas where risk has been managed, such as sensitive wetlands, wildlife management areas, etc.

4.5 Period of Analysis

The period of analysis for comparison of the preliminary focused array of alternative plans is the 50-year period from 2030 to 2080. Project implementation in a phased, scalable format is assumed to begin in the year 2030 and continue for five years to 2035. The base year is 2030 and is considered the year the alternatives have been implemented and project benefits will commence to accrue sequentially as different parts of the plans achieve implementation. Alternative plan performance has been evaluated as part of the NJBB CSRМ Study through the calculation of economic future damages, engineering and environmental performance for the 2030-2080 fifty-year period according to USACE policy (USACE, 2000). Coastal sustainability associated with sea level change (USACE, 2014; USACE, 2013) will be evaluated for the 100-year period from 2030-2130 for all of the alternative plans in the preliminary focused array.

4.6 Critical Assumptions

The NJBB Project Delivery Team (PDT) made certain assumptions and simplifications while performing the study and developing the Interim Feasibility Study and Environmental Scoping Document. These decisions affected the decision making process. As a result, the formulation of alternative plans at this point of the study were formulated with less level of detail of analysis than will be considered for future study phases. Critical assumptions from several disciplines were communicated with interested groups and decision makers through the use of a risk register and at a series of stakeholder and public meetings identified in Chapter 3.5.

Some of these critical assumptions are summarized below:

Economics:

The Hydrologic Engineering Center - Flood Damage Reduction Analysis (HEC-FDA) software model was used to perform economic modeling for the study area. While HEC-FDA is an USACE approved economic model, HEC-FDA is typically applied in riverine flood-prone areas. Also, a reduced sample size is used to inform certain critical variables such as foundation height (for use in First Floor Elevation calculation) and Depreciated Replacement Value adjustment (Marshall & Swift Residential Estimator software) across the entire inventory within the study area.

Engineering:

Geotechnical and geo-environmental analyses and utility siting/location info are based on existing data in the study area. Additional data collection and surveys to inform feasibility-level design analyses will occur in study phases after this Interim Feasibility Study and Environmental Scoping Document has been released, or during the Preconstruction, engineering and design (PED) phase of the project. The level of detail on conceptual engineering analyses, calculations, designs and costs is limited at this point in the study. Thus, parametric estimates for some costs have been used, thus resulting in high contingency.

Environmental:

The quantification of some environmental impacts associated with storm surge barriers and associated mitigation has not been performed since hydrodynamic environmental circulation and water quality modeling has not been completed at this point in the study. Due to the insufficient detail and preliminary nature of the preliminary focused array of alternative plans presented in this report, environmental resource agency concurrence and NEPA compliance document development will occur later in the study phase or during PED. Cultural Section 106 surveys will be conducted later in the study phase or during PED.

Table 4-1 provides a more comprehensive list of some of the important decisions along with a qualitative assessment of the risks and consequences associated with those decisions.

Table 4-1: Critical Assumptions

NEW JERSEY BACK BAYS REVISED DRAFT INTERIM REPORT CRITICAL ASSUMPTIONS TABLE			
Risk Register ID Number	Scoping Choice or Event	Risk	Consequence
Geotechnical Engineering	No Geotechnical Subsurface investigations or field data will be collected during the study to support structural features. Only Geotechnical field data with respect to potential beachfill alternatives will be collected during study.	Lack of site specific data for feasibility level of design and geotechnical engineering analysis of potential TSP features.	1. Conservative assumptions must be used that will drive up cost estimates and associated contingency of potential project features. 2. Existing data may not be sufficient to support an acceptable EIS and proper regulatory compliance. 3. PED schedule could be significantly impacted as final designs can't be completed until data collection and analyses are complete. 4. Even with conservative assumptions, actual construction costs could be significantly higher for some project features due to the varied and complex geologic conditions of the New Jersey coastal environment.
Structural Engineering	Level of detail on conceptual engineering analyses, calculations, and designs. Estimated labor costs may not be comprehensive enough to cover the field of engineering practices for the structural analyses and designs.	Typical structural engineering analyses, calculations, and designs for the project structural features are performed based on assumptions or limited data collection. Typical designs are provided for the different project features. Increasing the level of assumptions increases the risk of unsuitable designs for the different project features, which also increases the risk of redesigning and requiring additional funds. May need more engineers and/or resources to participate in the project.	1. Improper analysis of the proposed project features due to the uncertainty related to a low volume of data and/or assumptions made could result in unrealistic designs, redesigning the structures may be necessary. 2. Estimated labor costs may not be sufficient for analyses and designs of the project features. Designed features may not be practical or could not be constructed as proposed. Potential for inadequate design, factors of safety, and structural stability due to insufficient data. Potential for iterative redesign of elements due to uncertainty of constructability, which could increase in costs as a result. Labor costs can increase, TSP plan may not be practical or could not be constructed as proposed.
Civil Engineering	Civil/Site final feasibility design Level of detail not adequate for environmental resource agencies.	Final design from study is not acceptable to environmental resource agencies due to lack of design detail.	EIS report is deemed inadequate and not acceptable. Study delayed and not enough funds or time to properly attain acceptable design level of detail.
Civil Engineering	Condition and ability of existing CSRM structures to reduce flooding and be incorporated into plan	Existing bulkheads and other existing CSRM structures in poor or failing condition and not able to adequately function or be incorporated into project features. Assumptions made about condition of existing structures is not field verified or analyzed.	Inaccurate project costs due to assumptions about existing CSRM structures being wrong. Possible wrong TSP selected due to inaccurate BCR. Increased P E & D costs and final project construction costs.
Cost Engineering	Design development stage: preliminary	Incomplete technical data.	Higher construction cost due to increased contingencies on the order of 50% or higher. The increased contingencies are the result of lack of adequate/incomplete/conservative technical data and analyses. This will impact cost/benefit calculations and net benefits.
Geo-Environmental Engineering	Defer new geo-environmental exploration/testing and HTRW investigations to PED phase. OR eliminate HTRW investigations entirely from study.	Using existing information for feasibility study could lead to contaminated material being found during PED and incomplete information about subsurface conditions.	Additional construction cost and time. Additional design time. Unknown chemical characteristics of the soil, sediment and groundwater for disposal costs. Conservative volumes and cost estimates would be used, resulting in potentially erroneous project estimates.
H&H/Coastal Engineering	H&H Modeling Needs for Impacts from proposed SSBs	Several hydraulic models will be needed to consider significant number of environmental impact risks. These models can be costly and time consuming. With these models, the study cost and time increases.	Because these models are included, the study cost and length is higher. It's possible that even additional time or money could be required if the analysis turns out to take longer than expected.
H&H/Coastal Engineering	Level of effort for the coastal lakes portion of the study area	Except for the coastal lakes that are hydraulically connected to Barnegat Bay or Shark River, the coastal lakes area requires very different analysis such as interior drainage and storm sewer utility evaluation. These analyses will take more extensive time and cost. No extensive analysis will be completed and only recommendations for future work will be addressed for the coastal lakes that are not hydraulically connected to Barnegat Bay or Shark River.	Only recommendations for future work will be addressed in this study. Sponsor and Stakeholders may desired actionable designs/projects as a study outcome.
H&H/Coastal Engineering	Evaluate navigation impacts at inlets where storm surge barriers are proposed using a desktop analysis only.	Per ER 1110-2-1403, hydraulic design studies that affect navigation channels require ERDC's Ship/Tow Simulation Analysis. This detailed analysis requires significant time and cost.	Navigation impacts that affect the design of federal inlets may not properly be identified during feasibility.
Plan Formulation	Full range of flood risk management measures to be considered which include nature based solutions, engineering solutions and non-structural to be aligned with NACCS authority and guidance	Consideration of non-structural, natural and nature based features, and policy/programmatic solutions may not be consistent with VT direction, and may not provide comparable risk management capability of traditional structural solutions and may increase costs without increasing benefits but exclusion may make project inconsistent with NACCS	Inclusion may impact justification, exclusion may make study inconsistent with the goals of NACCS, reduce sponsor interest
Plan Formulation	Plan Formulation - Alternatives Risk	Scope of plan formulation will vary based on the appropriate extent of the alternatives evaluated	Low risk scenarios for planning alternatives will add time and costs to the study by evaluating 8 alternatives, while high risk scenarios will require aggressive screening and only evaluate 4 regional alternatives. Formulation, and removal of alternatives that may be viable options for implementation will present storm damage risks and evaluation of too many alternatives will create additional study and costs risks
Economics	Economics Database	The Economics database will be large and existing databases will need to be supplemented with new surveys/databases	Benefits Calculations
Economics	Use of models for evaluation of benefits	There are 3 models for use in the evaluation of benefits for the study, use of certain models in certain environments is more appropriate than others and limiting the use of models choice could impact benefits	A decision to limit the use of a model to decrease study time and costs would hinder project approval if the model is not approved for that environment type, the model use could have negative impacts on AAD, AAC, BCR, NED
Economics	Sampling % for structure database	There are over 150,000 structures in the NJBB study area, surveying all for first floor elevations would be difficult in the study timeframe regardless of schedule, for this reason sampling will be used for critical economic data	Decreasing the sample size to reduce study costs could result in analytical errors in benefit calculations, larger study samples could improve accuracy of the methods used for first floor elevations, depreciated replacement costs
Data	NFIP elevation certificates have been used to collect data on first floor elevations throughout the study area but may not be of great enough quantity to be the basis for FFE estimation	NFIP elevation certificates are only required on homes that are newly constructed or have significant renovations. Therefore, the data from NFIP elevation certificates may be biased towards structures that are at higher elevations	If the structure inventory is biased towards a higher elevation it could result in the underestimation of damages, which may result in more costly alternatives being inappropriately screened out of consideration.
Environmental	A lower level of design will potentially be used for the Environmental Scoping Document (ESD)/draft Feas. Report that is released for public and agency review.	Inadequate preliminary ESD or having to do a supplemental NEPA document in PED. Not getting resource agency buy in and subsequent approvals due to insufficient detail and information in NEPA document.	Need for supplemental NEPA document. Increase in budget and delay in schedule. Picking the wrong selected plan. Worst case scenarios may preclude selection of a viable plan.

5 Existing Conditions

5.1 Introduction

Existing conditions are characterized and documented in this section and serve as the basis for the problem identification and plan formulation including the development of future without project conditions. Development of detailed existing conditions across the study area identifies the vulnerabilities to coastal storm damage. This process helps to identify coastal risk reduction and resilience opportunities. The existing condition serves as the base against which all proposed risk reduction analyses and future without project conditions are compared.

The existing conditions are the conditions at the time the study is conducted (Para. 2-3(5)b of the 1105-2-100, USACE Planning Guidance Notebook) which consider the impacts of coastal storms including Hurricane Sandy and include local, state, regional and Federal government agency and NGO response since Hurricane Sandy. This existing condition analysis includes consideration of the general and physical setting including coastal processes, and a characterization of economic, environmental and cultural resources conditions.

The existing conditions for the State of New Jersey are summarized by the fact that while coastal storm risk is managed along the Atlantic Ocean coast by a number of Federal coastal storm risk management projects, the back bay and Delaware Bay coasts are not well protected due to the limited number of coastal storm risk management projects.

This Section discusses the existing conditions for the New Jersey Back Bay study area with respect to shoreline types, environmental conditions, economic conditions, and cultural resources.

5.2 General Setting

Barrier islands, barrier spits, and headland beaches make up the eastern side of the study area. These features face the brunt of the ocean forces including waves, currents, swells, winds, tides and storms and reduce the impacts to the bays and mainland coastlines landward of the islands. The maximum topographic elevations along the ocean coastline vary from approximately +10 to +22 ft. NAVD88 in areas where Federal CSRMs exist. Only a few areas along the ocean coast do not have federal projects: the Gateway National Recreation Area, the Edwin B. Forsythe National Wildlife Refuge and Island Beach State Park. While some of the topography in these undeveloped, preserved areas is higher with natural dunes, generally the elevations are lower with no continuous line of higher elevations to limit overtopping and erosion.

The back bays behind the barrier islands collect sediments from rivers and streams that drain from the mainland creating significant areas of shallow tidal marshes. In addition, there are areas of open water that vary in extent. Average depths in the bays behind the barrier islands vary from 3 to 6 ft. with some deeper areas up to 35 ft. near inlets. These depths represent areas outside the New Jersey Intracoastal Waterway (NJIWW). The NJIWW is dredged for navigation to maintain a depth of 6 ft. in most of the channel but up to 10 to 12 ft. deep in some locations (USACE, 2016b).

In the northern part of the NJBB study area, from the coastal lakes south to Manasquan Inlet, there are no barrier islands; beaches in this segment of shoreline are either headland beaches or barrier spits and are directly impacted by the ocean forces. Maximum topographic elevations

along the ocean shoreline range from about +10 to as much as +25 ft. relative to the North American Vertical Datum of 1988 (NAVD 88). In this area, there are small, non-tidal lakes that drain through outfalls to the ocean. The coastal lakes are shallow, with maximum depths generally not exceeding 10 ft. under normal conditions.

5.3 Existing Studies and Projects

Coastal storm risk is managed along the Atlantic Ocean coast of New Jersey by a number of Federal CSRM projects (**Figure 5-1**). However, the NJBB study area is presently exposed to significant coastal/tidal flood risk, due to the non-comprehensive system protection from flooding owing to the scattered constructed Federal, state and other coastal storm risk management projects included in **Figure 5-2**.

The New Jersey Back Bays study area includes five authorized Federal navigation projects at inlets, which connect the Atlantic Ocean to the back bays. From north to south the inlets (and their respective entrance channel dimensions (channel width and authorized navigation depth, in ft.) are: Shark River Inlet (100 x 12), Manasquan Inlet (250 x 14), Barnegat Inlet (300 x 10), Absecon Inlet (400 x 20), and Cold Spring (Cape May) Inlet (400 x 25). There is also the NJIWW, which is an authorized Federal navigation project with depths maintained at 6 to 12 ft. depending on location. The northern entrance to the NJIWW is at Manasquan Inlet. The NJIWW transits generally southward through the back bays of the study area until it enters Cape May Harbor, and then westward across the Cape May peninsula through the Cape May Canal. The western terminus of the Cape May Canal on Delaware Bay is also the southwest end of the NJIWW.

A more detailed discussion of Existing CSRM Studies, reports, actions and programs can be found in the Plan Formulation Appendix A.

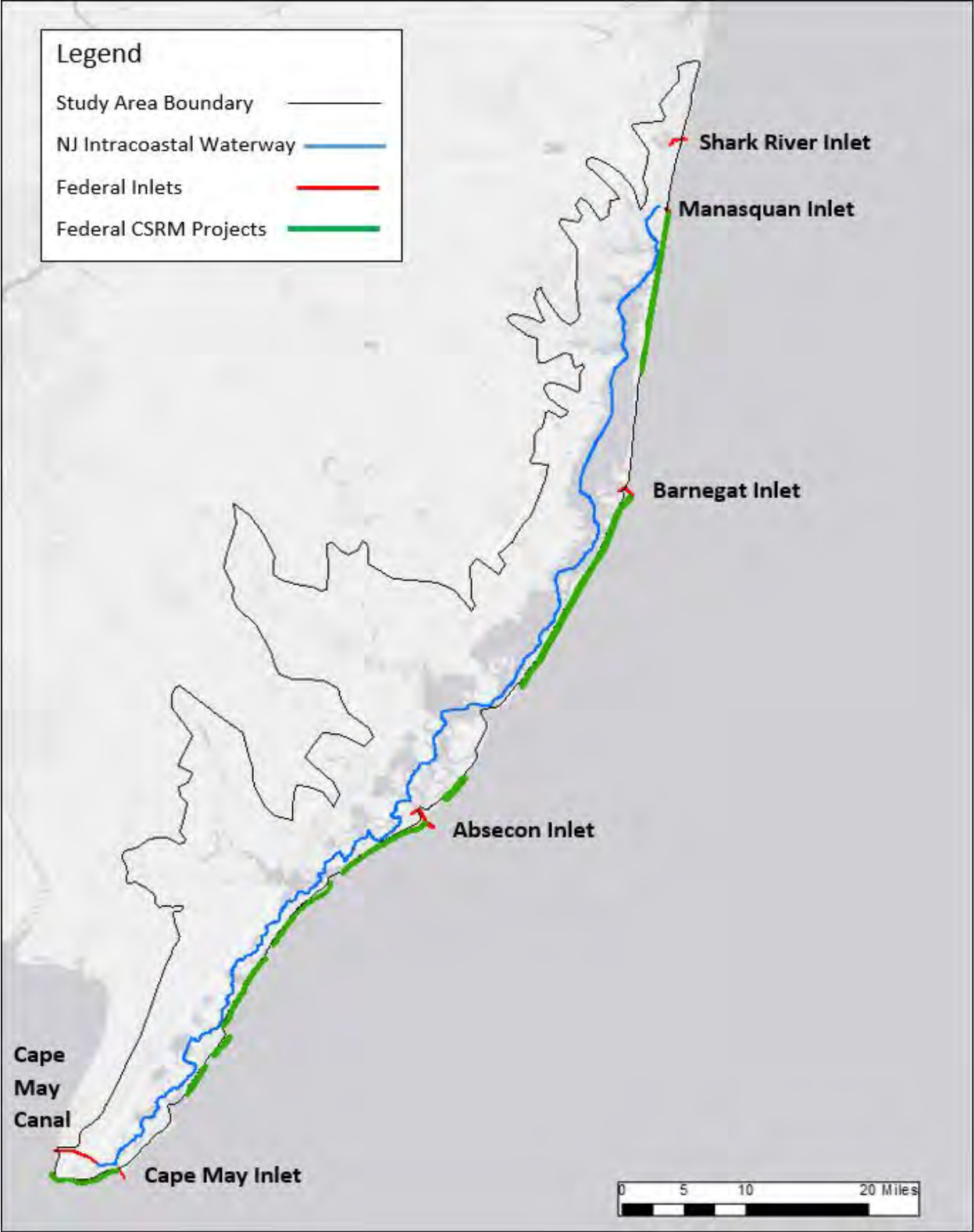

Figure 5-1: Constructed NJ Intracoastal Waterway, Inlet Navigation and Oceanfront CSRM Projects in the NJBB Study Area

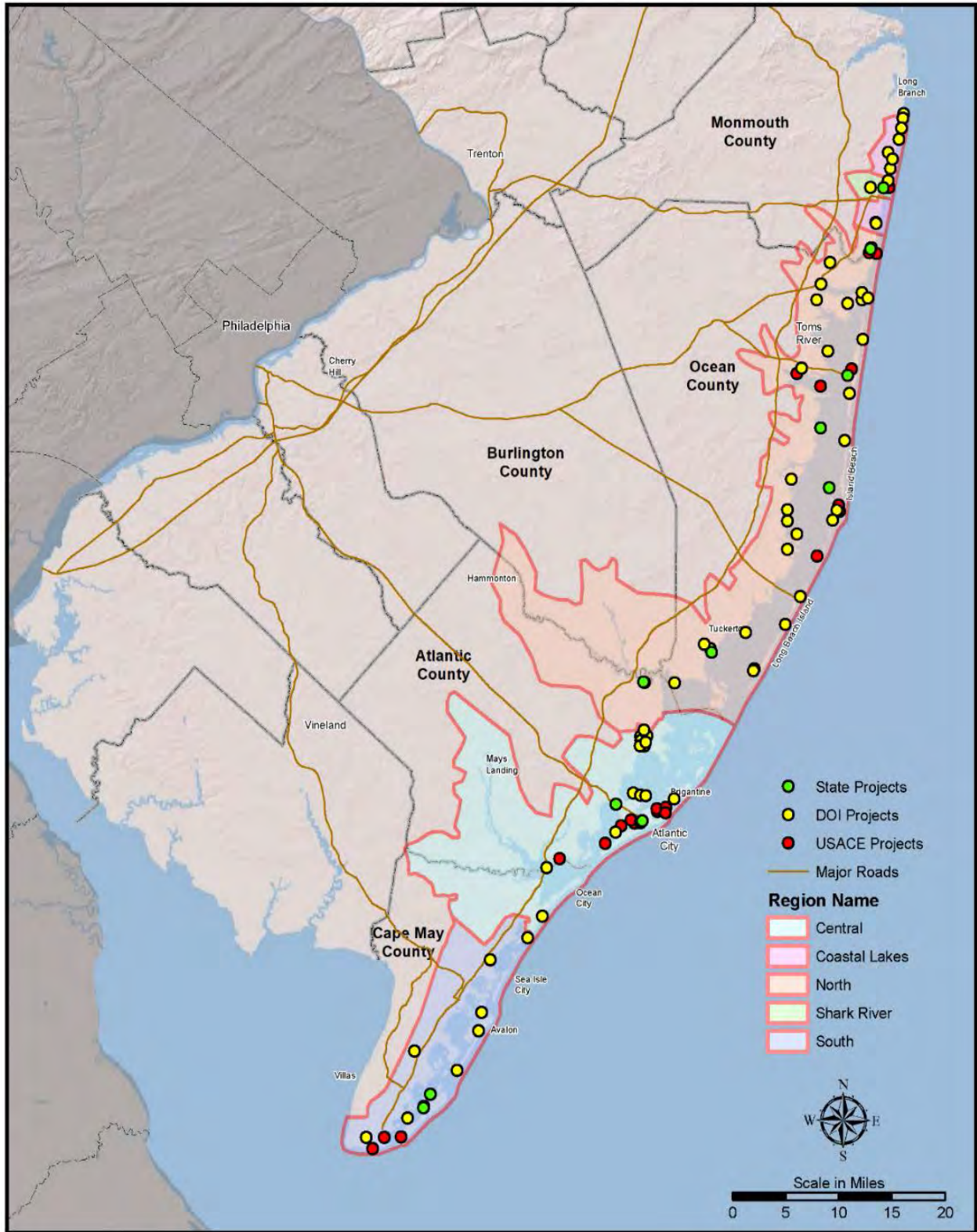

Figure 5-2: NJBB State, US Department of Interior (DOI), and USACE Projects

5.4 Shoreline Types

Shoreline types within the NJBB study area were initially mapped using the NOAA Environmental Sensitivity Index Shoreline Classification (NOAA, undated), which was compiled in the NACCS. This data set includes ten broad shoreline types existing within the entire NACCS study area, from New Hampshire to Virginia: rocky shorelines (exposed), rocky shorelines (sheltered), beaches (exposed), manmade structures (exposed), manmade structures (sheltered), scarps (exposed), scarps (sheltered), vegetated high banks (sheltered), vegetated low banks (sheltered), and wetlands/marshes/swamps (sheltered). Each of the shoreline types responds differently to coastal storms, sea level change and adaptive management; therefore, these are important considerations in identifying coastal storm risk management measures.

However, the most spatially comprehensive and detailed mapping and classification of shoreline types directly applicable to the NJBB study area was created by the NJDEP. The original state-wide dataset was clipped to include only the area within the NJBB study area. The total mapped shoreline length within the study area is 3,446 miles in 68 classes. The 68 classes of shoreline were divided into two broad groups: undeveloped shorelines and developed shorelines, which include 2,729 and 717 miles of shoreline, respectively. The resulting data is summarized in **Table 5-1** and displayed in **Figure 5-3**.

Table 5-1: NJDEP 2012 Shoreline Mapping

Undeveloped Shoreline (UDS)	Miles	% of UDS	% of Total	Developed Shoreline (DS)	Miles	% of DS	% of Total
Saline Marsh	2,521	92	73	Residential	517	72	15
Wetlands	80	3	2	Business/Comm.	34	5	1
Forest	32	1	1	Misc. (beach, recreational, lagoon entrances, etc.)	166	23	5
Phragmites	80	3	2				
Old Field / Agra.	7	<1	<1				
Misc.	9	<1	<1				
TOTAL UDS	2,729	100	79	TOTAL DS	717	100	21

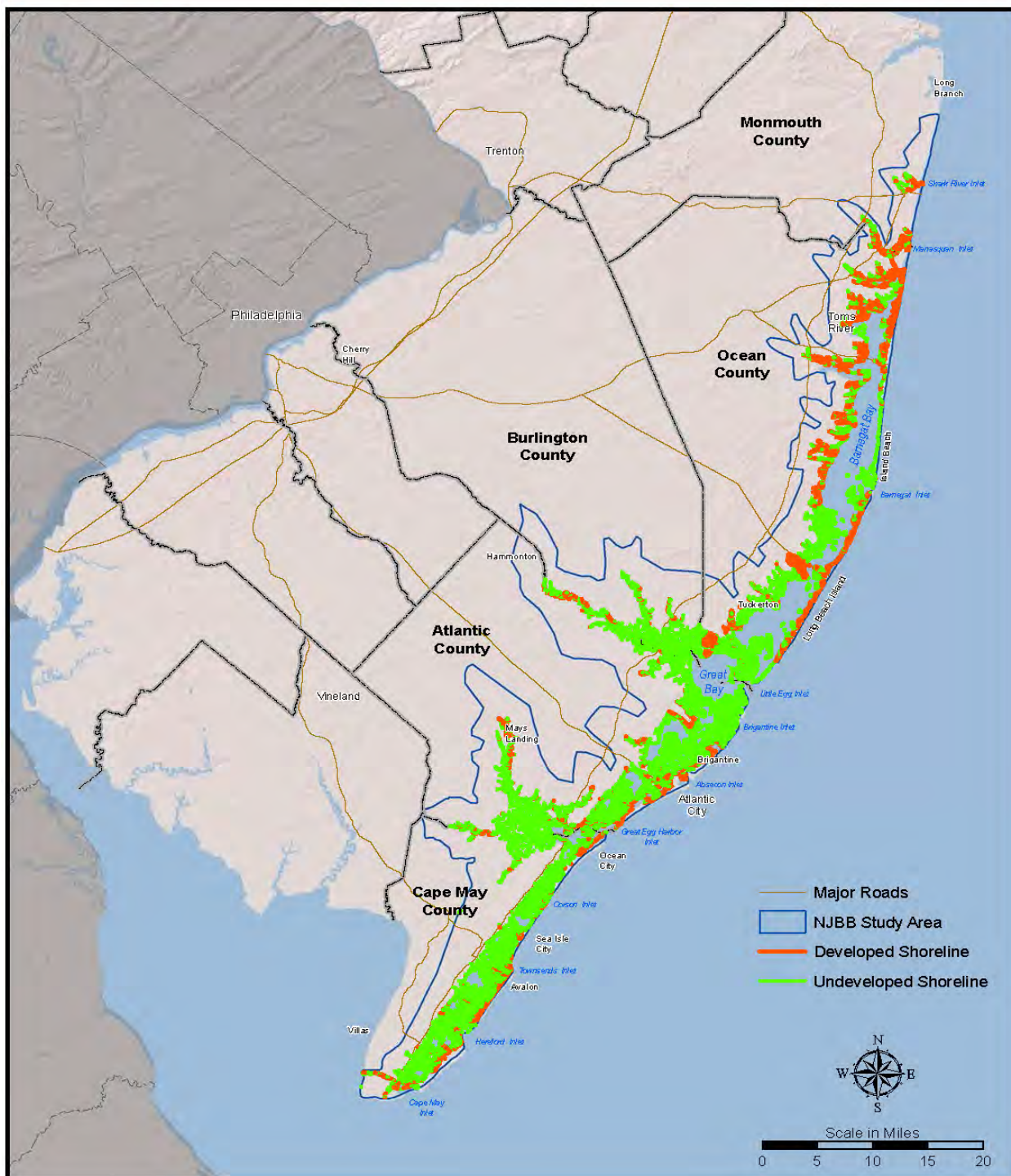

Figure 5-3: Developed vs. Undeveloped Shoreline

It is important to note that the NJDEP data layer reflects “land use type” and does not explicitly identify “bulk-headed residential shoreline” versus “residential shoreline with no structure”, for example. It is evident when viewing the data in GIS applications that the majority of the shoreline in the residential group (which includes seven sub-classes) is in fact bulk headed, but there are exceptions to this generalization. Likewise, the class “recreational” (within the Misc. group under Developed Shoreline), totals 62 miles of NJBB shoreline. However, the recreational class is a subjective mix of marinas/docks, open park space, etc.

5.5 Economics

The structure inventory indicates that there are approximately 182,930 structures within the NJBB study area. The structure inventory was created using a combination of the New Jersey MOD-IV Tax Lists and NJDEP-collected Building Footprint polygons for each of the five counties within the study area. **Table 5-2** outlines the number of structures inventoried by county.

Table 5-2: Structure Inventory Totals within Project Area

County	Structures
Monmouth County	10,598
Ocean County	81,262
Burlington County	322
Atlantic County	32,825
Cape May County	57,923

Information on the existing economic conditions within the New Jersey Back Bay Study area was collected from the U.S. Census Bureau, Federal Emergency Management Agency (FEMA), Bureau of Labor Statistics (BLS), Bureau of Economic Analysis (BEA), New Jersey Department of Labor and Workforce Development, New Jersey MOD-IV Property Tax Records, and County mapping resources.

The study area extent was developed using the National Weather Service (NWS) Sea, Lake, and Overland Surges from Hurricanes (SLOSH) model to create a Category 4 Hurricane Maximum of Maximums (MOM) study area limit. Within this study boundary, a detailed structure inventory was developed for all structures residing within the NACCS 0.2% Annual Chance Exceedance (ACE) Event Floodplain.

Residential structures comprise the majority of structure type within the study inventory, but non-residential structures (commercial, industrial, public, and academic) have a much higher average value and constitute just under 50% of total structure value.

Table 5-3 reflects only depreciated replacement structure and content value within the detailed structure inventory and does not account for additional benefit categories such as Infrastructure damages, vehicles damages, emergency costs, or transportation delays.

Table 5-3: Structure Inventory Summary Information

Structure Count by Type		Value	Percent
	Residential	173,845	95.0%
	Non-Residential	9,085	5.0%
	Total	182,930	100.0%
Structure Count by County		Value	Percent
	Monmouth	10,598	5.8%
	Ocean	81,262	44.4%
	Burlington	322	0.2%
	Atlantic	32,825	17.9%
	Cape May	57,923	31.7%
	Total	182,930	100.0%
Structure Value by Type		Value	Percent
	Residential	\$39,517,404,890	54.7%
	Non-Residential	\$32,706,835,440	45.3%
	Total	\$72,224,240,330	100.0%
Structure Value by County		Value	Percent
	Monmouth	\$4,357,499,270	6.0%
	Ocean	\$25,034,178,930	34.7%
	Burlington	\$99,498,110	0.1%
	Atlantic	\$20,842,857,680	28.9%
	Cape May	\$21,890,206,340	30.3%
	Total	\$72,224,240,330	100.0%

Historic Damages:

With \$65 billion in damages across 26 states (including 13 states with Major Disaster declarations), Hurricane Sandy is the largest storm of its kind to strike the East Coast of the United States. Hurricane Sandy also resulted in 159 fatalities, 650,000 homes destroyed or damaged, and years of recovery efforts.

Within the five New Jersey counties included in the New Jersey Back bay Study, 260,958 people and 191,244 structures were exposed to Hurricane Sandy, resulting in 137,309 damaged structures and \$4.5 billion in total damages. **Table 5-4** shows the effects of Hurricane Sandy according to the FEMA Modeling Task Force (MOTF) and the NACCS New Jersey State Analysis.

Information on the existing economic conditions and historic damages within the New Jersey Back Bay study area was collected from the U.S. Census Bureau, Federal Emergency Management

Agency (FEMA), North Atlantic Coast Comprehensive Study (NACCS) and New Jersey MOD-IV Property Tax Records.

Table 5-4: Historic Damages (Hurricane Sandy) by County

County	Population	Population Exposed	Households Exposed	Structures Damaged	Total Damages (\$1000)
Atlantic	274,549	75,537	38,610	21,705	\$635,750
Burlington	448,734	11,039	5,898	150	\$144,902
Cape May	97,265	34,730	54,516	31,516	\$659,828
Monmouth	630,380	45,439	27,538	21,452	\$1,137,124
Ocean	576,567	94,213	64,682	62,486	\$1,874,934

5.6 Existing Coastal Storm Risk

5.6.1 Tides

The Atlantic Ocean adjacent to the study area experiences semi-diurnal tides, with a full tidal period that averages 12 hours and 25 minutes; hence there are nearly two full tidal cycles per day. The mean tidal range in the ocean is 4.0 ft. at Atlantic City. The rise and fall of the tide in the ocean leads to tidal flow through the inlets that causes a corresponding rise and fall of water levels in the back bays.

Figure 5-4 shows the locations of tide gauges within the study area. The green symbols are NOAA/NOS tide gauges: one in the ocean at Atlantic City and one in Delaware Bay at the western entrance to the Cape May Canal. The NOAA/NOS tide gauge at Atlantic City is the only open-ocean gauge in the study area and has a period of record of over 100 years. The mean tide range in the ocean gradually increases north of Atlantic City, to 4.7 ft. at Sandy Hook at the entrance to Raritan Bay and New York Harbor. The second green symbol in **Figure 5-4** is the NOAA/NOS tide gauge at the Cape May Canal western entrance, with a mean range of 4.9 ft.

Figure 5-4 also displays the locations of tide gauges operated by the US Geological Survey (USGS) as red triangles. Data from these gauges indicate that the southern half of the study area, from Little Egg Harbor Inlet south to Cape May Inlet, experiences a mean tide range that is only slightly reduced relative to the mean range in the open ocean at Atlantic City, typically in the 3.5 to 4.0 foot mean range. This is due to the relatively shorter distance along the coast between inlets, and the relatively short distances from the open ocean, through the inlets, to the inland extent of the bays.



Figure 5-4: USGS Tide Gauges (RED) and NOAA/NOS Tide Gauges (GREEN)

Figure 5-5(a) shows tides during typical non-storm conditions (6 through 9 October 2018) for the ocean at Atlantic City and at five USGS gauges located in the back bays south of Little Egg Inlet. The Atlantic City data are shown as the heavy black line. The data for the USGS back bay gauges are difficult to distinguish from the ocean tide signal at Atlantic City, other than a small phase lag; high and low tides in the back bays are comparable to those in ocean but occur later.

North of Little Egg Harbor Inlet the mean tide range in the back bays gradually decreases such that at Mantoloking, near the head of Barnegat bay, the mean range is about 0.9 ft. The reduction in mean tide range is due to the long, narrow, and shallow geometry of Barnegat Bay and the relatively greater distances between inlets; it is about 24 miles from Manasquan Inlet south to Barnegat Inlet, and then an additional 21 miles south to Little Egg Harbor Inlet. Additionally, the hydraulic connection between the head of Barnegat Bay and Manasquan Inlet is the Point Pleasant Canal, which is 2 miles long but only about 150 ft. wide. **Figure 5-5(b)** shows typical non-storm tides at back bay gauges in the northern part of the study area over the same four-day period in **Figure 5-5(a)**. The tide in the ocean at Atlantic City is indicated by the bold black line. The additional tide curves are from gauges from Little Egg Inlet north to Mantoloking, and show a continually diminishing tide range and increasing phase lag toward the head of Barnegat Bay.

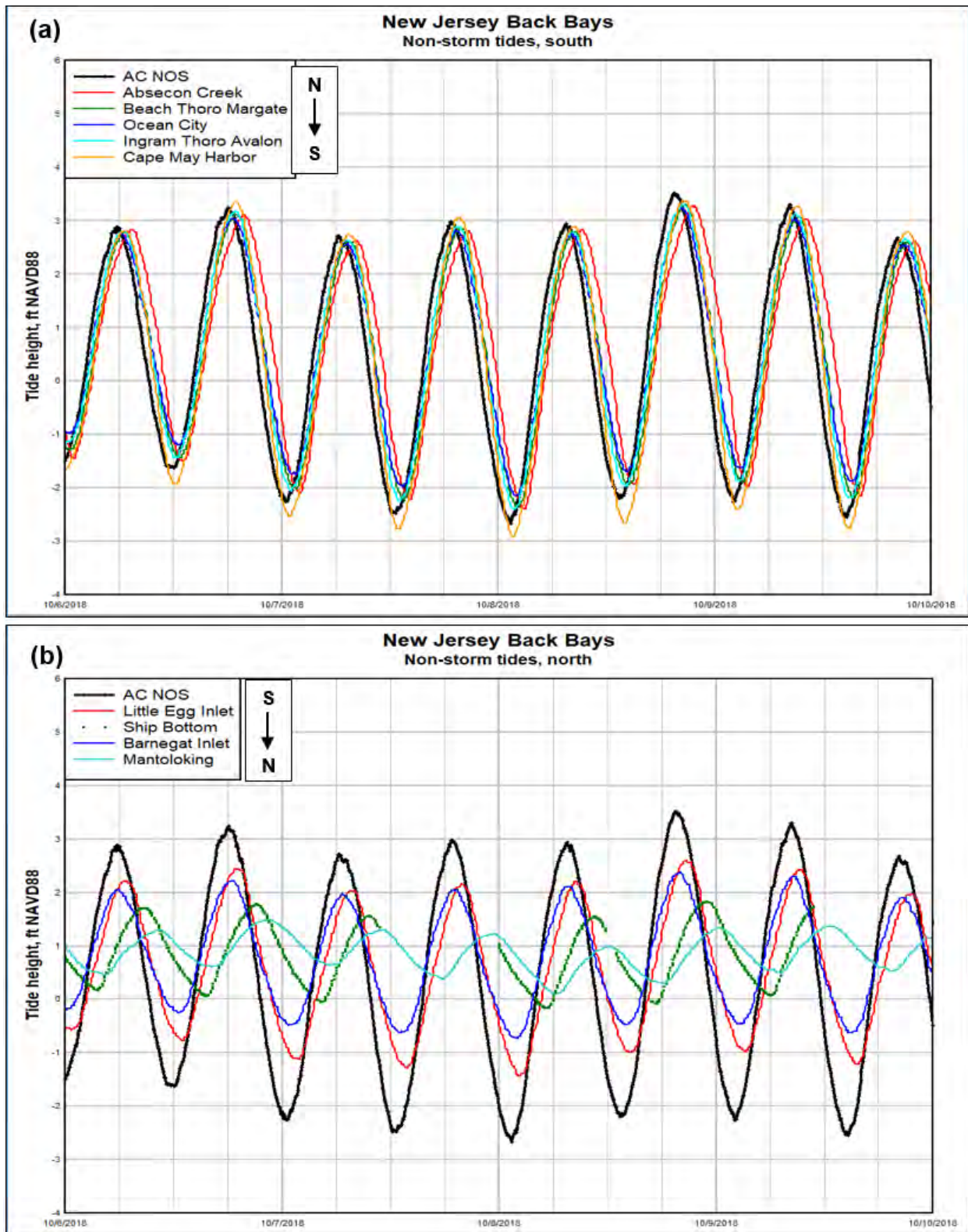

Figure 5-5: Non-storm tides for the South (a) and North (b) portions of the NJBB Study Area

5.6.2 Storm Surge

Storm surge is the increased water level above the predicted astronomical tide due to storm winds over the ocean and the resultant wind stress on the ocean surface. The principal factor that creates flood risk for the study area is storm surge that propagates into the back bays through the twelve inlets distributed along the New Jersey coast, between Shark River Inlet on the north and the Delaware Bay entrance to the Cape May Canal on the southwest. The magnitude of the storm surge is calculated as the difference between the predicted astronomic tidal elevation and the actual water surface elevation at any time. Any wind blowing over the ocean surface is capable of generating storm surge. However, the largest and most damaging storm surges develop as a result of either tropical cyclones (i.e., hurricanes) or extra-tropical cyclones (“nor’easters”). Although the meteorological origins of the two types of storms differ, both can generate large, low-pressure atmospheric systems with intense wind fields that rotate counter-clockwise (in the northern hemisphere). The relatively broad and shallow continental shelf along the study area allows the generation of larger storm surge values than are typically experienced on the US Pacific coast.

Just as **Figure 5-5** depicted differences in tidal characteristics between the southern and northern portions of the study area during non-storm conditions, **Figure 5-6** shows the differences between southern and northern areas during storm conditions, specifically those that occurred during Hurricane Sandy in October 2012. As depicted in **Figure 5-6**, the water level response of the southern back bays (**Figure 5-6(a)**) during Sandy broadly resembled the tide signal in the ocean at Atlantic City, although a number of the back bay gauges measured water levels higher than that observed at Atlantic City. Likewise, **Figure 5-6(b)** shows a larger degree of variability in storm surge response for the northern back bay areas, likely due to the effects of wind acting on the shallow, narrow Barnegat and Little Egg Harbor Bays. In particular note in **Figure 5-6(b)** that the tide level at Mantoloking near the head of Barnegat Bay stayed at near-normal values until late in the day on 29 October, when Sandy made landfall near Atlantic City. After Sandy’s landfall, the change in wind direction over the back bays “pushed” accumulated storm surge from the southern end of the Little Egg Harbor-Barnegat Bay system to the north, inundating the back bay side of Mantoloking in a matter of a few hours.

Figure 5-5 and **Figure 5-6** were presented to illustrate the different non-storm and storm condition water level characteristics of the southern portion of the back bay study area compared to the northern portion.

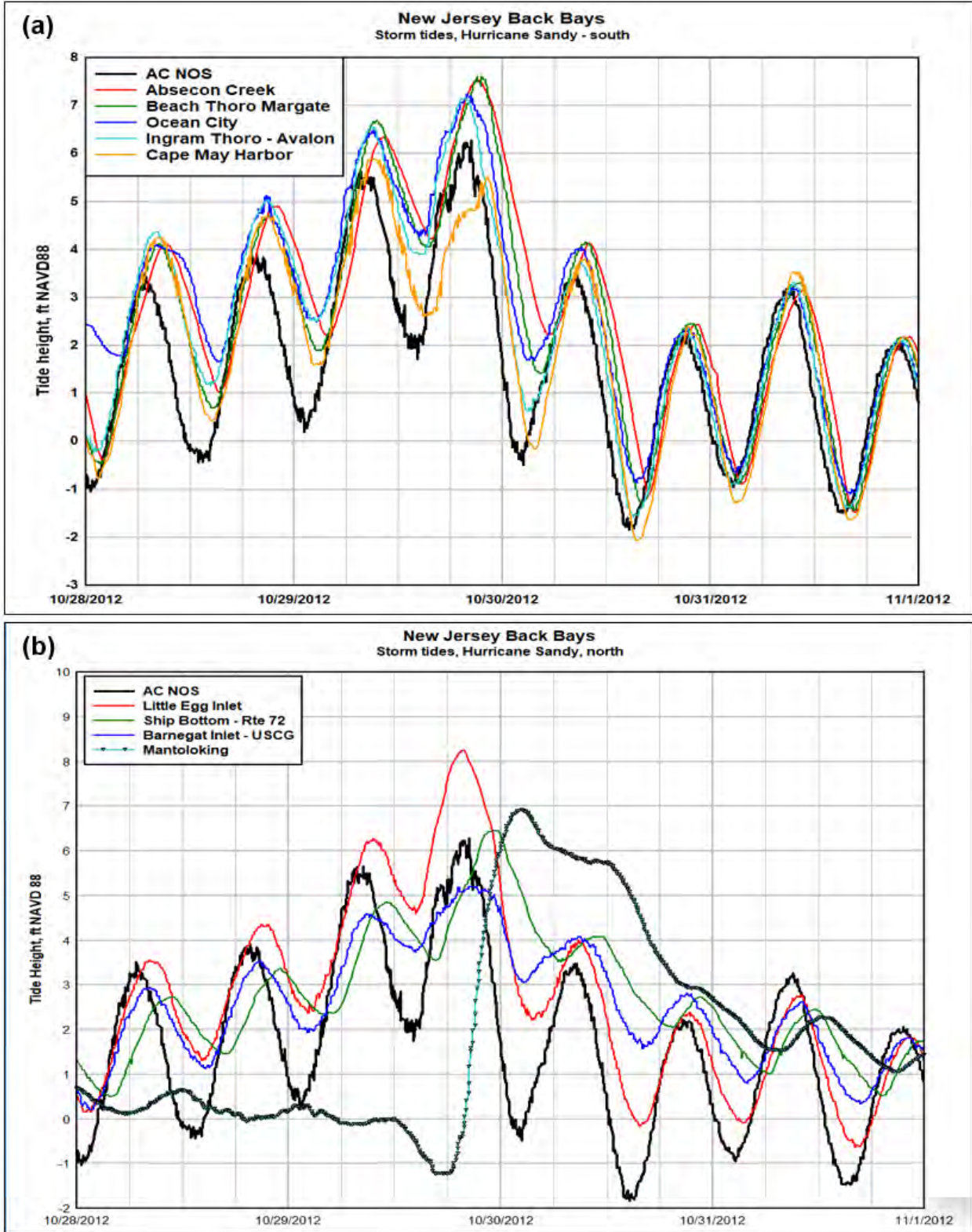

Figure 5-6: Storm water levels for the South (a) and North (b) portions of the NJBB Study Area

5.7 Historical Flooding

The back bays study area has experienced flooding from tropical storms (i.e., hurricanes) and extratropical storms (i.e., nor'easters) for as long as there has been development adjacent to the back bays. Hurricanes are characterized by winds of seventy-five miles per hour or greater and impact the Gulf and Atlantic seabords in the late summer and autumn. Extratropical storms typically develop as strong, low pressure areas over land and move slowly offshore between approximately October through March. The winds, though not necessarily of hurricane force, blow onshore from a northeasterly or easterly direction for sustained periods of time and over very long fetches. **Table 5-5** displays the Top 10 historical storms at Cape May, Atlantic City, and Sandy Hook NOAA tidal stations. Note that the historical water levels have not been adjusted for sea level rise.

Table 5-5: Top 10 Historical Storms at Cape May, Atlantic City, and Sandy Hook NOAA Tidal Stations

Cape May, NJ (since 1965)			Atlantic City, NJ (since 1911)			Sandy Hook, NJ (since 1932)		
Date	Type	Feet NAVD88	Date	Type	Feet NAVD88	Date	Type	Feet NAVD88
23-Jan-2016	E	5.96	11-Dec-1992	E	6.37	29-Oct-2012	T	10.42
29-Oct-2012	T	5.87	14-Sep-1944	T	6.23	12-Sep-1960	T	7.27
27-Sep-1985	T	5.79	29-Oct-2012	T	6.15	11-Dec-1992	E	7.26
29-Oct-2011	E	5.67	27-Sep-1985	T	5.96	28-Aug-2011	T	6.95
25-Oct-1980	E	5.64	31-Oct-1991	E	5.85	7-Nov-1953	E	6.87
11-Dec-1992	E	5.53	6-Mar-1962	E	5.83	6-Mar-1962	E	6.57
4-Jan-1992	E	5.52	9-Aug-1976	T	5.83	14-Sep-1944	T	6.57
3-Mar-1994	E	5.50	25-Nov-1950	E	5.63	13-Mar-2010	E	6.21
28-Aug-2011	T	5.37	29-Mar-1984	E	5.38	25-Nov-1950	E	6.17
14-Oct-1977	T	5.25	23-Jan-2016	E	5.23	12-Nov-1968	E	5.99

Note E: Extratropical; T: Tropical.

Recent storm surge events that have affected the back bays study area include floods associated with Tropical Storm Ida in November 2009, Hurricane Irene in August 2011, Hurricane Sandy in October 2012, and more recently, the nor'easter in January 2016.

The storm surge flooding that occurred in the NJ back bays during Hurricane Sandy and other coastal storm events results principally from the low elevation topography with densely populated residential and commercial areas and extensive low-lying roads and other public infrastructure. The intensity of the flooding ranges from nuisance flooding, typically associated with spring high tides, to severe, albeit less frequent flooding from hurricanes and major nor'easters. In addition, relative sea level in the study area has risen at a rate of 1.3 ft. per century, based on the period of record dating to 1911 at the NOAA/NOS Atlantic City tide gauge. Assuming that this trend continues or accelerates, both nuisance flooding and flooding from storm events will become more frequent and more damaging.

5.8 Historical Shoreline Change

Although there are some locations within the NJ back bays where shoreline erosion has historically posed a problem, coastal storm flooding is the overriding cause of significant economic damages to the study area.

5.9 Exposure and Vulnerability Assessment (Including Critical Infrastructure)

A NJBB exposure and vulnerability assessment was performed for four different inundation scenarios to best assess vulnerability to critical assets in the study area.

The four inundation scenarios included in this analysis are:

- a. Category 4 MOM inundation limits serve as a worst-case inundation scenario for hurricane evacuation planning from a Category 4 hurricane, irrespective of landfall point, forward speed, track direction, or radius of maximum winds. Category 4 MOM inundation values have no exceedance probability associated with them.
- b. FEMA “1 percent probability” inundation limits (also referred to as the “100 year flood plain”). The FEMA 1 percent flood plain is regulated by FEMA and the National Flood Insurance Program manages flood insurance using this recurrence probability.
- c. FEMA “1 percent probability” inundation limits plus sea level rise using the USACE intermediate curve to 2080 which coincides with the 50-year economic future damages, engineering and environmental performance period given a construction baseline of 2030.
- d. High frequency flooding (aka nuisance flooding) map based on the moderate flooding threshold from NWS as presented in NOAA CO-OPS 086 Report. The moderate threshold is differentiated from the additional minor and major flooding thresholds presented in the Report.

The Category 4 MOM (dark blue) and the FEMA 1 percent probability (turquoise) inundation limits are shown on **Figure 5-7** within the NJBB study area.

The “1 percent probability” inundation limits plus sea level rise using the USACE intermediate curve to 2080 inundation limits are shown on **Figure 5-8**. The Hurricane Sandy flooding limits are superimposed in **Figure 5-8** for relative purposes. Note the greater floodplain extent of the projected SLR floodplain that the Hurricane Sandy limits.

The high frequency flooding inundation limits without sea level change for the study regions within the study area shown in **Figure 5-9**, **Figure 5-10**, **Figure 5-11**, and **Figure 5-12**.



New Jersey Back Bay Study

Impacted Area Category 4 MOM and FEMA 100yr Flood Plain

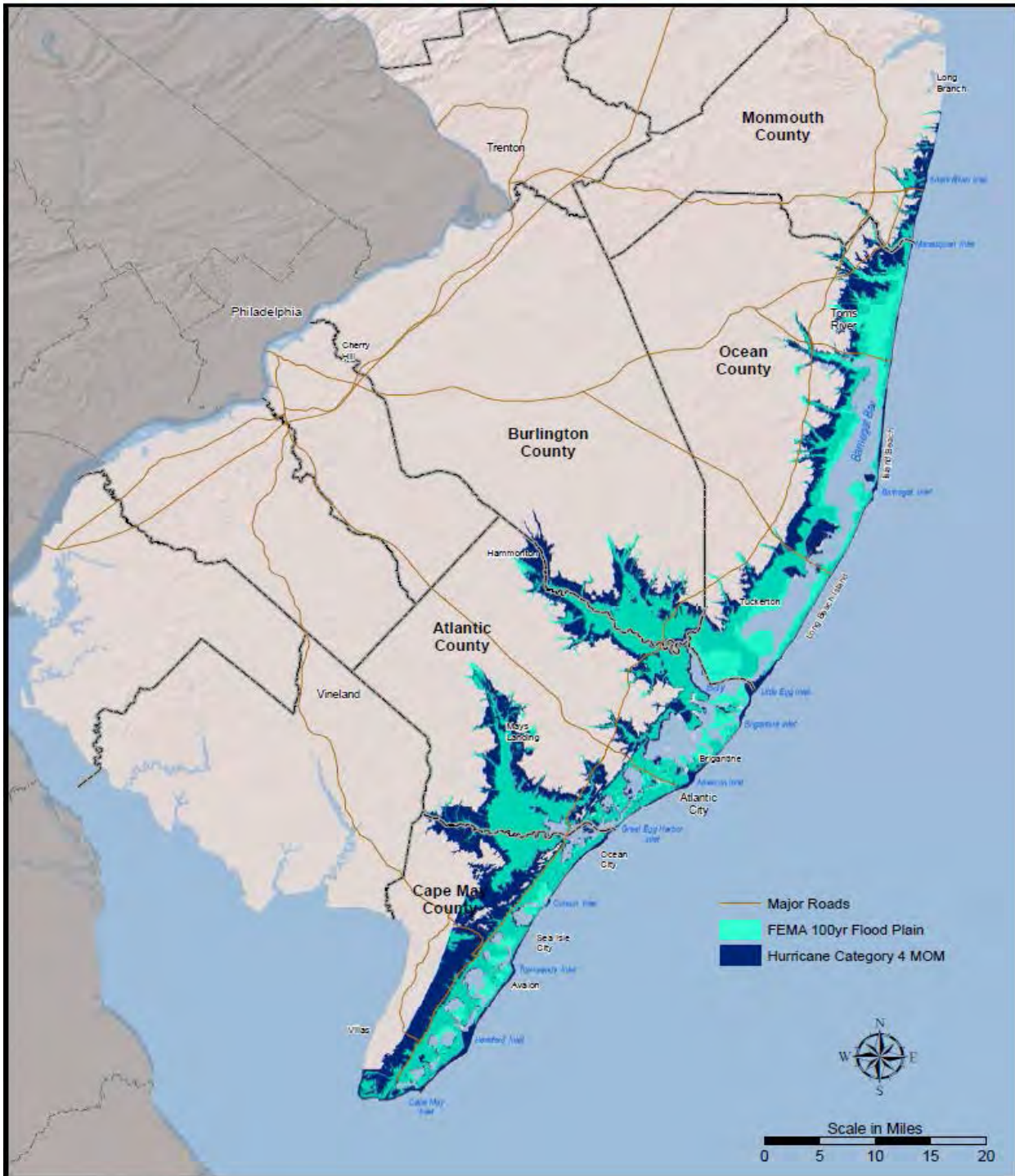

Figure 5-7: NJBB Study Area, Category 4 MOM and FEMA 100yr Flood Plain

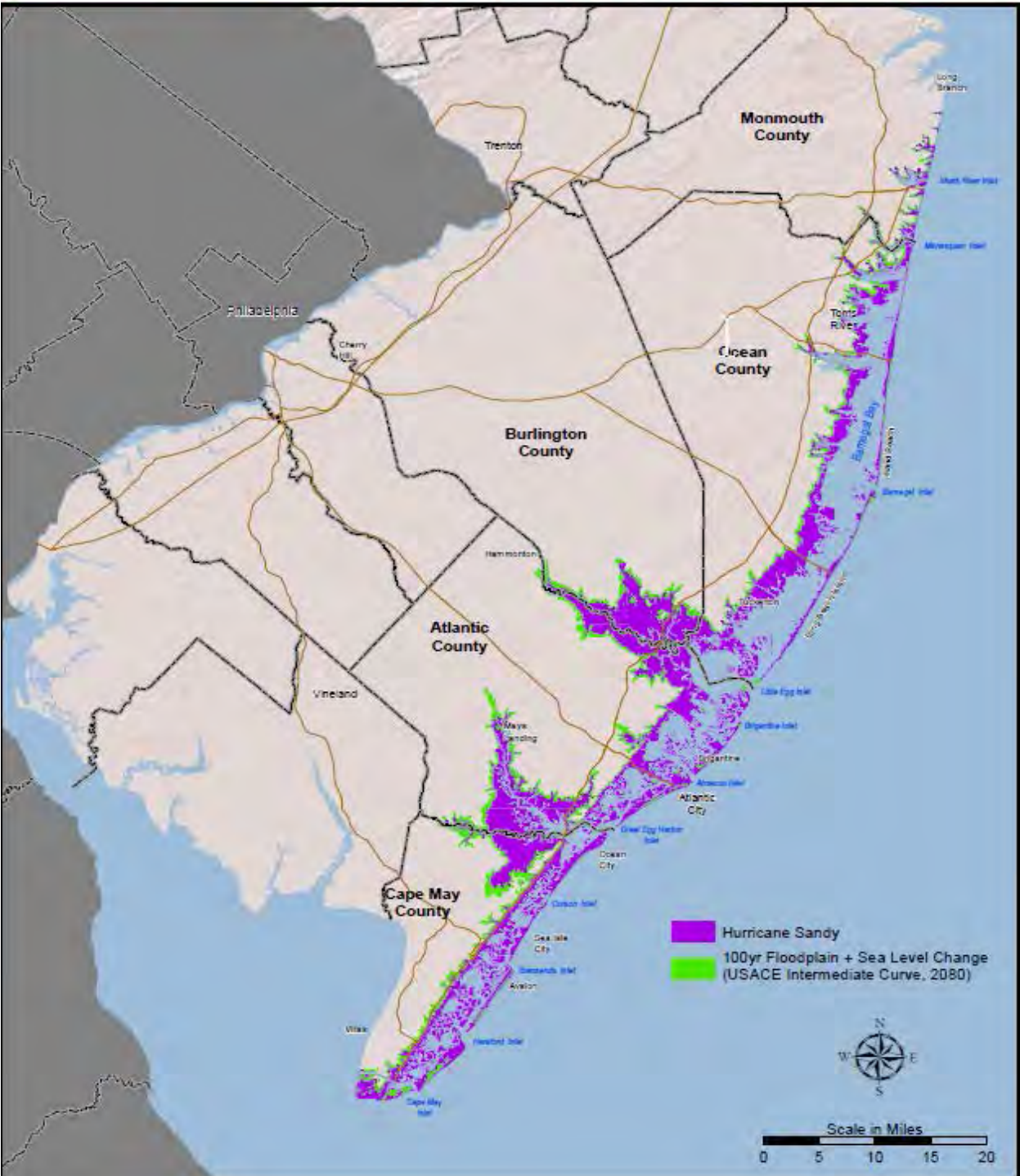

Figure 5-8: NJBB Study Area, Hurricane Sandy impacted area, and FEMA 100yr Flood Plain plus Sea Level Change with USACE Intermediate Curve to 2080



New Jersey Back Bays Study

Coastal Lakes And Shark River Regions -
With The NOAA Moderate Inundation Area



US Army Corps
of Engineers
Philadelphia District

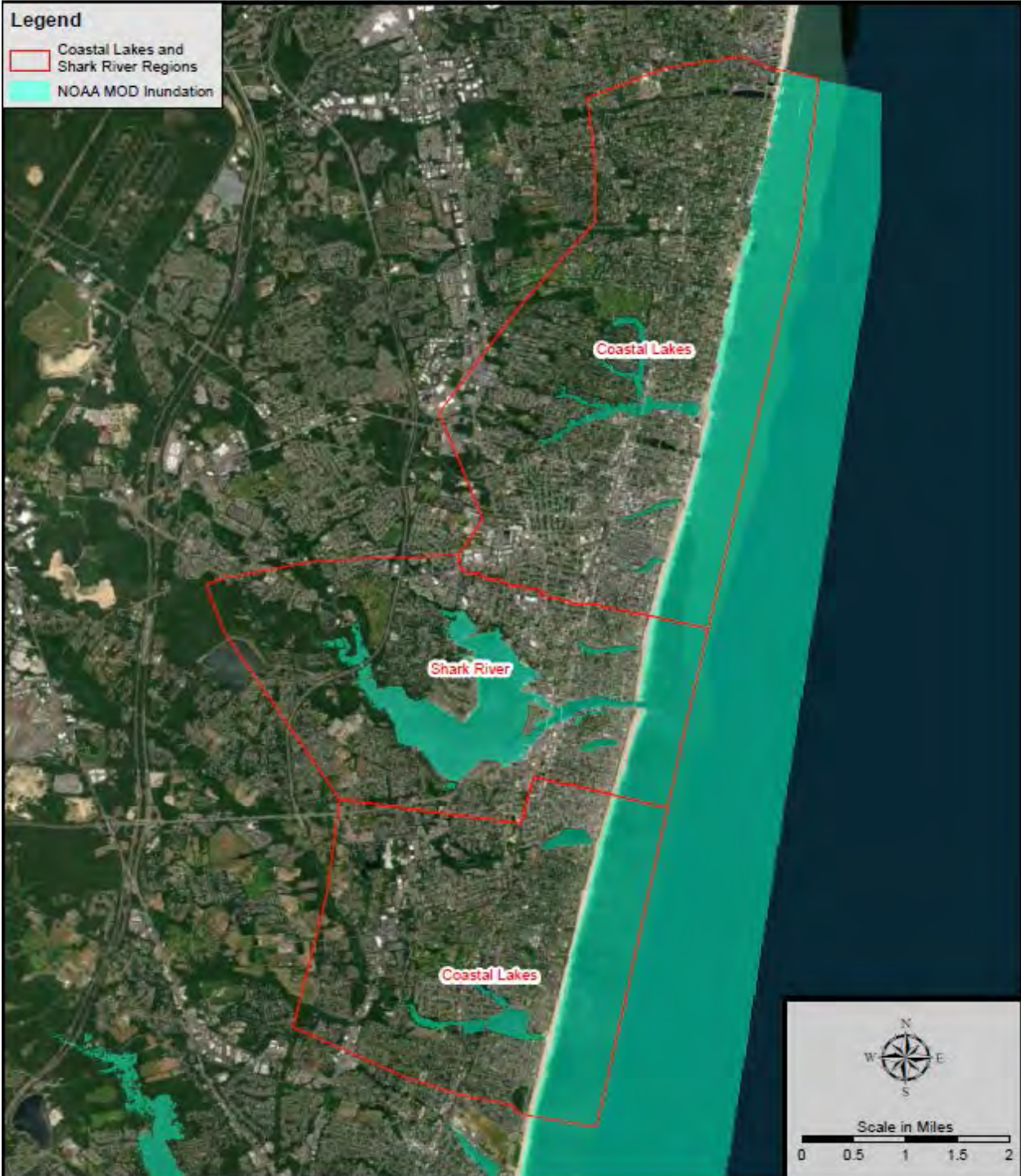

Figure 5-9: NOAA Moderate (MOD) Inundation Area for the Coastal Lakes and Shark River Study Region



New Jersey Back Bays Study

North Region - With The NOAA Moderate Inundation Area

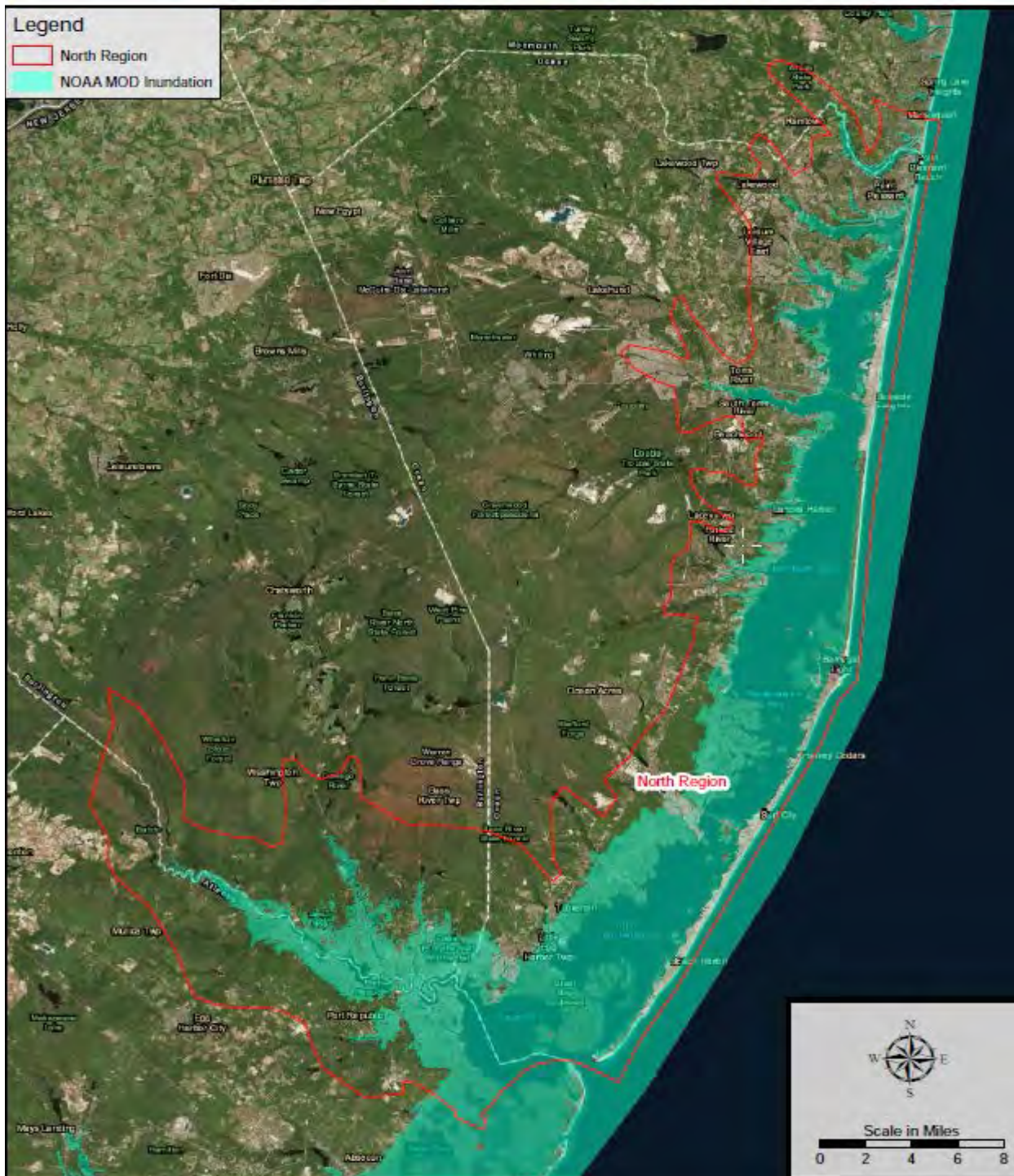

Figure 5-10: NOAA Moderate Inundation Area for the North Study Area

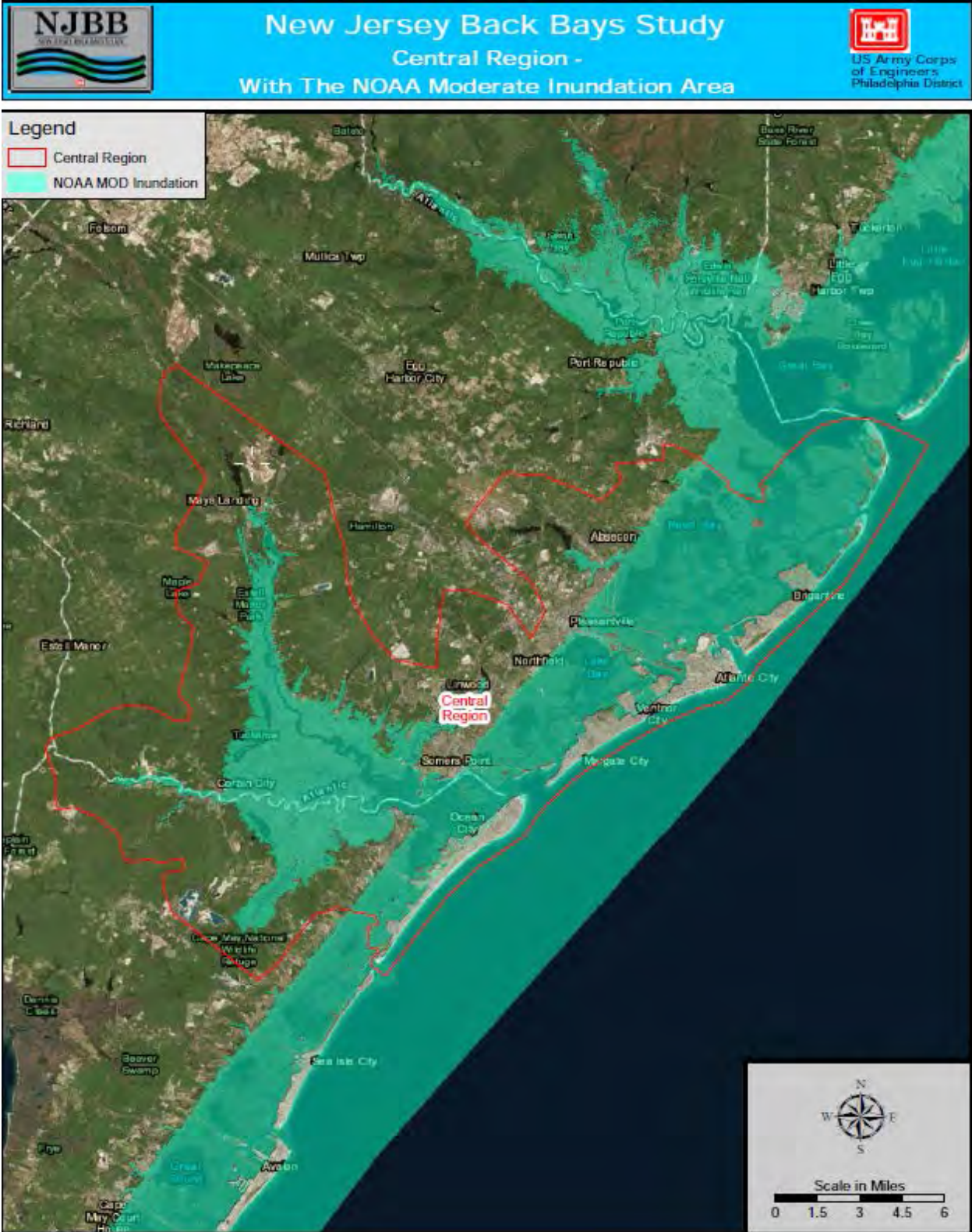

Figure 5-11: NOAA Moderate Inundation Area for the Central Study Region



New Jersey Back Bays Study

South Region -

With The NOAA Moderate Inundation Area



Figure 5-12: NOAA Moderate Inundation Area for the South Study Region

The NJBB Study has developed an exposure assessment for the entire study area to best characterize exposure.

Although a many factors or criteria can be used to identify exposure, the NJBB study focused on the following categories and criteria:

- a. Population Density and Infrastructure: Population density identifies the number of persons per unit area of the study area; infrastructure includes critical infrastructure that supports the population and communities. These factors were combined to reflect overall exposure of the built environment.
- b. Social Vulnerability: Social vulnerability includes certain segments of the population that may have more difficulty preparing for and responding to coastal flood events.
- c. Environmental and Cultural Resources: The environmental and cultural resources exposure captures important habitat and cultural resources that would be affected by storm surge, winds, and erosion.

Using data developed during the NACCS, a composite exposure index was created that integrates population and infrastructure, social vulnerability, and environmental indices (USACE 2015) (**Figure 5-13**). This index identifies areas of high exposure as indicated by the red colors. In summary, much of the NJBB study area is indicated as having high composite exposure.

Table 5-6 shows overview statistics for population (U.S. Census Bureau, 2010), number of residential units, and infrastructure units within the footprint of the Category 4 MOM inundation limits, the FEMA 1% probability inundation limits and the NWS moderate flooding threshold as a representation for high frequency flooding for the study regions.

A closer investigation of impacted critical infrastructure within the Category 4 MOM and the FEMA “1 percent probability” inundation limits are presented for each of the study regions within the study area shown in **Figure 5-14**, **Figure 5-15**, **Figure 5-16**, and **Figure 5-17**.



New Jersey Back Bays Study Composite Exposure Index CAT4 MOM

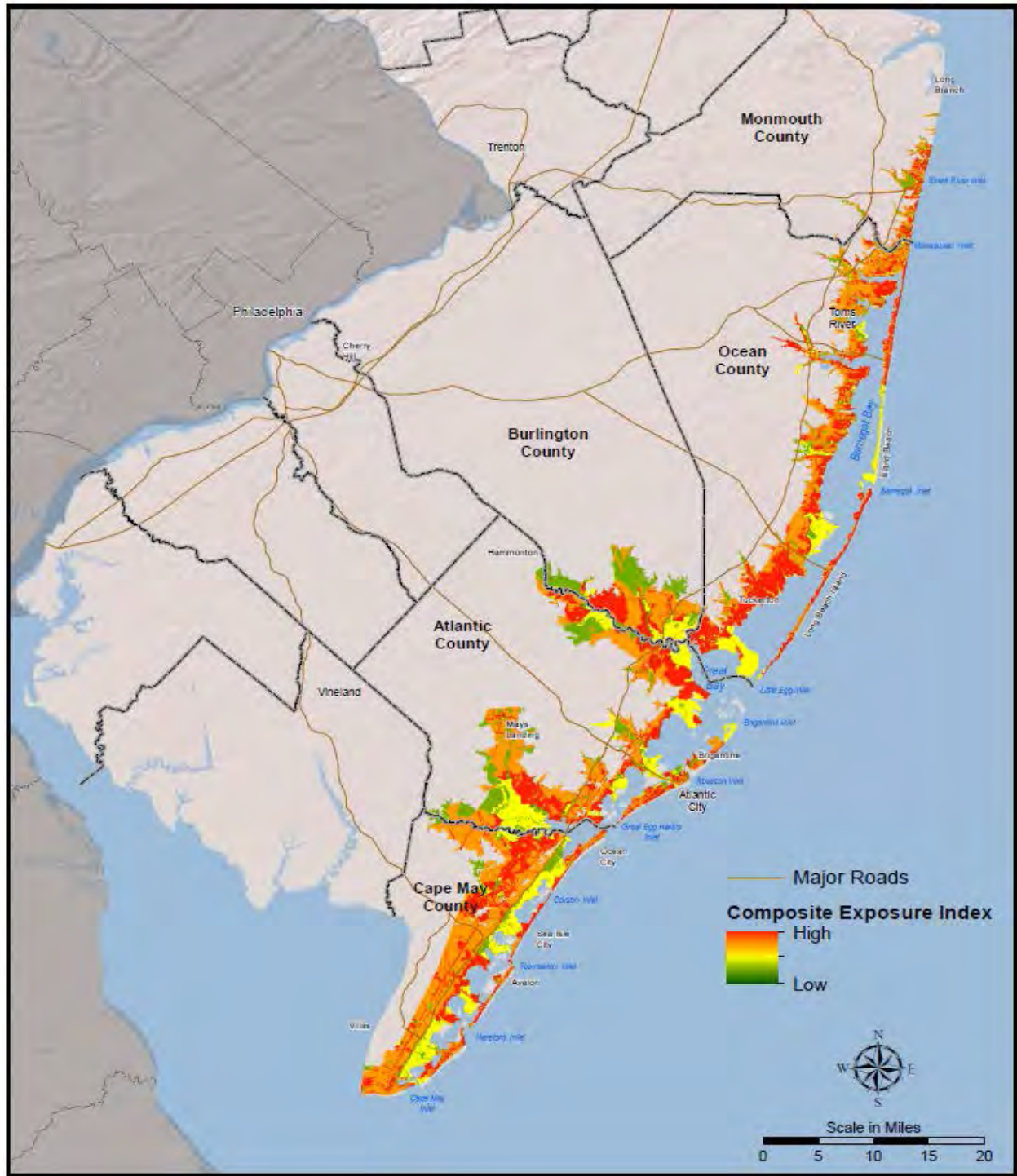

Figure 5-13: NJBB Study Area, Composite Exposure Index CAT 4 MOM

Table 5-6: Population, Housing Units, and Infrastructure included within CAT 4 MOM

REGION	INUNDATION AREA	REGION AREA SQ MILES	POPULATION (Based on 2010 Census)	RESIDENTIAL UNITS	CRITICAL INFRASTRUCTURE UNITS
Shark River and Coastal Lakes	Region	31	86,576	7,386	124
	CAT 4 MOM		44,839	7,386	54
	100 year floodplain		5,502	2,777	8
	NOAA Moderate flooding threshold		528	18	0
Northern	Region	536	325,123	82,070	309
	CAT 4 MOM		196,759	81,749	176
	100 year floodplain		100,789	69,357	57
	NOAA Moderate flooding threshold		15,122	3,676	2
Central	Region	312	185,606	47,452	225
	CAT 4 MOM		135,439	47,448	146
	100 year floodplain		97,211	45,145	90
	NOAA Moderate flooding threshold		9,955	1,440	2
South	Region	146	48,268	36,937	97
	CAT 4 MOM		46,745	36,937	95
	100 year floodplain		26,600	33,798	45
	NOAA Moderate flooding threshold		4,097	2,286	1

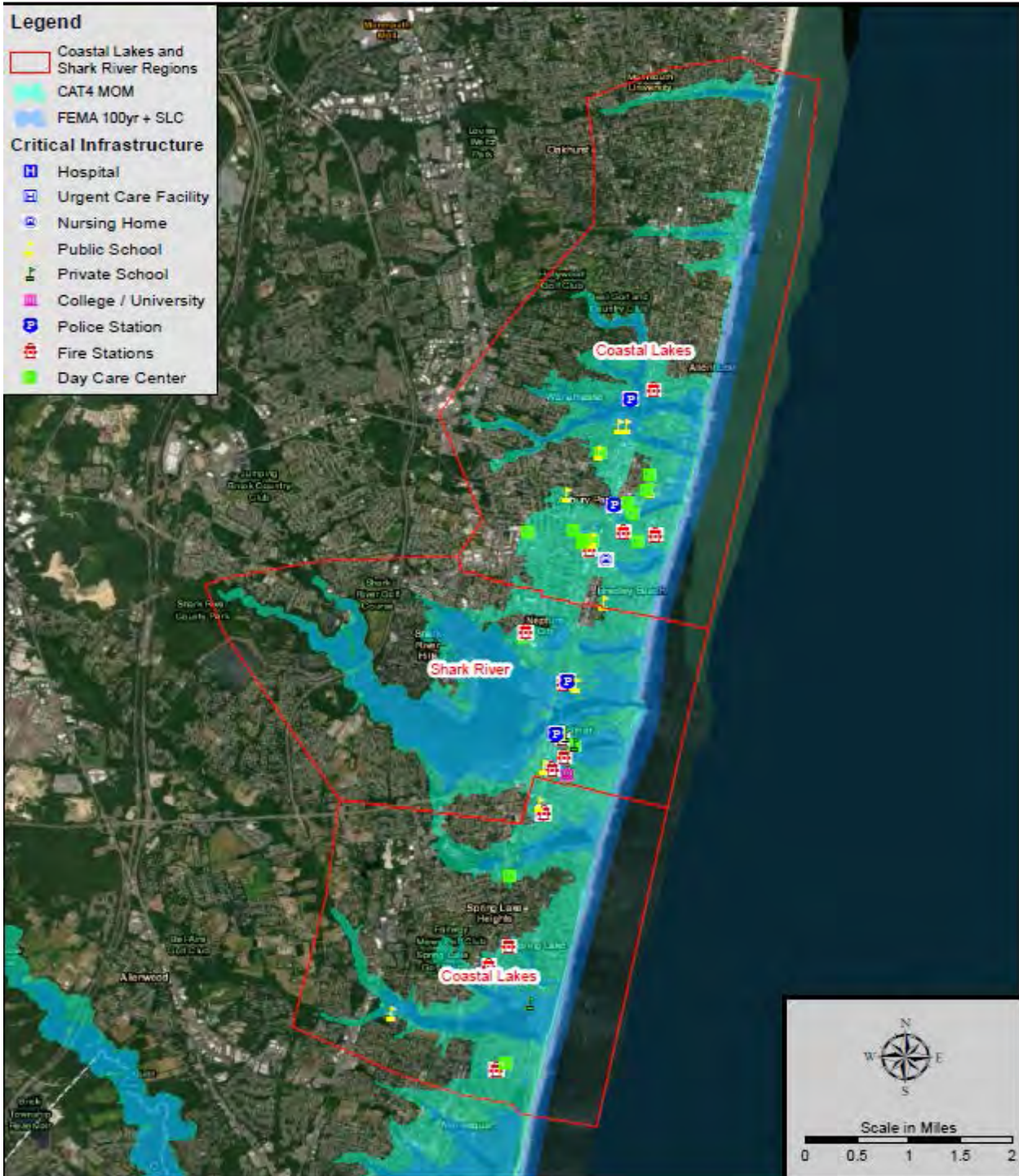

Figure 5-14: Impacted Critical Infrastructure in the Coastal Lakes and Shark River Study Regions within the CAT 4 MOM and FEMA 1% Probability Inundation Limits

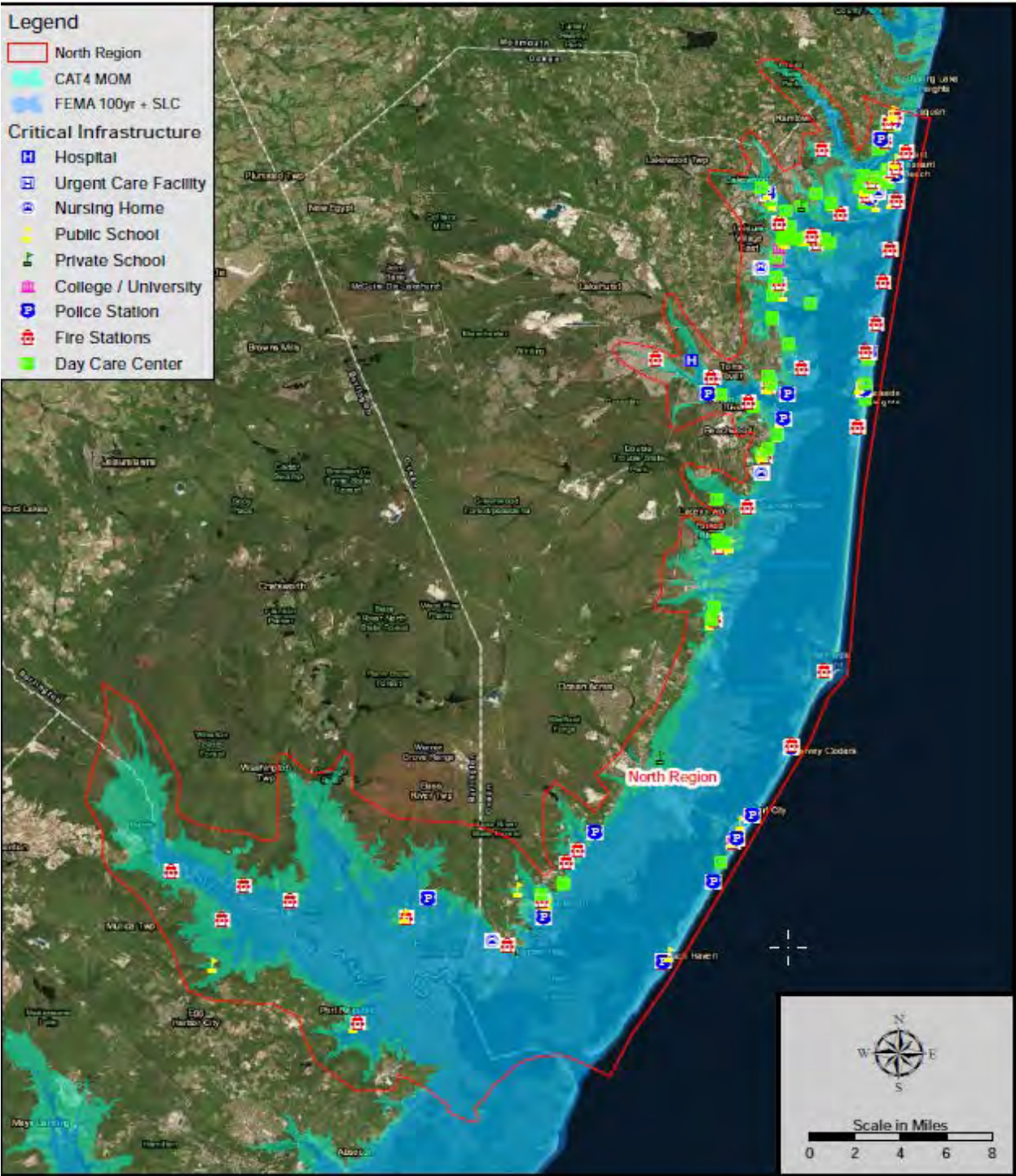

Figure 5-15: Impacted Critical Infrastructure in the North Study Region within the CAT 4 MOM and FEMA 1% Probability Inundation Limits

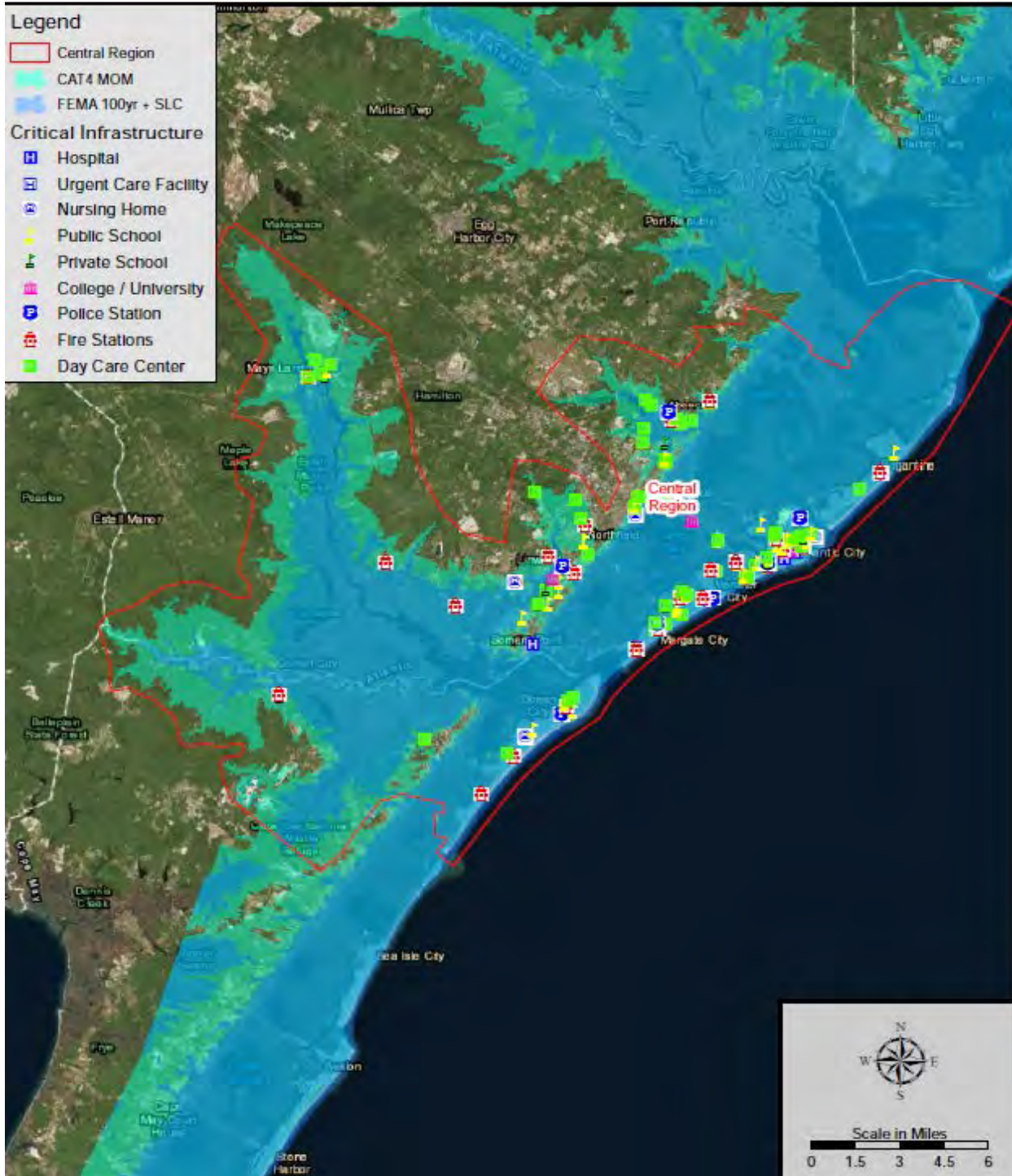

Figure 5-16: Impacted Critical Infrastructure in the Central Study Region within the CAT 4 MOM and FEMA 1% Probability Inundation Limits

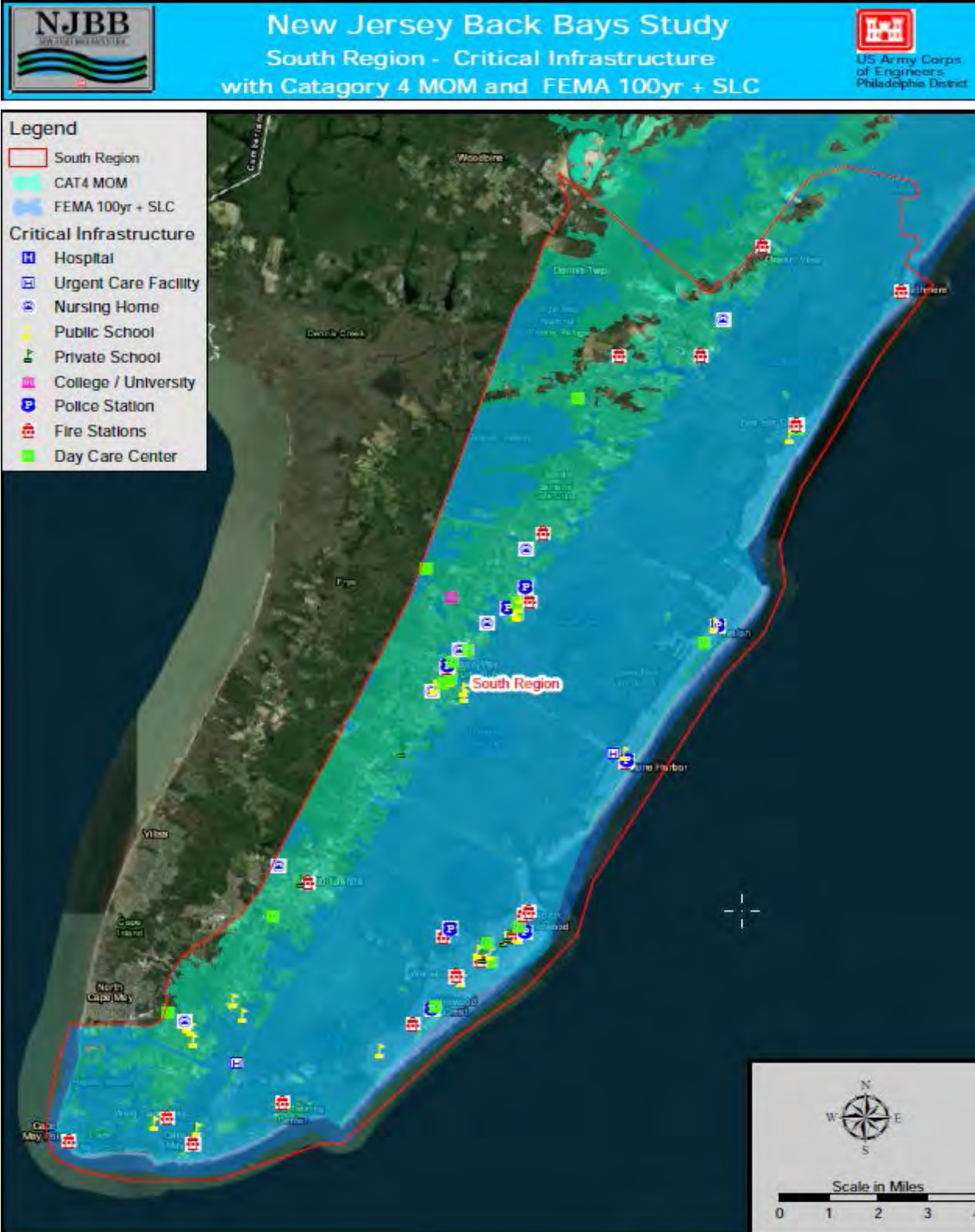

Figure 5-17: Impacted Critical Infrastructure in the South Study Region within the CAT 4 MOM and FEMA 1% Probability Inundation Limits

6 Affected Environment and Cultural Resources

6.1 Affected Environment

The Back Bays of New Jersey comprise a vast and rich coastal ecosystem which includes: barrier islands; beaches and dunes; salt, brackish, and freshwater marshes; tidal mud flats and maritime forests; rocky shorelines; submerged aquatic vegetation; oyster and rock reefs, shallow bays and bay islands; terrestrial uplands, flood plains, and riparian zones. These habitats contain a remarkable array of biodiversity and are recognized as an important ecological resource for migratory birds including waterfowl, wading birds, shorebirds, and other species that depend upon these areas during their lifetime. Significant habitats along the coast include coastal wetlands, water bird islands, and Essential Fish Habitat (EFH). The entire study area is part of the Atlantic Flyway which is home to 32 priority bird species.

In general, from an environmental standpoint, habitats will be subject to more stress in the future resulting from human population increases, climate change, sea level rise, and other effects.

Additional detail regarding the environment which could be affected by the NJBB CSR Study can be found in the Environmental and Cultural Resources Appendix F.

6.1.1 Land Use

The NJBB study area encompasses five coastal counties with a diverse array of land uses that are guided by comprehensive master plans for each county. With the exception of public lands, the beach communities along the coast including headland and barrier islands contain the most intense development in the upland areas consisting of residential (seasonal) homes, commercial – tourist oriented (amusement areas, marinas, and various smaller attractions and facilities), and some light industrial uses such as fishing related industry. In the coastal barrier complex areas, the mainland areas are generally separated by vast wetlands and open water bays. The mainland communities also include dense residential, commercial development, transportation, utilities services and some sporadic industrial development. Other land uses inland include woodland, farmland, and freshwater and tidal wetlands. Monmouth County is the northernmost county within the study area, which includes the beaches and coastal waters north of Manasquan Inlet, Shark River Inlet, and the Coastal Lakes Region of the study area. The Monmouth County Master Plan (Monmouth County Division of Planning, 2016) tracked land use changes between 1986 and 2012, and determined that the largest land use change was attributed to a growth in residential uses of 6.7% within that time period, which also saw a net decrease of 6.4% in agricultural land uses. Similar trends where urban lands (residential and commercial) saw net increases and agricultural lands saw net decreases were noted in Ocean County, Atlantic County and Cape May County. Ocean County experienced a 7.8% loss of farm land and a 7.7% gain in urban land from 2002 to 2007 (Ocean County Planning Board, 2011), and Atlantic County likewise lost 6.4% of agricultural land and 42.6% of barren land with a net gain of 14% of urban land from 2002 to 2012 (Heyer, Gruel & Associates, 2018). Recognizing the importance of farmlands and open space, all of the county comprehensive plans include goals to preserve farmlands and to acquire more open space for the communities.

New Jersey is a home rule state which means that much of the land use decisions are governed at the local municipal level.

6.2 Protected Lands

6.2.1 NJ State Coastal Zone

The entire study area falls within New Jersey's coastal zone, which is defined in N.J.A.C. 7:7, and provides rules for the NJDEP regarding the use and development of coastal resources that are reviewed by the Land Use Regulation Program in reviewing permit applications under the Coastal Area Facility Review Act (CAFRA), N.J.S.A. 13:19-1 et seq. (as amended 2016), Wetlands Act of 1970, N.J.S.A. 13:9A-1 et seq., Waterfront Development Law, N.J.S.A. 12:5-3, Water Quality Certification (401 of the Federal Clean Water Act), and Federal Consistency Determinations (307 of the Federal Coastal Zone Management Act).

The extent of the New Jersey coastal zone includes lands defined in 1. The Coastal Area Facility Review Act (CAFRA), N.J.S.A. 13:19-1 et seq.; 2. Coastal waters, which are any tidal waters of the State and all lands lying thereunder (Coastal waters of the State of New Jersey extend from the mean high water line out to the three geographical mile limit of the New Jersey territorial sea, and elsewhere to the interstate boundaries of the States of New York, and Delaware and the Commonwealth of Pennsylvania); 3. All lands outside of the coastal area as defined by CAFRA extending from the mean high water line of a tidal water body to the first paved public road, railroad or surveyable property line existing on September 26, 1980 generally parallel to the waterway, provided that the landward boundary of the upland area shall be no less than 100 ft. and no more than 500 ft. from the mean high water line; 4. All areas containing tidal wetlands; and 5. The Hackensack Meadowlands District as defined by N.J.S.A. 13:17-4.

6.2.2 Coastal Barrier Resources Act Areas

The Coastal Barrier Resources Act (CBRA) of 1982 is intended to protect fish and wildlife resources and habitat, prevent loss of human life, and preclude the expenditure of Federal funds that may induce development on coastal barrier islands and adjacent nearshore areas. The CBRA established the Coastal Barrier Resources System (CBRS), which consists of mapping of those undeveloped coastal barrier islands and other areas located on the coasts of the U.S. that were made ineligible for most Federal expenditures and financial assistance. Otherwise protected areas (OPAs) are a separate designation where the only Federal funding prohibition is Federal flood insurance. Other restrictions to Federal funding that apply to CBRS units do not apply to OPA's. Within the NJBB study area, there are 2 existing CBRS units in Barnegat Bay, 1 CBRS unit located at Hereford Inlet and 7 OPA's located throughout the study area (**Table 6-1**). Additionally, the US Fish and Wildlife Service prepared "Draft Revised" CBRA maps, which include a number of proposed changes to existing CBRS units and OPAs within the NJBB study area; however, these changes require Congressional authorization. Maps of the existing CBRA areas and "Draft Revised" areas are presented in the Environmental and Cultural Resources Appendix F.

Table 6-1: CBRS Units and OPAs in NJBB Study Area

ID	Location	CBRS Unit	OPA
NJ-04B*	Metedeconk Neck/Barnegat Bay west of Mantoloking	X	
NJ-04BP [†]	Edwin B. Forsythe NWR on Metedeconk Neck/Barnegat Bay west of Mantoloking		X
NJ-05P*	Island Beach State Park/Barnegat Bay & Inlet		X
NJ-06*	Cedar Bonnet Island west of Ship Bottom/S. of Rt. 72	X	
NJ-06P [†]	Cedar Bonnet Island west of Ship Bottom/S. of Rt. 72 and Egg Island		X
NJ-07P*	Edwin B. Forsythe NWR and Little Egg Harbor Inlet		X
NJ-19P**	Great Egg Harbor Inlet		X
NJ-08P*	Corson Inlet/Corson Inlet State Park, Strathmere Natural Area and west.		X
NJ-08**	West of Corson Inlet and Strathmere	X	
NJ-09*	Hereford Inlet/Stone Harbor Point/North Wildwood and west.	X	
NJ-09P [†]	West of Hereford Inlet		X
NJ-10P*	Lower Cape May Meadows – Atlantic Coast		X
NJ-11P*	Cape May Canal (Delaware Bay)		X
*Includes changes in boundary designations in “Draft Revised” maps			
[†] Includes changes in designation from an OPA to a System Unit in “Draft Revised” maps			
** Is a new designated CBRS unit or OPA in “Draft Revised” maps			

6.2.3 National Wildlife Refuges

The largest and most significant protected lands in the study area include E.B. Forsythe National Wildlife Refuge and Cape May National Wildlife Refuge. The E.B. Forsythe National Wildlife Refuge encompasses approximately 47,000 acres in two divisions (Brigantine Division and Barnegat Division) that are distributed in a patchwork along more than 50 miles of the coast in Atlantic, Burlington, and Ocean Counties. The Cape May National Wildlife Refuge encompasses approximately 11,800 acres within the Cape May Peninsula. It is divided into three main divisions: Great Cedar Swamp Division, Delaware Bay Division, and the Two-Mile Beach Unit.

6.2.4 Parks and Wildlife Management Areas

Other protected areas found within the study area include: Corson’s Inlet State Park, Cape May Point State Park, The Nature Conservancy’s South Cape May Meadows Nature Preserve, Island Beach State Park, Barnegat State Park, Great Bay Boulevard State Wildlife Management Area, Manahawkin Wildlife Management Area, and numerous county and municipal parklands.

6.2.5 State Natural Areas

There are eight state natural areas designated under N.J.A.C. 7:5A within the NJBB Study Area. Natural Areas receive an exceptional degree of protection. Lands in the Natural Areas system may not be sold, leased or exchanged, and they may not be altered in any way without the approval of the NJDEP. Several key State Natural Areas within the NJBB area are located at Island Beach State Park, North Brigantine, Strathmere and Cape May Wetlands.

6.2.6 National Reserves

Portions of the NJBB study area fall within the Federal Pinelands National Reserve (PNR), which was created by the National Parks and Recreation Act of 1978. The PNR is approximately 1.1 million acres within 7 counties in New Jersey occupying 22% of New Jersey's land area.

The Jacques Cousteau National Estuarine Research Reserve (JC NERR) is part of the National Estuarine Research Reserve System (NERRS) developed to protect the biologically, ecologically, economically, and aesthetically important estuarine areas along the coasts. It is one of the 2 national estuarine reserves created to promote the responsible use and management of the nation's estuaries through a program combining scientific research, education, and stewardship. The JC NERR encompasses approximately 116,000 acres in southeastern New Jersey, including a great variety of terrestrial, wetland and aquatic habitats within the Mullica River-Great Bay ecosystem (retrieved from <https://jcnerr.org/about.html> on 1/25/2019).

6.2.7 Wild and Scenic Rivers

The National Wild and Scenic Rivers System was created by Congress in 1968 to preserve certain rivers with outstanding natural, cultural, and recreational values in a free-flowing condition for the enjoyment of present and future generations. The Act is notable for safeguarding the special character of these rivers, while also recognizing the potential for their appropriate use and development. It encourages river management that crosses political boundaries and promotes public participation in developing goals for river protection. The Great Egg Harbor River is located within the NJBB study area, and was designated as a Wild and Scenic River in October 27, 1992. In the NJBB study area, Wild and Scenic River status of the Great Egg Harbor River and tributaries are generally west of the Garden State Parkway. Key drainages that are part of the system include Patcong Creek and the Tuckahoe River at near the confluence west of the Garden State Parkway.

6.2.8 National Estuary Programs

The Barnegat Bay Program (BBP) is one of 28 national estuary programs administered by the Environmental Protection Agency program to protect and restore the water quality and ecological integrity of estuaries of national significance. The BBP is guided by the Comprehensive Conservation and Management Plan (CCMP) that focuses on four priority areas: water quality, water supply, living resources, and land use. For each priority, the plan will specify one or more goals, several objectives, and multiple actions to achieve those objectives.

6.3 Floodplains

Through Executive Order (EO) 11988, Federal agencies are required to evaluate all proposed actions within the 1% annual chance (100-year) floodplain. Actions include any Federal activity involving 1) acquiring, managing, and disposing of Federal land and facilities, 2) providing Federally undertaken, financed, or assisted construction and improvements, and 3) conducting Federal activities and programs affecting land use, including but not limited to water and related land resources planning, and licensing activities. In addition, the 0.2% annual chance (500-year) floodplain should be evaluated for critical actions or facilities, such as storage of hazardous materials or construction of a hospital. The EO provides an eight-step process to evaluate activities in the floodplain that generally includes 1) determine if the proposed action is in the floodplain, 2) provide public review, 3) identify and evaluate practicable alternatives to locating in the 1% annual chance floodplain, 4) identify the impacts of the proposed action, 5) minimize threats to life and property and to natural and beneficial floodplain values and restore and preserve natural and beneficial floodplain values, 6) reevaluate alternatives, 7) issue findings and a public explanation, and 8) implement the action. Proposed actions may have limited impacts such that the eight-step process may vary or be reduced in application, which is the case for this project.

FEMA defined Flood Zones are predominantly high risk areas, designated by Zone AE, along the inland side of the barrier islands and the upland side of the bays. Base Flood Elevations associated with the AE Zones generally range from about 5 to 12 ft. NAVD88. There are several high risk coastal areas that carry an additional hazard associated with storm waves, designated by Zone VE, which vary greatly in location and severity. Base Flood Elevations associated with the VE Zones generally range from 9 to 16 ft. NAVD88 but go as high as 29 ft. NAVD88.

More frequent flood events were analyzed for structure counts due to the high number of structures in the study area. There are approximately 31,000 structures below the elevation of the 5% Annual Chance of Exceedance (ACE) flood event as defined by the North Atlantic Coast Comprehensive Study (NACCS). For the 10% ACE and 20% ACE, the number of structures is about 17,000 and 8,000 respectively.

Land elevations vary greatly throughout the study area. Generally, developed areas in the southern portion of the project area are on lands below 20-ft NAVD88. In these areas, the inland side of the barrier islands is generally at or below about 10-ft NAVD88 and the upland side of the bay is generally at or below about 20-ft NAVD88. The same is generally true in the northern portion of the project area, but there are more developed lands in the 20 to 30-ft NAVD88 range.

In the study area, there are approximately 183,000 structures with over \$90 billion in damageable assets, critical infrastructure, and utilities. These structures are located in 84 separate municipalities across five counties. Of the total structures, approximately 95% are classified as residential structures. The other 5% are classified as non-high rise commercial, industrial or public facilities.

6.4 Geology and Soils

The study area lies entirely within the Atlantic Coastal Plain, which extends along the east coast of the U.S. from Massachusetts to Florida. The Coastal Plan consists of unconsolidated sands, silts, clays, and marls with the Cohansey and Kirkwood sand formations being prevalent in the

area. The Coastal Plain sediments in this region are underlain by gneiss and schist. This basement complex slopes toward the Atlantic Ocean from a depth of about 1,100 ft. in New Egypt (in NW Ocean County) to over 5,000 ft. at the Atlantic Ocean. The bedrock formations were worn to a peneplain which slopes toward the Atlantic Ocean and were subsequently warped so that the Coastal Plain is depressed to the southeast. This resulted in the deposition of eroded material from the northern mountains.

The soils within the study area are varied, ranging from deep fertile soils to droughty infertile soils with little humus or organic material present to organic tidal marshes, urban lands, and barrier island beach. In Monmouth County, the Natural Resources Conservation Service (NRCS) features 43 agronomic soil series and 114 types or subtypes. Soils associations encountered within the study area include the Klej-Galestown-Evesboro-Downer, Lakewood-Lakehurst-Evesboro-Atsion and Hooksan-Psamments-Udorhents along the coast. The NRCS recognizes 32 soil series, with 85 types or subtypes in Ocean County (USDA 1980) where the dominant soil associations for the project area includes the Downer-Evesboro and Sulfaquents-Sulfihemists associations. The Downer-Evesboro association consists of well-drained and excessively drained, loamy and sandy soils on uplands that are nearly level and gently sloping. The Sulfaquents-Sulfihemists association consists of poorly drained, mineral and organic soils on tidal flats and marshes that are nearly level.

The southeast corner of Burlington County is within the study area that includes outer coastal plain soils within the lower Mullica River watershed composed predominantly of the Downer-Sassafras-Woodstown association, which are mostly sandy loams and fine sandy loam subsoils and the Tidal Marsh association composed of organic silts subjected to daily flooding.

In Atlantic County, dominant soils within the study area are composed of the Appoquinimink-Transquaking-Mispillion (ATM)-Psamments-Hooksan-Urban Association, which contains nearly level, poorly drained tidal flats; nearly level excessively drained sandy fill land; and nearly level or gently sloping, excessively drained coastal beaches. The ATM soil series is located in areas near sea-level that are flooded twice daily by tidal waters and occupies about 16% of Atlantic County soil types. Psamments are located where several ft. of sandy fill was placed on top of ATM soils to create developable land. Hooksan-Urban soils are located along the barrier beaches and includes areas that have been highly urbanized (Heyer, Gruel & Assoc., 2018).

In Cape May County, the barrier islands are composed of the heavily developed Coastal-Urban (CU) soil association and other fill lands (FL/FM) from tidal marshes converted to uplands. The tidal wetlands in the back bay marsh areas are Tidal Marsh (TM) association of various thicknesses of organic matter. Further inland and west, the dominant soil associations are the Downer-Sassafras-Fort Mott Association and Hammonton-Woodstown-Klej Association, which are high and intermediate landscape sandy loams and loamy sand soils found along the Garden State Parkway.

6.5 Watersheds

The New Jersey Back Bays are part of the New Jersey Atlantic Coast Water Region, which are heavily influenced by the freshwater inputs from a number of major river systems and smaller tributaries often originating as headwaters in the New Jersey Pinelands. These freshwater tributaries generally enter from the west where they meet tidally influenced polyhaline waters from the Atlantic Ocean that enter through the coastal inlets. The back bays are generally semi-

enclosed estuaries bounded by the barrier islands and/or adjacent headlands. Five major watershed management areas (WMA) form the Atlantic Coast Water Region, however, the NJDEP now assesses water quality in individual subwatersheds as Assessment Units (AU's) at the USGS HUC 14 level. The watershed management areas within the NJBB study area include:

Monmouth Watershed Management Area (WMA 12) – in NJBB, major tributaries are Shark River and Manasquan River.

Barneget Bay Watershed Management Area (WMA 13) – Major tributaries into Barneget Bay and Little Egg Harbor, Westecunk Creek include: Metedeconk River, Kettle Creek, Toms River, Cedar Creek, Forked River, Oyster Creek, Manahawkin Creek, Mill Creek, and Tuckerton Creek.

Mullica River Basin (WMA 14) – Great Bay major tributaries include: Batsto River, Atsion (upper Mullica) River, Sleeper Branch, Nescocheague Creek, Hammonton Creek, Bull Creek, Wading River, Bass River, Landing Creek and Nacote Creek.

Great Egg Harbor River Basin (WMA 15) – Major tributaries that drain into Great Egg Harbor Bay, Reeds Bay, Absecon Bay, Little Bay, Lakes Bay, Scull Bay, and Peck Bay include Great Egg Harbor River, Tuckahoe River, South River, Stephen Creek, Gibson Creek, Middle River, Babcock Creek, Gravelly Run, English Creek, Lakes Creek, and Patcong Creek.

Cape May Water Management Area (WMA 16) – No major tributaries in NJBB area. System of interconnected tidal bays and sounds including: Corson Sound, Ludlam Bay, Townsend Sound, Stites Sound, Great Sound, Jenkins Sound, Grassy Sound, Richardson Sound, Sunset Lake, Jarvis Sound, and Cape May Harbor.

6.6 Water Quality

Water quality is a primary determinant of habitat quality for fish and wildlife, and also affects recreational opportunities in regional water bodies and overall aesthetics of a water body. Water quality within the coastal waters of the New Jersey Atlantic Coast was comparable to that of similar coastal water bodies along the New York Bight and was indicative of similar coastal tidal river and estuary complexes along the Mid-Atlantic coast (USFWS, 1997). NJDEP (2017) summarizes that the coastal waters and estuaries of NJ were generally good for recreation and shellfish harvesting. However, there remain some areas where dissolved oxygen does not meet water quality criteria, which is a concern relative to aquatic life support particularly in Barneget Bay. The quality of water in this coastal region is dependent largely on the influence of the major coastal freshwater rivers that flow into the bays that make up the study area reaches (e.g. the Mullica River empties in the Great Bay). Other factors that influence water quality over time include tides, time of year, ocean current fluctuations, nutrient enrichment, water depth, biotic communities, and other temporal and spatial variables. The results of prior studies conducted on the bays and estuaries within the study area indicate that the water quality has historically been impacted by pollutants such as nutrients, pathogens, heavy metals (cadmium, lead, and zinc) and fecal coliform bacteria. (USACE, 1998; BBEP, 2001; Zimmer and Groppenbacher, 1999) As a result, habitat for fish and wildlife has been degraded in many areas relative to historical pre-developed conditions. In recent years, however, improvements in water quality have been seen in the region resulting from implementation of the Clean Water Act, and state programs such as discharge permitting programs, coupled with improvements in wastewater treatment technology.

The U.S. EPA maintains a web-based information system that allows the user to access pollution information from a search based on a locality. A search was conducted on the “How’s My Waterway” maps for the NJBB study area. With the exception of waters around Little Bay, Great Bay, Little Egg Harbor, and Southern Barnegat Bay, most of the waters were designated as polluted. These designations are based on State of NJ Water Quality Monitoring programs.

The NJBB study area is within the Atlantic Coast Region (ACR) for water quality monitoring, assessment, and management by the NJDEP. The Atlantic Coast Region is further divided into smaller assessment units (AU’s) that are based on the USGS Hydrologic Unit Code (HUC) 14 watershed level. Section 305(b) of the Clean Water Act requires states to report attainment of designated water uses, which include: Aquatic Life – General, Aquatic Life – Trout, Recreation, Water Supply, and Shellfish. A multitude of parameters are used to assess the water quality and designated uses, which include pathogens, nutrients, dissolved oxygen and toxics. The ACR consists of 293 AUs covering 2,962 square miles, 5,812 miles of nontidal and tidal rivers, 6,632 square acres of lakes/reservoirs, and 745 square miles of estuaries/bays and ocean waters. Use assessment results for the ACR’s 293 assessment units (AUs) showed that water quality is generally better in the ACR than water quality statewide. Both statewide and ACR assessment results showed that public water supply and recreation uses had the highest percentage of use support; moreover, the relative percentage of all AUs fully supporting applicable designated uses was generally higher in the ACR. **Figure 6-1** shows the number of AUs that fully support applicable designated uses in each Water Region. The ACR has the highest number of fully supported designated uses (274 AU/use combinations) of the New Jersey’s Water Regions, followed by Lower Delaware (156), Northwest/Upper Delaware (146), Raritan (100), and Northeast (70) (NJDEP, 2017). **Table 6-2** provides a breakdown of percentages of AUs that meet and do not meet designated uses within the ACR.

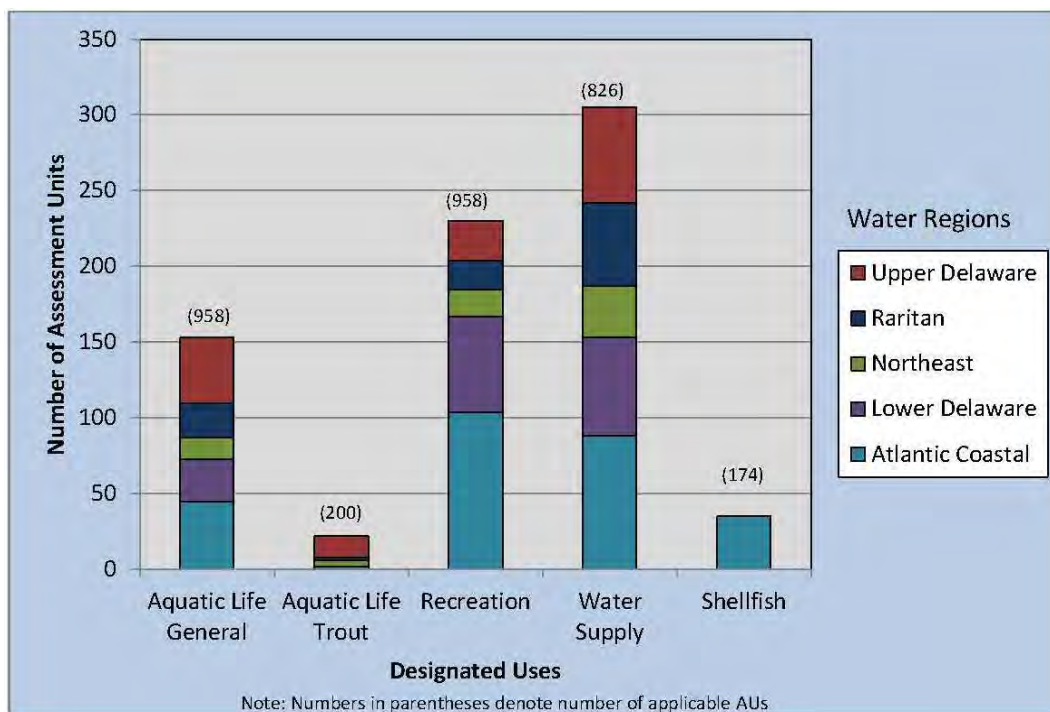

Figure 6-1: Number of AU's Fully Supporting Uses, Statewide (Source: NJDEP, 2017)

Table 6-2: Use Assessment Results for Atlantic Coastal Region (ACR), Number and Percentage of Assessment Units (AUs)

Designated Uses	Aquatic Life-General		Aquatic Life-Trout		Recreation	
	# AUs	% AUs	# AUs	% AUs	# AUs	% AUs
Fully Supporting	45	15%	2	12%	104	35%
Not Supporting	184	63%	11	65%	76	26%
Insufficient Information	64	22%	4	24%	113	39%
Total AUs Applicable	293		17		293	
Notes:	The predominant parameter causing aquatic life use impairment is "cause unknown", followed by pH, and dissolved oxygen.		Only applies to trout maintenance waters in the freshwater Manasquan River, Toms River and Metedeconk River watersheds.		Not supporting %'s due to pathogenic impairments in heavily urbanized areas such as in Monmouth and Ocean County and new tributaries added in upper Barnegat Bay area and beach closure data.	
Designated Uses	Water Supply		Shellfish Harvest		Fish Consumption	
	# AUs	% AUs	# AUs	% AUs	# AUs	% AUs
Fully Supporting	88	41%	35	27%	0	0%
Not Supporting	59	28%	78	60%	84	29%
Insufficient Information	67	31%	17	13%	209	71%
Total AUs Applicable	214		130		293	
Notes:	Water supply only applies to freshwater AUs. Impairments are predominantly due to arsenic concentrations that exceed established human health criteria even though the arsenic is naturally occurring.		Only shellfish waters classified as "approved" are assessed as fully supporting the designated use even though shellfish may be harvested from shellfish waters that are seasonal and special restricted.		Mercury and PCB in fish tissue are major causes of use impairment although, PCB in fish tissue along the Atlantic Coast is no longer on the 303(d) List because the waters from which the fish contamination arose are unknown. Other causes of use impairment found in fish tissue or subject to fish advisories are DDT and its metabolites, chlordane, dioxin, dieldrin and benzo (a) pyrene.	

Section 303(d) of the Federal Clean Water Act requires TMDLs (Total Maximum Daily Loads) to be developed for the pollutant(s) of concern in water bodies that cannot meet surface water quality standards after the implementation of technology-based effluent limitations. Waters of the State are regularly assessed to determine if surface water quality standards are attained. Waters that do not meet the applicable standards are placed on the 303(d) List of Water Quality Limited Waters (303(d) List). The 2014 303(d) List identifies 40 different causes of impairment for a total of 1,958 assessment unit (AU)/pollutant combinations (some AUs are impaired by multiple causes) statewide. Of all causes of water quality impairment, five of the top ten are associated with the aquatic life use, including total phosphorus (TP). TMDLs have been established for 74% of the pathogens, 56% of the mercury, and 35% of the TP causing use impairment. **Table 6-3** provides a list of impaired AUs within each Watershed Management Area (WMA) within the ACR, and demonstrates that the most impairments are for Aquatic Life-General.

Table 6-3: Number of Assessment Units (AUs) Listed within Each Watershed Management Area (WMA) within the Atlantic Coastal region as Impaired on the 2014 303(d) List

WMA	Aquatic Life General	Recreation	Water Supply	Shellfish Harvest	Fish Consumption
12 Monmouth	51	5	16	5	71
13 Barnegat	42	12	25	-	20
14 Mullica	50	-	18	-	34
15 Great Egg Harbor	39	-	14	1	4
16 Cape May	24	-	4	-	9
TOTAL AUs	206	17	77	6	138
Parameters:	Phosphorous, DO, Cause Unkn, TSS, pH, Turbidity, Copper, Nitrates	E. Coli, Enterococcus	Arsenic, Mercury, Lead	Total Coliform	PCB, Mercury, PAHs, DDT and Metabolites, Chlordane, Dieldrin, Dioxin,

6.6.1 Temperature and Salinity

The back bays generally exhibit lower mean salinities and higher water temperatures than the ocean. The lower salinities reflect the stronger influence of ocean dynamics on water within these bays as opposed to adjacent rivers which are more distant from the ocean. Warmer mean water temperatures in the back bays result from greater heating capability owing to shallow water depth, productivity, mixing, and influx of freshwater which may be warmed by seasonal shifts in sun strength, predominant winds, weather and ambient air temperature. Summer water temperatures along New Jersey coastal waters averages between 20°C and 30°C throughout most of the coastal waters. During winter months the average water temperature ranges from 0°C and 10°C (Zimmer and Groppenbacher, 1999). While these temperature ranges describe a majority of the water bodies along the coast, variables such as can all affect water temperatures in habitats across the study area.

6.6.2 Turbidity

Turbidity is a measure of the clarity of the water column, which is a function of suspended particles (Thurman, 1975) and is recorded as nephelometric turbidity units (NTUs). Turbid (cloudy) water can be caused by natural conditions (e.g., tidal flushing and resultant suspension of sediments), water from aquifer formations that is naturally elevated in total dissolved solids, or human activities, such as the release of suspended particles in urban runoff or wastewater discharges into the river. As a general trend, turbidity is somewhat lower in the winter months when biological productivity is lowest (Zimmer and Groppenbacher, 1999). Conversely high phytoplankton biomass and production during the warmer months of the year contribute to elevated turbidity readings. Other factors that may influence turbidity over the short term include storms, wind, and rain supplying energy that causes erosional processes that entrain suspended particles. Turbidity is also often elevated in areas near the mouth of estuaries, where tidal action and river flows result in great mixing.

6.6.3 Dissolved Oxygen

Dissolved oxygen is one of the most important water quality parameters, as most biota cannot survive without adequate DO levels. Dissolved oxygen concentrations in the water column are influenced by temperature, photosynthesis, respiration of aquatic life, aeration from physical processes, amount of organic matter, and pollutant inputs (USEPA, 1986). Generally DO is highest in the winter months and lowest in summer months (Zimmer and Groppenbacher, 1999), as its solubility increases when temperature decreases. DO can vary greatly over time within a specific area due to changes in presence of other nutrients that stimulate productivity. Furthermore, DO is highly dependent on salinity as the latter affects the solubility of oxygen in water.

6.6.4 Nutrients

The level of nutrients currently measured in coastal waters as a measure of non-point source pollution is among one of the higher priority management issues for the state and federal agencies (CBP, 2002). Two major nutrients (nitrogen and phosphorus) are monitored in water quality studies, although they may take many forms. Nitrogen is always present in aquatic systems although it exists in many forms simultaneously as ammonia (NH_4^+), nitrate (NO_3^-), nitrite (NO_2^-), and urea. It is the availability of the various nitrogen compounds that most influences the variety, abundance, and nutritional value of aquatic plants and eventually animals in an aquatic system (Goldman and Horne, 1983).

Many of New Jersey's coastal waters are experiencing high nutrient loadings that negatively impact water quality and biotic communities. For example, high nutrient inputs (especially nitrogen) can lead to a variety of adverse conditions (e.g., increased algal biomass and production, toxic or nuisance algal blooms, elevated turbidity, loss of submerged aquatic vegetation (SAV), exhausted DO levels, and a decline in biodiversity) that can severely impact the water quality of an estuary (BBEP, 2001). Kennish (2010) describes that the "nutrient enrichment of the Barnegat Bay-Little Egg Harbor Estuary is closely linked to a series of cascading environmental problems, notably increased growth of phytoplankton and benthic macroalgae (including both harmful and nuisance forms), loss of SAV, and declining shellfish resources.

These problems have also led to deterioration of sediment and water quality, loss of biodiversity, and disruption of ecosystem health and function. Human uses of estuarine resources have also been impaired.”

6.7 Plankton

Plankton are collectively a group of interacting minute organisms adrift in the water column. Plankton are commonly broken into two main categories (with some exceptions): phytoplankton (plant kingdom) and zooplankton (animal kingdom), and both form the base of the food web in aquatic ecosystems. Phytoplankton are the primary producers in the aquatic freshwater, estuarine, and marine ecosystems, and are assimilated by higher organisms in the food chain. Five major groups of phytoplankton are likely to be found in the NJBB study area including: diatoms (Bacillariophyceae), dinoflagellates (Dinophyceae), cryptophytes (Cryptophyceae), chlorophytes (Chlorophyceae), and chrysophytes (Chrysophyceae). Zooplankton provide an essential trophic link between primary producers and higher organisms. Zooplankton represent the animals (vertebrates and invertebrates) that are adrift in the water column, and are generally unable to move against major ocean currents. Zooplankton species that are characteristic of coastal areas include: *Acartia tonsa*, *Centropages humatus*, *C. furcatus*, *Temora longicornis*, *Tortanus discaudatus*, *Eucalanus pileatus* (all copepods), *Mysidopsis bigelowi* (mysid shrimp), and *Crangon septemspinosa* (sand shrimp).

Excessive phytoplankton blooms in the NJBB are attributed to eutrophication of the waters in the bays stemming from excessive nutrients and poor flushing. Excessive growth of some phytoplankton species can generate harmful algal blooms (HABs), an increasing phenomenon worldwide, which are characterized based on their pigments as brown, yellow, and red tides.

6.8 Submerged Aquatic Vegetation

Submerged aquatic vegetation (SAV) and/or “seagrass” beds exist in localized areas of the New Jersey Back Bay estuarine system, and are an essential food for a number of waterfowl species, habitat for finfish, shellfish and a number of other invertebrates, and provide sediment stabilization. SAV are rooted vascular flowering plants that exist within the photic zone of shallow bays, ponds, and rivers. The Barnegat Bay – Little Egg Harbor Estuary have the most extensive beds and account for nearly 75% of the beds in New Jersey (Kennish et al. 2010). The most important species of SAV in New Jersey is eelgrass (*Zostera marina*), which is also the most common SAV that can form extensive beds important for fish, shellfish and other wildlife species. Other species of submerged vegetation found in the more brackish waters of the estuary that are also of ecological importance include widgeon grass (*Ruppia maritima*) and other more freshwater and slightly brackish species of pondweeds (*Zanichellia palustris* and *Potamogeton* spp.) and wild celery (*Vallisneria americana*) as reported in the Great Egg Harbor River, Tuckahoe River, Patcong Creek, and the Mullica River (USFWS, 1997). SAV beds provide an important direct food source via the grazing chain, indirect food source via the detritus chain, a substrate for epiphytes, and cover and protective habitat. Although eelgrass is not used in fresh form by many organisms, Bellrose (1976) lists Atlantic brant and black duck as waterfowl known to feed extensively on eelgrass. Other waterfowl such as American widgeon (*Anas americana*), gadwall (*A. strepera*), mallard (*A. platyrhynchos*), canvasback (*Aythya valisineria*), greater scaup (*A. marila*), black scoter (*Melanitta nigra*), and surf scoter (*Melanitta perspicillata*) are also known to

feed on the plant. Large numbers of fish are also typically associated with eelgrass beds, although most do not feed directly on the plants (Good, et al., 1978). Additionally, eelgrass beds have been recognized as an important habitat for juvenile and adult blue crabs (*Callinectes sapidus*), and the leaves are used by the bay scallop (*Argopecten irradians*) as a setting substrate, and are also associated with hard clam (*Mercenaria mercenaria*) beds.

6.9 Wetland and Tidal Flats

Wetland and aquatic habitat types dominate much of the study area. Aquatic habitats are principally associated with back water sound and bay areas such as Richardson Sound and Grassy Sound, Great Sound, Jenkins Sound, Townsend Sound, Corson's Sound, Great Egg Harbor, Peckman Bay, Lakes Bay, Absecon Bay, Great Bay, Little Bay, Little Egg Harbor, and Barnegat Bay. In addition, nearshore and intertidal habitats are present within various channels and thoroughfares, while intertidal low marsh wetlands dominated by saltmarsh cordgrass (*Spartina alterniflora*) are present throughout much of the project area, and are the dominant vegetation feature. High saltmarsh habitats are generally found near the mean high tide level, and are generally dominated by saltmarsh hay (*Spartina patens*), seashore saltgrass (*Distichlis spicata*), and glasswort (*Salicornia spp.*).

Scrub/shrub habitats are common at the transition from high marsh to uplands. Common vegetation includes switchgrass (*Panicum virgatum*), groundsel tree

(*Baccharis halimifolia*), bayberry (*Myrica spp.*), eastern red cedar (*Juniperus virginiana*), hightide bush (*Iva frutescens*), seaside rose (*Rosa rugosa*) and poison ivy (*Toxicodendron radicans*). Common reed (*Phragmites australis*), often found in monotypic stands, competes with these species for dominance in these areas.

Intertidal mudflats or sand flats often border saltmarsh habitats, pocket beaches along developed shorelines, or locations where either erosion or marsh dieback has removed vegetation or depositional shoals have formed in areas that were previously subtidal. These habitats are often rich in benthic food sources available to wading birds and shorebirds that forage at low tide.

6.10 Terrestrial Habitats

Upland terrestrial habitats within the NJBB study area include vegetated primary and secondary dunes along the coastal barrier islands, inlets and undeveloped back-bay areas. Portions within the NJBB study area also include maritime forests and urbanized areas. These habitats are important for millions of neo-tropical migratory songbirds.

6.11 Wildlife

The NJBB are along the Atlantic Coastal Flyway that contain critical open water bay habitats, tidal flats, saltmarshes, scrub shrub, beaches, and overwash flats that support a multitude of resident and migratory birds that include: shorebirds, waterfowl, wading birds, colonial nesting birds, raptors and neotropical migrants. Raptors that occur in the area include the red-shouldered hawk (*Buteo lineatus*), redtailed hawk (*B. jamaicensis*), peregrine falcon (*Falco peregrinus*), osprey (*Pandion haliaetus*), Cooper's hawk (*Accipiter cooperii*), barred owl (*Strix varia*), and short-eared

owl (*Asio flammeus*) (New Jersey Division of Fish, Game and Wildlife, 1994, as cited in USFWS 1999). These species utilize tidal marshes for nesting and foraging throughout the year. Ospreys nest on platforms in numerous locations throughout the project area and “feed primarily on fish within the back bays” (USFWS, 1999). The short-eared owl is a temporary resident of high marsh areas, feeding primarily on small mammals and birds (USFWS, 1999). Northern harriers are also known to “nest and feed in the salt and brackish marshes” along the Intracoastal Waterway. The red-shouldered hawk and Cooper’s hawk migrate over the area in spring and fall (USFWS, 1999). Other raptors that could occur in the project area during migration include American kestrel (*Falco sparverius*), merlin (*E. columbarius*), sharp-shinned hawk (*Accipiter striatus*), broadwinged hawk (*Buteo platypterus*), and the bald eagle (*Haliaeetus leucacephalus*).

The New Jersey barrier beach/back barrier lagoon system provides important habitat for shorebirds during spring and fall migrations. Wetlands in the area also provided high quality habitats for a variety of migratory shorebirds. Shorebirds using beach areas and associated estuarine wetlands at the project area include the black rail (*Laterallus jamaicensis*), American oystercatcher (*Haematopus palliatus*), semi-palmated plover (*Charadrius semipalmatus*), Wilson's plover (*C. wilsonia*), piping plover (*C. melodus*), lesser golden plover (*Pluvialis dominica*), black-bellied plover (*P. squatarola*), hudsonian godwit (*Limosa haemastica*), marbled godwit (*Limosa fedoa*), whimbrel (*Numenius phaeopus*), sanderling (*Calidris alba*), semi-palmated sandpiper (*C. pusilla*), purple Nesting wading birds that occur within the area include the great blue heron (*Ardea herodias*), little blue heron (*Egretta caerulea*), tricolored heron (*E. tricolor*), snowy egret (*E. thula*), black-crowned night heron (*Nycticorax nycticorax*), yellow-crowned night heron (*Nyctanassa violaceus*), cattle egret (*Bubulcus ibis*), great egret (*Casmerodius albus*), glossy ibis (*Plegadis falcinellus*), great black-backed gull (*Larus marinus*), herring gull (*L. argentatus*), laughing gull (*L. atricilla*), glossy ibis (*Plegadis falcinellus*), black-legged kittiwake (*Rissa tridactyla*), gull-billed tern (*Gelochelidon nilotica*), Forster's tern (*Sterna forsteri*), common tern (*S. hirundo*), least tern (*S. antillarum*), black skimmer (*Rynchops niger*), common loon (*Gavia immer*), red-throated loon (*G. stellata*), great cormorant (*Phalacrocorax carbo*), and doublecrested cormorant (*P. auritus*) (New Jersey Division of Fish, Game and Wildlife, 1994, as cited in USFWS, 1999).

Estuarine marshes, bays, and channels within the area are important resting and feeding areas for migratory waterfowl on the Atlantic flyway. The bays and associated coves within the area provided habitat for tundra swan (*Cygnus columbianus*), mute swan (*Cygnus olor*), Canada goose (*Branta canadensis*), Atlantic brant (*Branta bernicla*), American black duck (*Anas rubripes*), gadwall (*Anas strepera*), American wigeon, northern pintail (*Anas acuta*), bluewinged teal (*A. discors*), green-winged teal (*A. crecca*), northern shoveler (*A. clypeata*), redhead (*A. americana*), lesser scaup (*Aythya affinis*), common goldeneye (*Bucephala clangula*), mallard, bufflehead, greater scaup, canvasback, oldsquaw (*Clangula hyemalis*), wood duck (*Aix sponsa*), ruddy duck (*Oxyura jamaicensis*), red-breasted merganser (*Mergus serrator*), hooded merganser (*Lophodytes cucullatus*), common merganser (*M. merganser*), and canvasback (*Aythya valisneria*) (New Jersey Division of Fish, Game and Wildlife, 1994, as cited in USFWS 1999).

Dabbling ducks and bufflehead are fairly evenly distributed along the shorelines and tidal creeks of estuaries, while diving ducks occur mostly in more open water areas (USFWS, 1997). Inlet waterways are an important concentration area for many waterfowl species during harsh winters when other area water surfaces freeze. Breeding waterfowl in estuaries include American black duck, gadwall, mallard, and Canada goose. Salt marshes provide an important larval insect food source for newly hatched ducklings (USFWS, 1997).

A number of mammals are likely to occur in terrestrial habitats including raccoon (*Procyon lotor*), red fox (*Vulpes vulpes*), gray fox (*Urocyon cinereoargenteus*), gray squirrel (*Sciurus carolinensis*), striped skunk (*Mephitis mephitis*), meadow vole (*Microtus pennsylvanicus*), eastern cottontail (*Sylvilagus floridanus*), Virginia opossum (*Didelphis virginiana*), red bat (*Lasiurus borealis*), little brown bat (*Myotis lucifugus*) and white-tailed deer (*Odocoileus virginianus*)

Several species of turtles and snakes could occur in upland areas of the barrier island complex within the study area including the snapping turtle (*Chelydra serpentina*), eastern mud turtle (*Kinosternon subrubrum*), stinkpot (*Sternotherus odoratus*), northern watersnake (*Natrix sipedon*), northern black racer (*Coluber constrictor*), and eastern garter snake (*Thamnophis sirtalis*). The distribution of these species is limited by the availability of fresh water, as they are intolerant of higher salinity. The northern diamondback terrapin (*Malaclemys terrapin terrapin*), a “species of special concern” is also known to inhabit marshes, tidal flats, and beaches within New Jersey estuaries.

A number of marine mammals protected under the Marine Mammal Protection Act are present at times within New Jersey coastal waters. The harbor porpoise (*Phocoena phocoena*) and the bottlenose dolphin (*Tursiops truncatus*) are New Jersey “species of special concern”.

6.12 Fisheries Resources

The presence of extensive estuarine wetlands, tidal creeks and inlets, mudflats and SAV beds within the New Jersey Back Bays allows the coastal waters of New Jersey to have productive fisheries. Many species utilize the estuaries behind the barrier islands for forage and nursery grounds. The finfish found along New Jersey coastal waters are principally seasonal migrants. Winter is a time of lower abundance and diversity as most species leave the area for warmer waters offshore and southward. During the spring, increasing numbers of fish are attracted to the New Jersey Coast, because of its proximity to several estuaries, which are utilized by these fish for spawning and nurseries (USACE 2002).

Many of these migrant species of estuarine-dependent fish (fish species that spend some stage of life history within an estuary) exist within the study area. Estuarine-dependent species that comprise the majority of the ecologically, recreationally, and commercially important fisheries include Atlantic menhaden (*Brevoortia tyrannus*), weakfish (*Cynoscion regalis*), spot (*Leiostomus xanthurus*), Atlantic croaker (*Micropogonias undulatus*), northern kingfish (*Menticirrhus saxatilis*), silver perch (*Bairdiella chrysoura*), bluefish (*Pomatomus saltatrix*), summer flounder (*Paralichthys dentatus*) and winter flounder (*Pseudopleuronectes americanus*) (Beccasio et al., 1980).

Anadromous species such as alewife (*Alosa pseudoharengus*), blueback herring (*Alosa aestivalis*), and striped bass (*Morone saxatilis*) utilize the bays' inlets to reach spawning and nursery habitat in the freshwater tributaries. The catadromous American eel (*Anguilla rostrata*)

spawn in the Sargasso Sea, and transit the inlets as elvers into the bays' freshwater tributaries.

6.12.1 Essential Fish Habitat

In accordance with the Magnuson-Stevens Fishery Conservation and Management Act, the back bays and coastal waters of New Jersey have been designated as essential fish habitat (EFH) for a variety of life stages of fish managed under the New England and Mid-Atlantic Fishery Management Councils and the National Marine Fisheries Service. Forty species are listed including Mid-Atlantic species, New England species, Coastal migratory pelagic species, highly migratory species and shark species. Key EFH species in the NJBB include: Atlantic butterfish (*Peprilus tricanthus*), bluefish, black sea bass (*Centropristus striata*), red hake, scup (*Stenotomus chrysops*), summer flounder, winter flounder, windowpane flounder (*Scopthalmus aquosus*), king mackerel (*Scomberomorus cavalla*), Spanish mackerel (*Scomberomorus maculatus*), cobia (*Rachycentron canadum*), clearnose skate (*Raja eglanteria*), little skate (*Leucoraja erinacea*), winter skate (*Leucoraja ocellata*), and a number of sharks and other highly migratory species (NMFS, 2016). See the Environmental and Cultural Resources Appendix F for the full list generated by the EFH Mapper.

Two habitat areas of particular concern (HAPCs) occur within the NJBB study area, which are: the mouth of the Little Egg Inlet and Great Bay for sandbar shark (*Charcharhinus plumbeus*) as an important pupping area, and any SAV bed, which is HAPC for juvenile summer flounder.

6.12.2 Shellfish

Shellfish habitats are located throughout the NJBB study area, which include beds containing hard clams (*Mercenaria mercenaria*), soft clams (*Mya arenaria*), and eastern oysters (*Crassostrea virginica*). Historic shellfish habitat mapping based on previous surveys is provided in the Environmental and Cultural Resources Appendix F. The blue crab (*Callinectes sapidus*) and hard clam are important commercial and recreational species in the NJBB. Based on the overall decline in hard clam stocks, the BBP has assessed that the indicator status for shellfish in Barnegat Bay as "degraded".

N.J.A.C. 7:12 provides rules for NJDEP to implement procedures to classify shellfish waters and their boundaries in order to protect human health, safety, and welfare from the risks associated with the consumption of shellfish. Classifications of shellfish waters were developed in accordance with the National Shellfish Sanitation Program (NSSP), a Federal/State cooperative program, guidelines. A number of factors determine the classification of shellfish waters that include ambient bacteriological water quality and point and non-point pollution sources. The classifications are: Approved, Conditionally Approved, Conditionally Restricted, Restricted, Prohibited, and Suspended. The NJBB study area includes a broad geographic area including Atlantic Ocean waters, large and small bays, and tidal creeks with surrounding variable land uses that have point and non-point discharges, and marinas that would result in variable shellfish growing water classifications. The Environmental and Cultural Resources Appendix F summarizes shellfish growing water classifications for the study area.

6.13 Invertebrates

The coastal habitats along the New Jersey coast including the back bays are home to a wide variety of both benthic and free swimming and floating invertebrates. Invertebrate groups found in various coastal habitats include Cnidaria (hydra, corals, anemones, jellyfish), Platyhelminthes (flatworms), *Nemertinea* (ribbon worms), Nematoda (roundworms), Polychaetes (bristle worms), Oligochaetes, *Bryozoa*, Mollusca (chitons, bivalves, snails, squids, etc.), Crustaceans (crabs, shrimp, amphipods), insects (Dipterans), Echinodermata (sea urchins, sea cucumbers, sand dollars, starfish), Urochordata (tunicates), and zooplankton, which may represent a number of different phyla at various life stages.

Benthic macroinvertebrate communities are commonly used as indicators of overall quality of water and benthic habitats. Indices measuring such parameters as abundance and species composition are well developed and often used in describing quality of habitats and also the potential food sources for higher consumers. In particular, benthic invertebrates make up the primary food source for both juvenile and adult fish species in shallow water environments found in estuarine habitats. Benthic invertebrate communities vary spatially and temporally (NOAA, 1994) as a result of factors such as sediment type, water quality, depth, temperature, predation, competition, and season. Thus, benthic invertebrate communities differ between habitat types. For example, the community within fine grain sediment found in deep water, low energy environment is likely to be dominated by a higher percentage of sessile organisms, while a shallow, high energy environment consisting of larger grain sediment may contain a higher percentage of mobile filter feeding invertebrates. The New Jersey Back Bays are rich in benthic taxa. A recent benthic survey of the Barnegat Bay and Little Egg Harbor estuaries by Taghon *et al.* (2016) demonstrated a fairly diverse benthic community where they collected a total of 276 taxa of which 220 were infaunal taxa. However, five of these taxa made up 50% of the total abundance, which include polychaetes: *Mediomastus ambiseta* and *Streblospio benedicti*; amphipods: *Ampelisca abdita* and *A. verrilli*; and Oligochaeta.

Shallow water intertidal areas consisting of habitats such as high salt marshes, low salt marshes, mudflats, and common reed dominated estuarine wetlands provide habitat for benthic invertebrate groups that are tolerant of a continuously changing environment such as *oligochaetes*, *polychaetes*, and nematodes. These habitats are frequently inhabited by the fiddler crab (*Uca spp.*), salt marsh snail (*Melampus bidentatus*), and ribbed mussels (*Geukensia demissus*). Other groups of benthic invertebrates that inhabit these habitats in lesser abundance include ceratopogonids, chironomids (green head flies, and mosquitos), mites, ostracods, isopods, and gastropods. High marsh habitats that are rarely affected by tidal influence generally contain lower abundances of aquatic invertebrates and a higher proportion of terrestrial taxa as a result. By comparison, habitats such as low saltmarsh and mosquito ditches are inundated most of the time and are home to a higher abundance of aquatic organisms. Similarly, the benthic macro invertebrate community may differ between vegetation types, such as within high marsh habitats dominated by common reed (*Phragmites*) vegetation versus low marsh habitat dominated by *Spartina alterniflora*. For example, low marshes dominated by *Spartina alterniflora* were shown to have greater abundance and species composition than high marshes dominated by *Phragmites* (Able, 2000; Angradi *et. al.*, 2001).

Other notable benthic invertebrates common to estuarine and marine habitats within the New Jersey coast include mollusks such as bay scallop (*Aequipecten irradians*), hard clam, common

blue mussel (*Mytilus edulis*), eastern oyster, moon snail (*Lunatia heros*), and knobbed whelk (*Busycon carica*); crustaceans such as common rock crab (*Cancer irroratus*), blue crab snapping shrimp (*Crangon septemspinosa*), and grass shrimp (*Palaemonetes spp.*); and an echinoderm: sea stars (*Asterias forbesi*).

The horseshoe crab (*Limulus polyphemus*) is a common, yet important, invertebrate inhabiting the New Jersey Back Bays and nearby Atlantic Ocean waters, and is notable for pharmaceutical applications, and their eggs are a critical food source for migratory shorebirds.

6.14 Special Status Species

Federally- listed threatened and endangered species and state-endangered species occur within the NJBB study area (Table 5-9). The Federally-listed (threatened) and state-listed (endangered) piping plover (*Charadrius melodus*) has historically nested along coastal beaches and inlets within the study area. Piping plover nests can be found above the high tide line on coastal beaches, on sand flats at the ends of sand spits and barrier islands, on gently sloping foredunes, in blowout areas behind primary dunes, and in washover areas cut into or between dunes. The Federally-threatened, rufa red knot (*Calidris canutus rufa*,) can be found in low densities during the spring and fall migrations along Atlantic Coast beaches, and could occur within the project area. The northern long-eared bat (*Myotis septentrionalis*) is a Federally-threatened species that utilizes dense forests to roost under the loose bark or crevices in trees.

Seabeach amaranth (*Amaranthus pumilus*) is a Federally-listed threatened plant. The seabeach amaranth is an annual plant, endemic to Atlantic coastal plain beaches, and primarily occurs on overwash flats at the accreting ends of barrier beach islands and lower foredunes of non-eroding beaches.

The National Marine Fisheries Service (NMFS) has jurisdiction over four (4) Federally-designated sea turtles that may occur in the study area: the endangered leatherback (*Dermochelys coriacea*), Kemp's Ridley (*Lepidochelys kempii*), and green (*Chelonia mydas*) sea turtles, and the threatened loggerhead (*Caretta caretta*) sea turtle.

With its range overlapping the study area, the New York Bight population of the Atlantic sturgeon (*Acipenser oxyrinchus oxyrinchus*) was recently listed as endangered by the NMFS. Atlantic sturgeon are anadromous, spending a majority of their adult life phase in marine waters. Mature sturgeon migrate up rivers to spawn in freshwater. The offspring then migrate to brackish water as juveniles. The shortnose sturgeon (*A. brevirostrum*) are found in 41 river systems and estuaries along the east coast, and are found less frequently in the Atlantic Ocean. However, their breeding populations are only associated with large river systems such as the Delaware River and Hudson River.

Several endangered whale species occur along New Jersey's Atlantic coast, and may occasionally transit through one of the many inlet areas. A listing of these species is provided in **Table 6-4**.

Table 6-4: Special Status Species in NJBB Coastal Areas

Species	Status	Habitat in NJBB
American Bittern (<i>Botaurus lentiginos</i>) BR	SE	Brackish marshes
Bald Eagle (<i>Haliaeetus leucocephalus</i>) BR/NB	SE/ ST	Forest edges, open water
Northern Harrier (<i>Circus cyaneus</i>) BR	SE	Tidal marshes
Red knot (<i>Calidris canutus rufa</i>) NB	FT, SE	Sandy beaches, spits, marsh islands, tidal flats
Short-Eared Owl (<i>Asio flammeus</i>) BR	SE	Coastal marshes
Black-Crowned Night-Heron (<i>Nycticorax nycticorax</i>) BR	ST	Maritime forests, scrub-shrub, mixed <i>Phragmites</i> marshes
Yellow-Crowned Night-Heron (<i>Nyctanassa violacea</i>)	ST	Maritime forests, scrub-shrub on barrier and bay islands
Osprey (<i>Pandion haliaetus</i>) BR	ST	Coastal rivers, marshes, bays & inlets. Nest on dead trees, platforms, poles
Piping plover(<i>Charadrius melodus</i>)	FT, SE	Ocean beaches, inlets, washover areas, tidal flats
Black Rail (<i>Laterallus jamaicensis</i>) BR/NB	SE/ST	High marshes
Black Skimmer (<i>Rynchops niger</i>)	SE	Sandy beaches, inlets, sandbars, offshore islands
Least Tern (<i>Sternula antillarum</i>)	SE	Sandy beaches, bay islands
Roseate Tern (<i>Sterna dougallii</i>)	FE/SE	Beaches w/ vegetated dunes
Sedge Wren (<i>Cistothorus platensis</i>)	SE	High marshes
Atlantic Loggerhead (<i>Caretta caretta</i>)	FT/SE	Marine/Estuarine Pelagic
Kemp's Ridley (<i>Lepidochelys kempii</i>)	FE/SE	Marine/Estuarine Pelagic
Atlantic Green Sea Turtle (<i>Chelonia mydas</i>)	FT/ST	Marine/Estuarine Pelagic
North Atlantic Right Whale (<i>Eubalaena glacialis</i>)	FE/SE	Marine pelagic
Blue Whale (<i>Balaenoptera musculus</i>)	FE/SE	Marine pelagic
Fin Whale (<i>Balaenoptera physalus</i>)	FE/SE	Marine pelagic
Humpback Whale (<i>Megaptera novaeangliae</i>)	FE/SE	Marine pelagic
Sei Whale (<i>Balaenoptera borealis</i>)	FE/SE	Marine pelagic
Sperm Whale (<i>Physeter microcephalus</i>)	FE/SE	Marine pelagic
Northern Long-Eared Bat (<i>Myotis septentrionalis</i>)	FT	Summertime roosts beneath the bark of live and dead trees.

Species	Status	Habitat in NJBB
Atlantic Sturgeon (<i>Acipenser oxyrinchus oxyrinchus</i>)	FE/SE	Marine/estuarine; Demersal/pelagic
Shortnose Sturgeon (<i>Acipenser brevirostrum</i>)	FE/SE	Marine/estuarine; Demersal/pelagic
Northeastern Beach Tiger Beetle (<i>Cincindela d. dorsalis</i>)	SE	Atlantic coast sandy beaches
Bronze Copper (butterfly) (<i>Lycaena hyllus</i>)	SE	Brackish marshes
Seabeach amaranth (<i>Amaranthus pumilus</i>)	FT/SE	Upper sandy beaches, accreting ends of inlets
FT= Federally Threatened FE= Federally Endangered ST=State Threatened SE= State Endangered BR= Breeding Population Only NB= Non-Breeding Population Only		

*Note: There are over 800 species of Special Status Plants in NJ. Due to the large study area, site specific species data searches will be conducted at subsequent phases of the feasibility study.

6.15 Coastal Lakes

The Coastal Lakes section of the study area is comprised of 16 freshwater/brackish water lakes. The lakes include: Lake Takanassee, Deal Lake, Sunset Lake, Wesley Lake, Fletcher Lake, Sylvan Lake, Silver Lake, Lake Como, Spring Lake, Wreck Pond, Stockton Lake, Glimmer Glass, Lake Louse, Little Silver Lake, Lake of the Lilies, and Twilight Lake. Most of the lakes have a connection to the ocean, but some are completely freshwater (Souza 2013). Twelve of the lakes are non-tidal and four are tidal. Historically, most of the coastal lakes were estuaries (Souza 2013).

The Coastal Lakes area of the study is highly urbanized with very limited natural resources and many are considered eutrophic lakes (NJDEP 2013). Today, the landscape defining the watersheds of the coastal lakes is primarily urban, and characterized by intensive residential and commercial development, which includes large contiguous swaths of impervious cover. Storm water and runoff generated from these areas is a major contributor to lake pollution. As a result, the water quality of almost all the coastal lakes has declined dramatically resulting in a loss of aesthetic attributes and recreation opportunities (Tiedemann 2013). All were severely impacted by Hurricane Sandy in 2013 (Souza 2013). Impacts from the storm included: direct scouring, impaired water quality (contaminants), sediment deposition, and habitat alteration.

6.16 Cultural Resources

The New Jersey Back Bays Study will be especially challenging regarding potential impacts to historic properties eligible for or listed on the National Register of Historic Places (NRHP). This project involves the entire southern coast of New Jersey from Monmouth to Cape May. Background research within the general study area show many previously recorded archaeological sites, historic structures, historic districts, shipwrecks, and other cultural

resources. The following is the current count of recorded historic properties eligible for or listed on the NRHP for each county in the study area:

Monmouth County – 377; Ocean County - 179; Burlington County – 331, one of which is a Paleo-Indian archaeological site; Atlantic County – 153; and, Cape May County – 189.

Continued consultation with the New Jersey State Historic Preservation Office, the Tribes, and other Consulting Parties will be required pursuant to Section 106 of the National Historic Preservation Act of 1966, as amended (NHPA) as the project develops. Once our study isolates viable alternatives, we will define the Area of Potential Effects (APE) and conduct the necessary investigations and consultation in order to avoid, minimize, or to mitigate Adverse Effects to historic properties.

6.17 Recreational Resources

Recreation and ecotourism services provided by the New Jersey Inland Bays, and adjacent marshes and beaches are a huge draw for tourism in the region. The New Jersey Back Bays support a number of sites with recreational bathing beaches along bayshores, inlets, and tidal rivers. Over 25 bathing beach locations in the back bays are monitored by local health departments for recreational beach water quality, which is reported to the NJDEP who issues beach advisories or closings if bacterial criteria are exceeded. Fishing is typically conducted along shoreline areas particularly where access to the water is available. Recreational fishing boats launch from private and public marinas and docks nearby to fish in deeper parts of the bays and creeks. Anglers in the back bays and tidal creeks typically target summer flounder (fluke), winter flounder, weakfish, bluefish, striped bass, kingfish, white perch and tautog. Other popular recreational activities in the back bays include clamming (hard clams), crabbing (blue crabs), hunting (waterfowl), sailing, boating, water skiing, jet skiing, paddling (canoes, kayaks, stand-up paddle boards), windsurfing, and bird watching.

6.18 Visual Resources and Aesthetics

Aesthetics refer to the sensory quality of the resources (sight, sound, smell, taste, and touch) and especially with respect to judgment about their pleasurable qualities (Canter, 1993; Smardon et al. 1986). The aesthetic quality of the study area is influenced by the natural and developed environment. The New Jersey Back Bays contain extensive natural tidal marshlands and islands, tidal creeks and “guts”, and open-water embayment and lagoons on both the mainland (west side of the bays) and also along the western edges of some of the barrier islands. Likewise, the study area also contains heavily urbanized areas consisting of developed shorelines composed of homes, condominiums, businesses, marinas, boat ramps, some industrial activities, and power plants. Many of these developed shorelines include docks, wharves, and hardened shorelines with bulkheads, concrete revetments, and riprap.

Visual resources are the natural and man-made features that comprise the visual qualities of a given area, or “viewshed.” These features form the overall impression that an observer receives of an area or its landscape character. Topography, water, vegetation, man-made features, and the degree of panoramic view available are examples of visual characteristics of an area. The views of open water bays and saltmarsh landscapes are an important component of the viewshed within the NJBB study area.

6.19 Air Quality

The entire state of New Jersey is in non-attainment of the National Ambient Air Quality Standards (NAAQS) for ozone pursuant to the Clean Air Act. The non-attainment status is classified as being either “Moderate” or “Marginal” for ground level ozone. Marginal classifications have been designated for counties in the Southern New Jersey – Pennsylvania-Delaware-Maryland Area, which include Ocean, Burlington, Atlantic, and Cape May Counties within the NJBB study area. Monmouth County is part of the Northern New Jersey-New York-Connecticut Area that have been reclassified from marginal to moderate non-attainment status in 2016 (NJDEP, 2017). For particulate matter (PM 2.5), no monitoring sites within NJ were in violation of either the annual standard of 12.0 µg/m³ or the 24-hour standard of 35 µg/m³ in 2016 and for the 3-year average from 2014-2016 (NJDEP, 2017).

6.20 Greenhouse Gases

In the State of New Jersey, the New Jersey Global Warming Response Act of 2007 (GWRA), N.J.S.A 26:2C-37, establishes two GHG limits, one for 2020 and another for 2050. The GWRA requires two recommendation reports, one for each limit. The GWRA 2050 target requires New Jersey to reduce GHG emissions by 80 percent from 2006 levels by 2050. This limit is equivalent to 25.4 million metric tons (MMT) CO₂ equivalent. The NJDEP has developed four scenarios to identify pathways to meet the GWRA target. In order to approach the 2050 GHG emission limit of 25.4 million metric tons, the following are a must: (a) energy efficiency measures for buildings, industry, and transportation; (b) electrification to avoid combustion wherever it is possible; (c) non-combustion electricity generating technology (e.g., renewables and nuclear); and (d) measures to increase and enhance natural sinks (NJDEP, 2016).

6.21 Climate and Climate Change

The NJBB area falls within the Coastal Zone, which is one of five climatic zones identified for the State of New Jersey. The New Jersey Atlantic Ocean coastal region experiences a moderate climate associated with the low elevations of the Coastal Plain and the presence of the large water bodies. Data obtained from the Office of the State Climatologist for 5 stations in the NJBB compiled from 1981-2010 are provided in **Table 6-5** and **Table 6-6**. The average annual temperature is approximately 54.6°F. The monthly averages for the coldest months of January and February are about 33.8 and 35.8°F, and the monthly averages for the warmest months of July and August range between 74.5°F and 75.7°F. Annual precipitation is approximately 42 inches that is evenly distributed throughout the year with monthly means ranging from 2.9 to 4.3 inches (NJ State Climatologist website retrieved on 2/24/2019 at http://climate.rutgers.edu/stateclim_v1/norms/monthly/index.html).

Table 6-5: New Jersey Back Bay Areas Monthly Temperature Range Normals (Deg. F)

Source: (NJ State Climatologist website retrieved on 2/24/2019 at http://climate.rutgers.edu/stateclim_v1/norms/monthly/index.html)

Mean Temperatures are in parentheses.

Based on Data from 1981-2010

STATION NAME	JAN	FEB	MAR	APR	MAY	JUN	JUL	AUG	SEP	OCT	NOV	DEC	ANN
ATLANTIC CITY AP	24.5-41.5 (33.0)	26.4-44.3 (35.3)	32.7-51.8 (42.2)	41.8-61.7 (51.7)	51.0-71.3 (61.1)	61.2-80.6 (70.9)	66.9-85.5 (76.2)	65.2-83.7 (74.4)	57.4-77.0 (67.2)	45.6-66.6 (56.1)	37.2-56.3 (46.8)	28.4-46.0 (37.2)	44.9-63.9 (54.3)
ATLANTIC CITY MARINA	29.2-41.8 (35.5)	30.9-43.5 (37.2)	36.9-49.6 (43.3)	45.5-57.6 (51.6)	54.5-66.6 (60.6)	64.3-75.7 (70.0)	70.0-81.3 (75.6)	69.7-80.2 (75.0)	63.5-74.8 (69.1)	52.5-65.0 (58.7)	42.9-55.8 (49.4)	33.5-46.3 (39.9)	49.5-61.5 (55.5)
BRANT BEACH BECH HAVEN	26.2-41.1 (33.6)	28.2-42.7 (35.5)	34.1-49.1 (41.6)	42.8-57.5 (50.1)	52.7-67.7 (60.2)	62.3-76.9 (69.6)	69.0-83.4 (76.2)	68.2-82.4 (75.3)	61.8-76.1 (68.9)	50.5-65.9 (58.2)	41.0-55.6 (48.3)	31.5-45.4 (38.5)	47.4-62.0 (54.7)
CAPE MAY	27.9-42.3 (35.1)	29.2-44.3 (36.8)	35.2-51.4 (43.3)	43.8-60.8 (52.3)	52.7-70.4 (61.5)	62.5-79.4 (71.0)	67.7-84.5 (76.1)	66.8-83.4 (75.1)	60.7-77.8 (69.2)	49.9-67.1 (58.5)	41.1-56.8 (49.0)	31.9-46.8 (39.4)	47.5-63.8 (55.6)
TOMS RIVER	22.1-41.1 (31.6)	23.9-44.0 (34.0)	30.1-50.9 (40.5)	39.3-61 (50.2)	48.9-71.1 (60.0)	58.5-80.0 (69.2)	63.9-85.0 (74.5)	62.2-83.4 (72.8)	54.5-77.0 (65.7)	42.8-66.5 (54.6)	34.6-56.5 (45.5)	26.5-45.7 (36.1)	42.3-63.5 (52.9)
MEAN	(33.8)	(35.8)	(42.2)	(51.2)	(60.7)	(70.1)	(75.7)	(74.5)	(68.0)	(57.2)	(47.8)	(38.2)	(54.6)

Table 6-6: New Jersey Monthly Precipitation Normals (Inches)

Source: (NJ State Climatologist website retrieved on 2/24/2019 at http://climate.rutgers.edu/stateclim_v1/norms/monthly/index.html)

Based on Data from 1981-2010

STATION NAME	JAN	FEB	MAR	APR	MAY	JUN	JUL	AUG	SEP	OCT	NOV	DEC	ANN
ATLANTIC CITY AP	3.2	2.9	4.2	3.6	3.4	3.1	3.7	4.1	3.2	3.4	3.3	3.7	41.8
ATLANTIC CITY MARINA	3.1	2.9	4.0	3.4	3.2	2.7	3.3	3.9	3.1	3.5	3.4	3.6	40.0
BRANT BEACH BECH HAVEN	3.3	2.9	4.0	3.3	2.8	3.1	3.9	3.7	2.8	3.7	2.9	3.4	39.5
CAPE MAY	3.3	2.8	4.3	3.5	3.5	3.4	3.7	3.6	3.3	3.7	3.3	3.5	41.9
TOMS RIVER	3.9	3.2	4.8	4.1	3.7	3.8	4.6	4.7	3.8	3.9	4.1	4.5	49.1
MEAN	3.4	2.9	4.3	3.6	3.3	3.2	3.9	4.0	3.2	3.6	3.4	3.7	42.4

Despite the historic moderate climate experienced within the Coastal Zone of New Jersey, the Earth’s surface temperature has risen by 1.3 °F over the last century, which is attributed to the anthropogenic introduction of carbon dioxide and other greenhouse gases (NJDEP, 2013). In New Jersey, the New Jersey State Climatologist reports a statistically significant rise in average statewide temperature over the last 118 years. Also during this period, New Jersey has experienced a significant increase of the departure from normal indicating that average annual temperatures are consistently greater than the longer term average. This temperature trend coincides with an increase in precipitation due to more moisture in the atmosphere. However, despite a trend toward more precipitation, the Northeast is seeing longer periods without rainfall and longer growing seasons (NJDEP, 2013 and O’Neill, 2009).

As stated in NJDEP (2013): “Sea levels are rising at a rate of 3.5 millimeters per year (Cooper *et al.* 2005), and this rate is projected to increase into the 21st Century (Climate Institute 2010, UCS 2013). The global average of sea level rise is approximately 8 inches since the Industrial Revolution, but other areas of the world, particularly the East and Gulf Coasts are experiencing some of the highest rates of sea level rise (UCS 2013). Small increases in sea level dramatically affects the world’s coastlines, physically, biogeochemically, and economically through impacts such as erosion, flooding, salinization, and habitat transformation for wildlife and plants (Climate Institute 2010, UCS 2013).”

Other impacts of climate change may include increased intensity of hurricanes; however, climate science projections for intensity and intense hurricane numbers suggest relatively large uncertainty at present (NOAA 2012). High magnitude storm events such as hurricanes and Nor'Easters could have extensive direct and indirect impacts to habitat, ranging from erosion from wave attack, salt water intrusion from inundation, as well as water quality impacts from developed areas experiencing inundation from floodwaters. Additionally, temporary and permanent impacts to habitat could occur across a broad temporal reference along the North Atlantic Coast. Some habitat areas could be exposed to different impacts based on the time of the year the storm occurs. Combined with sea level rise, extreme water levels may exacerbate coastal storm impacts to habitats over the long-term planning horizon (USACE 2014).

Climate change and Sea Level Rise are significant issues affecting coastal areas in New Jersey. Climate change has potential devastating ecological, economic and public health impacts in New Jersey (NJDEP, 2013 and IPCC, 2007). Executive Order 13653 on Preparing the United States for the Impacts of Climate Change was released 1 Nov 2013. EO 13653 contains very specific language, goals, and objectives to prepare the Nation for the impacts of climate change by undertaking actions to enhance climate preparedness and resilience. In response to this and other related Executive Orders, USACE has developed a comprehensive policy on climate change (USACE, 2015). It states in this document that: "It is the policy of USACE to integrate climate change preparedness and resilience planning and actions in all activities for the purpose of enhancing the resilience of our built and natural water-resource infrastructure and the effectiveness of our military support mission, and to reduce the potential vulnerabilities of that infrastructure and those missions to the effects of climate change and variability."

7 Future Without Project Conditions

The forecast of the future without-project (FWOP) condition reflects the conditions expected during the period of analysis. The future without-project condition provides the basis from which alternative plans are formulated and impacts are assessed. Since impact assessment is the basis for plan evaluation, comparison and selection, clear definition and full documentation of the without-project condition are essential. Gathering information about historic and existing conditions requires an inventory. Gathering information about potential future conditions requires forecasts, which should be made for selected years over the period of analysis to indicate how changes in economic and other conditions are likely to have an impact on problems and opportunities. Information gathering and forecasts will most likely continue throughout the planning process.

The most likely future without project condition is considered to be if no NJBB action is taken, and is characterized by CSRMs projects and features, and socio-economic, environmental, and cultural conditions. This condition is considered as the baseline from which future measures will be evaluated with regard to reducing coastal storm risk and promoting resilience. The Future-Without Project Condition serves as the baseline for evaluating the anticipated performance of alternatives. It documents the need for Federal action to address the water resources problem. A base year of 2030 has been identified as the year when USACE projects associated with the NJBB CSRMs Feasibility Study will be implemented or constructed.

Several trends have been identified for the NJBB Region which are projected to continue into the future and will likely effect the future without-project condition for this study. It is anticipated that the study area will continue to experience damages from coastal storms, and that the damages may increase as a result of more intense storm events. These coastal storm events will likely continue to effect areas of low coastal elevations within the study area with pronounced localized effects in some areas.

In the future without project condition, it is anticipated that sea level is increasing throughout the study area, that shorelines are changing in response to sea level change, and historic erosion patterns will continue and accelerate. It is anticipated that there will continue to be significant economic assets within the NJBB region and that population and development will continue to increase. Based on a desktop inventory of structures compiled for the HEC-FDA model, the New Jersey Back Bays study area experiences a total of \$1,571,616,000 in FWOP Average Annual Damages (AAD) over a 50 year period of analysis based on the intermediate rate of relative sea level change (RSLC).

The FWOP condition no-action alternative would see no additional federal involvement in storm damage reduction as outlined within this study. Current projects and programs that the USACE conducts in conjunction with other Federal and non-Federal entities would continue and would be constructed by 2030.

The FWOP condition does consider those projects that have been completed (existing), are under construction, or have been authorized for construction and are anticipated to be constructed by 2030. Any proposed projects, which are not yet authorized for construction, are not considered part of the FWOP conditions for analysis.

7.1 Economic and Social Without Project Conditions

The HEC-FDA software version 1.4.2 is used to model Future Without Project Conditions and a variety of scenarios for Future With Project Conditions.

HEC-FDA provides integrated hydrologic engineering and economic risk analysis during the formulation and evaluation of flood damage reduction plans in compliance with policy regulations ER 1105-2-100 Planning Guidance Notebook and ER 1105-2-101 Risk Analysis for Flood Damage Reduction Studies. Uncertainty in discharge-exceedance probability, stage-discharge, and damage-stage functions are quantified and incorporated into economic and engineering performance analyses of alternatives. The process applies Monte Carlo simulation, a numerical-analysis procedure that computes the expected value of damage while explicitly accounting for uncertainty in the basic parameters used to determine flood inundation damage.

Data on historic storms, water surface profiles, depth-percent damage functions, and residential, commercial, and public structures within the study area will be used as input for the HEC-FDA software. In conjunction with hydrologic modeling, HEC-FDA will also incorporate historic (Low), intermediate, and high relative sea level change (RSLC) analysis in compliance of ER 1100-2-8162 Incorporating Sea Level Change in Civil Works Programs and ER 1110-2-1619 Risk-Based Analysis for Flood Damage Reduction Studies.

FWOP conditions are used as the base condition over the 50-year period of analysis and are compared against potential alternatives to determine potential with-project National Economic Development (NED) benefits.

HEC-FDA links the predictive capability of hydraulic and hydrologic modeling with project area infrastructure information, structure and content damage functions, and economic valuations to estimate the total damages under various proposed alternatives while accounting for risk and uncertainty. The model output is then used to determine the net NED benefits of each project alternative in comparison with the No-Action Plan, or FWOP Condition.

Storm damage is defined as the monetary loss to contents and structures incurred as a direct result of inundation caused by a storm of a given magnitude and probability.

For the FWOP and Future With-Project Conditions, the structure inventory and assigned values are considered static throughout the 50 year period of analysis. Though this approach may ignore future condemnations of repeatedly damaged structures or increases in the number or value of structures in the inventory due to future development, the variability and limitations of projecting future inventory changes over 50 years across such a wide study area are too significant to assign any reasonable level of certainty to the predicted inventory alterations.

As mentioned earlier Future Without-Project Condition damages are used as the base condition and potential project alternatives are measured against this base to evaluate the project effectiveness and cost efficiency. Future Without-Project Condition damages are presented as Average Annual Damages (AAD) over a 50 year period of analysis with an FY2019 Project Evaluation and Formulation Rate (Discount Rate) of 2.875%.

The following model results for Future Without-Project Condition analysis are based on estimated structure and content damages with additional damages such as vehicles, critical infrastructure, emergency costs, and transportation delays accounted for using a percentage increase at the reach level. As the study progresses, this percentage allocation for additional benefit categories, currently at 25%, will be replaced by more specific and more detailed data at the reach level.

7.1.1 Model Results

The New Jersey Back Bays study area experiences a total of \$1,571,616,000 in Without-Project Average Annual Damages (AAD) over a 50 year period of analysis with Intermediate RSLC. Table 5 shows the breakdown in Average Annual Damages across all 84 municipalities. It is important to note the values in **Table 7-1** only reflect the AAD of the sections of the municipality that intersect with the study area. AAD within the municipality that are outside the study area are not included nor quantified.

While Average Annual Damages per structure fluctuates by municipality, Atlantic City has the highest mean AAD per Structure at \$41,605 followed by Ocean City at \$12,292. The total study area has a mean AAD per Structure at \$8,591.

Figure 7-1 and **Figure 7-2** shows the relative contribution to Average Annual Damages by reach. The generated heat map shows high damage areas in red and lower damage areas in green.

For Cape May County and Atlantic County, the majority of estimated FWOP damages are focused on the southern tip of New Jersey and along the barrier islands. These areas typically have a higher density of structures, higher average value per structure, and increased inundation risk due to lower ground elevations.

Table 7-1: Without Project Average Annual Damages by Municipality (2030-2080)

Municipality	AAD	Municipality	AAD
Atlantic City	\$323,774,000	Absecon	\$4,393,000
Ocean City	\$219,809,000	Eagleswood	\$4,217,000
Toms River	\$69,526,000	Mantoloking	\$3,778,000
Sea Isle City	\$62,714,000	Bass River	\$3,656,000
North Wildwood	\$59,807,000	West Cape May	\$3,545,000
Long Beach	\$54,554,000	Hamilton	\$3,329,000
Brick	\$53,293,000	South Toms River	\$3,168,000
Brigantine	\$37,997,000	Mullica	\$3,090,000
Avalon	\$37,841,000	Galloway	\$2,906,000
Wildwood	\$36,102,000	Cape May Point	\$2,720,000
Little Egg Harbor	\$33,981,000	Linwood	\$2,573,000
Margate City	\$28,530,000	Wall	\$2,474,000
Point Pleasant	\$28,009,000	Brielle	\$2,333,000
Bay Head	\$27,066,000	Belmar	\$1,989,000
Manasquan	\$26,571,000	Avon-by-the-Sea	\$1,969,000
Stone Harbor	\$25,008,000	Neptune	\$1,902,000
Ship Bottom	\$24,660,000	Barnegat	\$1,786,000

Stafford	\$24,308,000	Island Heights	\$1,711,000
Pt Pleasant Beach	\$23,860,000	Port Republic	\$1,534,000
Egg Harbor	\$23,113,000	Spring Lake	\$1,436,000
Ventnor City	\$21,304,000	Corbin City	\$1,268,000
Lavallette	\$21,111,000	Dennis	\$1,103,000
Surf City	\$20,869,000	Sea Girt	\$621,000
Cape May	\$20,732,000	Weymouth	\$483,000
Beach Haven	\$19,537,000	Beachwood	\$392,000
Berkeley	\$17,259,000	Pine Beach	\$303,000
West Wildwood	\$17,177,000	Northfield	\$235,000
Middle	\$16,636,000	Estelle Manor	\$210,000
Tuckerton	\$15,354,000	Lake Como	\$188,000
Somers Point	\$13,650,000	Washington	\$167,000
Harvey Cedars	\$11,974,000	Asbury Park	\$162,000
Lower	\$11,906,000	Neptune City	\$132,000
Wildwood Crest	\$11,189,000	Spring Lake Heights	\$128,000
Seaside Heights	\$10,706,000	Bradley Beach	\$125,000
Upper	\$10,666,000	Loch Arbour	\$93,000
Longport	\$10,400,000	Allenhurst	\$35,000
Lacey	\$8,760,000	Ocean (Monmouth)	\$21,000
Seaside Park	\$8,238,000	Interlaken	\$21,000
Ocean Gate	\$7,566,000	Lakewood	\$18,000
Barnegat Light	\$5,733,000	Egg Harbor City	\$18,000
Pleasantville	\$5,100,000	Deal	\$8,000
Ocean Township	\$4,981,000	Long Branch	\$5,000

TOTAL **\$1,571,616,000**

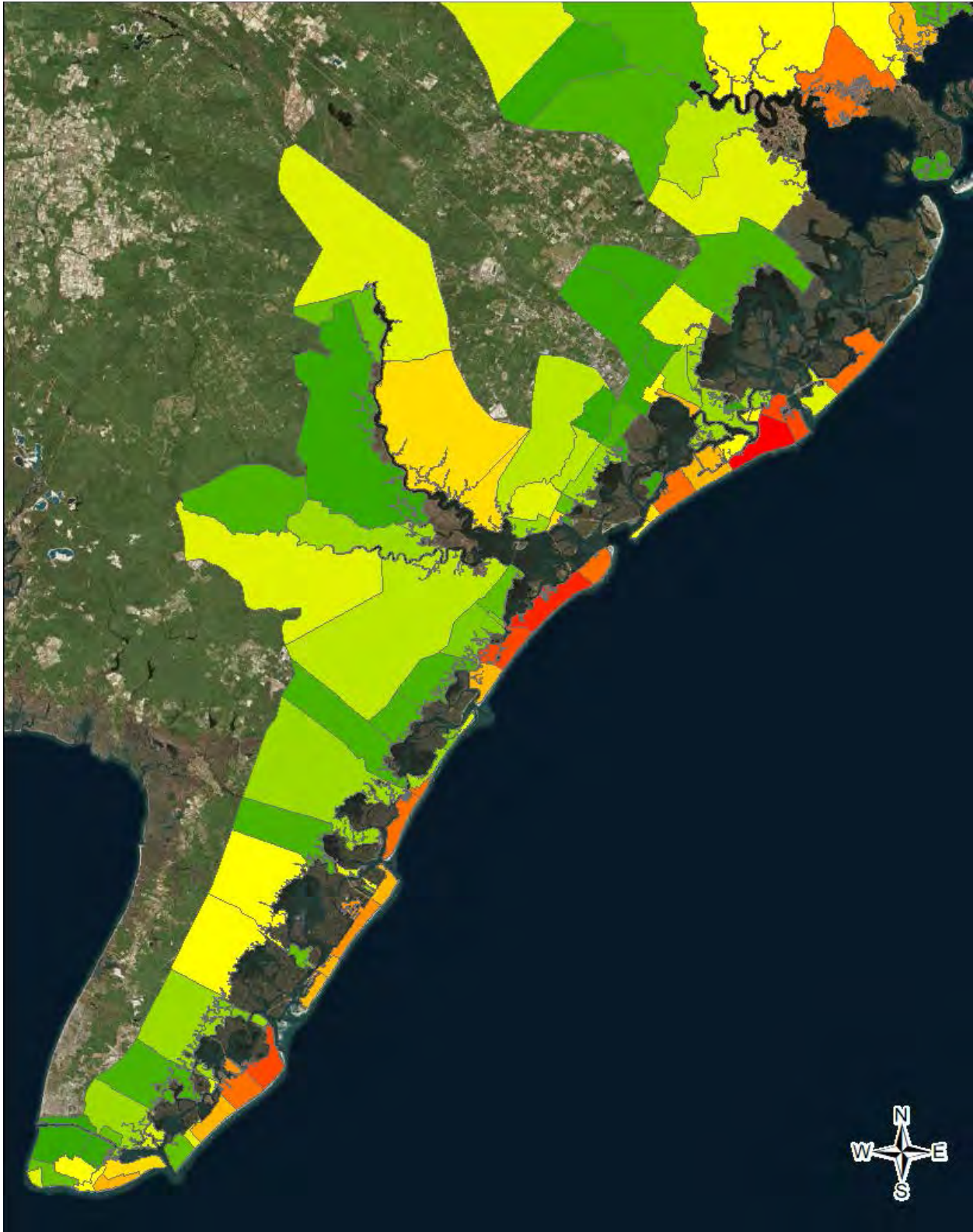

Figure 7-1: FWOP Damages - Heat Map (Cape May & Atlantic Counties). Red: High damages; Green: Low damages)

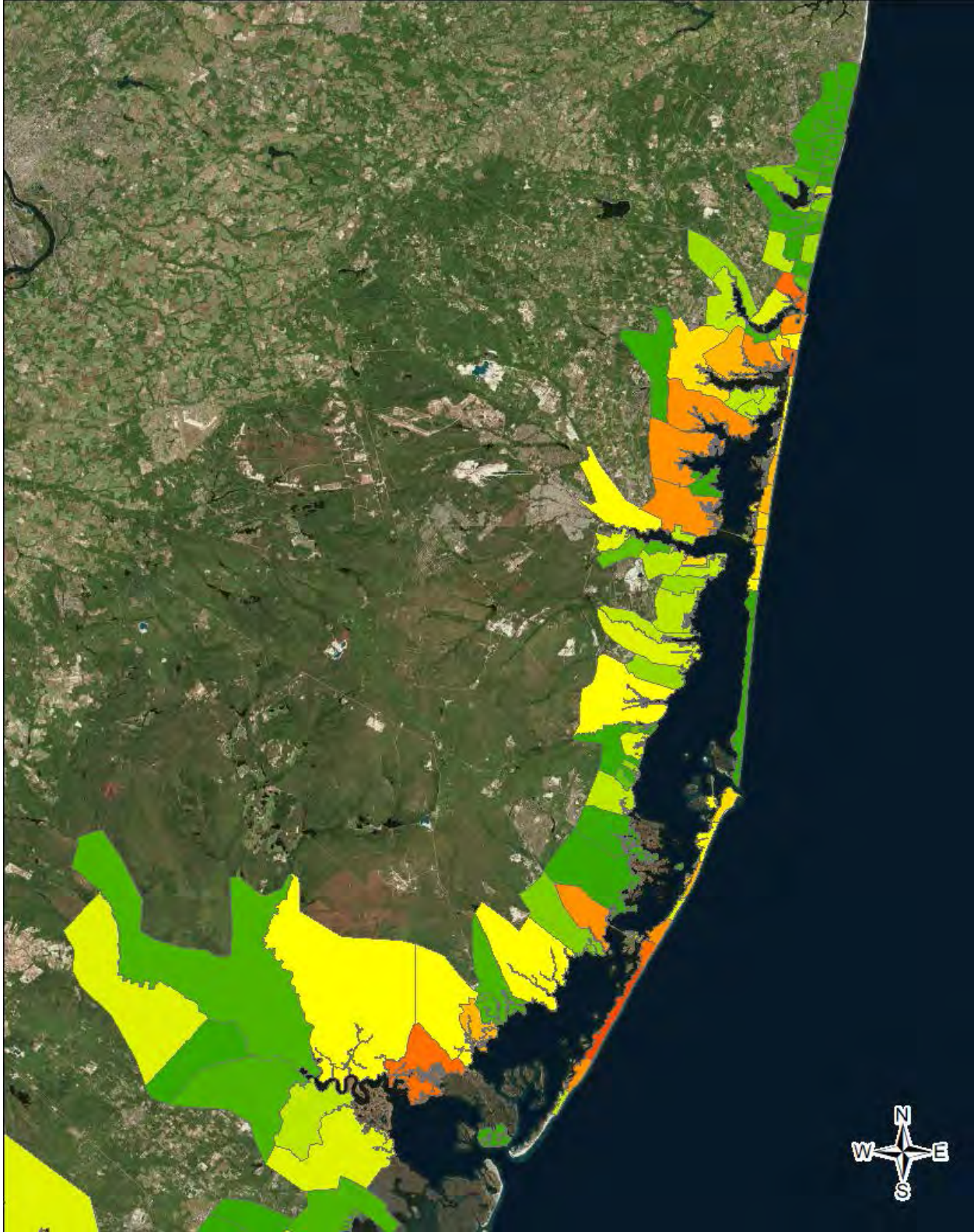

Figure 7-2: FWOP Damages - Heat Map (Burlington, Ocean and Monmouth Counties) Red: High damages; Green: Low damages)

For Burlington, Ocean, and Monmouth counties, damages are focused along the barrier islands, within the “finger canal” communities, and at the northern extent of Barnegat Bay. These areas share the same high density, high value, low elevation conditions.

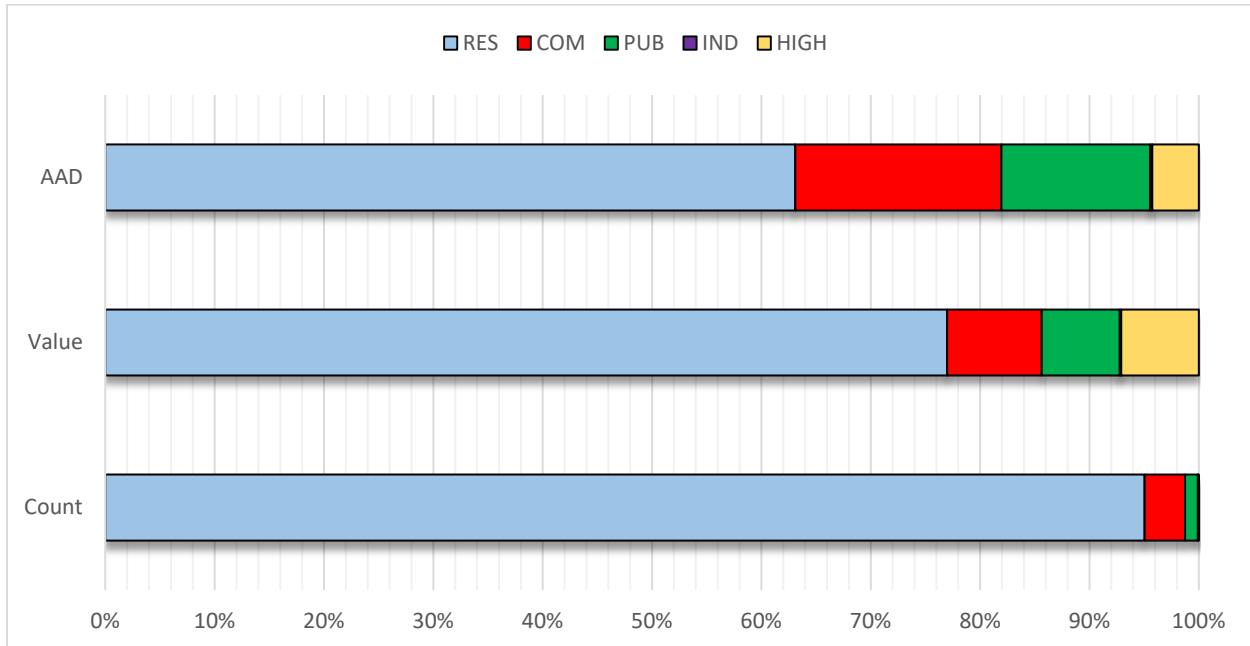

Figure 7-3: Comparison of Structure Count, Value and Average Annual Damages by Type

Figure 7-3 shows a comparison between structure count, structure/content value, and contribution to Average Annual Damages (AAD).

Residential structures represent over 95.0% of total structure by count, but only contribute 77.0% of total value by occupancy type and only 63.1% of total Average Annual Damages. Commercial and public structures represent 3.7% and 1.2% of total structures by volume, respectively, but contribute 18.9% and 13.6% of total AAD. Higher AAD estimates for commercial and public structures stem from their higher average structure/content value as well as greater risk to inundation due to lower foundation heights.

High-rise structures represent 7.1% of total inventory value, but only 4.3% of total AAD due to a relatively flat inundation damage curve.

8 Hydrodynamic Analyses

8.1 Vertical Datum

In accordance with ER 1110-2-8160 the NJBB Feasibility Study is designed to North American Vertical Datum of 1988 (NAVD88), the current orthometric vertical reference datum within the National Spatial Reference System (NSRS) in CONUS. The study area is subject to tidal influence and is directly referenced to National Water Level Observation Network (NWLON) tidal gauges and coastal hydrodynamic tidal models established and maintained by the NOAA. The current NWLON National Tidal Datum Epoch (NTDE) is 1983-2001.

More than one NWLON tidal gauge is required to reference tidal water levels to NAVD88 due to the vast size of the study area. The local NAVD88-MSL relationship at locations between gauges is estimated using NOAA VDatum models of the project region (EM 1110-2-6056). Hydrodynamic modeling completed for this study was performed in meters, MSL in the current NTDE. Water elevations are converted to ft., NAVD88 using NOAA VDatum.

8.2 Sea Level Change

8.2.1 Sea Level Change Guidance

Global sea level change (SLC) is often caused by the global change in the volume of water in the world's oceans in response to three climatological processes: 1) ocean mass change associated with long-term forcing of the ice ages ultimately caused by small variations in the orbit of the earth around the sun; 2) density changes from total salinity; and most recently, 3) changes in the heat content of the world's ocean, which recent literature suggests may be accelerating due to global warming. Global SLC can also be caused by basin changes through such processes as seafloor spreading. Thus, global sea level, also sometimes referred to as global mean sea level, is the average height of all the world's oceans.

Relative (local) SLC is the local change in sea level relative to the elevation of the land at a specific point on the coast. Relative SLC is a combination of both global and local SLC caused by changes in estuarine and shelf hydrodynamics, regional oceanographic circulation patterns (often caused by changes in regional atmospheric patterns), hydrologic cycles (river flow), and local and/or regional vertical land motion (subsidence or uplift). Relative SLC in the study area is higher than global SLC.

In accordance with ER 1100-2-8162, potential effects of relative sea level change (RSLC) were analyzed over a 50-yr economic analysis period and a 100-yr planning horizon. ER 1100-2-8162 requires planning studies and engineering designs consider three future sea level change scenarios (low, intermediate, and high) and consider how sensitive and adaptable the alternatives are to the range of SLC scenarios. The historic rate of SLC represents the "low" rate. The "intermediate" rate of SLC is estimated using the modified National Research Council (NRC) Curve I. The "high" rate of SLC is estimated using the modified NRC Curve III. The "high" rate exceeds the upper bounds of IPCC estimates from both 2001 and 2007 to accommodate the potential rapid loss of ice from Antarctica and Greenland, but it is within the range of values published in peer-reviewed articles since that time.

8.2.2 Historical and Projected SLC

Historical RSLC for this study (1.3 ft. per century) is based on NOAA tidal records at Atlantic City, NJ. USACE low, intermediate, and high SLC scenarios over the 100-yr planning horizon at Atlantic City, NJ are presented in **Table 8-1** and **Figure 8-1**. Water level elevations at year 2030 are expected to be between 0.5 and 1.0 ft. higher than the current NTDE. Water elevations at year 2080 are expected to be between 1.15 and 4.02 ft. higher than the current NTDE.

Hydrodynamic modeling performed for this study was completed in the current NTDE. Therefore, the modeled water levels represent MSL in 1992. Future water levels are determined by adding the SLC values in **Table 8-1**. For example, a water level elevation of 10 ft. NAVD88 based on the current National Tidal Datum Epoch (1983-2001), will have an elevation in the year 2080 of 11.15, 11.84, and 14.02 ft. NAVD88 under the USACE low, intermediate, and high SLC scenario respectively.

Table 8-1: Relative Sea Level Change Projections for Study Area

Year	USACE - Low (ft., MSL ¹)	USACE - Int. (ft., MSL ¹)	USACE - High (ft., MSL ¹)
1992	0.00	0.00	0.00
2000	0.11	0.11	0.13
2019	0.35	0.42	0.62
2030	0.50	0.63	1.03
2050	0.76	1.06	2.01
2080	1.15	1.84	4.02
2100	1.41	2.54	5.74
2130	1.81	3.50	8.87

¹Mean Sea Level based on National Tidal Datum Epoch (NTDE) of 1983-2001

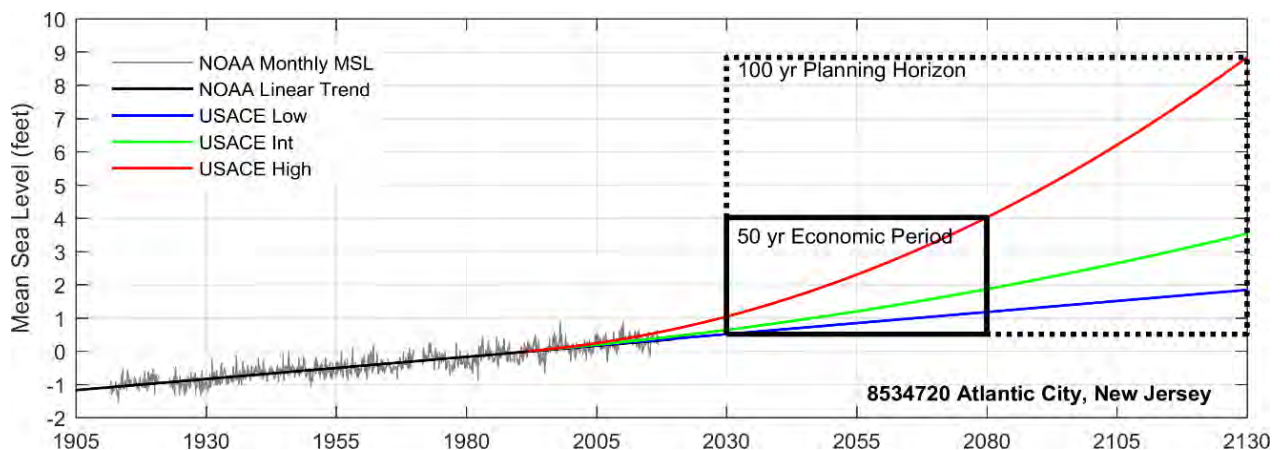

Figure 8-1: Relative Sea Level Change Projections for Study Area

8.3 High Frequency Flooding

High-frequency flooding, also known as nuisance flooding, recurrent flooding, or sunny-day flooding, are flood events caused by tides and/or minor storm surge that occur more than once per year. High-frequency flooding mostly affects low-lying and exposed assets or infrastructure, such as roads, public storm-, waste- and fresh-water systems (Sweet et. al 2018) and is likely more disruptive (a nuisance) than damaging. However, the cumulative effects of high-frequency flooding may be a serious problem to residents who live and work in these low-lying areas. The number of high-frequency flood days is accelerating in the study area in response to RSLC.

Flooding from rainfall and inadequate storm water systems are closely related to high-frequency flooding but are treated separated in this study. It is common for municipalities in the study area to have gravity based storm water systems that are unable to drain water when tidal level exceeds the elevation of the storm drain. When this happens, water starts ponding around the drain and may flood many of the same low-lying areas as high-frequency flooding. The frequency and impact of rainfall flooding will increase as the probability of the tide level exceeding storm drains will increase in response to RSLC. Some municipalities are addressing this problem by installing pump stations that are capable of draining water during elevated water levels.

The primary focus of the NJBB study is managing risk to severe storm surge events (i.e. Hurricane Sandy), not flooding associated with inadequate storm sewer systems and/or high-frequency flooding. It is USACE policy (ER 1165-2-21) that storm water systems are a local non-federal responsibility. While flooding from high frequency flooding and inadequate storm water systems is not the focus of the NJBB study, it is acknowledged that nonstructural and storm surge barrier measures may not provide any relief from these problems. Therefore, complementary measures to address these problems will likely be investigated and may be recommended as part of a comprehensive Federal project or recommended for implementation at the local non-federal level.

8.3.1 National Weather Service Flood Stages

The National Weather Service (NWS) with the help of NOAA and USGS provide real time flood status of stream gauges and tidal stations. The National Weather Service (NWS) has established three coastal flood severity thresholds: minor, moderate, and major flood stages. The NWS minor and moderate flood stages are the most representative of high-frequency flooding events right now. However, all three flood stages will be evaluated since NWS major flood stage could eventually occur at frequency consistent with high-frequency flooding in the future in response to RSLC.

The definition of minor, moderate, and major flooding is provided herein by NWS. The definitions are taken from the NWS website for Atlantic City, NJ so that impacts are specific to Ocean and Atlantic County. However, impacts experienced described at this station are generally representative of the entire study area.

- **Minor Flooding** - Minimal or no property damage, but possibly some public threat;
- **Moderate Flooding** - widespread flooding of roadways begins due to high water and/or wave action with many roads becoming impassable in the coastal communities of Ocean County and Atlantic County. Lives may be at risk when people put themselves in harm's way. Some damage to vulnerable structures may begin to occur;

- Major Flooding** - flooding starts to become severe enough to begin causing structural damage along with widespread flooding of roadways in the coastal communities of Ocean County and Atlantic County. Vulnerable homes and businesses may be severely damaged or destroyed as water levels rise further above this threshold. Numerous roads become impassable and some neighborhoods may be isolated. The flood waters become a danger to anyone who attempts to cross on foot or in a vehicle.

An example of the flood inundation area associated with the three NWS Flood stages is shown in **Figure 8-2** at Ventnor Heights, Chelsea Heights, and Absecon Island. The impact of minor flooding (orange) can be seen to be very limited to a few particularly low-lying areas. The impact of moderate flooding (red) is more widespread impacting some streets and properties and major flooding (purple) is widespread impacting several streets and blocks near the bay shoreline.

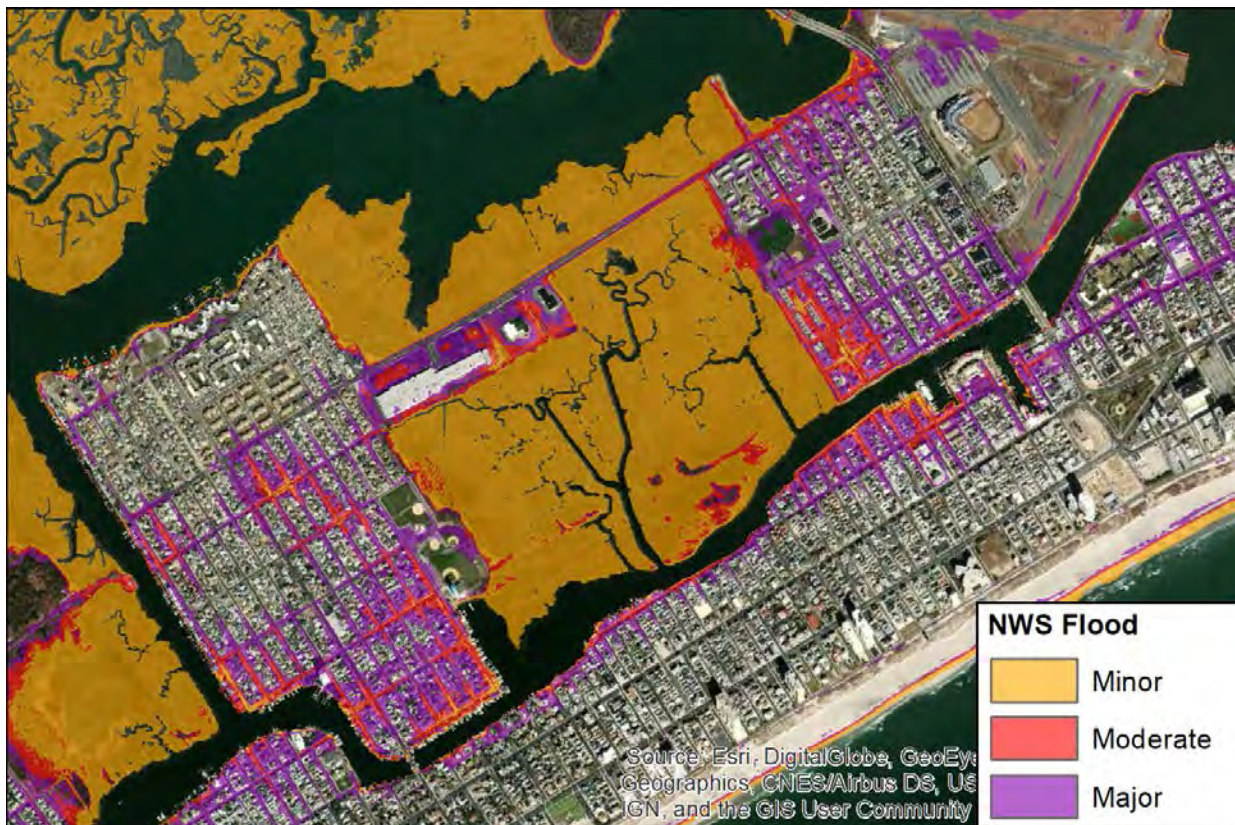

Figure 8-2: Floodplain associated with NWS Stages at Atlantic City, NJ

8.3.2 Historical and Future High-Frequency Flooding

Atlantic City, NJ has the longest tidal record (1911-Present) out of any of NOAA or USGS stations and is therefore best suited for investigating how often high-frequency flooding has occurred in the past and how the rate of flooding has been affected by historical RSLC. The number of days in which the daily maximum water level equaled or exceeded the NWS flood stages was tabulated for every year since 1911. Future high-frequency flooding is estimated by repeating the last 25 years of NOAA tidal records (1992-2017) over and over again with the three USACE SLC

projections added. An example of the approach using the USACE Low SLC scenario is shown in **Table 8-2** with historical and future projected hourly water levels and a color-coded dot for any day in which the NWS flood stages were exceeded.

Annual NWS flood days from the analyses are tabulated in **Figure 8-3**. It is difficult to say or know what the tipping point (days per year) is for NWS minor, moderate, and major flooding before the impacts to roads and infrastructure are unacceptable. However, the analysis shows that major investments in high frequency flood measures and storm water systems are likely to be required in the future for portions of the study area that could otherwise become inhabitable.

Table 8-2: High-Frequency Flood Occurrences (Per Year)

Year	NWS Minor Flood			NWS Moderate Flood			NWS Major Flood		
	Low	Int.	High	Low	Int.	High	Low	Int.	High
1930	1.1			0.0			0.0		
1955	1.7			0.2			0.1		
1980	3.6			0.5			0.2		
2005	14.5			0.7			0.0		
2015	26.5			2.2			0.5		
2030	54.7	73.2	139.8	4.7	5.9	21.1	0.1	0.3	1.0
2055	98.0	164.5	325.8	9.5	25.5	191.6	0.5	2.1	37.7
2080	153.8	282.6	356.2	23.1	100.9	349.9	1.5	11.1	298.3
2105	218.6	342.0	356.3	50.1	243.2	356.3	4.4	69.6	356.3
2130	258.5	350.6	352.3	78.1	327.3	352.3	5.8	182.3	352.3

Note: 10-year running mean filter applied to determine annual flood occurrences

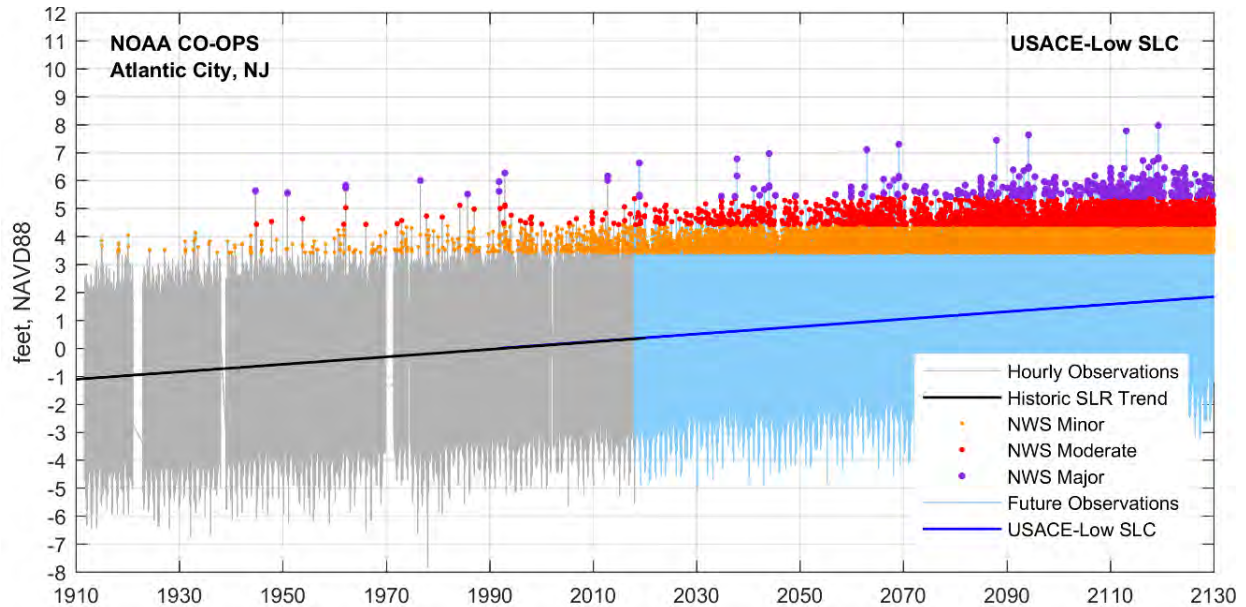

Figure 8-3: Historical and Future High Frequency Flooding with USACE Low SLC

8.4 Storm Surge Modeling

8.4.1 NACCS

As part of the NACCS, the US Army Engineer Research and Development Center (ERDC) completed a coastal storm wave and water level modeling effort for the U.S. North Atlantic Coast. This modeling study provides nearshore wind, wave, and water level estimates and the associated marginal and joint probabilities critical for effective coastal storm risk management. This modeling effort involved the application of a suite of high-fidelity numerical models within the Coastal Storm Modeling System (CSTORM-MS) to 1050 synthetic tropical storms and 100 historical extra-tropical storms. Documentation of the numerical modeling effort is provided in Cialone et al. 2015 and documentation of the statistical evaluation is provided in Nadal-Caraballo et al. 2015. Products of the study are available for viewing and download on the Coastal Hazards System (CHS) website: <https://chs.erdcdren.mil/>.

8.4.2 Modifications for NJBB

The USACE Engineer Research and Development Center (ERDC), Coastal and Hydraulics Lab (CHL) conducted a numerical modeling study to evaluate the effectiveness of storm surge barriers in reducing water levels in the study area. ERDC-CHL leveraged the existing NACCS CSTORM-MS complete the numerical modeling study. As part of this numerical modeling study the existing condition water levels in the study area were updated from NACCS to ensure that the existing and with-project water levels were consistent and derived from a common model, set of storms, and statistical evaluation.

The ERDC-CHL numerical modeling study reused the CSTORM-MS developed for NACCS. While the original mesh boundary was maintained, Chesapeake Bay and coastal Long Island in the NACCS grid were subject to a “de-refining” procedure, which locally reduces a mesh

resolution in areas that are distant from the area of interest. The model bathymetry was only updated to raise the barrier islands elevations from Manasquan to Lower Cape May Meadows to represent 2018 existing conditions with the recent construction of several USACE beach restoration projects that were not captured in the original NACCS model.

A total of 1,050 synthetic tropical cyclones were designed and simulated in the NACCS. However, not all of these storms affect the NJBB region. Using Gaussian process metamodeling (GPM) and a design of experiments (DoE) approach, CHL selected a subset of the NACCS synthetic tropical cyclones to maximize coverage of the storm parameter and probability spaces and produce storm surges across the NJBB region while reducing the hydrodynamic modeling requirements. A set of approximately 60 tropical cyclones was selected for modeling in order to complete the frequency distributions of response for both the with- and without-project conditions. Although the subset of storms does not include extratropical storms (nor'easters) the combined frequency distributions for both tropical and extratropical storms is generated by CHL using GPM.

8.4.3 NACCS Water Levels

Storm events are often defined according to their likelihood of occurring in any given year at a specific location. The most commonly used definition is the “100-year storm”. This refers to a storm with a “recurrence interval” or “return period” of 100 years and is equivalent to a storm that has a 1 in 100, or 1-percent chance of being equaled or exceeded in any year (i.e., 1-percent “annual exceedance probability”).

A common misinterpretation is that a 100-year storm is likely to occur only once in a 100-year period. In fact, a second 100-year storm could occur a year or even a week after the first one. The term only means that the average interval between storms greater than the 100-year storm over a very long period (say 1,000 years) will be 100 years. However, the actual interval between storms greater than this magnitude will vary considerably.

The probability of exceedance describes the likelihood of a specified flood or storm event being exceeded in a given year. There are several ways to express the annual chance of exceedance (ACE) or annual exceedance probability. The ACE is expressed as a percentage. An event having a one in 100 chance of occurring in any single year would be described as the one percent ACE event. This is the current accepted scientific terminology for expressing chance of exceedance. The annual recurrence interval, or return period, has historically been used by engineers to express probability of exceedance.

Figure 8-4 is presented to show the 1% ACE still water elevations for existing conditions as modeled during the NACCS. The salient point illustrated in **Figure 8-4** is the relatively lower modeled flood elevations in the northern portion of the study area, Barnegate Bay, compared to the southern portion. **Table 8-3** presents the ACE water levels at several locations throughout the study area.

Table 8-3: Water Level ACE in Study Area

Location	Save Point	Return Period (years)					
		1	10	20	50	100	500
		Annual Chance Event					
		100%	10%	5%	2%	1%	0.2%
Cape May	15566	3.9	7.1	7.9	9.2	10.4	12.9
Wildwood	11282	4.0	7.4	8.1	9.2	10.5	13.5
Avalon	13470	3.9	6.9	7.7	9.2	10.6	14.0
Strathmere	7531	4.1	7.0	7.8	9.2	10.4	13.9
Ocean City	11309	4.2	6.9	7.7	9.2	10.3	13.2
Atlantic City	11356	4.1	6.9	7.7	9.1	10.3	12.8
Mystic Island	11273	4.2	7.0	7.9	9.3	10.7	13.4
Lavallette	13694	2.9	5.2	6.1	7.6	8.8	11.2
Point Pleasant	13716	4.0	6.4	7.2	8.7	9.9	12.0
Belmar	13721	4.3	7.2	8.1	9.3	10.3	12.3
Asbury Park	3742	4.0	6.6	7.3	8.4	9.6	12.6

Note: All elevations are in ft. NAVD88, relative to NTDE (1983-2001)

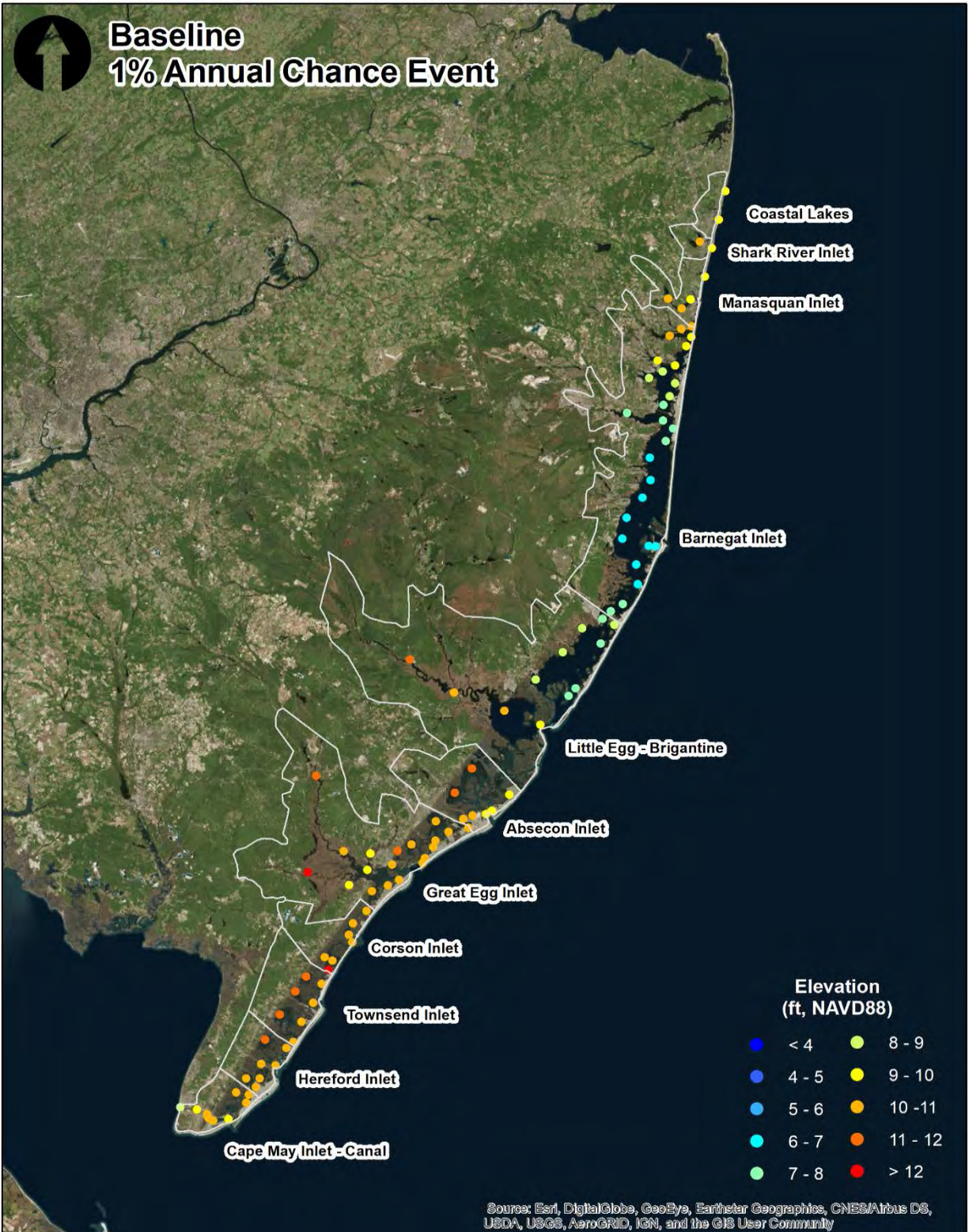

Figure 8-4: NACCS 1% ACE Peak Water Levels

8.5 Total Water Level and Crest Elevations

8.5.1 Total Water Level Components

The total water level component analysis identifies all the contributions to the water surface elevation applied in the design structural crest elevations. The significant water level components for the NJBB study area are shown below:

- **Mean Sea Level**
 - Mean Sea Level (MSL), a tidal datum, is mean or average sea level computed over a 19-year period, known as the National Tidal Datum Epoch (NTDE). The present 19-year reference period used by NOAA is the 1983-2001 NTDE.
 - Relative SLC is a combination of both global and local SLC including local vertical land motion (subsidence or uplift).
- **Astronomical Tide** is the semi-diurnal (twice daily) periodic rise and fall of a body of water resulting from gravitational interactions between Sun, Moon, and Earth.
- **Non-Tidal Residuals**
 - Seasonal variations in sea level from regular fluctuations in coastal temperatures, salinities, winds, atmospheric pressures, and ocean currents.
 - Interannual variations in sea level from irregular fluctuations in coastal temperatures, salinities, winds, atmospheric pressures, and ocean currents (El Niño).
 - Storm surge is the increased water level due to storm winds over the ocean and the resultant wind stress on the ocean surface.
- **Wave-induced Components**
 - Wave Setup is the increase in water level from wave breaking in the nearshore.
 - Freeboard is additional height of a structure (i.e. levee, floodwall) above the still water level required to limit wave overtopping below a tolerable discharge. On sloped structures such as levees the freeboard height is related to wave runup.

8.5.2 Design Crest Elevations

Preliminary crest elevations for structural measures (floodwalls, levees, storm surge barriers) are based on the 1% annual chance water level with 50% assurance provided in the NACCS hazard curves. The 50% assurance implies that there is 50% chance, or coin flip, that the 1% ACE (100-year return period) will have a water level greater. An alternative way to report the preliminary design water levels are at a 90% assurance and the 4% ACE (25-year return period) water level.

It is emphasized that there is no policy requirement that USACE projects be designed to the 1% annual chance water level or any minimum performance standard. In subsequent phases of the NJBB Feasibility Study the performance of the measures will be optimized to maximize NED benefits, which could result in higher or lower performance. The decision to design structures to the 1% ACE water level at this stage of the study is consistent with the parametric designs in NACCS and ECB 2013-33 that required all Sandy rebuilding projects receiving funds for

construction under the Sandy supplemental (Public Law 113-2) be meet a flood risk reduction standard of one foot above the best available and most recent base flood elevation. The 1% ACE water levels used for design are equal to or greater than observed water levels during Hurricane Sandy.

The relative contribution of each respective total water level component at three representative structure locations is provided in **Table 8-4**. A total water elevation relative to the NAVD88 vertical datum is based on MSL or the combined contribution from the NACCS hazard curve (shaded in grey), all other components reported are added to MSL or the NACCS hazard curve. Conceptual design of floodwalls, levees, and interior bay closures are based on a crest elevation of 13 ft. NAVD88. Conceptual design of storm surge barriers at inlets are based on a crest elevation of 20 ft. NAVD88. Additional refinement and granularity will be included in design crest elevations in subsequent phases of the Feasibility Study.

Table 8-4: Total Water Level Components

Component	Ocean City (ft.)		Lavellette (ft.)		Storm Surge Barrier (ft.)	
MSL (ft., NAVD88)	-0.40	9.4 ²	0.0	7.2 ²	-.40	9.0 ²
Astronomical Tide	1.6 ¹		1.1 ¹		1.6 ¹	
Storm Surge	8.0		5.9		7.2	
Wave Setup	0.2		0.2		0.6	
Relative SLC	2.0		2.0		2.0	
Seasonal Variations	0.3		0.3		0.3	
Interannual Variations	0.3		0.3		0.3	
Freeboard	0.6 ³		0.5 ³		9.0 ³	
Total Water Level (ft., NAVD88)	12.6		10.3		20.6	

Notes: ¹MHW shown; ²Value from NACCS hazard curve in ft., NAVD88; ³Freeboard based on wave overtopping of vertical wall.

The NACCS numerical modeling results and water level hazard curves include several of the total water level components: MSL, astronomical tide, storm surge, and wave setup. The water level hazard curves represent the joint probability of all the components combined and the exact relative contribution of each component is not well defined. However, the relative contribution of each component is estimated here based on the well-known tidal amplitudes (MHW) and approximate estimates of wave setup based on the wave heights.

Relative SLC is included by adding 2 ft., rounded value of the USACE Intermediate SLC scenario in 2080. The required freeboard for each structure was determined based on wave overtopping calculations and tolerable overtopping rate. Seasonal variations in sea level are included based on average seasonal fluctuation during peak hurricane season (August, September, October) observed NOAA tidal gauge at Atlantic City. Interannual variations in sea level are included based on typical peaks observed at Atlantic City over the last 20 years.

In subsequent phases of the NJBB Feasibility Study the performance of the measures will be revisited and optimized to maximize NED benefits, which could result in higher or lower performance crest elevations. The performance and adaptability of the measures to all three SLC scenarios will be incorporated in the optimization process.

9 Plan Formulation Process

9.1 Plan Formulation Synopsis

A comprehensive CSRM risk reduction plan for the NJBB study area has been developed to address the previously identified problems and opportunities and avoiding the constraints where possible. Plan formulation has focused on meeting the Federal objective of water resources project planning which is to contribute to the National Economic Development (NED) consistent with protecting the Nation's environment, pursuant to national environmental statutes, applicable executive orders, and other Federal planning requirements. Plan formulation also considers the effects to each of the four evaluation accounts identified in the Principles and Guidelines (ER 1105-2-100) (1983) which include the NED, Regional Economic Development (RED), Environmental Quality (EQ), and Other Social Effects (OSE). The four Planning Criteria including effectiveness, efficiency, acceptability and completeness identified in the Principles and Guidelines (ER 1105-2-100) (1983) were also considered in plan formulation. The NJBB study is guided by the principle of iterative planning, which encourages risk-informed decision making and the appropriate levels of detail for each round of alternatives formulation. Initial steps in the plan formulation process are broad-based analyses followed by more specific, detailed analyses during successive levels of the plan formulation process. Throughout the study, the study team will: a) Use existing data and tools as applicable including the NACCS Tier 2 evaluation and state and local datasets (county, municipal, nongovernmental organizations, and academic institutions; b) coordinate with and leverage other federal, state and NGO resilience projects, studies and efforts; and c) integrate federal and state agency, public and stakeholder outreach comments as gathered through the series of NJBB outreach events.

The plan formulation phase follows the Corps of Engineers traditional 6-step planning process. The plan formulation process in the initial part of the study consisted of identifying the potential management measures, scoring those measures against the Problem/Opportunity matrix, scoring the measures against the four planning criteria for Effectiveness, Efficiency, Acceptability, and Completeness (ER 1105-2-100). These measures were then ranked and grouped into three alternatives; 1-Preserve, 2-Accommodate, 3-Avoid based on the characteristics of that Alternative established in the NACCS. Their rank of each measure was based on their contributions to the Problem/Opportunity matrix combined with how well they scored against the four planning criteria.

The NJBB plan formulation process includes the integration of the Principles and Guidelines (ER 1105-2-100) (1983) 6-step planning process, including the following steps:

- Step 1 – Identifying Problems and Opportunities
- Step 2 – Inventorying and Forecasting Conditions
- Step 3 – Formulating Alternative Plans
- Step 4 – Evaluating Alternative Plans
- Step 5 – Comparing Alternative Plans
- Step 6 – Selecting a Plan

The preliminary focused array of alternative plans identified as part of this Interim Feasibility Study and Environmental Scoping Document is consistent with the findings and recommendations of the North Atlantic Coast Comprehensive Study (NACCS). The NACCS risk management framework is designed to help local communities better understand changing flood risks

associated with climate change and to provide tools to help those communities better prepare for future flood risks. In particular, it encourages planning for resilient coastal communities that incorporates wherever possible sustainable coastal landscape systems that takes into account, future sea level and climate change scenarios. The process used to identify the preliminary focused array of alternative plans herein utilized the NACCS framework that included evaluating alternative solutions and also considering future sea level change and climate change.

This report includes a detailed discussion of the preliminary focused array of alternative plans and includes analyses through Step #5 (Comparing Alternative Plans) of the 6-step planning process. Plan formulation analyses can be divided into four distinct phases including:

- 1) CSRM management measure inventory and screening. This analysis includes Steps 1-3 of the Principles & Guidelines 6-step process. The results of this analysis were presented at the Alternative Milestone Meeting in December 2016 and are discussed in detail in Section 9.2 and 9.3 below.
- 2) Alternative plan formulation and screening process, as discussed in Section 9.4 below.
- 3) Hybrid alternative plan evaluation and comparison, as discussed in Section 9.5 below.
- 4) Preliminary focused array of alternative plans, as discussed in Chapter 10 below.

The results of this analysis were presented at the tentatively selected plan (TSP) In-Progress Review Meeting held in December 2018. Continued analyses to compare alternative plans and subsequently plan selection will be accomplished later in the study following this report.

9.2 Coastal Storm Risk Management Measure Inventory and Screening

The NACCS full array of coastal storm risk management measures was used as the starting point for this study. The NACCS measures are the product of a 2-day working meeting on June 26-27, 2013 at Stevens Institute of Technology in Hoboken, NJ, with representatives from Federal, State, and local governments, as well as academia, NGOs, and private industry. A master list of all the measures identified was compiled at the conclusion of this meeting, then edited and filtered for duplication and consistency with study goals and objectives, and finally augmented based on a literature review.

The NACCS array of measures was refined for this study based on stakeholder feedback from two Planning Charrettes held on June 17, 2016 and June 21, 2016 and subsequent plan formulation sub-team meetings in June and July of 2016. The Planning Charrettes included representatives from Federal, State, and local governments, as well as academia and NGOs. The array of measures presented below represent a second layer of screening from the NACCS in order to reduce redundancy and focus on measures that are applicable only to the NJ back-bay environment. Measures are categorized by No Action, Non Structural, Structural, and Natural and Nature Based Features (NNBF). **Figure 9-1** provides diagrams of potential individual management measures for consideration in the NJBB Study, and **Figure 9-2** shows an example of how some of the coastal storm risk management measures could be used across the NJBB study area.

Although many of the categories generally correspond to standard coastal risk management strategies, specific applications are not constrained to the usual solutions. Opportunities for innovative designs, technologies, materials, and combinations of standard measures are

expected to be key to managing coastal risks and promoting resilience. Multi-purpose designs such as combining levees, bulkheads, and barriers with boardwalks and recreation paths or green infrastructure may enhance the utility of flood risk management measures.

MANAGEMENT MEASURES FOR CONSIDERATION

Structural

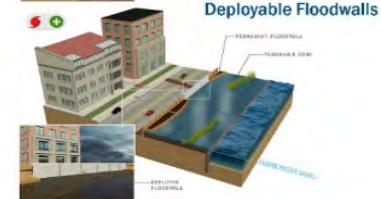
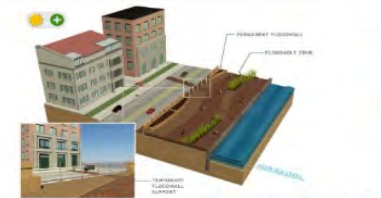
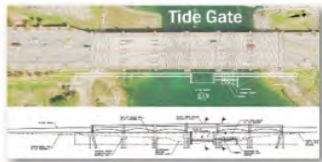

Non-structural



Relocation

Elevation or Acquisition

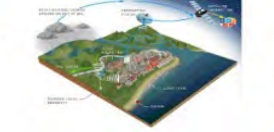
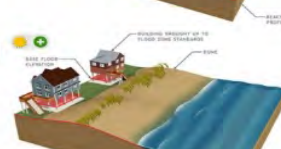
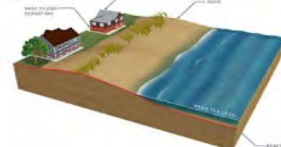
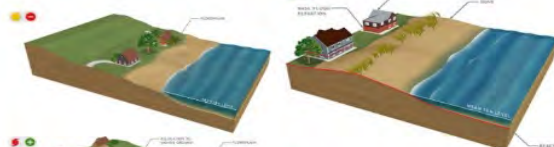

Natural and Nature-based

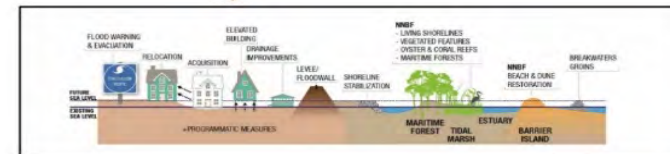
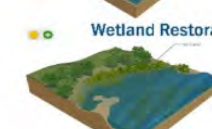
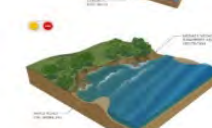
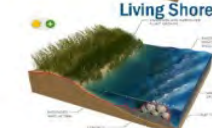
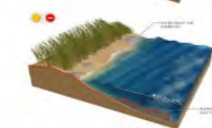
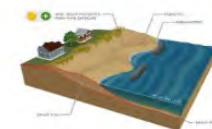
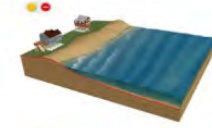

Figure 9-1: Potential Individual Management Measures for Consideration

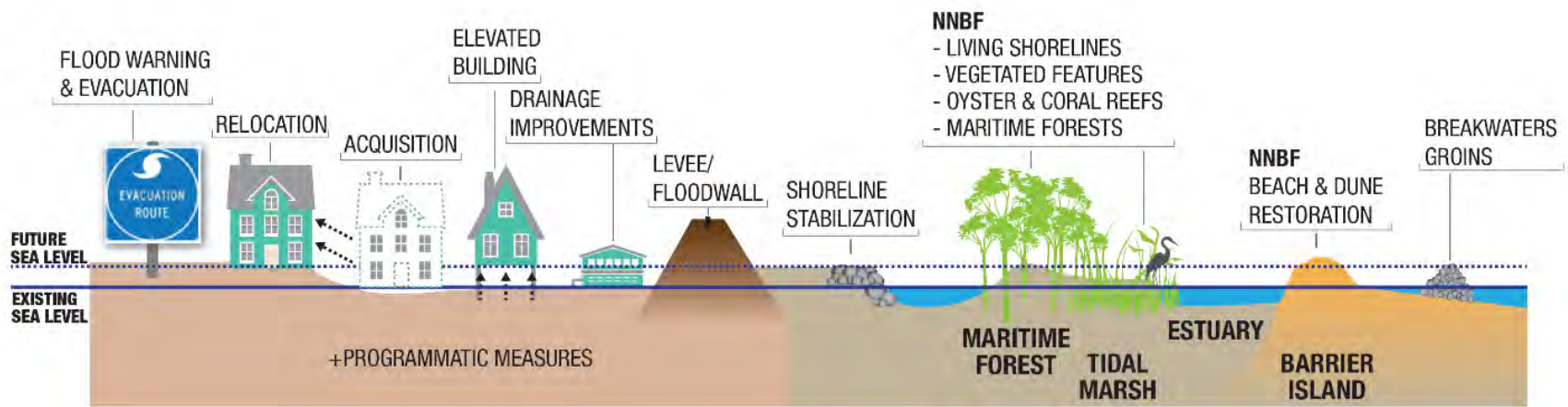

Figure 9-2: Examples of Management Measures across Coastal Landscape

9.2.1 No Action

The No Action plan provides no additional measures to provide flood risk management in the study area. The No Action plan represents the Future Without Project Condition against which alternatives plans will be evaluated.

9.2.2 Nonstructural Measures

Section 73 of the Water Resources Development Act of 1974 requires consideration of nonstructural alternatives (measures) in all flood risk reduction studies. They can be considered independently or in combination with structural measures (Corps Planning Guidance Notebook PGN). Planning Bulletin (PB 2016-01) signed on 22 December 2015 further clarifies Corps policy on nonstructural measures for the plan formulation phase on investigations and implantation. The Planning Bulletin clarifies that it is the policy of USACE to formulate a full array of alternatives consisting of nonstructural measures and structural measures and that not all nonstructural measures need to meet USACE criteria for agency participation and cost share implementation. It further clarifies that a 100% voluntary participation for acquisition, relocation and permanent evacuation is not considered a complete plan and is not acceptable for USACE participation. USACE participation must include the option to use eminent domain, where warranted, and costs for relocation, and should include the provision of relocation assistance under P.L. 91-646.

The definition of nonstructural is to reduce human exposure to a flood hazard without altering the nature or extent of the hazard. Nonstructural coastal storm risk management measures include acquisition and relocation, building retrofits, flood warning and evacuation planning, and programmatic considerations, such as land use and floodplain management and zoning. Additionally, conservation planning actions, including acquisition and the establishment of perpetual easements to increase the total acreage of undeveloped land and open space, to convert existing areas of privately owned and existing buildable properties into natural habitat along the coast could reduce risk by removing properties and people from potential direct damages from future coastal storm events (NRC 2014). The Project Development Team researched recent NGOs, university and Corps of Engineers guidance to determine nonstructural alternatives to reduce the risk from coastal flood events. Some of the measures listed in the nonstructural, managed retreat section will need to be combined with another measure in order to be effective.

Nonstructural management measures in general are intended to reduce the consequences that flooding would have to assets exposed to flood peril, as opposed to a structural measure that alters the characteristics or the probability of the flood peril to occur (USACE 2014b). Operation and maintenance costs of nonstructural measures are typically low, and are usually sustainable over long-term planning horizons (USACE 2014c).

1. Managed Coastal Retreat

This effort involves a series of different tools to reduce the level of development along a shoreline, reduce the number of repetitive losses, and limit the encroachment of private properties onto vulnerable shorelines through a series nonstructural efforts to be carried out at the municipal, state and federal level. Specific tools from the Columbia School of Law report on managed coastal retreat are listed below. Some of these measures are more valuable

along undeveloped shorelines where property and infrastructure is not as dense as it is along the New Jersey shoreline.

- a. Setbacks-Setbacks require property owners to locate structures at some distance from the shoreline. Setbacks are successful in communities that are not 100% built out and fully developed, or in the planning of new communities since they reduce the contact of damaging flood waters, erosion and waves. After the Ash Wednesday storm of 1962 the state of New Jersey established a building line or bulkhead line in coastal communities facing the Atlantic Ocean beyond which no structures could be built. New setback guidelines could be established for new construction, or re-construction that could reduce infrastructures exposure to storm events on the New Jersey Back Bay.

There are two main methods of establishing a setback distance, set distance and projected erosion rates. Set distances establish a fixed distance from the shoreward edge of a property to some fixed tidal landmark. Projected erosion rates can be established from historic erosion rates multiplied by a factor based on the level of risk for that structure. North Carolina and Florida have erosion setback based on erosion rates. North Carolinas Administrative Code for Coastal Hazard establishes a setback distance from the first line of vegetation (beach vegetation) depending on the size of the structure. For structures less than 5,000 square ft. the setback distance is 30 times the rate of annual erosion, for structures over 10,000 square ft. the setback distance is established at 90 times the rate of erosion.

- b. Rolling easements- A rolling easement can be a set distance from the established shoreline. They can be established to “roll” a set distance from the shoreline to allow communities to establish private property rights and public access to migrate landward with increased erosion and sea level rise. Rolling easement is a term used to refer to any public policy that protects lands in the public trust as the sea level “rolls” inland. A rolling easement grants the public access to a portion of the dry beach on a private property owner’s land and that rolls inland with the rising sea. This type of easement may also be important in areas of tidal encroachment that intersects with private property over time in order to protect public access to the shoreline as Defined in the Public Trust Doctrine. This public access enforcement principle was recently shot down in Severance vs. Patterson in the Texas Supreme Court in 2011 when the court ruled that unless a public easement was expressly included in the initial land grant, the state cannot rely on custom alone to secure public access.

Setback and rolling easements not only allow for protection of coastal properties by reducing their exposure to coastal floods, they allow for long term managed coastal retreat and for the reduction in repetitive loss properties. It is important to note that a setback conveys no right to the public as it is a building site restriction. But an easement grants the public as certain access rights under the Public Trust Doctrine.

- c. Exactions- An exaction is a condition tied to the granting of a development permit. The exaction requires the landowner to take some action or refrain from some action in order to mitigate the potential negative effects of the development. The

California Coastal Commission uses exactions to limit future armoring of the shoreline that may be harmful to the broader area or region.

- d. Mitigation fees - Mitigation fees are fees that are assessed to landowners who development actions burden or cause harm to other landowners and the public and can be used to fund further managed retreat strategies discussed in this section including buyouts, relocations, transfer development rights or green banks to fund local flood risk management project.
- e. Building restrictions – Building restrictions fall into two categories, limited resilient building and conditional rebuilding. Limited resilient building requires that damaged structures be replaced by structures that are more resilient to wave, erosion and inundation damages or be moved further from the coast, Conditional rebuilding requires property owners agree to certain conditions before they are allowed to rebuild. Owners might be asked to purchase additional insurance, to remove structures that may be threatened by erosion, or inundation, or be limited in the number of times they can rebuild. This is a tool to reduce the number of repetitive loses and is currently being promoted and implemented by FEMA in certain regions of the New Jersey Shore in a new post Sandy context.
- f. Zoning changes/overlay zoning/downzoning/un-inhabitability - Overlay zoning works in concert with existing zoning laws to apply an additional measure of approval for construction in high hazard coastal areas. Overlays can set development densities, building regulations, or setback requirements based on the location of the site in relation to flood sources. Downzoning reduces the use intensity of an existing zone by reducing densities or permitted use in the area. Specific downzoning techniques could change the classification of a zone from residential to conservation to reduce the development density. Un-inhabitability refers to the safety and livability of a coastal area in the face of coastal storms, sea level rise and erosion. Decision have to be made in communities that have high rates of erosion and exposure to coastal storms on whether the community is inhabitable in the long run in the face of these extreme events.
- g. Conservations easements – A conservation easement is a voluntary legal agreement between a landowner and an organization that limits specific activities in order to protect conservation values such as wildlife habitat, biodiversity or open space. Although the typical use for a conservation easement is to improve wildlife habitat, they could have the additional benefit of reducing damage to property from coastal storms if they reduce development densities and preserve land that is undeveloped, but slated for future development.
- h. Transfer Development Rights (TDRs) - TDRs are a market based mechanism intended to guide development toward preferred areas while limiting development in undesirable areas. The legal premise of the TDR ownership of the land is severable from the development rights. Developers in areas where development is desirable and encouraged can purchase the development rights from homeowners who are restricted in their development, in order to build in more desirable locations. So homeowners who are restricted from development through setback limits, or building restrictions, zoning changes, zoning overlays, can sell this development right to a developer in a separate onshore community in a high

density setting. TDR programs have not yet been employed to mitigate hazards caused by sea level rise, but they have been used to achieve a wide range of land use goals including the protection of agricultural lands, preservation of wildlife habitats and coastal resources and control of development densities. According to one estimate from 2012, there are 239 TDR programs in 35 states under development.

- i. Buyout programs (e.g. New Jersey Blue Acres) - Buyout programs are a specific type of acquisition program in which the government uses public funds to purchase title of privately held lands, demolishes existing structures on the land, and maintains the land in an undeveloped state for public use in perpetuity. Buyout programs can be conducted without the consent of the landowners by using eminent domain to acquire the lands, but most often buyout programs are conducted with voluntary sales from landowners who have recently experienced one of the disasters to which they are vulnerable. Buyout programs can be structured to provide financial incentives for owners who are uncertain about selling their property. Buyout programs can, reduce the exposure of people to dangerous conditions, reduce future disaster response costs by removing buildings and structures from the path of flooding, reduce future flood insurance payments, and assist homeowners by providing them with financial means to move from the floodplains and provide open space.
- j. Relocations/utility/residential managed retreat often emphasizes movement away from the vulnerable coasts without identifying areas that are available for development. This is true of most of the tools in this category but is particularly true of buyout programs where landowners are selling their homes and divesting their entire interest in the land. Having a relocation plan is crucial for maintaining communities, for gaining public support, and for long-term economic development.
- k. Eminent domain - Buyout programs are all voluntary programs, in which the homeowner has agreed to sell coastal property. However, the government can acquire shoreline properties using eminent domain, even without the consent of the owner, if the government pays the owner compensation and is pursuing a legitimate public purpose.

2. Building Retrofit

Building retrofit measures provide flood risk management to individual buildings. Retrofit measures include the following:

- a. Elevation - raising the existing structure on fill or foundation elements such as solid perimeter walls, piers, posts, columns, or pilings.
- b. Dry flood proofing - strengthening of existing foundations, floors, and walls to withstand flood forces while making the structure watertight.
- c. Wet flood proofing - making utilities, structural components, and contents flood- and water resistant during periods of flooding within the structure.
- d. Ringwall - construction of a floodwall around an individual structure.
- e. Replace building - demolition of the structure and subsequent building of an equivalent structure within the same property boundary to the design elevation.

FEMA's NFIP regulations require that the lowest floor of new and substantially improved residential structures be elevated to or above the base flood elevation. However, non-residential structures may be flood proofed below that elevation, provided that the structure is watertight, with walls that are impermeable to floodwaters. Elevation of an existing structure is usually limited to smaller buildings and depends on a number of factors, including the foundation type, wall type, size of structure, condition, etc. Other measures such as elevation of critical systems and abandoning lowest occupied floor and wet proofing the abandoned floor may be used to reduce flood risk and increase resilience.

In addition, short-term adaption measures may be used to increase resilience such as installing backflow valves to prevent water from flowing back into a home through sanitary/storm sewer systems, elevation or anchoring of heavy equipment like washing machines, bringing outside furniture inside the home.

3. Coastal Storm Plans and Preparedness

a. Hazard Mitigation Plans

Hazard mitigation is the effort to reduce loss of life and property by lessening the impact of disasters. It is most effective when implemented under a comprehensive, long-term mitigation plan. State, tribal, and local governments engage in hazard mitigation planning to identify risks and vulnerabilities associated with natural disasters, and develop long-term strategies for protecting people and property from future hazard events. The State of New Jersey and all five counties in the study area have FEMA-approved hazard mitigation plans.

b. Emergency and Evacuation Plans

Emergency and evacuation planning is imperative for areas with limited access, such as barrier islands, high density housing areas, elderly population centers, cultural resources, and areas with limited transportation options. When a coastal storm threatens many of the communities in the study area, the limited number of bridges and causeways that connect the islands with the mainland become overcrowded, making evacuations from the barrier islands to the mainland difficult. Timely evacuation depends on well-defined emergency evacuation plans used in conjunction with accurate flood forecasting.

The State of New Jersey Office of Emergency Management completed a hurricane evacuation study in 2007 with the support of the USACE and FEMA that provides the State of New Jersey with updated local and regional hurricane evacuation clearance times. The State also developed a hurricane survival guide and coastal evacuation maps. Prior to an emergency local, county or State emergency management officials notify neighborhoods of the need to evacuate or take other protective actions prior to the arrival of a storm event. This done via Emergency Alert System messages on local radio and TV. They may also alert entire areas via community notification systems such as "Reverse 911," which sends messages to home telephones.

c. Early Flood Warning Systems

A critical component of successful emergency and evacuation plans are early flood warning systems. Despite improved tracking and forecasting techniques, the

uncertainty associated with the size of a storm, the path, or its duration necessitate that warnings be issued as early as possible.

The National Hurricane Center and National Weather Service are responsible for preparing hurricane and nor'easter forecasts and warnings respectively. Both agencies are able to predict storm surge in real-time and assess potential storm surge flooding while the track of the storm is still changing. A limiting factor in the accuracy of early forecasts are predictions of storm track and intensity.

In addition to NHC and NWS storm surge forecasts, the New Jersey Tide Telemetry System (NJTTS) is able to report observed tidal elevations and weather data at 20 tide gauges, 5 tide/weather stations, and 31 tidal crest-stage gauges in 13 New Jersey counties. The tide level at each of the tide gauges is automatically transmitted by NOAA and to specific critical decision-making centers. Additional work needs to be accomplished with Early Flood Warning Systems so local flood risk managers understand the severity of each event as it relates to their location based on the surge forecast and the regional topography. Descriptions such as "high", "medium" and "low" risks for flooding, without definitions of what that means for local residents are not meaningful. Without two critical pieces of information, surge level compared to topography, a flood warning system may not communicate the specific level of risk to that community. More standardized systems, based on surge prediction networks, and local topography, and standardized elevation data can help local municipalities understand the risk for each surge event.

d. Public Education and Risk Communication

Hazard mitigation plans, emergency and evacuation plans, and early flood warning systems are of little value without communicating risk to local officials, community leaders, and decision-makers who are responsible for land use, evacuation planning, and implementation of mitigation measures. Public acceptability of coastal storm risk management measures, the difficulty individuals and communities have in understanding their own risk, and a lack of community engagement about coastal storm risk management options have all been cited as barriers to implementing good coastal management strategies.

Communities and residents often struggle navigating the complicated network of Federal, State, and local coastal programs. Hurricane Sandy generated huge public interest and awareness in flood risk management; however, it also led to several new initiatives and programs that may make communities feel overwhelmed and calloused to flood risk management opportunities.

4. National Flood Insurance Program Refinement

a. Increase homeowner participation

Residents that are uncertain about reducing risk to their belongings may be prone to attempt to remain in vulnerable areas during storm events, creating further risk. Knowing that personal property is insured, residents may be more comfortable with evacuating vulnerable areas at the approach of a storm. Flood insurance rates and regulations directly and indirectly impact property owners' decisions to reduce risk to their property through favorable construction practices.

b. Increase municipal participation in Community Rating System (CRS)

Community participation in the NFIP is conditional on meeting program guidelines. Participating communities must manage development within their floodplains in accordance with FEMA standards or risk removal from the program, which risks cancellation of all flood insurance policies within the community. Under the CRS, flood insurance premium rates are discounted to reward community actions that meet the three goals of the CRS, which are: (1) reduce flood damage to insurable property; (2) strengthen and support the insurance aspects of the NFIP; and (3) encourage a comprehensive approach to floodplain management. Participation in the CRS helps strengthen and enforce floodplain management policies.

c. Voucher system to assist lower income groups

One way to increase participation in the NFIP is a voucher system to provide assistance to lower income groups. Rising insurance rates and expanded flood plains have a greater burden on low income groups who may not be able to afford the increasing premiums associated with the Biggert-Waters Flood Insurance Reform Act.

5. Zoning Changes

Effective local floodplain management could potentially reduce the risk of flood peril even before the next storm event occurs. Communities at risk of flood peril have the regulatory authority to address local land use, zoning, and building codes to avoid siting development in floodplains. Communities participating in the NFIP must incorporate flood resistant construction standards into building codes. Local ordinances have been established in some municipalities to reduce impervious surfaces such as driveways and parking areas, promote uniform bulkhead elevations, and require buildings to have an additional 2-3 ft. of freeboard above the FEMA Base Flood Elevation (BFE).

An interagency task force could help municipalities incorporate climate change and sea level change in their planning, zoning, and adaptation plans.

9.2.3 Structural Measures

Structural coastal storm risk management measures are engineering solutions to manage flood risk and reduce damage from coastal storms. Typical structural solutions include levees, floodwalls, beaches, and dunes, which are intended to physically limit flood water inundation from causing damage. Although many of the structural measures generally correspond to standard coastal storm risk management strategies, specific applications are not constrained to the usual solutions. Opportunities for innovative designs, technologies, materials, etc., should be considered when evaluating specific application of any of these measures.

1. Inlet Storm Surge Barriers

Storm surge barriers reduce risk to back bay environments and estuaries against storm surge, flooding and waves. In most cases the storm surge barrier consists of a series of movable gates that stay open under normal conditions to allow navigation and tidal flow to pass but are closed during storm surge events. Storm surge barriers are often chosen as a preferred alternative during storm surge events and reduce the required length of flood protection measures behind the barriers. Storm surge barriers range in scale from small/local gates

reducing risk to a small coastal inlet to very large barrier “systems” reducing risk to a large estuary or bay and consist of a series of coastal dikes and gates. An example of the Seabrook Floodgate complex including a navigable sector gate and two vertical lift gates is provided in **Figure 9-3**.



Figure 9-3: Seabrook Floodgate Complex

2. Interior Bay Closures

Interior bay closures across the interior of the bay are essentially the same as storm surge barriers at the inlet. The only difference is location. Interior bay closures could be constructed across the interior of the bay and may be appropriate at locations where an Inlet Closure is not environmentally acceptable. Interior bay closures could be constructed adjacent existing roads, bridges and causeways with dynamic navigable gates across the NJIWW and additional auxiliary flow gates to allow tidal flow to pass under normal conditions.

3. Raised Roads and Rails

Existing road and rail networks may be raised to function as levees and reduce risk to storm surge flooding. Raised roads and rails can also enhance local evacuation plans and public safety by providing safer evacuation routes out of the area. Road and rail raising and could also be more acceptable to residents in some communities since it reduces the need for structural alterations to individual buildings that may disrupt the owners' lives and affect perceptions of property value.

4. Levees

Levees are earthen embankments with an impervious core constructed along a waterfront to reduce risk to flooding. Levees may be constructed in urban areas or coastal areas; however, large tracts of real estate are usually required due to the levee footprint. If a levee is located in an erosive shoreline environment, armoring may be needed.

5. Floodwalls (Permanent)

Floodwalls are vertical structures often constructed with steel or concrete that are used to reduce risk of flooding. Floodwalls are most frequently used in urban and industrial areas where smaller structure footprints are desired and there is limited space for large flood

protection measures. Two of the most common types of floodwalls are cantilevered I-walls and pile supported T-walls, both of these and other floodwall types will be considered in the study.

6. Deployable Floodwalls

Deployable floodwalls are vertical structures that can be rapidly deployed during a storm event to reduce the risk of flooding. Deployable floodwalls are particularly useful for flood risk management in smaller areas, and are usually considered for areas where access to the waterfront is essential to the economy or character of a community. Often, traditional floodwalls, or levees are used to reduce risk to some portions of the waterfront, with intermittent closure structures like a deployable floodwall.

7. Crown Walls

Crown walls are a relatively small reinforced concrete walls constructed on top of a new or existing vertical structure (bulkhead, seawall, curb, or gravity wall) to reduce the risk of flooding. Crown walls are relatively small structures, 1 to 3 ft., which are drilled and grouted to connect to the existing concrete surface.

8. Beach Restoration/Groins/Breakwaters

Beach restoration, also commonly referred to as beach nourishment or beachfill, typically includes the placement of sand fill to either replace eroded sand or increase the size (width and/or height) of an existing beach, including both the beach berm and dunes. Beach restoration reduce risk to storm surge flooding, waves, and erosion. Beach restoration is most applicable to areas with an existing beach. Additional erosion control measures such as groins and breakwaters may be included in a beach restoration project to reduce erosion and increase the longevity of the project and reduce future renourishment requirements.

9. Bulkheads

Bulkheads are vertical structures with the primary purpose of retaining land and preventing the sliding of land at the shoreline. Bulkheads are normally constructed in the form of a vertical wall built in concrete, stone, steel or timber. The concrete, steel or timber walls can be piled and anchored walls, whereas the concrete and stone walls can also be constructed as gravity walls. Their use is limited to those areas where wave action can be resisted by such materials. In areas of intense wave action, massive concrete seawalls are generally required. Bulkheads, unlike floodwalls and levees, are generally constructed at or near the existing grade and flood risk management is of secondary importance.

10. Seawalls

Seawalls are typically massive structures constructed along the shoreline whose primary purpose is interception of waves, prevention of upland erosion and reduction of wave-induced overtopping and flooding. If constructed with impermeable materials (not just stone) seawalls may also reduce flood risk to low-lying coastal areas.

11. Revetments

Revetments are sloped structures with the principal function of protecting the shoreline from erosion. Revetments typically constructed with cladding of stone, concrete, or asphalt to armor sloping natural shoreline profiles. Existing revetments may be retrofitted with an impermeable

concrete L-wall at the top of the revetment to increase the elevation of the structure by 1 to 3 ft. and reduce flood risk.

12. Storm water System Drainage Improvements

Storm water system and drainage improvements carry water away via conveyance systems during times of heavy rainfall or high tidal water. Conveyance systems utilize measures such as pump stations, culverts, drains, and inlets to remove water from a site quickly and send it to larger streams. Storage facilities are used to store excess water until the storm or flood event has ended. As an example, ecological methods such as wetland development would be helpful in storing water. An alternative as evidenced at Lake Lily at Cape May Point is to lower the lake's water levels prior to storm events to provide additional storage capacity. Improvements may also include retrofitting existing culverts and outfalls with flap gates and tide valves to prevent back flow during storm surge events, clearing storm drains. Tide levels have the potential to increase coastal flooding during non-storm events through increased water level superimposed on normal tidal ranges from sea level rise. Plan formulation that focuses on tidal encroachment, not flooding from overland flow from rainfall events, should be evaluated as part of the formulation process as it is likely to increase with long term increases in sea level from climate change.

9.2.4 Natural and Nature-Based Features (NNBF)

Natural Features are created and evolve over time through the actions of physical, biological, geologic, and chemical processes operating in nature. Natural coastal features take a variety of forms, including reefs (e.g., coral and oyster), barrier islands, dunes, beaches, wetlands, and maritime forests. The relationships and interactions among the natural and built features comprising the coastal system are important variables determining coastal vulnerability, reliability, risk, and resilience. Conversely, Nature-Based Features are those that may mimic characteristics of natural features, but are created by human design, engineering, and construction to provide specific services such as coastal risk reduction. The built components of the system include nature-based and other structures that support a range of objectives, including erosion control and storm risk reduction (e.g., seawalls, levees), as well as infrastructure providing economic and social functions (e.g., navigation channels, ports, harbors, residential housing). An integrated approach to coastal resilience and risk reduction will employ the full array of measures, in combination, to support coastal systems and communities.

1. Living Shorelines

Open and exposed shorelines are prone to erosion due to waves. Living shorelines are essentially tidal wetlands constructed along a shoreline to reduce coastal erosion. Living shorelines maintain dynamic shoreline processes, and provide habitat for organisms such as fish, crabs and turtles. An essential component of a living shoreline is constructing a rock structure (breakwater/sill) offshore and parallel to the shoreline to serve as protection from wave energy that would impact the wetland area and cause erosion and damage or removal of the tidal plants.

2. Reefs

The development of artificial reefs in bays provides a means to reestablish and enhance reef communities. Artificial reefs provide shoreline erosion protection through the attenuation of

wave energy. Artificial reefs are established for various reasons, amongst others: restore degraded or damaged natural reefs, provide three dimensional habitat structure above the bottom, and provide fishing and scuba diving opportunities.

The NJBB Study is also considering modifications that can be made to structural measures that can increase their habitat value including habitat benches to restore more natural slope along shorelines, and textured concrete to support colonization of algae and invertebrates.

3. Wetland Restoration

Wetlands may contribute to coastal flood risk management, wave attenuation and sediment stabilization. The dense vegetation and shallow waters within wetlands can slow the advance of storm surge somewhat and slightly reduce the surge landward of the wetland or slow its arrival time (Wamsley et al. 2010). Wetlands can also dissipate wave energy; potentially reducing the amount of destructive wave energy, though evidence suggests that slow-moving storms and those with long periods of high winds that produce marsh flooding can reduce this benefit (Resio and Westerlink 2008). The magnitude of these effects depends on the specific characteristics of the wetlands, including the type of vegetation, its rigidity and structure, as well as the extent of the wetlands and their position relative to the storm track.

Functionally restored wetlands act in the same manner as natural wetlands, though design features may be included to enhance risk reduction or account for adaptive capacity considering future conditions (e.g., by allowing for migration due to changing sea levels).

4. Submerged Aquatic Vegetation (SAV) Restoration

Submerged aquatic vegetation (SAV) are grasses that grow to the surface of shallow water, but do not emerge from the water surface. SAV performs many important functions, including: wave attenuation, buffer shorelines by stabilizing sediments with plant roots, water quality improvement, primary production, food web support for secondary consumers, and provision of critical nursery and refuge habitat for fisheries species.

5. Green Storm water Management

Green storm water management is a resilient approach that mimics nature to store and treat rainfall at its source. Green storm water management can be used to reduce runoff and increase the capacity of existing storm water systems and reduce the risk of flooding. Green storm water management includes measures such as rain gardens, bioswales, permeable pavements, rainwater harvesting, downspout disconnection, planter boxes, and green roofs.

9.3 Management Measure Screening Process

Screening is the process of eliminating management measures from the initial formulation list that do not resolve the problem/opportunities or the Planning Criteria. The list was derived from the specific planning study based on the planning problems, opportunities and constraints of the study/project area. Plans are also screened against the four Planning Criteria for Efficiency, Acceptability, Effectiveness and Completeness as defined in the ER 1105-2-100.

The initial screening (Cycle 1) of the management measures against the problems and opportunities was facilitated by the use of a problem/opportunity/management measure matrix. The measures were listed on the left hand side of the matrix while the weighted problems and opportunities were listed at the top of the matrix. The value assignment of problem/opportunity

weights was made to characterize the relative importance and was based upon the purpose of the study. Weighting was discussed among USACE staff and was based upon input from other flood risk management professionals from Federal and State agencies. Subsequently, measures were ranked with a score of 1, 0.5, or 0 based on that measure's ability to take advantage of that opportunity. Scores were tallied and ranked for each measure (**Figure 9-4**). Results are shown in **Table 9-1**.

The measures were further screened against the Four Planning Criteria (Cycle 2). The score from the initial screening was carried over to a second matrix, again with the measure listed on the left but this time with the Four Planning Criteria listed across the top. The measure received a score of 1, 0.5 or 0 if it was deemed to satisfy the Planning Criteria. Each Measure then received a score that reflected the percentage of the planning criteria it satisfied based on the score for the measure against a possible total of 4. A weighted score was calculated from the total Cycle 2 score divided by 4. The Cycle 2 screening results were then combined with the Cycle 1 results by multiplying the Cycle 2 weighted score by the Cycle 1 score for a combined score for each planning measure (**Figure 9-5**). These results can be seen in **Table 9-2**.

The results of the combined screening were grouped into the three Themed Measure Categories:

1. **Preserve** (also referred to as "Protect")

An adaptation strategy, sometimes termed "protect," that focuses on preserving the function or reliability of the given economic, social, and/or environmental system that is adversely affected by climate change (e.g., navigation channels continue to function reliably, coastal storm risk management measures continue to manage and reduce risk), and may include structural, nonstructural, NNBF measures.

2. **Accommodate**

An adaptation strategy that allows individuals and communities to adapt to sea level changes and other impacts as they occur over time. This strategy could include traditional nonstructural measures, such as elevation, flood proofing, and ring walls, along with improved implementation of NNBF measures.

3. **Avoid**

An adaptation strategy, sometimes termed "retreat," that seeks to avoid increasing impacts through traditional nonstructural activities, such as acquisition, to convert land to open space, providing natural infrastructure risk reduction benefits, but also could include other strategies, such as NNBF measures.

The results of the initial screening indicate that there are measures within the themed categories of Preserve, Accommodate, and Avoid that score highly, and measures that score low, and certain alternatives (Preserve) that had overall high score. This indicates that many within that group meet the identified problems and opportunities and also screened well against the Four Planning Criteria and will be evaluated further. Low scoring measures within the Avoid Strategy, like hazard mitigation plans, emergency evacuation plans, and early flood warning systems would add value to a comprehensive storm damage risk reduction plan, but may not meet federal criteria for further consideration. Most of the measures in the Preserve Category scored high, with all but three coming in the top 10 overall, indicating the Preserve Category as a strong theme for the NJBB across most localities. The lowest ranking Strategy was Accommodate, with most of the measures in this category ranked between 16 to 25 out of a potential 25 measures.

Table 9-1: Management Measure Cycle 1 Screening Results

Management Measures - Cycle 1 Screening	Problem & Opportunity Statements											Score	Rank
	Problem	No Comprehensive CSRM system to protect against erosion, inundation, wave attack			Sea Level Change/Climate Change	Inadequate Municipal Storm Water Infrastructure	No Multi-Agency efforts	Degraded Ecosystems	Economic Disruption	Inconsistent Flood Forecasting	Lack of Local Flood Risk Management Capabilities		
	Opportunity	Reduce Inundation Damage	Reduce Wave Damage	Reduce Erosion Damage	Mitigate Sea Level Change/Climate Change	Reduce Flooding Associated with Inadequate Municipal Storm Water Infrastructure	Create Multi-Agency efforts	Restore Degraded Ecosystems	Promote Community Resilience (Economic)	Improve Flood Forecasting/Evacuation Procedures	Support Local Efforts/Resources		
	Problem Weight	51	7	7	10	5	2	5	5	6	2		
Non-Structural Measures													
1 Managed Coastal Retreat	N1M	1	1	1	1	0	1	1	0	0	0	82	2
2 Building Retrofit	N2B	1	1	0.5	0.5	0	1	0	1	0	0	74	10
3 Hazard Mitigation Plans (County)	N3H	0	0	0	0	0	1	0	0.5	1	1	13	22
4 Emergency Evacuation Plans	N4E	0	0	0	0	0	1	0	0.5	1	1	13	22
5 Early Warning Systems (State/County)	N5EW	0	0	0	0	0	1	0	0.5	1	1	13	22
6 Public Education/Risk Communication	N6P	0	0	0	0	0	1	0	0.5	1	1	13	22
7 National Flood Insurance Program Improvements	P1NF	1	1	0.5	1	0	1	0	1	0	1	81	3
8 Zoning Changes (Code/Ordinance)	P4Z	0.5	0.5	0.5	1	0.5	1	0	1	0	0.5	53	14
Structural Measures													
1 Inlet Storm Surge Barriers	S1S	1	0.5	0.5	0.5	0	0	0	1	0	0	68	12
2 Interior Bay Closures (Tide Gates)	S2T	1	0.5	0.5	0.5	0	0	0	0.5	1	0	68	12
3 Road/Rail Elevation	S3R	1	1	0.5	1	0	0	0	1	0	0	77	6
4 Levees	S4L	1	1	0.5	1	0	0	0	1	0	0	77	6
5 Permanent Floodwalls	S5F	1	1	0.5	1	0	0	0	1	0	0	77	6
6 Deployable Floodwalls	S6D	1	1	0.5	1	0	0	0	1	0	0	77	6
7 Crown Walls	S7C	1	1	0	1	0	0	0	1	0	0	73	11
8 Beach Restoration/Groins/Breakwaters	S8B	1	1	1	1	0	0	1	1	0	0	85	1
9 Bulkheads	S9B	1	1	1	1	0	0	0	1	0	0	80	4
10 Seawalls (New)	S10S	1	1	1	1	0	0	0	1	0	0	80	4
11 Revetments (Slope Improvement)	S11R	0	1	1	1	0	0	0	1	0	0	24	18
12 Storm System Drainage Improvements	S12SD	0.5	0	0	1	1	1	0	1	0	0.5	49	15
Natural and Nature-Based Features													
1 Living Shorelines	NB1L	0	1	1	0	0	1	1	0.5	0	0	24	19
2 Reefs	NB2R	0	1	0.5	0	0	1	1	0	0	0	18	20
3 Wetland Restoration	NB3WR	0	1	1	1	0	1	1	0.5	0	0	34	17
4 Submerged Aquatic Vegetation	NB4BIR	0	0.5	0.5	0	0	1	1	0	0	0	14	21
5 Green Stormwater Management	NB5G	0.5	0	0	0.5	1	1	1	0.5	0	0	45	16
Total													

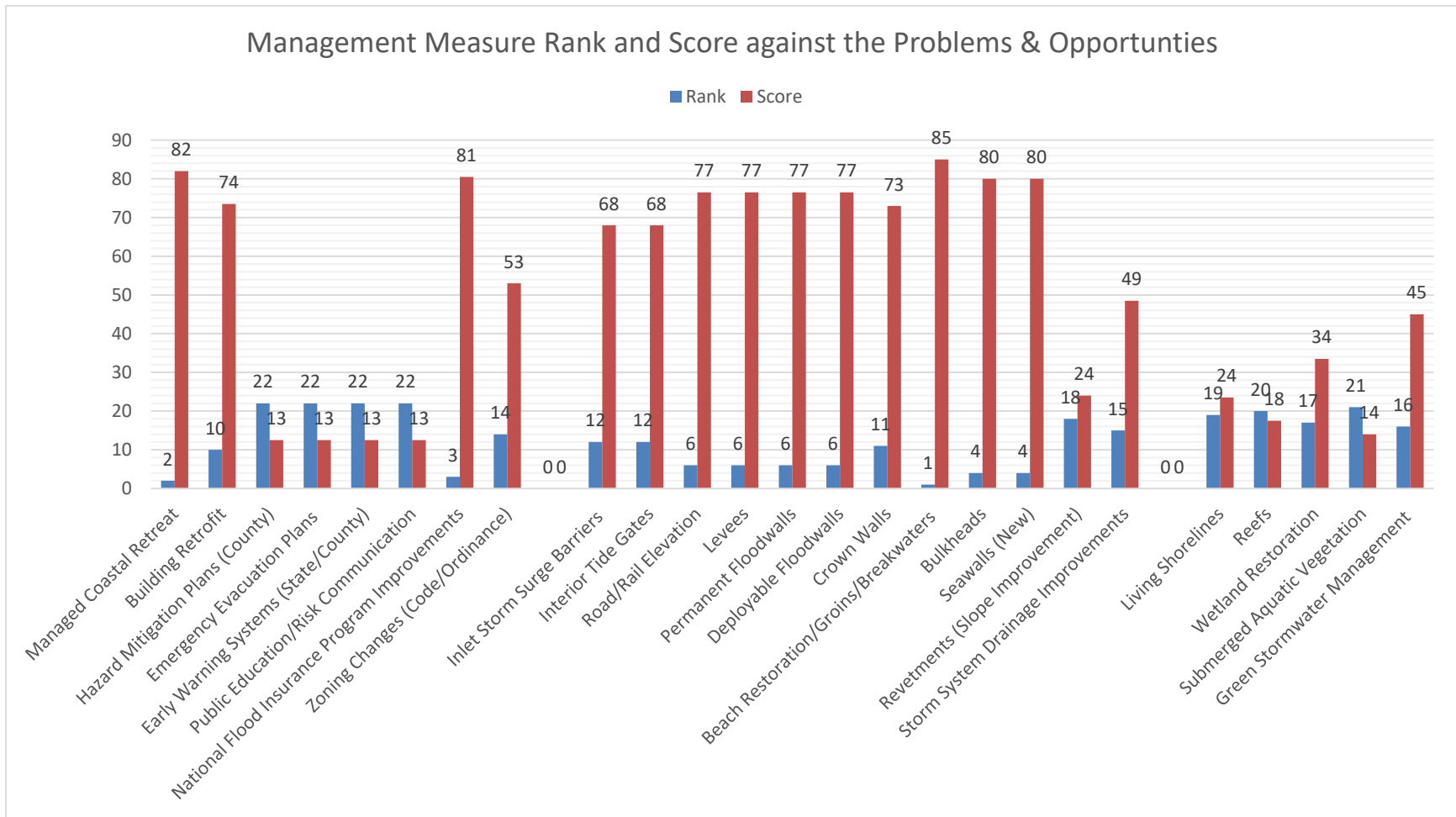

Figure 9-4: Management Measure Rank and Score Against the Problems and Opportunities.

Table 9-2: Management Measure Cycle 2 Screening Results

Management Measures - Cycle 2 Screening	Problem & Objective Statements								
	4 Planning Criteria					Score	Weighted score	Combined score	Rank
	Code	Effectiveness	Efficiency	Acceptability	Completeness				
Non-Structural Measures									
1 Managed Coastal Retreat	P1NF	1	0.5	0	0.5	2	0.5	41	13
2 Building Retrofit	N2B	1	1	1	0	3	0.75	55	10
3 Hazard Mitigation Plans (County)	N1M	0.5	1	1	0	2.5	0.625	8	20
4 Emergency Evacuation Plans	P4Z	0.5	1	1	0	2.5	0.625	8	20
5 Early Warning Systems (State/County)		0.5	1	1	0	2.5	0.625	8	20
6 Public Education/Risk Communication	N4E	0.5	1	1	0	2.5	0.625	8	20
7 National Flood Insurance Program Improvements	N5EW	1	1	1	0.5	3.5	0.875	70	2
8 Zoning Changes (Code/Ordinance)	N6P	0.5	1	0.5	0.5	2.5	0.625	33	14
Structural Measures									
1 Inlet Storm Surge Barriers	S4L	1	1	0.5	1	3.5	0.875	60	6
2 Interior Bay Closures (Tide Gates)	S9B	1	1	0.5	1	3.5	0.875	60	6
3 Road/Rail Elevation	SSF	1	0.5	1	0.5	3	0.75	57	8
4 Levees	S8B	1	1	1	1	4	1	77	1
5 Permanent Floodwalls	S1S	1	1	0.5	1	3.5	0.875	67	3
6 Deployable Floodwalls	S2T	0.5	1	1	0.5	3	0.75	57	8
7 Crown Walls	S3R	0.5	1	1	0.5	3	0.75	55	11
8 Beach Restoration/Groins/Breakwaters	S6D	0.5	1	1	0.5	3	0.75	64	4
9 Bulkheads	S7C	0.5	1	1	0.5	3	0.75	60	5
10 Seawalls (New)	S10S	1	0.5	0.5	0.5	2.5	0.625	50	12
11 Revetments (Slope Improvement)	S12SD	0.5	0.5	0.5	0	1.5	0.375	9	19
12 Storm System Drainage Improvements	S11R	0.5	0.5	1	0	2	0.5	24	15
Natural and Nature-Based Features									
1 Living Shorelines	NB5G	0.5	0.5	1	0	2	0.5	12	18
2 Reefs	NB3WR	0	0.5	0.5	0	1	0.25	4	24
3 Wetland Restoration	NB1L	0.5	0.5	1	0	2	0.5	17	17
4 Submerged Aquatic Vegetation	NB2R	0	0	1	0	1	0.25	4	25
5 Green Stormwater Management	NB4BIR	0.5	0	1	0	1.5	0.375	17	16
Total									

Management Measure Combined Rank and Score against Problems & Opportunities and the 4 Planning Criteria

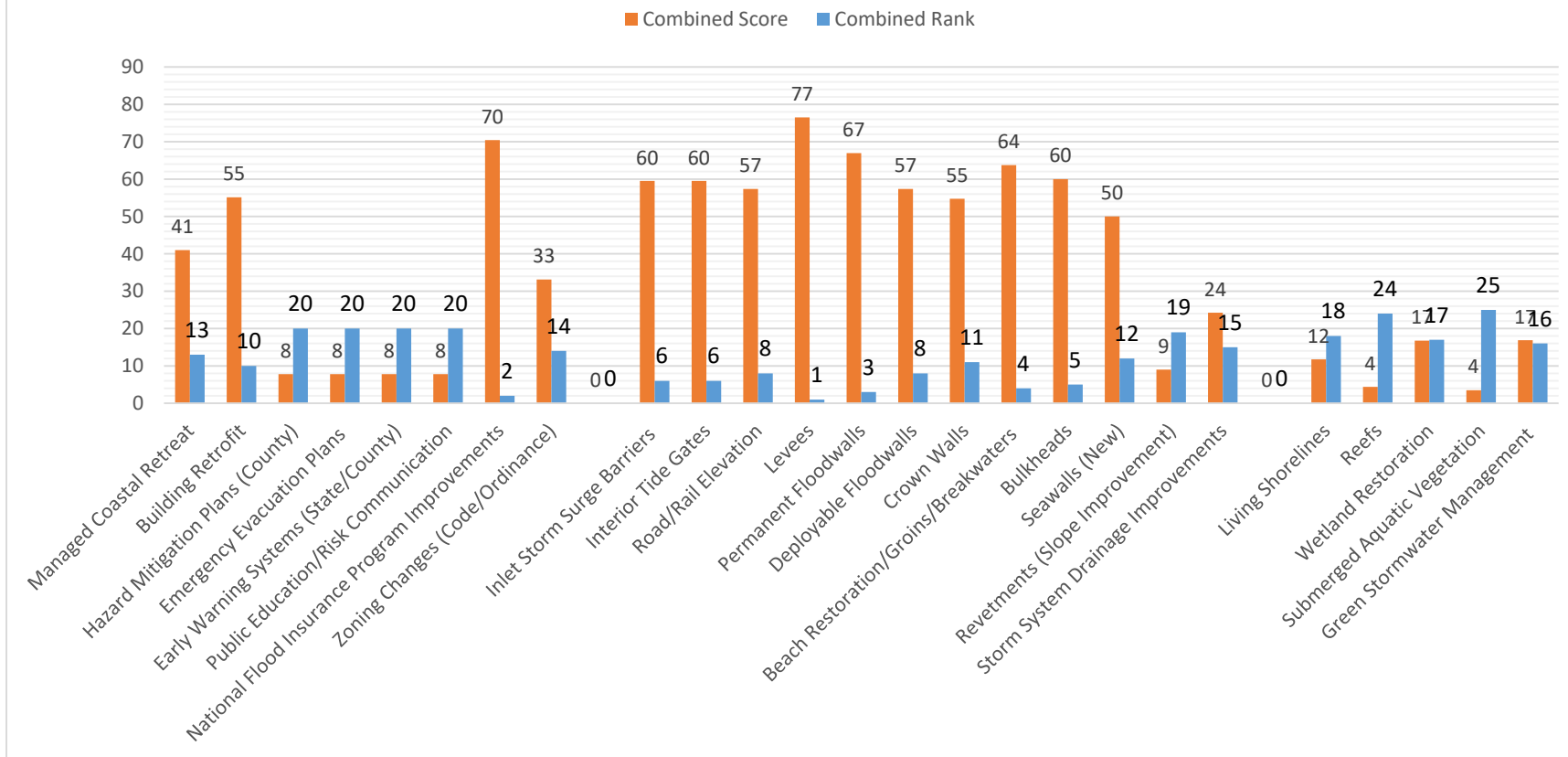

Figure 9-5: Management Measure Rank and Score Against the Problems and Opportunities and the 4 Planning Criteria

Table 9-3: Adaption Categories with Screened and Ranked Measures

Adaptation Categories with Screened and Ranked Measures			
	1. Preserve Focused Category– An adaptation category, sometimes termed “protect,” that focuses on preserving the function or reliability of the given economic, social, and/or environmental system that is adversely affected by climate change (e.g., navigation channels continue to function reliably, coastal storm risk management measures continue to manage and reduce risk), and may include structural, nonstructural, NNBF, and combinations of each as appropriate.	2. Accommodate Focused Category– An adaptation category that allows individuals and communities to adapt to sea level changes and other impacts as they occur over time. This strategy could include traditional nonstructural measures, such as elevation, flood proofing, and ring walls, along with improved implementation of NNBF measures.	3. Avoid Focused Category– An adaptation category, sometimes termed “retreat,” that seeks to avoid increasing impacts through traditional nonstructural activities, such as acquisition, to convert land to open space, providing natural infrastructure risk reduction benefits, but also could include other strategies, such as NNBF measures.
”	“Protect“	“Adapt“	“Managed Coastal Retreat“
	Includes traditional structural as well as NNBF and nonstructural measures	Includes nonstructural (i.e. elevation, flood proofing, building retrofit including ringwalls), structural (levees) and NNBF measures, as well as community-level efforts	Includes nonstructural and NNBF measures/natural infrastructure risk reduction benefits, with specific emphasis on managed coastal retreat (i.e. setbacks, rolling easements, exactions, mitigation fees, building restrictions, conservation easements, transfer development rights, buyout/acquisition programs, relocations and eminent domain).
HIGH	Levees	NFIP Refinement	Managed Coastal Retreat
	Floodwalls	Building Retrofit	Zoning Changes (Code/Ordinance)
	Beach Restoration	Managed Coastal Retreat	Wetland Restoration
	Bulkheads	Green Storm water Management	Living Shorelines
	Inlet Storm Surge Barriers	Wetland Restoration	Public Education/Risk Communication
	Interior Bay Closures	Living Shorelines	Reefs
	Road/Rail Elevation	Hazard Mitigation Plans	Submerged Aquatic Vegetation
	Deployable Floodwalls	Emergency Evacuation Plans	
	Building Retrofit	Early Flood Warning Systems	
	Crown Walls	Public Education/Risk Communication	
	Seawalls	Reefs	
	Managed Coastal Retreat	Submerged Aquatic Vegetation	
	Zoning Changes		
	Storm Drainage Improvements		
	Green Storm water Management		
Wetland Restoration			
Living Shorelines			
LOW	Submerged Aquatic Vegetation		
KEY	Structural		
	Nonstructural		
	Natural and Nature-Based Features		
	Community-Level Efforts		
	Policy/Programmatic Considerations:		
	Public/Private & Public/Public Partnerships		
	Zoning Changes		
	Regional Sediment Management		
	Engineering With Nature		
	Green Banks		
	Tax Incentive		

The Preserve, Accommodate, Avoid Categories work within themes established by the North Atlantic Comprehensive Study to organize and provide clarity on the overall strategy of the formulation process (**Table 9-3**).

9.4 NED Hybrid Plan Screening Process

The highest ranked measures carried forward from the initial CSRM measure inventory and screening process described above were then refined into more detailed measures with greater location, engineering and economic detail. Public, stakeholder and local meetings were held in 2018 to share the measures under consideration and the associated screening process, and to allow them to provide feedback on the development of region-wide CSRM alternatives.

Alternative formulation centered on grouping measures from the Protect, Adapt, and Avoid categories into three different strategies for managing coastal storm risk, including:

- Perimeter measures that limit the ingress of tidal floodwaters (primarily floodwalls and levees) – This strategy fits within the Protect adaptation category;
- Nonstructural measures that do not alter the elevation of floodwaters (building retrofit). This strategy fits within both Avoid and Adapt categories;
- Storm surge barriers (inlet gates) that close to stop tidal exchange and limit storm surge during a coastal storm. This strategy fits within the Protect category.

A qualitative comparison of these different previously screened component measures was conducted to offer stakeholders in the NJBB Region a greater understanding of different attributes. Pros and cons of the screened component measures are offered below. Each of the three strategies has key advantages and disadvantages (**Figure 9-6**). A multi-strategy approach may help to balance some of the disadvantages.

Nonstructural Strategy	<p>Key Advantage: Reduces risk to most vulnerable structures in study area</p>
	<p>Key Disadvantage: Does not reduce risk to infrastructure or other structures, so residual risk remains high.</p>
Perimeter Strategy	<p>Key Advantage: Reduces risk to infrastructure within the perimeter footprint during storm events with water elevations below the barrier elevation. This could reduce nuisance flooding within the perimeter footprint.</p>
	<p>Key Disadvantage: No risk reduction outside of the footprint of the perimeter structure. Impacts to viewshed would be high and real estate would need to be required to construct the perimeter structures.</p>
Storm Surge Barriers	<p>Key Advantage: Reduces risk to infrastructure within the area that is hydrologically connected to ocean tides through the inlet.</p>
	<p>Key Disadvantage: No risk reduction during higher frequency events when the gates are left open. Average Annual O&M costs are also very high.</p>

Figure 9-6: Advantages vs. Disadvantages

This section will detail the methodology and results of investigating each strategic grouping of measures in isolation. The following Alternative Section (will combine these strategies into implementable and complete proposed alternatives.

Each strategy was first evaluated independently for all relevant study area locations and then combined with other strategies types to create NED optimizing and comprehensive multi strategy alternatives. Additional details can be found in the Plan Formulation, Economic and Engineering Appendices. **Figure 9-7** below shows the formulation approach, beginning with single strategy Perimeter, Nonstructural, and Storm Surge Barrier alternatives and progressing to a full array of alternatives including multi-strategy approaches.

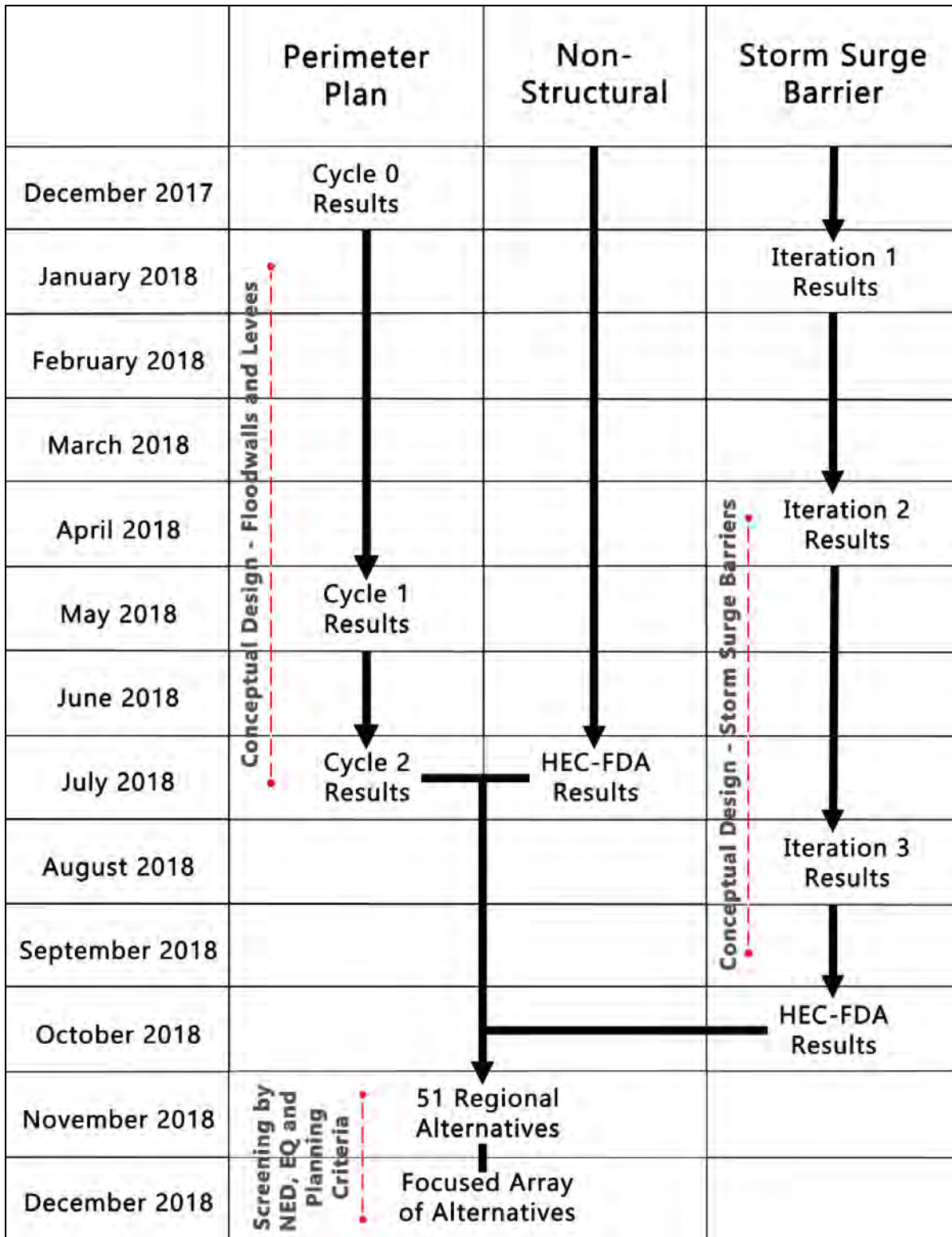

Figure 9-7: NJBB Component Plan Screening Process

Economic modeling using HEC-FDA for these plans was performed twice during the screening process to develop multi-strategy alternatives. HEC-FDA model runs were first performed inclusive of perimeter and nonstructural strategies. A second round of HEC-FDA model runs were performed after the hydrodynamic modeling of storm surge barriers was completed. These analyses were then combined to develop the preliminary focused array of alternative plans.

Additional details regarding the creation of the structure inventory, the methodology for identifying structures and their valuation as well as first floor elevation, the application of functions to compare water level depth to structure damage, and the final hydraulic engineering inputs for HEC-FDA can be found in the Economics Appendix C.

9.4.1 Perimeter Strategy Formulation

Evaluation of perimeter measures was completed using three iterative cycles of analysis. The Investigative Cycles (Cycles 0 and 1) including an initial comprehensive qualitative analysis, an excel-based quantitative analysis, and a final HEC-FDA based quantitative analysis (Cycle 2).

9.4.1.1 Perimeter Strategy Screening – Cycle 0

The initial analysis effort was a comprehensive qualitative screening of potential perimeter measure locations across the entire study area. The analysis completed in Cycle 0 did not assign refined costs nor benefits to identified perimeter locations. The analysis focused on identifying vulnerable areas where a perimeter solution was implementable.

Cycle 0 identified 49 possible perimeter locations across the study area. These locations represent the base for future analysis. All successive cycles of analysis refined cost and benefit inputs to screen these identified locations to only the economically justified alternatives. Economic justification is defined by the implementation of a plan having positive Average Annual Net Benefits (AANB).

Figure 9-8 shows all 49 identified perimeter locations. Measures include floodwalls and/or levees depending on ground conditions. In total, Cycle 0 presents 1.8 million ft. of perimeter length.

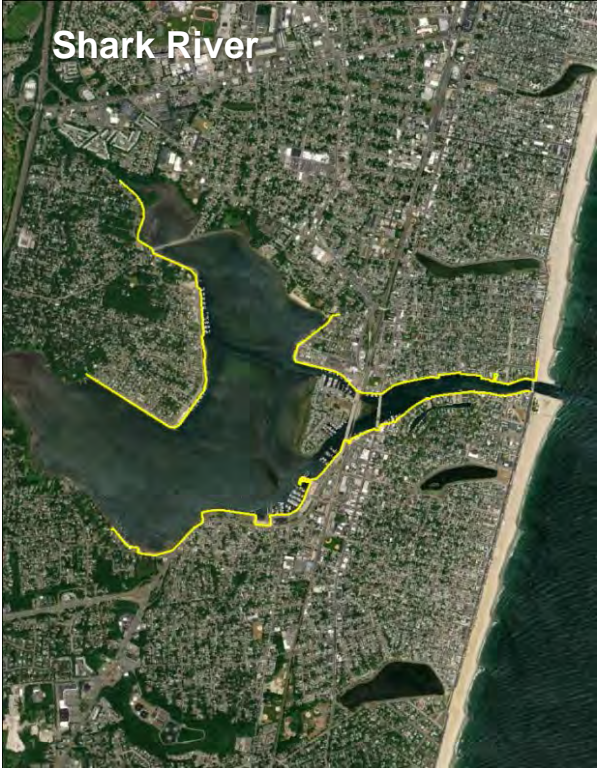

Figure 9-8: Perimeter Measure–Analysis - Cycle 0

9.4.1.2 Perimeter Strategy Screening – Cycle 1

Cycle 1 incorporated all the areas identified in Cycle 0 and introduced cost inputs and benefit estimates. The inclusion of cost and benefit estimates allowed the PDT to assign preliminary Average Annual Net Benefits (AANBs) and Benefit-Cost Ratios (BCRs)² to each of the 49 locations identified in Cycle 0. The AANB results from Cycle 1 were used to screen locations for implementation of the perimeter strategy; locations with positive AANB estimates would progress to Cycle 2 analysis and locations with negative AANB estimates would not be considered further for implementation of the perimeter strategy.

Perimeter costs were adapted from the North Atlantic Coast Comprehensive Study (NACCS) and benefits were calculated using an excel-based model with preliminary structure inventory data and a simplified depth-percent damage curve. Cost estimates included \$8,000 per linear foot of floodwall with additional costs added for miter gates, sluice gates, or road closures where applicable. Analysis was completed using the FY2018 Federal Discount Rate of 2.75% with a 50 year period of analysis. The PDT anticipated that the NACCS costs were likely an underestimate of the actual cost of implementation, and the use of a preliminary structural inventory with a simplified depth damage curve was likely to overestimate benefits. However, at this early stage of the analysis, the decision was made to use lower than anticipated cost estimates and higher than expected benefit assessments to capture the largest number of theoretically justified perimeter locations. **Table 9-4** shows the 13 perimeter locations that displayed Benefit-Cost Ratios above 1.0.

In **Table 9-4** below, Average Annual Cost includes annual Operations & Maintenance (O&M) and Average Annual Damages includes estimates for vehicle damages, infrastructure damages, and emergency costs.

All 13 of the locations identified in **Table 9-4** were carried forward into Cycle 2 to be evaluated further using HEC-FDA. This includes Strathmere with a 0.76 Benefit-Cost Ratio as this was the only community on the barrier islands without an initial BCR above 1.0.

Several main-land communities such as Somers Point and West Atlantic City had BCRs above 0.9 based on current parametric cost estimates. However these areas have been ultimately excluded from further perimeter measure analysis as anticipated costs associated with more detailed analyses in the future are expected to rise substantially while benefits were not expected to greatly fluctuate. In other words, though Cycle 1 analysis operated with a high degree of uncertainty, none of the 36 screened locations could reasonably be expected to attain future economic justification with perimeter measures and their exclusion presents no risk to final study results.

² Benefit-cost analysis is a technique to evaluate in monetary terms what is achieved (benefits) in comparison to what is invested (costs). It is used to ensure that the value of the benefits exceeds the value of the costs, or, in other words, resources are allocated in the most efficient manner possible. When both benefits and costs can be measured in monetary terms, then benefit-cost analysis can help decision makers select the best solution. Benefit-cost analysis involves two mathematical comparisons:

- **Net benefits** are calculated by subtracting total economic costs from total economic benefits. Net benefits represent the amount of total benefits less the total costs. This analysis is used to select and scale a recommended course of action from an array of alternatives
- **A benefit-cost ratio** is calculated by dividing total economic benefits by total economic costs. A benefit-cost ratio tells us which alternative produces the most benefits for every dollar of cost (total benefits/total costs). The benefit-cost ratio is useful for comparing or ranking different projects.

Table 9-4: Perimeter Measure–Analysis - Cycle 1 Results

ID	Location	Length	Initial Const.	AAC	AAD	AANB	BCR
1	Cape May City	15,757	\$133,361,310	\$6,273,439	\$16,961,371	\$10,687,932	2.7
2	Wildwood Island	54,070	\$491,161,680	\$23,104,697	\$93,958,647	\$70,853,950	4.1
4	West Wildwood	11,727	\$100,154,110	\$4,711,341	\$11,938,657	\$7,227,316	2.5
5	Stone Harbor / Avalon	96,936	\$858,289,730	\$40,374,738	\$63,320,119	\$22,945,381	1.6
10	Sea Isle City	34,954	\$329,939,900	\$15,520,676	\$38,710,939	\$23,190,263	2.5
11	Strathmere	8,165	\$77,850,490	\$3,662,159	\$2,777,660	-\$884,499	0.8
12	Ocean City	78,573	\$703,272,670	\$33,082,593	\$186,282,803	\$153,200,210	5.6
18	Absecon Island	97,409	\$977,008,560	\$45,959,381	\$400,981,475	\$355,022,094	8.7
23	Brigantine	48,590	\$431,911,960	\$20,317,536	\$52,970,720	\$32,653,184	2.6
26	Long Beach Island	206,561	\$1,883,468,300	\$88,600,081	\$145,286,947	\$56,686,867	1.6
42	Island Beach	186,140	\$1,784,578,000	\$83,948,190	\$160,691,242	\$76,743,052	1.9
45	Manasquan Inlet (North)	22,642	\$235,353,970	\$11,071,267	\$32,182,394	\$21,111,127	2.9
52	West Cape May	4,481	\$57,882,910	\$2,722,865	\$15,923,307	\$13,200,441	5.8
TOTAL ESTIMATED		866,005	\$8,064,233,590	\$379,348,963	\$1,221,986,280	\$842,637,317	3.2
ROUNDED		866,000	\$8,064,234,000	\$379,349,000	\$1,221,986,000	\$842,637,000	3.2

Figure 9-9, Figure 9-10 and Figure 9-11 show the 13 remaining perimeter measure locations. In total, Cycle 1 presents 840,000 ft. of perimeter length.



Figure 9-9: Perimeter Measure North Region Analysis - Cycle 1

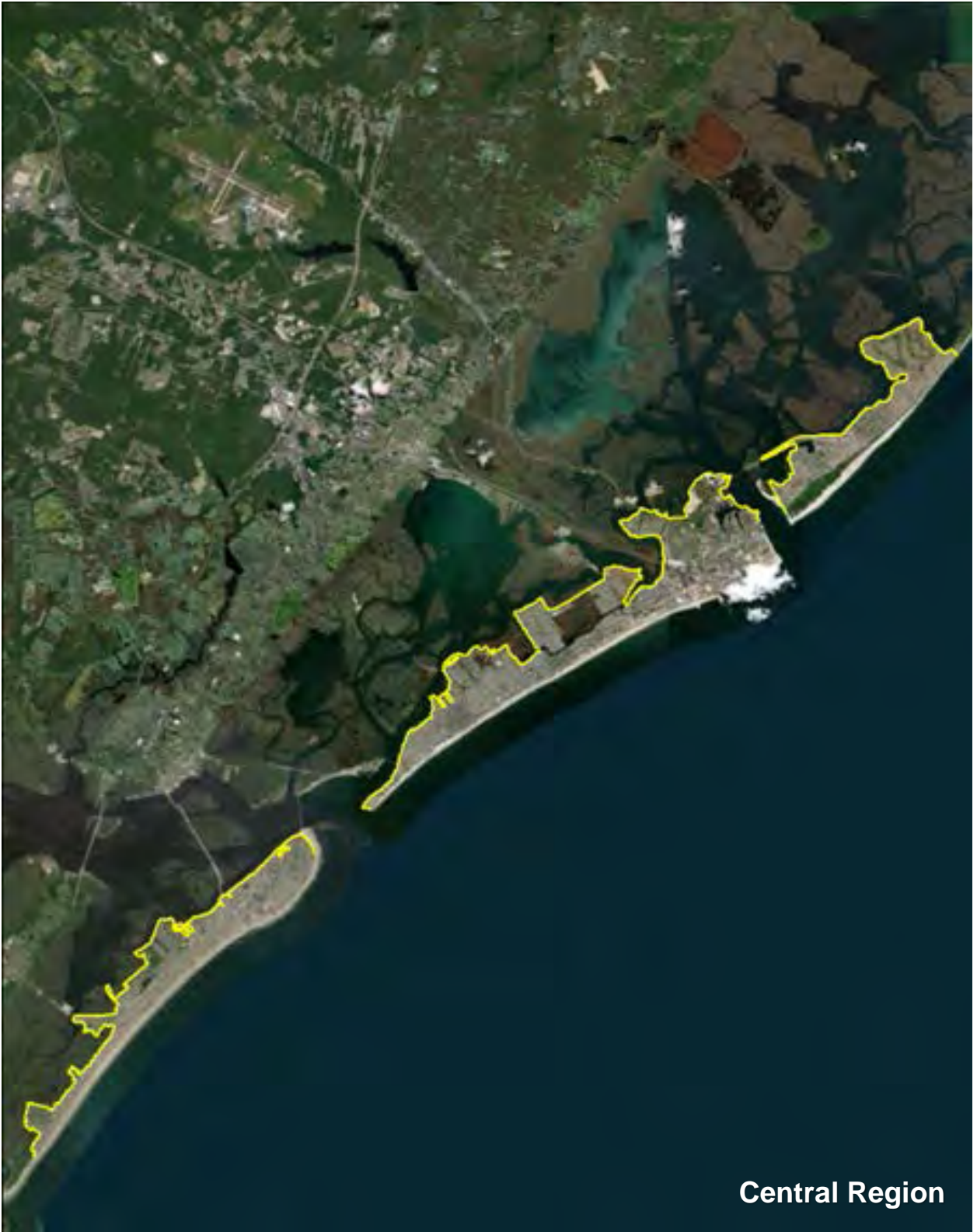

Figure 9-10: Perimeter Measure Central Region Analysis - Cycle 1

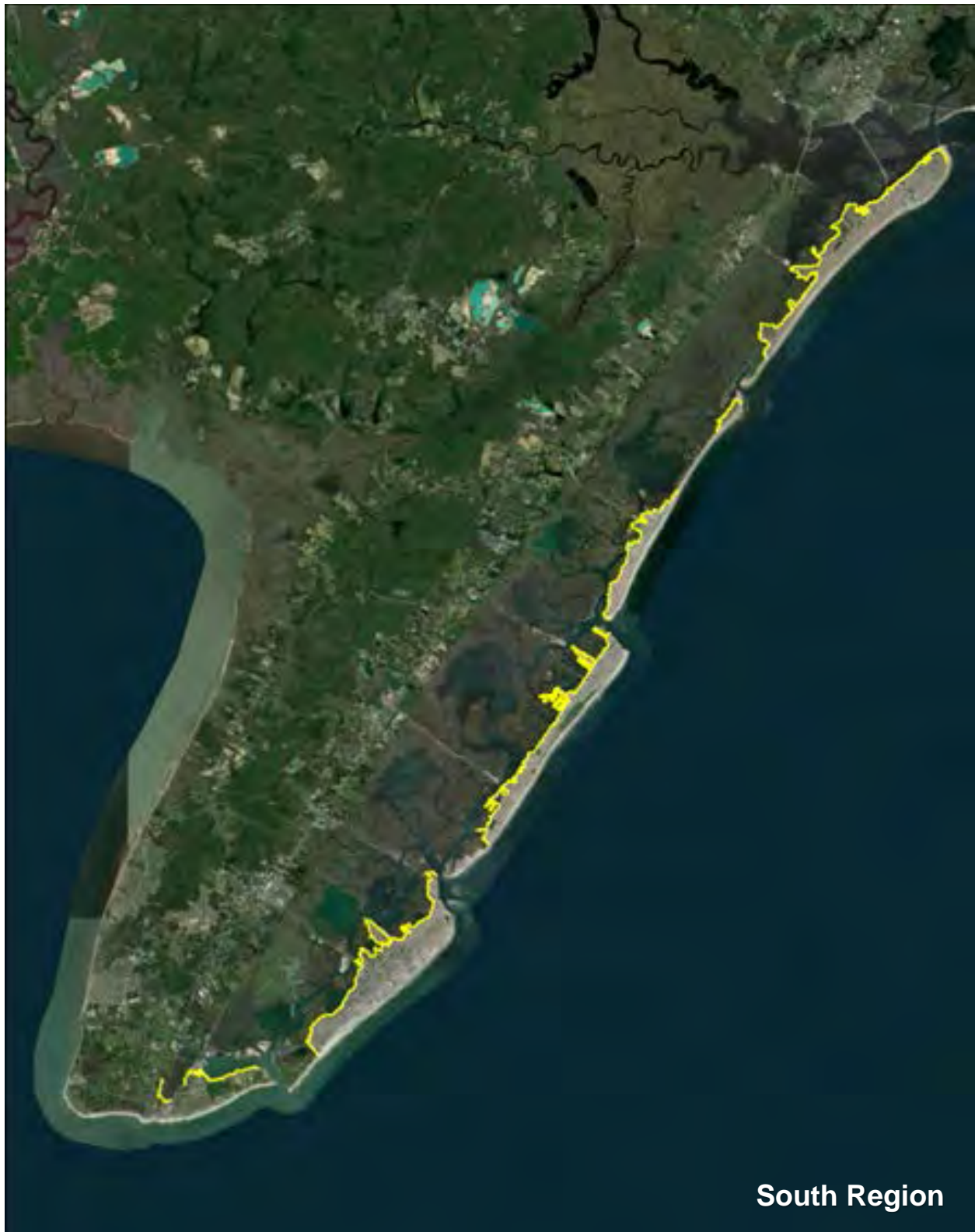

Figure 9-11: Perimeter Measure South Region Analysis - Cycle 1

9.4.1.3 Perimeter Strategy Screening – Cycle 2

The final analysis cycle for implementation of perimeter strategies transferred the Cycle 1 modeling using preliminary excel-based tools to USACE certified HEC-FDA modeling. Evaluation with HEC-FDA allows for significantly greater complexity and accuracy than possible with excel-based methods.

Cost estimates were also updated with modifications to perimeter measure placement and lengths as well as efforts to improve accuracy with changes to cost per linear foot and applied contingencies.

9.4.1.3.1 Cycle 2 Design Considerations and Assumptions

The Cycle 2 perimeter strategy utilized the following design considerations and assumptions.

A rough estimate of level of design was 5%.

Structural Measures:

- Floodwall – Pile supported concrete “T-wall” – Two (2) types: a) Wet construction, and b) Dry construction
- Levee – Random fill interior with riprap exterior, includes steel sheetpile cutoff wall
- Miter gate (65 foot-wide)
- Sluice gate (60 foot-wide)
- Road closure (2 & 4 lanes)
- Pump stations

Alignment Assumptions:

- Tie-in to high ground above the FEMA 500-year floodplain
- Tie-in to USACE dunes and seawalls on ocean-side
- Alignment selected for least impacts to existing structures

Interior Drainage:

- Line of protection includes drainage pipes through the structure for local drainage
- Pump Stations added for Interior Drainage; see the Engineering Appendix B for detailed analyses

Typical Sections:

Figure 9-12, Figure 9-13 and Figure 9-14 show typical sections which have been used in the perimeter plan design to date.

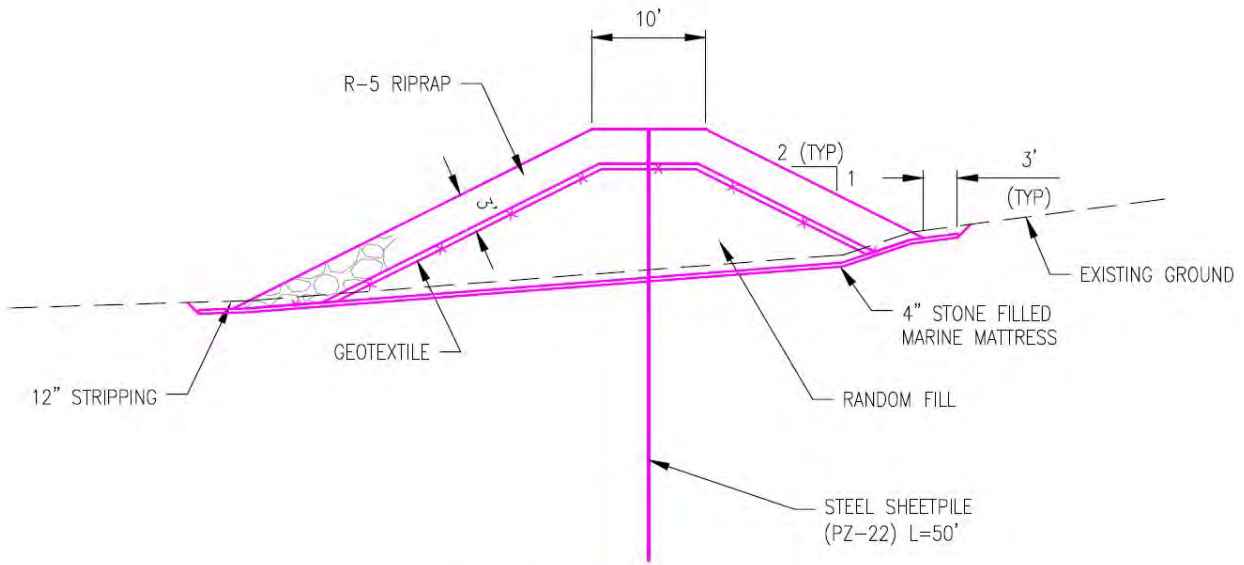

TYPICAL SECTION – LEVEE – TYPE A
NTS

Figure 9-12: Typical Section – Levee – Type A

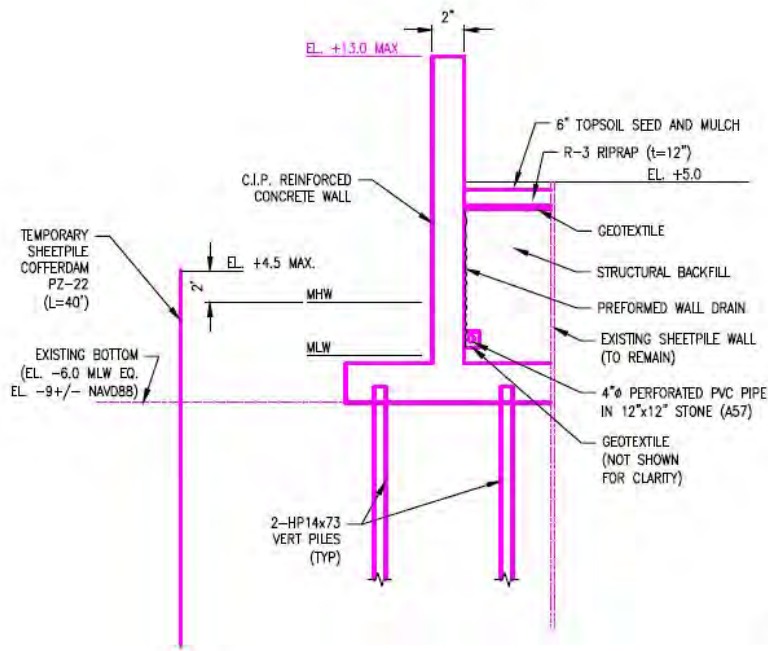

NOTES:
1. USE HP14x73 PILES 50' LONG @ 10' C-C.

TYPICAL SECTION – CONCRETE CANTILEVER
WALL ON PILES –TYPE B
NTS

Figure 9-13: Typical Section – Concrete Cantilever Wall on Piles – Type B

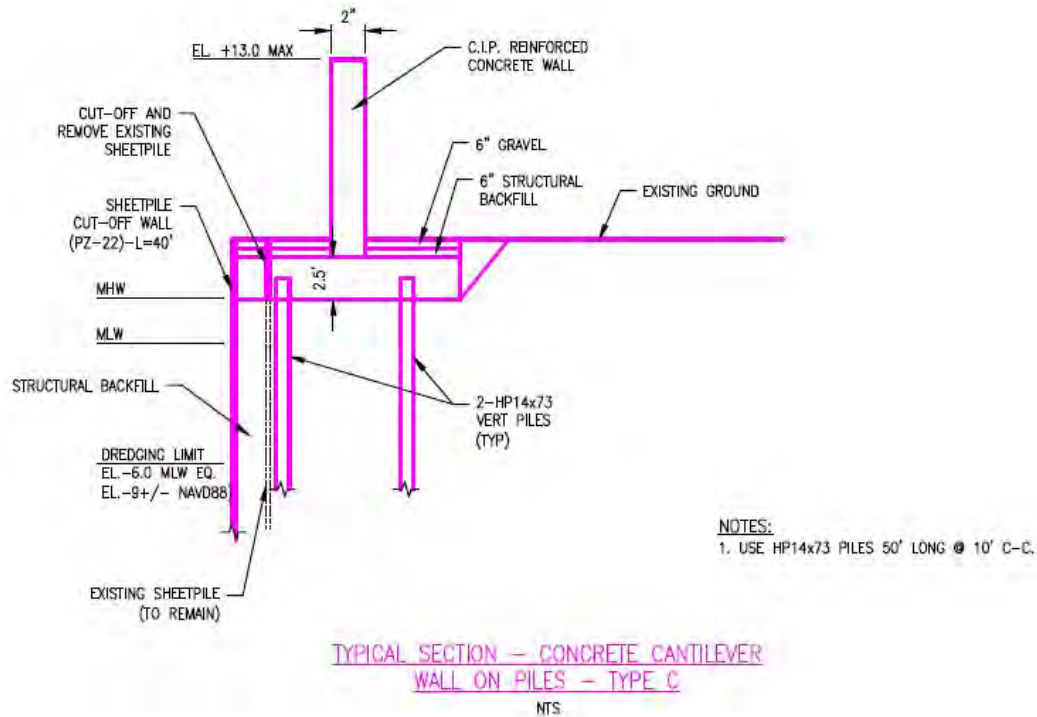

Figure 9-14: Typical Section – Concrete Cantilever Wall – Type C

9.4.1.3.2 Cycle 2 Cost and Contingency Considerations and Assumptions

The Cycle 2 perimeter strategy utilized the following cost and contingency considerations and assumptions. Due to the level of detail of engineering analyses at this point of the study, the unit costs presented below were based on analyses performed for different USACE feasibility studies including the New York-New Jersey Harbor and Tributaries CSRM Feasibility Study and the Norfolk CSRM Feasibility Study.

Unit Costs

- Floodwall:
 - Range between \$9,715/linear ft. (lf) and \$11,558/lf. Cost range is based on floodwall types discussed in above section and is dependent upon construction access for the different floodwall types. Construction from the land side can be performed from if no access limitations exist. Construction from the water side resulting from existing infrastructure or environmental mitigation activities will require water-based equipment and resulting cost differences
- Levee: \$10,385/lf
- Miter Gate: \$13,507,000 ea.
- Sluice Gate: \$9,800,000 ea.

- All costs adjusted based on an area factor and Oct17 price level
- Desktop estimate of interior pumping
- Real Estate: 10% of project costs
- Mitigation: 5% of project cost
- PED used 12% and S&A used 10% of construction costs
- Annual O&M is 1% of First Costs

Contingency

- Cycle 2 Contingency is 40% of construction costs for a “5% design level”
- Contingency includes
 - Utility relocations
 - 157 Crossovers and ADA accessibility
 - HTRW
 - Demolition/reconstruction of docks and ramps
 - Demolition/removal of bulkheads and revetments
 - Local borrow area and disposal sites
 - Accommodating navigation depths/vessel restrictions
 - Drainage outlets spaced every 400 ft.
- Final Contingency will be based on ‘Crystal Ball’ analysis and will likely be different.

9.4.1.3.3 Cycle 2 Screening Results

Of the 13 locations from the Cycle 1 analysis, 7 locations remain economically justified with positive Average Annual Net Benefits. Three sites (shaded yellow) could realistically attain justification with optimizations to measure placement or type, and are therefore being carried forward for a total of 10 potential locations. However, three sites (shaded orange) have negative Average Annual Net Benefits as well as other factors which make justification highly unlikely. For instance, Strathmere does not have the inventory to remain economically feasible and the sheer length of floodwall necessary to protect Long Beach Island or Island Beach creates a cost hurdle.

Compared to Cycle 1, estimated Average Annual Costs increased 71% over their Cycle 1 values, and Average Annual Benefits decreased -19% in the HEC-FDA based Cycle 2 analysis (**Table 9-5**). This results in a total -59% decrease in Average Annual Net Benefits. **Figure 9-15**, **Figure 9-16** and **Figure 9-17** show the locations of the 7 to 10 perimeter locations that passed the economic criteria for Cycle 2 and were carried through for inclusion in alternative formulation.

Table 9-5: Perimeter Measure Analysis – Cycle 2 Results

ID	Location	Length	Initial Const.	AAC	AAB	AANB	BCR
1	Cape May City	15,825	\$249,540,895	\$11,738,633	\$9,887,438	-\$1,851,196	0.8
2	Wildwood Island	54,171	\$810,770,180	\$38,139,375	\$84,907,400	\$46,768,025	2.2
4	West Wildwood	11,726	\$170,039,200	\$7,998,800	\$15,864,050	\$7,865,250	2.0
5	Stone Harbor / Avalon	97,225	\$1,443,894,068	\$67,922,105	\$46,650,575	-\$21,271,530	0.7
10	Sea Isle City	35,166	\$544,084,466	\$25,594,234	\$31,810,925	\$6,216,691	1.2
11	Strathmere	8,187	\$117,797,150	\$5,541,286	\$2,472,163	-\$3,069,124	0.4
12	Ocean City	78,732	\$1,149,394,269	\$54,068,563	\$182,588,238	\$128,519,674	3.4
18	Absecon Island	111,114	\$1,755,389,808	\$82,575,151	\$320,230,675	\$237,655,524	3.9
23	Brigantine	48,699	\$714,920,468	\$33,630,516	\$30,157,550	-\$3,472,966	0.9
26	Long Beach Island	209,124	\$3,172,187,591	\$149,222,621	\$118,660,075	-\$30,562,546	0.8
42	Island Beach	186,871	\$3,092,467,435	\$145,472,512	\$107,272,863	-\$38,199,649	0.7
45	Manasquan Inlet (North)	22,820	\$461,553,732	\$21,711,912	\$30,560,638	\$8,848,726	1.4
52	West Cape May	4,480	\$88,265,089	\$4,152,071	\$8,890,325	\$4,738,254	2.1
TOTAL ESTIMATED		884,140	\$13,770,304,352	\$647,767,779	\$989,952,913	\$342,185,134	1.5
ROUNDED		884,000	\$13,770,304,000	\$647,768,000	\$989,953,000	\$342,185,000	1.5



Figure 9-15: Perimeter Measure North Region Analysis - Cycle 2

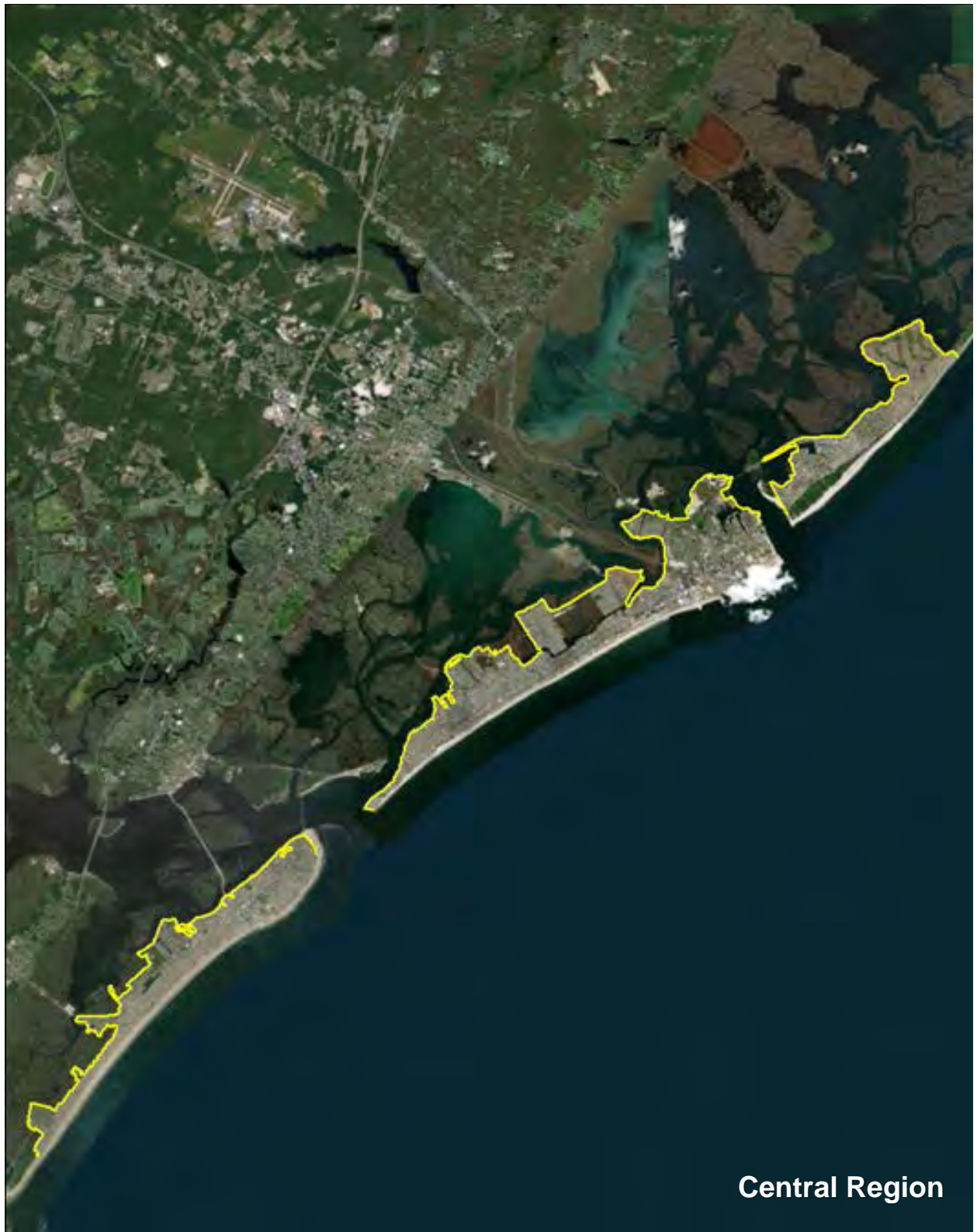

Figure 9-16: Perimeter Measure Central Region Analysis - Cycle 2



Figure 9-17: Perimeter Measure South Region Analysis - Cycle 2

9.4.2 Nonstructural Measures

9.4.2.1 Introduction

Nonstructural measures fall into four broad groups resulting from the CSRM Inventory and Screening process including:

- Managed Coastal Retreat including Acquisition / Relocation,
- Building Retrofit (flood proofing, elevations, ring levees),
- Land Use Management (zoning changes, undeveloped land preservation), and
- Early Flood Warnings (evacuation planning, emergency response systems).

Detailed nonstructural analyses results can be found in the Nonstructural Analyses Appendix D.

Refinements to the National Flood Insurance Program (including increasing homeowner participation and increasing municipal protection in the Community Rating System, also represent a nonstructural opportunity at an agency level. Each measure type has a varying level of storm damage reduction function / adaptive capacity and a complete nonstructural alternative would include each of the four measures as necessary to optimize CSRM benefits.

At this stage of the analysis, nonstructural economic analysis incorporates only building retrofits (elevations) to residential structures due to availability of existing data such as structure inventory and cost information. Future analysis will include additional building retrofits such as flood proofing and ring levees for commercial, public, and industrial structures, as well as managed coastal retreat including acquisition / relocation. Future recommendations will also be made regarding land use management and early flood warning elements.

Building retrofits, while effective in reducing the potential risk for storm damage to that specific structure, has no positive impact on reducing storm damage risk to surrounding property, vehicles, or infrastructure. Furthermore, emergency access and evacuation is not improved solely with the implementation of building retrofits and property owners should still evacuate vulnerable properties during storm events lest they become trapped by rising storm surge. While this section details the cost and benefits analysis for implementing only nonstructural measures, a potential alternative may incorporate nonstructural as a supplemental measure to either perimeter measures, storm surge barriers, or both.

9.4.2.2 Methodology

Nonstructural methods (Building Retrofit) protect the most vulnerable structures across the study area to an established Design Flood Elevation.

The design flood elevation or DFE was developed considering past, present, and future conditions. The State of New Jersey's requirement for building within a flood zone is an additional foot above the FEMA Base Flood Elevation, or BFE. Intermediate sea level rise is also accounted for in the development of the DFE.

- BFE -The hydraulics used for determination of the Base Flood Elevation are from the FEMA National Flood Hazard Layer geodatabase. The hydraulics were developed by FEMA and used for the study area. Preliminary data was used where available and the current effective floodplain data was used if the preliminary data was not available. To

add the FEMA floodplain data to the structure database involves using GIS to spatially determine the static BFE and the Flood Zone where the structure is located. The static BFE and flood zone varies throughout the study and each structure is populated with the value for the BFE based on its spatial location. The structure inventory was updated to include attributes for the FEMA Flood Zone, FLD_ZONE, and the static BFE, STATIC_BFE.

- Sea Level Rise – Intermediate curve 2080 expects the sea level rise to be 1.84 ft., rounded to 2 ft. (**Table 9-6**).
- Local Ordinance Municipalities may require that structures be elevated higher than the BFE. The State of New Jersey’s requirement is that structures be elevated 1 ft. above the BFE, and is adopted at this phase of the study.

Table 9-6: Sea Level Rise Curve Table

Year	USACE - Low (ft, MSL ¹)	USACE - Int (ft, MSL ¹)	USACE - High (ft, MSL ¹)
1992	0.00	0.00	0.00
2000	0.11	0.11	0.13
2019	0.35	0.42	0.62
2030	0.50	0.63	1.03
2050	0.76	1.06	2.01
2080	1.15	1.84	4.02
2100	1.41	2.54	5.74
2130	1.81	3.50	8.87

¹Mean Sea Level based on National Tidal Datum Epoch (NTDE) of 1983-2001

$$\text{DFE} = \text{BFE} + \text{Local Ordinance} + \text{Sea Level Rise} + \text{Rounding Error Factor}$$

$$\text{Current DFE} = \text{FEMA BFE} + 3\text{ft}$$

9.4.2.3 Cost Estimates

Building elevation costs are adapted from the North Atlantic Coast Comprehensive Study (NACCS) and are centered on quantifying the cost for elevating a typical (median) Single Family Residential One-Story (SFR1) structure and the cost for elevating a typical Single Family Residential Multi-Story (SFRM) structure.

A true building elevation cost is developed on a house-by-house basis and includes a number of factors including foundation type, wall type, and size of structure, condition, available work space, local labor rates, and many additional variables. Given the size of the study area and the limitations of the structure inventory, building elevation costs are based on the sampled median foundation size per occupancy type (SFR1 vs. SFRM). Total initial construction costs are then based on the estimated number of structures that require elevation in a given reach multiplied by the typical elevation cost per occupancy type. This method does not allow the identification of the exact structures that require elevation, but provides an estimate for overall cost and benefit quantification per reach.

NACCS building elevation costs incorporate values for engineering and design, administrative fees, temporary housing for inhabitants, and other inputs. **Table 9-7** provides the full cost breakdown for elevating a typical SFR1 structure and **Table 9-8** provides the full cost breakdown for a typical SFRM structure. Both tables use an FY18 price level.

Table 9-7: Building Retrofit Costs – Single Family Residential One Story

Item	Number	Unit	Unit Cost	Total Cost
Elevation	1,559	SQFT	\$87.57	\$136,483
Temporary rehousing	1	ea.	\$10,000	\$10,000
Subtotal				\$146,483
Contingency	25%			\$36,621
Total Construction				\$183,104
E&D	\$10,000			\$10,000
S&A	10%			\$18,310
TOTAL ESTIMATED INTITAL CONSTRUCTION				\$211,414

Median square footage for a typical SFR1 structure in the study area was quantified using a sample of 48,287 building footprint GIS files (provided by New Jersey Department of Environmental Protection) that intersected with SFR1 inventory markers, or a 63.9% sample of SFR1 structures. The median structure base was calculated at 1,559 square ft. All other cost inputs, including unit cost and contingency, were acquired from the NACCS.

Table 9-8: Building Retrofit Costs – Single Family Residential Multi Story

Item	Number	Unit	Unit Cost	Total Cost
Elevation	1,839	SQFT	\$87.57	\$161,016
Temporary rehousing	1	ea.	\$10,000	\$10,000
Subtotal				\$171,016
Contingency	25%			\$42,754
Total Construction				\$213,770
E&D	\$10,000			\$10,000
S&A	10%			\$21,377
TOTAL ESTIMATED INTITAL CONSTRUCTION				\$245,147

Similar to SFR1 structures, the typical SFRM structure square footage base was quantified using a sample of 59,852 building footprint shape files provided by NJDEP, or a 61.4% sample. The median structure base was calculated at 1,839 square ft.

Structures are elevated to a Design Flood Elevation (DFE). This is the Base Flood Elevation (BFE) + 3ft. The additional height is added to mitigate risk from sea level rise.

9.4.2.4 Structure Identification

Selecting structures eligible for building elevation focused on identifying structures with the highest coastal storm damage risk levels. Residential structures in high risk areas or with lower first floor elevations are more vulnerable to coastal storm damage and considered prime candidates for building retrofits.

Nonstructural analysis focused on structures within the 20% Annual Chance Exceedance (ACE) floodplain (05YR Storm Event), the 10% ACE floodplain (10YR Storm Event), and the 5% ACE floodplain (20YR Storm Event). The Nonstructural analysis at this phase of the study focuses on identifying the most vulnerable, or highest risk, structures in the inventory. Elevating structures in the 20%, 10% and the 5% ACE floodplains typically provide the highest NED benefits as structures outside these floodplains cost the same to elevate, but are damaged much less frequently. Further analysis at future study phases will be performed to determine the NED optimizing floodplain level including floodplain with lower annual chance exceedance probabilities (i.e. 1% and 2% ACE floodplains).

Each of the 226 study reaches has a unique water surface profile with a set stage height for the 20% ACE, 10% ACE, and 5% ACE events. All structures with first floor elevations equal to or below any of the three storm event stage heights (FY2030 Intermediate RSLC curve) is considered high risk and eligible for building retrofit evaluation.

The nonstructural analysis at this phase of the study focuses on identifying the most vulnerable, or highest risk, structures in the inventory. These structures are the most susceptible to repetitive damages and are impacted by even moderate- to high-frequency storm events. Elevating structures in the 20% ACE, 10% ACE, or 5%ACE floodplains typically provides the highest NED benefits as structures outside these floodplains cost the same to elevate, but are damaged much less frequently.

Figure 9-18 shows the number of structures contained within each layer as determined by first floor elevation in comparison to the storm event return frequency. Figures 9###a-d show the number of structures within respective ACE floodplains for different regions of the study area.

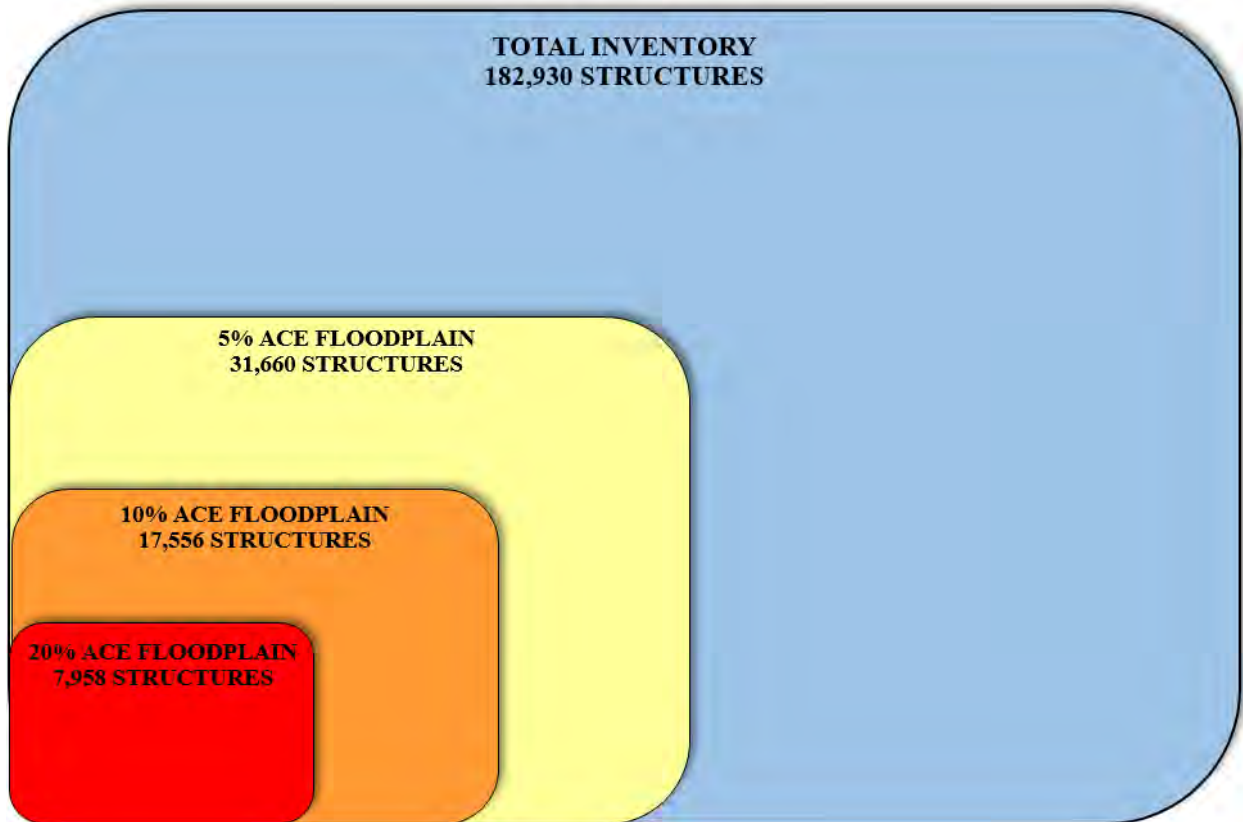

Figure 9-18: Nonstructural Return Period Interval Nomenclature and Building Retrofit Volume

Of the 182,930 structures captured in the study inventory, only 4.4% of SFR1 and SFRM structures fall within the 20% ACE event floodplain (05YR Storm Event). 9.6% of total SFR1 or SFRM structures fall within the 10% ACE event floodplain (10YR Storm Event) and a final 17.3% fall within the 5% ACE event floodplain (20YR Storm Event).

Figure 9-19, Figure 9-20, Figure 9-21 and Figure 9-22 identify the number of structures both outside and within the 20% ACE event floodplain (blue and red, respectively), within the 10% ACE event floodplain (orange), and within the 5% ACE event floodplain (yellow) for each of the four regions of the study area.

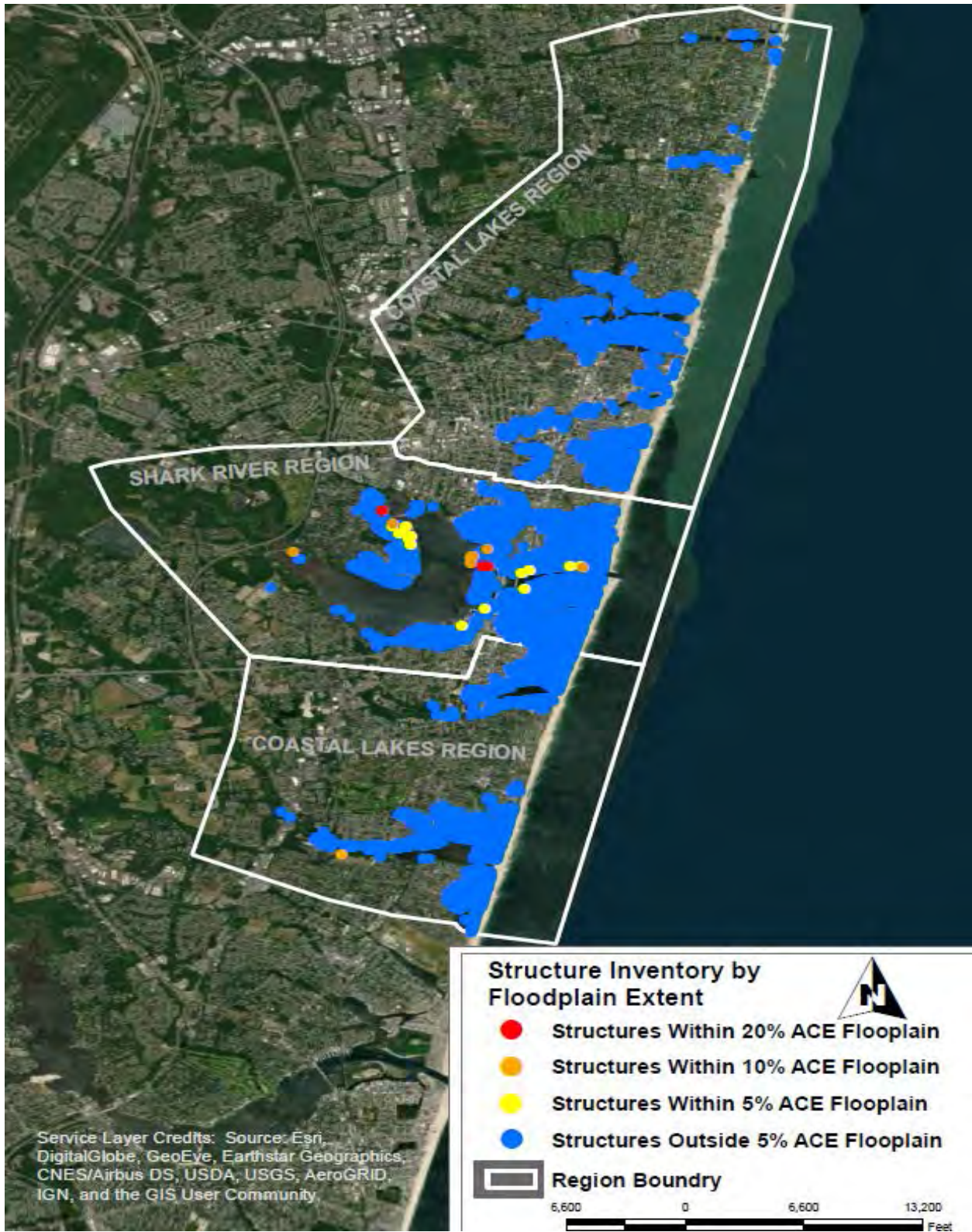

Figure 9-19: Structures Within Respective ACE Floodplains for the Coastal Lakes and Shark River Regions

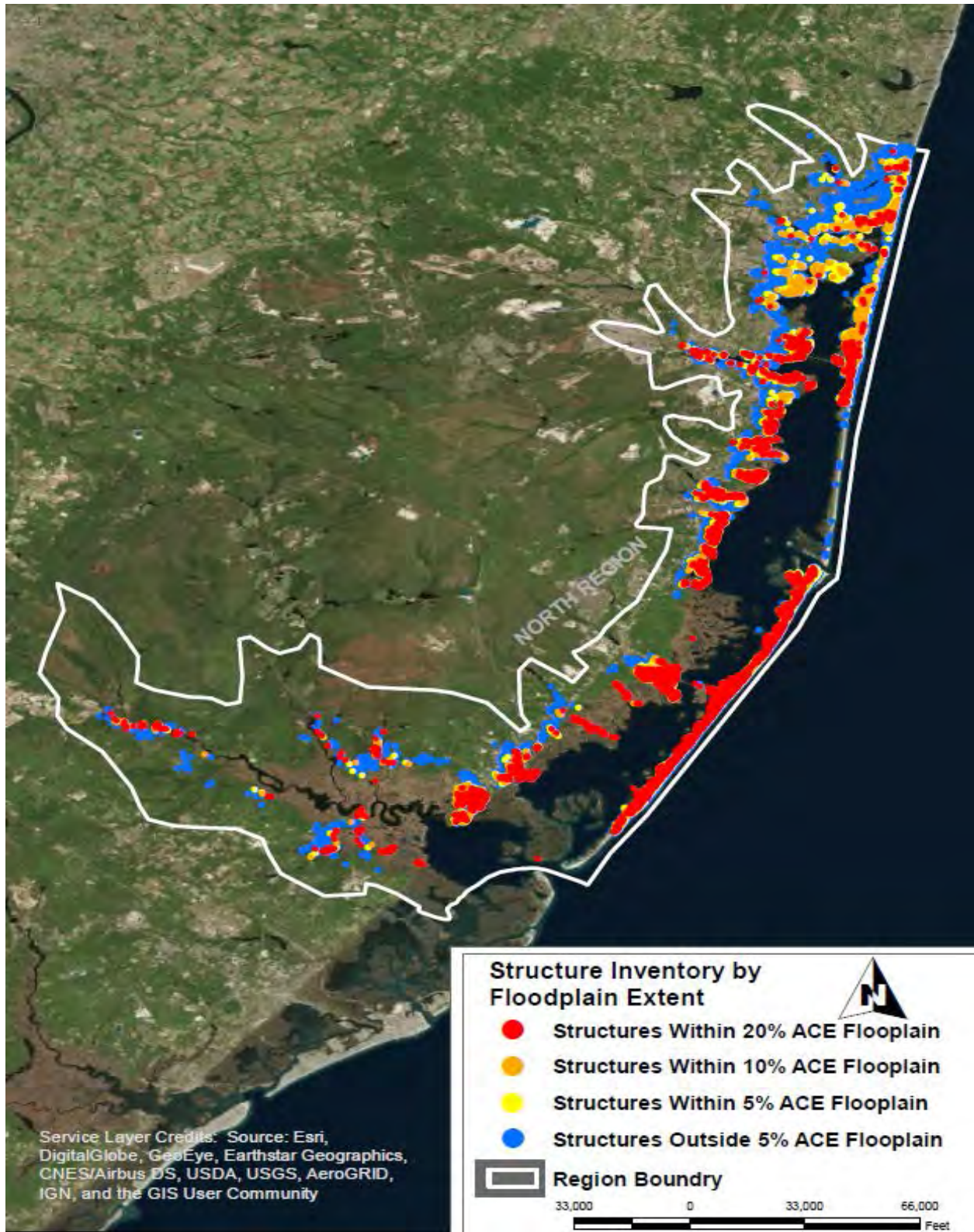

Figure 9-20: Structures Within Respective ACE Floodplains for the North Region

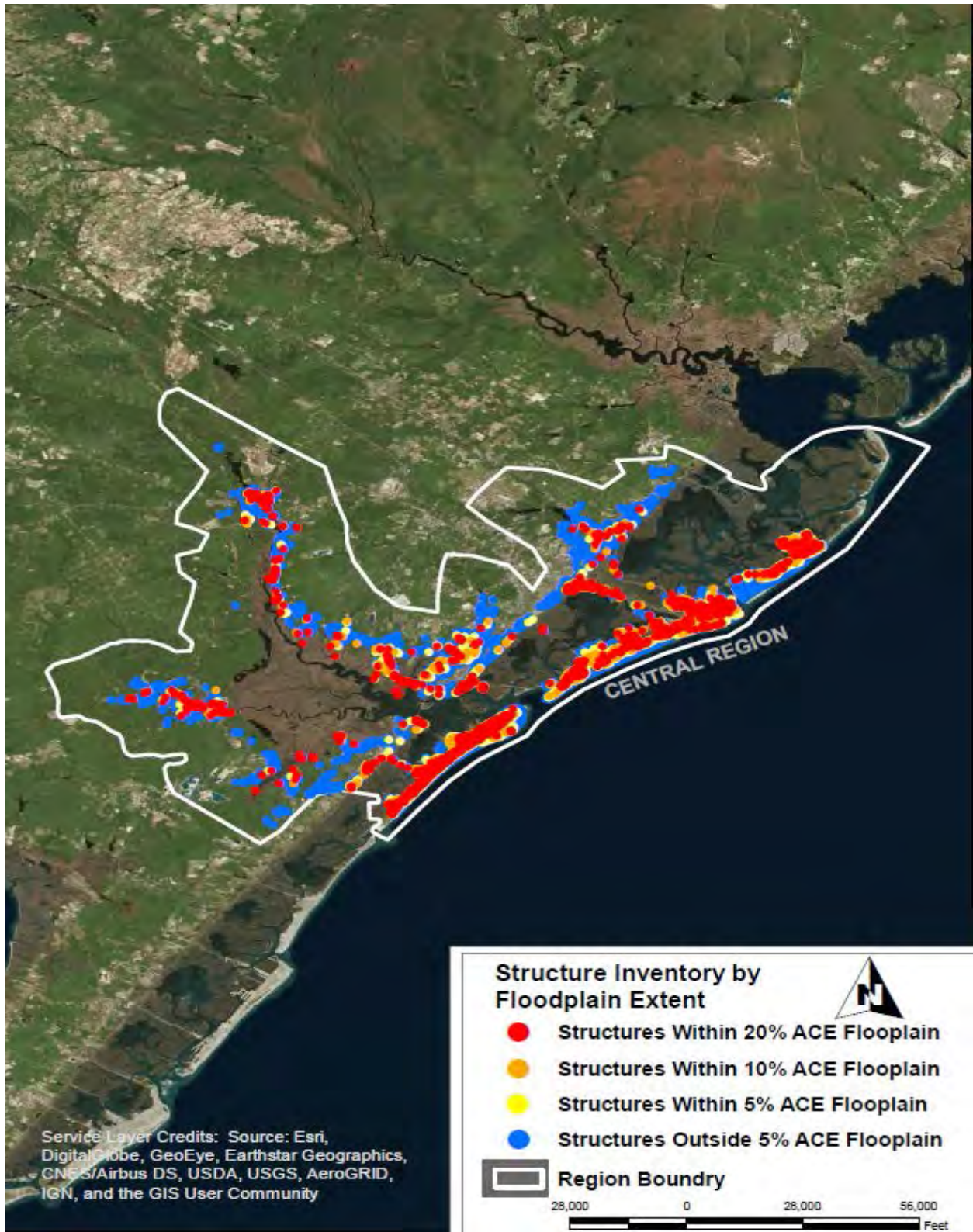

Figure 9-21: Structures Within Respective ACE Floodplains for the Central Region

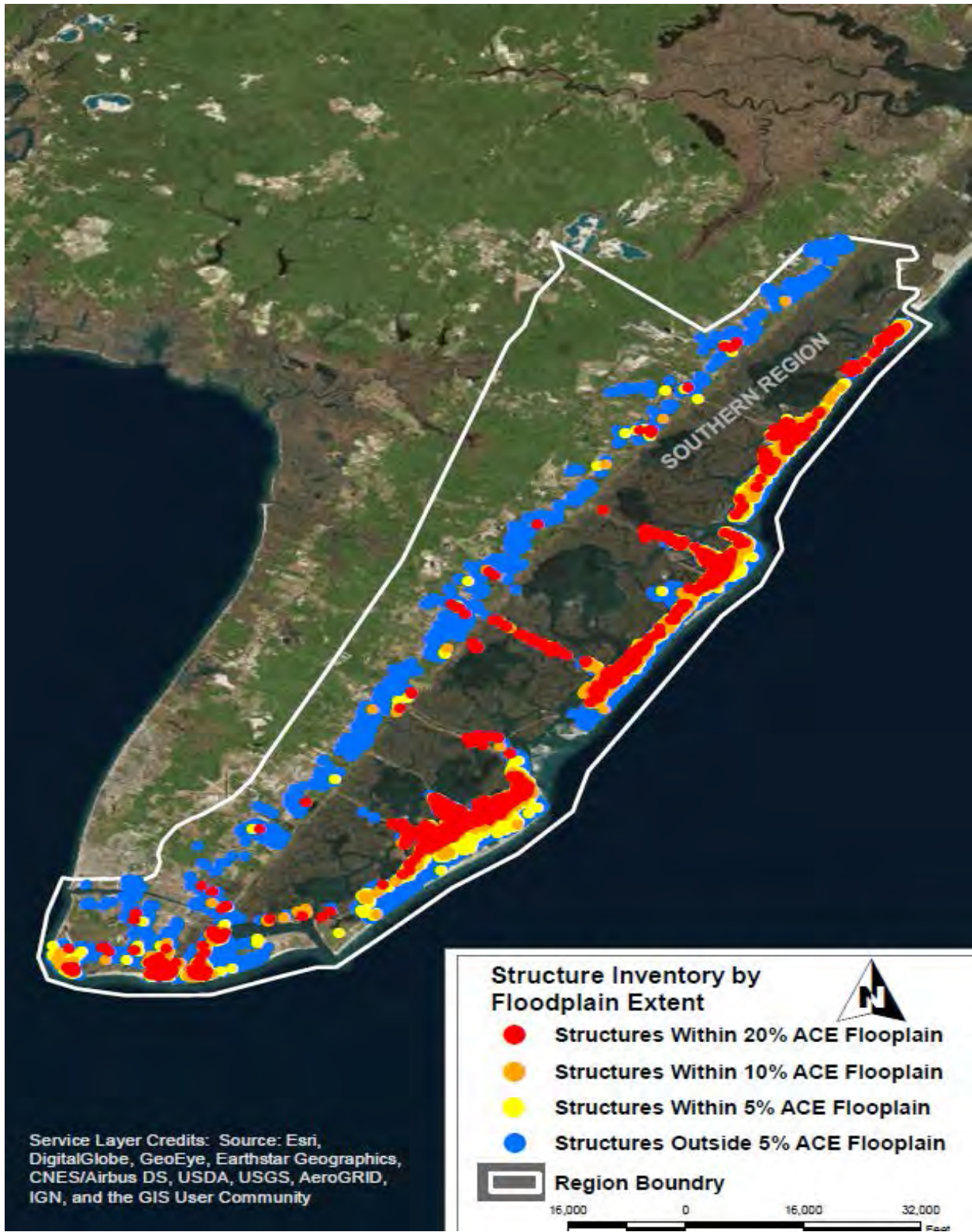

Figure 9-22: Structures Within Respective ACE Floodplains for the South Region

9.4.2.5 Benefits Analysis

Nonstructural economic analysis is conducted using HEC-FDA with an FY18 Federal Discount Rate of 2.75% over a 50 year period of analysis. All SFR1 and SFRM structures with first floor elevations below the 5% ACE event stage height were “elevated” to 15ft NAVD88 within the model (**Table 9-9**). This elevation height was selected only to remove any possibility of damage for these structures for any storm more frequent than the 1% ACE event. In reality, the exact elevation necessary for each structure (Design Flood Elevation) will fluctuate depending on the site specific FEMA BFEs.

One limitation of HEC-FDA is the requirement of a static inventory for the entirety of the period of analysis. Structures cannot be added, removed, nor elevated within the model. To circumvent this limitation for nonstructural analysis, two separate HEC-FDA models are developed. One model has the Without-Project Condition from FY2030 to FY2080 and a separate model has the With-Project Condition (updated inventory) from FY2030 to FY2080. The difference in calculated average annual damages between the model results is the coastal storm damage reduction benefits of retrofitting 31,660 of the 182,930 structures in the inventory.

Additional damage categories such as infrastructure, vehicle damage, emergency costs, and transportation delays are not mitigated through nonstructural measures and are included in the residual damage³ category.

Table 9-9; Nonstructural Measure Evaluation – 5% ACE Event Floodplain

Item	Number	Unit Cost	Total Cost
SFR1 Elevations	20,338	\$211,414	\$4,299,737,932
SFRM Elevations	11,322	\$245,147	\$2,775,554,334
Total Initial Const.	31,660		\$7,075,292,266
Period of Analysis			50
FY18 Discount Rate			2.75%
Capital Recovery Factor			0.037041
Total AAC			\$262,075,331
Without AAD			\$1,571,616,063
With AAD			\$1,119,950,393
Reduced AAD			\$451,665,670
AANB			\$189,590,339
BCR			1.72
Residual Damage			71.3%

³ **Residual damages** are the expected damages to surrounding property and other damage categories including vehicle damage, infrastructure damage, emergency costs, and transportation delays that are not protected by the CSRSM alternative as modeled in HEC-FDA. Residual damages are the damages expected in the study area even after construction of the proposed alternative

The nonstructural strategy when implemented across the study area, has a positive Average Annual Net Benefit and passes the NED economic criteria. However, alternatives that only employ a nonstructural strategy will have an exceptionally high residual damage percentage. Residual damages stem from damage to non-elevated surrounding property, vehicle damage, infrastructure damage, emergency costs, and transportation delays.

9.4.3 Storm Surge Barrier Measures

Storm surge barrier and interior bay closure single strategy alternatives are presented by each of the five Regions (**Figure 9-23**) based on the relative hydraulic independence of the storm surge barrier alternatives configurations identified for these regions. Since many of the storm surge barrier alternatives are developed around leaving Corson Inlet and Little Egg Inlet open, these two inlets were natural boundaries between the South/Central and Central/North regions. The storm surge barrier alternatives proposed within each Region are anticipated to not have a significant impact on the performance of a storm surge barrier proposed at a different Region. The HEC-FDA model reaches were developed with the storm surge barrier alternatives in mind and are restricted to exactly one of the five Regions with no overlaps. This allows for HEC-FDA reach outputs to be aggregated at the Region level and then Region level results to be aggregated (if necessary) to calculate a study wide proposed alternative combination. All storm surge barrier alternatives are calculated using the FY2018 Federal Discount Rate of 2.75% with a 50 year period of analysis and Intermediate RSLC.

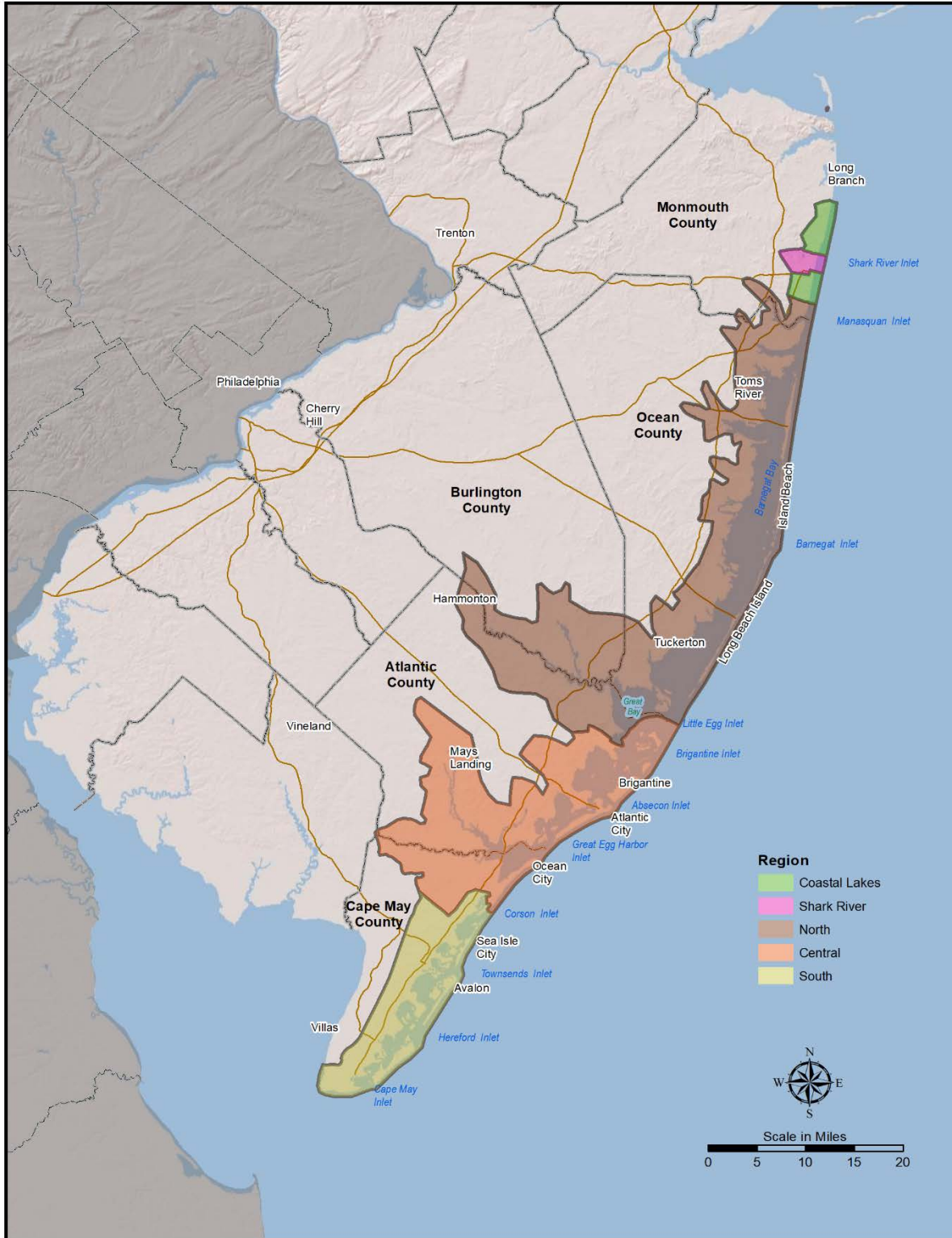

Figure 9-23: Study Area Regions

9.4.3.1 Hydrodynamic Modeling

Due to the complex network of inlets and bays that control the flow of water between the ocean and back bays, NAP requested assistance from ERDC-CHL in evaluating the effectiveness of storm surge barriers in reducing water levels in the NJBB study area. More specifically, NAP wanted help determining how much storm surge barriers reduce back-bay flooding. How effective storm surge barriers are at reducing water levels if other inlets are open and if multiple storm surge barriers could work as system? To answer these questions ERDCCHL leveraged the existing NACCS CSTORM-MS.

An iterative modeling approach was devised that would allow a large number of storm surge barrier alternatives to be considered before converging on a smaller final set of storm surge barrier alternatives. The iterative modeling approach is made feasible by utilizing a very small subset of 10 tropical cyclones for the first two iterations and a more robust set of 60 tropical cyclones for the third and final iteration in order to develop frequency distributions.

- Iteration 1: Model the hydraulic influence of each barrier island inlet by modeling one storm surge barrier at a time.
- Iteration 2: Model the effectiveness of large set of possible storm surge barrier alternatives.
- Iteration 3: Model the effectiveness of final set of storm surge barrier alternatives and develop frequency distributions of peak water levels.

Workshops with the ERDC-CHL, the NJBB PDT, and non-Federal sponsor (NJDEP) were held on January 31, 2018 and April 13, 2018 to review the model results from Iteration 1 and Iteration 2 and selected the closure configurations to be brought forward in the study (**Figure 9-24**, **Figure 9-25** and **Figure 9-26**). Many of the closure configurations for Iteration 2 are designed around leaving the most environmentally sensitive inlets open: Little Egg/Brigantine, Corson, and Hereford. Interior bay closures across the interior bays are added to several configurations to reduce water levels where environmentally sensitive inlets are open.

Modeling results from Iteration 1 showed that individual storm surge barriers at Great Egg Inlet, Barnegat Inlet, and Shark River Inlet were relatively effective. Whereas, individual storm surge barriers from Cape May to Corson Inlet were not as effective as standalone solutions at each location due to the close proximity of tidal inlets and would only perform better as part of system of storm surge barriers. An individual storm surge barrier at Manasquan Inlet was effective for some storms, but ineffective during storms with southerly winds capable of pushing storm surge northward from Barnegat Bay into Manasquan.

Modeling results from Iteration 2 showed that many of the storm surge barrier system (multiple) alternatives were relatively effective at reducing back bay water levels, even with Corson and Little Egg/Brigantine inlets open. However, storm surge barrier systems in the south experienced significant reductions in performance if any of the inlets in the south were left open, such as Hereford Inlet. Therefore, any storm surge barrier system in the south would likely require a storm surge barrier at all the inlets from Cape May Canal to Townsends Inlet. Many of the storm surge barrier alternatives such as “All Closures Less 2” showed considerable sensitivity to the storm and wind directions and it was unclear what the ultimate impact would be on frequency distributions of peak water levels. Iteration 2 also showed that many of the alternatives with bay

closures have the potential to increase surge on the unprotected side of the closure as wind-blown water piles up against the closure.

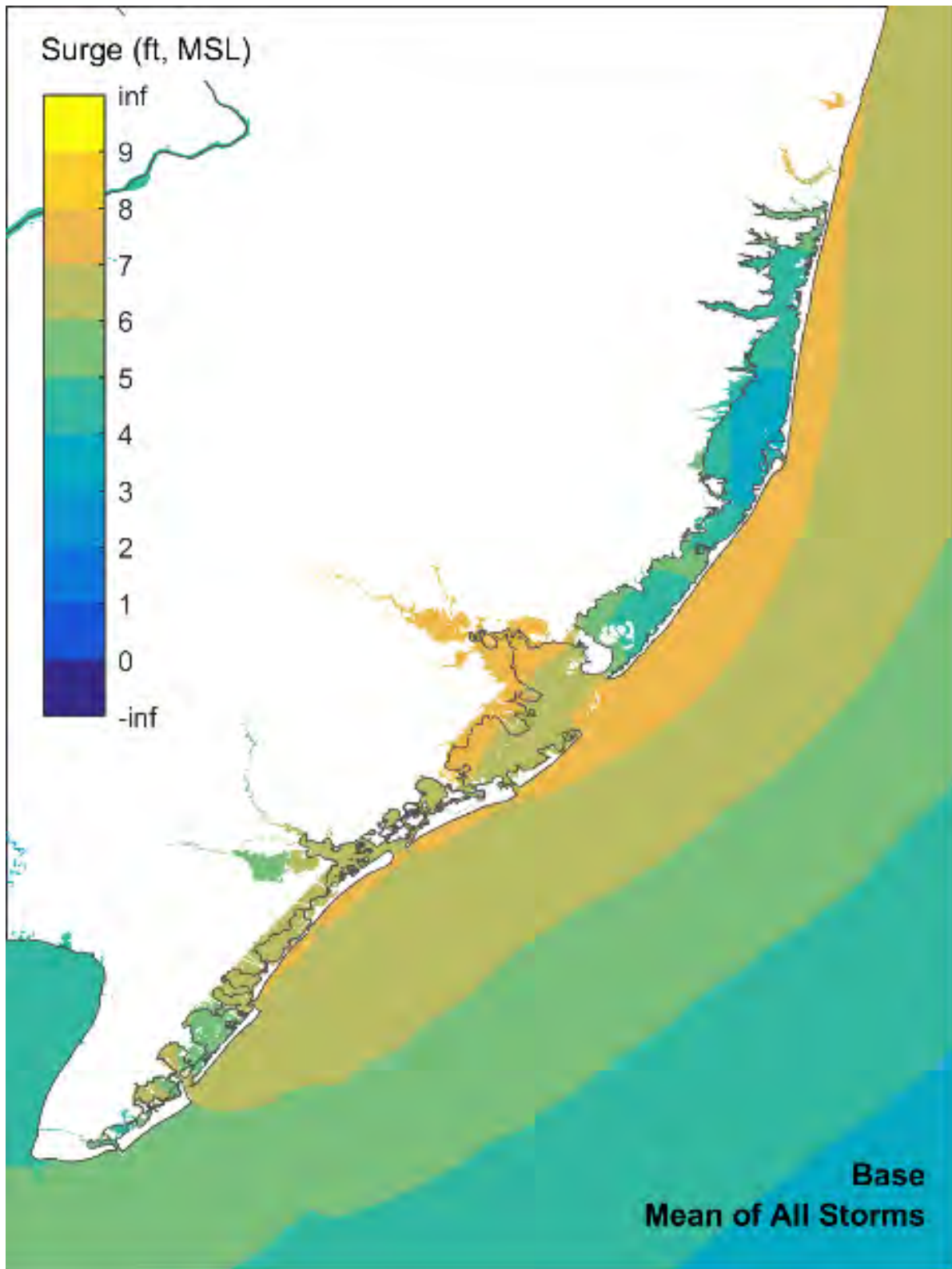

Figure 9-24: Modeling Results for Storm Surge Barrier Alternative - Base

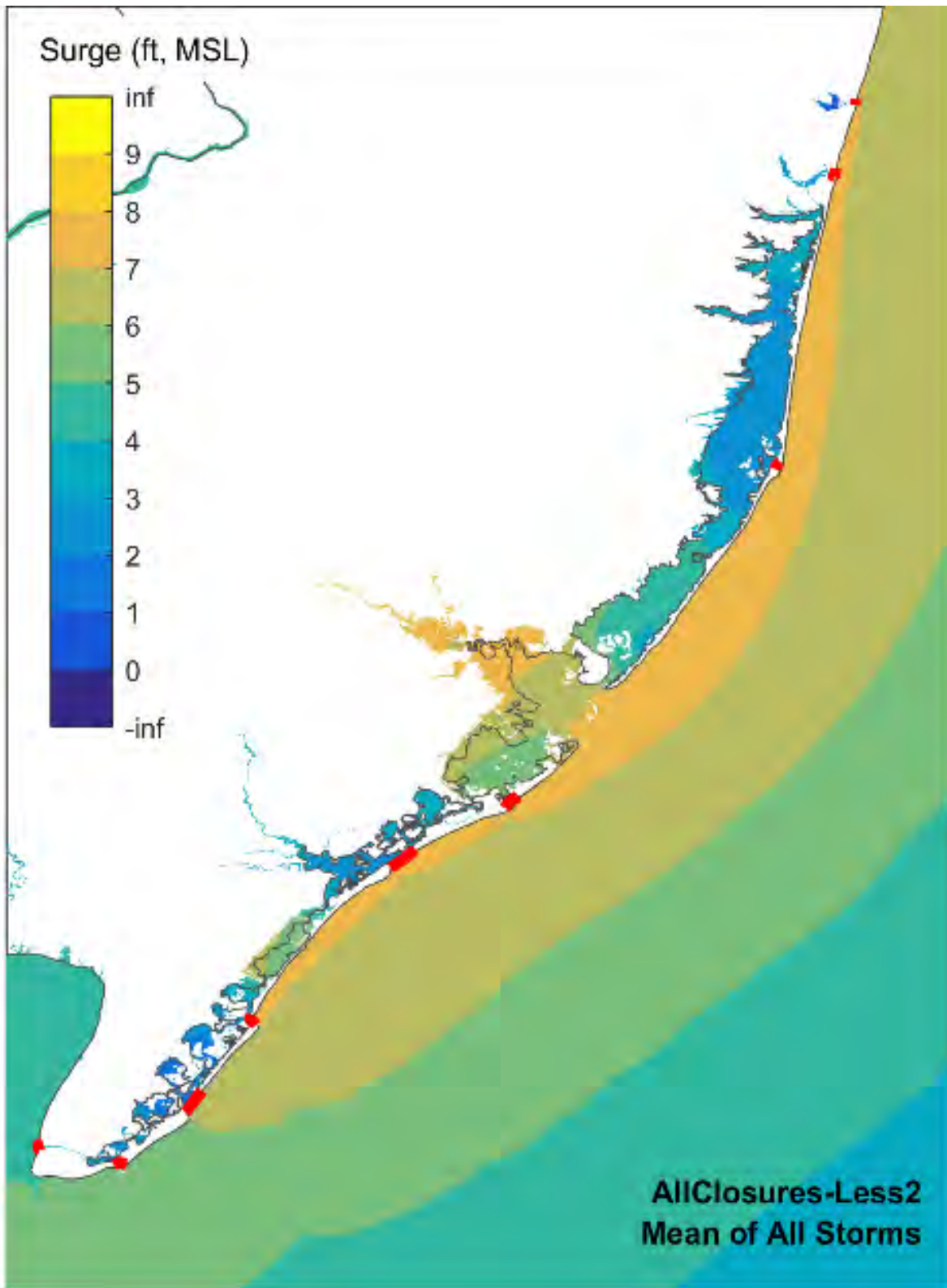

Figure 9-25: Modeling Results for Storm Surge Barrier Alternative All Closures Less 2

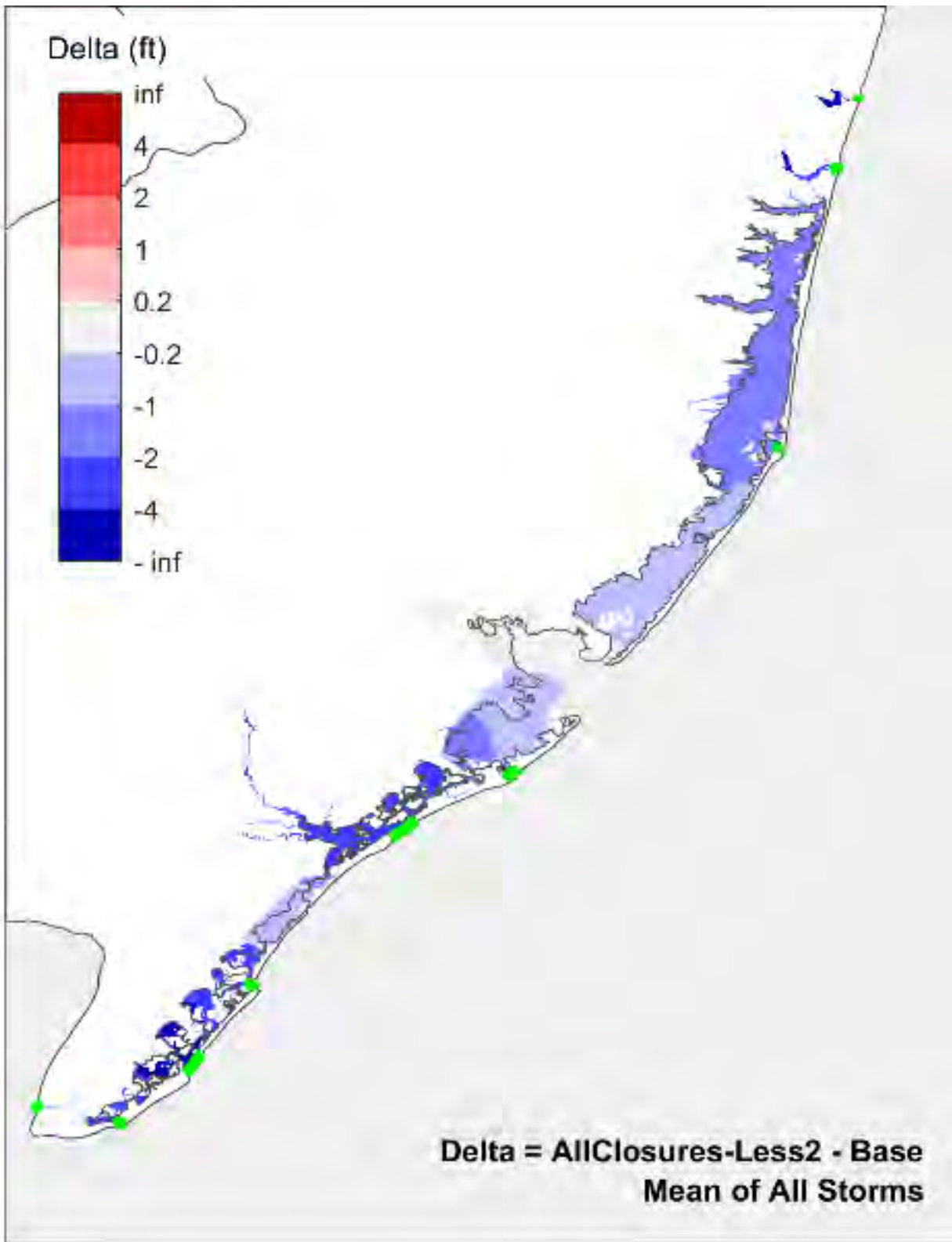

Figure 9-26: Modeling Results for Storm Surge Barrier Alternative All Closures - Less 2 - Base

Iteration 3 focused on the 8 alternatives identified during the April 13, 2018 workshop with the ERDC-CHL, the NJBB Project Delivery Team (PDT), and non-Federal sponsor (NJDEP). These 8 alternatives were selected based on their ability to generate the greatest NED benefits (flood damages reduced minus project costs) and be environmentally acceptable. Several alternatives were included that are not likely to be environmentally acceptable to ensure that alternatives were not eliminated too early before a more thorough plan formulation evaluation is applied. Hazard curves were generated for the Iteration 3 alternatives based on simulations for a storm suite of 60 tropical cyclones and the performance of each alternative was evaluated using the economic model HEC-FDA.

Modeling results show that the storm surge barriers may cause an increase in water levels on ocean-facing beaches in the immediate vicinity of the storm surge barrier. Beyond a distance of 1 mile of the storm surge barrier no discernable (less than 1 inch) increase in water levels was observed. **Figure 9-27** shows a comparison of the peak surge in the baseline conditions, All Closures Less 2 alternative, and the difference between All Closures Less 2 and the baseline conditions. An increase in ocean water levels of 6 to 12 inches is observed at the storm surge barrier, and increase of 2 to 6 inches within ½ mile of the barrier, and 1 to 2 inches within 1 mile of the barrier. It is noted that the values reported here are based on mean of all 10 tropical storms in NJBB Iteration 1 and 2 storm suites, and increase, proportionally, with stronger storms.

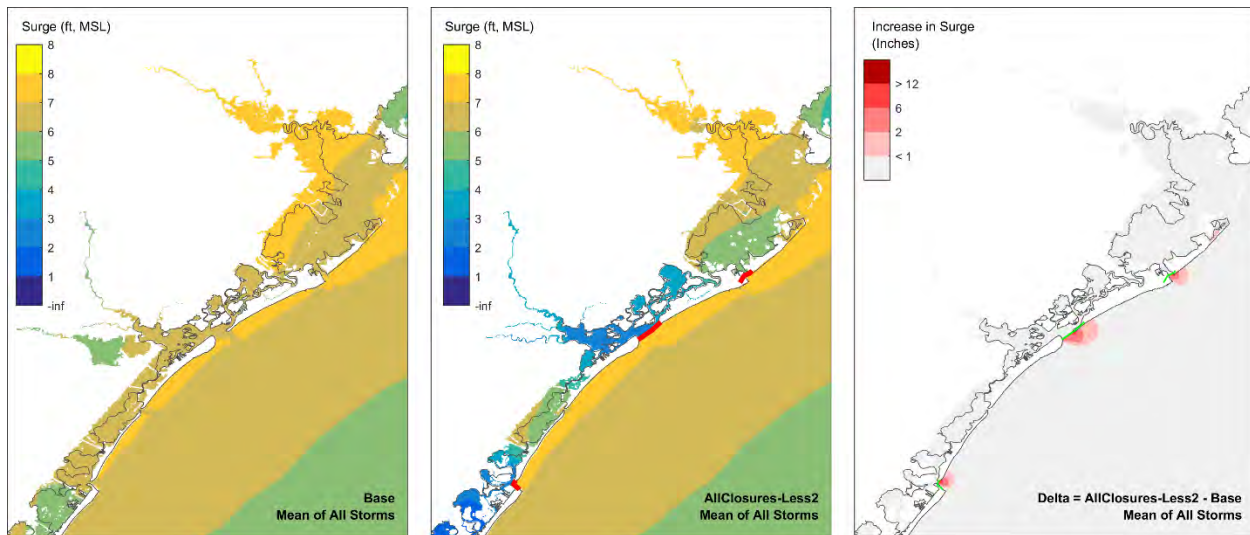

Figure 9-27: Impact of Storm Surge Barrier on Ocean-Facing Beaches

9.4.3.2 Design

A screening level storm surge barrier design was performed at 11 inlets and 8 interior bay closure locations based on ERDC modeling results. Preliminary assumptions, alignments and quantities were estimated using Google Earth, AutoCAD and available bathymetric and topographic data (see the Engineering Appendix B). Storm surge barrier and interior bay closure components design quantities including gate lengths, heights and areas can also be found in the Engineering

Appendix B. A parametric cost model, developed by USACE New York District, was utilized in the screening level design. The cost model is based on statistical data and major design considerations such as storm surge barrier crest elevations, lengths, depths and proportions of navigable and auxiliary flow features versus static elements. The model differentiates barrier components into three categories; navigable gate area, auxiliary flow gate area, and impermeable barrier area.

Navigable gates provide a navigable opening at each inlet with an unlimited height restriction. For the screening level design, navigable gates were assumed to be sector gates due to their prevalence both in the US and overseas. A sector gate contains two dynamic, or moveable, gates and two static housing structures. The dynamic gates remain in their housing structures, providing an open channel for navigation, and close during significant storm events. At this stage, the specific type of navigable gate does not affect the construction cost. Additional gate types will be investigated as the study continues.

Sector gates were positioned across the New Jersey Intracoastal Waterway (NJIWW) and Federal Navigation Channels. The size of the sector gates was scaled off an existing storm surge barrier site in the US, the Seabrook Flood Complex in New Orleans, LA. Not all storm surge barrier sites have a Federal Navigation Channel or NJIWW. For these sites, sector gates were positioned along the deepest portion of the waterway in order to promote tidal flow during open conditions.

Auxiliary flow gates were placed adjacent to navigable gates and throughout interior bay closure alignments to maintain tidal flow. Auxiliary flow gates were assumed to be vertical lift gates for the screening level design since they are one of the more common storm surge barrier gates types in the US and overseas. Vertical lift gates have a limited vertical clearance but are capable of providing recreational navigation. The initial dimensions of the vertical lift gates were sized from the Seabrook Flood Complex. The length of the dynamic gate will be refined as the study continues due to its impacts on flow restriction. At this stage, the specific type of auxiliary flow gate does not affect the construction cost. Additional gate types, besides vertical lift gates, will be investigated as the study continues.

Impermeable storm surge barriers connect to the navigable and auxiliary flow gates, tying them into the upland. Impermeable barriers were also positioned along portions of low lying marsh land across interior bay closure alignments. Levees, floodwalls, and seawalls were used in upland areas to tie the barrier into high ground or existing adjacent oceanfront projects. At this stage of the study, it was assumed the performance of the existing USACE CSRMs projects along the ocean shorelines would be compatible as a tie-in point for storm surge barrier and perimeter plan alternatives. It is acknowledged that there is variability in the design dune dimensions and performance of the existing CSRMs projects up and down the coast. In the next phase of the study, the performance and compatibility of the existing CSRMs projects as a tie-in point as well as all the static barrier components will be investigated further.

9.4.3.3 Costs

Detailed storm surge barrier designs and cost estimation methodology can be found in the Engineering Appendix B, but this section will cover the final cost estimates used for the economic analysis.

Detailed cost estimates were calculated for eleven possible storm surge barriers and eight possible interior bay closures. Estimates are based on barriers with navigable sector gates and vertical life gates to allow tidal flow outside of storm events.

Cost estimates are shown in **Table 9-10** and **Table 9-11** with values for initial construction, contingency, and interest during construction, and Operation, Maintenance, Repair, Replacement and Rehabilitation (OMRR&R).

Table 9-10: Storm Surge Barrier Cost Estimates (\$1000s)

Region	Barrier	Init. Const.	Contingency	Total Const.	Construction Duration (months)	IDC	Subtotal AAC	OMRR&R	Total AAC
South	Cape May Canal	\$389,412	\$145,232	<i>\$534,644</i>	55	\$67,387	\$22,300	\$8,250	<i>\$30,549</i>
South	Cape May Inlet	\$1,203,163	\$448,721	<i>\$1,651,884</i>	113	\$427,769	\$77,032	\$25,500	<i>\$102,532</i>
South	Hereford Inlet	\$1,001,373	\$373,463	<i>\$1,374,836</i>	66	\$207,944	\$58,628	\$21,222	<i>\$79,850</i>
South	Townsend's Inlet	\$785,109	\$292,807	<i>\$1,077,916</i>	56	\$138,333	\$45,051	\$16,638	<i>\$61,689</i>
Boundary	Corson Inlet	\$686,898	\$256,179	<i>\$943,077</i>	61	\$131,834	\$39,816	\$14,556	<i>\$54,372</i>
Central	Great Egg Harbor	\$2,838,878	\$1,058,762	<i>\$3,897,641</i>	126	\$1,125,444	\$186,060	\$60,175	<i>\$246,235</i>
Central	Absecon Inlet	\$2,065,920	\$770,487	<i>\$2,836,407</i>	127	\$825,513	\$135,641	\$43,789	<i>\$179,430</i>
Boundary	Brigantine to Little Egg Inlet	\$4,390,448	\$1,637,421	<i>\$6,027,869</i>	143	\$1,975,383	\$296,448	\$93,066	<i>\$389,514</i>
North	Barnegat Inlet	\$1,251,230	\$466,647	<i>\$1,717,878</i>	105	\$413,364	\$78,943	\$26,519	<i>\$105,462</i>
North	Manasquan Inlet	\$605,604	\$225,861	<i>\$831,465</i>	81	\$154,341	\$36,515	\$12,833	<i>\$49,348</i>
Shark	Shark River Inlet	\$430,712	\$160,635	<i>\$591,347</i>	48	\$65,048	\$24,313	\$9,125	<i>\$33,439</i>
TOTAL ESTIMATED AMOUNT		\$15,648,749	\$5,836,214	<i>\$21,484,962</i>	-	\$5,532,359	\$1,000,746	\$331,673	<i>\$1,332,419</i>

Table 9-11: Interior Bay Closure Cost Estimates (\$1000s)

Region	Barrier	Initial Construct.	Contingency	Total Const.	Duration (months)	IDC	Subtotal AAC	OMRR&R	Total AAC
South	Wildwood Blvd	\$641,899	\$238,183	<i>\$880,082</i>	55	\$110,927	\$36,708	\$13,248	<i>\$49,956</i>
South	Stone Harbor Blvd	\$828,572	\$306,461	<i>\$1,135,034</i>	56	\$145,663	\$47,438	\$16,782	<i>\$64,220</i>
South	Sea Isle Blvd	\$426,966	\$158,037	<i>\$585,003</i>	50	\$67,032	\$24,152	\$8,692	<i>\$32,844</i>
Central	52nd Street	\$307,798	\$113,822	<i>\$421,620</i>	49	\$47,344	\$17,371	\$6,234	<i>\$23,605</i>
Central	Absecon Blvd	\$720,765	\$265,805	<i>\$986,570</i>	50	\$113,045	\$40,731	\$14,381	<i>\$55,112</i>
Central	North Point	\$2,256,894	\$840,313	<i>\$3,097,206</i>	133	\$944,003	\$149,690	\$47,431	<i>\$197,121</i>
North	Holgate	\$2,459,847	\$915,349	<i>\$3,375,197</i>	125	\$966,853	\$160,834	\$51,543	<i>\$212,376</i>
North	Point Pleasant Canal	\$233,064	\$86,919	<i>\$319,984</i>	49	\$35,932	\$13,183	\$4,934	<i>\$18,117</i>
TOTAL ESTIMATED AMOUNT		\$7,875,807	\$2,924,890	<i>\$10,800,696</i>	-	\$2,430,798	\$490,107	\$163,245	<i>\$653,351</i>

9.4.3.4 Economics

Storm surge barriers provide coastal storm risk management benefits by lowering flood stage heights during storm events. The effectiveness of the storm surge barrier alternative is dependent upon the combination of storm surge barriers and interior bay closures as well as hydraulic conditions in the study region.

9.4.3.4.1 Shark River Region

Shark River Inlet is the only inlet in the study area which is independent from tidally-influenced flooding of all other inlet systems during normal non-storm tidal conditions. The Region experiences \$9,828,750 in average annual damages, or just 0.6% of all damages in the study area. Due to local conditions around the inlet, the Shark River storm surge barrier would require the construction of a new coastal structure, either dune or floodwall, along the ocean front to provide high ground for the storm surge barrier to tie into.

Figure 9-28 shows the extent of the Shark River Region as well as the outline of the potential storm surge barrier measure.

The Shark River storm surge barrier has a projected \$33,349,000 average annual cost (AAC) with \$6,149,000 in average annual benefits (AAB) for -\$27,289,000 in average annual net benefits (AANB) with a 0.18 benefit-cost ratio (BCR). The storm surge barrier does prevent 62.6% of storm damage in the Region, with the majority of the residual damages occurring outside the storm surge barrier in the Coastal Lakes Region, but the potential damage pool inside Shark River Inlet is too small to support the barrier cost.

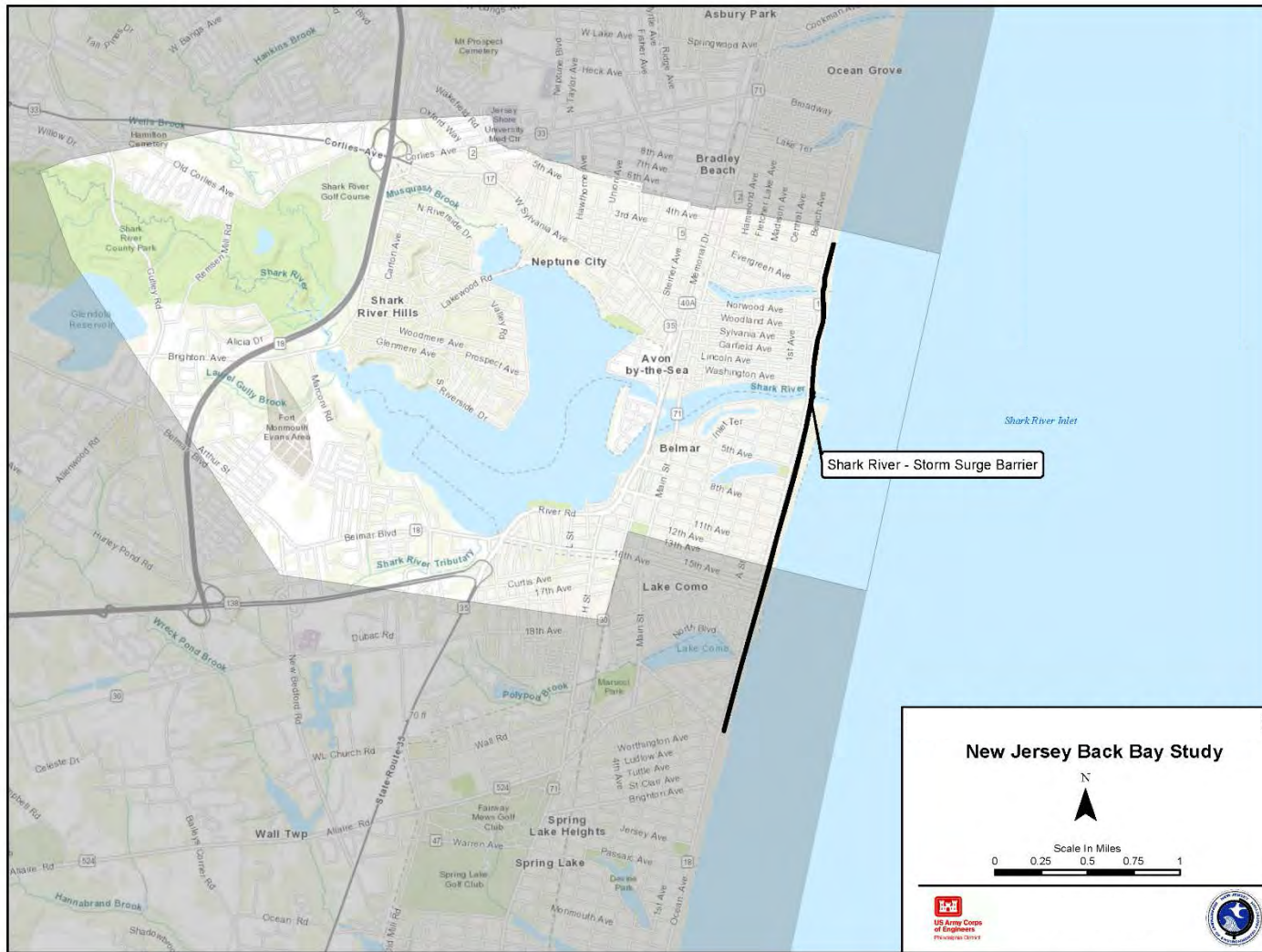

Figure 9-28: Shark River Region Storm Surge Barrier Alternatives (Note: Approximate, preliminary locations)

9.4.3.4.2 North Region

The North Region includes the possibility of two storm surge barriers (SSB) at Barnegat Inlet and Manasquan Inlet, and two interior bay closures at Point Pleasant Canal and Holgate. The combination of these measures creates the three alternatives shown in **Figure 9-29**, **Figure 9-30** and **Figure 9-31**.

Table 9-12 displays the AANB and BCR results for the three storm surge barrier and interior bay closure combination alternatives.

Table 9-12: North Region Storm Surge Barrier Alternatives

ITEM	Manasquan SSB + Barnegat SSB	Manasquan SSB + Barnegat SSB + Holgate BC	Manasquan SSB + Pt. Pleasant BC
Initial Construction	\$2,549,342,000	\$5,924,539,000	\$1,151,448,000
AAC	\$154,810,000	\$367,186,000	\$67,465,000
AAD Without	\$548,225,000	\$548,225,000	\$548,225,000
AAD With	\$239,397,000	\$113,711,000	\$505,723,000
AAB	\$308,828,000	\$434,515,000	\$42,502,000
AANB	\$154,018,000	\$67,329,000	-\$24,963,000
BCR	1.99	1.18	0.63
Residual Damage	43.7%	20.7%	92.2%
O&M	\$39,351,000	\$90,894,000	\$17,766,000

Closing Manasquan Inlet and Barnegat Inlet with storm surge barriers has the highest NED AANB of the three storm surge barrier and interior bay closure alternatives. Adding an interior bay closure at Holgate does reduce residual damages from 43.7% to 20.6%, but has 56.3% fewer AANB and a considerably higher AAC and O&M cost.

The final alternative, constructing only the Manasquan storm surge barrier and the Point Pleasant Canal closure, is not economically justified.

It is important to note that any of the alternatives discussed so far can be combined with other measure types to further drive down residual damages and boost AANB. The combination of perimeter, nonstructural, and storm surge barrier alternative is discussed later in the Economics Appendix C.

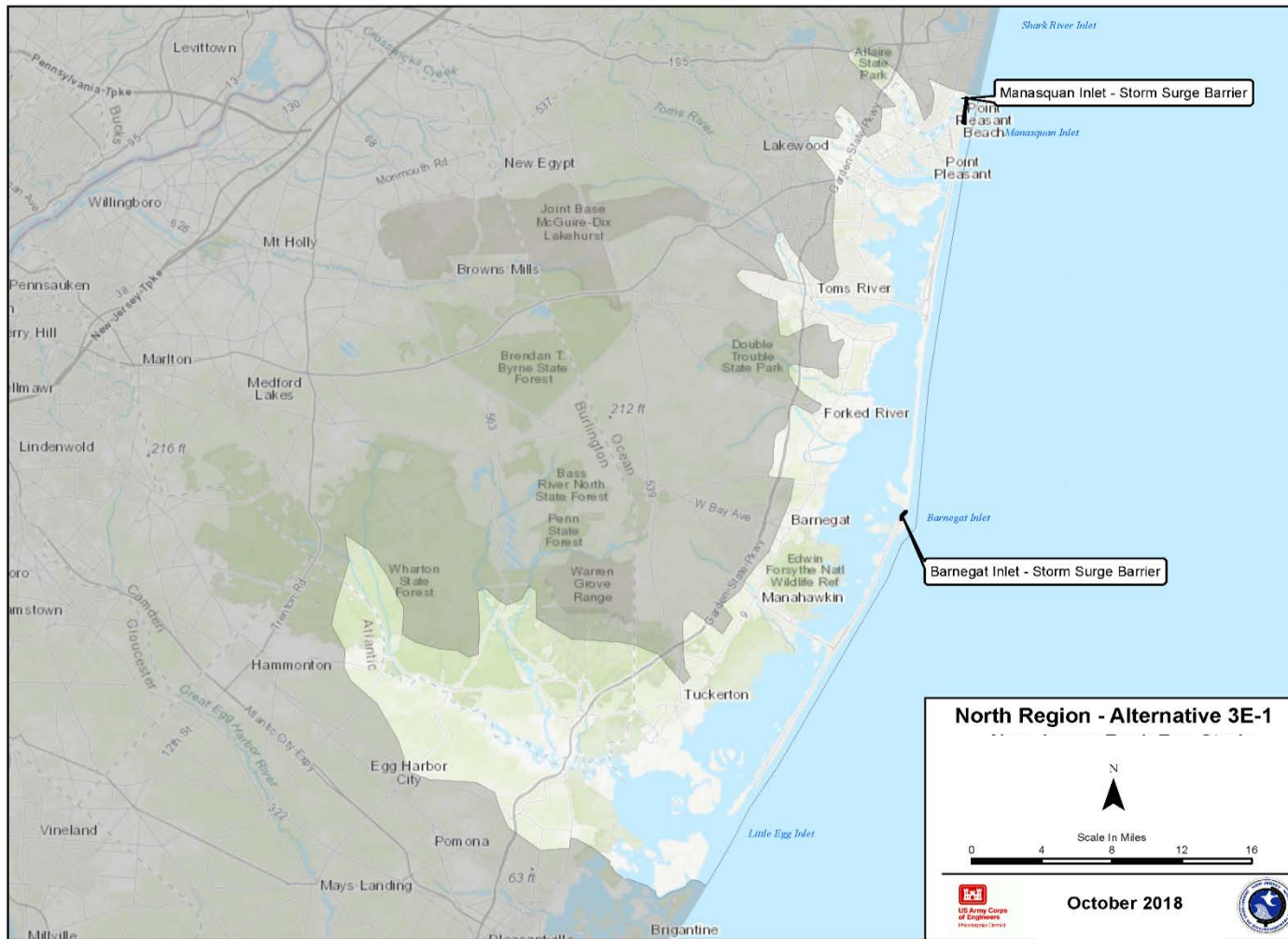

Figure 9-29: North Region Storm Surge Barrier Alternatives (Note: Approximate, preliminary locations)

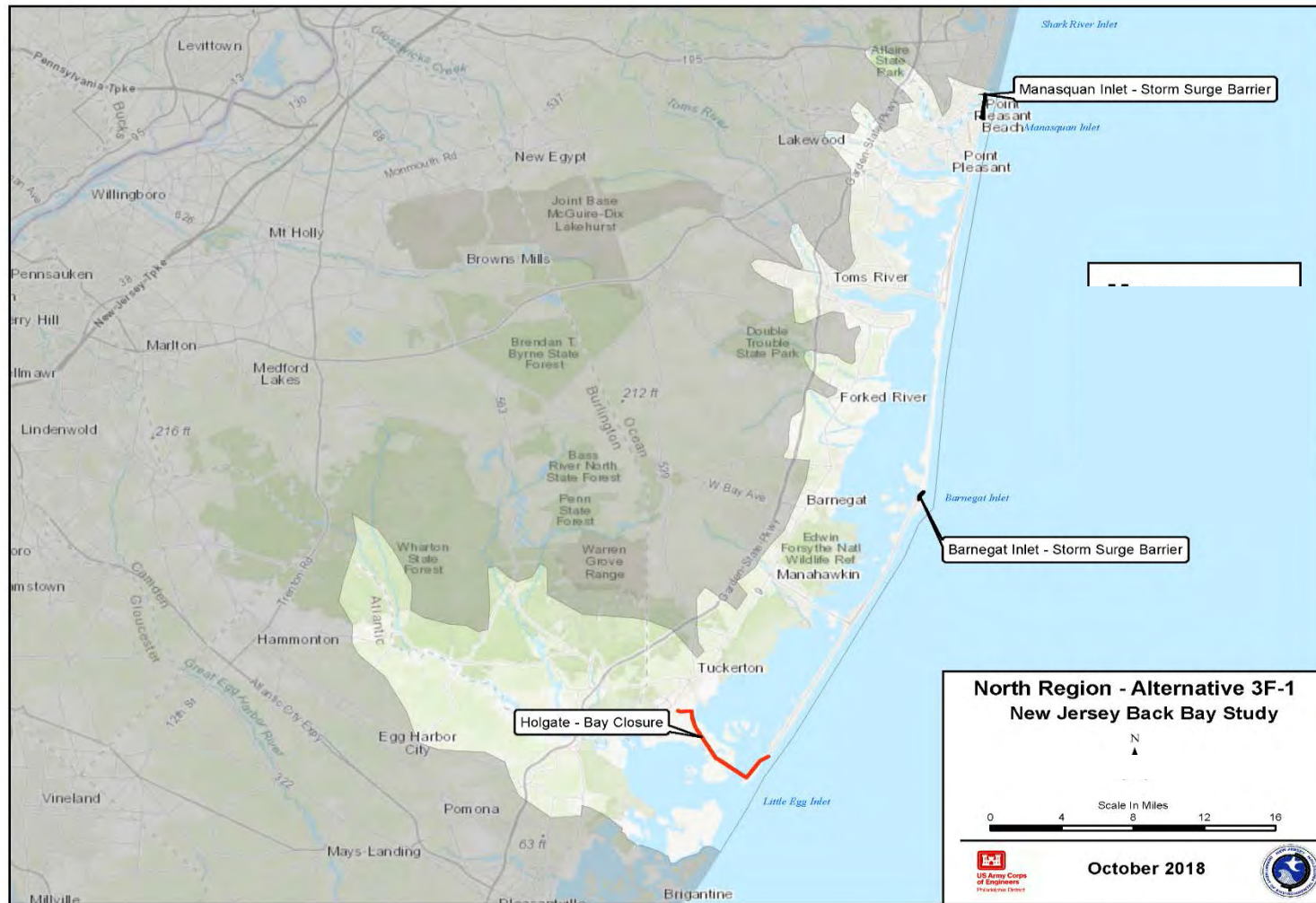

Figure 9-30: North Region Storm Surge Barrier Alternatives (Note: Approximate, preliminary locations)

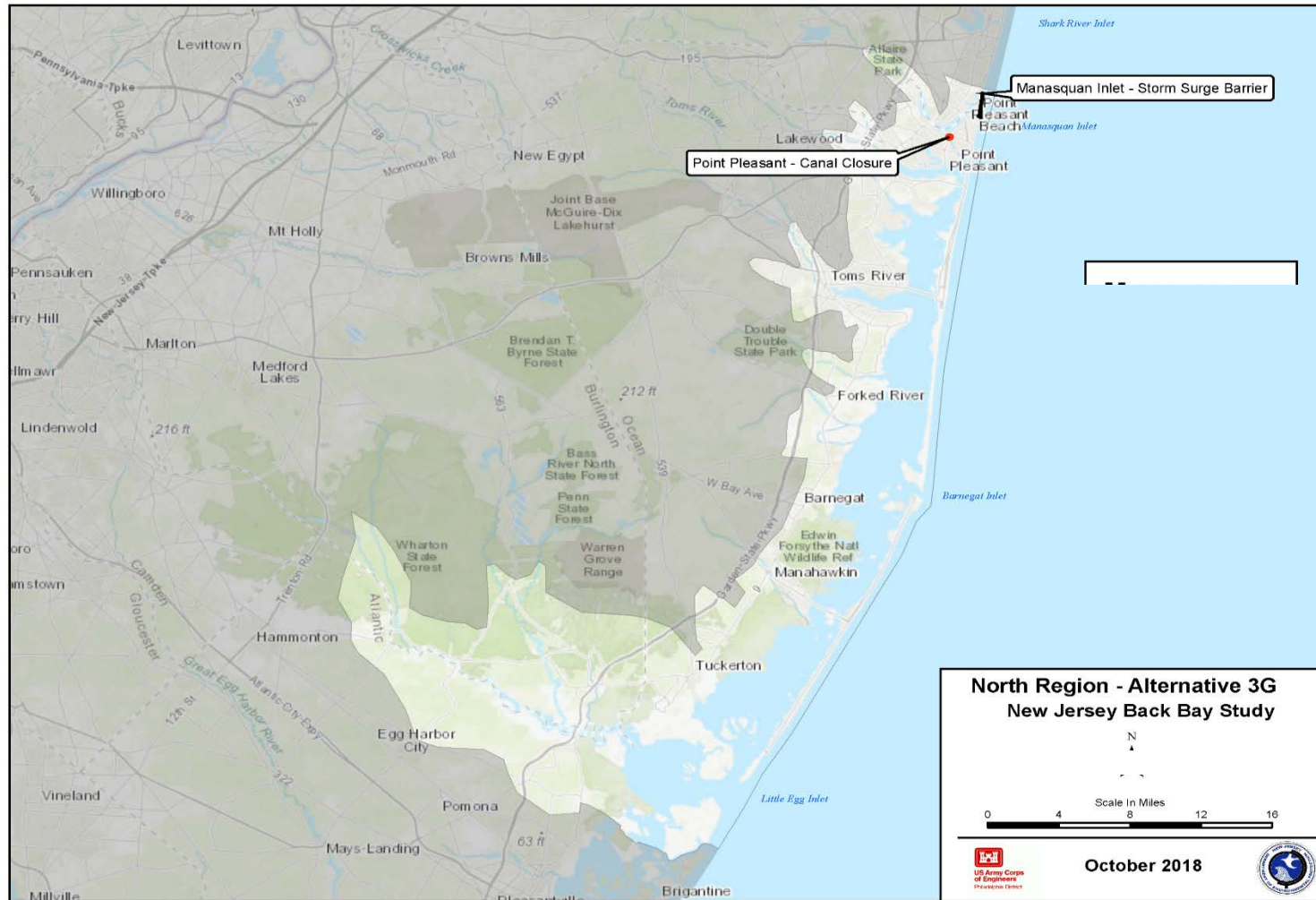

Figure 9-31: North Region Storm Surge Barrier Alternatives (Note: Approximate, preliminary locations)

9.4.3.4.3 Central Region

Initial analysis of the Central Region includes the possibility for two storm surge barriers at Absecon Inlet and Great Egg Harbor Inlet and two interior bay closures at North Point and Absecon Blvd. The combination of these measures creates the three alternatives shown in **Figure 9-32**, **Figure 9-33** and **Figure 9-34**.

During further analysis, a third interior bay closure was modeled at South Ocean City (north of Corson's Inlet). That interior bay closure is not presented here, but is included in the "hybrid" alternative analysis in the Economics Appendix C.

Table 9-13 displays the AANB and BCR results for the three storm surge barrier and interior bay closure combination alternatives.

Table 9-13: Central Region Storm Surge Barrier Alternatives

ITEM	Absecon SSB + Great Egg Harbor SSB	Absecon SSB + Great Egg Harbor SSB + North Point BC	Great Egg Harbor SSB + Absecon Blvd. BC
Initial Construction	\$6,734,047,000	\$9,831,254,000	\$4,884,211,000
AAC	\$425,665,000	\$622,785,000	\$301,347,000
AAD Without	\$702,936,000	\$702,936,000	\$702,936,000
AAD With	\$132,766,000	\$50,016,000	\$108,652,000
AAB	\$570,170,000	\$652,920,000	\$594,284,000
AANB	\$144,506,000	\$30,135,000	\$292,937,000
BCR	1.34	1.05	1.97
Residual Damage	18.9%	7.1%	15.5%
O&M	\$103,964,000	\$151,395,000	\$74,556,000

Closing Absecon Inlet and Great Egg Harbor Inlet is economically justified with over \$144,000,000 in AANB. Adding North Point interior bay closure does reduce residual damages down to 7.1%, but results in \$114,371,000 in lost AANB due to the estimated \$3 billion initial construction cost.

Construction of an interior bay closure at Absecon Blvd (southwest of Brigantine Island) slightly increases residual damages in comparison to the North Point interior bay closure, but is considerably less expensive than either the Absecon storm surge barrier or the North Point interior bay closure and maximizes NED AANB at \$292,937,000 with a BCR of 1.97. The addition of the South Ocean City interior bay closure during additional analysis further reduced residual damages and increased AANB.

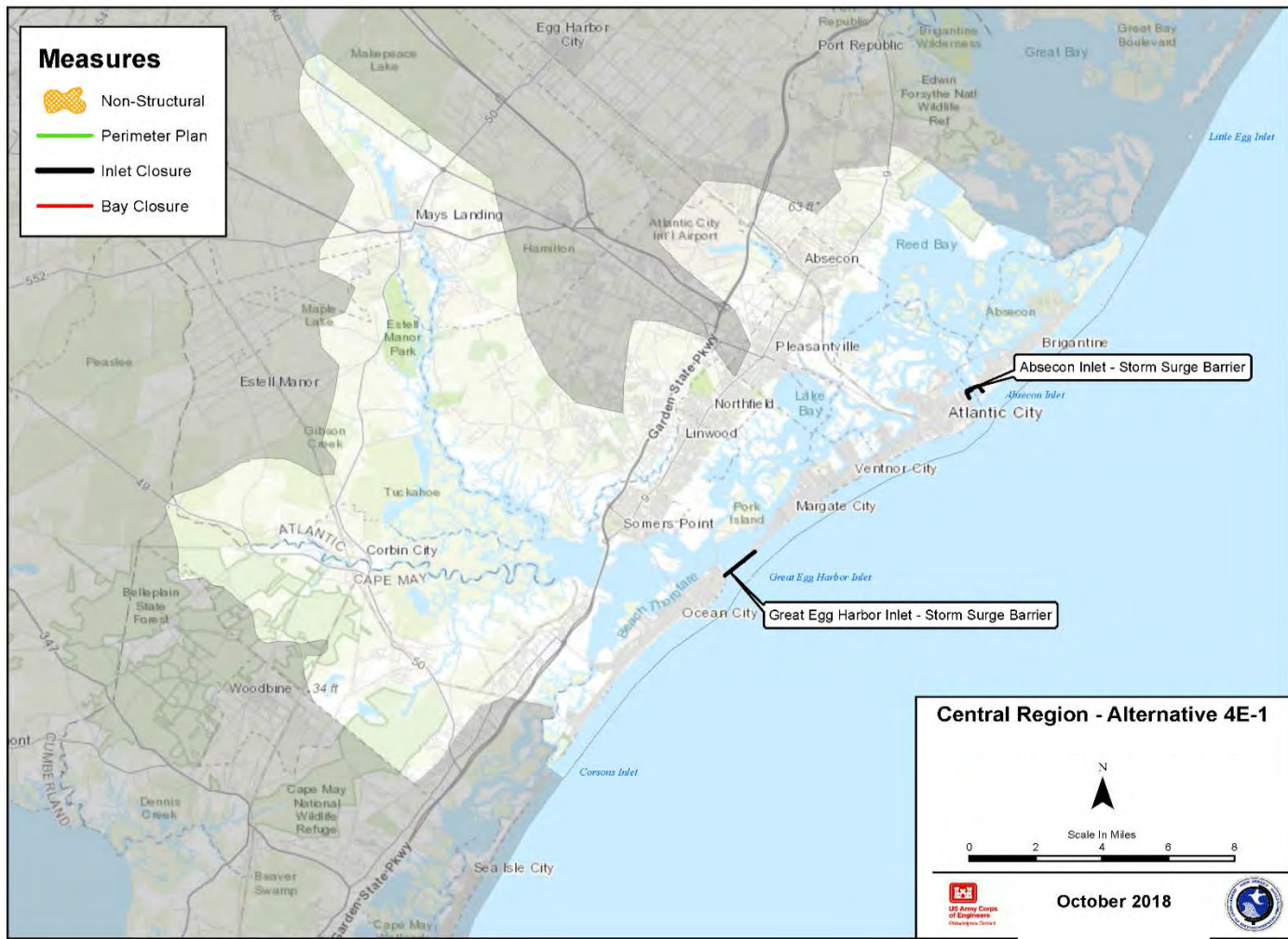

Figure 9-32: Central Region Storm Surge Barrier Alternatives (Note: Approximate, preliminary locations)

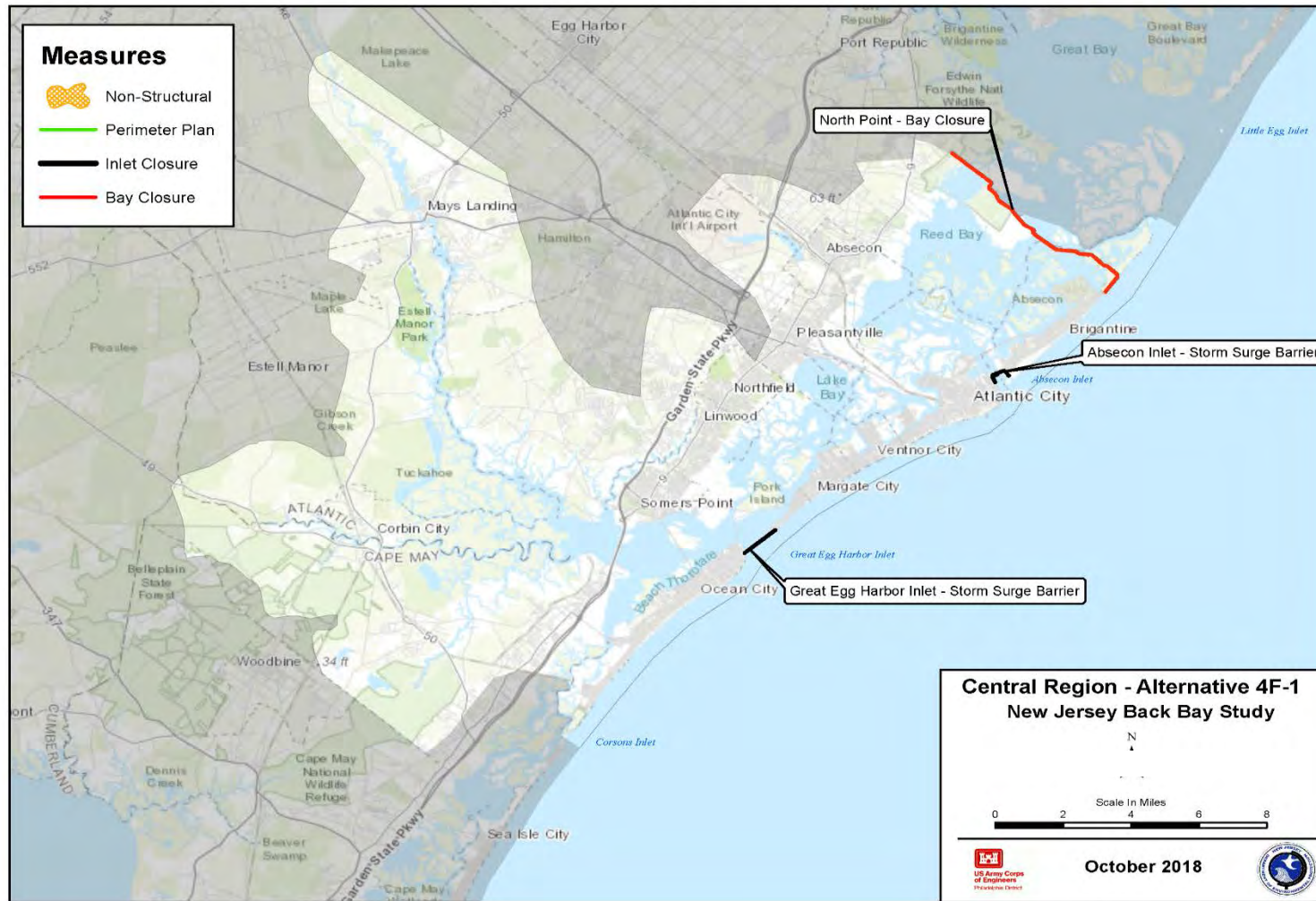

Figure 9-33: Central Region Storm Surge Barrier Alternatives (Note: Approximate, preliminary locations)

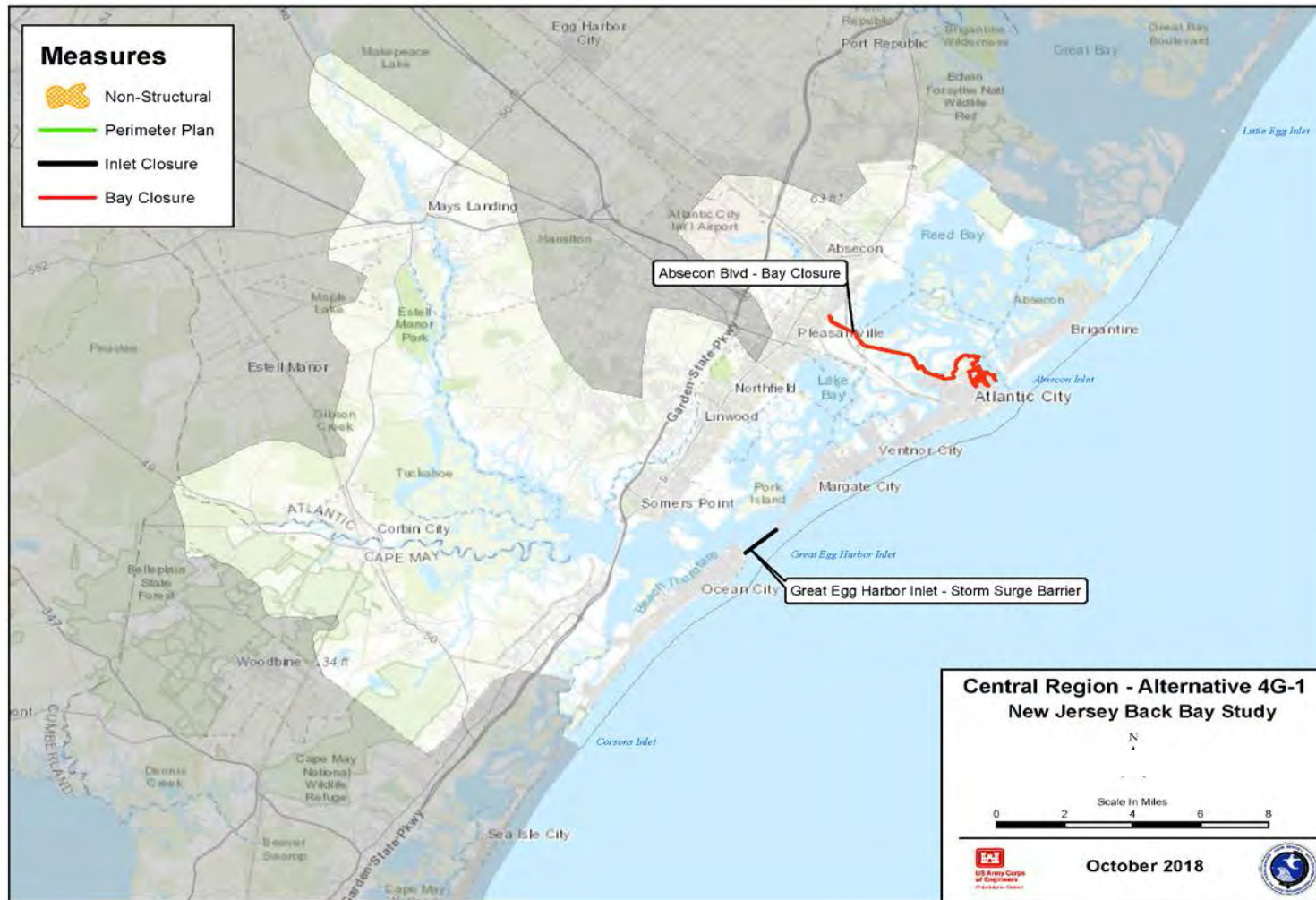

Figure 9-34: Central Region Storm Surge Barrier Alternatives (Note: Approximate, preliminary locations)

9.4.3.4.4 South Region

Analysis of the South Region includes four storm surge barriers at Cape May Canal, Cape May Inlet, Hereford Inlet, and Townsends Inlet, and three bay closure sat Wildwood Blvd, Stone Harbor Blvd, and Sea Isle City Blvd. The combination of these measures creates the three alternatives shown in **Figure 9-35**, **Figure 9-36** and **Figure 9-37**.

The South Region has four inlets with a high level of interdependency plus environmental concerns at Hereford Inlet. For any proposed alternative to have a significant impact on stage height reductions, all four inlets need to be closed. In **Table 9-14**, the last two alternatives have some nonstructural measures included due to concerns about induced damages, but the additional AAB and AAC from these components is minor and does not affect the economic justification of the alternatives.

Table 9-14 displays the AANB and BCR results for the three storm surge barrier and interior bay closure combination alternatives.

Table 9-14: South Region Storm Surge Barrier Alternatives

ITEM	Cape May Canal + Cape May Inlet + Hereford Inlet + Townsends Inlet	Cape May Canal + Cape May Inlet + Hereford Inlet + Townsends Inlet + Sea Isle Blvd BC	Cape May Canal + Cape May Inlet + Wildwood Blvd BC + Stone Harbor Blvd BC + Townsends Inlet + Sea Isle Blvd BC
Initial Construction	\$4,639,279,000	\$5,265,569,000	\$5,924,476,000
AAC	\$274,620,000	\$308,994,000	\$344,010,000
AAD Without	\$310,626,000	\$310,626,000	\$310,626,000
AAD With	\$19,772,000	\$12,431,000	\$16,702,000
AAB	\$290,854,000	\$298,195,000	\$293,924,000
AANB	\$16,233,000	-\$10,799,000	-\$50,086,000
BCR	1.06	0.97	0.85
Residual Damage	6.4%	4.0%	5.4%
O&M	\$71,610,000	\$80,302,000	\$89,110,000

Closing all four of the inlets in the South Region is economically justified, but ignores serious environmental concerns and potential mitigation costs at Herford Inlet.

Adding an interior bay closure at Sea Isle Blvd does drive down residual damages, but decreases overall AANB and drives the BCR below 1.0. Replacing the storm surge barrier at Hereford Inlet with two interior bay closure avoids some of the potential mitigation costs, but adds significant construction costs to the alternatives and drives the BCR further below 1.0.

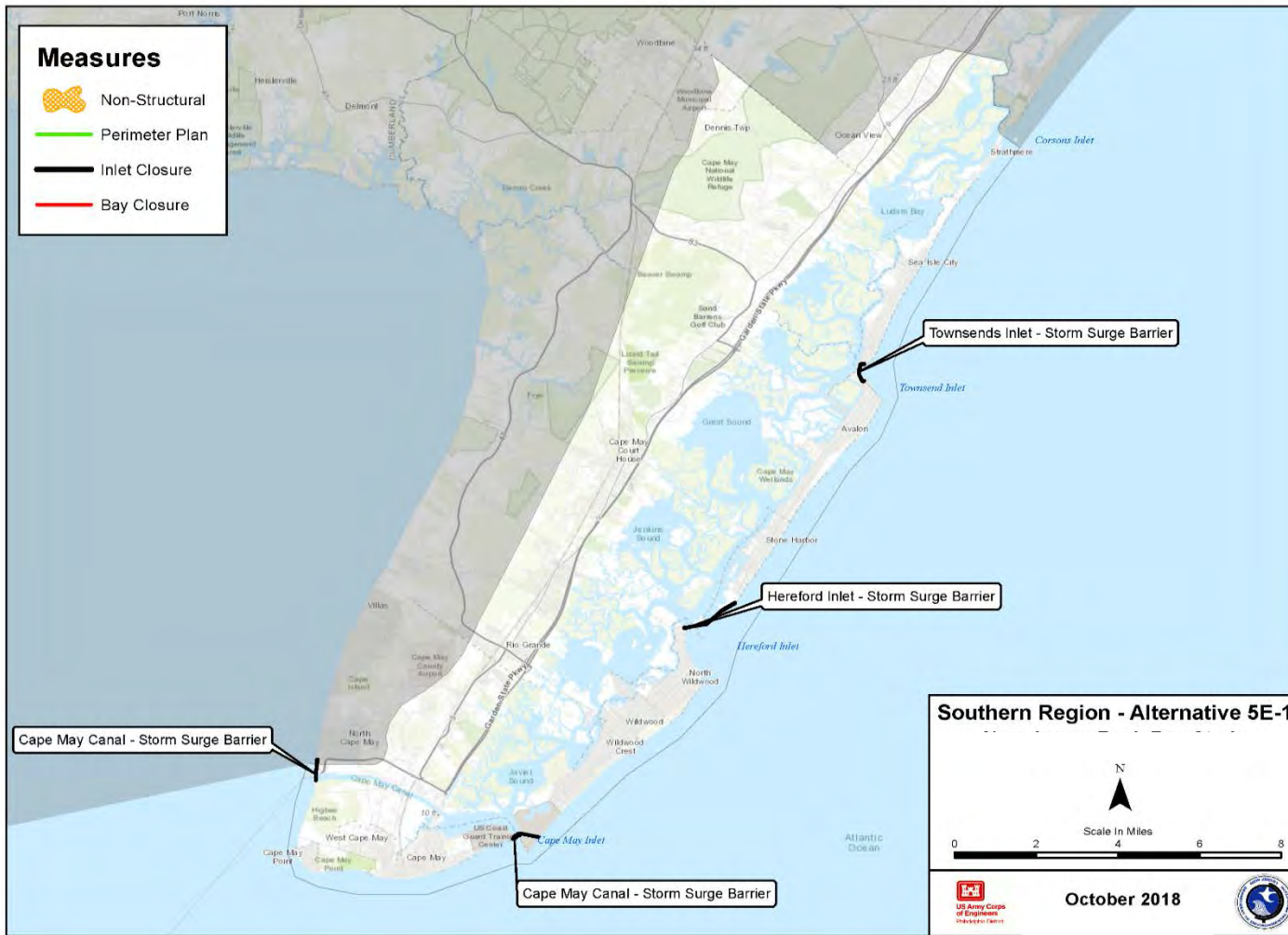

Figure 9-35: South Region Storm Surge Barrier Alternatives (Note: Approximate, preliminary locations)

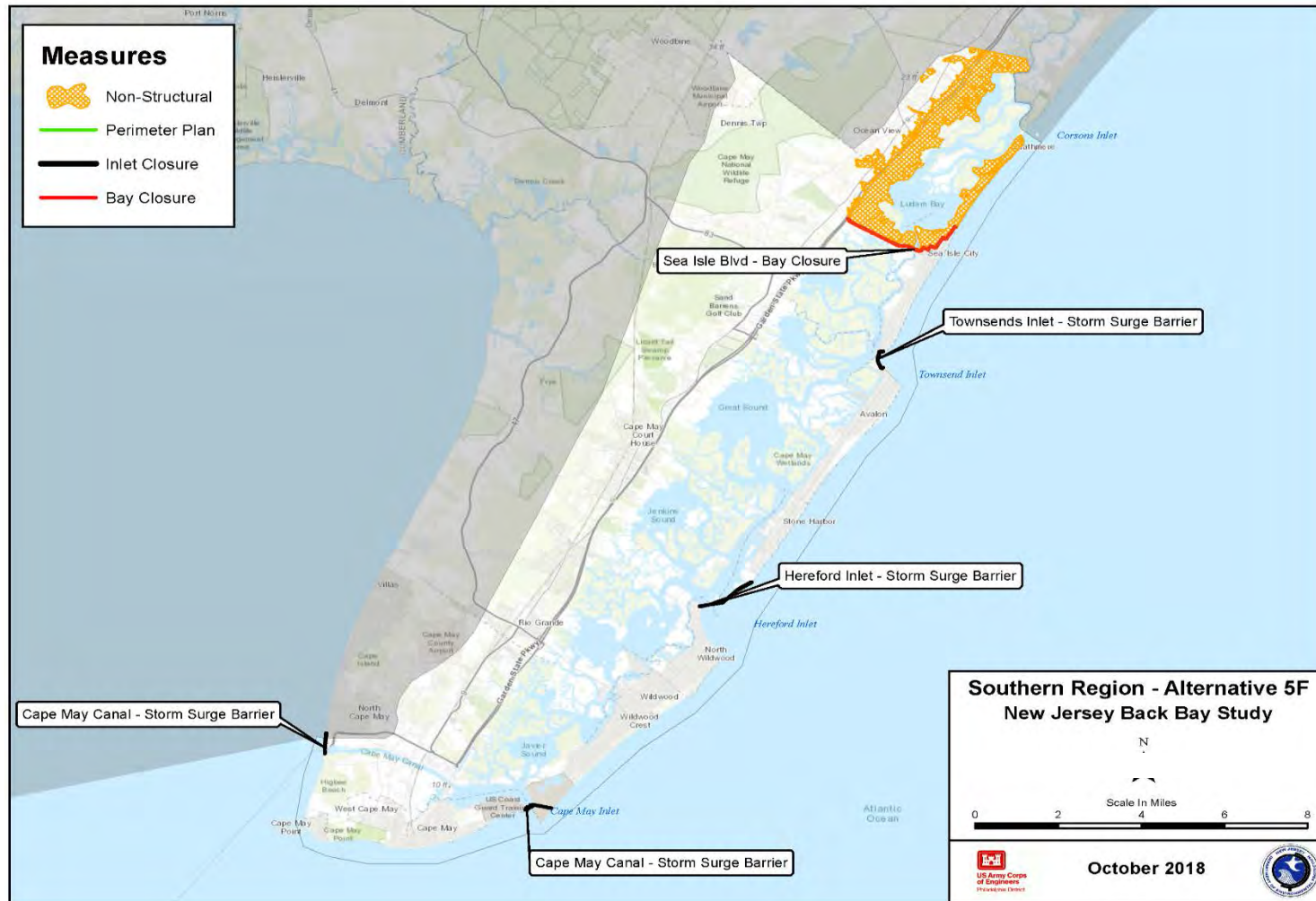

Figure 9-36: South Region Storm Surge Barrier Alternatives (Note: Approximate, preliminary locations)

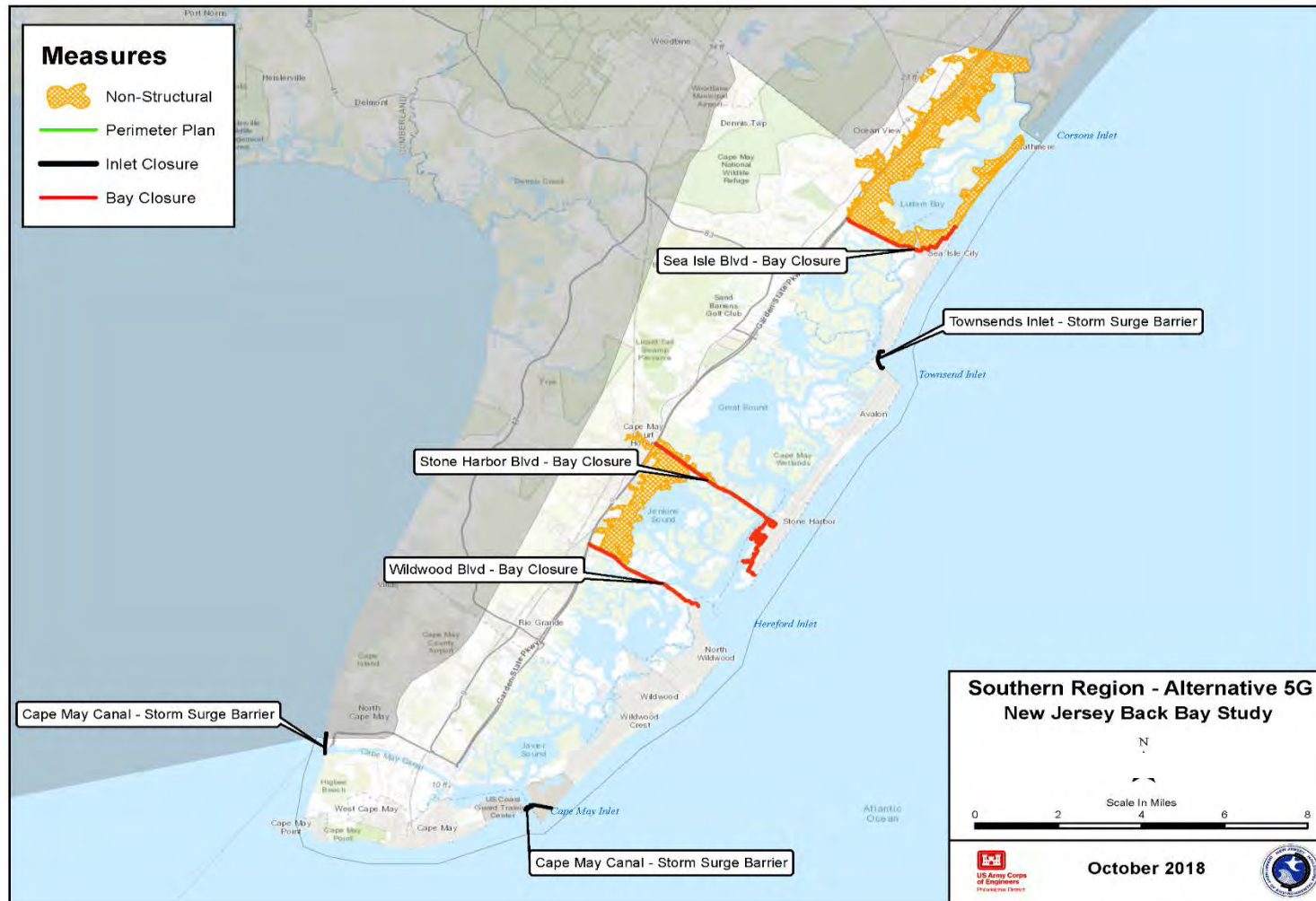

Figure 9-37: South Region Storm Surge Barrier Alternatives (Note: Approximate, preliminary locations)

9.5 Multi-Strategy Formulation

Following the economic evaluation of each potential strategy in isolation, potential CSRMs solutions were combined into multi-strategy alternatives.

The following tables show 51 potential single and multi-strategy alternatives, though not all alternatives are considered complete or environmentally acceptable. All 51 alternatives are shown to provide transparency on the transition from isolated single strategy alternatives to a preliminary focused array of complete and implementable hybrid multi-strategy alternative plans. Individual maps for each of these alternative plans can be found in the Economics Appendix C in the Section titled B-6 Hybrid NED (Multi-Measure) Alternative.

The 51 alternatives were separated into 5 regional groups that were each assigned a number to describe their location: (1) Entire Study Area, (2) Shark River, (3) Area between Manasquan Inlet and Little Egg Inlet; referred to as “North Region”, (4) Area south of Little Egg Inlet and north of Corson Inlet, referred to as “Central Region”, and (5) Areas south of Corson Inlet, referred to as “South Region”. Within each region, the alternatives were assigned a letter to describe the strategies implemented: (A) nonstructural strategy only, (B) perimeter strategy only (including locations that passed cycle 1 and cycle 2 analyses), (C) perimeter only in locations that passed cycle 2, (D) perimeter in locations that passed cycle 2 with nonstructural (plus permutations for perimeter locations that passed cycle 1), (E) storm surge barriers with nonstructural and/or perimeter, (F) storm surge barriers with nonstructural and/or perimeter and interior bay closures, and finally (G) storm surge barriers with nonstructural and/or perimeter and a different combination of interior bay closures.

Table 9-15 provides a brief description of each of the 51 alternatives. Individual maps are provided for each of the 51 alternatives in the Economics Appendix C.

Table 9-15: Comprehensive List of 51 Regional Alternatives

REGION	ALTERNATIVES	DESCRIPTION
STUDY WIDE	1A	Nonstructural ONLY
	1B	Perimeter (justified) ONLY
	1C	Storm Surge Barrier ALL INLETS
	1D	Storm Surge Barrier ALL INLETS minus Little Egg Harbor Inlet
SHARK RIVER	2A	Nonstructural ONLY
	2B	Perimeter ONLY
	2C	Storm Surge Barrier ONLY
NORTH REGION	3A	Nonstructural ONLY
	3B	Perimeter ONLY
	3C	Perimeter (Cycle 2) ONLY
	3D	Perimeter (Cycle 2) + Nonstructural
	3E(1)	Storm Surge Barrier ONLY
	3E(2)	Storm Surge Barrier + Nonstructural
	3E(3)	Storm Surge Barrier + Nonstructural + Perimeter
	3F(1)	Storm Surge Barrier + Bay Closure (Holgate)
	3F(2)	Storm Surge Barrier + Bay Closure (Holgate) + Nonstructural
	3G	Storm Surge Barrier + Bay Closure (Point Pleasant Canal)

CENTRAL REGION	4A	Nonstructural ONLY
	4B	Perimeter ONLY
	4C	Perimeter (Cycle 2) ONLY
	4D(1)	Perimeter (Cycle 2) + Nonstructural
	4D(2)	Perimeter (Cycle 1 and 2) + Nonstructural
	4E(1)	Storm Surge Barrier ONLY
	4E(2)	Storm Surge Barrier + Nonstructural
	4E(3)	Storm Surge Barrier + Nonstructural + South Ocean City Perimeter
	4E(4)	Storm Surge Barrier + Nonstructural + South Ocean City Bay Closure
	4F(1)	Storm Surge Barrier + Bay Closure (North Point)
	4F(2)	Storm Surge Barrier + Bay Closure (North Point) + Nonstructural
	4F(3)	Storm Surge Barrier + Bay Closure (North Point) + Nonstructural + South Ocean City Perimeter
	4F(4)	Storm Surge Barrier + Bay Closure (North Point) + Nonstructural + South Ocean City Bay Closure
	4G(1)	Storm Surge Barrier + Bay Closure (Absecon Blvd)
	4G(2)	Storm Surge Barrier + Bay Closure (Absecon Blvd) + Nonstructural
	4G(3)	Storm Surge Barrier + Bay Closure (Absecon Blvd) + Nonstructural + South Ocean City Perimeter
	4G(4)	Storm Surge Barrier + Bay Closure (Absecon Blvd) + Nonstructural + South Ocean City Bay Closure
	4G(5)	Storm Surge Barrier + Bay Closure (Absecon Blvd) + NS Brigantine + South Ocean City No-Action
4G(6)	Storm Surge Barrier + Bay Closure (Absecon Blvd) + NS Brigantine + South Ocean City Nonstructural	
4G(7)	Storm Surge Barrier + Bay Closure (Absecon Blvd) + NS Brigantine + South Ocean City Perimeter	
4G(8)	Storm Surge Barrier + Bay Closure (Absecon Blvd) + NS Brigantine + South Ocean City Bay Closure	
4G(9)	Storm Surge Barrier + Bay Closure (Absecon Blvd) + PM Brigantine + South Ocean City No-Action	
4G(10)	Storm Surge Barrier + Bay Closure (Absecon Blvd) + PM Brigantine + South Ocean City Nonstructural	
4G(11)	Storm Surge Barrier + Bay Closure (Absecon Blvd) + PM Brigantine + South Ocean City Perimeter	
4G(12)	Storm Surge Barrier + Bay Closure (Absecon Blvd) + PM Brigantine + South Ocean City Bay Closure	
SOUTH REGION	5A	Nonstructural ONLY
	5B	Perimeter ONLY
	5C	Perimeter (Cycle 2) ONLY
	5D(1)	Perimeter (Cycle 2) + Nonstructural
	5D(2)	Perimeter (Cycle 1 and 2) + Nonstructural
	5E(1)	Storm Surge Barrier ONLY
	5E(2)	Storm Surge Barrier + Nonstructural
	5F	Storm Surge Barrier + Nonstructural + Bay Closure (Sea Isle Blvd)
		Storm Surge Barrier + Nonstructural + Bay Closure (Sea Isle Blvd, Wildwood Blvd, Stone Harbor Blvd)
	5G	

*NS = Nonstructural, PM = Perimeter Measure

9.5.1 Alternative Screening

After developing the initial array of 51 alternatives across the 5 regional groups in the study area, the PDT began to evaluate alternatives with the goal of narrowing the array down to the alternatives that had the highest benefits. To accomplish this screening, the PDT used a series of criteria to describe the various benefits of the different alternatives, including National Economic Development (NED), Environmental Quality (EQ), and the 4 planning criteria (completeness, efficiency, effectiveness, and acceptability) as outlined in the Principles and Guidelines (ER 1105-2-100) . Each of the criteria used for screening are defined in **Table 9-16** below.

Table 9-16: Alternative Screening Criteria Matrix

Criteria	Definition	Screening Threshold
National Economic Development (NED)	Increases in the net value of the national output of goods and services, expressed in monetary units) through the reduction in wave, erosion and inundation damage.	Average Annual Net Benefits greater than \$0.
Environmental Quality (EQ)	Beneficial effects in the EQ account are favorable changes in the ecological, aesthetic, and cultural attributes of natural and cultural resources. Adverse effects in the EQ account are unfavorable changes in the ecological, aesthetic, and cultural attributes of natural and cultural resources.	Through use of best professional judgment by the PDT and coordination with other state and Federal resource agencies, the PDT analyzed the potential environmental impacts of the alternatives. Alternatives that had environmental impacts with a high certainty of hindering implementation failed the EQ criteria and were removed for further consideration.
Completeness	Completeness is the extent to which a given alternative plan provides and accounts for all necessary investments or other actions to ensure the realization of the planned effects.	Using best professional judgment, the PDT qualitatively assessed each alternative to determine if it met the completeness criteria. Generally, alternatives with higher geographical distribution of risk management and lower residual risk were considered more complete.
Efficiency	Efficiency is the extent to which an alternative plan is the most cost effective means of alleviating the specified problems and realizing the specified opportunities.	Using best professional judgment, the PDT qualitatively assessed each alternative to determine if it met the efficiency criteria. Generally, alternatives with higher Benefit Cost Ratios were considered more efficient because each dollar spent resulted in more benefits accrued.
Effectiveness	Effectiveness is the extent to which an alternative plan alleviates the specified	Using best professional judgment, the PDT qualitatively assessed each alternative to

	problems and achieves the specified opportunities.”	determine if it met the effectiveness criteria. Generally, plans with lower residual risk were considered more effective.
Acceptability	Acceptability is the workability and viability of the alternative plan with respect to compatibility with existing laws, regulations, and public policies.	Using best professional judgment, the PDT qualitatively assessed each alternative to determine if it met the acceptability criteria. Plans that passed the EQ screening were generally considered acceptable at this stage in the planning process. Future acceptability analysis will focus on land use policies and real estate constraints in addition to environmental policies.

9.5.1.1 National Economic Development (NED) Criteria Screening

Table 9-17 provides the economic analysis and screening against the NED criteria for each measure combination. Each Region is presented independently in separate tables with results for Average Annual Net Benefits, Benefit-Cost Ratio, residual damages, and projected annual operations & maintenance⁴. Alternatives met the NED criteria and were considered economically justified if the Average Annual Net Benefits were greater than zero.

Any alternatives shaded in GREEN denotes success of meeting the NED criteria, and inclusion in the Final Array of Alternatives.

Table 9-17: Economic Analysis Results for 51 Regional Alternatives – Study Wide (Baseline)

ITEM	Initial Const.	AAC	AAB	AANB	BCR	Residual	O&M
1A	\$7,075,292,000	\$262,075,000	\$451,666,000	\$189,590,000	1.72	71.26%	\$0
1B	\$5,229,038,000	\$281,177,000	\$738,568,000	\$457,392,000	2.63	53.01%	\$52,290,000
1C	\$21,484,962,000	\$1,332,419,000	\$1,478,075,000	\$145,656,000	1.11	5.95%	\$331,673,000
1D	\$15,457,093,000	\$942,905,000	\$1,219,060,000	\$276,155,000	1.29	22.43%	\$238,606,000

⁴ • **Annual Operations & Maintenance** is the annual cost for operating and maintaining a CSRM measure most notably a storm surge barrier in the NJBB Study.

Each of the study wide single-measure alternatives have positive Average Annual Net Benefits (AANB) and a Benefit Cost Ratio (BCR greater than 1). The nonstructural alternative only plan (1A) and cycle 2 perimeter only plan (1B) have exceedingly high residual damages at 71% and 53%, respectively. Only incorporating nonstructural strategies across the study area, such as in Alternative 1A, does not inhibit vehicle damage, infrastructure damage, emergency costs, or transportation delays. Alternative 2A incorporates physical barriers to reduce the ingress of flood waters and is effective at reducing CSRM damages for the communities within the footprint of perimeter measures, but does not reduce risk to structures outside the footprint of the perimeter measures.

Closing all inlets in the study area with storm surge barriers (Alternative 1C) and closing all inlets except Little Egg Harbor Inlet (Alternative 1D) also have positive AANBs and BCRs.

Due to the reasons presented above, while these plans provide valuable context for the Region-specific evaluations, none are considered acceptable or implementable.

The economic assessment presented below in **Table 9-18** contains both the results for the Shark River Inlet HEC-FDA reaches and the Coastal Lakes HEC-FDA reaches. To reiterate, the Coastal Lakes Region covers only the coastal lakes not already included in either the North or Shark River Regions. The results are aggregated here due to the exceptionally minor influence of either Region on the overall study area.

Both the perimeter (2B) and storm surge barrier (2C) alternatives are economically unviable and were eliminated from further analysis. Only nonstructural (2A) has a positive AANB and meets the NED criteria. **Table 9-19** contains the results for the North Region.

Table 9-18: Shark River and Coastal Lakes Region - NED Screening

ITEM	Initial Const.	AAC	AAB	AANB	BCR	Residual	O&M
2A	\$24,468,000	\$906,000	\$1,133,000	\$227,000	1.25	88.47%	\$0
2B	\$512,216,000	\$25,747,000	\$3,771,000	-\$21,976,000	0.15	61.63%	\$5,122,000
2C	\$591,347,000	\$33,439,000	\$6,149,000	-\$27,289,000	0.18	37.44%	\$9,125,000

Table 9-19: North Region - NED Screening

ITEM	Initial Const.	AAC	AAB	AANB	BCR	Residual	O&M
3A	\$3,629,095,000	\$134,425,000	\$203,011,000	\$68,586,000	1.51	62.97%	\$0
3B	\$6,726,209,000	\$437,164,000	\$276,635,000	-\$160,529,000	0.63	49.54%	\$67,262,000
3C	\$461,554,000	\$22,731,000	\$26,258,000	\$3,528,000	1.16	95.21%	\$4,616,000
3D	\$3,898,614,000	\$150,042,000	\$214,874,000	\$64,831,000	1.43	60.81%	\$4,616,000
3E(1)	\$2,549,342,000	\$154,810,000	\$308,828,000	\$154,018,000	1.99	43.67%	\$39,351,000
3E(2)	\$3,837,663,000	\$202,530,000	\$362,691,000	\$160,160,000	1.79	33.84%	\$39,351,000
3E(3)	\$4,838,353,000	\$268,041,000	\$399,903,000	\$131,861,000	1.49	27.06%	\$53,997,000
3F(1)	\$5,924,539,000	\$367,186,000	\$434,515,000	\$67,329,000	1.18	20.74%	\$90,894,000
3F(2)	\$6,354,659,000	\$383,118,000	\$455,972,000	\$72,854,000	1.19	16.83%	\$90,894,000
3G	\$1,151,448,000	\$67,465,000	\$42,502,000	-\$24,963,000	0.63	92.25%	\$17,766,000

As shown in **Table 9-20**, Alternative 4A, which only employs the nonstructural strategy meets the NED criteria, but has high residual damages (79%). Alternatives 4B and 4C (perimeter only) meet the NED criteria, but both are improved by Alternatives 4D(1) and 4D(2). Alternative 4D(1) adds

nonstructural and maximizes AANB while Alternative 4D(2) adds nonstructural and a perimeter measure to Brigantine Island. Alternative 4D(2) reduces residual damages with only a 2.6% decrease in AANB.

Alternative 4E(1) meets the NED criteria, yet is improved with the inclusion of other measure types in 4E(2), 4E(3), 4E(4).

The inclusion of the North Point interior bay closure in Alternative 4F severely dropped AANB in comparison with other storm surge barrier alternative. Alternative 4F increased AAB by 14.5%, but required a 46.3% increase in AAC.

Alternative 4G(1) meets the NED criteria, but is improved by adding either nonstructural or perimeter measures to Brigantine Island and nonstructural, perimeter, or interior bay closure measures to South Ocean City (Alternatives 4G(6) – 4G(8) and 4G(10) – 4G(12)).

At the current level of analysis, any of Alternatives 4D(1), 4D(2), 4G(7), or 4G(12) could be considered the maximizing NED alternative.

Table 9-20: Central Region - NED Screening

ITEM	Initial Const.	AAC	AAB	AANB	BCR	Residual	O&M
4A	\$1,954,627,000	\$72,401,000	\$148,963,000	\$76,562,000	2.06	78.81%	\$0
4B	\$3,619,705,000	\$201,070,000	\$562,047,000	\$360,976,000	2.80	20.04%	\$36,197,000
4C	\$2,904,784,000	\$164,102,000	\$530,764,000	\$366,662,000	3.23	24.49%	\$29,048,000
4D(1)	\$3,336,914,000	\$180,109,000	\$557,779,000	\$377,671,000	3.10	20.65%	\$29,048,000
4D(2)	\$3,822,130,000	\$208,568,000	\$576,257,000	\$367,689,000	2.76	18.02%	\$36,197,000
4E(1)	\$6,734,047,000	\$425,665,000	\$570,170,000	\$144,506,000	1.34	18.89%	\$103,964,000
4E(2)	\$7,140,707,000	\$425,665,000	\$585,964,000	\$160,299,000	1.38	16.64%	\$103,964,000
4E(3)	\$7,169,796,000	\$446,873,000	\$592,968,000	\$146,094,000	1.33	15.64%	\$107,923,000
4E(4)	\$7,173,761,000	\$449,940,000	\$595,793,000	\$145,853,000	1.32	15.24%	\$110,198,000
4F(1)	\$9,831,254,000	\$622,785,000	\$652,920,000	\$30,135,000	1.05	7.12%	\$151,395,000
4F(2)	\$10,219,820,000	\$637,178,000	\$669,220,000	\$32,041,000	1.05	4.80%	\$151,395,000
4F(3)	\$10,248,909,000	\$643,324,000	\$677,241,000	\$33,918,000	1.05	3.66%	\$155,354,000
4F(4)	\$10,252,874,000	\$646,390,000	\$680,097,000	\$33,706,000	1.05	3.25%	\$157,629,000
4G(1)	\$4,884,211,000	\$301,347,000	\$594,284,000	\$292,937,000	1.97	15.46%	\$74,556,000
4G(2)	\$5,272,777,000	\$315,740,000	\$610,169,000	\$294,429,000	1.93	13.20%	\$74,556,000
4G(3)	\$5,301,866,000	\$321,885,000	\$617,831,000	\$295,946,000	1.92	12.11%	\$78,516,000
4G(4)	\$5,305,831,000	\$324,952,000	\$620,672,000	\$295,720,000	1.91	11.70%	\$80,790,000
4G(5)	\$5,132,009,000	\$310,526,000	\$611,147,000	\$300,622,000	1.97	13.06%	\$74,556,000
4G(6)	\$5,520,576,000	\$324,918,000	\$627,032,000	\$302,114,000	1.93	10.80%	\$74,556,000
4G(7)	\$5,549,665,000	\$331,064,000	\$634,694,000	\$303,630,000	1.92	9.71%	\$78,516,000
4G(8)	\$5,553,629,000	\$334,130,000	\$637,535,000	\$303,405,000	1.91	9.30%	\$80,790,000
4G(9)	\$5,617,225,000	\$338,985,000	\$634,873,000	\$295,888,000	1.87	9.68%	\$81,706,000
4G(10)	\$6,005,792,000	\$353,378,000	\$650,758,000	\$297,380,000	1.84	7.42%	\$81,706,000
4G(11)	\$6,034,880,000	\$359,524,000	\$658,420,000	\$298,897,000	1.83	6.33%	\$85,665,000
4G(12)	\$6,038,845,000	\$362,590,000	\$661,261,000	\$298,671,000	1.82	5.93%	\$87,939,000

As shown in **Table 9-21**, the nonstructural only alternative (5A) meets the NED criteria though with 68% residual damages. Alternatives 5B and 5C (perimeter only) also meet the NED criteria, but both are improved by Alternatives 5D(1) and 5D(2). Alternative 5D(1) adds nonstructural and maximizes AANB while Alternative 5D(2) adds nonstructural and a perimeter measure to Seven Mile Island.

Alternatives 5E(1) and 5E(2) meet the NED criteria, but with significantly fewer AANB than other alternatives. Adding the Sea Isle Blvd Interior Bay Closure (5F) drops residual damages, but fails to meet the NED criteria. Avoiding an inlet closure at Hereford Inlet with the inclusion of two interior bay closures (5G) also fails to meet the NED criteria.

At the current level of analysis, Alternatives 5D(1) or 5D(2) could be considered the maximizing NED alternative.

Table 9-21: South Region - NED Screening

ITEM	Initial Const.	AAC	AAB	AANB	BCR	Residual	O&M
5A	\$1,467,103,000	\$54,343,000	\$98,558,000	\$44,216,000	1.81	68.27%	\$0
5B	\$3,424,391,000	\$181,379,000	\$231,893,000	\$50,514,000	1.28	25.35%	\$34,244,000
5C	\$1,862,700,000	\$94,344,000	\$181,546,000	\$87,202,000	1.92	41.55%	\$18,627,000
5D(1)	\$2,286,822,000	\$110,054,000	\$206,462,000	\$96,408,000	1.88	33.53%	\$18,627,000
5D(2)	\$3,428,552,000	\$180,266,000	\$237,575,000	\$57,310,000	1.32	23.52%	\$33,066,000
5E(1)	\$4,639,279,000	\$274,620,000	\$290,854,000	\$16,233,000	1.06	6.37%	\$71,610,000
5E(2)	\$4,680,566,000	\$276,150,000	\$292,784,000	\$16,634,000	1.06	5.74%	\$71,610,000
5F	\$5,265,569,000	\$308,994,000	\$298,195,000	-\$10,799,000	0.97	4.00%	\$80,302,000
5G	\$5,924,476,000	\$344,010,000	\$293,924,000	-\$50,086,000	0.85	5.38%	\$89,110,000

9.5.1.2 Environmental Quality (EQ) Criteria Screening

Alternatives that met the NED screening criteria were carried forward to be screened against the Environmental Quality (EQ) criteria. The potential environmental impacts of the various alternatives were assessed qualitatively using the best professional judgment of the PDT and through coordination with state and Federal resource agencies. Potential impacts of the implementation of alternatives to water quality, estuary circulation, sedimentation and scour, air quality, endangered species, fisheries, aquatic life, wetland habitat, aquatic habitat, and upland terrestrial habitat were considered and scored using a ranked ordinal scale to describe the magnitude of the impacts and risk related to their implementation. The EQ scores for different habitats and resources were averaged to calculate an EQ Index Score (**Table 9-22**). If any alternative received a score of 0 for any habitat or natural resource impact, the alternative failed the EQ criteria.

Table 9-22: EQ Index Score

Score	Description	Risk Category
0	EXTREME RISK. Environmental Impacts are severe making alternative non-implementable and/or is not likely to receive statutory approvals for compliance. A score of zero on any criteria negates entire alternative.	HIGH
1	VERY HIGH RISK. Environmental Impacts are significant with either the magnitude, duration of impact, and/or a very high vulnerability of resources. Alternative would have very high level of controversy. Statutory approvals would require extensive reviews that are likely to impact schedule and budget. Alternative would require very high compensatory mitigation and associated costs likely to adversely affect project costs.	
2	HIGH RISK. Environmental Impacts are substantial to moderate with either the magnitude, duration of impact, and/or a high vulnerability of resources. Alternative would have a higher level of controversy. Statutory approvals would require extensive reviews that are likely to impact schedule and budget. Alternative would require high compensatory mitigation and associated costs likely to have an adverse effect on project costs.	
3	MODERATE RISK. Environmental Impacts are moderate with either the magnitude, duration of impact, and/or a moderate vulnerability of resources. Alternative would have a moderate level of controversy. Statutory approvals could require additional reviews that could impact schedule and budget. Alternative would require compensatory mitigation and associated costs could impact project costs.	MEDIUM
4	MINOR RISK. Environmental Impacts are minor with either the magnitude, duration of impact, and/or a minor vulnerability of resources. Alternative would have little or no level of controversy. Statutory approvals are routine, but could require additional reviews that could impact schedule and budget based on complexity. Alternative would require some compensatory mitigation and associated costs would likely have little impact to project costs.	
5	LOW RISK. Environmental Impacts are neutral with either the magnitude, duration of impact, and/or no vulnerability of resources. Alternative would have little or no level of controversy. Statutory approvals are routine. Alternative would require no compensatory mitigation.	LOW
6	VERY LOW RISK. Environmental impacts are beneficial and provide a net ecological uplift. Alternative would have very little or no level of controversy. Statutory approvals would be routine. No compensatory mitigation required.	

At this stage in the analysis, the indirect impacts to environmental resources from storm surge barriers have not been modeled. Therefore, there is a high degree of uncertainty around the impacts of those measures. Similar to the planning process, the EQ screening of alternatives will be an iterative process that will be refined as more data and model results are available. Alternatives that passed this iteration of EQ screening may not pass future iterations of screening as the PDT’s understanding of impacts improves. **Table 9-23** provides the preliminary analysis and screening against the EQ criteria. Each Region is presented independently with a pass or fail designation for the EQ criteria. Alternatives that successfully met the EQ screening are shaded GREEN, and are included from the final array of alternatives.

STUDY WIDE – EQ Screening

Alternatives 1C and 1D both failed to meet the EQ criteria and were eliminated from further consideration. Alternative 1C included storm surge barriers at every inlet in the study area, and 1D included storm surge barriers at every inlet in the study area, except for Little Egg Harbor Inlet. Endangered species impact and wildlife habitat impacts at Little Egg Inlet, Corson Inlet, and Hereford Inlet drove the decision to eliminate these alternatives. A storm surge barrier at Little Egg Harbor Inlet would impact at least 10 miles of critical habitat for the endangered Piping Plover within the Edwin B. Forsythe National Wildlife Refuge. Little Egg Inlet also provides uniquely undisturbed habitat to a wide range of wildlife because is also the only unmodified inlet between Montauk, New York and Gargathy Inlet, Virginia. Corson Inlet is an inlet with significant beach nesting bird habitat and contains a State Natural Area at Strathmere. The area of Hereford Inlet is within a CBRA zone and a Federal coastal storm risk project in the area would not comply with CBRA. A storm surge barrier at Hereford Inlet would result in significant impacts to critical habitat for Piping Plover at Stone Harbor Point.

Table 9-23: EQ Screening for Individual Regions

Alternative	EQ Index Score	EQ Pass/Fail
1A	4.2	Pass
1B	3.3	Pass
1C	1.6	Fail
1D	2.1	Fail

SHARK RIVER AND COASTAL LAKES REGION – EQ Screening

Alternative 2A employs the nonstructural strategy in the Shark River Region and passed the EQ screening analysis. It is the only alternative remaining under consideration for inclusion in the preliminary focused array of alternative plans. Building retrofit is the least impactful measure under consideration environmentally.

Alternative	EQ Index Score	EQ Pass/Fail
2A	4.2	Pass

NORTH REGION – EQ Screening

In the North Region of the study area, Alternative 3F(1) and 3F(2) did not pass the EQ criteria. Impacts resulting from the Holgate interior bay closure were the primary drivers behind the failure of these alternatives. The Holgate interior bay closure would negatively impact piping plover habitat in addition to high wetland and aquatic habitat impacts within the Edwin B. Forsythe National Wildlife Refuge.

Alternative	EQ Index Score	EQ Pass/Fail
3A	4.2	Pass
3C	3.3	Pass
3D	3.3	Pass
3E(1)	2.1	Pass
3E(2)	2.1	Pass
3E(3)	2.0	Pass
3F(1)	1.2	Fail
3F(2)	1.2	Fail

CENTRAL REGION – EQ Screening

In the Central Region of the study area, Alternative 4F(1) through 4F(4) did not pass the EQ criteria. Impacts resulting from the North Point interior bay closure were the primary drivers behind the failure of these alternatives. The North Point interior bay closure includes the construction of a seawall along the beach in a sensitive piping plover habitat within a State Natural Area and would pass through environmentally sensitive wetland habitat within the Edwin B. Forsythe National Wildlife Refuge.

Alternative	EQ Index Score	EQ Pass/Fail
4A	4.2	Pass
4B	3.3	Pass
4C	3.3	Pass
4D(1)	3.3	Pass
4D(2)	3.3	Pass
4E(1)	2.1	Pass
4E(2)	2.1	Pass
4E(3)	2.1	Pass
4E(4)	2.0	Pass
4F(1)	2.0	Fail
4F(2)	2.0	Fail
4F(3)	2.0	Fail
4F(4)	1.9	Fail
4G(1)	2.0	Pass
4G(2)	2.0	Pass
4G(3)	2.0	Pass
4G(4)	2.0	Pass
4G(5)	2.0	Pass
4G(6)	2.0	Pass
4G(7)	2.0	Pass
4G(8)	2.0	Pass
4G(9)	2.0	Pass
4G(10)	2.0	Pass
4G(11)	2.0	Pass
4G(12)	2.0	Pass

SOUTH REGION – EQ Screening

In the South Region of the study area, Alternative 5E(1) and 5E(2) did not pass the EQ criteria. Impacts resulting from the Hereford Inlet storm surge barrier were the primary drivers behind the failure of these alternatives. Hereford Inlet is within a Coastal Barrier Resources Act (CBRA) zone and a Federal coastal storm risk project in the area would not comply with CBRA. A storm surge barrier at Hereford Inlet would result in significant impacts to critical habitat for Piping Plover at Stone Harbor Point

Alternative	EQ Index Score	EQ Pass/Fail
5A	4.2	Pass
5B	3.3	Pass
5C	3.3	Pass
5D(1)	3.3	Pass
5D(2)	3.3	Pass
5E(1)	2.0	Fail
5E(2)	2.0	Fail

9.5.1.3 Planning Criteria Screening Analyses

After alternatives were screened using the NED and EQ criteria, the PDT qualitatively assessed and screened the remaining alternatives against the four planning criteria. Reference ER 1105-2-100, Section 2-3, c (2), states, "As a general rule projects must be formulated to reasonably maximize benefits to the national economy, to the environment or to the sum of both. Each alternative plan shall be formulated in consideration of four criteria described in the Principles and Guidelines (ER 1105-2-100) (1983): completeness, efficiency, effectiveness, and acceptability."

Table 9-24 provides the analysis and screening against the four planning criteria. Each alternative is presented independently with a pass or fail designation for the planning criteria. Alternatives that successfully met the planning criteria screening are shaded GREEN, and are included in the preliminary focused array of alternative plans.

Table 9-24: Four Planning Criteria Screening

Alternative	Completeness	Efficiency	Effectiveness	Acceptability	Planning Criteria Pass/Fail
SHARK RIVER AND COASTAL LAKES REGION					
2A	Plan has high residual risk (71%)	BCR > 1	Elevating structures will reduce damages to buildings, but does not reduce risk to other infrastructure	There is risk due to uncertainty of implementing building retrofit due to remaining questions about compliance with state and local laws.	Pass
NORTH REGION					
3A	Plan has high residual risk (71%)	BCR > 1	Elevating structures will reduce damages to buildings, but does not reduce risk to other infrastructure	There is risk due to uncertainty of implementing building retrofit due to remaining questions about compliance with state and local laws.	Pass
3C	Fail – Residual Risk is too high (95%) to be considered implementable	BCR > 1	CSRM is provided only behind the Manasquan North floodwall, where the floodwall will manage risk for both high and low frequency events	There is risk that the project may not be implementable due to environmental laws. This risk is based in the very high uncertainty whether the high direct impacts of a floodwall would be acceptable to resource agencies.	Fail
3D	High residual risk (61%). Provides CSRM to both mainland and barrier islands	BCR > 1	Elevating structures will reduce damages to buildings, but do not reduce risk to other infrastructure on the mainland. Behind the Manasquan North floodwall, the floodwall will manage risk for both high and low frequency events	There is risk that the project may not be implementable due to environmental laws. This risk is based in the very high uncertainty whether the high direct impacts of a floodwall would be acceptable to resource agencies. There is also risk due to uncertainty of implementing nonstructural measures due to remaining questions about compliance with state and local laws.	Pass
3E(1)	Provides CSRM benefits to both barrier islands and mainland communities, but only during low frequency events.	BCR >2	Storm surge barriers will reduce coastal storm risk during low frequency events, but will not reduce risk from more frequent storm events.	There is risk that the project may not be implementable due to environmental laws. This risk is based in the very high uncertainty of indirect impacts to water quality and circulation from Storm Surge Barriers.	Pass
3E(2)	Provides CSRM benefits to both barrier islands and mainland communities, but only during low frequency events. Structure elevation will provide CSRM to more vulnerable structures.	BCR >1	Storm surge barriers will reduce coastal storm risk during low frequency events, but will not reduce risk from more frequent storm events. Elevating structures will reduce damages to buildings, but do not reduce risk to other infrastructure	There is risk that the project may not be implementable due to environmental laws. This risk is based in the very high uncertainty of indirect impacts to water quality and circulation from Storm Surge Barriers. There is risk due to uncertainty of implementability due to remaining questions about compliance with state and local laws.	Pass
3E(3)	Lowest residual risk plan in this region. Provides CSRM to both mainland and barrier islands.	BCR > 2	Storm surge barriers will reduce coastal storm risk during low frequency events, but will not reduce risk from more frequent storm events. Elevating structures will reduce damages to buildings, but do not reduce risk to other infrastructure on the mainland. In southern LBI, the floodwall will manage risk for both high and low frequency events	There is risk that the project may not be implementable due to environmental laws. This risk is based in the very high uncertainty of indirect impacts to water quality and circulation from Storm Surge Barriers and high uncertainty whether the high direct impacts of a floodwall would be acceptable to resource agencies. There is also risk due to uncertainty of implementing nonstructural measures due to remaining questions about compliance with state and local laws.	Pass
CENTRAL REGION					
4A	High residual risk (79%). Provides CSRM to both mainland and barrier islands	BCR >1	Elevating structures will reduce damages to buildings, but do not reduce risk to other infrastructure	There is risk due to uncertainty of implementability of nonstructural measures due to remaining questions about compliance with state and local laws.	Pass
4B	Fail - No CSRM is provided to communities on the mainland or Brigantine	BCR >2	Floodwalls around barrier island communities (except Brigantine) will reduce coastal storm risk.	There is risk that the project may not be implementable due to environmental laws. This risk is based in the very high uncertainty whether the high direct impacts of a floodwall would be acceptable to resource agencies.	Fail
4C	Fail - No CSRM is provided to communities on the mainland	BCR >2	Floodwalls around barrier island communities will reduce coastal storm risk.	There is risk that the project may not be implementable due to environmental laws. This risk is based in the very high uncertainty whether the high direct impacts of a floodwall would be acceptable to resource agencies.	Fail
4D(1)	Provides CSRM benefits to both barrier islands (Except Brigantine) and mainland communities. Elevating structures does not reduce risk to other critical infrastructure. Plan has low residual risk.	BCR >2	Elevating structures will reduce damages to buildings, but do not reduce risk to other infrastructure on the mainland. In Ocean City and Absecon Island, the floodwalls will manage risk for both high and low frequency events.	There is risk that the project may not be implementable due to environmental laws. This risk is based in the very high uncertainty whether the high direct impacts of a floodwall would be acceptable to resource agencies. There is also risk due to uncertainty of implementing nonstructural measures due to remaining questions about compliance with state and local laws	Pass

Alternative	Completeness	Efficiency	Effectiveness	Acceptability	Planning Criteria Pass/Fail
4D(2)	Provides CSRM benefits to both barrier islands and mainland communities. Elevating structures does not reduce risk to other critical infrastructure. Plan has low residual risk.	BCR > 2	Elevating structures will reduce damages to buildings, but do not reduce risk to other infrastructure on the mainland. In Ocean City, Absecon Island, and Brigantine, the floodwalls will manage risk for both high and low frequency events.	There is risk that the project may not be implementable due to environmental laws. This risk is based in the very high uncertainty whether the high direct impacts of a floodwall would be acceptable to resource agencies. There is also risk due to uncertainty of implementing nonstructural measures due to remaining questions about compliance with state and local laws.	Pass
4E(1)	Fail - Provides CSRM benefits to both barrier islands and mainland communities, but only during low frequency events. Also, provides no CSRM to the area to the north of Corson Inlet.	BCR > 1	Storm surge barriers will reduce coastal storm risk during low frequency events, but will not reduce risk from more frequent storm events.	There is risk that the project may not be implementable due to environmental laws. This risk is based in the very high uncertainty of indirect impacts to water quality and circulation from Storm Surge Barriers.	Fail
4E(2)	Provides CSRM benefits to both barrier islands and mainland communities, but only during low frequency events.	BCR > 1	Storm surge barriers will reduce coastal storm risk during low frequency events, but will not reduce risk from more frequent storm events. Elevating structures north of Corson Inlet and in the vicinity of Absecon, will reduce damages to buildings, but do not reduce risk to other infrastructure	There is risk that the project may not be implementable due to environmental laws. This risk is based in the very high uncertainty of indirect impacts to water quality and circulation from Storm Surge Barriers. There is also risk due to uncertainty of implementing nonstructural measures due to remaining questions about compliance with state and local laws.	Pass
4E(3)	Provides CSRM benefits to both barrier islands and mainland communities, but only during low frequency events. The floodwall in Ocean City will provide CSRM during high frequency events. Nonstructural measures will manage risk to structures, but not other infrastructure.	BCR > 1	Storm surge barriers will reduce coastal storm risk during low frequency events, but will not reduce risk from more frequent storm events. Elevating structures north of Corson Inlet and in the vicinity of Absecon, will reduce damages to buildings, but do not reduce risk to other infrastructure. The floodwall in southern Ocean City will manage risk from high and low frequency events.	There is risk that the project may not be implementable due to environmental laws. This risk is based in the very high uncertainty of indirect impacts to water quality and circulation from Storm Surge Barriers and very high uncertainty whether the high direct impacts of a floodwall would be acceptable to resource agencies. There is also risk due to uncertainty of implementing nonstructural measures due to remaining questions about compliance with state and local laws.	Pass
4E(4)	Storm surge barriers will reduce coastal storm risk during low frequency events, but will not reduce risk from more frequent storm events. Elevating structures north of Corson Inlet and in the vicinity of Absecon, will reduce damages to buildings, but do not reduce risk to other infrastructure	BCR > 1	Provides CSRM benefits to both barrier islands and mainland communities, but only during low frequency events.	There is risk that the project may not be implementable due to environmental laws. This risk is based in the very high uncertainty of indirect impacts to water quality and circulation from Storm Surge Barriers. There is also risk due to uncertainty of implementing nonstructural measures due to remaining questions about compliance with state and local laws.	Pass
4G(1)	Fail - No CSRM is provided to communities north of the Absecon Blvd Bay closure and the communities directly north of Corson Inlet	BCR > 2	Storm surge barriers and bay closures will reduce coastal storm risk during low frequency events, but will not reduce risk from more frequent storm events.	There is risk that the project may not be implementable due to environmental laws. This risk is based in the very high uncertainty of indirect impacts to water quality and circulation from Storm Surge Barriers and Bay Closures. There is also risk due to uncertainty of implementing nonstructural measures due to remaining questions about compliance with state and local laws.	Fail
4G(2)	Fail - No CSRM is provided to communities north of the Absecon Blvd Bay closure	BCR > 1	Storm surge barriers and bay closures will reduce coastal storm risk during low frequency events, but will not reduce risk from more frequent storm events. Elevating structures north of Corson Inlet, will reduce damages to buildings, but do not reduce risk to other infrastructure	There is risk that the project may not be implementable due to environmental laws. This risk is based in the very high uncertainty of indirect impacts to water quality and circulation from Storm Surge Barriers and Bay Closures. There is also risk due to uncertainty of implementing nonstructural measures due to remaining questions about compliance with state and local laws.	Fail
4G(3)	Fail - No CSRM is provided to communities north of the Absecon Blvd Bay closure	BCR > 1	Storm surge barriers and bay closures will reduce coastal storm risk during low frequency events, but will not reduce risk from more frequent storm events. Elevating structures north of Corson Inlet, will reduce damages to buildings, but do not reduce risk to other infrastructure. The floodwall in southern Ocean City will manage risk from high and low frequency events.	There is risk that the project may not be implementable due to environmental laws. This risk is based in the very high uncertainty of indirect impacts to water quality and circulation from Storm Surge Barriers and Bay Closures and very high uncertainty whether the high direct impacts of a floodwall would be acceptable to resource agencies. There is also risk due to uncertainty of implementing nonstructural measures due to remaining questions about compliance with state and local laws.	Fail
4G(4)	Fail - No CSRM is provided to communities north of the Absecon Blvd Bay closure and the communities directly north of Corson Inlet	BCR > 2	Storm surge barriers and bay closures will reduce coastal storm risk during low frequency events, but will not reduce risk from more frequent storm events.	There is risk that the project may not be implementable due to environmental laws. This risk is based in the very high uncertainty of indirect impacts to water quality and circulation from Storm Surge Barriers and Bay Closures.	Fail

Alternative	Completeness	Efficiency	Effectiveness	Acceptability	Planning Criteria Pass/Fail
4G(5)	Provides CSRM benefits to both barrier islands and mainland communities. Elevating structures does not reduce risk to other critical infrastructure. Very low residual risk.	BCR > 2	Storm surge barriers and bay closures will reduce coastal storm risk during low frequency events, but will not reduce risk from more frequent storm events. Nonstructural measures such as building elevation north of the Absecon Blvd Bay closure will manage risk to structures, but not other critical infrastructure.	There is risk that the project may not be implementable due to environmental laws. This risk is based in the very high uncertainty of indirect impacts to water quality and circulation from Storm Surge Barriers and Bay Closures. There is also risk due to uncertainty of implementing nonstructural measures due to remaining questions about compliance with state and local laws.	Pass
4G(6)	Provides CSRM benefits to both barrier islands and mainland communities. Elevating structures does not reduce risk to other critical infrastructure. Very low residual risk.	BCR > 1	Storm surge barriers and bay closures will reduce coastal storm risk during low frequency events, but will not reduce risk from more frequent storm events. Nonstructural measures such as building elevation north of the Absecon Blvd Bay closure will manage risk to structures, but not other critical infrastructure.	There is risk that the project may not be implementable due to environmental laws. This risk is based in the very high uncertainty of indirect impacts to water quality and circulation from Storm Surge Barriers and Bay Closures. There is also risk due to uncertainty of implementing nonstructural measures due to remaining questions about compliance with state and local laws.	Pass
4G(7)	Provides CSRM benefits to both barrier islands and mainland communities. Elevating structures does not reduce risk to other critical infrastructure. Very low residual risk.	BCR > 1	Storm surge barriers and bay closures will reduce coastal storm risk during low frequency events, but will not reduce risk from more frequent storm events. Nonstructural measures such as building elevation north of the Absecon Blvd Bay closure will manage risk to structures, but not other critical infrastructure. The floodwall along southern Ocean City will manage risk from both high and low frequency events.	There is risk that the project may not be implementable due to environmental laws. This risk is based in the very high uncertainty of indirect impacts to water quality and circulation from Storm Surge Barriers and Bay Closures and very high uncertainty whether the high direct impacts of a floodwall would be acceptable to resource agencies. There is also risk due to uncertainty of implementing nonstructural measures due to remaining questions about compliance with state and local laws.	Pass
4G(8)	Provides CSRM benefits to both barrier islands and mainland communities. Elevating structures does not reduce risk to other critical infrastructure. Very low residual risk.	BCR > 2	Storm surge barriers and bay closures will reduce coastal storm risk during low frequency events, but will not reduce risk from more frequent storm events. Nonstructural measures such as building elevation north of the Absecon Blvd Bay closure will manage risk to structures, but not other critical infrastructure.	There is risk that the project may not be implementable due to environmental laws. This risk is based in the very high uncertainty of indirect impacts to water quality and circulation from Storm Surge Barriers and Bay Closures. There is also risk due to uncertainty of implementing nonstructural measures due to remaining questions about compliance with state and local laws.	Pass
4G(9)	Provides CSRM benefits to both barrier islands and mainland communities. Elevating structures does not reduce risk to other critical infrastructure. Very low residual risk.	BCR > 1	Storm surge barriers and bay closures will reduce coastal storm risk during low frequency events, but will not reduce risk from more frequent storm events. Nonstructural measures such as building elevation north of the Absecon Blvd Bay closure will manage risk to structures, but not other critical infrastructure. The floodwall along Brigantine will manage risk from both high and low frequency events.	There is risk that the project may not be implementable due to environmental laws. This risk is based in the very high uncertainty of indirect impacts to water quality and circulation from Storm Surge Barriers and Bay Closures and very high uncertainty whether the high direct impacts of a floodwall would be acceptable to resource agencies. There is also risk due to uncertainty of implementing nonstructural measures due to remaining questions about compliance with state and local laws.	Pass
4G(10)	Provides CSRM benefits to both barrier islands and mainland communities. Elevating structures does not reduce risk to other critical infrastructure. Very low residual risk.	BCR > 1	Storm surge barriers and bay closures will reduce coastal storm risk during low frequency events, but will not reduce risk from more frequent storm events. Nonstructural measures such as building elevation north of the Absecon Blvd Bay and north of Corson Inlet closure will manage risk to structures, but not other critical infrastructure. The floodwall along Brigantine will manage risk from both high and low frequency events.	There is risk that the project may not be implementable due to environmental laws. This risk is based in the very high uncertainty of indirect impacts to water quality and circulation from Storm Surge Barriers and Bay Closures and very high uncertainty whether the high direct impacts of a floodwall would be acceptable to resource agencies. There is also risk due to uncertainty of implementing nonstructural measures due to remaining questions about compliance with state and local laws.	Pass
4G(11)	Provides CSRM benefits to both barrier islands and mainland communities. Elevating structures does not reduce risk to other critical infrastructure. Lowest residual risk plan in this region.	BCR > 1	Storm surge barriers and bay closures will reduce coastal storm risk during low frequency events, but will not reduce risk from more frequent storm events. Nonstructural measures such as building elevation north of the Absecon Blvd Bay and north of Corson Inlet closure will manage risk to structures, but not other critical infrastructure. The floodwall along Brigantine and around southern Ocean City will manage risk from both high and low frequency events.	There is risk that the project may not be implementable due to environmental laws. This risk is based in the very high uncertainty of indirect impacts to water quality and circulation from Storm Surge Barriers and Bay Closures and very high uncertainty whether the high direct impacts of a floodwall would be acceptable to resource agencies. There is also risk due to uncertainty of implementing nonstructural measures due to remaining questions about compliance with state and local laws.	Pass
4G(12)	Provides CSRM benefits to both barrier islands and mainland communities. Elevating structures does not reduce risk to other critical infrastructure. Lowest residual risk plan in this region.	BCR > 1	Storm surge barriers and bay closures will reduce coastal storm risk during low frequency events, but will not reduce risk from more frequent storm events. Nonstructural measures such as building elevation north of the Absecon Blvd Bay and north of Corson Inlet closure will manage risk to structures, but not other critical infrastructure. The floodwall along Brigantine will manage risk from both high and low frequency events.	There is risk that the project may not be implementable due to environmental laws. This risk is based in the very high uncertainty of indirect impacts to water quality and circulation from Storm Surge Barriers and Bay Closures and very high uncertainty whether the high direct impacts of a floodwall would be acceptable to resource agencies. There is also risk due to uncertainty of implementing nonstructural measures due to remaining questions about compliance with state and local laws.	Pass
SOUTH REGION					

Alternative	Completeness	Efficiency	Effectiveness	Acceptability	Planning Criteria Pass/Fail
5A	High residual risk (71%). Provides CSRSM to both mainland and barrier islands	BCR > 2	Elevating structures will reduce damages to buildings, but do not reduce risk to other infrastructure	There is risk due to uncertainty of implementability of nonstructural measures due to remaining questions about compliance with state and local laws.	Pass
5B	Fail: No CSRSM is provided to communities on the mainland	BCR > 1	Floodwalls around barrier island communities will reduce coastal storm risk.	There is risk that the project may not be implementable due to environmental laws. This risk is based in the very high uncertainty whether the high direct impacts of a floodwall would be acceptable to resource agencies.	Fail
5C	Fail: No CSRSM is provided to communities on the mainland, Strathmere or 7 Mile Island	BCR > 1	Floodwalls around Cape May City, the Wildwoods, and Sea Isle City will manage risk from coastal storms.	There is risk that the project may not be implementable due to environmental laws. This risk is based in the very high uncertainty whether the high direct impacts of a floodwall would be acceptable to resource agencies.	Fail
5D(1)	Provides CSRSM benefits to both barrier islands and mainland communities. Elevating structures does not reduce risk to other critical infrastructure.	BCR > 1	Elevating structures will reduce damages to buildings, but do not reduce risk to other infrastructure on the mainland. In Cape May City, Wildwood Island and Sea Isle City, the floodwalls will manage risk for both high and low frequency events.	There is risk that the project may not be implementable due to environmental laws. This risk is based in the very high uncertainty whether the high direct impacts of a floodwall would be acceptable to resource agencies. There is also risk due to uncertainty of implementing nonstructural measures due to remaining questions about compliance with state and local laws.	Pass
5D(2)	Provides CSRSM benefits to both barrier islands and mainland communities. Elevating structures does not reduce risk to other critical infrastructure on the mainland. This plan has the lowest residual risk (25%) in the region.	BCR > 1	Elevating structures will reduce damages to buildings, but do not reduce risk to other infrastructure on the mainland. In Cape May City, Wildwood Island, Seven Mile Island, and Sea Isle City, the floodwalls will manage risk for both high and low frequency events.	There is risk that the project may not be implementable due to environmental laws. This risk is based in the very high uncertainty whether the high direct impacts of a floodwall would be acceptable to resource agencies. There is also risk due to uncertainty of implementing nonstructural measures due to remaining questions about compliance with state and local laws.	Pass

9.5.2 Other Social Effects Analysis

The other Social Effects (OSE) account is a means of displaying and integrating into water resource planning information from perspectives that are not reflected in the other accounts. The categories of effects in the OSE account include the following: Urban and community impacts; life, health, and safety factors; displacement; long-term productivity; and energy requirements and energy conservation. At this stage in the study, the OSE account is not being used as an alternative screening tool, but it does provide context on social and infrastructure vulnerability that the PDT will continue to consider throughout the planning process as it progresses.

An OSE qualitative analysis was performed on alternatives that met the NED, EQ, and four planning criteria to ensure that any decisions based on economics and engineering would also consider life/safety, critical infrastructure, and disproportionate negative impacts to socially vulnerable populations. At this stage of the analysis, the information used included the NACCS Social Vulnerability Exposure and Risk Indices, NACCS geodatabases of critical infrastructure, and mapped emergency evacuation routes. The NACCS defines exposure as the presence of people, infrastructure, and/or environmental resources in areas subject to coastal flooding. The NACCS Social Vulnerability Exposure Index was created by compiling data from the U.S. 2010 Census and 2011 American Community Survey on age, income, and other characteristics. Key variables that defined social vulnerability exposure include: percentage of people age 65 or older, percentage of people age 5 and younger, percentage of all people whose income in the past 12 months is below poverty threshold, and percentage of people with limited proficiency in English. Based on the data to reflect OSE, the mapping of each alternative was qualitatively assessed against social vulnerability, critical infrastructure, and evacuation route mapping and observations were recorded (**Table 9-25**). As the study progresses, the data and information used to assess OSE will be refined and will be used to further evaluate alternatives within the preliminary focused array of alternative plans.

Table 9-25: Alternative Qualitative Assessment

Alternative	Nuisance Flooding	Social Risk and Vulnerability	Infrastructure Exposure	Community Cohesion
SHARK RIVER AND COASTAL LAKES REGION				
2A	No reduction in inundation during higher frequency events	There is risk that elevating structures might create a false sense of security during a storm event reducing compliance with evacuation orders. People sheltering in place will increase their personal risk and could also increase risk to emergency responders	No reduction of exposure of critical infrastructure and evacuation routes	Residual risk to infrastructure and properties that don't qualify for elevation could reduce the robustness of coastal communities. Additionally, there might be community opposition to selective elevating of structures and the needed real estate easements.
NORTH REGION				
3A	No reduction in inundation during higher frequency events	There is risk that elevating structures might create a false sense of security during a storm event reducing compliance with evacuation orders. People sheltering in place will increase their personal risk and could also increase risk to emergency responders	No reduction of exposure of critical infrastructure and evacuation routes	Residual risk to infrastructure and properties that don't qualify for elevation could reduce the robustness of coastal communities. Additionally, there might be community opposition to selective elevating of structures and the needed real estate easements.
3D	No reduction in inundation during higher frequency events, except behind the Manasquan North floodwall.	There is risk that elevating structures might create a false sense of security during a storm event reducing compliance with evacuation orders. People sheltering in place will increase their personal risk and could also increase risk to emergency responders	No reduction of exposure of critical infrastructure and evacuation routes, except behind the Manasquan North Floodwall.	Residual risk to infrastructure and properties that don't qualify for elevation could reduce the robustness of coastal communities. Additionally, there might be community opposition to selective elevating of structures and the needed real estate easements. Along the Manasquan North floodwall, there is potential for reduction in bayside views and access by floodwalls. There will also likely be difficulties in obtaining real estate easements required to construct walls. .
3E(1)	Storm surge barriers will manage risk from low frequency storms in the area of influence around Manasquan and Barnegat inlets, but will not address the risk to communities from higher frequency events.	Storm surge barriers will manage risk from low frequency coastal storms, but will not address the risk to communities from higher frequency events. No coastal storm risk management is implemented in the vicinity of Tuckerton.	Exposure of critical infrastructure and evacuation routes is lessened around Manasquan and Barnegat Inlets during low frequency events when the storm surge barrier is closed. However, infrastructure is vulnerable in the southern vicinity of Tuckerton	As of now, the full extent of the indirect impacts of a storm surge barrier are not understood. There is risk that these structures could result in environmental degradation, which can have negative impacts on the recreational and aquaculture industries in the study area. The omission of coastal storm risk management in the vicinity of Tuckerton could have a negative impact on this community in the future
3E(2)	Storm surge barriers will manage risk from low frequency storms in the area of influence around Manasquan and Barnegat inlets, but will not address the risk to communities from higher frequency events.	Storm surge barriers will manage risk from low frequency coastal storms, but will not address the risk to communities from higher frequency events. There is risk that elevating structures might create a false sense of security during a storm event reducing compliance with evacuation orders around Tuckerton. People sheltering in place will increase their personal risk and could also increase risk to emergency responders	Exposure of critical infrastructure and evacuation routes is lessened around Manasquan and Barnegat Inlets during low frequency events when the storm surge barrier is closed. However, infrastructure is vulnerable in the southern vicinity of Tuckerton where nonstructural measures will be implemented.	As of now, the full extent of the indirect impacts of a storm surge barrier are not understood. There is risk that these structures could result in environmental degradation, which can have negative impacts on the recreational and aquaculture industries in the study area. Residual risk to infrastructure and properties that don't qualify for elevation could reduce the robustness of coastal communities. Additionally, there might be community opposition to selective elevating of structures and the needed real estate easements.
3E(3)	Storm surge barriers will manage risk from low frequency storms in the area of influence around Manasquan and Barnegat inlets, but will not address the risk to communities from higher frequency events. Southern LBI will experience less nuisance flooding due to the construction of a floodwall.	Storm surge barriers will manage risk from low frequency coastal storms, but will not address the risk to communities from higher frequency events, except in southern LBI where a floodwall will be constructed. There is risk that elevating structures might create a false sense of security during a storm event reducing compliance with evacuation orders around Tuckerton.	Exposure of critical infrastructure and evacuation routes is lessened around Manasquan and Barnegat Inlets during low frequency events when the storm surge barrier is closed and in LBI due to the presence of a floodwall. However, infrastructure is vulnerable in the southern vicinity of Tuckerton where nonstructural measures will be implemented.	As of now, the full extent of the indirect impacts of a storm surge barrier are not understood. There is risk that these structures could result in environmental degradation, which can have negative impacts on the recreational and aquaculture industries in the study area. Residual risk to infrastructure and properties that don't qualify for elevation could reduce the robustness of coastal communities. Additionally, there might be community opposition to selective elevating of structures and the needed real estate easements. In southern LBI, there is potential for reduction in bayside views and access by floodwalls. There will also likely be difficulties in obtaining real estate easements required to construct walls.
CENTRAL REGION				
4A	No reduction in inundation during higher frequency events	There is risk that elevating structures might create a false sense of security during a storm event reducing compliance with evacuation orders. People sheltering in place could increase both their personal risk and the risk to emergency responders.	No reduction of exposure of critical infrastructure and evacuation routes	T Residual risk to infrastructure and properties that don't qualify for elevation could reduce the robustness of coastal communities. Additionally, there might be community opposition to selective elevating of structures and the needed real estate easements.

Alternative	Nuisance Flooding	Social Risk and Vulnerability	Infrastructure Exposure	Community Cohesion
4D(1)	Floodwalls and Levees would reduce inundation in barrier island (except Brigantine Island) communities during higher frequency events.	There is risk that elevating structures might create a false sense of security during a storm event reducing compliance with evacuation orders in Brigantine, Somers Point, Linwood, Northfield, Pleasantville, and Absecon. People sheltering in place could increase both their personal risk and the risk to emergency responders.	Exposure of critical infrastructure and evacuation routes is lessened on the barrier islands, except for Brigantine. Infrastructure and evacuation routes remain vulnerable on the mainland and Brigantine.	Potential for reduction in bayside views and access by floodwalls in Ocean City and Absecon Island. Real estate easements required to construct walls could be difficult to obtain. Residual risk to infrastructure and properties that don't qualify for elevation could reduce the robustness of coastal communities in Brigantine, Somers Point, Linwood, Northfield, Pleasantville, and Absecon. Additionally, there might be community opposition to selective elevating of structures and the needed real estate easements.
4D(2)	Floodwalls and Levees would reduce inundation in barrier island communities during higher frequency events.	There is risk that elevating structures might create a false sense of security during a storm event reducing compliance with evacuation orders in Somers Point, Linwood, Northfield, Pleasantville, and Absecon. People sheltering in place could increase both their personal risk and the risk to emergency responders.	Exposure of critical infrastructure and evacuation routes is lessened on the barrier islands. Infrastructure and evacuation routes remain vulnerable on the mainland. .	Potential for reduction in bayside views and access by floodwalls in Ocean City, Absecon Island, and Brigantine. Real estate easements required to construct walls could be difficult to obtain. Residual risk to infrastructure and properties that don't qualify for elevation could reduce the robustness of coastal communities in Somers Point, Linwood, Northfield, Pleasantville, and Absecon. Additionally, there might be community opposition to selective elevating of structures and the needed real estate easements.
4E(2)	Storm surge barriers will manage risk from low frequency storms in the area of influence around Great Egg Harbor and Absecon Inlets, but will not address the risk to communities from higher frequency events.	Storm surge barriers will manage risk from low frequency coastal storms, but will not address the risk to communities from higher frequency events. Additionally, communities on the mainland Little Egg Inlet remain vulnerable as these inlets will not be closed. There is risk that elevating structures might create a false sense of security during a storm event reducing compliance with evacuation orders in mainland communities adjacent to Little Egg Inlet.	Exposure of critical infrastructure and evacuation routes is lessened around Great Egg Harbor and Absecon Inlets during low frequency events when the storm surge barrier is closed. However, infrastructure is vulnerable when the storm surge barriers are open.	As of now, the full extent of the indirect impacts of a storm surge barrier are not understood. There is risk that these structures could result in environmental degradation, which can have negative impacts on the recreational and aquaculture industries in the study area. Residual risk to infrastructure and properties that don't qualify for elevation could reduce the robustness of coastal communities in Southern Ocean City and Absecon. Additionally, there might be community opposition to selective elevating of structures and the needed real estate easements.
4E(3)	Storm surge barriers will manage risk from low frequency storms in the area of influence around Great Egg Harbor and Absecon Inlets, but will not address the risk to communities from higher frequency events. The floodwall in Southern Ocean City will reduce inundation from higher frequency events.	Storm surge barriers will manage risk from low frequency coastal storms, but will not address the risk to communities from higher frequency events. Additionally, communities on the mainland around Corson Inlet and Little Egg Inlet remain vulnerable as these inlets will not be closed. There is risk that elevating structures might create a false sense of security during a storm event reducing compliance with evacuation orders in mainland communities adjacent to Little Egg Inlet and Corson Inlet. People sheltering in place could increase both their personal risk and the risk to emergency responders.	Exposure of critical infrastructure and evacuation routes is lessened around Manasquan and Barnegat Inlets during low frequency events when the storm surge barrier is closed. However, infrastructure is vulnerable when the storm surge barriers are open. The floodwall in Southern Ocean City could improve risk management for critical infrastructure in this area.	T As of now, the full extent of the indirect impacts of a storm surge barrier are not understood. There is risk that these structures could result in environmental degradation, which can have negative impacts on the recreational and aquaculture industries in the study area. However, storm surge barriers will reduce coastal storm risk in mainland communities during low frequency events when the barrier is closed. Residual risk to infrastructure and properties that don't qualify for elevation could reduce the robustness of coastal communities on the mainland adjacent to Corson and Little Egg Inlet. Additionally, there might be community opposition to selective elevating of structures and the needed real estate easements. Potential for reduction in bayside views and access by floodwalls in Southern Ocean City. Real estate easements required to construct walls could be difficult to obtain.
4E(4)	Storm surge barriers will manage risk from low frequency storms in the area of influence around Great Egg Harbor and Absecon Inlets, but will not address the risk to communities from higher frequency events. The floodwall in Southern Ocean City will reduce inundation from higher frequency events.	Storm surge barriers will manage risk from low frequency coastal storms, but will not address the risk to communities from higher frequency events. Additionally, communities on the mainland around Corson Inlet and Little Egg Inlet remain vulnerable as these inlets will not be closed. There is risk that elevating structures might create a false sense of security during a storm event reducing compliance with evacuation orders in mainland communities adjacent to Little Egg Inlet and Corson Inlet. People sheltering in place could increase both their personal risk and the risk to emergency responders.	Exposure of critical infrastructure and evacuation routes is lessened around Great Egg and Absecon Inlets during low frequency events when the storm surge barrier is closed. However, infrastructure is vulnerable when the storm surge barriers are open. The floodwall in Southern Ocean City could improve risk management for critical infrastructure in this area. .	As of now, the full extent of the indirect impacts of a storm surge barrier and bay closures are not understood. There is risk that these structures could result in environmental degradation, which can have negative impacts on the recreational and aquaculture industries in the study area. However, storm surge barriers will reduce coastal storm risk in mainland communities during low frequency events when the barrier is closed. Residual risk to infrastructure and properties that don't qualify for elevation could reduce the robustness of coastal communities on the mainland adjacent to Little Egg Inlet. Additionally, there might be community opposition to selective elevating of structures and the needed real estate easements.

Alternative	Nuisance Flooding	Social Risk and Vulnerability	Infrastructure Exposure	Community Cohesion
4G(5)	Storm surge barriers will manage risk from low frequency storms in the area of influence around Great Egg Harbor, but will not address the risk to communities from higher frequency events. Nonstructural measures to the north of the Absecon Bay Blvd will reduce risk to structures from nuisance flooding, but will not impact other critical infrastructure such as roads. No coastal storm risk management is provided to communities around Corson Inlet.	Storm surge barriers and bay closures will manage risk from low frequency coastal storms, but will not address the risk to communities from higher frequency events. Additionally, communities around Corson Inlet remain vulnerable as this inlet will not be closed. There is risk that elevating structures north of the Absecon Bay Blvd closure might create a false sense of security during a storm event reducing compliance with evacuation orders. People sheltering in place could increase both their personal risk and the risk to emergency responders.	Exposure of critical infrastructure and evacuation routes is lessened around Great Egg Inlet and south of the Absecon Blvd bay closure during low frequency events when the storm surge barrier is closed. However, infrastructure is vulnerable when the storm surge barriers are open. The construction of the bay closure will elevate Absecon Blvd, which will reduce exposure of the evacuation route to coastal storm risk. North of the bay closure and around Corson Inlet, there is no risk reduction to critical infrastructure or evacuation routes. Modeling would need to be completed to confirm that the bay closure doesn't induce flooding north of the structure from Little Egg Inlet. .	As of now, the full extent of the indirect impacts of a storm surge barrier and bay closures are not understood. There is risk that these structures could result in environmental degradation, which can have negative impacts on the recreational and aquaculture industries in the study area. However, storm surge barriers will reduce coastal storm risk in mainland communities such as Somers Point, Linwood, and Northfield during low frequency events when the barrier is closed. Residual risk to infrastructure and properties that don't qualify for elevation could reduce the robustness of coastal communities north of the Absecon Blvd bay closure. No coastal storm risk management on around Corson Inlet can have negative impacts on these communities. .
4G(6)	Storm surge barriers will manage risk from low frequency storms in the area of influence around Great Egg Harbor, but will not address the risk to communities from higher frequency events. Nonstructural measures to the north of the Absecon Bay Blvd and around Corson Inlet will reduce risk to structures from nuisance flooding, but will not impact other critical infrastructure such as roads.	Storm surge barriers and bay closures will manage risk from low frequency coastal storms, but will not address the risk to communities from higher frequency events. There is risk that elevating structures north of the Absecon Bay Blvd closure and around Corson Inlet might create a false sense of security during a storm event reducing compliance with evacuation orders. People sheltering in place could increase both their personal risk and the risk to emergency responders.	Exposure of critical infrastructure and evacuation routes is lessened around Great Egg Inlet and south of the Absecon Blvd bay closure during low frequency events when the storm surge barrier is closed. However, infrastructure is vulnerable when the storm surge barriers are open. The construction of the bay closure will elevate Absecon Blvd, which will reduce exposure of the evacuation route to coastal storm risk. North of the bay closure and around Corson Inlet, there is no risk reduction to critical infrastructure or evacuation routes. Modeling would need to be completed to confirm that the bay closure doesn't induce flooding north of the structure from Little Egg Inlet.	As of now, the full extent of the indirect impacts of a storm surge barrier and bay closures are not understood. There is risk that these structures could result in environmental degradation, which can have negative impacts on the recreational and aquaculture industries in the study area. However, storm surge barriers will reduce coastal storm risk in mainland communities such as Somers Point, Linwood, and Northfield during low frequency events when the barrier is closed. Residual risk to infrastructure and properties that don't qualify for elevation could reduce the robustness of coastal communities north of the Absecon Blvd bay closure and around Corson Inlet.
4G(7)	Storm surge barriers will manage risk from low frequency storms in the area of influence around Great Egg Harbor, but will not address the risk to communities from higher frequency events. Nonstructural measures to the north of the Absecon Bay Blvd and around Corson Inlet will reduce risk to structures from nuisance flooding, but will not impact other critical infrastructure such as roads. The floodwall in Southern Ocean City will reduce inundation from higher frequency events. .	Storm surge barriers and bay closures will manage risk from low frequency coastal storms, but will not address the risk to communities from higher frequency events. There is risk that elevating structures north of the Absecon Bay Blvd closure and around Corson Inlet might create a false sense of security during a storm event reducing compliance with evacuation orders. People sheltering in place could increase both their personal risk and the risk to emergency responders.	Exposure of critical infrastructure and evacuation routes is lessened around Great Egg Inlet and south of the Absecon Blvd bay closure during low frequency events when the storm surge barrier is closed. However, infrastructure is vulnerable when the storm surge barriers are open. The construction of the bay closure will elevate Absecon Blvd, which will reduce exposure of the evacuation route to coastal storm risk. The floodwall in Southern Ocean City could improve risk management for critical infrastructure in this area. North of the bay closure and around Corson Inlet, there is no risk reduction to critical infrastructure or evacuation routes. Modeling would need to be completed to confirm that the bay closure doesn't induce flooding north of the structure from Little Egg Inlet.	As of now, the full extent of the indirect impacts of a storm surge barrier and bay closures are not understood. There is risk that these structures could result in environmental degradation, which can have negative impacts on the recreational and aquaculture industries in the study area. However, storm surge barriers will reduce coastal storm risk in mainland communities such as Somers Point, Linwood, and Northfield during low frequency events when the barrier is closed. Residual risk to infrastructure and properties that don't qualify for elevation could reduce the robustness of coastal communities north of the Absecon Blvd bay closure and around Corson Inlet. There is potential for reduction in bayside views and access by floodwalls in Southern Ocean City. Real estate easements required to construct walls could be difficult to obtain.
4G(8)	Storm surge barriers and bay closures will manage risk from low frequency storms in the area of influence around Great Egg Harbor, but will not address the risk to communities from higher frequency events. Nonstructural measures to the north of the Absecon Bay Blvd will reduce risk to structures from nuisance flooding, but will not impact other critical infrastructure such as roads.	Storm surge barriers and bay closures will manage risk from low frequency coastal storms, but will not address the risk to communities from higher frequency events. There is risk that elevating structures north of the Absecon Bay Blvd closure might create a false sense of security during a storm event reducing compliance with evacuation orders. People sheltering in place could increase both their personal risk and the risk to emergency responders.	Exposure of critical infrastructure and evacuation routes is lessened around Great Egg Inlet and south of the Absecon Blvd bay closure during low frequency events when the storm surge barrier and bay closures are closed. However, infrastructure is vulnerable when the storm surge barriers are open. The construction of the Absecon Blvd bay closure will elevate Absecon Blvd, which will reduce exposure of the evacuation route to coastal storm risk. North of the bay closure, there is no risk reduction to critical infrastructure or evacuation routes. Modeling would need to be completed to confirm that the bay closure doesn't induce flooding north of the structure from Little Egg Inlet.	As of now, the full extent of the indirect impacts of a storm surge barrier and bay closures are not understood. There is risk that these structures could result in environmental degradation, which can have negative impacts on the recreational and aquaculture industries in the study area. However, storm surge barriers will reduce coastal storm risk in mainland communities such as Somers Point, Linwood, and Northfield during low frequency events when the barrier is closed. Residual risk to infrastructure and properties that don't qualify for elevation could reduce the robustness of coastal communities north of the Absecon Blvd bay closure.

Alternative	Nuisance Flooding	Social Risk and Vulnerability	Infrastructure Exposure	Community Cohesion
4G(9)	<p>P Storm surge barriers will manage risk from low frequency storms in the area of influence around Great Egg Harbor, but will not address the risk to communities from higher frequency events. Nonstructural measures to the north of the Absecon Bay Blvd on the mainland will reduce risk to structures from nuisance flooding, but will not impact other critical infrastructure such as roads. The floodwall around Brigantine will reduce inundation from higher frequency events. No coastal storm risk management is provided to communities around Corson Inlet.</p>	<p>Storm surge barriers and bay closures will manage risk from low frequency coastal storms, but will not address the risk to communities from higher frequency events. Additionally, communities around Corson Inlet remain vulnerable as this inlet will not be closed. There is risk that elevating structures on the mainland north of the Absecon Bay Blvd closure might create a false sense of security during a storm event reducing compliance with evacuation orders. People sheltering in place could increase both their personal risk and the risk to emergency responders.</p>	<p>Exposure of critical infrastructure and evacuation routes is lessened around Great Egg Inlet and south of the Absecon Blvd bay closure during low frequency events when the storm surge barrier is closed. However, infrastructure is vulnerable when the storm surge barriers are open. The construction of the bay closure will elevate Absecon Blvd, which will reduce exposure of the evacuation route to coastal storm risk. The floodwall around Brigantine could improve risk management for critical infrastructure in this area. On the mainland north of the Absecon Blvd bay closure and around Corson Inlet, there is no risk reduction to critical infrastructure or evacuation routes. Modeling would need to be completed to confirm that the bay closure doesn't induce flooding north of the structure from Little Egg Inlet.</p>	<p>As of now, the full extent of the indirect impacts of a storm surge barrier and bay closures are not understood. There is risk that these structures could result in environmental degradation, which can have negative impacts on the recreational and aquaculture industries in the study area. However, storm surge barriers will reduce coastal storm risk in mainland communities such as Somers Point, Linwood, and Northfield during low frequency events when the barrier is closed. Residual risk to infrastructure and properties that don't qualify for elevation could reduce the robustness of coastal communities on the mainland north of the Absecon Blvd bay closure. There is potential for reduction in bayside views and access by floodwalls in Brigantine. Real estate easements required to construct walls could be difficult to obtain. No coastal storm risk management on around Corson Inlet can have negative impacts on these communities.</p>
4G(10)	<p>Storm surge barriers will manage risk from low frequency storms in the area of influence around Great Egg Harbor, but will not address the risk to communities from higher frequency events. Nonstructural measures to the north of the Absecon Bay Blvd on the mainland and around Corson Inlet to the south will reduce risk to structures from nuisance flooding, but will not impact other critical infrastructure such as roads. The floodwall around Brigantine will reduce inundation from higher frequency events.</p>	<p>Storm surge barriers and bay closures will manage risk from low frequency coastal storms, but will not address the risk to communities from higher frequency events. There is risk that elevating structures on the mainland north of the Absecon Bay Blvd closure and to the south around Corson Inlet might create a false sense of security during a storm event reducing compliance with evacuation orders. People sheltering in place could increase both their personal risk and the risk to emergency responders.</p>	<p>Exposure of critical infrastructure and evacuation routes is lessened around Great Egg Inlet and south of the Absecon Blvd bay closure during low frequency events when the storm surge barrier is closed. However, infrastructure is vulnerable when the storm surge barriers are open. The construction of the bay closure will elevate Absecon Blvd, which will reduce exposure of the evacuation route to coastal storm risk. The floodwall around Brigantine could improve risk management for critical infrastructure in this area. On the mainland north of the Absecon Blvd bay closure and around Corson Inlet, there is no risk reduction to critical infrastructure or evacuation routes. Modeling would need to be completed to confirm that the bay closure doesn't induce flooding north of the structure from Little Egg Inlet.</p>	<p>As of now, the full extent of the indirect impacts of a storm surge barrier and bay closures are not understood. There is risk that these structures could result in environmental degradation, which can have negative impacts on the recreational and aquaculture industries in the study area. However, storm surge barriers will reduce coastal storm risk in mainland communities such as Somers Point, Linwood, and Northfield during low frequency events when the barrier is closed. Residual risk to infrastructure and properties that don't qualify for elevation could reduce the robustness of coastal communities on the mainland north of the Absecon Blvd bay closure and to the south around Corson Inlet. There is potential for reduction in bayside views and access by floodwalls in Brigantine. Real estate easements required to construct walls could be difficult to obtain.</p>
4G(11)	<p>Storm surge barriers will manage risk from low frequency storms in the area of influence around Great Egg Harbor, but will not address the risk to communities from higher frequency events. Nonstructural measures to the north of the Absecon Bay Blvd on the mainland and around Corson Inlet to the south will reduce risk to structures from nuisance flooding, but will not impact other critical infrastructure such as roads. The floodwalls around Brigantine and southern Ocean City will reduce inundation from higher frequency events.</p>	<p>Storm surge barriers and bay closures will manage risk from low frequency coastal storms, but will not address the risk to communities from higher frequency events. There is risk that elevating structures on the mainland north of the Absecon Bay Blvd closure and to the south around Corson Inlet might create a false sense of security during a storm event reducing compliance with evacuation orders. People sheltering in place could increase both their personal risk and the risk to emergency responders.</p>	<p>Exposure of critical infrastructure and evacuation routes is lessened around Great Egg Inlet and south of the Absecon Blvd bay closure during low frequency events when the storm surge barrier is closed. However, infrastructure is vulnerable when the storm surge barriers are open. The construction of the bay closure will elevate Absecon Blvd, which will reduce exposure of the evacuation route to coastal storm risk. The floodwalls around Brigantine and southern Ocean City could improve risk management for critical infrastructure in this area. On the mainland north of the Absecon Blvd bay closure and around Corson Inlet, there is no risk reduction to critical infrastructure or evacuation routes. Modeling would need to be completed to confirm that the bay closure doesn't induce flooding north of the structure from Little Egg Inlet.</p>	<p>As of now, the full extent of the indirect impacts of a storm surge barrier and bay closures are not understood. There is risk that these structures could result in environmental degradation, which can have negative impacts on the recreational and aquaculture industries in the study area. However, storm surge barriers will reduce coastal storm risk in mainland communities such as Somers Point, Linwood, and Northfield during low frequency events when the barrier is closed. Residual risk to infrastructure and properties that don't qualify for elevation could reduce the robustness of coastal communities on the mainland north of the Absecon Blvd bay closure and to the south around Corson Inlet. There is potential for reduction in bayside views and access by floodwalls in Brigantine and southern Ocean City. Real estate easements required to construct walls could be difficult to obtain.</p>

Alternative	Nuisance Flooding	Social Risk and Vulnerability	Infrastructure Exposure	Community Cohesion
4G(12)	Storm surge barriers will manage risk from low frequency storms in the area of influence around Great Egg Harbor, but will not address the risk to communities from higher frequency events. Nonstructural measures to the north of the Absecon Bay Blvd on the mainland will reduce risk to structures from nuisance flooding, but will not impact other critical infrastructure such as roads. The floodwall around Brigantine will reduce inundation from higher frequency events.	Storm surge barriers and bay closures will manage risk from low frequency coastal storms, but will not address the risk to communities from higher frequency events. . There is risk that elevating structures on the mainland north of the Absecon Bay Blvd closure might create a false sense of security during a storm event reducing compliance with evacuation orders. People sheltering in place could increase both their personal risk and the risk to emergency responders.	Exposure of critical infrastructure and evacuation routes is lessened around Great Egg Inlet and south of the Absecon Blvd bay closure during low frequency events when the storm surge barrier is closed. However, infrastructure is vulnerable when the storm surge barriers are open. The construction of the Absecon Blvd bay closure will elevate Absecon Blvd, which will reduce exposure of the evacuation route to coastal storm risk. The floodwall around Brigantine could improve risk management for critical infrastructure in this area. On the mainland north of the Absecon Blvd bay closure there is no risk reduction to critical infrastructure or evacuation routes. Modeling would need to be completed to confirm that the bay closure doesn't induce flooding north of the structure from Little Egg Inlet.	As of now, the full extent of the indirect impacts of a storm surge barrier and bay closures are not understood. There is risk that these structures could result in environmental degradation, which can have negative impacts on the recreational and aquaculture industries in the study area. However, storm surge barriers will reduce coastal storm risk in mainland communities such as Somers Point, Linwood, and Northfield during low frequency events when the barrier is closed. Residual risk to infrastructure and properties that don't qualify for elevation could reduce the robustness of coastal communities on the mainland north of the Absecon Blvd bay closure. There is potential for reduction in bayside views and access by floodwalls in Brigantine. Real estate easements required to construct walls could be difficult to obtain.
SOUTH REGION				
5A	No reduction in inundation during higher frequency events	There is risk that elevating structures might create a false sense of security during a storm event reducing compliance with evacuation orders. People sheltering in place could increase both their personal risk and the risk to emergency responders.	No reduction of exposure of critical infrastructure and evacuation routes	Residual risk to infrastructure and properties that don't qualify for elevation could reduce the robustness of coastal communities. Additionally, there might be community opposition to selective elevating of structures and the needed real estate easements.
5D(1)	No reduction in inundation during higher frequency events in Strathmere and 7 Mile Island. Floodwalls and Levees would reduce inundation during higher frequency events in Cape May, the Wildwoods, and Sea Isle City.	There is risk that elevating structures might create a false sense of security during a storm event reducing compliance with evacuation orders. People sheltering in place could increase both their personal risk and the risk to emergency responders.	Exposure of critical infrastructure and evacuation routes is lessened in the Wildwoods, Cape May, and Sea Isle City. Exposure to critical infrastructure is not lessened in Strathmere and 7 Mile Island. Infrastructure and evacuation routes remain vulnerable on the mainland.	Residual risk to infrastructure and properties that don't qualify for elevation in Strathmere and 7 Mile Island could reduce the robustness of those coastal communities. Additionally, there might be community opposition to selective elevating of structures and the needed real estate easements. Along the floodwalls in Sea Isle City, the Wildwoods, and Cape May, there is potential for reduction in bayside views and access by floodwalls. There will also likely be difficulties in obtaining real estate easements required to construct walls.
5D(2)	No reduction in inundation during higher frequency events in Strathmere. Floodwalls and Levees would reduce inundation during higher frequency events in Cape May, the Wildwoods, 7 Mile Island and Sea Isle City.	There is risk that elevating structures might create a false sense of security during a storm event reducing compliance with evacuation orders in Strathmere. People sheltering in place could increase both their personal risk and the risk to emergency responders.	Exposure of critical infrastructure and evacuation routes is lessened in the Wildwoods, Cape May, 7 Mile Island and Sea Isle City. Exposure to critical infrastructure is not lessened in Strathmere. Infrastructure and evacuation routes remain vulnerable on the mainland.	Residual risk to infrastructure and properties that don't qualify for elevation could reduce the robustness of coastal communities. Additionally, there might be community opposition to selective elevating of structures and the needed real estate easements.

10 The Preliminary Focused Array of Alternative Plans

10.1 Introduction and Overview

The preliminary focused array of alternative plans has been formulated based on management measures screening and the evaluation and comparison of alternative plans as discussed in preceding sections. From the 51 presented regional alternative plans, 20 preliminary regional alternative plans within 10 themes are included in the focused array and are discussed in this chapter. Nonstructural measures are being considered in all regions. Storm surge barriers are considered only in the North and Central regions, while interior bay closures are considered in only the Central region. Perimeter measures including floodwalls and levees are considered in all regions. **Table 10-1** provides an overview of the strategies that remain under consideration within each region.

Table 10-1: Preliminary Focused Array of Alternative Plans

Region	Themes	Alternative	NONSTRUC	PERIMETER	SSB	BC
SHARK RIVER	2A	2A	X			
NORTH	3A	3A	X			
	3D	3D	X	X		
	3E	3E(2)	X		X	
		3E(3)	X	X	X	
CENTRAL	4A	4A	X			
	4D	4D(1)	X	X		
		4D(2)	X	X		
	4E	4E(2)	X		X	
		4E(3)	X	X	X	
		4E(4)	X		X	X
	4G	4G(6)	X		X	X
		4G(7)	X	X	X	X
		4G(8)	X		X	X
		4G(10)	X	X	X	X
		4G(11)	X	X	X	X
	4G(12)	X	X	X	X	
SOUTH	5A	5A	X			
	5D	5D(1)	X	X		
		5D(2)	X	X		

Region	Overview	Alternative	INIT. CONST.	AANB	BCR	RESIDUAL
SHARK RIVER	2A	2A	\$24,468,000	\$227,000	1.25	88.47%
NORTH	3A	3A	\$3,629,095,000	\$68,586,000	1.51	62.97%
	3D	3D	\$3,898,614,000	\$64,831,000	1.43	60.81%
	3E	3E(2)	\$3,837,663,000	\$160,160,000	1.79	33.84%

		3E(3)	\$4,838,353,000	\$131,861,000	1.49	27.06%
CENTRAL	4A	4A	\$1,954,627,000	\$76,562,000	2.06	78.81%
	4D	4D(1)	\$3,336,914,000	\$377,671,000	3.10	20.65%
		4D(2)	\$3,822,130,000	\$367,689,000	2.76	18.02%
	4E	4E(2)	\$7,140,707,000	\$160,299,000	1.38	16.64%
		4E(3)	\$7,169,796,000	\$146,094,000	1.33	15.64%
		4E(4)	\$7,173,761,000	\$145,853,000	1.32	15.24%
	4G	4G(6)	\$5,520,576,000	\$302,114,000	1.93	10.80%
		4G(7)	\$5,549,665,000	\$303,630,000	1.92	9.71%
		4G(8)	\$5,553,629,000	\$303,405,000	1.91	9.30%
		4G(10)	\$6,005,792,000	\$297,380,000	1.84	7.42%
		4G(11)	\$6,034,880,000	\$298,897,000	1.83	6.33%
		4G(12)	\$6,038,845,000	\$298,671,000	1.82	5.93%
SOUTH	5A	5A	\$1,467,103,000	\$44,216,000	1.81	68.27%
	5D	5D(1)	\$2,286,822,000	\$96,408,000	1.88	33.53%
		5D(2)	\$3,428,552,000	\$57,310,000	1.32	23.52%

The focused array of alternative plans is presented by region as even just the remaining 20 alternatives have a total of 144 unique, non-repetitive combinations if they were aggregated to a study-wide level. In addition, each region (with the exception of Shark River) has multiple alternative types still under consideration with further analysis necessary to determine the NED Plan.

However, as each region is functionally independent, it is possible to calculate the AANB and BCR for any and all of the 144 combinations. For example, the current NED maximizing study wide plan is the combination of 2A + 3E(2) + 4D(1) + 5D(1) for a total of \$634,466,000 in AANB with a 2.29 BCR with 28.22% residual damages. The current damage minimization plan is 2A + 3E(3) + 4G(12) + 5D(2) with \$488,069,000 in AANB with a 1.6 BCR and 17.29% in residual damages.

Combinations that minimize environmental impact or maximize social benefits or any other objective can be calculated by aggregating one alternative from each Region.

10.2 Natural and Nature Based Features in the Preliminary Focused Array

Natural and Nature Based Features (NNBFs) assist in the incorporation of natural approaches to develop regional climate change and sea level rise adaptation planning strategies and solutions in the NJBB study area. At this point in the NJBB Study, the preliminary focused array of alternative plans do not consider specific locations for NNBF implementation. Additional analysis regarding NNBF implementation will be performed during subsequent phases of the feasibility study. Additional USACE and stakeholder resources will be incorporated towards integration of NNBF as the study progresses.

To date, the NJBB study has incorporated NNBFs to help meet the project objectives and provide coastal storm risk management attributes in adherence to Section 1184 of the Water Resources

Development Act of 2016 requires the Secretary of the Army, with the consent of the non-federal sponsor, to consider NNBFs when studying the feasibility of projects for flood risk management. Other policy drivers for incorporating NNBF are outlined below:

- Executive Order 13690: "Where possible, an agency shall use natural systems, ecosystem processes, and nature-based approaches when developing alternatives for consideration,"
- Executive Order 11998, Section 1, which directs Federal agencies to take action to restore and preserve the natural and beneficial values served by floodplains; and
- Consistent with Federal Government Policy Priorities and best practices which promote integration of green infrastructure for coastal flood risk management following Hurricane Sandy (e.g. Hurricane Sandy rebuilding Strategy Recommendations 19-22).

Stand-alone NNBF measures under consideration as part of the plan formulation process in the NJBB Study are discussed in Chapter 10.2.4 and include:

- Living shorelines
- Reefs
- Wetland restoration; and
- Submerged aquatic vegetation (SAV)

In addition to the stand-alone NNBF measures discussed above, NNBFs are also being considered in combination with structural measures. For instance, plan formulation analyses suggest that NNBFs would meet the project objectives when placed in combination with the following structural measures:

- Unarmored shorelines adjacent to infrastructure;
- Complementary to structural measures such as floodwalls and levees; and
- Specific modifications to structural measures including habitat benches to restore more natural slope along shorelines and textured concrete to support colonization of algae and invertebrates.

Continuing evaluation for potential NNBF implementation include locations in the study area with undeveloped shorelines showing shoreline erosion adjacent to infrastructure as well as adjacent to storm surge barriers or floodwalls/levees to pre-emptively address erosion near these structures. Additional analyses are being performed as part of the study process to assess the roll of NNBF measures to manage the risk from both erosion and inundation.

10.3 Preliminary Focused Array Description by Region

10.3.1 No Action

The No Action alternative is a plan that proposes the USACE will not implement any of the proposed actions identified in this study. The No Action Alternative also assumes current floodplain management conditions continue into the future. Estimated future changes such as changes in sea level, local environment, land use, and population as well as policy, laws and regulations are incorporated into the No Action Alternative.

This plan is considered the projected baseline, or without project, condition which is used to compare all other proposed alternatives. Future economic, environmental, and social impacts of all proposed alternatives are assessed against the No Action Alternative.

The project baseline is estimated to be 2030 when construction of the actual project will begin. All Federal, NJDEP and NGOs (i.e. NFWF) constructed or ongoing navigation projects as identified in Plan Formulation Appendix A in the 'Existing CSRMs Studies, Reports Projects, Actions and Programs' Section are considered included in the No Action alternative.

10.3.2 Coastal Lakes Region

Along the northernmost 13 miles of the study area there are sixteen bodies of water commonly referred to as "coastal lakes", which are displayed in **Figure 10-1**. From north to south, the coastal lakes (and the municipalities in which they are located) include:

- Lake Takanassee (Long Branch)
- Deal Lake (Loch Arbor/Asbury Park)
- Sunset Lake (Asbury Park)
- Wesley Lake (Asbury Park/Ocean Grove)
- Fletcher Lake (Ocean Grove)
- Sylvan Lake (Bradley Beach/Avon-by-the-Sea)
- Silver Lake (Belmar)
- Lake Como (Belmar/Spring Lake)
- Spring Lake (Spring Lake)
- Wreck Pond (Spring Lake/Sea Girt)
- Stockton Lake (Sea Girt/Manasquan)
- Glimmer Glass (Manasquan)
- Lake Louise (Pt Pleasant Beach)
- Little Silver Lake (Pt Pleasant Beach)
- Lake of the Lilies (Pt Pleasant Beach)
- Twilight Lake (Bay Head)



Figure 10-1: Coastal Lakes within the NJBB Study Area

However, there are actually three different classes of “lake” based on their hydrologic and hydraulic characteristics that affect the manner in which their flood risk will be evaluated. For example, four of the lakes are ordinary tidewater bodies with direct, open channel tidal connections to the ocean through Manasquan Inlet or upper Barnegat Bay. The land and structures adjacent to these four will be evaluated for coastal flood risk in the same way that the other 700 (plus) miles of back bay shoreline will be analyzed. Specifically, NACCS stage-frequency data at appropriate data save points will be applied to inventories of structures surrounding each water body. This group of four “lakes” and their tidewater connection are highlighted in green text in **Figure 10-1** and consist of:

- Stockton Lake (Manasquan Inlet)
- Glimmer Glass (Manasquan Inlet)
- Lake Louise (Manasquan Inlet)
- Twilight Lake (upper Barnegat Bay)

There are also four “lakes” that do not have direct open channel connections to the ocean. However, because of a combination of topography and/or underground hydraulic connections (i.e., “plumbing”), they will be evaluated using the same general methodology described above. These four lakes are highlighted in orange text in Figure 10-1 and include:

- Sylvan Lake (north of Shark River Inlet)
- Silver Lake (south of Shark River Inlet)
- Little Silver Lake (south of Manasquan Inlet)
- Lake of the Lillies (south of Manasquan Inlet)

The remaining eight “coastal lakes” are indicated in white text on **Figure 10-1**, and include:

- | | |
|-------------------|-----------------|
| ▪ Lake Takanassee | ▪ Fletcher Lake |
| ▪ Deal Lake | ▪ Lake Como |
| ▪ Sunset Lake | ▪ Spring Lake |
| ▪ Wesley Lake | ▪ Wreck Pond |

These lakes are not directly connected to tidal inlets, hence they are subject to a different type of flood risk than the eight lakes previously discussed and will consequently require an alternate method of analysis. Potential flood pathways for these lakes include fluvial flooding due to precipitation over each lake’s watershed, ocean wave and storm surge overtopping of the barrier beach, and ocean storm surge flooding that “backs up” from the ocean into the lake through the underground drainage pipes. The study team will evaluate each of these lakes and their respective structure inventories for potential coastal flood risk at a screening level of detail. The maximum potential flood risk benefit for each lake will be computed based on an idealized reduction of average annual flood damages to zero. This maximum potential benefit will then be used to calculate the upper limit of an average annual cost that could be applied to measures for flood risk reduction. If this screening-level analysis indicates the potential for cost-effective structural or nonstructural measures (i.e., BCR >> 1.0) to reduce flood risk, then a recommendation will be made for further investigation.

Possible other study approaches include the USACE Continuing Authorities Program or a General Reevaluation Study for the Sea Bright to Manasquan Inlet CSRM project managed by New York District (NAN). A third option would be to modify the scope of the NJBB study to consider additional study efforts required to perform this work. Any of these potential future study paths would require approval from USACE higher authority, and endorsement by the non-federal sponsor, NJDEP.

10.3.3 Shark River Region

Alternative 2A

This alternative includes only nonstructural solutions for 106 residential structures. Only structure elevation is being considered as a nonstructural measure at this point in the study. No storm surge barriers or interior bay closures, or floodwalls/levees are included in this alternative plan. Of particular note is that the storm surge barrier alternative was not justified economically due to relative higher costs than the nonstructural solution and was eliminated as an alternative in the preliminary focused array. NNBF will be considered for this and future focused array alternative plans as they are developed during subsequent phases of the feasibility study. The management measure features of this alternative plan are provided in **Figure 10-2**.

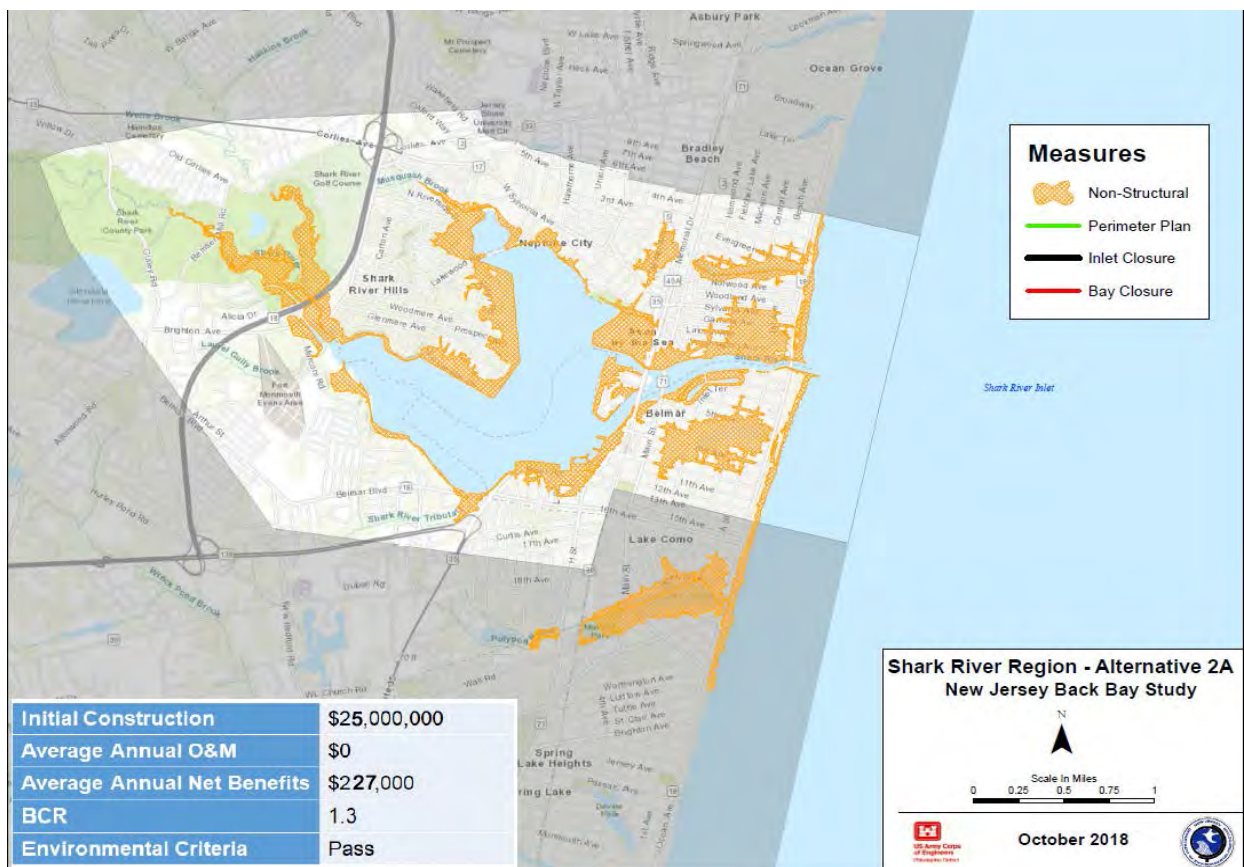

Figure 10-2: Shark River Region Alternative 2A Management Measure Features (Note: Approximate, preliminary locations)

10.3.4 North Region

Analyses for the North Region have indicated a combination of storm surge barriers, floodwalls/levees and nonstructural solutions (including structure elevation for residential structures only at this point in the study) to address coastal storm risk (including residual coastal flooding impacts due to increasing sea level over the extended project period) for the larger Barnegat Bay and Great Bay system. Detailed quantities for storm surge barriers and floodwall/levee solutions can be found in the Engineering Sub-Appendix of the Engineering Appendix B. Detailed hydrodynamic modeling results for storm surge barriers can be found in the Hydrology, Hydraulics and Coastal Engineering Sub-Appendix.

The North Region of the NJBB Study Area includes three themes in the preliminary focused array of alternative plans including 3A, 3D and 3E. Alternative 3A considers nonstructural solutions only. Alternative 3D includes nonstructural and floodwall/levee solutions. Theme 3E, which has two alternative plans including 3E(2) and 3E(3), includes variations of storm surge barrier, nonstructural and floodwall/levee solutions. A more detailed description of these alternative plans are provided below.

Alternative 3A

This preliminary alternative plan includes only nonstructural solutions for 16,421 residential structures. No storm surge barriers or interior bay closures, or floodwalls/levees are included in this alternative plan. The management measure features of Alternative 3A are provided in **Figure 10-3**.

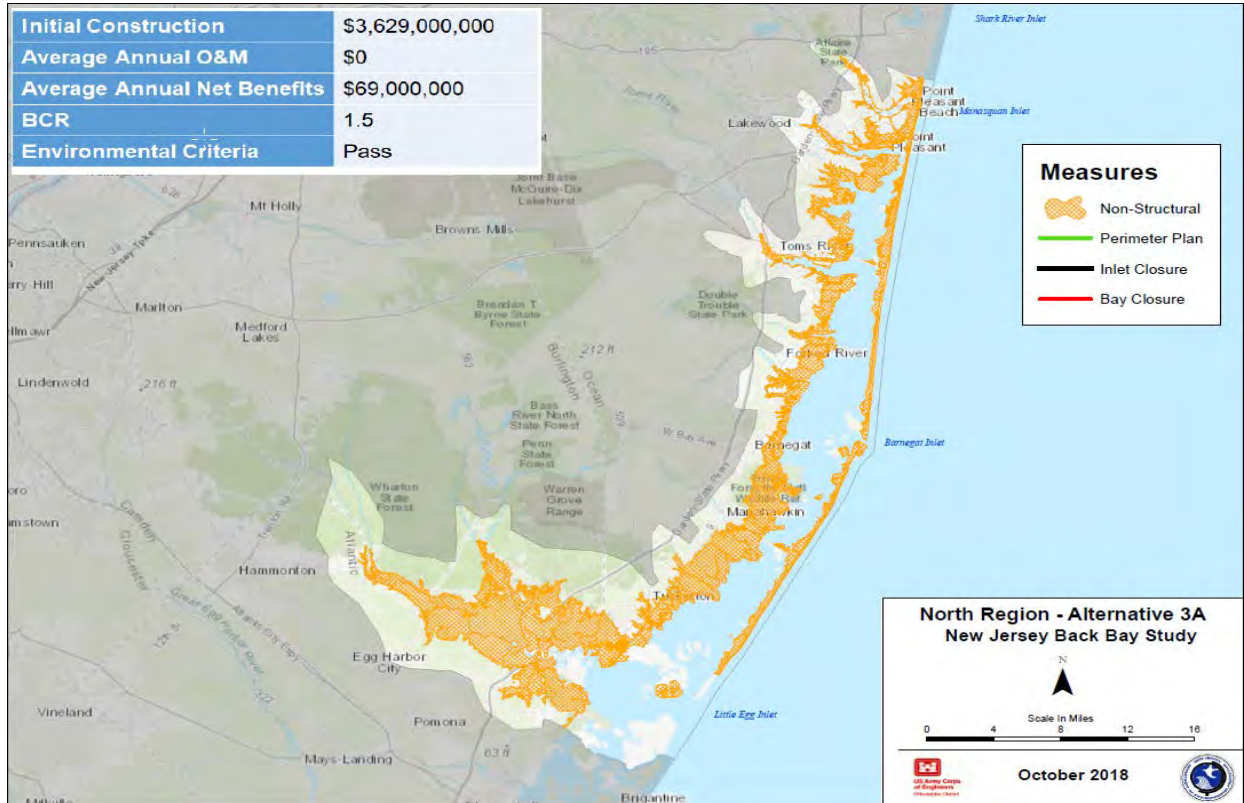

Figure 10-3: North Region Alternative 3A Management Measure Features (Note: Approximate, preliminary locations)

Alternative 3D

The preliminary strategy developed for Alternative 3D includes nonstructural solutions for 15,565 residential structures for the municipalities on the mainland adjacent to Great Bay and Mullica River Embayment, Little Egg Harbor and portions of Manasquan Bay, and associated tributaries and canals. This alternative plan also includes over six miles of floodwalls inclusive of three miter gates and two road closures as well as approximately two miles of levees in the vicinity of Manasquan Inlet in Manasquan, Brielle and Point Pleasant Beach. The management measure features of this alternative plan are provided in **Figure 10-4**.

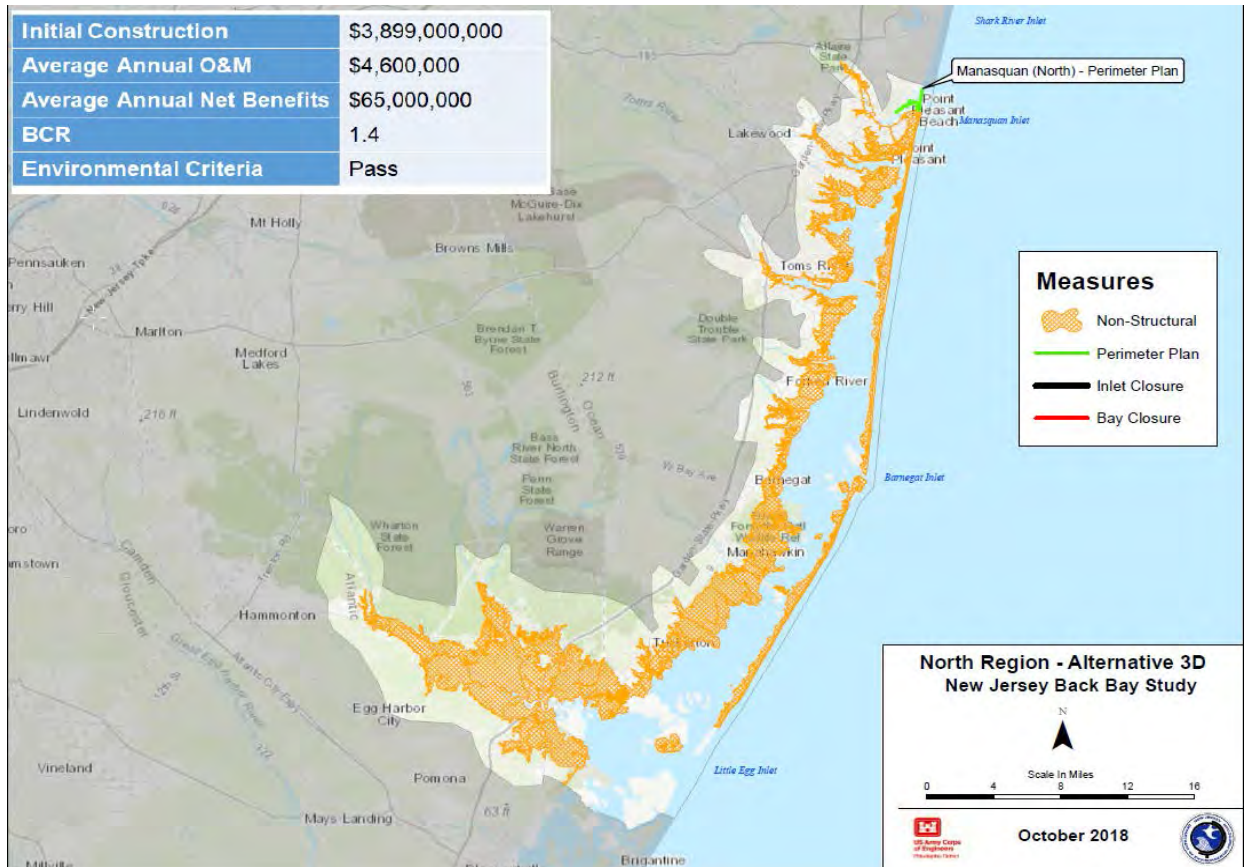

Figure 10-4: North Region Alternative 3D Management Measure Features (Note: Approximate, preliminary locations)

Alternative 3E(2) and 3E(3)

A preliminary strategy was developed for Alternatives 3E(2) and 3E(3) to focus on managing the risk of coastal flooding and sea level rise in the North Region of the NJBB study area. These alternative plans include storm surge barriers located at both Manasquan Inlet and Barnegat Inlet. Detailed quantities for each of these storm surge barriers can be found in the Civil Engineering Sub-Appendix. Detailed hydrodynamic modeling results for storm surge barriers can be found in the Hydrology, Hydraulics and Coastal Engineering Sub-Appendix. Each of these alternative plans include nonstructural solutions for the municipalities on the mainland adjacent to Great Bay and Mullica River Embayment, Little Egg Harbor and portions of Manahawkin Bay, and associated tributaries and canals.

Alternative 3E(2) includes nonstructural solutions for 5,843 residential structures developed portions of Long Beach Island fronting Little Egg Harbor and portions of Manahawkin Bay. Alternative 3E(3) includes 75 miles of floodwalls inclusive of 10 miter gates and 10 road closures, and approximately three miles of levees along Long Beach Island fronting Little Egg Harbor and portions of Manahawkin Bay rather than the nonstructural solutions for the Long Beach Island shoreline offered in alternative 3E(2). This alternative plan includes nonstructural solutions for 3,780 residential structures. The management measure features of these alternative plans are provided in **Figure 10-5** and **Figure 10-6**.

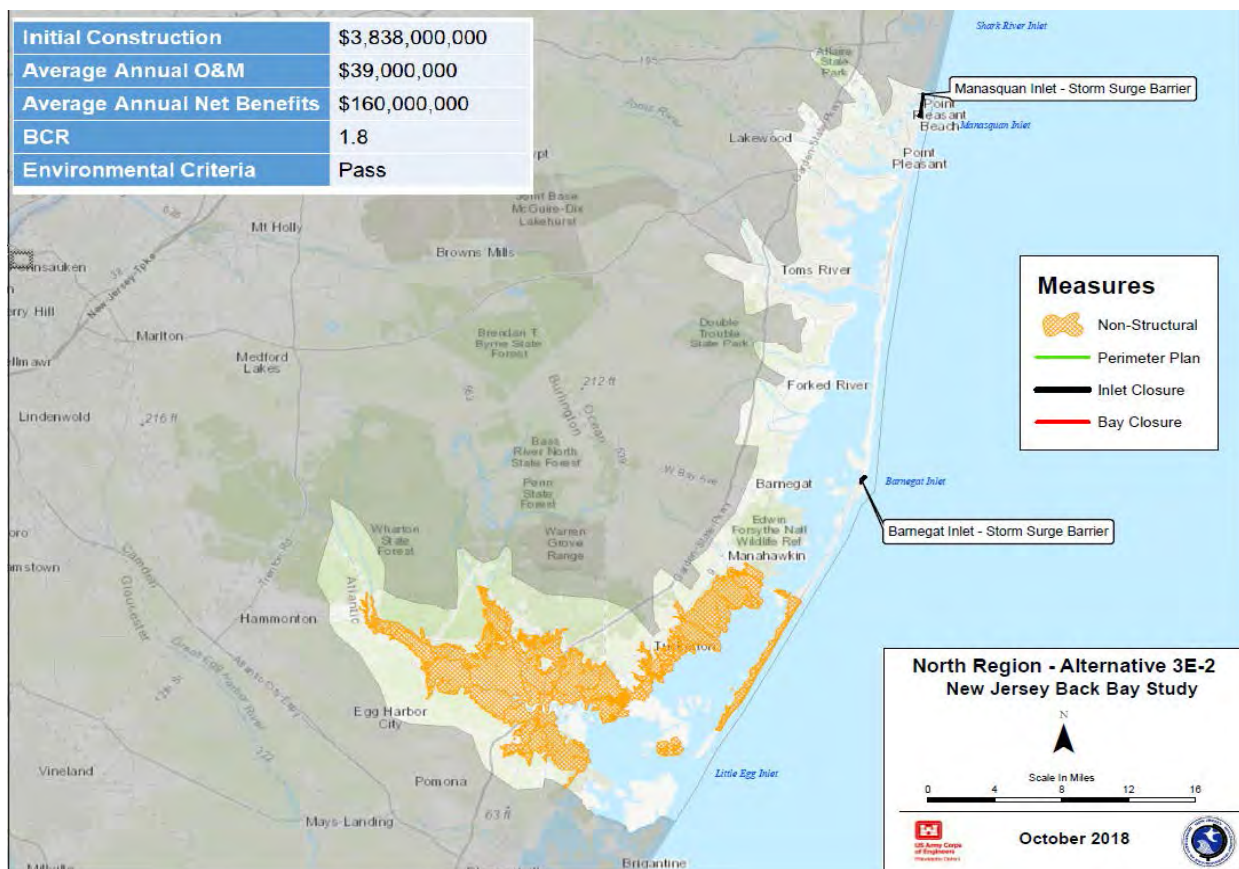

Figure 10-5: North Region Alternative 3E(2) Management Measure Features (Note: Approximate, preliminary locations)

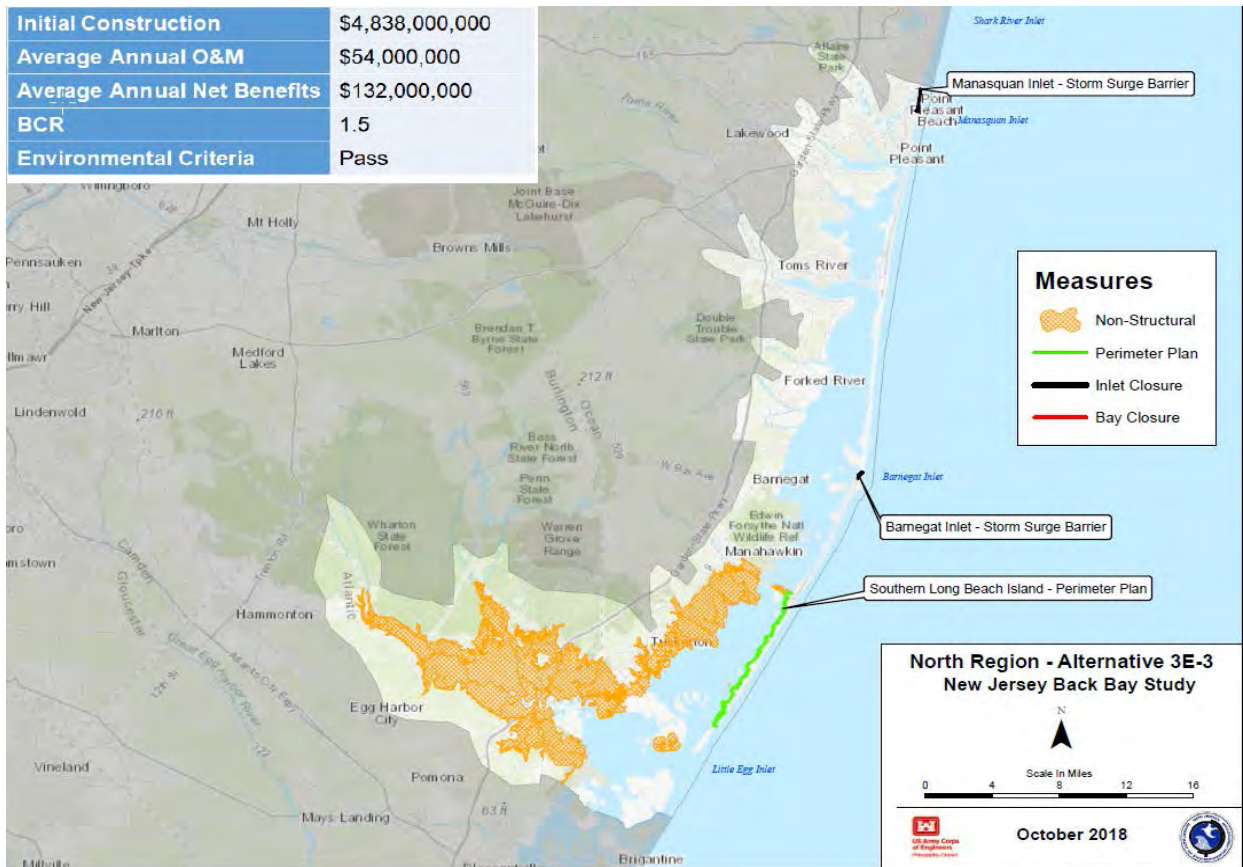

Figure 10-6: North Region Alternative 3E(3) Management Measure Features (Note: Approximate, preliminary locations)

10.3.5 Central Region

Analyses for the Central Region have indicated a preliminary combination of storm surge barriers, interior bay closures, nonstructural (including structure elevation only at this point in the study) and floodwalls/levees solutions to address coastal storm risk for the Reed Bay and Absecon Bay areas backing Brigantine, Lakes Bay and Scull Bay backing Absecon Island, and the Great Egg Harbor Bay System backing Peck Island (Ocean City).

The Central Region of the NJBB Study Area is probably the most complicated and includes thirteen alternative plans in the preliminary focused array within four themes. Theme 1 constitutes Alternative 4A which considers only nonstructural solutions. Theme 2 includes Alternatives 4D(1) and 4D(2) which considers floodwalls/levees and nonstructural solutions. Theme 3 includes Alternatives 4E(2) 4E(3), and 4E(4) which includes both storm surge barriers at inlets, interior bay closures, nonstructural solutions and floodwalls/levees. Theme 4 includes Alternatives 4G(6) through 4G(12) which includes both storm surge barriers at inlets, interior bay closures, nonstructural solutions and floodwalls/levees, as well as the no action alternative for some areas. A more detailed description of these alternative plans is provided below.

Alternative 4A

This preliminary alternative plan includes only nonstructural solutions for 8,744 residential structures. No storm surge barriers, interior bay closures or floodwalls/levees are included in this alternative. The management measure features of this alternative plan are provided in **Figure 10-7**.

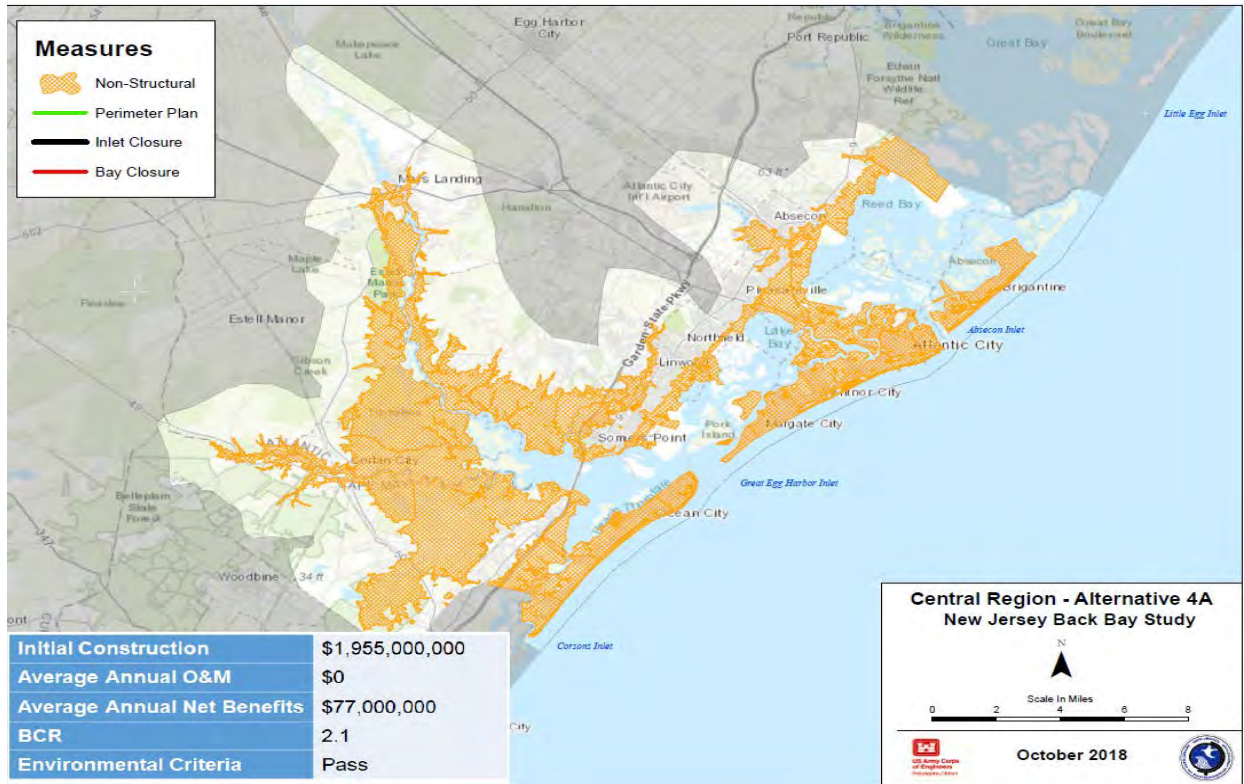

Figure 10-7: Central Region Alternative 4A Management Measure Features (Note: Approximate, preliminary locations)

Alternatives 4D(1) and 4D(2)

A preliminary strategy was developed for Alternatives 4D(1) and 4D(2) to focus on managing the risk of coastal flooding and sea level rise in the Central Region of the NJBB study area. These alternative plans include nonstructural and floodwall/levee solutions. These alternative plans do not include storm surge barriers or interior bay closures due to reduced economic justification due to greater initial construction costs and lower AANB compared to nonstructural and floodwall/levee solutions. Alternative 4D(1) includes nonstructural solutions for 1,928 residential structures for: a) the municipalities on the mainland adjacent to Reed Bay, Lake Bay and Great Egg Harbor Bay and associated tributaries including the Mullica River; and b) Brigantine Island. Alternative 4D(1) also includes greater than 65 miles of floodwalls inclusive of 11 miter gates and 15 road closures and approximately 6 miles of levees along the backside of Absecon Island and Ocean City.

Alternative 4D(2) differs from Alternative 4D(1) in that coastal flood risk is managed at Brigantine through floodwall and levee solutions rather than nonstructural solutions. Floodwall and levee solutions on Brigantine includes approximately 18 miles of floodwalls with 1 miter gate and 5 road closures and approximately a minimal length of levees. This alternative plan includes nonstructural solutions for 901 residential structures. The management measure features of this alternative plan are provided in **Figure 10-8** and **Figure 10-9**.

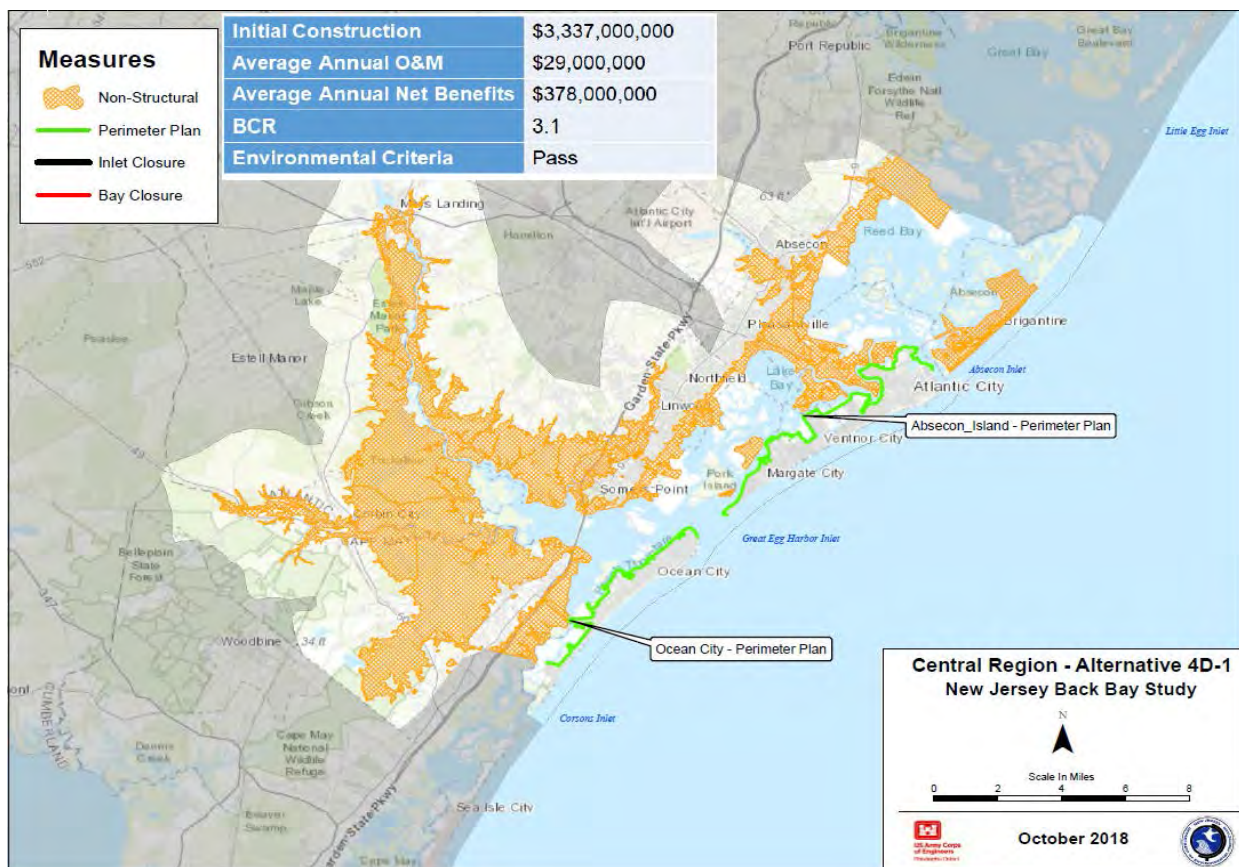

Figure 10-8: Central Region Alternative 4D(1) Management Measure Features (Note: Approximate, preliminary locations)

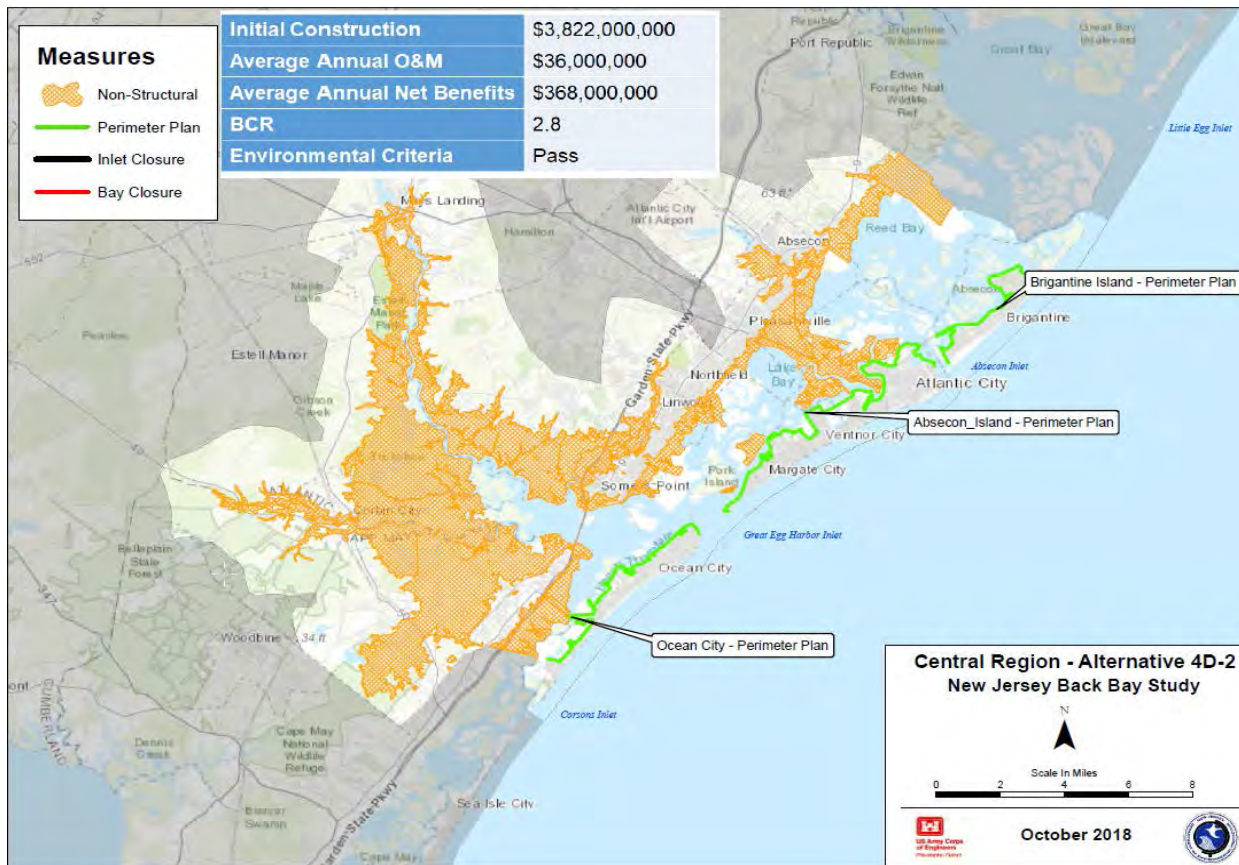

Figure 10-9: Central Region Alternative 4D(2) Management Measure Features (Note: Approximate, preliminary locations)

Alternatives 4E(2), 4E(3), and 4E(4)

A preliminary strategy was developed for Alternatives 4E(2), 4E(3) and 4E(4) to focus on managing the risk of coastal flooding and sea level rise in the Central Region of the NJBB study area. These alternative plans include storm surge barriers located at both Absecon Inlet and Great Egg Harbor Inlet. Detailed quantities for each of these storm surge barriers can be found in the Civil Engineering Sub-Appendix. Detailed hydrodynamic modeling results for storm surge barriers can be found in the Hydrology, Hydraulics and Coastal Engineering Sub-Appendix. Each of these alternative plans include nonstructural solutions for the mainland shorelines of the Municipality of Absecon fronting Reeds Bay. The remaining difference between these three alternative plans is the strategy identified for southern Ocean City and adjacent portions of Upper Township on the mainland side of the NJ Intracoastal Waterway between Peck bay and Corson Sound.

Alternative 4E(2) includes nonstructural solutions for this area while Alternative 4E(3) includes nonstructural solutions for the Upper Township portion and a floodwall/levee solution for the Ocean City portion. Alternative 4E(4) includes an interior bay closure for this area rather than nonstructural or floodwall/levee solutions. The management measure features of this alternative plan are provided in **Figure 10-10**, **Figure 10-11**, and **Figure 10-12**.

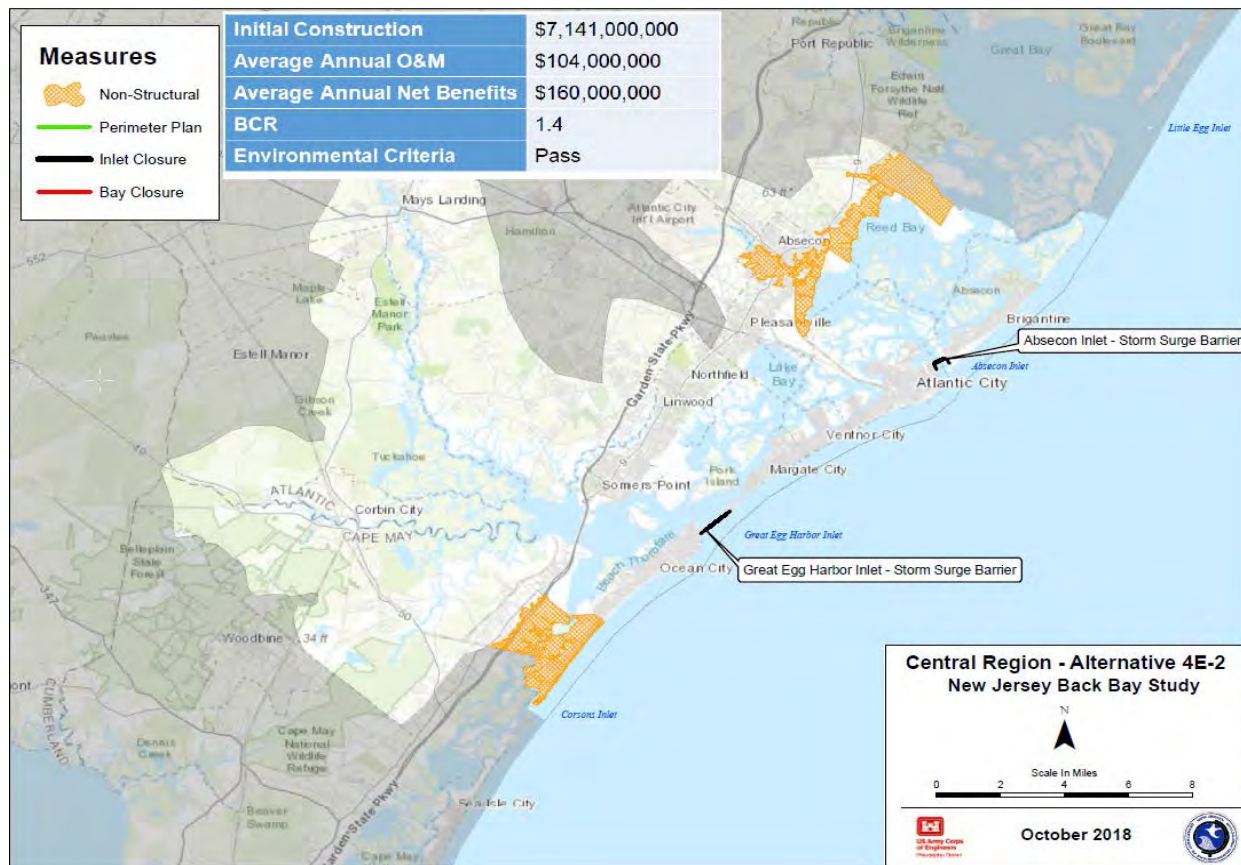

Figure 10-10: Central Region Alternative 4E(2) Management Measure Features (Note: Approximate, preliminary locations)

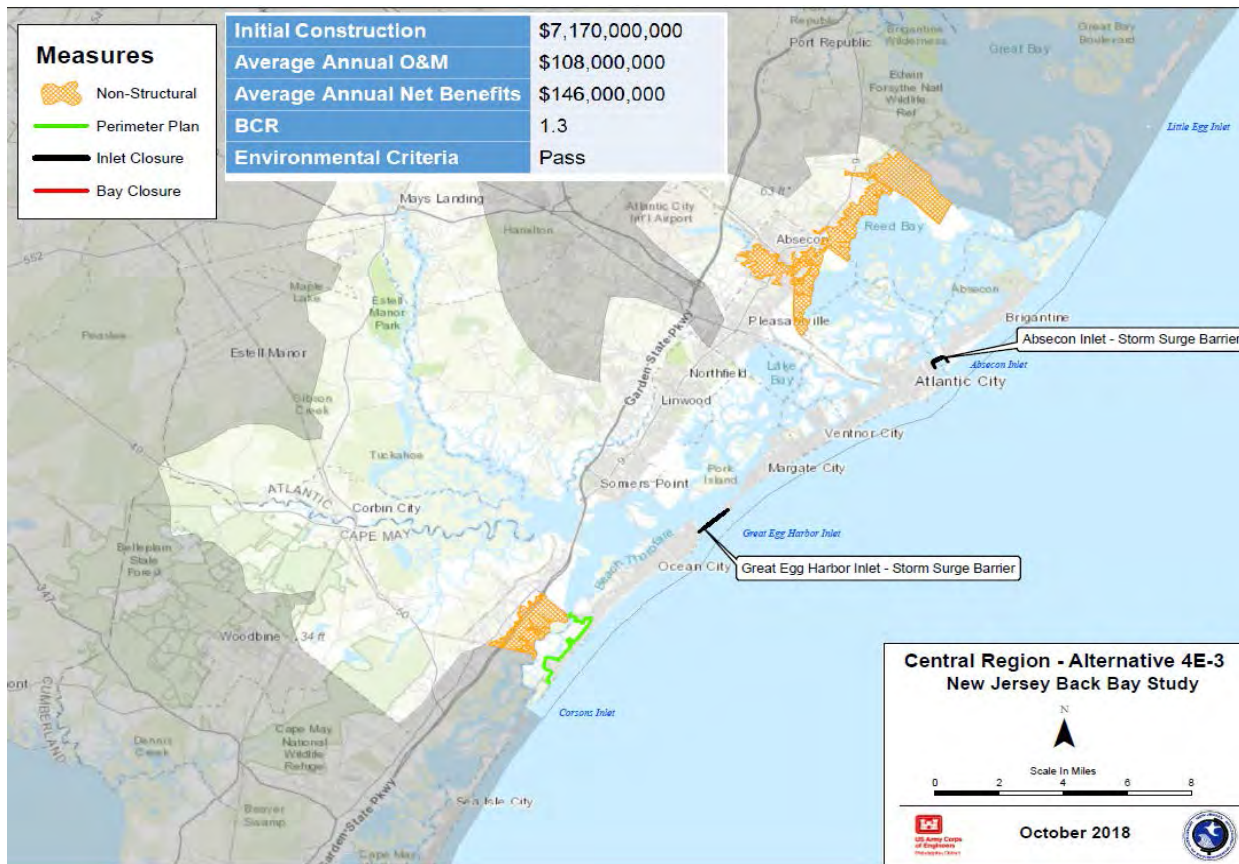

Figure 10-11: Central Region Alternative 4E(3) Management Measure Features (Note: Approximate, preliminary locations)

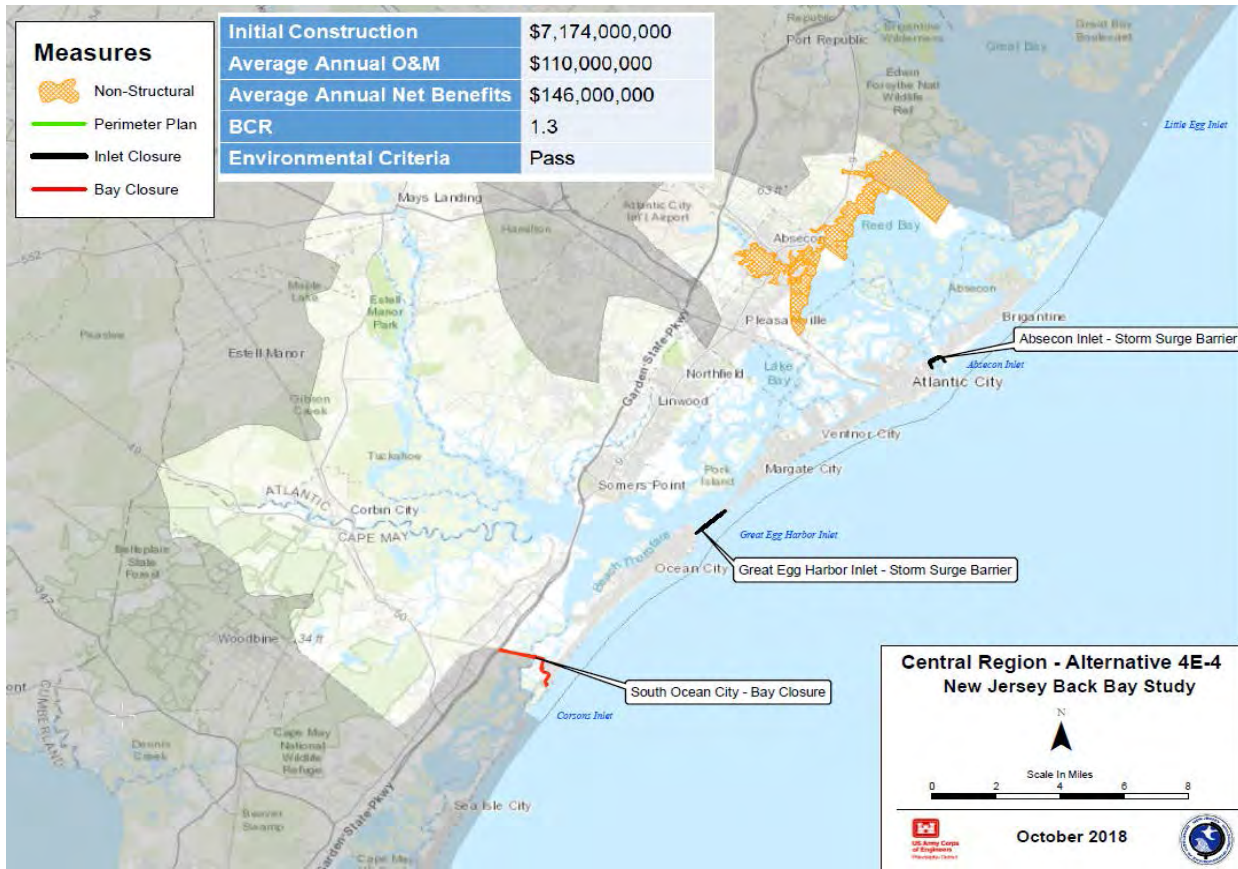

Figure 10-12: Central Region Alternative 4E(4) Management Measure Features (Note: Approximate, preliminary locations)

Alternatives 4G(6) through 4G(12)

A preliminary strategy was developed for Alternatives 4G(6) through 4G(12) to focus on managing the risk of coastal flooding and sea level rise in the Central Region of the NJBB study area. These alternative plans include storm surge barriers located only at Great Egg Harbor Inlet. Each of these alternative plans include an interior bay closure at Absecon Blvd between Atlantic City and Pleasantville and nonstructural solutions for the mainland shorelines of the Municipality of Absecon fronting Reeds Bay. The remaining differences between these alternative plans include: a) nonstructural solutions or floodwall/levee solutions at Brigantine; and b) a combination of interior bay closure, nonstructural or floodwall/levee solutions at southern Ocean City and southern Upper Township on the mainland side of the NJ Intracoastal Waterway between Peck bay and Corson Sound. The management measure features of this alternative plan are provided in **Figure 10-13** and **Figure 10-14**.

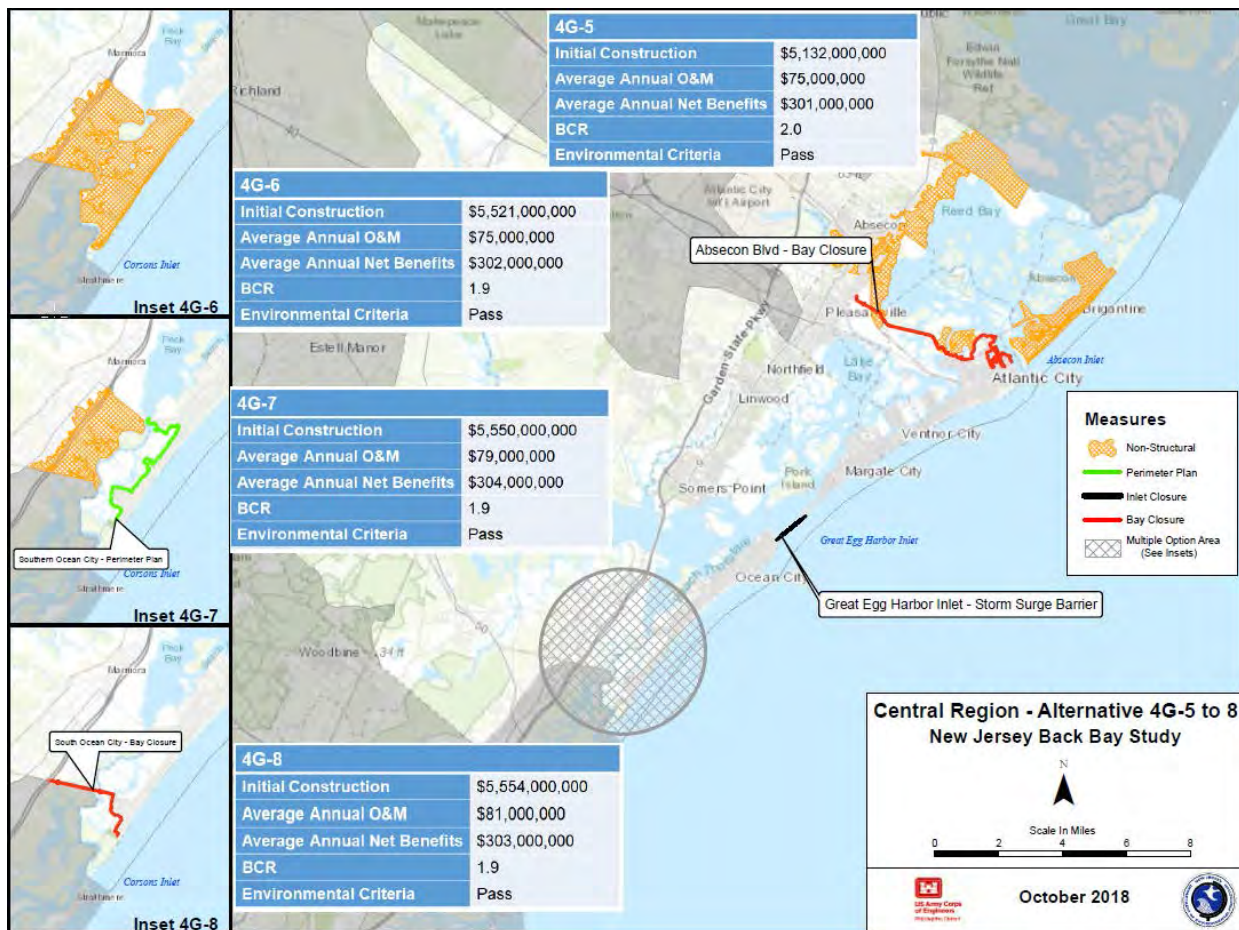

Figure 10-13: Central Region Alternatives 4G(6) through 4G(8) Management Measure Features (Note: Approximate, preliminary locations)

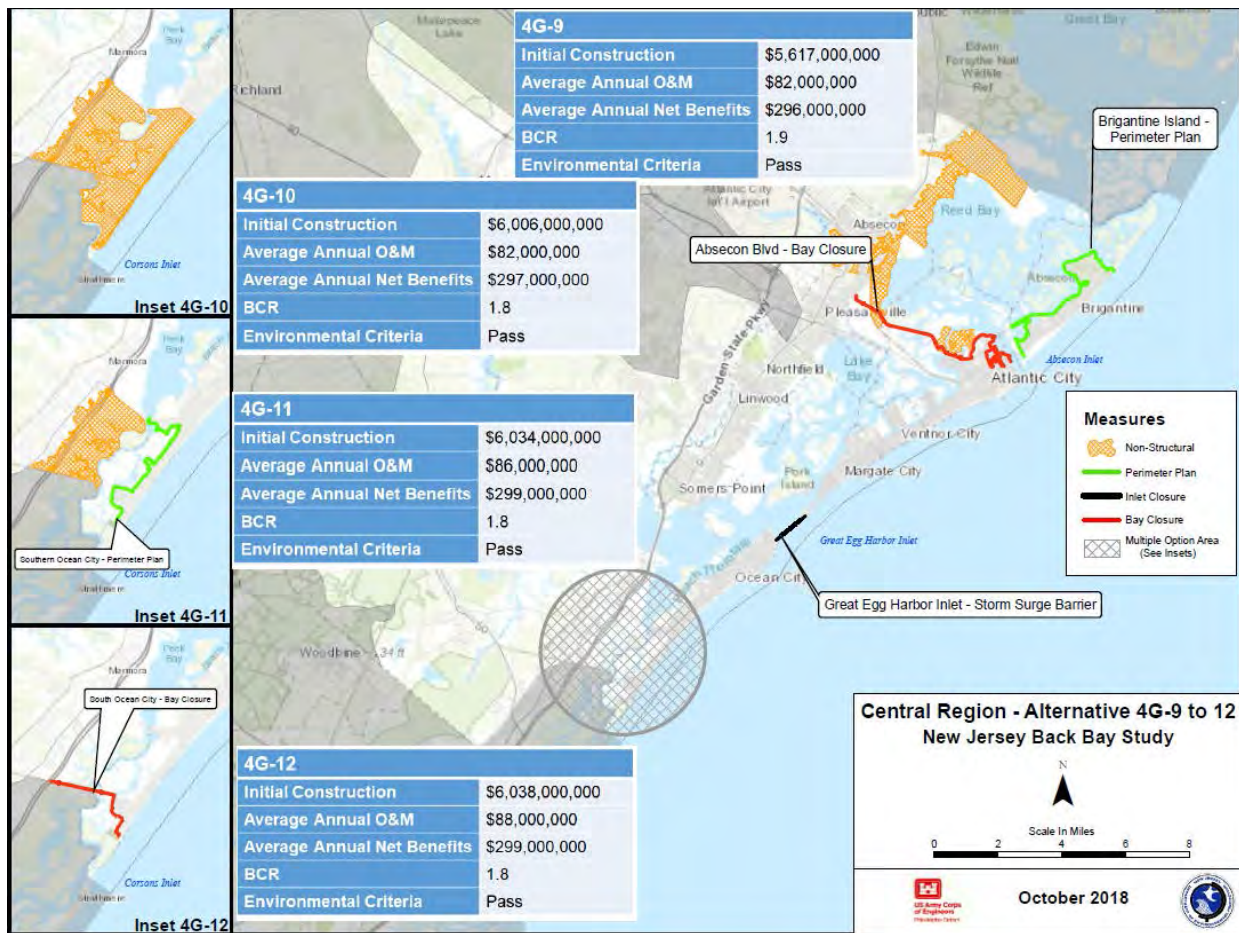

Figure 10-14: Central Region Alternatives 4G(9) through 4G(12) Management Measure Features (Note: Approximate, preliminary locations)

10.3.6 South Region

Analyses for the South Region have indicated a preliminary combination of nonstructural and floodwalls/levees solutions to address coastal storm risk for the Ludlam Bay and Townsend Sound backing Ludlam Island (Sea Isle City), Great Sounds and Jenkins Sound backing Seven Mile Island (Avalon and Stone Harbor), Grassy Sound, Richardson Sound and Jarvis Sound backing Wildwood Island, and Cape May Harbor backing the Cape May Peninsula. Detailed quantities for floodwall/levee solutions can be found in the Civil Engineering Sub-Appendix.

The South Region of the NJBB Study Area includes three preliminary alternatives in the preliminary focused array of alternative plans within two themes. Theme 1 constitutes Alternative 5A which considers only nonstructural solutions. Theme 2 includes Alternatives 5D(1) and 5D(2) which considers floodwalls/levees and nonstructural solutions. A more detailed description of these alternative plans is provided below.

Alternative 5A

The preliminary strategy developed for Alternative 5A includes nonstructural solutions for 6,389 residential structures for the municipalities on the mainland adjacent to the back bays stretching from Corson Inlet to Cape May and associated tributaries and canals inclusive of the Cape May Canal. No storm surge barriers or interior bay closures, or floodwalls/levees are included in this alternative plan. The management measure features of this alternative plan are provided in **Figure 10-15**.

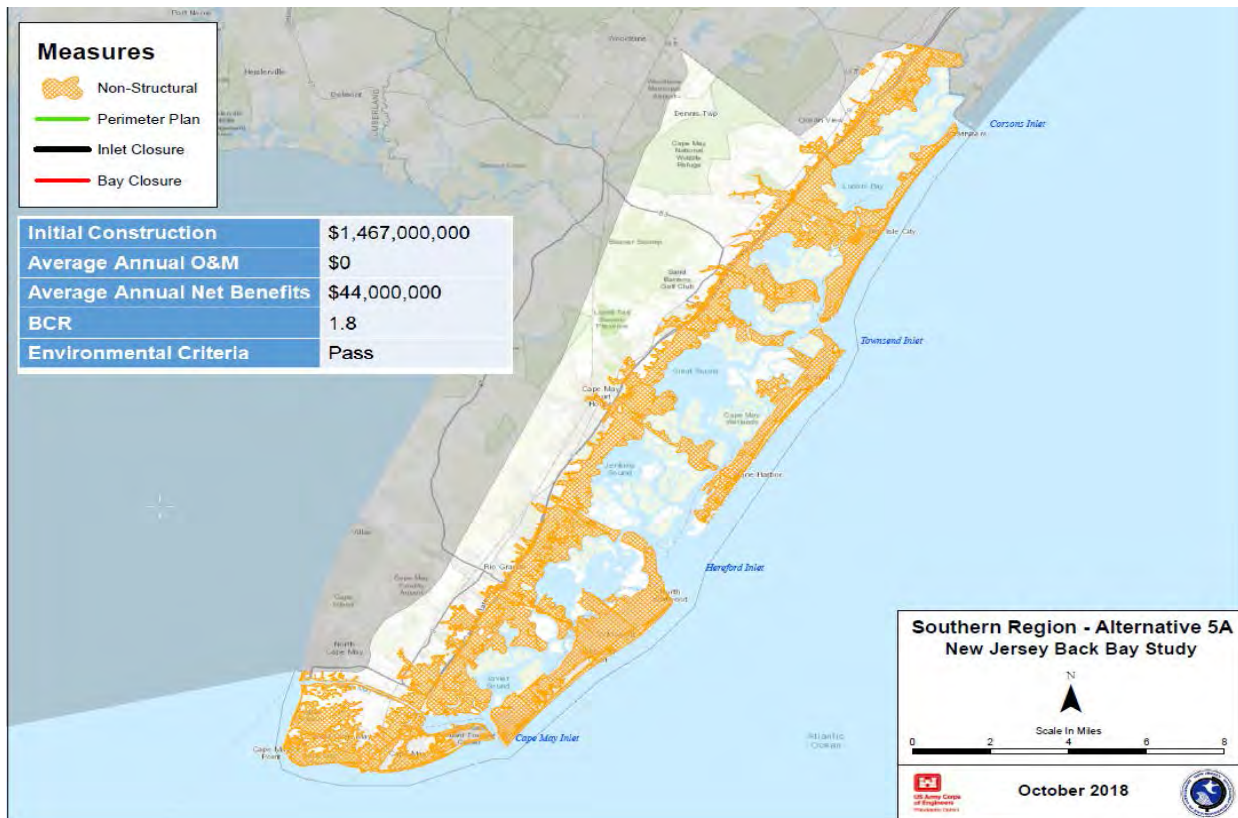

Figure 10-15: South Region Alternative 5A Management Measure Features (Note: Approximate, preliminary locations)

Alternatives 5D(1) and 5D(2)

A preliminary strategy was developed for Alternatives 5D(1) and 5D(2) to focus on managing the risk of coastal flooding and sea level rise in the South Region of the NJBB study area. These alternative plans include nonstructural and floodwall/levee solutions. These alternative plans do not include storm surge barriers owing in part to the close spacing of inlets in the South Region allowing many possibilities for storm surge entry into the back bays.

Alternative 5D(1) includes nonstructural solutions for 1848 residential structures for: a) the municipalities on the mainland adjacent to the back bays stretching from Corson Inlet to Cape May inclusive of the Cape May Canal; and b) barrier island municipalities including Strathmere, Seven Mile Island, and Lower Township. Alternative 5D(1) also includes greater than 36 miles of floodwalls inclusive of 4 miter gates and 17 road closures and approximately 10 miles of levees along the backside of Sea Isle city, Wildwood Island (including West Wildwood) and Cape May City.

Alternative 5D(2) differs from Alternative 5D(1) in that coastal flood risk is managed at Seven Mile Island through floodwall and levees solutions rather than nonstructural solutions. This includes approximately 35 miles of floodwalls with 2 miter gates and 9 road closures and approximately 1 mile of levees. This alternative plan includes nonstructural solutions for 544 residential structures. The management measure features of this alternative plan are provided in **Figure 10-16** and **Figure 10-17**.

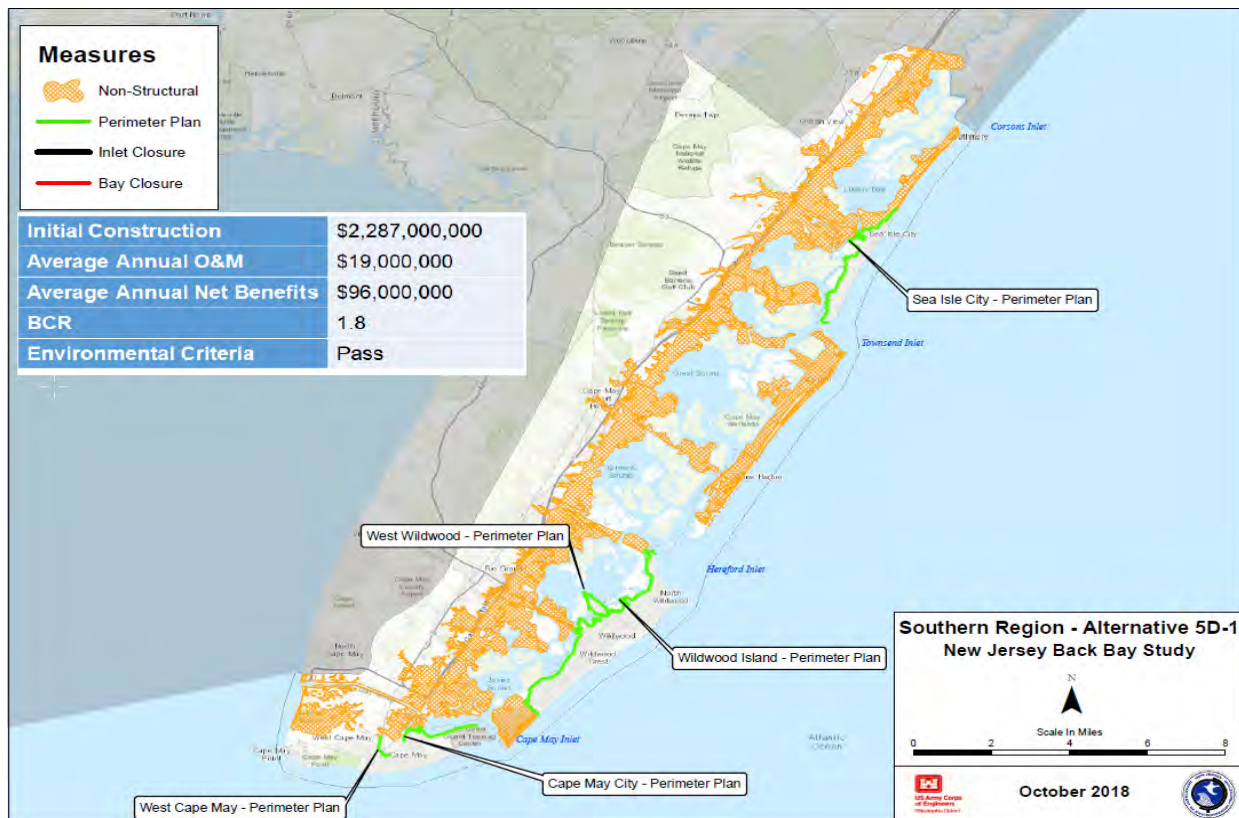

Figure 10-16: South Region Alternative 5D(1) Management Measure Features (Note: Approximate, preliminary locations)

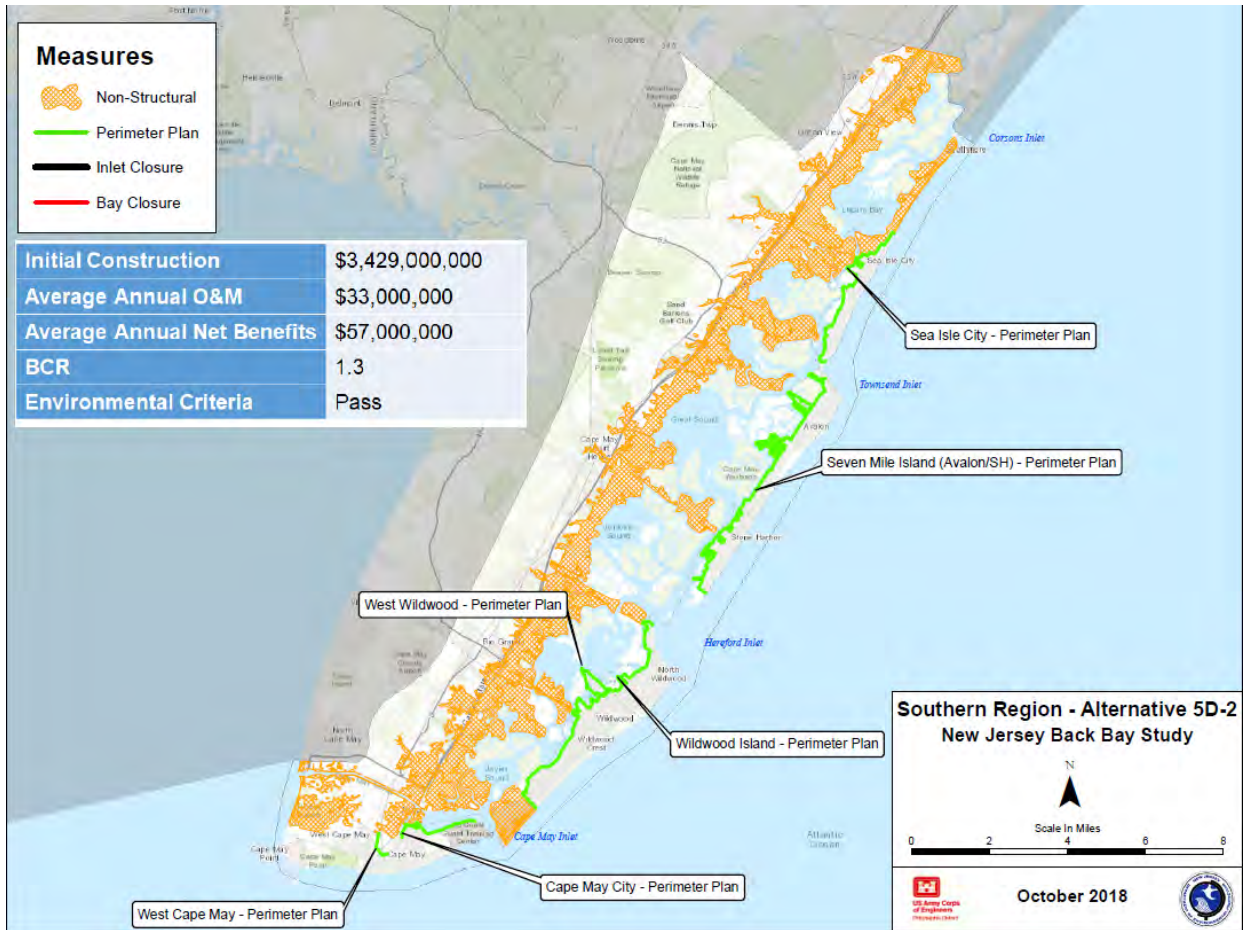

Figure 10-17: South Region Alternative 5D(2) Management Measure Features (Note: Approximate, preliminary locations)

10.4 Preliminary Focused Array Assumptions

This study is guided by the principle of iterative planning, which encourages risk-informed decision making and the appropriate levels of detail for each round of alternative plan formulation. The preliminary focused array of alternatives for the NJBB Region provided in this Interim Feasibility Study and Environmental Scoping Document have focused on identifying feasible system-wide CSRMs solutions. These focused array solutions are preliminary and are based on a lower level of detailed analyses at this phase of the study. As a result, a number of assumptions were made during the planning process, including:

- Economics
 - HEC-FDA to model economic benefits
 - Reduced sample size of structures given the large study area resulting in the development of assumptions with respect to structure type and first floor elevation height
 - Depreciated replacement value adjustment
- Engineering
 - Existing information utilized for engineering analyses rather than field-collected data at specific locations
 - Less level of detail of engineering analyses given the use of existing information
 - Parametric cost estimates application
- Environmental
 - Indirect impacts have not been identified resulting in preliminary understanding of comprehensive environmental impacts of measure features
 - NEPA compliance and cultural resource investigations are in progress and preliminary
- Plan formulation
 - Formulation of alternative plans including the preliminary focused array of alternative plans is preliminary based on the level of analyses discussed above.
- Real Estate
 - Widespread stakeholder/landowner approval of the project
 - Use of basic real estate assumptions including cost estimated for the level of project detail available
 - Real estate interests required for all project areas will be acquired for minimal appraised values once off-setting project benefits are applied

10.5 Future Planning Analyses

A greater level of detail of analysis will be applied to subsequent plan formulation efforts following this Interim Feasibility Study and Environmental Scoping Document. Additional detailed planning

analyses will be conducted towards developing a Draft Feasibility Report and Environmental Impact Statement and associated TSP in 2020, and a Final Feasibility Report and Environmental Impact Statement and associated recommended plan in 2021.

These additional planning analyses will continue towards the development of a comprehensive CSRM assessment for the entire NJBB Region towards managing the risk of coastal flooding and sea level rise to critical infrastructure, property and economic assets as well as maintaining sustainable cohesive resilient neighborhoods.

While the type of storm surge barrier, gates, and shoreline-based measures (floodwall vs levee, nonstructural, or natural and nature-based features) have preliminarily been identified in this report, more detailed analyses will help to refine system-wide solutions provided in this report to identify the best combination of measures (barriers, floodwalls, levees, pumps, nonstructural, and NNBFs) as well as associated environmental impacts and construction footprints. The Draft Feasibility Report and Environmental Impact Statement report in 2020 will also include explanations regarding the selection of the TSP and associated measures with respect to siting and implementation requirement descriptions.

Specific additional more detailed planning analyses to be performed during subsequent feasibility study phase analyses will include:

- Continued economic NED analyses of alternatives and ultimate selected plan;
- Continued assessment of the ability of CSRM measures to meet NJBB CSRM objectives and avoid constraints;
- Continued analyses to compare alternatives based on completeness, effectiveness, efficiency, and acceptability;
- Continued environmental analyses to consider factors such as impacts to habitat;
- Continued environmental analyses to consider factors such as impacts to habitat, salinity, circulation, endangered species, cultural resources or communities;
- Regional Economic Development (RED) benefit account analysis;
- OSE alternative plan scoring and ranking according to the Institute for Water Resources' handbook for Applying Other Social Effects in Alternatives Analysis (2013);
- Analysis to cite key risks and uncertainties associated with the plans, identify key tradeoffs among the alternatives;
- Analysis comparing and documenting the with-project condition for each alternative plan to the without-project condition;
- Detailed assessment of different USACE sea level change scenarios to more comprehensively formulate measures and selected plan;
- Incorporation and integration of Federal and state agency, stakeholder and public comments and efforts into subsequent planning analyses and feasibility report drafts, and;
- Completion of 30% Design Real Estate Plan (REP), to include complete review of project area real estate as shown on 30% plans. REP will consider real estate interests required, numbers of parcels and landowners in the acquisition area, utilities

and other relocations that may be required, the possibility of additional compensable interests, and the inclusion of outstanding probable/possible real estate risks that may impact the project through 100% design, as well as provide a gross estimate of land and ancillary costs.

Following the incorporation of public, stakeholder and agency comments on the Draft Integrated Feasibility Report and EIS in 2020, and subsequent approval by HQUSACE, the TSP will be optimized including the maximization of net benefits. While the footprint of the alternative is not expected to change, other design criteria including the height and design quantities may change and more cost effective ways to achieve the target level of risk reduction may be considered. The Final Feasibility Report and EIS will be developed after the optimization period.

10.6 Environmental Considerations of the Preliminary Focused Array

At this stage of the feasibility study and NEPA analysis, accurate quantitative impact analyses are generally unavailable for a number of these alternatives due to the current preliminary low-level of design, and that detailed numerical modeling has not been applied at this point. Therefore, impact assessment is introduced in this section, and the general impacts and/or range of impacts are presented, as known, at this time. Early estimates of direct habitat impacts with respect to the preliminary focused array of alternative plans is provided in **Table 10-2**. However, impact “avoidance” and “minimization” have not been applied at this stage, which could affect these preliminary estimates. The Environmental and Cultural Resources Appendix F provides a more detailed discussion on environmental considerations on the preliminary focused array. Additionally, a preliminary conceptual model intended to articulate the mechanisms of environmental impact of proposed flood risk management alternatives, inform the NEPA process and transparently link actions to specific pieces of environmental policy and legislation, and to identify any gaps in quantitative tools needed for future impact assessment is being developed (**Figure 10-18**). This conceptual model is at an early stage, but will be further developed with research from relevant peer-reviewed literature, engagement with resource agency staff technical experts, and iterative development with USACE staff, which will help guide the impact analyses and development of numerical modeling leading up to the TSP and Draft EIS.

The No Action alternative (Future without Project Condition) would involve no additional action from current USACE actions to mitigate against coastal storm risk. Some generalized assumptions for the array of alternatives are that no action will continue existing environmental trends unless significant changes are implemented such as regulatory changes, development policies related to land use, and natural events with awareness of current knowledge of climate change and sea level rise as a major driving force.

For structural measures in the array, the perimeter plans are expected to have significant direct impacts particularly on wetlands and shallow aquatic habitats within the footprint of floodwalls and levees over long linear distances, which would have regional effects. Additionally, perimeters are expected to have significant impacts on visual resources. The inlet storm surge barriers and interior bay closures would have moderate to significant direct impacts on aquatic habitats, but comparatively less than the perimeter plans. However, there may be more potential indirect impacts that storm surge barriers and interior bay closures may pose on hydrodynamics, water quality, and shifts in flora and fauna abundance, distributions and migrations. These potential effects have a high level of uncertainty particularly with the unknown frequency of gate closures

coupled with changes in tidal flooding events related to sea level rise. This would require further modeling efforts to inform the impact assessment of storm surge barriers and interior bay closures. As part of the TSP phase, the preliminary focused array of alternative plans will undergo a rigorous evaluation of avoidance and minimization of these direct and indirect impacts; however, based on the scale of these alternatives, it is likely that substantial compensatory mitigation would be required.

Nonstructural measures are a component for all of the preliminary focused array of alternative plans either as a standalone alternative or in various combinations with other structural components. At this point, the preliminary focused array has only evaluated building elevation, which may have some temporary adverse direct and indirect effects related to earth disturbance, but are not significant. However, impacts on cultural resources (particularly if building modifications are on historic structures or in a historic district) and community or other social effects are potentially significant. Other nonstructural measures such as building acquisition and relocation and flood-proofing have not been evaluated at this point, but will be considered in the next phase prior to the identification of the TSP. A measure like building acquisition and relocation could provide significant environmental benefit by increasing open space by converting existing privately owned and buildable properties into natural habitat. However, as is the case with building elevation (retrofit), there is a potential for significant adverse impacts to cultural resources and other social effects

NNBFs would need to have a direct CSRSM function for flooding and/or function as a scour protection feature of a traditional structural CSRSM feature while providing ecological uplift. NNBFs would help in slowing storm surges and dissipating wave energies. These features would promote resilience, and be adaptable to climate change and sea level rise. Some considerations for NNBF features include island creation, saltmarsh creation, SAV restoration or reefs, and possibly combinations, thereof. The selection of locations for NNBFs require the consideration of the existing habitat values for fish and wildlife resources. NNBFs are expected to have temporary and minor impacts on aquatic resources and water quality during their construction, but would have a long-term beneficial effect on aquatic and some terrestrial habitats and the flora and fauna that inhabit these areas. However, NNBFs have not been evaluated at this point, but will be considered in the next phase prior to the identification of the TSP.

Table 10-2: Preliminary Environmental Considerations of the Preliminary Focused Array of Alternatives

REGION	ALT	NONSTRUCTURAL Building Elevation for structures with first floor w/in 20-yr floodplain	PERIMETER Floodwalls, Levees and Miter Gates	STORM SURGE BARRIER Inlet Navigable Sector Gates, Auxiliary Lift Gates, Impermeable Barriers, Levees	BAY CLOSURE Navigable Sector Gates, Auxiliary Lift Gates, Miter Gates, Sluice Gates, Impermeable Barriers, Levees
SHARK RIVER	2A	Location: Portions of Belmar, Bradley Beach, Neptune City & Shark River Hills Env. Considerations: Potential impacts to community, cultural resources, noise. Mitigation: None likely.	NA	NA	NA
NORTH (Manasquan Inlet to Brigantine Inlet)	3A	Location: Point Pleasant, Manasquan, all communities on LBI, western shore of Barnegat Bay, Mystic Island, and along lower Mullica River Basin Env. Considerations: Potential impacts to community, cultural resources, noise Mitigation: None likely.	NA	NA	NA
	3D	Location: All communities on LBI, western shore of Barnegat Bay, Mystic Island, and along lower Mullica River Basin Env. Considerations: Potential impacts to community, cultural resources, noise Mitigation: None likely.	Location: Manasquan Inlet/ Point Pleasant Area Env. Considerations: Temporary turbidity, air quality, noise, community disruption. Moderate permanent losses of soft bottom subtidal (9 ac.), tidal marsh (3 ac.). Moderate impacts to fish and wildlife. ESA consultation likely due to levee structure on Manasquan Beach. Obstruction of viewsheds. Mitigation: Moderate	NA	NA
	3E(2)	Location: All communities on southern LBI (Cedar Bonnet Island and south), western shore of Barnegat Bay at Beach Haven West and south, Mystic Island, and along lower Mullica River Basin Env. Considerations: Potential impacts to community, cultural resources, noise Mitigation: None likely.	NA	Location: Manasquan Inlet and Barnegat Inlet Env. Considerations: Temporary turbidity, air quality, noise. Moderate permanent losses of soft bottom subtidal (8 ac.). ESA consultation likely due to levee structure on Manasquan Beach and dune tie-ins in Barnegat Inlet. Potential indirect significant impacts to hydrodynamics, water quality and fish/shellfish and wildlife. Obstruction of viewsheds in inlets. Mitigation: Moderate for Direct Impacts and Potentially High for Indirect Impacts	NA

REGION	ALT	NONSTRUCTURAL Building Elevation for structures with first floor w/in 20-yr floodplain	PERIMETER Floodwalls, Levees and Miter Gates	STORM SURGE BARRIER Inlet Navigable Sector Gates, Auxiliary Lift Gates, Impermeable Barriers, Levees	BAY CLOSURE Navigable Sector Gates, Auxiliary Lift Gates, Miter Gates, Sluice Gates, Impermeable Barriers, Levees
	3E(3)	Location: Cedar Bonnet Island, western shore of Barnegat Bay at Beach Haven West and south, Mystic Island, and along lower Mullica River Basin Env. Considerations: Potential impacts to community, cultural resources, noise Mitigation: None likely.	Location: Along western side of S. LBI from Ship Bottom to Holgate Env. Considerations: Temporary turbidity, air quality, noise, community disruption. Significant permanent losses of soft bottom subtidal (76 acres), SAV beds (11 ac.), intertidal flats (24 ac.), tidal marsh (21 ac.), scrub-shrub (5 ac ac). Significant impacts to fish/shellfish and wildlife. Obstruction of viewsheds. Mitigation: Very High	Location: Manasquan Inlet and Barnegat Inlet Env. Considerations: Temporary turbidity, air quality, noise. Moderate permanent losses of soft bottom subtidal (8 ac.). ESA consultation likely due to levee structure on Manasquan Beach and dune tie-ins in Barnegat Inlet. Potential indirect significant impacts to hydrodynamics, water quality and fish/shellfish and wildlife. Obstruction of viewsheds in inlets. Mitigation: Moderate for Direct Impacts and Potentially High for Indirect Impacts	NA
CENTRAL (Brigantine Inlet to Corson Inlet)	4A	Location: Brigantine, Absecon, Pleasantville, West A.C., A.C., Ventnor, Margate, Longport, Northfield, Linwood, Estelle Manor, Mays Landing, Somers Point, Marmora, Ocean City, Palermo Env. Considerations: Potential impacts to community, cultural resources, noise Mitigation: None likely.	NA	NA	NA
	4D(1)	Location: Brigantine, Absecon, Pleasantville, West A.C., Northfield, Linwood, Estelle Manor, Mays Landing, Somers Point, Marmora, Palermo Env. Considerations: Potential impacts to community, cultural resources, noise Mitigation: None likely.	Location: Along Absecon Inlet and western side of A.C., Ventnor, Margate, Longport, & Ocean City Env. Considerations: Temporary turbidity, air quality, noise, community disruption. Significant permanent losses of soft bottom subtidal (96 ac.), intertidal flats (27 ac.), tidal marsh (63 ac.), scrub-shrub (10 ac.). Significant impacts to fish/shellfish and wildlife. Obstruction of viewsheds. Mitigation: Very High	NA	NA
	4D(2)	Location: Absecon, Pleasantville, West A.C., Northfield, Linwood, Estelle Manor, Mays Landing, Somers Point, Marmora, Palermo Env. Considerations: Potential impacts to community, cultural resources, noise Mitigation: None likely.	Location: Along Absecon Inlet and western side of Brigantine, A.C., Ventnor, Margate, Longport, & Ocean City Env. Considerations: Temporary turbidity, air quality, noise, community disruption. Significant permanent losses of soft bottom subtidal (112 ac.), intertidal flats (38 ac.), tidal marsh (83 ac.), scrub-shrub (11 ac.).	NA	NA

REGION	ALT	NONSTRUCTURAL Building Elevation for structures with first floor w/in 20-yr floodplain	PERIMETER Floodwalls, Levees and Miter Gates	STORM SURGE BARRIER Inlet Navigable Sector Gates, Auxiliary Lift Gates, Impermeable Barriers, Levees	BAY CLOSURE Navigable Sector Gates, Auxiliary Lift Gates, Miter Gates, Sluice Gates, Impermeable Barriers, Levees
			Significant impacts to fish/shellfish and wildlife. Obstruction of viewsheds. Mitigation: Very High		
	4E(2)	Location: Absecon, Pleasantville, S. Ocean City, Marmora, & Palermo Env. Considerations: Potential impacts to community, cultural resources, noise Mitigation: None likely.	NA	Location: Absecon Inlet & Great Egg Harbor Inlet Env. Considerations: Temporary turbidity, air quality, noise. Moderate permanent losses of soft bottom subtidal (24 ac.) and intertidal flats (5 ac.). ESA consultation likely due to dune tie-ins in both inlets. Potential indirect significant impacts to hydrodynamics, water quality and fish/shellfish and wildlife. Obstruction of viewsheds in inlets. Mitigation: Moderate for Direct Impacts and Potentially High for Indirect Impacts	NA
	4E(3)	Location: Absecon, Pleasantville, Marmora, & Palermo Env. Considerations: Potential impacts to community, cultural resources, noise Mitigation: None likely.	Location: Western side of S. Ocean City Env. Considerations: Temporary turbidity, air quality, noise, community disruption. Significant permanent losses of soft bottom subtidal (26 ac.), intertidal flats (5 ac.), tidal marsh (33 ac.), scrub-shrub (4 ac.). Significant impacts to fish/shellfish and wildlife. Obstruction of viewsheds. Mitigation: High	Location: Absecon Inlet & Great Egg Harbor Inlet Env. Considerations: Temporary turbidity, air quality, noise. Moderate permanent losses of soft bottom subtidal (24 ac.) and intertidal flats (5 ac.). ESA consultation likely due to dune tie-ins in both inlets Potential indirect significant impacts to hydrodynamics, water quality and fish/shellfish and wildlife. Obstruction of viewsheds in inlets. Mitigation: Moderate for Direct Impacts and Potentially High for Indirect Impacts	NA
	4E(4)	Location: Absecon & Pleasantville Env. Considerations: Potential impacts to community, cultural resources, noise Mitigation: None likely.	NA	Location: Absecon Inlet & Great Egg Harbor Inlet Env. Considerations: Temporary turbidity, air quality, noise. Moderate permanent losses of soft bottom subtidal (24 ac.) and intertidal flats (5 ac.). ESA consultation likely due to dune tie-ins in both inlets. Potential indirect significant impacts to hydrodynamics, water quality and	Location: Cross bay barrier in S. Ocean City from 52 nd St. Env. Considerations: Temporary turbidity, air quality, noise. Significant permanent losses of soft bottom subtidal (26 ac.), intertidal flats (5 ac.), tidal marsh (22 ac.), scrub-shrub (1 ac.). Significant impacts to fish/shellfish and wildlife. Potential indirect significant

REGION	ALT	NONSTRUCTURAL Building Elevation for structures with first floor w/in 20-yr floodplain	PERIMETER Floodwalls, Levees and Miter Gates	STORM SURGE BARRIER Inlet Navigable Sector Gates, Auxiliary Lift Gates, Impermeable Barriers, Levees	BAY CLOSURE Navigable Sector Gates, Auxiliary Lift Gates, Miter Gates, Sluice Gates, Impermeable Barriers, Levees
				fish/shellfish and wildlife. Obstruction of viewsheds in inlets. Mitigation: Moderate for Direct Impacts and Potentially High for Indirect Impacts	impacts to hydrodynamics, water quality and fish/shellfish and wildlife. Obstruction of viewsheds in inlets. Mitigation: Moderate for Direct Impacts and Potentially High for Indirect Impacts
	4G(6)	Location: Brigantine, Absecon, Pleasantville, West A.C., Marmora, S. Ocean City, Palermo, Env. Considerations: Potential impacts to community, cultural resources, noise Mitigation: None likely.	NA	Location: Great Egg Harbor Inlet Env. Considerations: Temporary turbidity, air quality, noise. Moderate permanent losses of soft bottom subtidal (18 acres). ESA consultation likely due to dune tie-ins in inlet. Potential indirect significant impacts to hydrodynamics, water quality and fish/shellfish and wildlife. Obstruction of viewsheds in inlets. Mitigation: Moderate for Direct Impacts and Potentially High for Indirect Impacts	Location: Cross bay barrier along S. Absecon Inlet and Absecon Blvd. Env. Considerations: Temporary turbidity, air quality, noise. Significant permanent losses of soft bottom subtidal (39 ac.), intertidal flats (6 ac.), tidal marsh (52 ac.), scrub-shrub (2 ac.). Significant impacts to fish/shellfish and wildlife. Potential indirect significant impacts to hydrodynamics, water quality and fish/shellfish and wildlife. Obstruction of viewsheds in inlets. Mitigation: High for Direct Impacts and Potentially High for Indirect Impacts
	4G(7)	Location: Brigantine, Absecon, Pleasantville, West A.C., Marmora Env. Considerations: Potential impacts to community, cultural resources, noise Mitigation: None likely.	Location: Western side of S. Ocean City Env. Considerations: Temporary turbidity, air quality, noise, community disruption. Significant permanent losses of soft bottom subtidal (26 ac.), intertidal flats (5 ac.), tidal marsh (33 ac.), scrub-shrub (4 ac.). Significant impacts to fish/shellfish and wildlife. Obstruction of viewsheds. Mitigation: High	Location: Great Egg Harbor Inlet Env. Considerations: Temporary turbidity, air quality, noise. Moderate permanent losses of soft bottom subtidal (18 acres). ESA consultation likely due to dune tie-ins in inlet. Potential indirect significant impacts to hydrodynamics, water quality and fish/shellfish and wildlife. Obstruction of viewsheds in inlets. Mitigation: Moderate for Direct Impacts and Potentially High for Indirect Impacts	Location: Cross bay barrier along S. Absecon Inlet and Absecon Blvd Env. Considerations: Temporary turbidity, air quality, noise. Significant permanent losses of soft bottom subtidal (39 ac.), intertidal flats (6 ac.), tidal marsh (52 ac.), scrub-shrub (2 ac.). Significant impacts to fish/shellfish and wildlife. Potential indirect significant impacts to hydrodynamics, water quality and fish/shellfish and wildlife. Obstruction of viewsheds in inlets. Mitigation: High for Direct Impacts and Potentially High for Indirect Impacts
	4G(8)	Location: Brigantine, Absecon, Pleasantville, West A.C., Env. Considerations: Potential impacts to community, cultural resources, noise Mitigation: None likely.	NA	Location: Great Egg Harbor Inlet Env. Considerations: Temporary turbidity, air quality, noise. Moderate permanent losses of soft bottom subtidal (18 acres). ESA consultation likely due to dune tie-ins in inlet. Potential indirect significant impacts to hydrodynamics, water quality and	Location: Cross bay barrier along S. Absecon Inlet and Absecon Blvd Env. Considerations: Temporary turbidity, air quality, noise. Significant permanent losses of soft bottom subtidal (39 ac.), intertidal flats (6 ac.), tidal marsh (52 ac.), scrub-shrub (2 ac.).

REGION	ALT	NONSTRUCTURAL Building Elevation for structures with first floor w/in 20-yr floodplain	PERIMETER Floodwalls, Levees and Miter Gates	STORM SURGE BARRIER Inlet Navigable Sector Gates, Auxiliary Lift Gates, Impermeable Barriers, Levees	BAY CLOSURE Navigable Sector Gates, Auxiliary Lift Gates, Miter Gates, Sluice Gates, Impermeable Barriers, Levees
				fish/shellfish and wildlife. Obstruction of viewsheds in inlets. Mitigation: Moderate for Direct Impacts and Potentially High for Indirect Impacts	Significant impacts to fish/shellfish and wildlife. Potential indirect significant impacts to hydrodynamics, water quality and fish/shellfish and wildlife. Obstruction of viewsheds in inlets. Mitigation: High for Direct Impacts and Potentially High for Indirect Impacts
	4G(10)	Location: Absecon, Pleasantville, West A.C., Marmora, S. Ocean City, Palermo Env. Considerations: Potential impacts to community, cultural resources, noise Mitigation: None likely.	Location: Western side of Brigantine Env. Considerations: Location: Western side of S. Ocean City Env. Considerations: Temporary turbidity, air quality, noise, community disruption. Significant permanent losses of soft bottom subtidal (15 ac.), intertidal flats (12 ac.), tidal marsh (20 ac.), scrub-shrub (0.1 ac.). Significant impacts to fish/shellfish and wildlife. Obstruction of viewsheds. Mitigation: High	Location: Great Egg Harbor Inlet Env. Considerations: Temporary turbidity, air quality, noise. Moderate permanent losses of soft bottom subtidal (18 acres). ESA consultation likely due to dune tie-ins in inlet. Potential indirect significant impacts to hydrodynamics, water quality and fish/shellfish and wildlife. Obstruction of viewsheds in inlets. Mitigation: Moderate for Direct Impacts and Potentially High for Indirect Impacts	Location: Cross bay barrier along S. Absecon Inlet and Absecon Blvd Env. Considerations: Temporary turbidity, air quality, noise. Significant permanent losses of soft bottom subtidal (39 ac.), intertidal flats (6 ac.), tidal marsh (52 ac.), scrub-shrub (2 ac.). Significant impacts to fish/shellfish and wildlife. Potential indirect significant impacts to hydrodynamics, water quality and fish/shellfish and wildlife. Obstruction of viewsheds in inlets. Mitigation: High for Direct Impacts and Potentially High for Indirect Impacts
	4G(11)	Location: Absecon, Pleasantville, West A.C., Marmora, Palermo Env. Considerations: Potential impacts to community, cultural resources, noise Mitigation: None likely.	Location: Western side of Brigantine and S. Ocean City Env. Considerations: Temporary turbidity, air quality, noise, community disruption. Significant permanent losses of soft bottom subtidal (16 ac.), intertidal flats (12 ac.), tidal marsh (53 ac.), scrub-shrub (4 ac.). Significant impacts to fish/shellfish and wildlife. Obstruction of viewsheds. Mitigation: High	Location: Great Egg Harbor Inlet Env. Considerations: Temporary turbidity, air quality, noise. Moderate permanent losses of soft bottom subtidal (18 acres). ESA consultation likely due to dune tie-ins in inlet. Potential indirect significant impacts to hydrodynamics, water quality and fish/shellfish and wildlife. Obstruction of viewsheds in inlets. Mitigation: Moderate for Direct Impacts and Potentially High for Indirect Impacts	Location: Cross bay barrier along S. Absecon Inlet and Absecon Blvd Env. Considerations: Temporary turbidity, air quality, noise. Significant permanent losses of soft bottom subtidal (39 ac.), intertidal flats (6 ac.), tidal marsh (52 ac.), scrub-shrub (2 ac.). Significant impacts to fish/shellfish and wildlife. Potential indirect significant impacts to hydrodynamics, water quality and fish/shellfish and wildlife. Obstruction of viewsheds in inlets. Mitigation: High for Direct Impacts and Potentially High for Indirect Impacts
	4G(12)	Location: Brigantine, Absecon, Pleasantville, West A.C., Env. Considerations: Potential impacts to community, cultural resources, noise Mitigation: None likely.	Location: Western side of Brigantine Env. Considerations: Temporary turbidity, air quality, noise, community disruption. Significant permanent losses of soft bottom subtidal (15 ac.), intertidal flats (12 ac.), tidal marsh (20 ac.), scrub-shrub (0.1 ac.).	Location: Great Egg Harbor Inlet Env. Considerations: Temporary turbidity, air quality, noise. Moderate permanent losses of soft bottom subtidal (18 acres). ESA consultation likely due to dune tie-ins in inlet. Potential indirect significant impacts to hydrodynamics, water quality and	Location: Cross bay barrier along S. Absecon Inlet and Absecon Blvd. and cross bay barrier in S. Ocean City from 52 nd St. Env. Considerations: Temporary turbidity, air quality, noise. Significant permanent losses of soft bottom

REGION	ALT	NONSTRUCTURAL Building Elevation for structures with first floor w/in 20-yr floodplain	PERIMETER Floodwalls, Levees and Miter Gates	STORM SURGE BARRIER Inlet Navigable Sector Gates, Auxiliary Lift Gates, Impermeable Barriers, Levees	BAY CLOSURE Navigable Sector Gates, Auxiliary Lift Gates, Miter Gates, Sluice Gates, Impermeable Barriers, Levees
			Significant impacts to fish/shellfish and wildlife. Obstruction of viewsheds. Mitigation: High	fish/shellfish and wildlife. Obstruction of viewsheds in inlets. Mitigation: Moderate for Direct Impacts and Potentially High for Indirect Impacts	subtidal (39 ac.), intertidal flats (6 ac.), tidal marsh (52 ac.), scrub-shrub (2 ac.). Significant impacts to fish/shellfish and wildlife. Potential indirect significant impacts to hydrodynamics, water quality and fish/shellfish and wildlife. Obstruction of viewsheds in inlets. Mitigation: High for Direct Impacts and Potentially High for Indirect Impacts
SOUTH (Corson Inlet to Cape May Inlet)	5A	Location: All Atlantic Coast and bayside communities from Ludlam Island (Upper Twp.) south to Cape May and W. Cape May Env. Considerations: Potential impacts to community, cultural resources, noise Mitigation: None likely.	NA	NA	NA
	5D(1)	Location: All Atlantic Coast and bayside communities from Ludlam Island (Upper Twp.) south to Cape May and W. Cape May except for SIC, all WW, and Cape May Env. Considerations: Potential impacts to community, cultural resources, noise Mitigation: None likely.	Location: Western side of Sea Isle City, all Wildwoods, and southern shore along Cape May Harbor in Cape May Env. Considerations: Temporary turbidity, air quality, noise, community disruption. Significant permanent losses of soft bottom subtidal (40 ac.), intertidal flats (32 ac.), tidal marsh (72 ac.), scrub-shrub (16 ac.), and forested wetland (5 ac). Significant impacts to fish/shellfish and wildlife. Obstruction of viewsheds. Mitigation: Very High	NA	NA
	5D(2)	Location: All bayside communities from Ludlam Island (Upper Twp.) south to Cape May and W. Cape May; Strathmere and N. Cape May Inlet along Atlantic Coast. Env. Considerations: Potential impacts to community, cultural resources, noise Mitigation: None likely.	Location: Western side of Sea Isle City, Seven Mile Island, all Wildwoods, and southern shore along Cape May Harbor in Cape May Env. Considerations: Temporary turbidity, air quality, noise, community disruption. Significant permanent losses of soft bottom subtidal (109 ac.), intertidal flats (44 ac.), tidal marsh (103 ac.), scrub-shrub (21 ac.), and forested wetland (5 ac). Significant impacts to fish/shellfish and wildlife. Obstruction of viewsheds. Mitigation: Very High	NA	NA

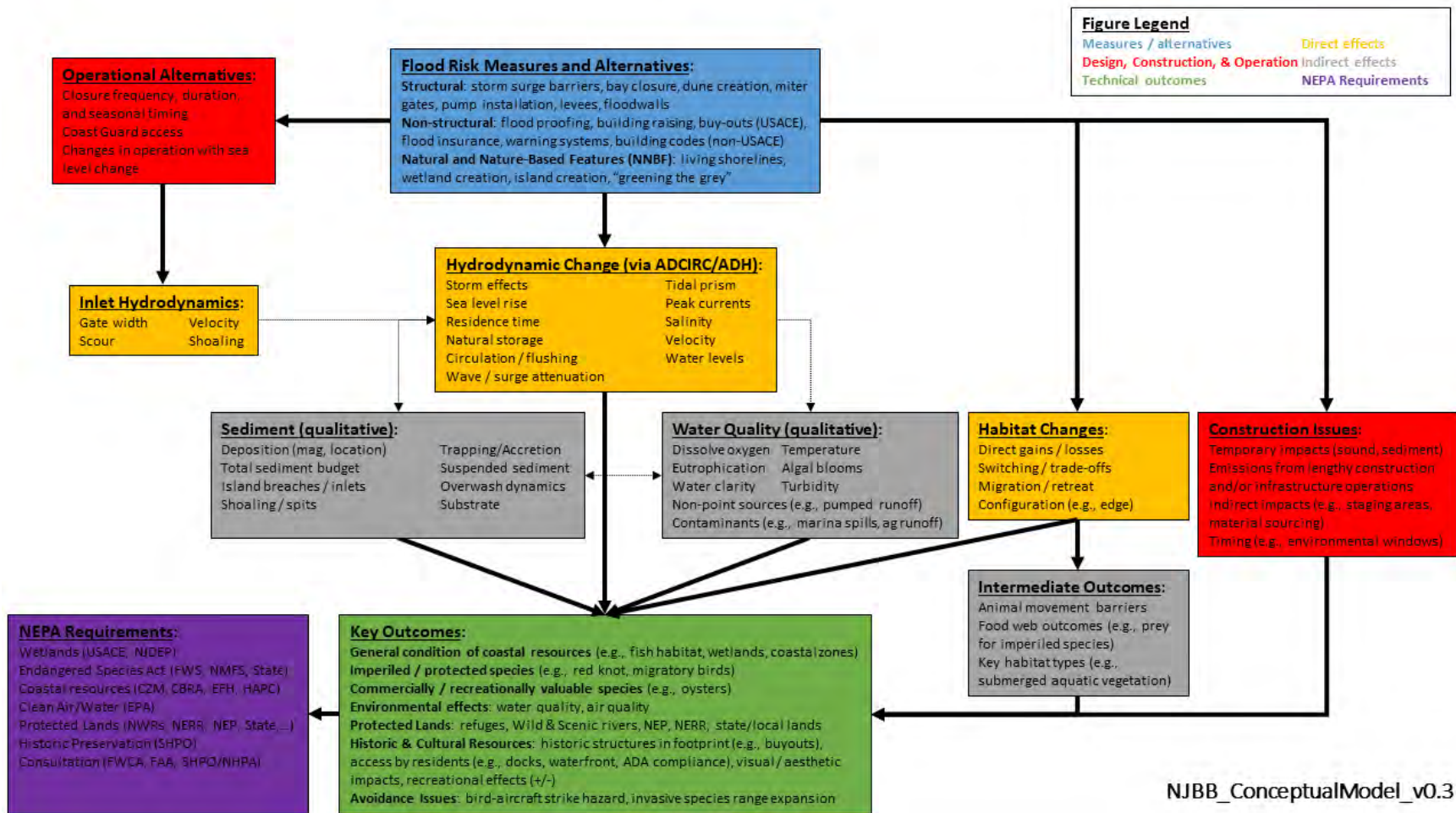

Figure 10-18: Preliminary Conceptual Model of NJBB Structural, Nonstructural and NNBF Measures

10.7 Environmental Mitigation

A preliminary evaluation of the structural components of the preliminary focused array of alternative plans has identified that the impacts to wetlands and other aquatic habitats are moderate to significant. This is inherent in the proposed use of floodwalls, levees, and miter gates for the perimeter plans, the proposed use of floodwalls, levees, sector gates and lift gates for the storm surge barriers and the proposed use of interior bay closures, which are all water dependent features required for flood and erosion control.

When potential significant impacts are identified, CEQ regulations direct Federal agencies to “use the NEPA process to identify and assess the reasonable alternatives to proposed actions that will avoid or minimize adverse effects of these actions...” 40 CFR § 1500.2(e); see 40 CFR § 1500.2(f). The practice of avoidance and minimization is also inherent in the Clean Water Act Section 404(b)(1) guidelines when evaluating the effects of the discharge of dredged or fill material into waters of the United States including wetlands. USACE has adopted a mitigation hierarchical sequencing for civil works projects as defined in ER 1105-2-100. This mitigation sequencing includes:

- a. Avoiding the impact altogether by not taking a certain action or part of an action;
- b. Minimizing impacts by limiting the degree or magnitude of the action and its implementation;
- c. Rectifying the impact by repairing, rehabilitating, or restoring the affected environment;
- d. Reducing or eliminating the impact over time by preservation and maintenance operations during the life of the action;
- e. Compensating for the impact by replacing or providing substitute resources or environments. “Replacing” means the replacement of fish and wildlife resources in-kind.

“Substitute” means the replacement of fish and wildlife resources out-of-kind. Substitute resources, on balance, shall be at least equal in value and significance as the resources lost.

The current preliminary focused array of alternative plans is a result of screening that considered the Environmental Quality (EQ) account. Several preliminary alternatives were screened out based on EQ criteria that eliminated them based on their unacceptable level of adverse impacts. These alternatives including storm surge barriers located at Little Egg Harbor Inlet, Hereford Inlet, and BCs at North Point (Edwin B. Forsythe NWR), which would have induced significant impacts on critical fish and wildlife resources. By eliminating these alternatives, the practice of “avoidance” has been accomplished at an early stage. However, additional avoidance measures with the current preliminary focused array will be considered, where practicable for development of the final array and TSP. Avoidance could be accomplished through design modifications in either the structures themselves or by moving the structure to another location, wherever practicable. An example would be to seek locations where a floodwall or levee could be set-back further from a sensitive habitat. “Minimization” of the impact will also be considered, and some of the same means for avoidance could be applied. An example of minimization could be to maximize the location of a structure feature outside of a sensitive habitat such as a wetland or aquatic area even though avoidance is not practicable. Additionally, minimization can also be practiced if NNBF alternatives are employed that can effectively offset some of the impacts of a structural alternatives’ impacts by providing an ecological uplift through an NNBF feature implementation.

After the practice of minimization is considered, compensation is the most likely form of mitigation in this situation. Compensatory mitigation would require intensive coordination with resource agencies on site selection and mitigation methods. In accordance with USACE policy, a habitat model is required to assess the baseline habitat values, and to determine the severity of the impact to derive an appropriate compensation for the impact. The selection of compensatory mitigation requires the utilization of “cost effectiveness and incremental cost analysis” to determine the optimal level of ecosystem outputs compared with cost considerations.

In the case of the NJBB study, USACE is considering the use of the New England Salt Marsh Model for assessing wetland impacts and mitigation needs. The New England Salt Marsh Model is a community model that quantifies the health and function of salt marsh based on marsh characteristics and the presence of habitat types that contribute to use by terrestrial species. The model consists of eight wetland and landscape components that are used to assess and evaluate salt marsh wildlife habitat values. Several of the components are directly based on the different habitat types found in and around marshes or ecosystems that are linked to salt marshes. Other components reflect the anthropogenic alteration of these habitats. The remaining components take into account the size, morphology, and landscape positions of the marsh, which may be important to territorial species and those that require adjacent upland habitats. The eight components are (1) marsh habitat types, (2) marsh morphology, (3) marsh size, (4) degree of anthropogenic modification, (5) vegetative heterogeneity, (6) surrounding land use, (7) connectivity, and (8) vegetation types. Model output is a numerical score with a maximum possible score of 784. For estuarine aquatic habitat impacts, the Benthic Index of Biotic Integrity (BIBI) is being considered. The combination of the New England Saltmarsh Model and BIBI provides a means to comprehensively evaluate the loss of ecological functions and services across a wide range of habitats.

10.7.1 Historic and Cultural Resources

The New Jersey Back Bays Study will be especially challenging regarding potential impacts to historic properties eligible for or listed on the National Register of Historic Places (NRHP). This project involves the entire southern coast of New Jersey from Monmouth to Cape May. Background research within the general study area show many previously recorded archaeological sites, historic structures, historic districts, shipwrecks, and other cultural resources. The following is the current count of recorded historic properties eligible for or listed on the NRHP for each county in the study area: Monmouth County – 377; Ocean County - 179; Burlington County – 331, one of which is a Paleo-Indian archaeological site; Atlantic County – 153; and, Cape May County – 189. Continued consultation with the New Jersey State Historic Preservation Office, the Tribes, and other Consulting Parties will be required pursuant to Section 106 of the National Historic Preservation Act of 1966, as amended (NHPA) as the project develops. Once our study isolates viable alternatives, we will define the Area of Potential Effects (APE) and conduct the necessary investigations and consultation in order to avoid, minimize, or to mitigate Adverse Effects to historic properties.

11 Environmental Laws and Compliance

The preliminary focused array of alternative plans identified to date, require a rigorous examination of compliance with environmental protection statutes and Executive Orders. Because this study is at an early stage, and a TSP has not yet been identified, there have been no formal proposals by USACE or environmental reviews completed by the public or resource agencies with jurisdiction over the various statutes and regulations. Therefore, full environmental compliance has not been met. However, with circulation of this document, and earlier scoping activities that involved public notices, letters, public, stakeholder and interagency scoping meetings, and the publication of a Notice of Intent (to prepare an EIS), partial compliance is achieved for the current study phase in accordance with NEPA. **Figure 11-1** provides a representation of key environmental compliance statutes and Executive Orders.

11.1 National Environmental Policy Act (NEPA) of 1970, As Amended, 42 U.S.C. 4321, *et seq.*

NEPA requires that all federal agencies use a systematic, interdisciplinary approach to protect the human environment. This approach promotes the integrated use of natural and social sciences in planning and decision-making that could have an impact on the environment. NEPA requires the preparation of an EIS for any major federal action that could have a significant impact on quality of the human environment and the preparation of an Environmental Assessment (EA) for those federal actions that do not cause a significant impact but do not qualify for a categorical exclusion. The NEPA regulations issued by Council on Environmental Quality (CEQ) (40 CFR Part 1500–1508) and the USACE’s regulation ER 200-2-2 -Environmental Quality: Policy and Procedures for Implementing NEPA, 33 CFR 230 provide for a scoping process to identify and the scope and significance of environmental issues associated with a project. The process identifies and eliminates from further detailed study issues that are not significant. USACE will use this process to comply with NEPA and focus this General Investigation (GI) study on the issues most relevant to the environment and the decision making process. **Figure 11-2** provides an overview of the integration of NEPA into the NJBB study’s planning process.

Agency Coordination and Compliance with Key Environmental Quality Protection Statutes

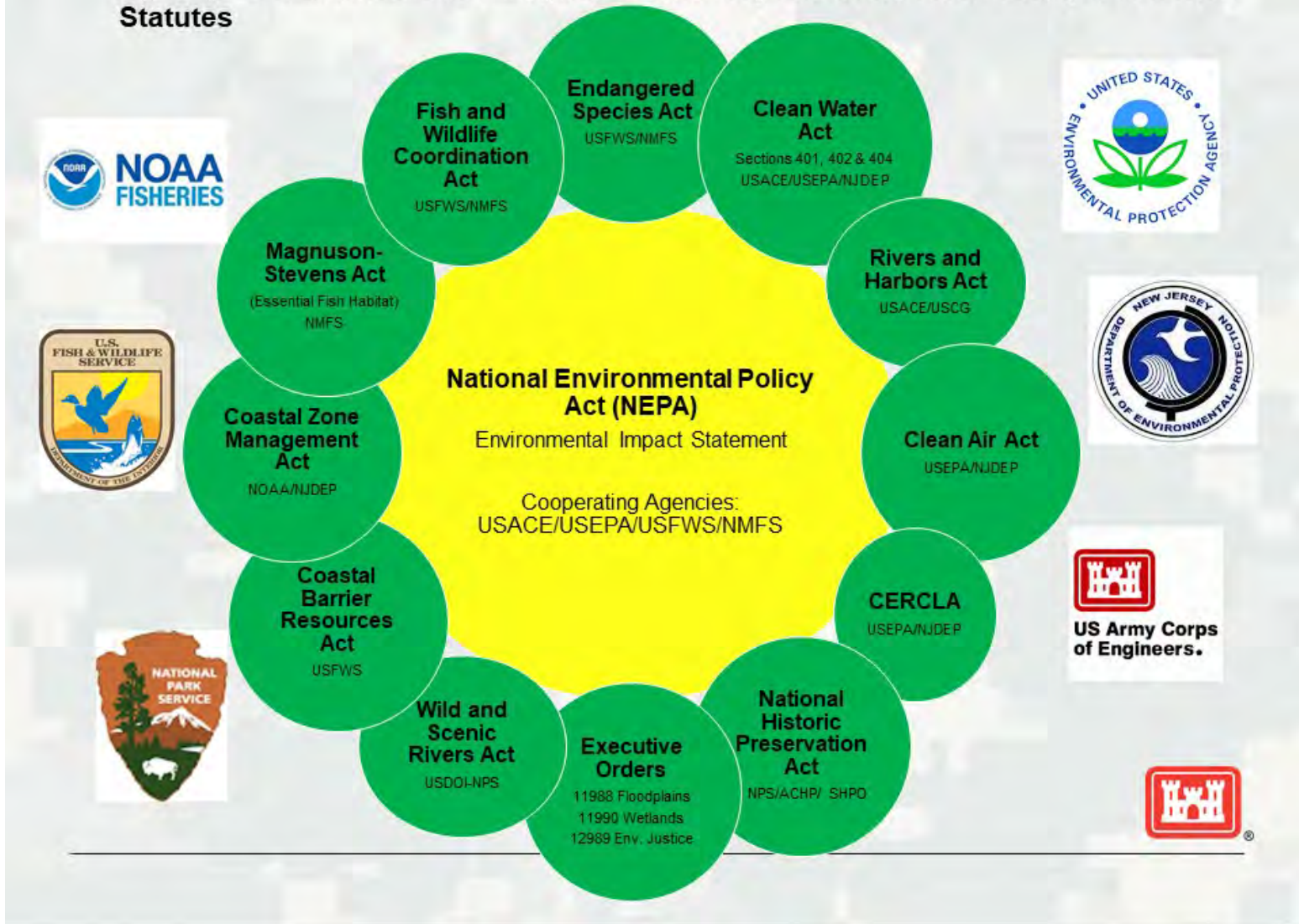

Figure 11-1: Agency Coordination

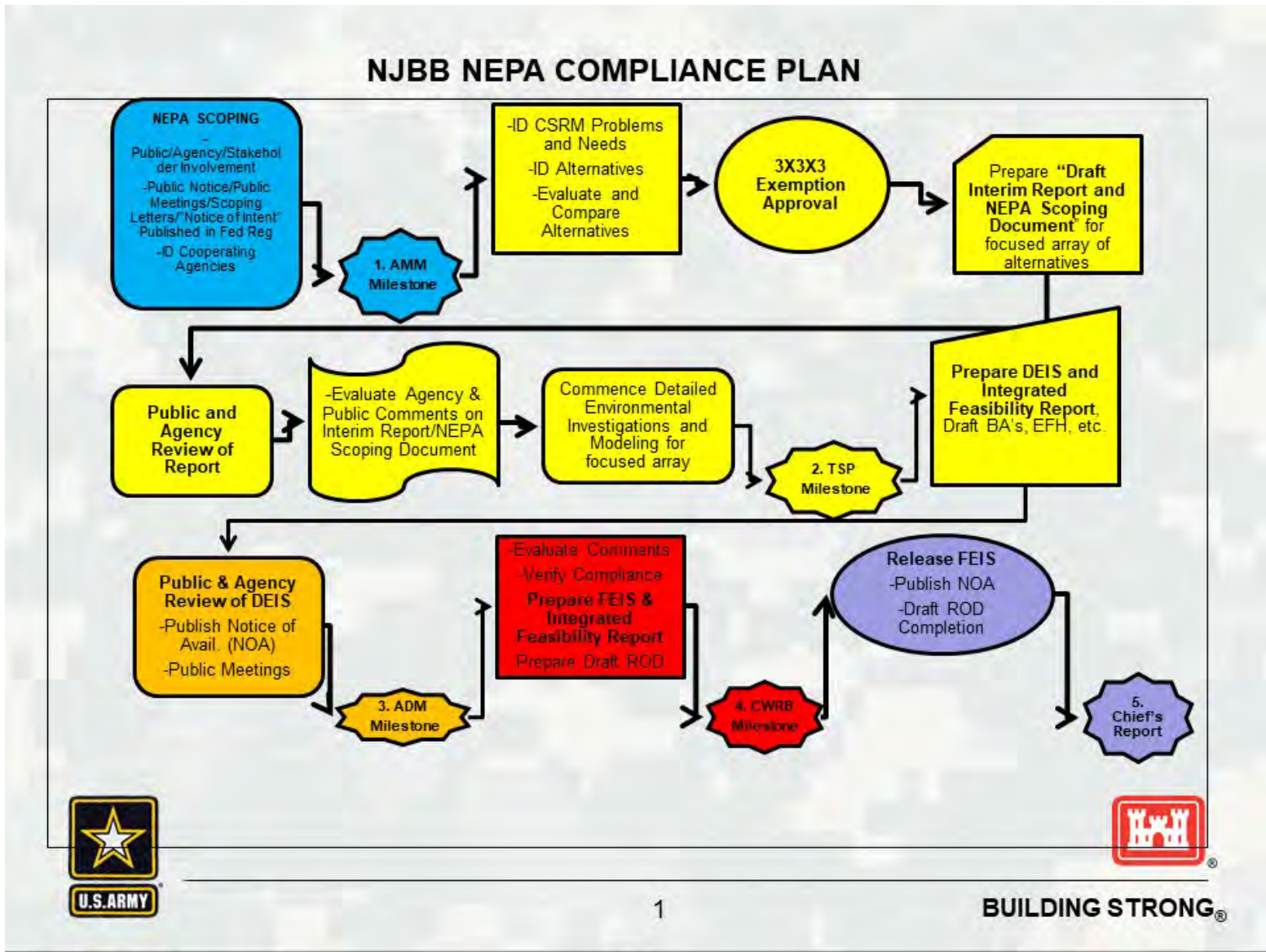

Figure 11-2: NJBB NEPA Compliance Plan

11.2 Clean Air Act, As Amended, 42 U.S.C. 7401, et seq.

Section 118 of the Act states that any Federal action that may result in discharge of air pollutants must comply with Federal, State, interstate and local requirements respecting control and abatement of air pollution. Section 176(c) of the Act requires that Federal actions conform to an implementation plan after it has been approved or promulgated under Section 110 of the Act. Because all of the counties within the NJBB study area are in non-attainment for ozone, an accounting of emissions for any action contemplated will be required in order to determine if any threshold levels are exceeded that would trigger General Conformity Review. At this stage, no accounting for emissions estimates for temporary construction or long-term Operations and Maintenance activities has been performed.

11.3 Clean Water Act (CWA), 33 U.S.C. 1251, et seq.

Section 401 of the CWA requires every applicant for a Federal license or permit for any activity that may result in a discharge into navigable waters to obtain a State Water Quality Certification (Certification) or waiver that the proposed activity will comply with state water quality standards (*i.e.*, beneficial uses, water quality objectives, and anti-degradation policy). The NJDEP issues section 401 Water Quality Certifications for activities within NJ via the Waterfront Development Permits and CAFRA Permits processes.

Section 402 prohibits the discharge of pollutants to "waters of the United States" from any point source unless the discharge is in compliance with a National Pollutant Discharge Elimination System (NPDES) Permit (NJPDES in NJ). Additionally, storm water discharges associated with activities that involve earth disturbances that exceed one acre require an NPDES permit. Given the size and scope of the preliminary focused array of alternative plans, and NPDES storm water permit will likely be required.

Section 404 authorizes the Secretary of the Army acting through the USACE to issue permits for the discharge of dredged or fill materials into the waters of the United States, including wetlands, at specified disposal sites. The selection and use of disposal sites must be in accordance with guidelines developed by the Administrator of EPA in conjunction with the Secretary of the Army and published in 40 CFR Part 230 (known as the 404(b)(1) guidelines). Under the Section 404(b)(1) guidelines, the USACE shall examine practicable alternatives to the proposed discharge and permit only the Least Environmentally Damaging Practicable Alternative (LEDPA). Section 404 of the CWA and 33 C.F.R. 336(c)(4) and 33 C.F.R. 320.4(b) require the USACE to avoid, minimize, and mitigate impacts to wetlands. Jurisdictional wetlands are anticipated with the implementation of any of the preliminary focused array structural alternatives.

11.4 Rivers and Harbors Act, 33 U.S.C. 401, et seq.

This law and its implementing regulations prohibit the construction of any bridge, dam, dike, or causeway over or in navigable waters of the U.S. without Congressional approval. The U.S. Coast Guard administers Section 9 and issues bridge crossing permits over navigable waters. This law and its implementing regulations also allows the U.S. Coast Guard to require necessary lighting and aids to navigation, and to approve any temporary or permanent closures or restrictions of navigation channels. The storm surge barriers and interior bay closures would constitute bridge

crossings by definition, therefore, a permit must be obtained from the USCG once these structures are designed.

11.5 Endangered Species Act (ESA), As Amended 16 U.S.C. 1531, et seq.

The ESA protects threatened and endangered species, and their designated critical habitat, from unauthorized take. Section 9 of the Act prohibits such take, and defines take as to harm, harass, pursue, hunt, shoot, wound, kill, trap, capture, or collect or to attempt to engage in any such conduct. Section 7 of the ESA requires Federal agencies to insure that any action authorized, funded or carried out by them is not likely to jeopardize the continued existence of listed species or modify their critical habitat. Consultation with the USFWS or National Marine Fisheries Service is required if the Federal action may affect a Federally-listed species or designated critical habitat. Given the potential for impacts to Federally-listed species within the NJBB study area with any of the preliminary focused array of alternative plans that utilize structural measures informal and/or formal Section 7 consultation is likely to be required. Initiation of consultation is expected to be completed prior to the selection of a TSP.

11.6 Magnuson-Stevens Fishery Conservation and Management Act (MSA), 16 U.S.C. 1801, et seq.

The Magnuson-Stevens Fishery Conservation and Management Act (PL 94-265), as amended, establishes procedures for the identification of EFH and required interagency coordination to further the conservation of Federally-managed fisheries. Its implementing regulations specify that any Federal agency that authorizes, funds, or undertakes, or proposes to authorize, fund, or undertake, an activity that could adversely affect EFH is subject to the consultation provisions of the Act and identifies consultation requirements. EFH consists of those habitats necessary for spawning, breeding, feeding, or growth to maturity of species managed by Regional Fishery Management Councils in a series of Fishery Management Plans. Based on the locations of the preliminary focused array of alternative plans, all of the structural measures will have direct, indirect, and cumulative effects on EFH, therefore, an EFH assessment will be required for the TSP.

11.7 Federal Coastal Zone Management Act (CZMA), 16 U.S.C. 1451, et seq.

The CZMA requires each federal agency activity performed within or outside the coastal zone (including development projects) that affects land or water use, or natural resources of the coastal zone to be carried out in a manner which is consistent to the maximum extent practicable, i.e. fully consistent, with the enforceable policies of approved state management programs unless full consistency is prohibited by existing law applicable to the federal agency.

To implement the CZMA and to establish procedures for compliance with its federal consistency provisions, the U.S. Department of Commerce, National Oceanic and Atmospheric Administration (NOAA), promulgated regulations which are contained in 15 C.F.R. Part 930. As per 15 CFR 930.37, a federal agency may use its NEPA documents as a vehicle for its consistency determination.

In New Jersey, the CZMA Federal Consistency program is administered by the New Jersey Department of Environmental Protection – Division of Land Use Regulation (NJDEP-DLUR). The preliminary focused array of alternative plans include a number of structural and nonstructural measures that would have significant effects in New Jersey’s coastal zone. Therefore, a detailed review and evaluation of these effects with the applicable coastal management policies will be conducted with the TSP to determine their consistency with these policies. This evaluation will be reviewed by the NJDEP-DLUR for a Federal Consistency Determination.

11.8 Fish and Wildlife Coordination Act (FWCA), 16 U.S.C. 661, et seq.

The FWCA requires Federal agencies to consult with the U.S. Fish and Wildlife Service (USFWS) and the fish and wildlife agencies of States where the "waters of any stream or other body of water are proposed or authorized, permitted or licensed to be impounded, diverted or otherwise controlled or modified" by any agency under a Federal permit or license. Consultation is to be undertaken for the purpose of "preventing loss of and damage to wildlife resources." The intent is to give fish and wildlife conservation equal consideration with other purposes of water resources development projects.

Early coordination with the USFWS has been initiated for the NJBB CSRM feasibility study. This coordination will continue through the development of a TSP scheduled for 2020. At that time, a draft FWCA 2(b) Report will be available, and will contain USFWS comments on any proposed actions associated with the TSP. A final FWCA 2(b) Report will be prepared after agency review of the Draft EIS scheduled for 2020.

11.9 Migratory Bird Treaty Act (MBTA), 16 U.S.C. 715-715s, and Executive Order 13186 Responsibilities of Federal Agencies to Protect Migratory Birds

The MBTA prohibits the taking or harming of any migratory bird, its eggs, nests, or young without an appropriate Federal permit. Almost all native birds are covered by this Act and any bird listed in wildlife treaties between the United States and several other countries. A “migratory bird” includes the living bird, any parts of the bird, its nest, or eggs. The take of all migratory birds is governed by the MBTA’s regulation of taking migratory birds for educational, scientific, and recreation purposes and requiring harvest to be limited to levels that prevent over-utilization. Section 704 of the MBTA states that the Secretary of the Interior is authorized and directed to determine if, and by what means, the take of migratory birds should be allowed and to adopt suitable regulations permitting and governing take. Disturbance of the nest of a migratory bird requires a permit issued by the USFWS pursuant to Title 50 of the Code of Federal Regulations (CFR).

Construction of the measures identified in the preliminary focused array of alternative plans have the potential to “take” migratory birds, eggs, nests, or young during construction that may involve mechanized land clearing particularly during nesting seasons. In order to comply with MBTA, USACE will coordinate with USFWS and NJDEP to determine appropriate construction windows that avoid such takes.

11.10 Marine Mammal Protection Act (MMPA) of 1972, 16 U.S.C. 1631, et seq.

The MMPA was passed in 1972 and amended through 1997. It is intended to conserve and protect marine mammals and establish the Marine Mammal Commission, the International Dolphin Conservation Program, and a Marine Mammal Health and Stranding Response Program. The MMPA prohibits the take of marine mammals, and all cetaceans found within the affected areas. The preliminary focused array is being coordinated with USFWS and NMFS. Because some of the structures within the preliminary focused array include storm surge barriers and interior bay closures, there is a potential for restriction of aquatic life passage to some marine mammals. USACE will continue to coordinate with these agencies to determine the level of effect, and whether a permit that authorizes incidental take is anticipated to be required for this project.

11.11 National Historic Preservation Act (NHPA) of 1966, 16 U.S.C. 6901, et seq.

Compliance with the National Historic Preservation Act of 1966, as amended (54 U.S.C. § 306108), requires the consideration of effects of the undertaking on all historic properties in the project area and development of mitigation measures for those adversely affected properties in coordination with the NJ State Historic Preservation Office (SHPO) and the Advisory Council on Historic Preservation. USACE has initiated Section 106 consultation with the NJ SHPO and selected Native American Tribes. Additionally, USACE anticipates executing a Programmatic Agreement (PA) among USACE, the NJ SHPO, and non-Federal implementation sponsors to address the identification and discovery of cultural resources that may occur during the construction and maintenance of proposed or existing facilities. USACE will also invite the ACHP and Native American Tribes to participate as signatories to the anticipated PA.

11.12 Coastal Barrier Improvement Act (CBIA) of 1990

The CBIA is a reauthorization of the Coastal Barrier Resources Act (CBRA) of 1982. This act is intended to protect fish and wildlife resources and habitat, prevent loss of human life, and preclude the expenditure of Federal funds that may induce development on coastal barrier islands and adjacent nearshore areas. The CBRA established the Coastal Barrier Resources System (CBRS), which consists of mapping of those undeveloped coastal barriers and other areas located on the coasts of the U.S. that were made ineligible for most Federal expenditures and financial assistance. The CBIA of 1990 expanded the CBRS and created a new category of lands known as otherwise protected areas (OPAs). The only Federal funding prohibition within OPAs is Federal flood insurance. Other restrictions to Federal funding that apply to CBRS units do not apply to OPA's. Within the NJBB study area, there are 2 existing CBRS units in Barnegat Bay, 1 CBRS unit located at Hereford Inlet and 7 OPA's located throughout the study area. Additionally, the US Fish and Wildlife Service prepared "Draft Revised" CBRA maps, which include a number of proposed changes to existing CBRS units and OPAs within the NJBB study area; however, these changes require Congressional authorization. Maps of the existing CBRA areas and "Draft Revised" areas are presented in the Environmental and Cultural Resources Appendix F.

11.13 Wild and Scenic Rivers Act of 1968 (Public Law 90-542; 16 U.S.C. 1271, et seq.)

The National Wild and Scenic Rivers System was created by Congress in 1968 to preserve certain rivers with outstanding natural, cultural, and recreational values in a free-flowing condition for the enjoyment of present and future generations. The Act is notable for safeguarding the special character of these rivers, while also recognizing the potential for their appropriate use and development. It encourages river management that crosses political boundaries and promotes public participation in developing goals for river protection.

The Great Egg Harbor River is located within the NJBB study area, and was designated in October 27, 1992. In the NJBB study area, Wild and Scenic River status of the Great Egg Harbor River and tributaries are generally west of the Garden State Parkway. Key drainages that are part of the system include Patcong Creek and the Tuckahoe River at near the confluence west of the Garden State Parkway. The preliminary focused array of alternatives include the nonstructural alternative located in several municipalities that are part of the Comprehensive Management Plan. Additionally, structural alternatives such as the storm surge barrier at Great Egg Harbor Inlet have potential indirect impacts on the Great Egg Harbor River, therefore, USACE will undertake coordination with the National Park Service for review under Section 7(a) of the Wild and Scenic Rivers Act.

11.14 Marine Protection Research and Sanctuaries Act (MPRSA)

The Act has two essential aims: to regulate intentional ocean disposal of materials, and to authorize any related research. While the MPRSA regulates the ocean dumping of waste and provides for a research program on ocean dumping, it also provides for the designation and regulation of marine sanctuaries.

The preliminary focused array of alternatives have not identified any needs, to date, that would involve ocean dumping of waste. A compliance review of MPRSA will be conducted as part of the development of the TSP.

11.15 Resource Conservation and Recovery Act, As Amended, 42 U.S.C. 6901, et seq.

The Resource Conservation and Recovery Act (RCRA) RCRA controls the management and disposal of hazardous waste. "Hazardous and/or toxic wastes", classified by the Resource Conservation and Recovery Act (RCRA), are materials that may pose a potential hazard to human health or the environment due to quantity, concentration, chemical characteristics, or physical characteristics. This applies to discarded or spent materials that are listed in 40 CFR 261.31-.34 and/or that exhibit one of the following characteristics: ignitable, corrosive, reactive, or toxic. Radioactive wastes are materials contaminated with radioactive isotopes from anthropogenic sources (e.g., generated by fission reactions) or naturally occurring radioactive materials (e.g., radon gas, uranium ore).

As part of the feasibility study evaluations will be conducted in accordance with ER 1165-2-132, entitled *Hazardous, Toxic and Radioactive Wastes (HTRW) Guidance for Civil Works Projects*,

dated June 26, 1992, where investigations must be conducted to assess the existence, nature and extent of HTRW within a project impact area.

11.16 Comprehensive Environmental Response, Compensation and Liability Act, 42 U.S.C. 9601, et seq.

The Comprehensive Environmental Response, Compensation and Liability Act (CERCLA or Superfund) governs the liability, compensation, cleanup, and emergency response for hazardous substances released into the environment and the cleanup of inactive hazardous substance disposal sites.

As part of the feasibility study evaluations will be conducted in accordance with ER 1165-2-132, entitled *Hazardous, Toxic and Radioactive Wastes (HTRW) Guidance for Civil Works Projects*, dated June 26, 1992, where investigations must be conducted to assess the existence, nature and extent of HTRW within a project impact area.

11.17 Farmland Protection Policy Act of 1981 and the CEQ Memorandum Prime and Unique Farmlands

In 1980, the CEQ issued an Environmental Statement Memorandum “Prime and Unique Agricultural Lands” as a supplement to the NEPA procedures. Additionally, the Farmland Protection Policy Act, passed in 1981, requires Federal agencies to evaluate the impacts of Federally funded projects that may convert farmlands to nonagricultural uses and to consider alternative actions that would reduce adverse effects of the conversion. The preliminary focused array of alternatives do not appear to have any effects on farmlands within the study area. An evaluation of the effects of the TSP on farmlands will be conducted during the development of the TSP.

11.18 Executive Order 11990, Protection of Wetlands

This EO directs Federal agencies to avoid undertaking or assisting in new construction located in wetlands, unless no practicable alternative is available. A preliminary review of wetland impacts for the preliminary focused array demonstrates a potential significant direct impact on wetland resources for the perimeter plans and interior bay closures that intersect with coastal wetlands. However, to date, these alternatives have not undergone avoidance and minimization reviews, which will be done prior to the development of a TSP. Despite these measures, compensatory mitigation will likely be required for unavoidable impacts.

11.19 Executive Order 11988, Floodplain Management

This EO directs Federal agencies to evaluate the potential effects of proposed actions on floodplains. Such actions should not be undertaken that directly or indirectly induce growth in the floodplain unless there is no practicable alternative. The Water Resources Council Floodplain Management Guidelines for implementation of EO 11988, as referenced in USACE ER 1165-2-26, require an eight-step process that agencies should carry out as part of their decision making

on projects that have potential impacts on or within the floodplain. A full evaluation pursuant to EO 11900 will be completed for the TSP.

11.20 Executive Order 12898, Environmental Justice

This EO directs Federal agencies to determine whether the Preferred Alternative would have a disproportionate adverse impact on minority or low-income population groups within the project area. A full evaluation pursuant to EO 12898 will be completed for the TSP.

11.21 Executive Order 13045, Protection of Children from Environmental and Safety Risks

This EO requires Federal agencies to make it a high priority to identify and assess environmental health and safety risks that may disproportionately affect children and to ensure that policies, programs, activities, and standards address these risks. A full evaluation pursuant to EO 13045 will be completed for the TSP.

11.22 Executive Order 13807, Establishing Discipline and Accountability in the Environmental Review and Permitting Process for Infrastructure Projects

This EO sets out several policies of the Federal Government related to infrastructure projects including, but not limited to, a policy to develop environmentally sensitive infrastructure; a policy to conduct coordinated, consistent, predictable, and timely environmental reviews; and a policy to make timely decisions with the goal of completing all federal environmental reviews and authorization decisions for “major infrastructure projects” within two years. USACE has issued Implementation Guidance for EO 13807 and feasibility studies dated 26 September 2018. Based on the date of the Implementation Guidance, and the requirement to complete major infrastructure project reviews within two years, USACE is re-scoping the review with the Federal and State resource agencies to align with EO 13807. This will be accomplished by the withdrawal of the existing NOI to prepare an EIS (dated December 27, 2017) and the subsequent re-scoping of the environmental reviews with the cooperating agencies and appropriate review agencies (based on the remaining study schedule) followed with the issuance of a new NOI.

12 Agency Coordination and Public Involvement (NEPA Requirement)

12.1 Agency Coordination

On June 17, 2016 and June 21, 2016 USACE and NJDEP conducted Stakeholder Planning Workshops for Study. The purpose of these workshops was to obtain feedback from stakeholders including agency partners to assist NAP in developing problems, objectives, and potential measures throughout the NJBB study area. In recognition of the diversity of the existing conditions and CSRMs issues throughout the study area, NAP sent out invitations to a wide range of stakeholders including representatives from Federal agencies, state agencies, counties, municipalities, NGOs, elected officials, and academia. A total of 39 and 52 stakeholders attended the June 17 and June 21 workshops, respectively. Feedback was gathered from discussion at the meetings as well as written responses submitted during and after the meetings. Analysis of stakeholder feedback on coastal flooding issues identified problems, opportunities, considerations and constraints in the NJBB study. Additional information pertaining to these workshops and interagency coordination is provided in the Correspondence and Communication Appendix E.

A total of eight NEPA scoping comment emails/letters were received, including: four from Federal agencies, three from State agencies, and one from a Native American Tribe. Each comment email/letter included several individual comments typically regarding alternatives, environmental consequences, and coordination and compliance. The majority of comments addressed the effect of CSRMs measures on the environmental integrity of the back bays. The USFWS had the most comments which included 24 comments.

In addition, the following were invited to be cooperating agencies: U.S. Environmental Protection Agency (USEPA), U.S. Coast Guard, Federal Emergency Management Agency (FEMA), National Oceanic and Atmospheric Administration's National Marine Fisheries Service (NOAA NMFS), and the U.S. Fish and Wildlife Service (USFWS). The EPA, USFWS and NOAA NMFS accepted the invitation, although coordination with the remaining agencies is ongoing. Although the Coast Guard verbally expressed interest, it has not officially accepted or attended meetings. No agency declined. FEMA did not respond, although they have participated in meetings.

USACE has held two meetings on 6 June 2018 and 29 November 2018. All of the above agencies participated except for the Coast Guard. The agencies were briefed on the status of the study at that time. Few initial comments were received. Further cooperating agency meetings will be held in the future.

Coordination under the U.S. Fish and Wildlife Coordination Act (FWCA) with the U.S. Fish and Wildlife Service (USFWS) is ongoing. Coordination under Section 7 of the Endangered Species Act is also ongoing.

Coordination with the NMFS under the Magnuson-Stevens Fishery Conservation and Management Act is ongoing and an Essential Fish Habitat (EFH) Assessment is under development. Coordination as required per Section 106 the National Historic Preservation Act is ongoing. Further coordination will occur between the release of this Interim Feasibility Study and Environmental Scoping Document and subsequent reports.

12.2 Public Involvement

On December 01, 2016, and on September 12 and 13, 2018, USACE conducted additional Public Meetings for the Study. The purpose of these meetings were to provide an introduction of the study to the general public and obtain feedback from the general public to assist NAP in identifying problems, opportunities, objectives, constraints and potential CSRM measures throughout the NJBB study area.

In May and June of 2018, USACE and NJDEP conducted Mayor Association Meetings for each of the five counties in the study area including Monmouth, Ocean, Burlington, Atlantic and Cape May Counties. The purpose of these meetings were to provide the Mayors with a more detailed summary of the study and to obtain feedback on the different structural, nonstructural, perimeter and NNBF measures throughout the NJBB study area.

Over 100 participants attended each of the public meetings. Common themes garnered from verbal and written comments both during and after the meetings include:

- Understanding how ongoing state, local, and Federal activities fit with the NJBB study towards the development of a comprehensive, systems-based CSRM approach should be considered.
- Meeting participants expressed a need for USACE to coordinate with other Federal agencies NGO's, the Governor's office, state agencies, and municipalities to ensure that the NJBB study is in alignment with existing efforts and to best leverage study resources. After Hurricane Sandy, some meeting participants stated there was a need that went unmet for state and Federal agencies to distribute best management practices for storm recovery and future flood risk reduction.
- There was interest at the meeting for wider policy centered solutions in addition to the largely engineering based solutions discussed at the meeting. Specifically, meeting participants expressed the difficulty in implementing system wide changes when different municipalities have different levels of engagement and participation in coastal storm risk management policies and activities.
- Both the agencies and the public offer support and opposition to structural solutions. Comprehensive solutions considering structural, nonstructural and NNBF measures should be considered. Proper evaluation of storm surge barrier benefits and costs and their potential impacts to people, property, the local economy and the environment should be strongly considered. Apprehension was expressed regarding tidal velocities and exchange between the bay and the ocean, the accuracy of methodology of inlet hydrodynamic modeling, impacts to navigation and factoring of future breaches in barrier islands.
- Commentary regarding floodwall aesthetics, limitations in access, interior drainage and wall heights was transcribed.
- Interest was expressed in land use changes to facilitate movement out of high risk areas and to decrease development in floodplains, acquisition/relocation as well as elevation strategies was expressed.

- Support was offered for using dredged materials to build berms and dunes and thin layer placement at back bay areas, and both support and opposition to natural and nature based features due to perceived lack of risk management.
- Concerns about the length of the study given uncertainty in funding, legislation and bureaucracy. Specific emphasis was given to the desire for the study to be constructed in a timely fashion and in a scaled fashion rather than at one time to facilitate timeliness.
- A greater understanding on how climate change and sea level rise and associated adaptation is considered in the study process was expressed as a concern by stakeholders.

Flooding of roads and properties from high-frequency flooding including through the overtopping of bulkheads and inundation of salt marsh areas was highlighted as an issue in several parts of the study area. Backflow of water through storm water management systems was also discussed as an issue. Structural solutions to coastal flooding that were discussed by the public included bulkheads along shorelines, check valves at storm water outfalls, storm water improvements, movable flood gates, and storm surge barriers.

- The health of salt marshes within the study area as a result of some of the CSRSM measures was a topic of discussion. Structural measures that may cause negative impacts to the environment area major concern.
- Flood risk assessment procedures particularly with respect to prioritization of risk management along the ocean coast compared to the Back Bay Region was discussed amongst stakeholders.

13 Conclusions and Recommendations

13.1 Path Forward

13.1.1 Feasibility Phase

The New Jersey Back Bays CSRM Feasibility Study has identified the preliminary focused array of alternative plans and subsequent feasibility study analyses towards developing a Draft Feasibility Report and Environmental Impact Statement and associated tentatively selected plan (TSP) in 2020, and a Final Feasibility Report and Environmental Impact Statement and associated recommended plan in 2021. These analyses are inclusive of continued system of accounts analyses (NED, RED, OSE and EQ), planning criteria analyses, and other engineering, planning and environmental analyses. These continued analyses will result in the selection of a recommended plan that reduces coastal storm risk in the NJBB Region consistent with planning objectives in addition to minimizing environmental, social and economic impacts. Each measure type and alternative plan has pros and cons and further investigation is necessary to determine the optimal measure combination for each Region and for the study area as a whole.

This Interim Feasibility Study and Environmental Scoping Document has been prepared in accordance with relevant laws and USACE policy. Analyses have been conducted to address the specific requirements necessary to demonstrate that the preliminary focused array of alternative plans will form a recommended plan that is technically feasible, economically justified, and environmentally compliant and ultimately develop costs and cost-sharing to support a Project Partnership Agreement (PPA).

The information contained within this Interim Feasibility Study and Environmental Scoping Document is preliminary and will be undergoing modifications and additions until approval of the recommended plan scheduled for 2021. The deliverable for this study will be a feasibility report with integrated NEPA compliance documentation (EIS) culminating in a Chief's Report in 2022. This Document will undergo review by USACE technical teams, while the Draft and Final Feasibility Reports and EISs will also undergo an independent external technical peer review by an organization external to the USACE. Prior to submission of the final version of this report to Congress, the report will also undergo review by national policy reviewers, other local, state, and federal agencies, NGOs, and the public. All comments submitted by the aforementioned parties will be addressed. Review comments and responses to those comments will be documented in the future reports discussed above. Upon approval by USACE's Assistant Secretary of the Army, Civil Works (ASA [CW]), the project will be considered for design and construction.

Using the information in each subsequent Feasibility Report, the USACE will continue to coordinate with the NJDEP to implement the recommended project in accordance with current policy and in the most expeditious manner available by maximizing the use of available construction and study authorities (i.e. modifications of on-going projects/studies, post-authorization change reports, or new authorizations).

13.1.2 Plan Implementation

Following the feasibility phase of a project, the pre-construction engineering and design (PED) phase of a project initiates the implementation process of the recommended plan including the development of plans and specifications. Funding by the Federal Government to support these

activities would have to meet traditional civil works budgeting criteria. In order for the PED Phase to be initiated, USACE must sign a Project Partnering Agreement (PPA) with a non-Federal sponsor to cost share PED and construction. This project would require congressional authorization for PED and construction. PED and construction are cost shared 65% Federal and 35% non-Federal. Implementation would then occur provided that sufficient funds are appropriated to design and construct the project.

The construction of scaled, incrementally implementable integrated USACE construction opportunities associated with the recommended plan associated with the Final Feasibility Report and Environmental Impact Statement to reduce risk along the NJBB coast is massive in scale and thus necessitates phasing of the actions with respect to realizing the life cycle of the plan. A strategy for implementation and sequencing of the recommended plan will need to be prepared amongst team partners in order to identify and make available construction funds and to communicate the construction priority to stakeholders. This sequenced approach will also facilitate sponsor readiness and will accommodate the possible intermittent Federal and non-Federal budget cycles. This phased approach will also offer cost saving opportunities through combining efforts on varying scales and accelerating benefit flows by prioritizing actions. The completion of the Chief's Report is the first step toward implementing the design and construction of the NJBB Study.

13.1.3 Operation, Maintenance, Repair, Replacement and Rehabilitation (OMRR&R)

The purpose of OMRR&R is to sustain the constructed project. The most significant OMRR&R is associated with the Storm Surge Barriers. At this point of the study, it is estimated that barriers would be closed for a 1-yr and higher storm surge event, with an average of 2 closure operations per year. In the next phase of the study the storm surge barrier operations plan and closure criteria will be reevaluated. OMRR&R for storm surge barriers typically include monthly startup of backup generators/systems, annual closure of surge barrier gates pre-hurricane season, dive inspections, gate adjustments/greasing, gate rehab and gate replacement. Annual OMRR&R costs of 1.96% of the construction cost were included for the storm surge barrier features and 1.0% of the project cost for the perimeter plan features for each year of the 50-year project life. OMRR&R costs for the storm surge barriers are based on the work performed in the NYNJHAT Coastal Storm Risk Management Feasibility Study. There is no OMRR&R associated with nonstructural solutions.

13.2 Interagency Alignment

A variety of stakeholders have been identified that will be interested in the conduct of the NJBB Study. These groups include:

- Federal and State Agencies
- Regional entities and NGOs
- Tribes
- Academia

- Communities affected by Hurricane Sandy (including local governments and community groups)
- Congressional and Political Leaders
- Media

Federal agency stakeholders include USACE (Institute of Water Resources, Engineer Research and Development Center, Sliver Jackets), FEMA, USGS, NOAA (NWS and NMFS), USDOJ, USDA/NRCS, HUD, BOEM, NASA, SBA, USFWS, USEPA, and NPS. State agency stakeholders include NJDEP, NJDOT, NJOEM, NJ Department of Community Affairs (CDBG), NJSHPO and NJFWS. NGOs include TNC, NFWF, Barnegat Bay Partnership, Rockefeller Foundation, Jacques Cousteau National Estuarine Research Reserve, NJ Adapt, American Littoral Society, Sustainable Jersey, and the Trust for Public Lands. Native American Tribes include the Lenni-Lanape.

13.3 Systems / Watershed Context

The preliminary focused array of alternative plans were formulated to ultimately develop a recommended plan which provides a comprehensive coastal storm risk management plan within the study area and supports the National Economic Development and the regional economy of the watershed. Throughout the study, coordination was maintained with the State of New Jersey as well as counties and municipalities throughout the study area as well as academic institutions, environmental/resource agencies, and other key stakeholders. Continued NJBB analyses will incorporate Federal, State, local, NGOs and academic datasets and tools as applicable and will consider ways to coordinate with and leverage other federal and state resilience projects. The development of relationships with Cooperating Agencies was and will continue to be critical in conducting future analyses.

13.4 Separable and Complementary Measures

These formulation of alternative plans and ultimate identification of the preliminary focused array of alternative plans allow for the identification of separable and complementary measures as discussed above. Separable measures are those measures that can provide a level of risk reduction to an area without relying on other measures, and therefore can potentially be applied on a smaller regional or local scale under a different authority which is not being considered for this study given the large study area. Individually justified separable measures or combined measures in the form of alternative plans can be considered.

Complementary measures are those measures that provide risk reduction in the residual floodplains of structural measures in order to provide a uniform level of risk reduction throughout the city. For example, engineering constraints may limit the location of a structural measure such that a portion of a neighborhood is left unprotected. Providing a complementary measure, typically nonstructural, that will provide a similar level of risk reduction, allows for a more holistic approach to citywide flood risk reduction.

13.5 Sustainability/Adaptability

The preliminary focused array of alternative plans positively affects the sustainability of environmental conditions in the affected area. The preliminary focused array of alternative plans meets the economic, environmental, and community sustainability goals for the fifty year length of the project. Economic principals are used in benefit calculations, plan formulation ranking, and project justification by their contributions to the both the National Economic Development account and community resiliency goals. Environmental concerns are evaluated in the EIS and through coordination and review by the resource agencies including the Environmental Protection Agency, the USFWS and NOAA-NMFS as part of the feasibility process. Social accounts are intrinsic in coastal storm risk management projects since they maintain habitat for beach patrons. The combination of these pillars indicates that this project is sustainable.

13.6 Environmental Operating Principles

In 2002, USACE reaffirmed its long-standing commitment to environmental conservation by formalizing a set of environmental operating principles applicable to all decision making in all programs. The principles are consistent with NEPA; the Department of the Army's Environmental Strategy with its four pillars of prevention, compliance, restoration, and conservation; other environmental statutes and WRDA that govern USACE activities. The Environmental Operating Principles informed the plan formulation process and are integrated into all proposed program and project management processes.

The Environmental Operating Principles are:

- Foster sustainability as a way of life throughout the organization.
- Proactively consider environmental consequences of all USACE activities and act accordingly.
- Create mutually supporting economic and environmentally sustainable solutions.
- Continue to meet our corporate responsibility and accountability under the law for activities undertaken by USACE which may impact human and natural environments.
- Consider the environment in employing a risk management and systems approach throughout the life cycles of projects and programs.
- Leverage scientific, economic, and social knowledge to understand the environmental context and effects of USACE actions in a collaborative manner.
- Employ an open transparent process that respects views of individuals and groups interested in USACE activities.

Plan selection took these principles into account to ensure the sustainability and resiliency of the NED plan while considering the environmental consequences of implementation. USACE considered the environmental and cultural resources in the study area.

13.7 Views of the Non-Federal Sponsor

The non-Federal sponsor, the New Jersey Department of Environmental Protection, has indicated their support for releasing this report for public and agency input.

13.8 Points of Contact

Interested parties can access further information at the USACE's NJBB web Portal which is situated at the following link:

<https://www.nap.usace.army.mil/Missions/Civil-Works/New-Jersey-Back-Bays-Coastal-Storm-Risk-Management/>

Alternatively, interested parties can email all questions and comments to (reference "NJBB" in the subject headings):

PDPA-NAP@usace.army.mil,

A third avenue for contacting the USACE includes providing written correspondence to:

U.S. Army Corps of Engineers, Planning Division

100 Penn Square East (7th floor South)

Wanamaker Building

Philadelphia, PA 19107

14 References

NOAA Technical Report NOS CO-OPS 086, 2018, Patterns and Projections of High Tide Flooding Along the U.S. Coastline Using a Common Impact Threshold, 44p.

U.S. Army Corps of Engineers, Engineering Circular 11-2-194, "Corps of Engineers Civil Works Direct Program, Program Development Guidance Fiscal Year 2011," 2009.

U.S. Army Corps of Engineers, Engineering Circular 11-2-199, "Corps of Engineers Civil Works Program Direct Program, Program Development Guidance Fiscal Year 2012," 2010.

U.S. Army Corps of Engineers, Engineering Circular 1165-2-214, "Civil Works Review." 2012.

U.S. Army Corps of Engineers, Engineering Circular 1105-2-412, "Assuring Quality of Planning Models," 2011.

U.S. Army Corps of Engineers, Engineering Regulation 1105-2-100, "Planning Guidance Notebook," 2000.

U.S. Army Corps of Engineers, Engineering Regulation 1100-2-8162, "Incorporating Sea Level Change in Civil Works Programs," 2013.

U.S. Army Corps of Engineers, Technical Letter 1100-2-1, "Procedures to Evaluate Sea Level Change: Impacts, Responses, and Adaptation," 2014.

U.S. Army Corps of Engineers 2015. North Atlantic Coast Comprehensive Study: Appendix D-New Jersey State Appendix, 120p.

U.S. Congress, Water Resources Development Act of 2007, November 8, 2007.