

Appendix I

Clean Water Act Section 404 Permit Appendix

Appendix I.1
Department of the Army Permit Application

DEPARTMENT OF THE ARMY PERMIT APPLICATION

WEST SACRAMENTO AREA FLOOD CONTROL AGENCY

SOUTHPORT EARLY IMPLEMENTATION PROJECT

YOLO COUNTY, CALIFORNIA

SPK# 2012-00462

SUBMITTED TO:

U.S. Army Corps of Engineers
Regulatory Division, Sacramento District
1325 J Street, Room 1350
Sacramento, CA 95814
Contact: Marc Fugler
916/557-5255

APPLICANT:

West Sacramento Area Flood Control Agency
1110 West Capitol Avenue
West Sacramento, CA 95691
Contact: John Powderly
916/617-4850

PREPARED BY:

ICF International
630 K Street, Suite 400
Sacramento, CA 95814
Contact: Michael Vondergeest
916/231-9570

January 2013



ICF International. 2013. Southport Early Implementation Project. ENG Form 4345 Department of the Army Permit Application. January. (ICF 00071.11.) Sacramento, CA. Prepared for: West Sacramento Area Flood Control Agency, West Sacramento, CA. Submitted to: U.S. Army Corps of Engineers, Sacramento District.

Contents

Department of the Army Permit Application	1 to 3
Supplemental Pages.....	4
Box 15. Location of Proposed Project	4
Box 16. Other Location Descriptions	4
Box 18. Nature of Activity.....	4
Project Background.....	4
Project Setting.....	5
Project Description	6
Construction Details.....	23
Project Impacts	25
Box 23. Avoidance, Minimization, and Compensation.....	27
Avoidance and Minimization	27
Mitigation.....	34
Box 25. Addresses of Adjoining Property Owners.....	38
Box 26. Required Permits and Approvals	39

Tables	Page
1. Project Flood Risk–Reduction Measures	7
2. Setback Levee—Phases, Equipment, and Materials.....	8
3. Adjacent Levee—Phases, Equipment, and Materials	9
4. Slope Flattening—Phases, Equipment, and Materials.....	11
5. Semi-Pervious Berm—Phases, Equipment, and Materials	12
6. Conventional Slot Trench Slurry Wall—Phases, Equipment, and Materials.....	14
7. Deep Soil Mixing Slurry Wall—Phases, Equipment, and Materials	15
8. Jet Grouting Phases, Equipment, and Materials.....	17
9. Relief Wells—Phases, Equipment, and Materials.....	19
10. Rock Slope Protection—Phases, Equipment, and Materials	20
11. Impacts to Waters of the United States	26
12. Federally Listed Threatened and Endangered Species	31

Appendix A Figures

- Figure 1 Project Location
- Figure 2 USGS Quadrangle
- Figure 3 Project Plan View Showing Impacts to Potential Waters of the United States
- Figures 4a-f Typical Levee Cross Sections
- Figure 5 Typical Storm Drain/Culvert Inlet/Outlet

Appendix B Addresses of Adjoining Property Owners

Appendix C Figure 3 (24" x 36"), Folded

**Enclosures Compact Disc containing:
 Public Draft EIS/EIR**

Acronyms and Abbreviations

ASTM	American Society for Testing and Materials
BMPs	best management practices
BSSCP	bentonite slurry spill contingency plan
CDFW	California Department of Fish and Wildlife
CHP	California Highway Patrol
City	City of West Sacramento
CVFBP	Central Valley Flood Protection Board
CVFPP	Central Valley Flood Protection Plan
CVRWQCB	Central Valley Regional Water Quality Control Board
CWA	Clean Water Act
DSM	deep soil mixing
DWR	Department of Water Resources
EIPs	Early Implementation Projects
EPA's	U.S. Environmental Protection Agency's
ESA	Endangered Species Act
HSI	habitat suitability index
LCM	life-cycle management
NHPA	National Historic Preservation Act
NMFS	National Marine Fisheries Service
NPDES	National Pollutant Discharge Elimination System
NTUs	nephelometric turbidity units
O&M	operations and maintenance
PL	Public Law
Regional Water Board	Central Valley Regional Water Quality Control Board
RM	River Mile
rpm	rotations per minute
Southport project	Southport Early Implementation Project
SPCCP	spill prevention, control, and countermeasure plan
SRA	shaded riverine aquatic
SRBPP	Sacramento River Bank Protection Project
SWAMP	Surface Water Quality Ambient Monitoring Program
SWPPP	stormwater pollution prevention plan
ULDC	Urban Levee Design Criteria
USACE	U.S. Army Corps of Engineers
USC	United States Code
USFWS	U.S. Fish and Wildlife Service
WSAFCA	West Sacramento Area Flood Control Agency
WSLIP	West Sacramento Levee Improvements Program

17. DIRECTIONS TO THE SITE

The site can be reached by taking CA-50 west from Sacramento and taking the Jefferson Boulevard exit. Stay left at the fork on the offramp and then turn left onto Jefferson Boulevard. Go south on Jefferson Boulevard for approximately 2 miles and then turn left onto Linden Road. Follow Linden Road to its end at South River Road located at RM 56.1. The project levee extends 1.1 mile upstream to RM 57.2 and 4.5 miles downstream to RM 51.6 and can be viewed by driving primarily along South River Road.

18. Nature of Activity (Description of project, include all features)

The overall project would construct flood risk-reduction measures along 5.6 miles of the Sacramento River to address levee deficiencies that include waterside erosion, geometry, through-seepage, and under-seepage. Proposed flood risk-reduction measures include the construction of a setback levee, adjacent levees, seepage berms, slurry cutoff walls, strengthening in place, and bank stabilization. The resulting levee setback areas would be opened to river flows by breaching the old levee. The setback areas would be used for fish and wildlife habitat restoration where compatible with construction, operation, and maintenance of flood risk-reduction infrastructure. Suitable borrow material needed to construct the new levees and berms would come from several nearby properties shown on Figures 1 and 2. In addition, an existing irrigation pump station and inlet structure would be removed from its current location within the proposed setback area, and a new pump station would be constructed at a new location allowing the continued conveyance of irrigation water in the project area. A full, technically accurate description of each project component is provided in the attached sheets.

19. Project Purpose (Describe the reason or purpose of the project, see instructions)

WSAFCA's goal is to achieve a minimum of 200-year flood protection for the city of West Sacramento by improving the approximately 50 miles of levees protecting West Sacramento. The primary purpose of the Southport project is to reduce flood risk for the entire city of West Sacramento by addressing known levee deficiencies along the Southport reach. Secondary purposes of the Southport project are to provide ecosystem restoration and public recreation opportunities that are compatible with flood risk-reduction measures. The proposed project would incrementally reduce localized flood risk for the reach of the levee at which measures are proposed, in turn reducing risk for the entire city. While the Southport project would not by itself reduce all flood risks affecting the planning area, it would address the most immediate risk based on the location of known levee deficiencies and the clarity and feasibility of available measures to address these deficiencies. Construction of the project is expected to begin in 2014 and be completed during the 2015 construction season. Some preparation of construction may occur during the 2013 construction season, but no changes would be made to the existing levee prism.

USE BLOCKS 20-23 IF DREDGED AND/OR FILL MATERIAL IS TO BE DISCHARGED

20. Reason(s) for Discharge

Fill material would be discharged into waters of the United States to construct new levees, levee seepage berms, roadways (culvert crossings), pumping facilities, bank stabilization, levee breaches, and site grading associated with habitat restoration.

21. Type(s) of Material Being Discharged and the Amount of Each Type in Cubic Yards:

Type Amount in Cubic Yards	Type Amount in Cubic Yards	Type Amount in Cubic Yards
Rock, quantities given on attached sheets	Soil, quantities given on attached sheets	Concrete, quantities given on attached sheets

22. Surface Area in Acres of Wetlands or Other Waters Filled (see instructions)

Acres See the impact table provided on attached sheets for surface areas and linear feet of waters filled.

or

Linear Feet

23. Description of Avoidance, Minimization, and Compensation (see instructions)

Impacts to waters of the United States and special status species habitat will be avoided or minimized wherever possible while still meeting the project purpose and need through project design and the implementation of several measures during construction. Impacted waters will be fully mitigated through the reconstruction of the ditch system in the project area, as well as the creation of the offset area. A full description of avoidance and minimization, as well as mitigation, is provided in the attached sheets.

24. Is Any Portion of the Work Already Complete? Yes No IF YES, DESCRIBE THE COMPLETED WORK

No work has been done for the Southport project.

25. Addresses of Adjoining Property Owners, Lessees, Etc., Whose Property Adjoins the Waterbody (if more than can be entered here, please attach a supplemental list).

a. Address- See attached sheets, Appendix B for this information

City - State - Zip -

b. Address-

City - State - Zip -

c. Address-

City - State - Zip -

d. Address-

City - State - Zip -

e. Address-

City - State - Zip -

26. List of Other Certificates or Approvals/Denials received from other Federal, State, or Local Agencies for Work Described in This Application.

AGENCY	TYPE APPROVAL*	IDENTIFICATION NUMBER	DATE APPLIED	DATE APPROVED	DATE DENIED
See attached sheets					

* Would include but is not restricted to zoning, building, and flood plain permits

27. Application is hereby made for permit or permits to authorize the work described in this application. I certify that this information in this application is complete and accurate. I further certify that I possess the authority to undertake the work described herein or am acting as the duly authorized agent of the applicant.

[Signature] 1/25/13
SIGNATURE OF APPLICANT DATE

[Signature] 1/25/13
SIGNATURE OF AGENT DATE

The Application must be signed by the person who desires to undertake the proposed activity (applicant) or it may be signed by a duly authorized agent if the statement in block 11 has been filled out and signed.

18 U.S.C. Section 1001 provides that: Whoever, in any manner within the jurisdiction of any department or agency of the United States knowingly and willfully falsifies, conceals, or covers up any trick, scheme, or disguises a material fact or makes any false, fictitious or fraudulent statements or representations or makes or uses any false writing or document knowing same to contain any false, fictitious or fraudulent statements or entry, shall be fined not more than \$10,000 or imprisoned not more than five years or both.

Additional Pages

Standard Department of the Army Permit Application for the Southport Early Implementation Project

Box 15. Location of Proposed Project

The proposed Southport Early Implementation Project (Southport project) is located in and west of the Sacramento River between Latitude 38.5572° North, Longitude 121.5177° West and Latitude 28.5030° North, Longitude 121.5599° West.

Box 16. Other Location Descriptions

The Southport project extends approximately 5.6 miles along the Sacramento River South Levee from the termination of the U.S. Army Corps of Engineers (USACE) Sacramento River Bank Protection Project (SRBPP) at River Mile (RM) 57.2 south to the South Cross Levee at RM 51.6, protecting the Southport community of West Sacramento. The 3.9-square mile project area encompasses the area of levee flood-risk reduction along the river corridor and potential soil borrow sites located throughout the Southport area of West Sacramento. The project area covers all or portions of Sections 10, 15, 21, 22, 28, 29, and 32, Township 8 North, and Range 4 East, Mount Diablo Meridian, Yolo County, California.

Box 18. Nature of Activity

Project Background

The project is proposed by the West Sacramento Area Flood Control Agency (WSAFCA) under a framework known as the West Sacramento Levee Improvements Program (WSLIP). To protect human health and safety and prevent adverse effects on property and its economy, the City of West Sacramento (City), as part of WSAFCA, and in partnership with the California Department of Water Resources (DWR), embarked on a comprehensive evaluation of the condition of the levees protecting the city in 2006. The evaluation was necessary to determine the level of flood protection provided by the existing levee system, identify the magnitude and severity of deficiencies, and propose potential flood risk-reduction measures. The results of the comprehensive evaluation revealed several deficiencies that require substantial improvements to meet current flood protection standards as implemented federally by the USACE as levee design criteria and by the Central Valley Flood Protection Board (CVFPP) at the state level for target levels of protection.

DWR administers a program for constructing Early Implementation Projects (EIPs), termed as such as advance efforts in coordination with the comprehensive Central Valley Flood Protection Plan (CVFPP). Three such projects have been constructed by WSAFCA, beginning with the I Street Bridge

EIP in 2008 and the California Highway Patrol (CHP) Academy and The Rivers EIPs in 2011. The proposed project would be the fourth EIP by WSAFCA.

WSAFCA's levees have been evaluated according to the latest USACE criteria for stability, seepage, erosion, geometry, and levee height. Data collected from the evaluation show that much of the existing system does not provide protection from the 100-year flood event (the event having a 1% chance of occurring in any given year), the commonly accepted minimum level of flood protection. In addition, an emergency preparedness mapping study analyzed two hypothetical levee failures and determined the rate and depth at which water would flood the city if a levee failure occurred in the studied reaches. This study predicted flooding depths near 15 feet associated with the 100-year flood event.

The City engaged a consultant engineering team to prepare a problem identification report to determine the types, location, and severity of deficiencies in the WSAFCA flood management system. The deficiencies present in the Southport reach are through seepage, under-seepage, slope stability, geometry, erosion, encroachments, and noncompliant vegetation.

To implement the project, WSAFCA is requesting permission from USACE, Operations Division, pursuant to Section 14 of the Rivers and Harbors Act of 1899 (Title 33 of the United States Code [USC], Section 408, [33 USC 408]), for the alteration of the Federal flood control project; and USACE, Regulatory Division, pursuant to Section 404 of the Clean Water Act (CWA) for regulation of dredged or fill material in jurisdictional waters of the United States and Section 10 of the Rivers and Harbors Act of 1899 for regulation of navigable waters. USACE's responsibilities include these three approvals, the necessary NEPA compliance in granting those approvals, and compliance with other applicable laws such as the federal Endangered Species Act (ESA) and National Historic Preservation Act (NHPA). The Operations Division is preparing an Environmental Impact Statement and will be initiating consultations under ESA Section 7 with the U.S. Fish and Wildlife Service (USFWS) and National Marine Fisheries Service (NMFS), and Section 106 with the State Historic Preservation Officer.

Project Setting

The 3.9-square mile Southport project area encompasses the area of levee flood-risk reduction along the river corridor and potential soil borrow sites located throughout the Southport area of West Sacramento (Figures 1 and 2). Within the project's reach, seven segments have been defined, lettered A through G from south to north (Figure 3). South River Road runs along the top of the levee for the majority of this reach. At Segment A, the road diverts off of the levee top and runs along the landside toe for a short distance. The land side of Segments A through D is bordered mainly by private agricultural lands containing rural residences. The land side of Segment of E is bordered by two small bodies of water referred to as Bees Lakes. Two marinas and multiple boat docks are located along the water side of the levee in Segments E and F. Rural residences border the land side of Segment F, and a residential development closely borders Segment G.

A 10-foot-wide drained stability berm is present on the landside levee slope along the extent of the reach. This risk-reduction measure was completed 1990 through 1993 as part of the Sacramento Urban Levee Reconstruction Project. Two critical erosion sites north of Linden Road in Segments F and G were repaired with rock slope protection as part of the SRBPP and the Flood Control and Coastal Storm Emergency Act (Public Law [PL] 84-99) Rehabilitation Assistance Program.

The project area also includes several adjacent and nearby locations at which suitable borrow material may be available for use in constructing the project. As shown on Figure 1, potential borrow sites are located both close to the levee footprint, to the east and west of southern Jefferson Boulevard, and along the Deep Water Ship Channel.

Project Description

WSAFCA is proposing the Southport project to implement flood risk-reduction measures along the Sacramento River South Levee in order to provide 200-year protection consistent with the goal for urbanized areas, as well as providing opportunities for ecosystem restoration and public recreation. The overall project involves the following elements:

- Flood risk-reduction measures, including setback levee, adjacent levee, slope flattening, seepage berms, slurry cutoff walls, riprap bank stabilization, and operations and maintenance (O&M) easements;
- Road Construction;
- Levee breaches to open up the setback areas to Sacramento River flows;
- Offset area restoration; and
- Reclamation District 900 pump station relocation.

Each of the project components above will result in a discharge of fill material to waters considered jurisdictional under Section 404 of the Clean Water Act. Some of these activities will occur in the Sacramento River, a navigable waterway, and are described in detail below.

Flood-Risk Reduction Measures

In order to address levee deficiencies, several flood risk-reduction measures would be constructed in the project area. These measures consist of a setback levee, an adjacent levee, strengthening in place (slope flattening), seepage berms, slurry cutoff walls, and riprap bank stabilization. The levee flood risk-reduction measure footprint also includes the following elements: a waterside O&M easement (where available), the levee from toe to toe, and the landside O&M and utility easement. The waterside O&M easement is assumed to be 20 feet wide, and the landside O&M easement is assumed to be 50 feet wide. The utility corridor is included largely within the landside O&M area. In Segment G, the landside O&M easement is assumed to vary between the proposed flood risk-reduction measure toe and the existing residential lot lines, a distance varying from approximately a few feet to 100 feet. The approximate linear length of each flood risk-reduction measure proposed for each segment is provided in Table 1, below, and is displayed in Figure 3. For segments where a suitable impermeable tie-in layer was not identified from the geotechnical explorations, a 300-foot wide seepage berm was assumed. Where a tie-in layer was located, a cutoff wall at the associated depth was assumed.

Table 1. Project Flood Risk–Reduction Measures

Segment	Approximate Linear Length	Measures
A	4,850	Slope flattening, slurry cutoff wall, and bank stabilization
B	2,050	Adjacent levee, seepage berm, slurry cutoff wall, and bank stabilization
	3,500	Setback levee, seepage berm, slurry cutoff wall
C	4,400	Setback levee and seepage berm
	900	Setback levee and slurry cutoff wall
D	2,000	Setback levee and slurry cutoff wall
E	1,200	Setback levee and slurry cutoff wall
	2,100	Setback levee and seepage berm
F	5,500	Setback levee and seepage berm
G	2,100	Adjacent levee, slurry cutoff wall, and bank stabilization

Each of the proposed flood risk–reduction measures is described below. See Figures 4a through 4e cross sectional views through levee sections and biotechnical bank stabilization areas. Post-construction, the levee slopes, areas used for construction staging, and any other disturbed areas would be hydroseeded with a native seed mix.

Setback Levee

Objective

A setback levee is an entirely new section of levee constructed at some distance behind the land side of the existing levee. The existing levee remains in place or is removed or breached, depending on conditions in that levee reach. The new section of levee is tied into the existing levee and then becomes the Federal project levee.

A setback levee can address the following deficiencies:

- Through-seepage
- Slope stability and geometry
- Erosion*
- Noncompliant vegetation
- Encroachments

*Adequacy of this measure for correcting an erosion deficiency is dependent on physical and environmental site conditions.

Design and Construction

The new levee section is constructed to meet current design standards, including height and slope requirements. To begin construction activities, the area required to construct the new levee is cleared, grubbed, and stripped. To construct the new section of levee, bulldozers excavate and stockpile borrow material from a nearby permitted borrow site. Front-end loaders load haul trucks with the borrow material. The haul trucks transport the material to the new levee site, where motor

graders spread it evenly. Sheepsfoot rollers compact the material, and water trucks distribute water over the material to ensure proper moisture for compaction. Levee slopes are graded to a 3:1 slope, and a crown at least 20 feet wide is created. For the purpose of levee inspection, an aggregate base, all-weather patrol road is constructed on the crown of the new levee.

If the material from the existing levee is of sufficient quality and not intended to remain in place, it may be excavated and used as fill for the new setback levee. If the existing levee is excavated, grading may be necessary in the offset area (between the new levee and the river) to ensure proper drainage.

Equipment and materials necessary to construct a setback levee are listed in Table 2. Post-construction, construction staging areas, levee slopes, and any other disturbed areas would be hydroseeded with a native seed mix.

Table 2. Setback Levee—Phases, Equipment, and Materials

Phases of Construction	Equipment	Materials
Site preparation (clearing, grubbing, and stripping)	Scraper	Embankment fill material
Embankment fill material placement	Excavator or track hoe	Water
Finish grading	Bulldozer	Aggregate base rock
Site restoration and demobilization	Front-end loader Haul truck Motor grader Sheepsfoot roller Water truck	Hydroseed

Operations and Maintenance

Post-construction, the only permanent facility is the improved levee. O&M would be the same as for a typical levee, described under Adjacent Levee.

Impacts to Waters of the U.S.

Construction of the setback levee would result in the fill of several ditches within the Southport project area. In addition to the ditches that would be filled, portions of the irrigation ditches within the offset area would be cut off from the rest of the ditch system on the land side of the new setback levee. These ditches would be considered permanently impacted, as described in Table 11 under “Project Impacts”, below.

Adjacent Levee

Objective

The adjacent levee involves the construction of a new levee embankment adjacent to the existing levee. This treatment may address the following deficiencies:

- Through-seepage
- Slope stability
- Erosion*

- Noncompliant vegetation
- Encroachments

Adequacy of this measure for correcting an erosion deficiency is dependent on physical and environmental site conditions.

Design and Construction

The adjacent levee essentially adds material to increase the cross section of the levee, thereby allowing the prescribed 3:1 landside slopes and 20-foot-wide crown to be established. The adjacent levee is constructed on the landward side of the levee.

The first construction phase is clearing, grubbing, and stripping the work site and any construction staging areas, if necessary. A trapezoidal trench is cut at the toe of the slope and the levee embankment may be cut in a stair-step fashion to allow the new material to key into the existing material. Bulldozers then excavate and stockpile borrow material from a nearby borrow site. Front-end loaders load haul trucks with the borrow material, and the haul trucks subsequently transport it to the adjacent levee site. The haul trucks dump the material, and dozers spread it evenly. Sheepsfoot rollers compact the material, and water trucks distribute water over the material to ensure proper moisture for compaction. The landside levee typically is graded at a 3:1 slope, and the levee crown is at least 20 feet wide. The slope may be track-walked with a dozer.

The levee crown is finished with an aggregate base or paved road, depending on the type and level of access desired. Either condition requires importation of material with dump trucks, placement with a loader and motor grader, and compaction. A paver is required for asphalt placement.

Equipment and materials necessary to construct an adjacent levee are listed in Table 3. Post-construction, the levee slopes, areas used for construction staging, and any other disturbed areas would be hydroseeded with a native seed mix.

Table 3. Adjacent Levee—Phases, Equipment, and Materials

Phases of Construction	Equipment	Materials
Site preparation (clearing, grubbing, and stripping)	Scraper	Embankment fill material
Material placement and rough grading	Excavator or track hoe	Aggregate base rock
Finish grading	Bulldozer	Hydroseed
Paving (optional)	Front-end loader	Asphalt concrete (optional)
Site restoration and demobilization	Haul truck Motor grader Sheepsfoot roller Water truck Paver (optional)	

Operations and Maintenance

Post-construction, the only permanent facility is the improved levee, subject to typical O&M. Typical levee O&M in the Southport project area currently includes the following actions.

- Vegetation maintenance up to four times a year by mowing or applying herbicide.
- Control of burrowing rodent activity monthly by baiting with pesticide.
- Slope repair, site-specific and as needed, by re-sloping and compacting.
- Patrol road reconditioning up to once a year by placing, spreading, grading, and compacting aggregate base or substrate.
- Visual inspection at least monthly, by driving on the patrol road on the crown and maintenance roads at the base of the levee.

Impacts to Waters of the U.S.

Construction of an adjacent levee would result in the fill of a portion of a ditch in Segment A.

Slope Flattening

Objective

Slope-flattening is a mechanical method to repair or reshape slopes that do not meet standards for geometry and stability. Levee slopes are typically subject to a standard of 3H:1V, but this may vary based on site-specific conditions and supporting engineering analysis. Slope-flattening addresses deficiency related to slope stability and geometry.

Design and Construction

To begin slope-flattening activities, the area is cleared, grubbed, and stripped to provide space for construction and reshaping slopes. Additional embankment fill material may be necessary to achieve slope-flattening. If so, bulldozers excavate and stockpile borrow material from a nearby permitted borrow site. Front-end loaders load haul trucks with the borrow material. The haul trucks transport the material to the slope-flattening site. Motor graders spread material evenly according to levee design plans, and sheepsfoot rollers compact the material. Water trucks distribute water over the material to ensure proper moisture for compaction.

To reshape a waterside slope, the existing crown of the levee is shifted farther landward, and the waterside slope is trimmed and reshaped typically to a 3:1 slope. The shifted levee crown would be a minimum of 20 feet wide, with a 3:1 slope on the landward side, except in cases where the existing slope is 2:1 and it would be maintained. An all-weather patrol road made of aggregate base rock is constructed on the levee crown.

Equipment and materials necessary to implement slope-flattening treatment are listed in Table 4. Post-construction, the construction staging areas, levee slopes, and any other disturbed areas would be hydroseeded with a native seed mix.

Table 4. Slope Flattening—Phases, Equipment, and Materials

Phases of Construction	Equipment	Materials
Site preparation (clearing, grubbing, and stripping)	Scraper	Embankment fill material
Reshaping of slopes and placement of additional fill (if necessary)	Excavator or track hoe	Water
Finish grading	Bulldozer	Aggregate base rock
Site restoration and demobilization	Front-end loader Haul truck Motor grader Sheepsfoot roller Water truck	Hydroseed

Operation and Maintenance

Post-construction, the only permanent facility is the improved levee. Maintenance of the new levee surfaces would consist of:

- Vegetation maintenance up to four times a year by mowing or applying herbicide.
- Control of burrowing rodent activity monthly by baiting with pesticide.
- Slope repair, site-specific and as needed, by re-sloping and compacting.
- Patrol road reconditioning up to once a year by placing, spreading, grading, and compacting aggregate base or substrate.
- Visual inspection at least monthly, by driving on the patrol road on the crown and maintenance roads at the base of the levee.

Impacts to Waters of the U.S.

Levee slope flattening would result in the fill of one ditch in Segment A.

Seepage Berm

Objective

Seepage berms are wide embankment structures made up of low-permeability materials that resist accumulated water pressure and safely release seeping water. A seepage berm is typically one third the height of the levee, and seepage berms proposed for the Southport project can be as wide as 300 feet, extending outward from the landside levee toe and laterally along the levee as needed relative to the seepage conditions. A seepage berm addresses the deficiency of under-seepage.

Design and Construction

Berms vary from 100 to 300 feet in width. Typical height of the berm is 5 feet at the levee landside toe, and it tapers to 3 feet at the berm toe, regardless of the berm width. Lateral length depends on seepage conditions along the levee reach.

Construction consists of clearing, grubbing, and stripping the ground surface. Depending on the alternative, soil used to construct the berm would be stockpiled from levee degradation, excavated

from nearby borrow pits, or trucked on site from off-site locations (if on-site material is not adequately available.) During the degrading, soil would be stockpiled at the proposed berm site. If constructing the alternative does not require levee degradation, all soil material used to construct the berm would come from nearby borrow sites. At the borrow sites, bulldozers excavate and stockpile borrow material. Front-end loaders load haul trucks, and the haul trucks subsequently transport the borrow material to the site. The haul trucks dump the material, and motor graders spread it evenly, placing approximately 3 to 5 feet of embankment fill material. Sheepsfoot rollers compact the material, and water trucks distribute water over the material to ensure proper moisture for compaction.

Equipment and materials necessary to construct a berm are listed in Table 5.

Table 5. Semi-Pervious Berm—Phases, Equipment, and Materials

Phases of Construction	Equipment	Materials
Site preparation (clearing, grubbing, and stripping)	Scraper	Embankment fill material
Embankment fill material placement	Excavator or track hoe	Water
Finish grading	Bulldozer	Aggregate base rock
Site restoration and demobilization	Front-end loader Haul truck Motor grader Sheepsfoot roller Water truck	Hydroseed

Areas used for construction staging, levee slopes, the berm, and any other disturbed areas would be hydroseeded with a native seed mix.

Operation and Maintenance

The only post-construction permanent facility is the berm. Maintenance of the berm would be similar to the typical O&M practices presently in place for maintenance of levee surfaces:

- Vegetation maintenance up to four times a year by mowing or applying herbicide.
- Control of burrowing rodent activity monthly by baiting with pesticide.
- Slope repair, site-specific and as needed, by re-sloping and compacting.
- Patrol road reconditioning up to once a year by placing, spreading, grading, and compacting aggregate base or substrate.
- Visual inspection at least monthly by driving on the patrol road on the crown and maintenance roads at the base of the levee.

Impacts to Waters of the U.S.

Construction of the seepage berm would result in the fill of several ditches within the Southport project area. In addition to the ditches that would be filled, portions of the irrigation ditches within the offset area would be cut off from the rest of the ditch system on the land side of the new setback levee. These ditches would be considered permanently impacted, as described in Table 11 under “Project Impacts”, below.

Slurry Cut-off Wall

Objective

A slurry cutoff wall consists of impermeable material that is placed parallel to the levee, typically through the center of the levee crown. There are three methods for constructing a slurry cutoff wall: (1) conventional slot trench, (2) deep soil mixing (DSM), and (3) jet grouting. The first two methods are for application over longer areas, and jet grouting is a spot application based on limiting conditions for the primary methods. A slurry cutoff wall addresses the deficiency of seepage (through- and under-seepage).

Shallow cutoff walls are those that do not reach the lower impervious layer but may reduce the seepage gradient by increasing the seepage path. Sometimes the reduction in the seepage gradient is not below the maximum allowable limit and an additional seepage berm or relief well is required. Fully penetrating cutoff walls generally are preferred, if feasible to construct, because they are the least costly compared to DSM walls, seepage berms, and relief wells (specifically for a soil-bentonite mix and wall depth less than 85 feet); are the most reliable under certain hydraulic and geotechnical conditions (e.g., water surface elevations above design, variations in foundation soil conditions); and when combined with an adjacent levee, minimize construction disturbance outside the levee footprint.

If a fully penetrating wall is not feasible because of the foundation conditions (the lower impervious layer is nonexistent or at a depth impossible to reach with the existing equipment), shallow cutoff walls supplemented with additional methods of seepage control (such as seepage berms or relief wells) may be used.

Conventional Slot Trench Method: Design and Construction

To begin construction, the construction site and any necessary construction staging or slurry mixing areas are cleared, grubbed, and stripped.

In the conventional slot trench method, a trench is excavated through the levee center from the top of the levee and into subsurface materials. The size of the trench is based on the severity of the seepage but is typically 3 feet wide and up to 85 feet deep. As the trench is excavated, it is filled temporarily with bentonite water slurry to prevent collapse of the trench. The soil from the excavated trench is hauled to a nearby location where it is mixed with hydrated bentonite to reduce permeability and cement in some applications where increased strength and reduced curing time are desired. The soil-bentonite mixture then is returned to the levee and backfilled into the trench. This mixture hardens and creates the impermeable barrier wall in the levee.

In most cases, degradation of the levee crown is necessary to create a large enough working platform to accommodate seepage berm construction activities, and allow equipment to reach lower impervious layers. Dependent on the conditions of the particular levee, it may be necessary to degrade the levee by one to two thirds its existing height. The excavated material is hauled to a nearby stockpile area. Following completion of the slurry cutoff wall, the material is hauled back to the levee to restore the levee to its original dimensions. The material may need to be hauled off site, and borrow material may need to be imported if the in-situ levee material is found to be unsuitable for current levee standards.

One construction crew typically is able to construct 200 to 250 linear feet of slurry wall (approximately 70 to 80 feet deep) in an 8-hour shift. Equipment needed for the crew includes a

long-reach track hoe, three or four dump trucks (15–cubic yard capacity each), two loaders at the mixing location, bulldozers, excavators, a rough terrain forklift, compactors, maintainers, and a water truck. Vertical clearance of about 40 feet is needed for the excavator boom. Horizontal clearance of about 30 feet beyond the levee crest may be required for excavator swing when loading dump trucks.

A mixing area is located at the construction staging area. The mixing area is to prepare the soil-bentonite mixture and supply bentonite-water slurry. The mixing area is contained to avoid inadvertent dispersal of the mixing materials. Dump trucks haul material between the excavator and the mixing area along the levee.

An all-weather patrol road made of aggregate base rock is constructed on the levee crown to enable regular levee inspections.

The construction equipment and materials necessary to construct a slurry cutoff wall by this method are listed in Table 6. Post-construction, areas used for construction staging, mixing, the levee crown, slopes, and any other disturbed areas would be hydroseeded with a native seed mix.

Table 6. Conventional Slot Trench Slurry Wall—Phases, Equipment, and Materials

Phases of Construction	Equipment	Materials
Site preparation (clearing, grubbing, and stripping)	Scraper	Cement
Work platform and trench excavation	Excavator or track hoe	Bentonite
Mixing/placement of soil-bentonite mix	Long-reach track hoe	Aggregate base rock
Replacement of levee material	Bulldozer	Hydroseed
Finish grading	Front-end loader	Water (if no available domestic supply)
Site restoration and demobilization	Haul truck	
	Compactor	Miscellaneous construction support materials
	Maintainer	Embankment fill material (if existing material is of poor quality)
	Water truck	
	Rough terrain forklift	

Operations and Maintenance

Post-construction, the only permanent facility is the slurry cutoff wall. Observation for seepage during high-water events would be the only O&M activity needed.

Deep Soil Mixing Method: Design and Construction

There are several DSM methods of constructing a slurry cutoff walls. Typically DSM methods use a crane-supported set of mixing augers. The augers are drilled through the levee crown and foundation to the required depth (capable of a maximum depth of about 130 feet dependent on the subsurface conditions). As the augers are inserted and withdrawn, a cement-bentonite grout is injected through the augers and mixed with the native soil. An overlapping series of mixed columns is drilled to create a continuous seepage cutoff barrier

To provide a wide enough working platform on the levee crown, the upper portion of some segments of the levee requires excavation with a paddle wheel scraper. Material is scraped and stockpiled at a nearby stockpile area. Dependent on the depth of the wall required, vertical clearance for the crane also may be needed. An excavator manipulates injector return spoils near the DSM rig, and transport trucks are used to haul spoils off site. A crane is used for in-place sampling of DSM material and also for loading bentonite into the batch plant hopper. A mobile batch plant (diesel-powered) is required near each DSM rig at the work area to prepare the cement-bentonite grout. The grout is transported to the DSM rig through flexible hoses. Each batch plant requires a pad of 50 by 100 feet. Hauling at the work area involves scraper runs along the levee to the staging area and deliveries of cement and bentonite to the batch plant.

During DSM slurry wall construction, a typical DSM rig can construct 20 linear feet of DSM wall per 8-hour shift (for wall depths up to 130 feet). An all-weather patrol road made of aggregate base rock is constructed on the levee crown to enable regular levee inspections.

The equipment and materials necessary to construct a DSM slurry wall are listed in Table 7. Post-construction, areas used for construction staging, the levee slopes, and any other disturbed areas would be hydroseeded with a native seed mix.

Operation and Maintenance

Post-construction, the only permanent facility is the slurry cutoff wall. The only O&M activity would be observation for seepage during high-water events.

Table 7. Deep Soil Mixing Slurry Wall—Phases, Equipment, and Materials

Phases of Construction	Equipment	Materials
Site preparation (clearing, grubbing, and stripping)	Scraper	Cement
Work platform excavation	Excavator or track hoe	Bentonite
Deep soil mixing (DSM)	DSM crane	Hydroseed
Replacement of levee material	Bulldozer	Water (if no available domestic supply)
Finish grading	Front-end loader	Aggregate base rock
Site restoration and demobilization	Haul truck	Miscellaneous construction support materials
	Paddle wheel scraper	Embankment fill material (if existing material is of poor quality)
	Water truck	
	Mobile batch plant	

Jet Grouting Method: Design and Construction

Jet grouting involves injecting fluids or binders into the soil at very high pressure. The injected fluid can be grout; grout and air; or grout, air, and water. Jet grouting breaks up soil and, with the aid of a binder, forms a homogenous mass that solidifies over time to create a mass of low permeability. Jet grouting typically is used in constructing a slurry cutoff wall (described later in this chapter) to access areas other methods cannot. In this regard, it is typically a spot application rather than a

treatment to be applied on a large scale along an entire reach. Jet grouting addresses the deficiency of seepage (through- and under-seepage).

Equipment required for jet grouting consists of a drill rig fitted with a special drill string; a high pressure, high flow pump; and an efficient batching plant with sufficient capacity for the required amount of grout and water. The high-pressure pump conveys the grout, air, and/or water through the drill string to a set of nozzles located just above the drill bit. The diameter of the jet grout column is dependent on site-specific variables such as soil conditions, grout mix, nozzle diameter, rotation speed, withdrawal rate, and grout pressure. Jet-grouted columns range from 1 to 16 feet in diameter and typically are interconnected to form cutoff barriers or structural sections. One construction crew, consisting of a site supervisor, pump operator, batch plant operator, chuck tender, and driller under ideal conditions, can construct two 6-foot-diameter, 50-foot columns per day consisting of approximately 100 cubic yards of grout injected per 8 hour shift. Ideal conditions would be characterized by no technical issues such as loss of fluid pressure, breakdown of equipment, or subsurface obstructions to drilling operations occurring at either the batch plant or the drilling site.

To initiate jet grouting, a borehole is drilled through the levee crown and foundation to the required depth (to a maximum depth of approximately 130 feet) by rotary or rotary-percussive methods using water, compressed air, bentonite, or a binder as the flushing medium. When the required depth is reached, the grout is injected at a very high pressure as the drill string is rotated and slowly withdrawn. Rotation speeds range between 10 and 30 rotations per minute (rpm), and the withdrawal rates vary between 2 and 12 inches per minute. Use of the double, triple, and superjet systems create eroded spoil materials that are expelled out of the top of the borehole. The spoil material contains significant grout content and frequently is used as a construction fill.

To provide a wide enough working platform on the levee crown, the upper portion of some segments of the levee may require degradation with a paddle wheel scrapper. Material is scraped and stockpiled at a nearby stockpile area. Hauling at the work area involves scraper runs along the levee to the staging area and grout, bentonite, and water deliveries to the batch plant.

Batch plants typically are centrally located to the injection site, with pipelines for mixed grout that run the length of the work. Grout mixing and injection equipment consists of grout mixers, high-powered grout pumps and supporting generators and air compressors, holding tanks, and water tanks, with bulk silos of grout typically used to feed large mixers. Smaller equipment can be used in combination with the single phase-fluid system and can be permanently trailer-mounted to permit efficient mobilization and easy movement at the job site.

Prior to jet grouting, a field test program typically is completed to evaluate injection parameters and to assess jet grout column geometries, and mechanical and permeability properties. Where possible, jet grout test elements are exposed by excavation and properties are obtained by direct measurement. Bulk samples are collected and delivered to a laboratory for unconfined compressive strength and permeability testing, as required. Where excavation is not possible, core drilling is employed to obtain samples from the jet grout test columns for strength testing.

Types of Jet Grouting Systems

A single phase jet grouting system uses the binder to break up and provide soil mixing of the soils surrounding the drill rods. The single jet grouting system is the most versatile; it can be applied at any inclination and in areas where space is restricted. Set up and excavation times are considerably

shorter; the method is also less expensive, cleaner, and less noisy than the three-fluid jet grouting system.

A double phase jet grouting system improves the range of influence of the single phase jet grouting system using an aureole of compressed air concentric about the jet of binder. The diameter of a column of soil treated by the single phase jet grouting system can be increased by adding the air component. Additional equipment includes a two-way coaxial drill string and an air compressor.

The triple-phase or Kajima jet grouting system uses water and air to break up the soil to produce partial substitution of the finer soil particles to create a column of stabilized material whose diameter may exceed 6 feet. Additional equipment includes a three-way coaxial drill string, an air compressor, and an additional pump and lines for the water phase.

The superjet grouting system is a modified double-phase jet grouting system that uses tooling design efficiencies and increased energy that allow the construction of large columns, up to 16 feet in diameter. The superjet system operates by mechanically and hydraulically focusing the injection of the grout for pinpoint cutting and erosion of very large volumes of soil in situ. The excess soil-grout mixture is simultaneously expelled at the surface, preventing subsurface pressurization and hydrofracturing. A listing of equipment and materials necessary to construct the jet grouting system is provided in Table 8.

Table 8. Jet Grouting Phases, Equipment, and Materials

Phases of Construction	Equipment	Materials
Site preparation (clearing, grubbing, and stripping)	Scraper	
Work platform excavation	Excavator or track hoe	
Jet grouting	Jet grouting drill rig	
	Mobile batch plant	Cement, bentonite
	High pressure, high flow pump	Water
	Piping from drill rig to batch plant (spoil line)	
	Piping from batch plant to drill rig	
Replacement of levee material	Bulldozer	Water
	Haul truck	Embankment fill material
Finish grading	Bulldozer	
Site restoration and demobilization	Haul truck	Miscellaneous construction support materials
	Front-end loader	Embankment fill material
	Paddle wheel scraper	
	Water truck	

Areas used for construction staging, the levee slope, and any other disturbed areas would be restored and hydroseeded following construction.

Operations and Maintenance

Post-construction, the only permanent facility is the slurry cutoff wall. Observation for seepage during high-water events would be the only O&M activity needed.

Impacts to Waters of the U.S.

Construction of the slurry cut off walls would not result in the fill of waters of the U.S.

Relief Wells

Objective

Relief wells are passive systems that are constructed near the levee landside toe to provide a low-resistance pathway for under-seepage to exit to the ground surface in a controlled and observable manner. A low-resistance pathway allows under-seepage to exit without creating sand boils or piping levee foundation materials. Relief wells are an option only in reaches where geotechnical analyses have identified continuous sand and gravel layers and the presence of an adequate impermeable layer. Relief wells are used to address the levee deficiency of under-seepage. Relief wells would be applied only on a limited basis for site-specific conditions rather than a reach-wide application.

Design and Construction

Relief wells are constructed using soil-boring equipment to drill a hole vertically through the fine-grained blanket layer (sand) into the coarse-grained aquifer layer (gravel) beneath. Pipe casings and gravel/sand filters are installed to allow water to flow freely to the ground surface, relieving the pressure beneath the clay blanket without transporting fine materials to the surface, which can undermine the levee foundation. The water then is collected and discharged into RD 900's drainage system.

Relief wells generally are spaced at 50- to 150-foot intervals, dependent on the amount of under-seepage, and extend to depths of up to 150 feet. Areas for relief well construction are cleared, grubbed, and stripped. During relief well construction, a typical well-drilling rig is used to drill to the required depth and construct the well (including well casing, gravel pack material, and well seal) beneath the ground surface. The drill rig likely would be an all-terrain, track-mounted rig that could access the well locations from the levee toe.

Areas along the levee toe may be used to store equipment and supplies during construction of each well. Construction of each well and the lateral drainage system typically takes 10 to 20 days. Additional time may be required for site restoration.

Equipment and materials necessary to construct a relief well are listed in Table 9.

Table 9. Relief Wells—Phases, Equipment, and Materials

Phases of Construction	Equipment	Materials
Site preparation (clearing, grubbing, and stripping)	Scraper	Well casing
Drilling and well installation	Trench excavator or track hoe	Sand and gravel
Finish grading	Drill rig	Concrete
Site restoration and demobilization	Equipment support vehicle	Drain pipe
	Haul truck	Hydroseed
	Motor grader	
	Sheepsfoot roller	
	Water truck	
	Small compactor	

Post-construction, areas used for construction staging, the levee slopes, and any other disturbed areas would be hydroseeded with a native seed mix.

Operation and Maintenance

Relief wells require regular maintenance to ensure proper operation. Piezometers, also called monitoring wells, could be installed between relief wells to allow monitoring of groundwater levels to ensure the wells are relieving the pressure within the aquifer.

Permanent facilities associated with relief wells include the wells themselves, associated lateral drains, and the pump station. Inspection of the relief wells is required at least annually, and observation of flow from the wells is required during high river stages. The wells are test-pumped every 2 years, and the discharge water from those tests is trucked off site to a central disposal, if necessary. The collection ditch is maintained to allow free flow of water.

Impacts to Waters of the U.S.

Construction of relief wells would not result in the fill of waters of the U.S.

Bank Stabilization

Objective

Portions of the levee slopes may be protected by the placement of rock slope protection. Rock is placed in a layer approximately 2.5 feet thick on the water side of the levee to protect against erosional forces that threaten levee stability, such as wind, waves, and boat wake. Rock slope protection addresses the levee deficiency of erosion.

Wherever possible, the bank protection is designed both to control erosion and to maintain existing vegetation and IWM as much as possible. This can be accomplished by incorporating rock benches that serve as buffers against extreme toe scour and shear stress while providing space for planting riparian vegetation and creating a platform to support aquatic habitat features. Such features would be subject to and designed in compliance with USACE levee vegetation guidance.

Design and Construction

The placement of rock onto the levee slope would occur either from atop the levee or from the water side by means of barges, or both. Rock required within the channel, both below and slightly above the surface of the water at the time of placement, would be placed by a crane located on a barge and then spread by an excavator located on top of the levee. Construction would require two barges—one barge would carry the crane while the other barge would hold the stockpile of rock to be placed on the channel slopes—and one excavator located on top of the levee. Rock required on the upper portions of the slopes would be placed by an excavator located on top of the levee. Rock placement from atop the levee would require one excavator and one loader for each potential placement site. The loader brings the rock from a permitted source within 25 miles of the project area and dumps it within 100 feet of the levee. The excavator then moves the rock from the stockpile to the water side of the levee. Soil may be placed in the interstitial spaces, followed by hand installation of native vegetation where outside the vegetation-free zone, consistent with USACE levee vegetation policy. Equipment and materials necessary for rock slope protection are listed in Table 10..

Table 10. Rock Slope Protection—Phases, Equipment, and Materials

Phases of Construction	Equipment	Materials
Site preparation (dependent on site conditions: clearing, grubbing, and stripping)	Scraper	Rock and soil (optional)
Rock placement	Crane	Rock, hydroseed
	Excavator	
	Loader	
	Barges	
Biotechnical element installation	Hand tools	Geotextiles, coir logs, and stakes (optional)
Site restoration and demobilization	Haul truck	Pole cuttings, container stock, and transplanted vegetation (optional)

Post-construction, areas disturbed by the equipment or the rock stockpile area would be hydroseeded with a native seed mix.

Operation and Maintenance

The only permanent features post-construction would be the rock slope protection and native vegetation and other biotechnical features. O&M for plantings may include irrigation, weeding, and monitoring during an establishment period.

Impacts to Waters of the U.S.

The placement of riprap below the OHWM of the Sacramento River would impact navigable waters of the U.S., as described in Table 11.

Road Construction

A majority of South River Road traffic would be relocated to the land side of the Sacramento River South Levee to the future Village Parkway alignment. Year 1 would include the construction of this section of the future Village Parkway and the associated marina access roads (Figure 3).

In order to maintain marina access, South River Road would continue in its current alignment on the existing levee at Segment E and a portion of Segments F and G. The existing levee at Segment E, and a portion of Segment F would remain but no longer would provide flood protection. Linden and Davis Roads would be connected to the new Village Parkway alignment to restore traffic circulation. In order to maintain access to the marinas, two new roads would be constructed that would be routed over the levee crown. The first road would be constructed just north of the Bees Lake area, and the second would be constructed on the southern side of the Bees Lake area. Where practicable, culverts would be constructed in ditches that are crossed by proposed roadways and operations and Maintenance corridors would parallel alongside roads.

Impacts to Waters of the U.S.

Construction of culverts to allow road crossings would impact ditches. These impacts and fill quantities are provided in Table 11 under “Project Impacts”, below. A typical culvert design is shown on Figure 5

Levee Breaches

Objective

Portions of the existing levee would be breached to allow Sacramento River flows into the offset areas. The breach shoulders would be armored with rock placed in a layer approximately 2.5 feet thick and extending 100 feet up and down river from the breach. The sill of the breach would also be armored to protect against erosional forces, such as wind, waves, and boat wake. The sill rock protection would extend approximately 100 feet into the setback area. See Figure 4f to see a typical cross section of a breach sill.

Wherever possible, the bank protection at the breaches is designed both to control erosion and to maintain existing vegetation and IWM as much as possible. This can be accomplished by incorporating rock benches that serve as buffers against extreme toe scour and shear stress while providing space for planting riparian vegetation and creating a platform to support aquatic habitat features. The breach locations would not be subject to USACE levee vegetation guidance and would be vegetated using biotechnical designs. The final design of the breaches would be included in the Offset Area Restoration Plan still in preparation.

Design and Construction

The placement of rock onto the levee slope would occur either from atop the levee or from the water side by means of barges, or both. Rock required within the channel, both below and slightly above the surface of the water at the time of placement, would be placed by a crane located on a barge and then spread by an excavator located on top of the levee. Construction would require two barges—one barge would carry the crane while the other barge would hold the stockpile of rock to be placed on the channel slopes—and one excavator located on top of the levee. Rock required on the upper portions of the slopes would be placed by an excavator located on top of the levee. Rock placement from atop the levee would require one excavator and one loader for each potential placement site. The loader brings the rock from a permitted source within 25 miles of the project area and dumps it within 100 feet of the levee. The excavator then moves the rock from the stockpile to the water side of the levee. Soil may be placed in the interstitial spaces, followed by hand installation of native vegetation where outside the vegetation-free zone, consistent with USACE levee vegetation policy. Equipment and materials necessary for rock slope protection are listed in Table 10 above.

Impacts to Waters of the U.S.

The placement of riprap below the OHWM of the Sacramento River would impact navigable waters of the U.S., as described in Table 11.

Offset Area Restoration

The offset floodplain area refers to the expanded floodway water side of the proposed setback levee. Project activities in this area would include floodplain and habitat restoration and borrow excavation. If appropriate for reuse, the excavated material would be used in construction of the setback levee. Following excavation, the offset area would be finished and graded to allow creation and restoration of riverine, riparian habitats. Once construction of the setback levee is complete, the existing levee would be degraded and breached in five locations to allow for inlet and outlet of floodplain-inundating flows. Habitat restoration in the offset area, along the degraded levee and within the levee breaches is further described under "Mitigation" in Box 23, below.

Grading of the offset areas would result in the fill of several ditches, which are listed in Table 11 under "Project Impacts", below.

Irrigation Pump Station Relocation and Ditch Reshaping

RD 900 owns and operates an irrigation pump station located in the project area on the land side of the levee just south of the intersection of Linden Road and South River Road. During the irrigation season (April through October), the pump station provides irrigation water to stormwater detention ponds in the Southport basin and Main Drain Canal.

As a part of all the proposed project alternatives, the pump station would be relocated south of the current location to an area within the Sherwood Marina. Construction activities would consist of removing and demolishing the existing pump station with the use of a bulldozer and excavator with a percussion hammer attachment for breaking up the foundation. A front-end loader would be used to load the rubble into waste containers, which eventually would be hauled off to a permitted disposal site within 10 miles of the project area.

Installation of the new irrigation pump station would include construction of three pump station components: wet well installation; force main pipeline installation; and pump station building construction. The wet well consists of the temporary underground storage area where the water is held before it is pumped to the force main pipeline. Wet well installation involves the use of an excavator, crane, and dump truck. After the shaft of the wet well is excavated, the pump shaft is installed with a crane. The installation of the force main pipe would involve the use of an excavator, pipe layer, front-end loader, and dump truck. After the excavation of the trench, the force main pipeline would be installed by a pipe layer, and a front-end loader would backfill the trench.

The material excavated during wet well and force main pipeline installation would be hauled off in a dump truck to a permitted disposal site within 10 miles of the project area. Equipment used to construct the pump station building would include a front-end loader, concrete truck, and crane. After the pump station building site is prepped using a front-end loader, a concrete truck would be used to pour the building foundation, and then a crane would be used to place a prefabricated building structure and pump motor at the site. The construction of the entire irrigation pump station would require approximately 4 months.

Operation of the new pump station will result in increased flows into the ditch along Davis Road. To accommodate this additional flow, the entire ditch would be widened to its junction with D-25, which would also be widened for approximately 100 feet and new widened culverts would be installed in the widened ditch.

Construction Details

Construction Schedule

Construction of the project would occur in more than one annual construction season (typically April 15 to October 31, subject to conditions), with construction of Segments C, D, E, F, and G preceding construction of Segments A and B. Construction of the first segments is scheduled to begin during the 2014 construction season, and construction of segments A and B would begin during the 2015 construction season. Some preparation of construction may occur during the 2013 construction season, but no changes would be made to the existing levee prism.

At the end of each construction season, the flood protection system would be restored, at a minimum, to the level of protection existing at the project outset. During construction Year 1, “tie-ins” would be built connecting the existing levee up- and downstream to the segments constructed that season. These tie-ins would be achieved by benching the existing levee and installing compacted lifts to completely bond the new and existing levee materials. During the flood season, maintenance of the baseline level of flood protection would be undertaken by the maintaining agency, RD 900.

Borrow Material Excavation

To meet borrow material demands for constructing the flood risk-reduction measures, multiple sources are being considered, including:

- Embankment fill material excavated from the existing levee structure as part of construction.
- Material excavated from borrow sites located within the 3.9-square mile Southport project area.
- Material purchased from permitted commercial borrow locations within 20 miles of the project site.

Embankment fill material excavated as part of construction would be evaluated for reuse, and that deemed suitable would be used as part of construction of the new levees and berms.

Ongoing borrow analysis has identified potential borrow sites in the Southport project area from which suitable borrow may be excavated (Figure 1). These potential borrow sites range in location from immediately adjacent to the levee construction to approximately 3.5 miles away. If local borrow sites are used, existing top soil would be scraped and set aside and borrow material excavated from the site. Excavation depths would vary, depending on landowner agreement; however, depths of excavation would not encroach upon the water table, and no dewatering would be required. Following material extraction, Southport-area borrow sites would be graded to a depth of no greater than 3 feet. Where feasible, excess embankment fill material deemed unsuitable for reuse could be placed in the borrow site pits and compacted, and the top soil replaced, returning the site to its original elevation. The borrow sites then would be reseeded and returned to pre-use vegetated conditions. Excavation of borrow material would not occur in waters of the United States. If necessary, temporary ditch crossings would be constructed to allow haul trucks access over

ditches, where necessary to minimize the lengths of haul routes and associated environmental impacts. If temporary fill material is discharged to drainages to create the crossing, it would be removed entirely and immediately following completion of the project. The temporarily affected drainage would be restored to pre-project contours and function.

Management of Woody Vegetation

Woody vegetation remaining on levees after construction would be managed according to levee vegetation inspection criteria and consistent with the CVFPP. The inspection criteria establish a vegetation management zone in which trees are trimmed up to 5 feet above the ground (12-foot clearance above the crown road) and thinned for visibility and access. Brush, weeds, and other such vegetation over 12 inches high are to be removed in an authorized manner. The vegetation management zone includes the entire landside levee slope plus 15 feet beyond the landside toe (or less, if the existing easement is less than 15 feet), the levee crown, and the top 20 feet (slope length) of the waterside levee slope.

Waterside vegetation below the vegetation management zone would remain in place without trimming or thinning, unless it poses an unacceptable threat to levee integrity.

Vegetation that was introduced, allowed, required as mitigation, or endorsed by a previous USACE action as necessary to comply with environmental requirements, and/or was present when the levee system was transferred from the USACE to a non-Federal sponsor, would not be removed (unless changed conditions cause such vegetation to pose an unacceptable threat or it creates a visibility problem within the vegetation management zone).

The CVFPP proposes a long-term, adaptive, vegetation life-cycle management (LCM) plan that will lead to the eventual elimination of trees and other woody vegetation through removal of immature trees and woody vegetation. LCM will be implemented in the vegetation management zone, as described above.

This plan will allow existing “legacy” trees and other woody vegetation beyond a certain size to live out their normal life cycles on the levee unless they pose an unacceptable threat. Under the LCM plan, removal of immature trees and woody vegetation less than 4 inches in diameter at breast height will be conducted in consultation with the appropriate resources agencies.

Per the Urban Levee Design Criteria (ULDC), before any tree removal, an engineering inspection and evaluation should be conducted to identify trees and woody vegetation (alive or dead) that pose an unacceptable threat to the integrity of the levee.

Structure and Road Demolition and Utility Relocation

Structure and road demolition activities would consist of removing standing structures within the flood protection corridor and removing sections of two-lane asphalt rural road in the project area. Implementation of the project would require the demolition of 19 structures in Segment A, 37 structures in Segment B, one structure in Segment C, three structures in Segment D, 10 structures in Segment F, and one structure in Segment G. South River Road would be removed along the levee crown in Segments A, B, C, and a section of Segment F north of Linden Road.

Vegetation Removal

Vegetation clearing activities would consist of removing larger woody vegetation, such as trees and shrubs. Grubbing activities consist of removing roots, and stripping activities consist of excavating approximately 6 inches of organic material from the levee surface. The vegetation on the existing Sacramento River levee mostly would be retained, with the exception of the five breach locations, because the levee no longer would provide flood protection and no longer would be subject to the USACE vegetation guidelines. Some vegetation would be removed as part of construction of the new setback levee, seepage berms, and the landside utility O&M corridor.

Staging Areas and Equipment Access

As depicted on Figure 3, three staging areas would be used in the project area. These staging areas are located on the land side of the levee at Segments B, C, and F and would occupy approximately 3.2, 11.0, and 11.7 acres, respectively. These areas would be used for staging construction activities and to provide space to house construction equipment and materials before and during construction activities. The staging area at Segment B would correspond with Segment A and B construction, and the staging areas at Segments C and F would be used for the construction of Segments C through G.

To facilitate project construction, temporary earthen ramps would be constructed to ease equipment access between the levee crown and the staging area(s). The earthen ramps would not affect any delineated water bodies and would be removed when construction is complete.

Project Impacts

Construction of the Southport project would affect the Sacramento River and several ditches. The south bank of the Sacramento River in Segment A would be riprapped to stabilize the bank and prevent erosion. A small amount of concrete would be discharged on the bank of the Sacramento River to construct the pump station intake in Segment E. Ditches would be filled where they are crossed by flood risk-reduction measures, O&M corridors, and proposed roadways. Ditches on the water side of the setback levee would be impacted by borrow extraction, grading, and riparian habitat restoration within the offset area. The estimated acreage of impact and quantity of fill discharged to each water body is provided in Table 11. The quantity of fill into ditches was estimated by multiplying the length of fill by the average width of the ditch, by an assumed 1 foot depth.

Table 11. Impacts to Waters of the United States

Water Body	Reason for Discharge	Permanent Impact (acres)	Linear Feet	Estimated Quantity of Fill (cubic yards)
PD-1: Perennial Drainage (Sacramento River)	Bank Stabilization	16.524	11,800	37,071 cy of riprap
	Levee Breach	6.981	4,412	22,525 cy of riprap
D-01: Agricultural Ditch 5	Setback Levee	0.081	3,772	140 cy soil
	Seepage Berm	0.062		
	Offset Area	0.265		
	Roads	0.006		
	O&M Corridor	0.012		
D-02: Agricultural Ditch	Offset Area	0.125	1,044	193 cy soil
D-03: Agricultural Ditch	Setback Levee	0.015	599	111 cy soil 2 cy riprap
	Offset Area	0.042		2 cy concrete
	Roads	0.006		1 pipe culvert
	O&M Corridor	0.005		
	Ditch Reshape	0.282	2,793	
D-04: Agricultural Ditch	Offset Area	0.306	3,119	462 cy soil
D-05: Riparian Ditch	Seepage Berm	0.013	141	26 cy soil
	O&M Corridor	0.002		
D-06: Riparian Ditch	Seepage Berm	0.022	272	40 cy soil
	Roads	0.006		2 cy riprap
	O&M Corridor	0.002		2 cy concrete 1 pipe culvert
D-07: Riparian Ditch	Offset Area	0.072	1,123	250 cy soil
	O&M Corridor	0.070		
D-08: Riparian Ditch	Setback Levee	0.020	658	158 cy soil
	Seepage Berm	0.056		
	Offset Area	0.001		
	O&M Corridor	0.016		
D-09: Riparian Ditch	Offset Area	0.046	390	72 cy soil
D-10: Riparian Ditch	Setback Levee	0.036	415	50 cy soil
	Roads	0.035		4 cy riprap
	O&M Corridor	0.004		4 cy concrete 2 pipe culvert
D-11: Riparian Ditch	Setback Levee	0.001	328	61 cy soil
	Seepage Berm	0.041		
	O&M Corridor	0.003		

Water Body	Reason for Discharge	Permanent Impact (acres)	Linear Feet	Estimated Quantity of Fill (cubic yards)
D-12: Riparian Scrub Ditch	Setback Levee	0.017	441	82 cy soil
	Seepage Berm	0.013		
	Offset Area	0.018		
	O&M Corridor	0.002		
D-14: Roadside Ditch	Setback Levee	0.148	3,754	278 cy soil
	O&M Corridor	0.029		
D-17: Agricultural Ditch	Setback Levee	0.018	1,208	169 cy soil 2 cy riprap 2 cy concrete 1 pipe culvert
	Seepage Berm	0.035		
	Offset Area	0.078		
	Roads	0.011		
	O&M Corridor	0.005		
D-20: Agricultural Ditch	Roads	0.011	96	2 cy riprap 2 cy concrete 1 pipe culvert
D-21: Agricultural Ditch	Setback Levee	0.007	454	34 cy soil
	Seepage Berm	0.014		
	Offset Area	0.008		
	O&M Corridor	0.002		
D-25: Agricultural Ditch	Ditch Reshape	0.028	108	
D-27: Agricultural Ditch	Roads	0.053	357	6 cy riprap 6 cy concrete 3 pipe culvert
Perennial Drainages (Sacramento River)		23.505	16,212	59,614 cy riprap
Agricultural and Roadside Ditches		1.655	17,513	1,737 cy soil
Riparian and Riparian Scrub Ditches		0.499	3,769	20 cy concrete
Total:		25.659	37,494	10 pipe culverts

Box 23. Avoidance, Minimization, and Compensation

Avoidance and Minimization

The Southport project has been designed to avoid and minimize impacts to waters of the United States to the maximum extent practicable while still meeting SAFCA's need for flood protection. For example:

- Seepage berms will be the minimum width necessary to avoid additional impacts to landside drainages.
- All borrow excavation outside of the construction footprint will avoid waters of the United States entirely.
- Culverts placed in ditches will be sized to accommodate expected high water flows and maintain pre-project downstream flows.

- Rock or concrete aprons will be placed at the upstream and downstream ends of the culverts to prevent erosion and sedimentation to waters.
- All temporary culvert or flat car crossings of ditches needed for vehicle and equipment access will be removed when construction is completed.
- Once construction is completed, all temporarily disturbed areas will be restored to pre-project conditions, and will be revegetated with a native grass mix or hydroseeded.

Stormwater Pollution Prevention Plan

Because ground disturbance would be greater than 1 acre, WSAFCA will obtain coverage under the U.S. Environmental Protection Agency's (EPA's) National Pollutant Discharge Elimination System (NPDES) general construction activity stormwater permit. The Central Valley Regional Water Quality Control Board (Regional Water Board) administers the NPDES stormwater permit program in Yolo County. Obtaining coverage under the NPDES general construction activity permit generally requires that the project applicant prepare a stormwater pollution prevention plan (SWPPP) that describes the best management practices (BMPs) that will be implemented to control accelerated erosion, sedimentation, and other pollutants during and after project construction. The SWPPP will be prepared prior to commencing earth-moving construction activities.

The specific BMPs that will be incorporated into the erosion and sediment control plan and SWPPP will be site-specific and will be prepared by the construction contractor in accordance with the Regional Water Board Field Manual. However, the plan likely will include, but not be limited to, one or more of the following standard erosion and sediment control BMPs.

- Timing of construction. The construction contractor will conduct all construction activities during the typical construction season to avoid ground disturbance during the rainy season.
- Staging of construction equipment and materials. To the extent possible, equipment and materials will be staged in areas that have already been disturbed. No equipment or materials would be stored in the floodway during the flood season.
- Minimize soil and vegetation disturbance. The construction contractor will minimize ground disturbance and the disturbance/destruction of existing vegetation. This will be accomplished in part through the establishment of designated equipment staging areas, ingress and egress corridors, and equipment exclusion zones prior to the commencement of any grading operations.
- Stabilize grading spoils. Grading spoils generated during the construction will be temporarily stockpiled in staging areas. Silt fences, fiber rolls, or similar devices will be installed around the base of the temporary stockpiles to intercept runoff and sediment during storm events. If necessary, temporary stockpiles may be covered with an appropriate geotextile to increase protection from wind and water erosion.
- Install sediment barriers. The construction contractor may install silt fences, fiber rolls, or similar devices to prevent sediment-laden runoff from leaving the construction area.
- Stormwater drain inlet protection. The construction contractor may install silt fences, drop inlet sediment traps, sandbag barriers, and/or other similar devices.
- Permanent site stabilization. The construction contractor will install structural and vegetative methods to permanently stabilize all graded or otherwise disturbed areas once construction is

complete. Structural methods may include the installation of biodegradable fiber rolls and erosion control blankets. Vegetative methods may involve the application of organic mulch and tackifier and/or the application of an erosion control native seed mix. Implementation of a SWPPP will substantially minimize the potential for project-related erosion and associated adverse effects on water quality.

Bentonite Slurry Spill Contingency Plan (Frac-Out Plan)

Before excavation begins, WSAFCA will ensure the contractor will prepare and implement a bentonite slurry spill contingency plan (BSSCP) for any excavation activities that use pressurized fluids (other than water). If the contractor prepares the plan, it will be subject to approval by USACE, NMFS, and WSAFCA before excavation can begin. The BSSCP will include measures intended to minimize the potential for a frac-out (short for “fracture-out event”) associated with excavation and tunneling activities; provide for the timely detection of frac-outs; and ensure an organized, timely, and “minimum-effect” response in the event of a frac-out and release of excavation fluid (bentonite). The BSSCP will require, at a minimum, the following measures.

- If a frac-out is identified, all work will stop, including the recycling of the bentonite fluid. In the event of a frac-out into water, the location and extent of the frac-out will be determined, and the frac-out will be monitored for 4 hours to determine whether the fluid congeals (bentonite will usually harden, effectively sealing the frac-out location).
- NMFS, DFG, and the Regional Water Board will be notified immediately of any spills and will be consulted regarding clean-up procedures. A Brady barrel will be on site and used if a frac-out occurs. Containment materials, such as straw bales, also will be on site prior to and during all operations, and a vacuum truck will be on retainer and available to be operational on site within 2 hours' notice. The site supervisor will take any necessary follow-up response actions in coordination with agency representatives. The site supervisor will coordinate the mobilization of equipment stored at staging areas (e.g., vacuum trucks) as needed.
- If the frac-out has reached the surface, any material contaminated with bentonite will be removed by hand to a depth of 1 foot, contained, and properly disposed of, as required by law. The drilling contractor will be responsible for ensuring that the bentonite is either properly disposed of at an approved Class II disposal facility or properly recycled in an approved manner.
- If the bentonite fluid congeals, no other actions, such as disturbance of the streambed, will be taken that potentially would suspend sediments in the water column.
- The site supervisor has overall responsibility for implementing this BSSCP. The site supervisor will be notified immediately when a frac-out is detected. The site supervisor will be responsible for ensuring that the biological monitor is aware of the frac-out; coordinating personnel, response, cleanup, regulatory agency notification and coordination to ensure proper clean-up; disposal of recovered material; and timely reporting of the incident. The site supervisor will ensure all waste materials are properly containerized, labeled, and removed from the site to an approved Class II disposal facility by personnel experienced in the removal, transport, and disposal of drilling mud.
- The site supervisor will be familiar with the contents of this BSSCP and the conditions of approval under which the activity is permitted to take place. The site supervisor will have the authority to stop work and commit the resources (personnel and equipment) necessary to implement this plan. The site supervisor will ensure that a copy of this plan is available (on site)

and accessible to all construction personnel. The site supervisor will ensure that all workers are properly trained and familiar with the necessary procedures for response to a frac-out prior to commencement of excavation operations.

Spill Prevention, Control, and Countermeasure Plan

A spill prevention, control, and countermeasure plan (SPCCP) is intended to prevent any discharge of oil into navigable water or adjoining shorelines. WSAFCA or its contractor will develop and implement an SPCCP to minimize the potential for and effects from spills of hazardous, toxic, or petroleum substances during construction and operation activities. The SPCCP will be completed before any construction activities begin. Implementation of this measure will comply with state and Federal water quality regulations. The SPCCP will describe spill sources and spill pathways in addition to the actions that will be taken in the event of a spill (e.g., an oil spill from engine refueling will be immediately cleaned up with oil absorbents). The SPCCP will outline descriptions of containments facilities and practices such as double-walled tanks, containment berms, emergency shutoffs, drip pans, fueling procedures, and spill response kits. It will describe how and when employees are trained in proper handling procedure and spill prevention and response procedures.

WSAFCA will review and approve the SPCCP before onset of construction activities and routinely inspect the construction area to verify that the measures specified in the SPCCP are properly implemented and maintained. WSAFCA will notify its contractors immediately if there is a noncompliance issue and will require compliance.

The Federal reportable spill quantity for petroleum products, as defined in 40 CFR 110, is any oil spill that:

- Violates applicable water quality standards.
- Causes a film or sheen on or discoloration of the water surface or adjoining shoreline.
- Causes a sludge or emulsion to be deposited beneath the surface of the water or adjoining shorelines.

If a spill is reportable, the contractor's superintendent will notify WSAFCA, and WSAFCA will take action to contact the appropriate safety and cleanup crews to ensure that the SPCCP is followed. A written description of reportable releases must be submitted to the Regional Water Board. This submittal must contain a description of the release, including the type of material and an estimate of the amount spilled, the date of the release, an explanation of why the spill occurred, and a description of the steps taken to prevent and control future releases. The releases will be documented on a spill report form.

If an appreciable spill occurs and results determine that project activities have adversely affected surface or groundwater quality, a detailed analysis will be performed by a registered environmental assessor or professional engineer to identify the likely cause of contamination. This analysis will conform to American Society for Testing and Materials (ASTM) standards and will include recommendations for reducing or eliminating the source or mechanisms of contamination. Based on this analysis, WSAFCA and its contractors will select and implement measures to control contamination, with a performance standard that surface water quality and groundwater quality must be returned to baseline conditions.

Turbidity Monitoring in Adjacent Water Bodies

WSAFCA or its contractor will monitor turbidity in the adjacent water bodies, where applicable criteria apply, to determine whether turbidity is being affected by construction and ensure that construction does not affect turbidity levels, which ultimately increase the sediment loads.

The Basin Plan contains turbidity objectives for the Sacramento River. Specifically, the plan states that where natural turbidity is between 5 and 50 nephelometric turbidity units (NTUs), turbidity levels may not be elevated by 20% above ambient conditions. Where ambient conditions are between 50 and 100 NTUs, conditions may not be increased by more than 10 NTUs.

WSAFCA or its contractor will monitor ambient turbidity conditions upstream during construction and adhere to the Surface Water Quality Ambient Monitoring Program (SWAMP) requirements for turbidity monitoring. Monitoring will continue approximately 300 feet downstream of construction activities to determine whether turbidity is being affected by construction. Grab samples will be collected at a downstream location that is representative of the flow near the construction site. If there is a visible sediment plume being created from construction, the sample will represent this plume. Monitoring will occur hourly when construction encroaches into the Sacramento River. If construction does not encroach into the river, the monitoring will occur once a week on a random basis.

If turbidity limits exceed Basin Plan standards, construction-related earth-disturbing activities will slow to a point that results in alleviating the problem. WSAFCA will notify the Regional Water Board of the issue and provide an explanation of the cause.

Federally-listed Species

The federally-listed species that are known to occur or have the potential to occur in the Southport project area are listed in Table 12, below.

Table 12. Federally Listed Threatened and Endangered Species

Common and Scientific Names	Federal Status	Potential Occurrence in Affected Area
Valley elderberry longhorn beetle <i>Desmocerus californicus dimorphus</i>	T	High—two CNDDDB (2012) occurrences in the project area and approximately 58 shrub locations (potential VELB habitat) found in the project area during field surveys (2005–2011)
Giant garter snake <i>Thamnophis gigas</i>	T	Moderate—CNDDDB occurrences within 3 miles of project area.
Delta smelt <i>Hypomesus transpacificus</i>	T	High
Central Valley steelhead <i>Oncorhynchus mykiss</i>	T	High—spawning during migration
Sacramento River winter-run Chinook salmon <i>Oncorhynchus tshawytscha</i>	E	High—spawning during migration
Central Valley spring-run Chinook salmon <i>Oncorhynchus tshawytscha</i>	T	High—spawning during migration
Central Valley fall-/late fall-run Chinook salmon <i>Oncorhynchus tshawytscha</i>	SC	High—spawning during migration

Common and Scientific Names	Federal Status	Potential Occurrence in Affected Area
Green sturgeon (southern DPS) <i>Acipenser medirostris</i>	T	High—spawning during migration

E = Listed as endangered under the federal Endangered Species Act (ESA).
T = Listed as threatened under ESA.
SC = Species of concern.

Biological assessments are currently being prepared to support formal Section 7 consultation between USACE and the U.S. Fish & Wildlife Service (USFWS) and the National Marine Fisheries Service (NMFS). Measures to avoid and minimize impacts to the habitat of the species in Table 12 are provided below.

Valley Elderberry Longhorn Beetle

Before any ground-disturbing activities occur, WSAFCA will ensure that a minimum 4-foot-tall, temporary plastic mesh-type construction fence (Tensor Polygrid or equivalent) is installed at least 20 feet from the dripline of the elderberry shrub. This fencing is intended to prevent encroachment by construction vehicles and personnel. The exact location of the fencing will be determined by a qualified biologist, with the goal of protecting sensitive biological resources (habitat for VELB). The fencing will be strung tightly on posts set at a maximum interval of 10 feet. The fencing will be installed in a way that prevents equipment from enlarging the work area beyond what is necessary to complete the work. The fencing will be checked and maintained weekly until all construction is completed. This buffer zone will be marked by a sign stating:

This is habitat of the valley elderberry longhorn beetle, a threatened species, and must not be disturbed. This species is protected by the Endangered Species Act of 1973, as amended. Violators are subject to prosecution, fines, and imprisonment.

No construction activity, including grading, will be allowed until this condition is satisfied. The fencing and a note reflecting this condition will be shown on the construction plans.

WSAFCA will ensure that dust control measures are implemented for all ground-disturbing activities in the project area. These measures may include application of water to graded and disturbed areas that are unvegetated. To avoid attracting Argentine ants, at no time will water be sprayed within the driplines of elderberry shrubs.

Elderberry shrubs growing within 20 feet of proposed construction areas will require transplanting prior to any ground-disturbing activities. In the event that elderberry shrubs determined to be directly affected can be retained on site but occur within 20 feet of proposed construction activities, dust control measures will be required to minimize direct effects on these shrubs. Therefore, the applicant will implement one of the following mitigation measures for each elderberry shrub that occurs within 20 feet of proposed construction activities.

- All elderberry shrubs that occur in proposed development areas will be transplanted to a USFWS-approved conservation area in accordance with the Conservation Guidelines for Valley Elderberry Longhorn Beetle (U.S. Fish and Wildlife Service 1999). These elderberry shrubs will be transplanted when they are dormant (after they lose their leaves), in the period starting approximately in November and ending in the first 2 weeks of February. A qualified specialist familiar with elderberry shrub transplantation procedures will supervise the transplanting. The

location of the conservation area transplantation site will be approved by USFWS before removal of the shrubs.

OR

- If it is determined that elderberry shrubs can be avoided but that construction activities will occur within 20 feet of the shrubs, the applicant will ensure that dust control measures (e.g., watering) are implemented in the vicinity of the shrub. To further minimize effects associated with dust accumulation, the elderberry shrubs will be covered by a protective cloth (burlap) during all ground-disturbing activities occurring within 20 feet of the shrubs. The cloth will be removed daily and immediately after ground-disturbing activities are completed. In addition, temporary construction fencing will be placed around the dripline of the elderberry shrubs before the start of construction activities to ensure that the shrub is not inadvertently removed.

Giant Garter Snake

To avoid and minimize effects on giant garter snake, WSAFCA will implement the following surveys and protection measures.

- All construction activity in giant garter snake aquatic and upland habitat in and around agricultural ditches and Bees Lakes will be conducted between May 1 and October 1, the active period for giant garter snakes. This would reduce direct effects on the species because the snakes would be active and respond to construction activities by moving out of the way.
- Prior to any construction in suitable giant garter snake aquatic habitat (agricultural ditches), the habitat will be dewatered and must remain dry for at least 15 consecutive days after April 15 and prior to excavating or filling of dewatered habitat.
- A USFWS-approved biologist will conduct a preconstruction survey in suitable habitat no more than 24 hours before construction and will be on site during construction activity in potential aquatic and upland habitat. The construction area will be resurveyed whenever there is a lapse in construction activity of 2 weeks or more.
- A preconstruction survey will be conducted in areas proposed for use as borrow sites to determine whether suitable aquatic or upland habitat for giant garter snake is present on the site or within 200 feet of the site. If suitable upland or aquatic habitat is identified in the survey area, the borrow site will not be used to obtain borrow material.
- If a giant garter snake is encountered in the construction work area, construction activities must cease until the snake moves out of the work area unassisted. Capture and relocation of trapped or injured individuals can be attempted only by USFWS-permitted personnel. The applicant or its contractors will notify USFWS within 24 hours and submit a report, including dates, locations, habitat description, and any corrective measures taken to protect the snake(s) encountered. For each giant garter snake encountered, the biologist will submit a completed CNDDDB field survey form (or equivalent) to DFG no more than 90 days after completing the last field visit to the project site.
- Construction personnel will participate in a USFWS-approved worker environmental awareness program (see Mitigation Measure VEG-MM-3 described in Section 3.8, Vegetation and Wetlands). A qualified biologist will inform all construction personnel about the life history of giant garter snake and the terms and conditions of the BO. Proof of this instruction will be submitted to USFWS Sacramento field office.

- To ensure that construction equipment and personnel do not affect giant garter snake aquatic habitat outside the construction work area, orange barrier fencing will be erected to clearly delineate the aquatic habitat to be avoided.
- A post-construction compliance report prepared by a qualified biologist will be forwarded to the chief of the Endangered Species Division of USFWS Sacramento field office within 60 days after completion of the project. This report will include dates that construction occurred, pertinent information about WSAFCA's success in implementing project mitigation measures, an explanation of any failures to implement mitigation measures, any known project effects on federally listed species, any occurrences of incidental take of federally listed species, and any other pertinent information.

Fish Species

WSAFCA will minimize fish stranding by developing and implementing a drainage and grading plan that minimizes the extent of ponding and facilitates complete drainage of the active floodplain to the main river. As part of the final offset area design, WSAFCA will determine the specific topographic and hydrologic characteristics of the levee offset area and will define the flooding regime (depth, duration, and extent of flooding), drainage patterns, and potential fish stranding risks. The final project design will include re-contouring as necessary to facilitate complete drainage and unimpeded fish passage to the main river as floodwaters recede from the levee offset area. Features with substantial stranding risk will be filled and/or graded to minimize this risk.

A mitigation and monitoring plan will be developed by a qualified biologist on behalf of WSAFCA and will be approved by NMFS, USFWS, and DFG before implementation of the levee setback. The mitigation and monitoring plan will evaluate the effectiveness of the grading and drainage features in preventing or reducing fish stranding and will include provisions for remediation should the design fail to meet established performance or success criteria.

Mitigation

The project has been designed to avoid and minimize impacts to waters of the U.S. where practicable. Unavoidable impacts on ditches and the Sacramento River will be compensated for as follows:

Ditches

The Southport project will mitigate for ditch impacts by expanding the existing ditch system on the landward side of the proposed project levee. The plans for the new ditches will be provided when available.

Sacramento River

The Sacramento River will be impacted by the placement of riprap below the ordinary high water mark and the removal of shaded riverine aquatic habitat. Most of the Sacramento River through the impacted reaches is already riprapped and the additional riprap will be filling in eroded areas that have failed or strengthening the rock armor by thickening it. The impacts resulting in riprap would be more than adequately offset through creation of 120 acres of floodplain in the offset areas.

Offset Area Design

A draft restoration plan for the offset areas is being developed and will be submitted to USACE upon completion. The restoration objectives developed for the project include:

- Provide compensatory mitigation credits for impacts to protected land cover types and to special-status species and potential habitat for these species
- Maximize shaded riverine aquatic (SRA)/channel margin habitat, over and above current erosion stabilization efforts using biotechnical methods.
- Enhance offset ecological values using topographic and vegetation/habitat heterogeneity.
- Restore portions of the historic Sacramento River floodplain (i.e., waters of the United States)
- Restore riparian and oak woodland habitat on the restored floodplain that will create continuous habitat corridors for wildlife movement
- Design habitat features to minimize future maintenance obligations (e.g., reduce opportunities for sediment and debris accumulation).
- Design floodplain planting and vegetation management schemes to avoid undesirable hydraulic and sediment transport impacts to the offset levee and offset area.
- Comply with current U.S. Army Corps of Engineers (USACE) levee vegetation policy to balance habitat needs with flood management objectives.

The preliminary target habitats to be restored were identified based on an evaluation of the current extent and condition of riparian and upland habitat, the historical conditions of the Sacramento River floodplain and its associated habitat values, the post-project floodplain conditions, and a review of similar projects in the region.

Approximately 120 acres of habitat floodplain habitat and 21,000 linear feet of SRA habitat will be restored or enhanced as part of the project implementation. The required portion of these acres of riparian habitat and SRA habitat will be used as project mitigation.

Design of the restoration project in the offset area would be initiated once the Southport EIP 65% design and the public review period for the EIS-EIR is underway which is expected in early 2013. Based on designs for the Southport EIP which are currently being finalized, it is anticipated that the offset area would be excavated down to a floodplain elevation of approximately 10.0' NAVD88 and the excavated material would be utilized in constructing portions of the new flood control features. A low-flow swale would be excavated within the restored floodplain with an invert elevation at approximately +7.0' NAVD88 to provide access to the vegetated floodplain terrace and a drainage point back to the main river channel to minimize the potential for fish stranding during flood water recession. The existing Sacramento River levee would be excavated to a lower elevation or completely breached in places to create effective hydrologic connectivity between the restored floodplain and the main river channel.

Seasonal inundation of the floodplain, including restored riparian, woodland, and grassland habitats, would provide seasonal rearing habitat for juvenile salmonids. Based on a habitat suitability index (HSI) developed for juvenile salmonids by ICF International, the restored floodplain is likely to provide optimal or near-optimal rearing habitat for juvenile salmonids. Floodplain and riparian habitat inundation may also benefit other native fishes, including Sacramento splittail and steelhead trout. After young salmon have dispersed from spawning areas, the distribution and abundance of

young salmon is determined largely by their preferences for shallow water and low water velocities, which in large rivers are found mostly along channel margins, floodplains, and other off-channel habitats.

Existing riparian habitat in the Southport EIP project area is limited to a narrow, discontinuous band of riparian vegetation on the Sacramento River levee and at isolated locations in the levee offset area. The primary area for restoring SRA habitat would be focused along the existing riverbank of the Sacramento River. The existing levee is generally positioned along the top of the riverbank. With implementation of the Southport EIP, the new levee would be set back and the existing levee will be degraded, partially or wholly, along the riverbank. Removing the existing levee from the riverbank will allow for substantial lengths of channel margin to be enhanced with riparian vegetation, slope flattening, and in-stream habitat structures. Riparian scrub and cottonwood forest habitat would be established on portions of the restored and/or lowered floodplain relatively close to the Sacramento River and would be subject to recurrent inundation. Riparian shrub habitat would include several willow species, buttonbush, and seedlings of other native riparian species. Cottonwood forest habitat would be subject to recurrent flooding and would include an overstory composed of cottonwood, sycamore, willow, box elder and Oregon ash. Understory riparian species such as California grape and California blackberry would be included in both planting palates to provide diversity in vegetative structure. Elderberry shrubs may be included in the restoration design as long as they don't present a conflict with managing the flood control features. Current project designs call for areas to be stabilized with biotechnical treatments to minimize bank erosion in critical areas. These erosion treatments may be modified to better maximize benefits provided to aquatic species with additional plantings and habitat structures such as root wads or engineered log jams.

Between the riverbank and the new offset levee alignment, a system of swales will be designed that will form the primary riparian and aquatic habitat corridors that will also provide for floodplain drainage of the offset area. Substantial aquatic to terrestrial transition 'edge' habitat will be created along these swales. In addition, topographic heterogeneity will be incorporated into the project design grading plans that will allow for a mosaic of seasonal wetland, riparian wetland, and riparian upland habitats. Seasonal wetland areas will be enhanced with wetland vegetation, while riparian upland habitats will include a variety of willow-scrub, cottonwood forest and oak woodland plantings.

Finally, other enhancements may be incorporated, such as the inclusion of large woody material (root wads/engineered log jams) to provide for additional flow diversity and habitat refugia valuable for aquatic habitats in the offset area.

Construction

Construction of the restoration project will begin with fine grading of the offset area (major grading will be conducted as part of the Southport EIP) in compliance with the construction documents and any earthworks measures associated with the SRA/channel margin enhancement elements. This will involve grading the channel margin slope grading to a flatter profile, installation of instream woody material, and placement of rock reinforcement as required. Following this, installation of the irrigation system for the restoration plantings will occur. Once the irrigation system is installed and confirmed to be working per the construction drawings, the plantings will be installed. This will include installation of container plants or pole cuttings.

Once all planting and irrigation installation activities are complete, final site stabilization will occur with the application of an appropriate restoration seed mix and/or other erosion control measures.

As-built record drawings of the completed project will be prepared once all construction activities have been completed and the completed project has been accepted by the site owner or its designee.

Performance Monitoring

Annual performance of the riparian plantings and SRA/channel margin habitat will take place for the first ten years following construction and will consist of the following:

- vegetation monitoring conducted in accordance with the methodology developed by the California Native Plant Society which includes collection of data along transects or within quadrats, as appropriate to the habitat type,
- qualitative and quantitative monitoring of the physical structure of the channel margin habitat, including persistence of instream woody material installation, recruitment of additional woody material, and performance of rock reinforcement
- documentation of hydrological conditions, animal species observed or detected, integrity of signage and other general conditions, and corrective measures that may be appropriate to ensure relevant success criteria, and
- initial establishment of photodocumentation locations and collection of photographic data.

An annual monitoring report documenting the annual performance monitoring effort will be prepared for submittal to the appropriate resource agencies. The annual report will address the maintenance activities conducted the previous year, monitoring methods, results from the annual vegetation monitoring, photos from the designated photo stations, wildlife observations/detections, and detailed information on the exotic vegetation removal efforts. In addition, each annual report will include the qualitative field information and the summary of the documentation of the planting area conditions.

Special Status Species

Valley Elderberry Longhorn Beetle

WSAFCA will compensate for direct effects (including transplanting) on all elderberry stems measuring 1 inch or more at ground level (i.e., VELB habitat) that are located within 20 feet of construction activities. Compensation will include planting replacement elderberry seedlings or cuttings and associated native plantings in a USFWS-approved conservation area, at a ratio between 1:1 and 8:1 (ratio = new plantings to affected stems), depending on the diameter of the stem at ground level, the presence or absence of exit holes, and whether the shrub is located in riparian habitat.

Mitigation credits for VELB would be purchased at a USFWS-approved mitigation bank or created in an on-site or off-site conservation area. A management plan for the mitigation sites would be developed and implemented according to USFWS Conservation Guidelines for Valley Elderberry Longhorn Beetle. Final compensation requirements and mitigation ratios for VELB will be determined through consultation with USFWS.

Giant Garter Snake

To compensate for the permanent loss of suitable aquatic and upland habitat for giant garter snake, WSAFCA will purchase off-site giant garter snake habitat credits from a USFWS-approved conservation area servicing the project area. Compensation requirements and mitigation ratios for GGS will be determined through consultation with USFWS.

Fish Species

To compensate for losses of riparian vegetation and shaded riverine aquatic (SRA) cover on the waterside slope of the existing levee, WSAFCA will incorporate riparian and wetland vegetation in the design of the offset area. Compensation requirements will be determined following quantification of SRA cover losses and determination of compensation ratios. Breaching the existing levee and lowering the floodplain to achieve frequent inundation of the floodplain will provide an opportunity to compensate and expand the amount of riparian habitat and SRA cover available to fish over a broad range of flows. Compensation and enhancement of SRA cover will be important objectives of the final design. The current conceptual restoration design includes the creation of one or more floodplain swales bordered by wetland and riparian benches to facilitate drainage of the floodplain and movements of fish between the river and floodplain during flood events. These swales and wetland/riparian benches will interface with the Sacramento River at low-elevation transition areas that extend from the floodplain to the river channel at the levee breaches. SRA cover along these swales will be available to fish on a seasonal or year-round basis depending on flows. Full compensation of SRA cover losses will likely take several years as vegetation matures, but SRA cover values within the breach areas will likely exceed the values that will be lost on the existing levee within 10-15 years.

WSAFCA will also implement hand installation of native vegetation outside the vegetation -free zone in the bank stabilization area. This onsite planting would provide additional SRA mitigation in ripped areas. However, compliance with the USACE levee vegetation policy and other regulatory or engineering constraints may limit the ability to achieve full on-site compensation.

Box 25. Addresses of Adjoining Property Owners

See Appendix B.

Box 26. Required Permits and Approvals

The following permits and approvals are required to construct the proposed project. No permit applications have been submitted to date to the CVRWQCB, CDFW, or CVFPB.

Responsible Agency	Permit, Approval, or Consultation
U.S. Fish and Wildlife Service (USFWS)	A Biological Assessment is being prepared by ICF to facilitate formal consultation with USFWS by USACE Operations Division.
National Marine Fisheries Service (NMFS)	A Biological Assessment is being prepared by ICF to facilitate formal consultation with NMFS by USACE Operations Division.
State Office of Historic Preservation	A Programmatic Agreement has been prepared by ICF and submitted by USACE Operations Division to SHPO for review.
Central Valley Regional Water Quality Control Board (CVRWQCB)	Section 401 Water Quality Certification: Application will be filed subsequent to EIS/EIR draft release. NPDES for Construction Activity: a SWPPP will be prepared prior to the commencement of construction activities.
California Department of Fish and Wildlife (CDFW)	An application for a Section 1602 Lake and Streambed Alteration Agreement from DFG will be filed subsequent to EIS/EIR draft release..

Appendix A
Figures

Path: K:\Projects_1\HDRV00071_11_SouthPort\mapdoc\Working\Fig_1_Location_Impact_20130115.mxd AA 1/15/2013

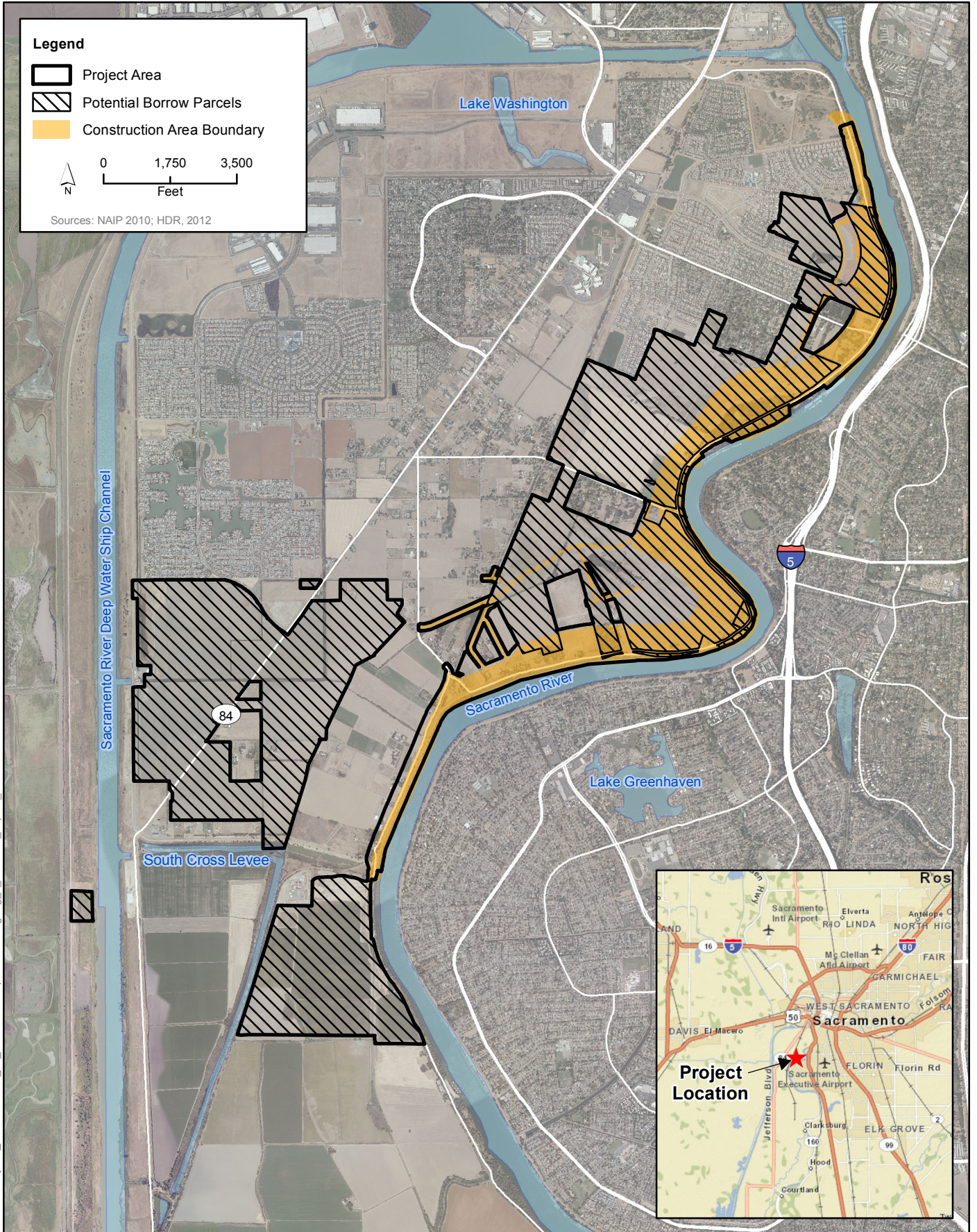
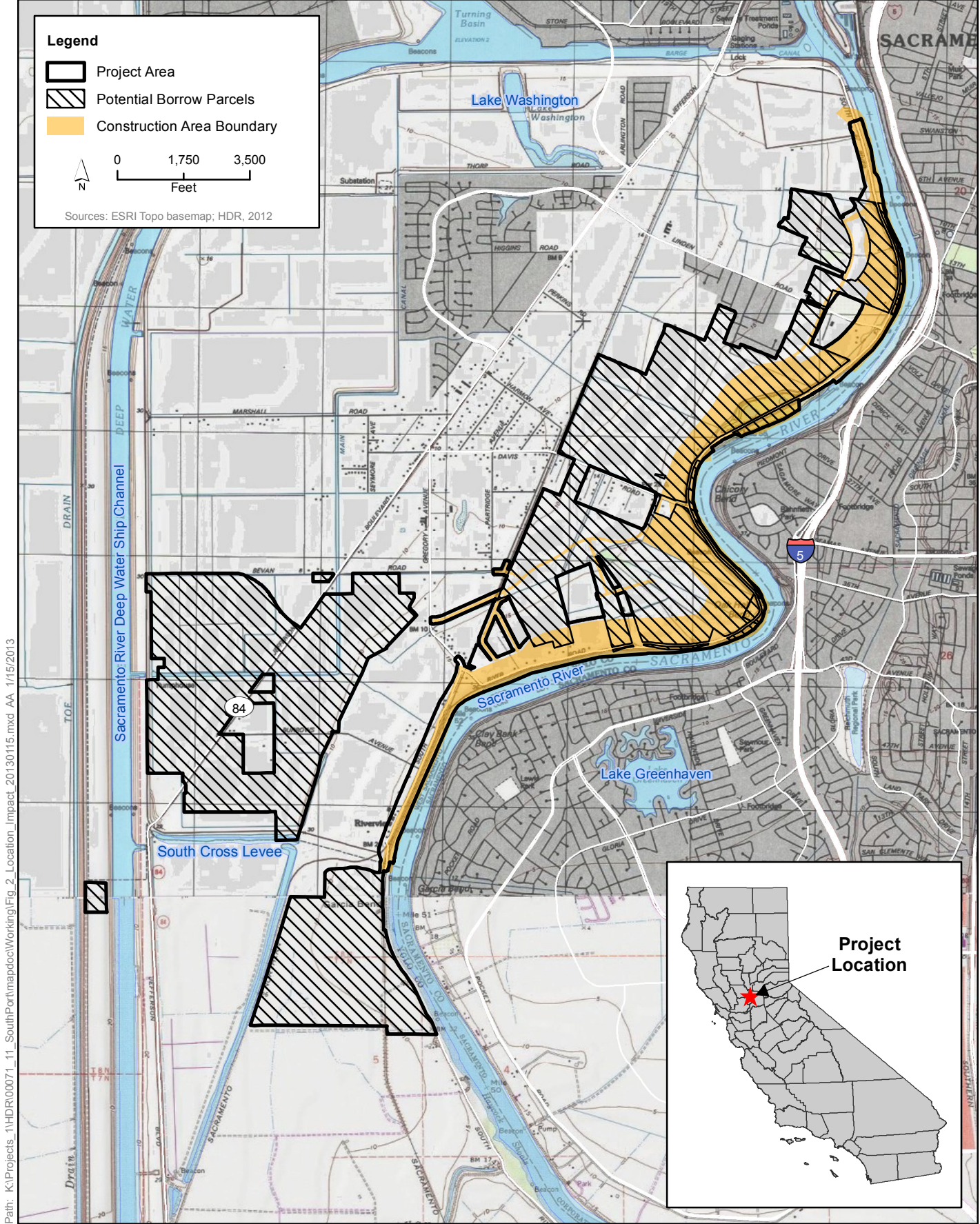

Figure 1
Project Location





Path: K:\Projects_1\HDR\00071_11_SouthPort\mapdoc\Working\Fig_2_Location_Impact_20130115.mxd AA_1/15/2013



Figure 2
Project Location

121°31'10"W

121°31'0"W

121°30'50"W

38°33'20"N

38°33'10"N

121°31'10"W

121°31'0"W

121°30'50"W

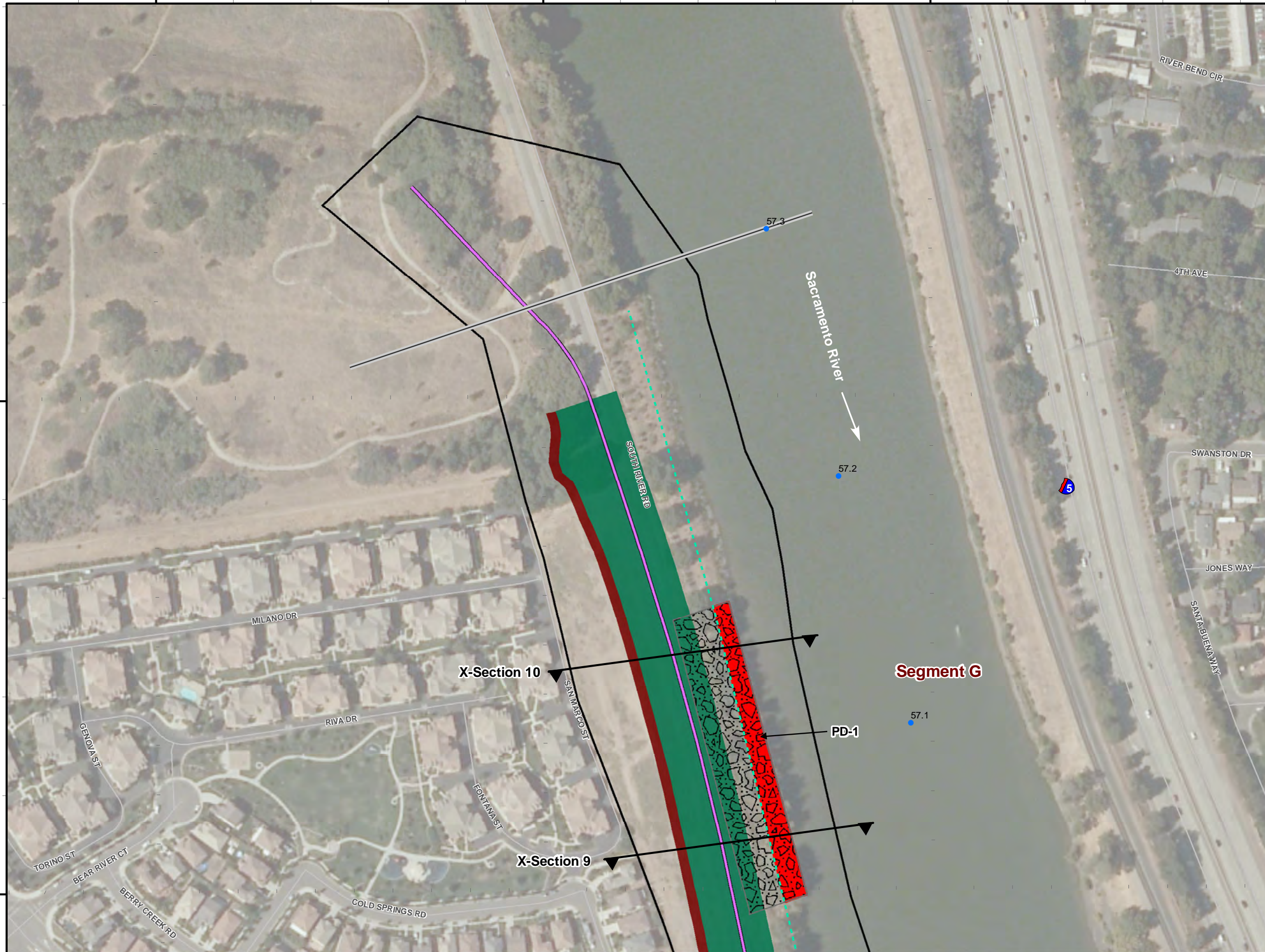



















Figure 3
Project Plan View Showing Impacts
to Potential Waters of the
United States, Including Wetlands

Southport Sacramento River
 Early Implementation Project
 January 2013
 SPK-2012-00462
 Sheet 1 of 19

Legend

-  Construction Area Boundary
-  Permanent Fill (25.659 acres)
-  Ordinary High Water Mark (OHWM)
-  Segment Boundary
-  Sacramento River Mile
-  Pond
-  Ditch
- Project Elements**
-  Cutoff Wall
-  Offset Area Grading
-  Proposed Road
-  O&M Corridor
-  Seepage Berm
-  Adjacent Levee
-  Setback Levee
-  Levee Slope Flattening
-  Bank Stabilization
-  Levee Breach Protection
-  Staging Area

W = Average Width

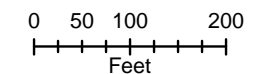

1 inch = 200 feet

Notes:

Source: Project Elements, HDR 12/20/2012
 Base Map Source: ICF, 2012
 Imagery Source: NAIP 2010
 USGS Topo Quad: Sacramento West
 PLSS: Wetlands Land Grant

Prepared By: ICF, International 916.737.3000
 Edward Douglas, February 5, 2013

Path: K:\Projects_1\HDR\00071_11_SouthPort\mapdoc\Working\Impact_Mapbook_20130116.mxd; Author: ; Date: 2/5/2013

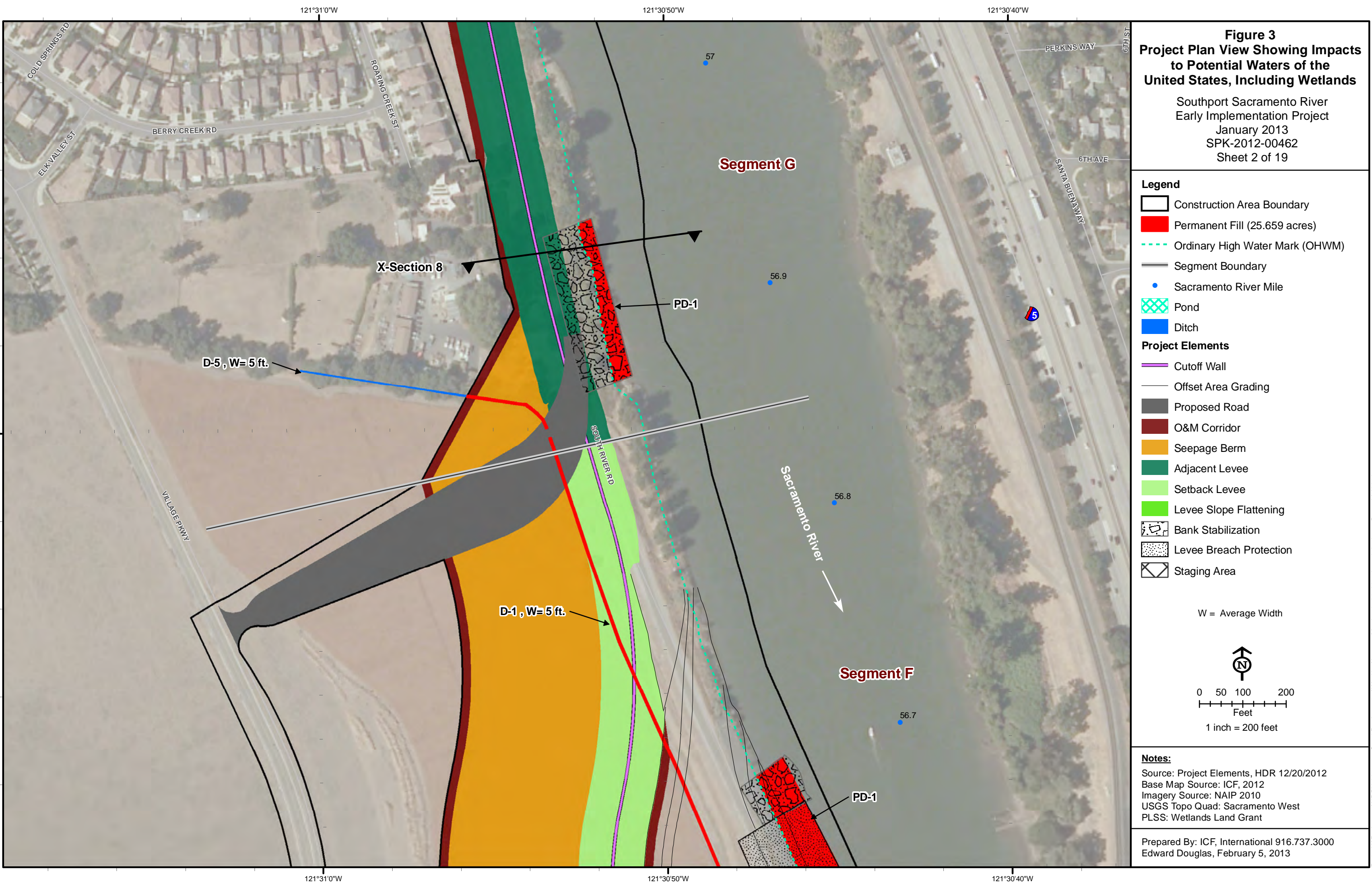

Figure 3
Project Plan View Showing Impacts to Potential Waters of the United States, Including Wetlands
 Southport Sacramento River
 Early Implementation Project
 January 2013
 SPK-2012-00462
 Sheet 2 of 19

Legend

- Construction Area Boundary
- Permanent Fill (25.659 acres)
- Ordinary High Water Mark (OHWM)
- Segment Boundary
- Sacramento River Mile
- Pond
- Ditch

Project Elements

- Cutoff Wall
- Offset Area Grading
- Proposed Road
- O&M Corridor
- Seepage Berm
- Adjacent Levee
- Setback Levee
- Levee Slope Flattening
- Bank Stabilization
- Levee Breach Protection
- Staging Area

W = Average Width

0 50 100 200
 Feet
 1 inch = 200 feet

Notes:
 Source: Project Elements, HDR 12/20/2012
 Base Map Source: ICF, 2012
 Imagery Source: NAIP 2010
 USGS Topo Quad: Sacramento West
 PLSS: Wetlands Land Grant

Prepared By: ICF, International 916.737.3000
 Edward Douglas, February 5, 2013

Path: K:\Projects_1\HDR\00071_11_SouthPort\mapdoc\Working\Impact_Mapbook_20130116.mxd; Author: ; Date: 2/5/2013

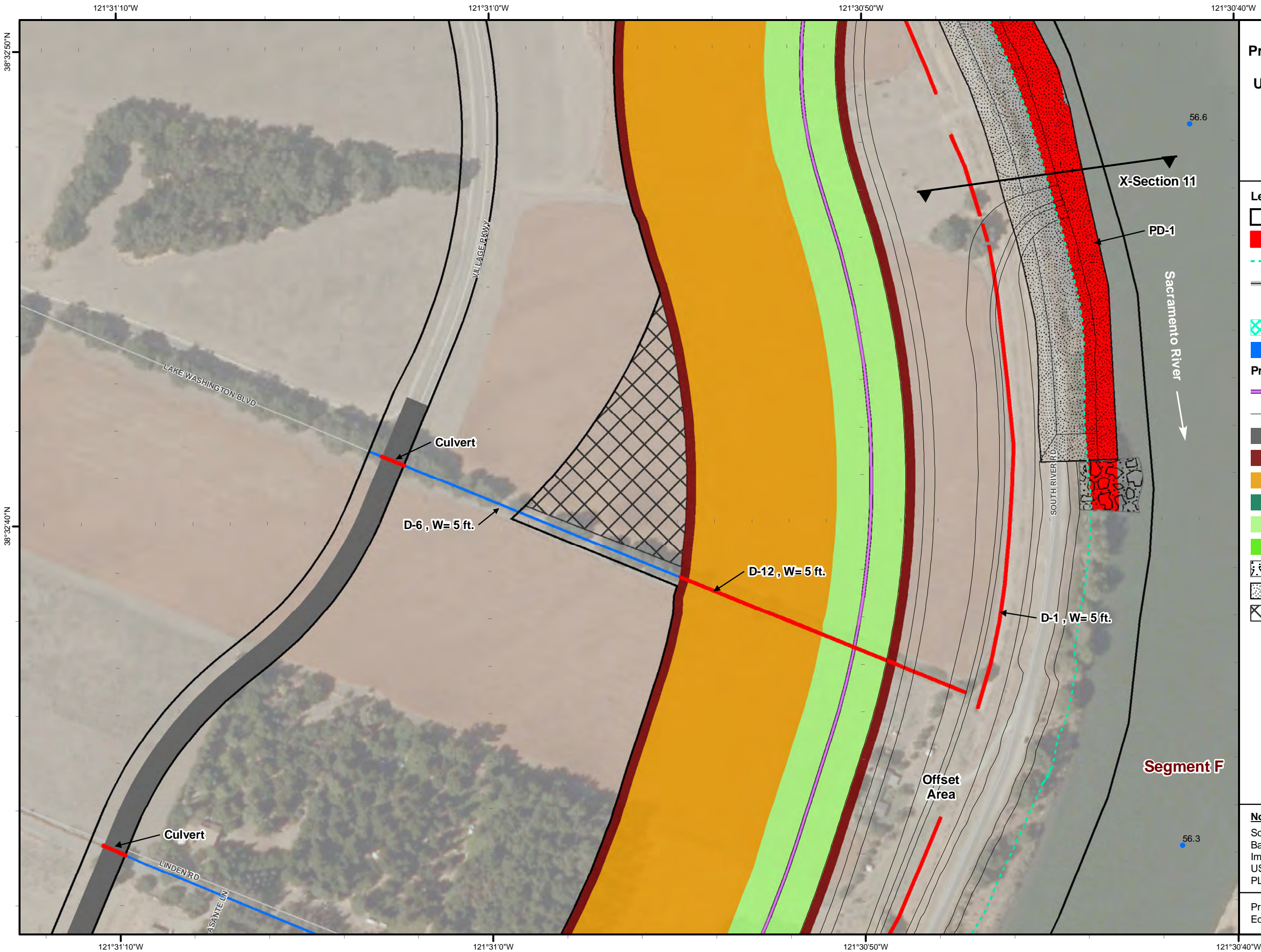

Figure 3
Project Plan View Showing Impacts to Potential Waters of the United States, Including Wetlands
 Southport Sacramento River
 Early Implementation Project
 January 2013
 SPK-2012-00462
 Sheet 3 of 19

Legend

- Construction Area Boundary
- Permanent Fill (25.659 acres)
- Ordinary High Water Mark (OHWM)
- Segment Boundary
- Sacramento River Mile
- Pond
- Ditch

Project Elements

- Cutoff Wall
- Offset Area Grading
- Proposed Road
- O&M Corridor
- Seepage Berm
- Adjacent Levee
- Setback Levee
- Levee Slope Flattening
- Bank Stabilization
- Levee Breach Protection
- Staging Area

W = Average Width

0 50 100 200
 Feet
 1 inch = 200 feet

Notes:
 Source: Project Elements, HDR 12/20/2012
 Base Map Source: ICF, 2012
 Imagery Source: NAIP 2010
 USGS Topo Quad: Sacramento West
 PLSS: Wetlands Land Grant

Prepared By: ICF, International 916.737.3000
 Edward Douglas, February 5, 2013

Path: K:\Projects_1\HDR\00071_11_SouthPort\mapdoc\Working\Impact_Mapbook_20130116.mxd; Author: ; Date: 2/5/2013

Figure 3
Project Plan View Showing Impacts to Potential Waters of the United States, Including Wetlands

Southport Sacramento River
 Early Implementation Project
 January 2013
 SPK-2012-00462
 Sheet 4 of 19

Legend

- Construction Area Boundary
- Permanent Fill (25.659 acres)
- Ordinary High Water Mark (OHWM)
- Segment Boundary
- Sacramento River Mile
- Pond
- Ditch

Project Elements

- Cutoff Wall
- Offset Area Grading
- Proposed Road
- O&M Corridor
- Seepage Berm
- Adjacent Levee
- Setback Levee
- Levee Slope Flattening
- Bank Stabilization
- Levee Breach Protection
- Staging Area

W = Average Width

0 50 100 200
 Feet
 1 inch = 200 feet

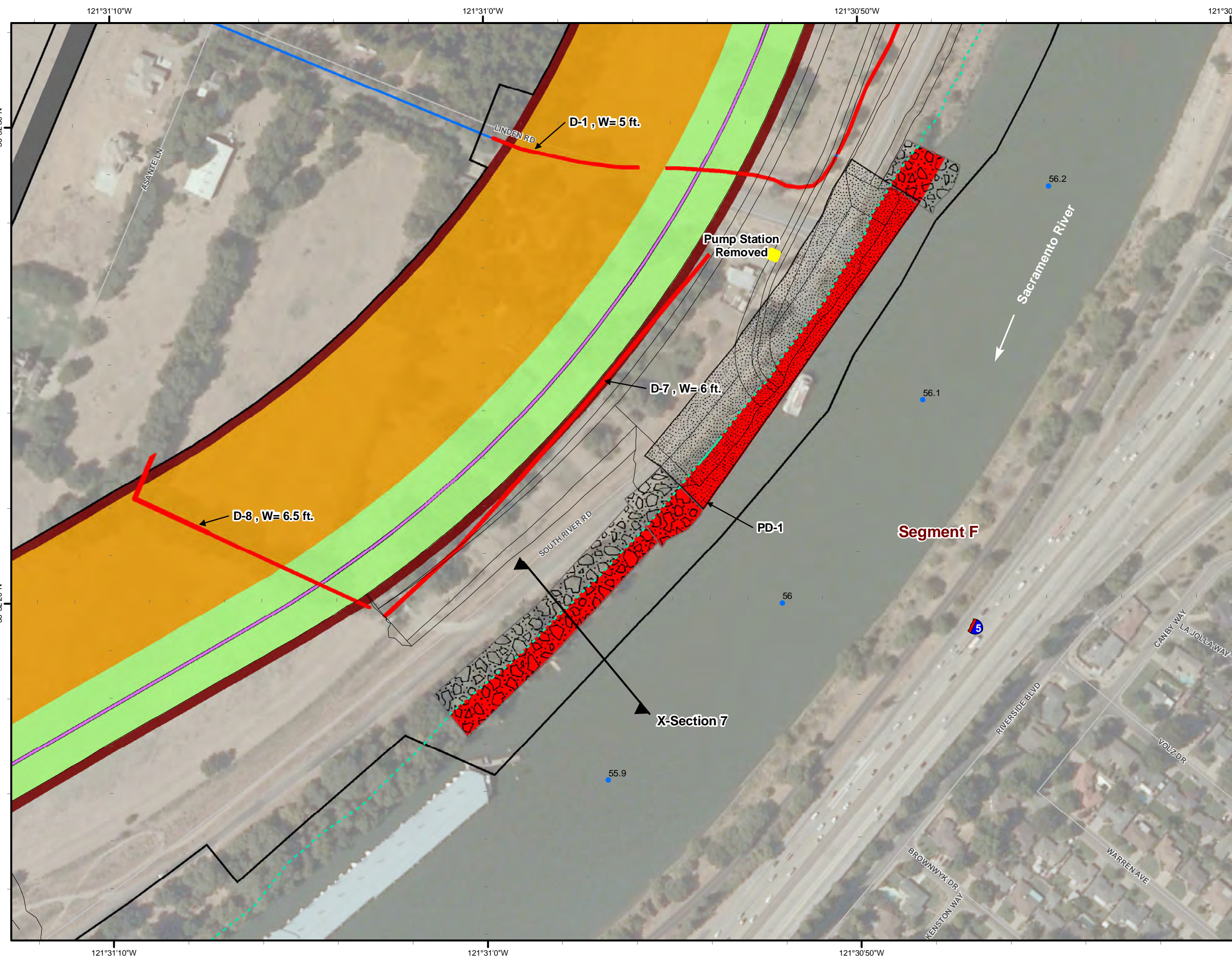

Notes:
 Source: Project Elements, HDR 12/20/2012
 Base Map Source: ICF, 2012
 Imagery Source: NAIP 2010
 USGS Topo Quad: Sacramento West
 PLSS: Wetlands Land Grant

Prepared By: ICF, International 916.737.3000
 Edward Douglas, February 5, 2013

Path: K:\Projects_1\HDR\00071_11_SouthPort\mapdoc\Working\Impact_Mapbook_20130116.mxd; Author: ; Date: 2/5/2013



Figure 3
Project Plan View Showing Impacts to Potential Waters of the United States, Including Wetlands
 Southport Sacramento River
 Early Implementation Project
 January 2013
 SPK-2012-00462
 Sheet 5 of 19

Legend

- Construction Area Boundary
- Permanent Fill (25.659 acres)
- Ordinary High Water Mark (OHWM)
- Segment Boundary
- Sacramento River Mile
- Pond
- Ditch

Project Elements

- Cutoff Wall
- Offset Area Grading
- Proposed Road
- O&M Corridor
- Seepage Berm
- Adjacent Levee
- Setback Levee
- Levee Slope Flattening
- Bank Stabilization
- Levee Breach Protection
- Staging Area

W = Average Width

0 50 100 200
 Feet
 1 inch = 200 feet

Notes:
 Source: Project Elements, HDR 12/20/2012
 Base Map Source: ICF, 2012
 Imagery Source: NAIP 2010
 USGS Topo Quad: Sacramento West
 PLSS: Wetlands Land Grant

Prepared By: ICF, International 916.737.3000
 Edward Douglas, February 5, 2013

Path: K:\Projects_1\HDR\00071_11_SouthPort\mapdoc\Working\Impact_Mapbook_20130116.mxd; Author: ; Date: 2/5/2013

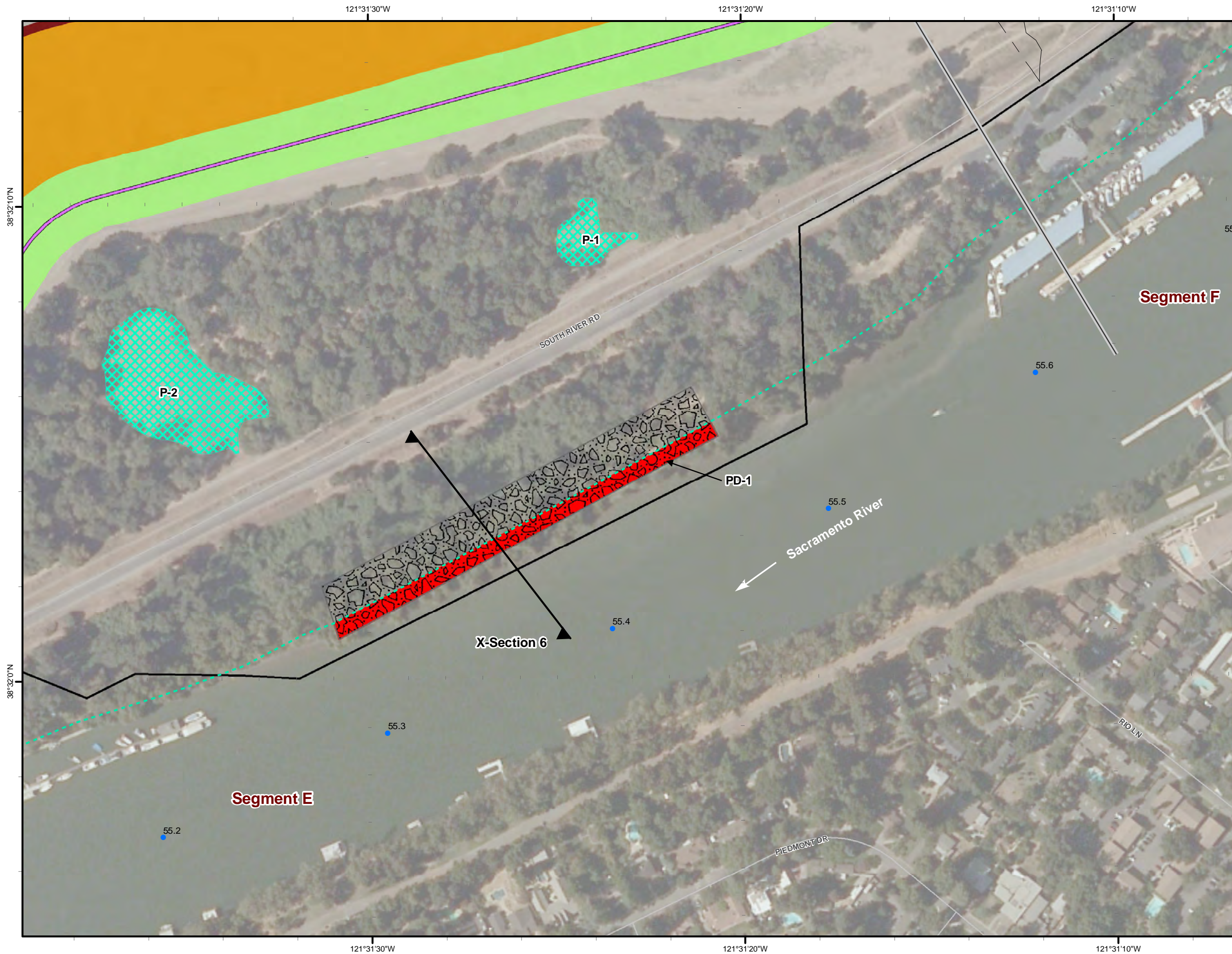

Figure 3
Project Plan View Showing Impacts to Potential Waters of the United States, Including Wetlands
 Southport Sacramento River
 Early Implementation Project
 January 2013
 SPK-2012-00462
 Sheet 6 of 19

Legend

- Construction Area Boundary
- Permanent Fill (25.659 acres)
- Ordinary High Water Mark (OHWM)
- Segment Boundary
- Sacramento River Mile
- Pond
- Ditch

Project Elements

- Cutoff Wall
- Offset Area Grading
- Proposed Road
- O&M Corridor
- Seepage Berm
- Adjacent Levee
- Setback Levee
- Levee Slope Flattening
- Bank Stabilization
- Levee Breach Protection
- Staging Area

W = Average Width

0 50 100 200
 Feet
 1 inch = 200 feet

Notes:
 Source: Project Elements, HDR 12/20/2012
 Base Map Source: ICF, 2012
 Imagery Source: NAIP 2010
 USGS Topo Quad: Sacramento West
 PLSS: Wetlands Land Grant

Prepared By: ICF, International 916.737.3000
 Edward Douglas, February 5, 2013

Path: K:\Projects_1\HDR\00071_11_SouthPort\mapdoc\Working\Impact_Mapbook_20130116.mxd; Author: ; Date: 2/5/2013

121°32'10"W 121°32'0"W 121°31'50"W 121°31'40"W

38°32'10"N



















38°32'0"N

121°32'10"W 121°32'0"W 121°31'50"W 121°31'40"W

Figure 3 Project Plan View Showing Impacts to Potential Waters of the United States, Including Wetlands

Southport Sacramento River
Early Implementation Project
January 2013
SPK-2012-00462
Sheet 7 of 19

Legend

-  Construction Area Boundary
-  Permanent Fill (25.659 acres)
-  Ordinary High Water Mark (OHWM)
-  Segment Boundary
-  Sacramento River Mile
-  Pond
-  Ditch
- Project Elements**
-  Cutoff Wall
-  Offset Area Grading
-  Proposed Road
-  O&M Corridor
-  Seepage Berm
-  Adjacent Levee
-  Setback Levee
-  Levee Slope Flattening
-  Bank Stabilization
-  Levee Breach Protection
-  Staging Area

W = Average Width



0 50 100 200
Feet

1 inch = 200 feet

Notes:

Source: Project Elements, HDR 12/20/2012
Base Map Source: ICF, 2012
Imagery Source: NAIP 2010
USGS Topo Quad: Sacramento West
PLSS: Wetlands Land Grant

Prepared By: ICF, International 916.737.3000
Edward Douglas, February 5, 2013



Path: K:\Projects_1\HDR\00071_11_SouthPort\mapdoc\Working\Impact_Mapbook_20130116.mxd; Author: ; Date: 2/5/2013

121°32'10"W

121°32'0"W

121°31'50"W

Figure 3
Project Plan View Showing Impacts to Potential Waters of the United States, Including Wetlands
 Southport Sacramento River
 Early Implementation Project
 January 2013
 SPK-2012-00462
 Sheet 8 of 19

- Legend**
- Construction Area Boundary
 - Permanent Fill (25.659 acres)
 - Ordinary High Water Mark (OHWM)
 - Segment Boundary
 - Sacramento River Mile
 - Pond
 - Ditch
- Project Elements**
- Cutoff Wall
 - Offset Area Grading
 - Proposed Road
 - O&M Corridor
 - Seepage Berm
 - Adjacent Levee
 - Setback Levee
 - Levee Slope Flattening
 - Bank Stabilization
 - Levee Breach Protection
 - Staging Area

W = Average Width

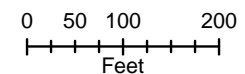

1 inch = 200 feet

Notes:
 Source: Project Elements, HDR 12/20/2012
 Base Map Source: ICF, 2012
 Imagery Source: NAIP 2010
 USGS Topo Quad: Sacramento West
 PLSS: Wetlands Land Grant

Prepared By: ICF, International 916.737.3000
 Edward Douglas, February 5, 2013

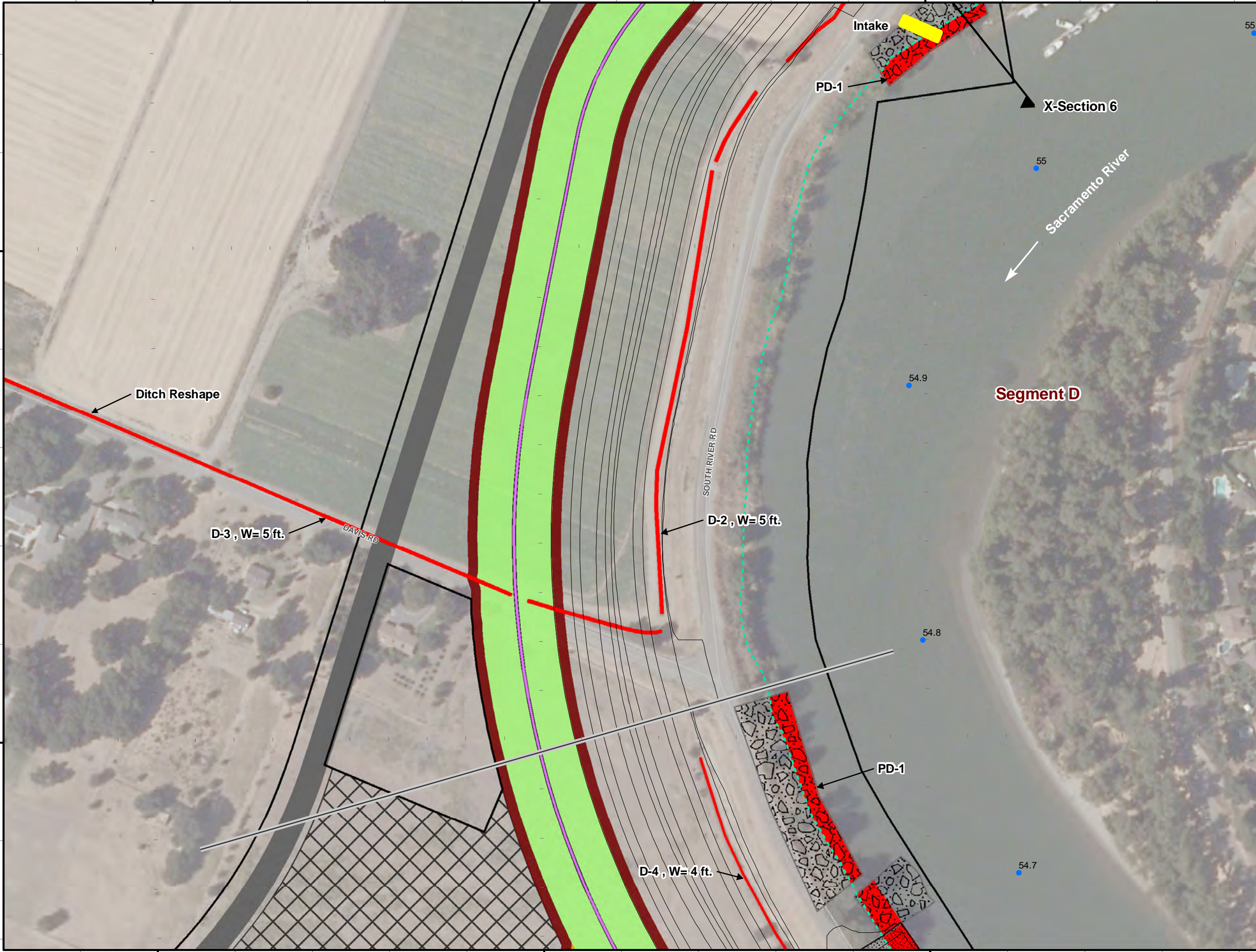

38°31'50"N

38°31'40"N

121°32'10"W

121°32'0"W

121°31'50"W

Path: K:\Projects_1\HDR\00071_11_SouthPort\mapdoc\Working\Impact_Mapbook_20130116.mxd; Author: ; Date: 2/5/2013



Figure 3
Project Plan View Showing Impacts to Potential Waters of the United States, Including Wetlands

Southport Sacramento River
 Early Implementation Project
 January 2013
 SPK-2012-00462
 Sheet 9 of 19

- Legend**
- Construction Area Boundary
 - Permanent Fill (25.659 acres)
 - Ordinary High Water Mark (OHWM)
 - Segment Boundary
 - Sacramento River Mile
 - Pond
 - Ditch
- Project Elements**
- Cutoff Wall
 - Offset Area Grading
 - Proposed Road
 - O&M Corridor
 - Seepage Berm
 - Adjacent Levee
 - Setback Levee
 - Levee Slope Flattening
 - Bank Stabilization
 - Levee Breach Protection
 - Staging Area

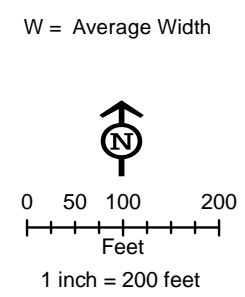

Notes:
 Source: Project Elements, HDR 12/20/2012
 Base Map Source: ICF, 2012
 Imagery Source: NAIP 2010
 USGS Topo Quad: Sacramento West
 PLSS: Wetlands Land Grant

Prepared By: ICF, International 916.737.3000
 Edward Douglas, February 5, 2013

Path: K:\Projects_1\HDR\00071_11_SouthPort\mapdoc\Working\Impact_Mapbook_20130116.mxd; Author: ; Date: 2/5/2013

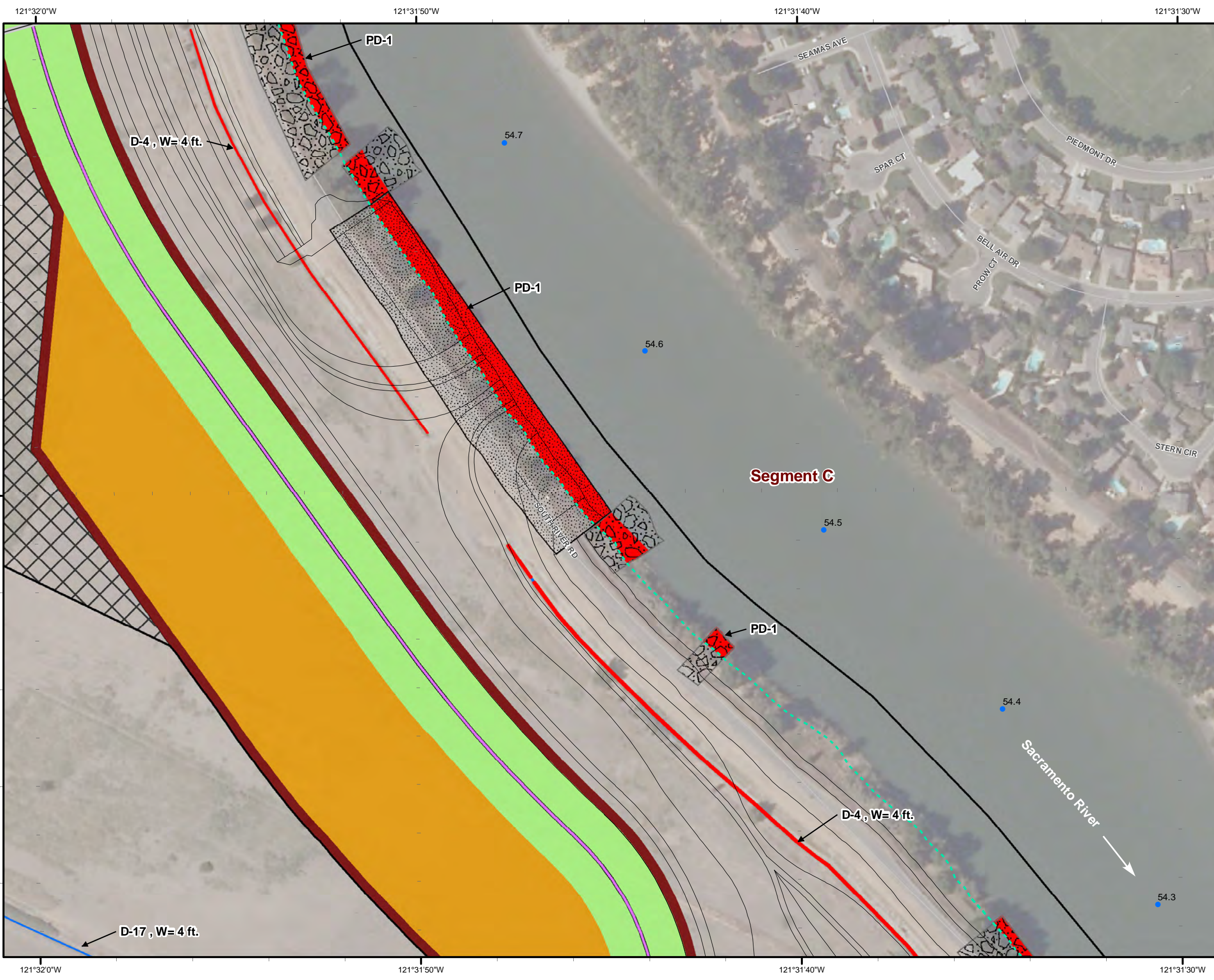

Figure 3
Project Plan View Showing Impacts to Potential Waters of the United States, Including Wetlands
 Southport Sacramento River
 Early Implementation Project
 January 2013
 SPK-2012-00462
 Sheet 10 of 19

Legend

- Construction Area Boundary
- Permanent Fill (25.659 acres)
- Ordinary High Water Mark (OHWM)
- Segment Boundary
- Sacramento River Mile
- Pond
- Ditch

Project Elements

- Cutoff Wall
- Offset Area Grading
- Proposed Road
- O&M Corridor
- Seepage Berm
- Adjacent Levee
- Setback Levee
- Levee Slope Flattening
- Bank Stabilization
- Levee Breach Protection
- Staging Area

W = Average Width

0 50 100 200
 Feet
 1 inch = 200 feet

Notes:
 Source: Project Elements, HDR 12/20/2012
 Base Map Source: ICF, 2012
 Imagery Source: NAIP 2010
 USGS Topo Quad: Sacramento West
 PLSS: Wetlands Land Grant

Prepared By: ICF, International 916.737.3000
 Edward Douglas, February 5, 2013

Path: K:\Projects_1\HDR\00071_11_SouthPort\mapdoc\Working\Impact_Mapbook_20130116.mxd; Author: ; Date: 2/5/2013

121°32'30"W

121°32'20"W

121°32'10"W

121°32'0"W

38°31'30"N

38°31'20"N

121°32'30"W

121°32'20"W



















121°32'10"W

121°32'0"W

Figure 3 Project Plan View Showing Impacts to Potential Waters of the United States, Including Wetlands

Southport Sacramento River
Early Implementation Project
January 2013
SPK-2012-00462
Sheet 11 of 19

Legend

-  Construction Area Boundary
-  Permanent Fill (25.659 acres)
-  Ordinary High Water Mark (OHWM)
-  Segment Boundary
-  Sacramento River Mile
-  Pond
-  Ditch
- Project Elements**
-  Cutoff Wall
-  Offset Area Grading
-  Proposed Road
-  O&M Corridor
-  Seepage Berm
-  Adjacent Levee
-  Setback Levee
-  Levee Slope Flattening
-  Bank Stabilization
-  Levee Breach Protection
-  Staging Area

W = Average Width



0 50 100 200
Feet

1 inch = 200 feet

Notes:

Source: Project Elements, HDR 12/20/2012
Base Map Source: ICF, 2012
Imagery Source: NAIP 2010
USGS Topo Quad: Sacramento West
PLSS: Wetlands Land Grant

Prepared By: ICF, International 916.737.3000
Edward Douglas, February 5, 2013

Path: K:\Projects_1\HDR\00071_11_SouthPort\mapdoc\Working\Impact_Mapbook_20130116.mxd; Author: ; Date: 2/5/2013

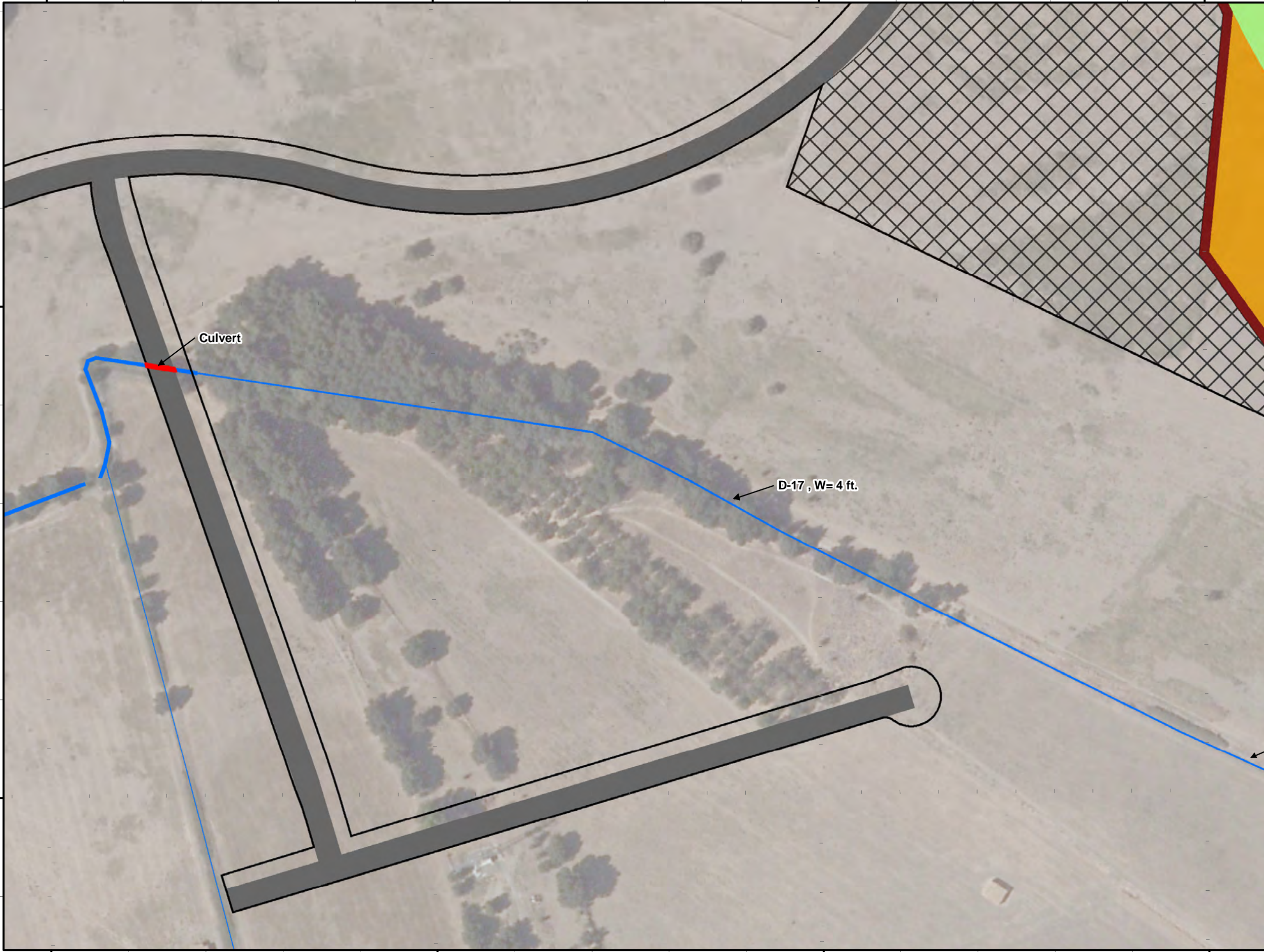



Figure 3
Project Plan View Showing Impacts to Potential Waters of the United States, Including Wetlands
 Southport Sacramento River
 Early Implementation Project
 January 2013
 SPK-2012-00462
 Sheet 12 of 19

Legend

- Construction Area Boundary
- Permanent Fill (25.659 acres)
- Ordinary High Water Mark (OHWM)
- Segment Boundary
- Sacramento River Mile
- Pond
- Ditch

Project Elements

- Cutoff Wall
- Offset Area Grading
- Proposed Road
- O&M Corridor
- Seepage Berm
- Adjacent Levee
- Setback Levee
- Levee Slope Flattening
- Bank Stabilization
- Levee Breach Protection
- Staging Area

W = Average Width

0 50 100 200
 Feet
 1 inch = 200 feet

Notes:
 Source: Project Elements, HDR 12/20/2012
 Base Map Source: ICF, 2012
 Imagery Source: NAIP 2010
 USGS Topo Quad: Sacramento West
 PLSS: Wetlands Land Grant

Prepared By: ICF, International 916.737.3000
 Edward Douglas, February 5, 2013

Path: K:\Projects_1\HDR\00071_11_SouthPort\mapdoc\Working\Impact_Mapbook_20130116.mxd; Author: ; Date: 2/5/2013

121°33'30"W

121°33'20"W

121°33'10"W

38°31'10"N

121°33'30"W



















121°33'20"W

121°33'10"W

Figure 3
Project Plan View Showing Impacts
to Potential Waters of the
United States, Including Wetlands

Southport Sacramento River
 Early Implementation Project
 January 2013
 SPK-2012-00462
 Sheet 13 of 19

Legend

-  Construction Area Boundary
-  Permanent Fill (25.659 acres)
-  Ordinary High Water Mark (OHWM)
-  Segment Boundary
-  Sacramento River Mile
-  Pond
-  Ditch
- Project Elements**
-  Cutoff Wall
-  Offset Area Grading
-  Proposed Road
-  O&M Corridor
-  Seepage Berm
-  Adjacent Levee
-  Setback Levee
-  Levee Slope Flattening
-  Bank Stabilization
-  Levee Breach Protection
-  Staging Area

W = Average Width



0 50 100 200
 Feet

1 inch = 200 feet

Notes:

Source: Project Elements, HDR 12/20/2012
 Base Map Source: ICF, 2012
 Imagery Source: NAIP 2010
 USGS Topo Quad: Sacramento West
 PLSS: Wetlands Land Grant

Prepared By: ICF, International 916.737.3000
 Edward Douglas, February 5, 2013

Path: K:\Projects_1\HDR\00071_11_SouthPort\mapdoc\Working\Impact_Mapbook_20130116.mxd; Author: ; Date: 2/5/2013

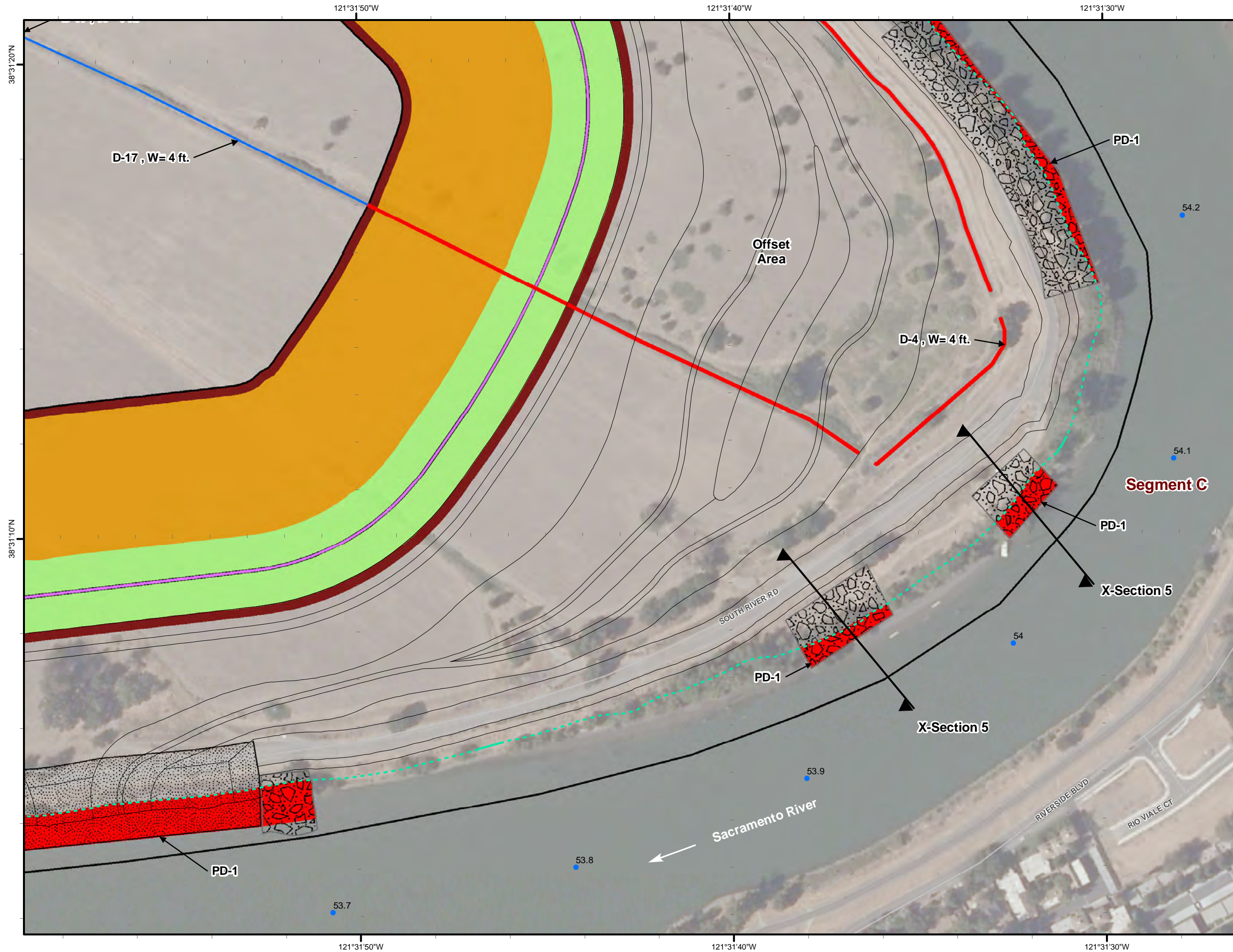

Figure 3
Project Plan View Showing Impacts to Potential Waters of the United States, Including Wetlands
 Southport Sacramento River
 Early Implementation Project
 January 2013
 SPK-2012-00462
 Sheet 14 of 19

Legend

- Construction Area Boundary
- Permanent Fill (25.659 acres)
- Ordinary High Water Mark (OHWM)
- Segment Boundary
- Sacramento River Mile
- Pond
- Ditch

Project Elements

- Cutoff Wall
- Offset Area Grading
- Proposed Road
- O&M Corridor
- Seepage Berm
- Adjacent Levee
- Setback Levee
- Levee Slope Flattening
- Bank Stabilization
- Levee Breach Protection
- Staging Area

W = Average Width

0 50 100 200
 Feet
 1 inch = 200 feet

Notes:
 Source: Project Elements, HDR 12/20/2012
 Base Map Source: ICF, 2012
 Imagery Source: NAIP 2010
 USGS Topo Quad: Sacramento West
 PLSS: Wetlands Land Grant

Prepared By: ICF, International 916.737.3000
 Edward Douglas, February 5, 2013



















Path: K:\Projects_1\HDR\00071_11_SouthPort\mapdoc\Working\Impact_Mapbook_20130116.mxd; Author: ; Date: 2/5/2013

121°32'30"W 121°32'20"W 121°32'10"W 121°32'0"W

Figure 3
Project Plan View Showing Impacts to Potential Waters of the United States, Including Wetlands

Southport Sacramento River
 Early Implementation Project
 January 2013
 SPK-2012-00462
 Sheet 15 of 19

Legend

-  Construction Area Boundary
-  Permanent Fill (25.659 acres)
-  Ordinary High Water Mark (OHWM)
-  Segment Boundary
-  Sacramento River Mile
-  Pond
-  Ditch
- Project Elements**
-  Cutoff Wall
-  Offset Area Grading
-  Proposed Road
-  O&M Corridor
-  Seepage Berm
-  Adjacent Levee
-  Setback Levee
-  Levee Slope Flattening
-  Bank Stabilization
-  Levee Breach Protection
-  Staging Area

W = Average Width

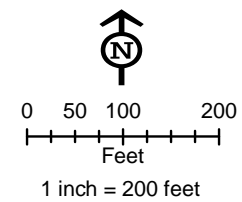

Notes:

Source: Project Elements, HDR 12/20/2012
 Base Map Source: ICF, 2012
 Imagery Source: NAIP 2010
 USGS Topo Quad: Sacramento West
 PLSS: Wetlands Land Grant

Prepared By: ICF, International 916.737.3000
 Edward Douglas, February 5, 2013



Path: K:\Projects_1\HDR\00071_11_SouthPort\mapdoc\Working\Impact_Mapbook_20130116.mxd; Author: ; Date: 2/5/2013



Figure 3
Project Plan View Showing Impacts to Potential Waters of the United States, Including Wetlands

Southport Sacramento River
 Early Implementation Project
 January 2013
 SPK-2012-00462
 Sheet 16 of 19

- Legend**
- Construction Area Boundary
 - Permanent Fill (25.659 acres)
 - Ordinary High Water Mark (OHWM)
 - Segment Boundary
 - Sacramento River Mile
 - Pond
 - Ditch
- Project Elements**
- Cutoff Wall
 - Offset Area Grading
 - Proposed Road
 - O&M Corridor
 - Seepage Berm
 - Adjacent Levee
 - Setback Levee
 - Levee Slope Flattening
 - Bank Stabilization
 - Levee Breach Protection
 - Staging Area

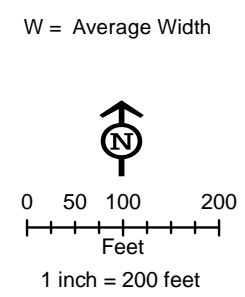

Notes:
 Source: Project Elements, HDR 12/20/2012
 Base Map Source: ICF, 2012
 Imagery Source: NAIP 2010
 USGS Topo Quad: Sacramento West
 PLSS: Wetlands Land Grant

Prepared By: ICF, International 916.737.3000
 Edward Douglas, February 5, 2013

Path: K:\Projects_1\HDR\00071_11_SouthPort\mapdoc\Working\Impact_Mapbook_20130116.mxd; Author: ; Date: 2/5/2013

121°33'20"W 121°33'10"W 121°33'0"W 121°32'50"W

38°31'0"N



















38°30'50"N

121°33'20"W 121°33'10"W 121°33'0"W 121°32'50"W

Figure 3
Project Plan View Showing Impacts
to Potential Waters of the
United States, Including Wetlands

Southport Sacramento River
 Early Implementation Project
 January 2013
 SPK-2012-00462
 Sheet 17 of 19

Legend

-  Construction Area Boundary
-  Permanent Fill (25.659 acres)
-  Ordinary High Water Mark (OHWM)
-  Segment Boundary
-  Sacramento River Mile
-  Pond
-  Ditch
- Project Elements**
-  Cutoff Wall
-  Offset Area Grading
-  Proposed Road
-  O&M Corridor
-  Seepage Berm
-  Adjacent Levee
-  Setback Levee
-  Levee Slope Flattening
-  Bank Stabilization
-  Levee Breach Protection
-  Staging Area

W = Average Width

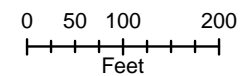

1 inch = 200 feet

Notes:

Source: Project Elements, HDR 12/20/2012
 Base Map Source: ICF, 2012
 Imagery Source: NAIP 2010
 USGS Topo Quad: Sacramento West
 PLSS: Wetlands Land Grant

Prepared By: ICF, International 916.737.3000
 Edward Douglas, February 5, 2013

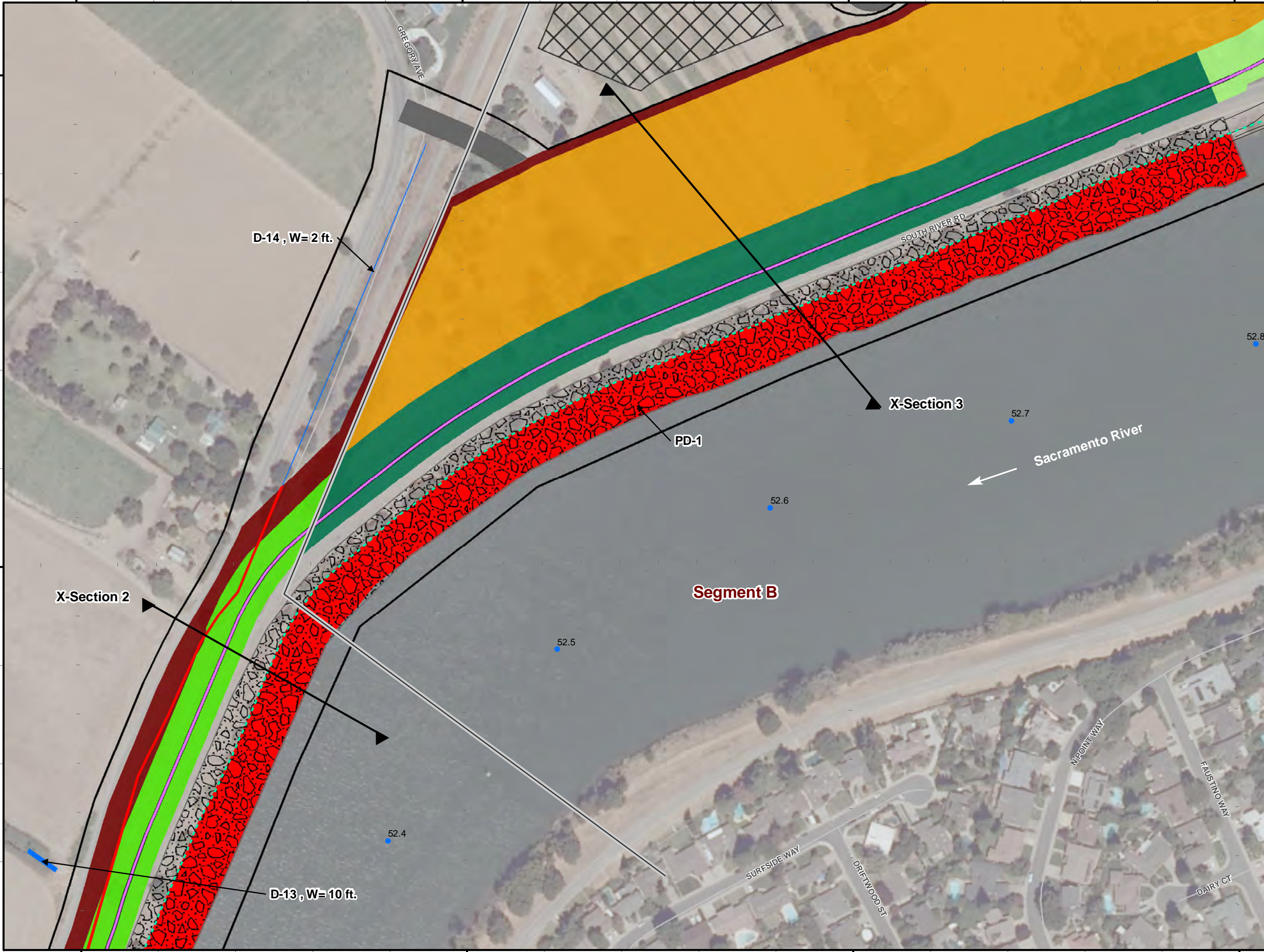

Path: K:\Projects_1\HDR\00071_11_SouthPort\mapdoc\Working\Impact_Mapbook_20130116.mxd; Author: ; Date: 2/5/2013



Figure 3
Project Plan View Showing Impacts to Potential Waters of the United States, Including Wetlands
 Southport Sacramento River
 Early Implementation Project
 January 2013
 SPK-2012-00462
 Sheet 18 of 19

Legend

- Construction Area Boundary
- Permanent Fill (25.659 acres)
- Ordinary High Water Mark (OHWM)
- Segment Boundary
- Sacramento River Mile
- Pond
- Ditch

Project Elements

- Cutoff Wall
- Offset Area Grading
- Proposed Road
- O&M Corridor
- Seepage Berm
- Adjacent Levee
- Setback Levee
- Levee Slope Flattening
- Bank Stabilization
- Levee Breach Protection
- Staging Area

W = Average Width

0 50 100 200
 Feet
 1 inch = 200 feet

Notes:
 Source: Project Elements, HDR 12/20/2012
 Base Map Source: ICF, 2012
 Imagery Source: NAIP 2010
 USGS Topo Quad: Sacramento West
 PLSS: Wetlands Land Grant

Prepared By: ICF, International 916.737.3000
 Edward Douglas, February 5, 2013

Path: K:\Projects_1\HDR\00071_11_SouthPort\mapdoc\Working\Impact_Mapbook_20130116.mxd; Author: ; Date: 2/5/2013

121°33'40"W

121°33'30"W

121°33'20"W

38°30'20"N

38°30'10"N

121°33'40"W

121°33'30"W

121°33'20"W

Figure 3
Project Plan View Showing Impacts
to Potential Waters of the
United States, Including Wetlands

Southport Sacramento River
 Early Implementation Project
 January 2013
 SPK-2012-00462
 Sheet 19 of 19

Legend

- Construction Area Boundary
- Permanent Fill (25.659 acres)
- Ordinary High Water Mark (OHWM)
- Segment Boundary
- Sacramento River Mile
- Pond
- Ditch

Project Elements

- Cutoff Wall
- Offset Area Grading
- Proposed Road
- O&M Corridor
- Seepage Berm
- Adjacent Levee
- Setback Levee
- Levee Slope Flattening
- Bank Stabilization
- Levee Breach Protection
- Staging Area

W = Average Width

0 50 100 200
Feet
1 inch = 200 feet



Notes:
 Source: Project Elements, HDR 12/20/2012
 Base Map Source: ICF, 2012
 Imagery Source: NAIP 2010
 USGS Topo Quad: Sacramento West
 PLSS: Wetlands Land Grant

Prepared By: ICF, International 916.737.3000
 Edward Douglas, February 5, 2013

Path: K:\Projects_1\HDR\00071_11_SouthPort\mapdoc\Working\Impact_Mapbook_20130116.mxd; Author: ; Date: 2/5/2013

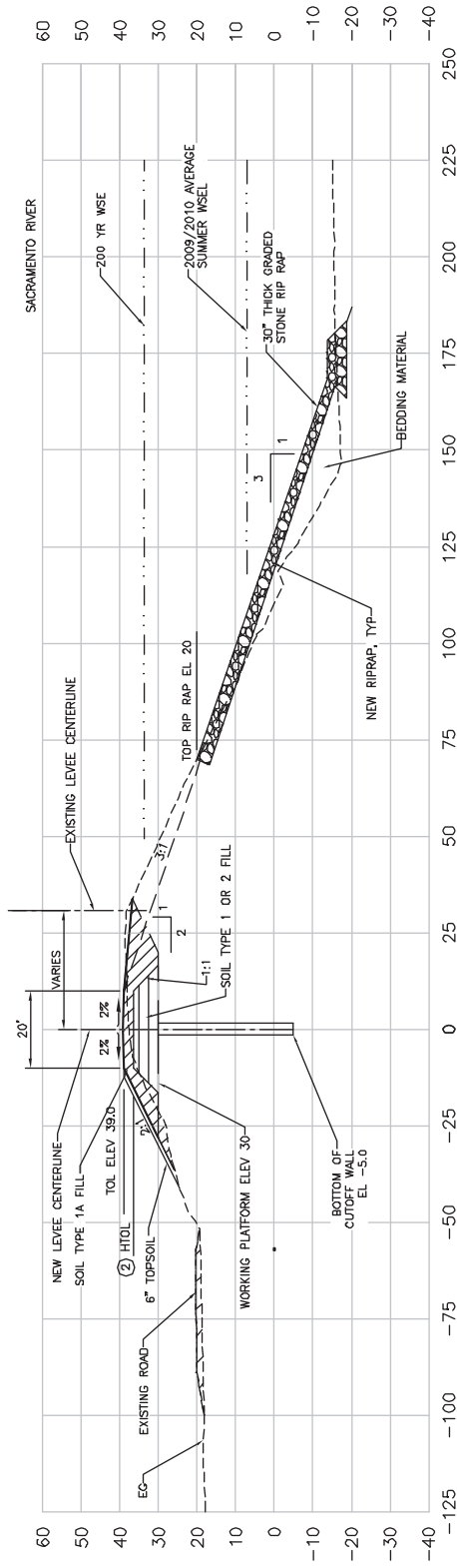

CROSS SECTION 1 — STRENGTHEN IN-PLACE W/CUTOFF WALL
(STA 24+00 TO 46+50)

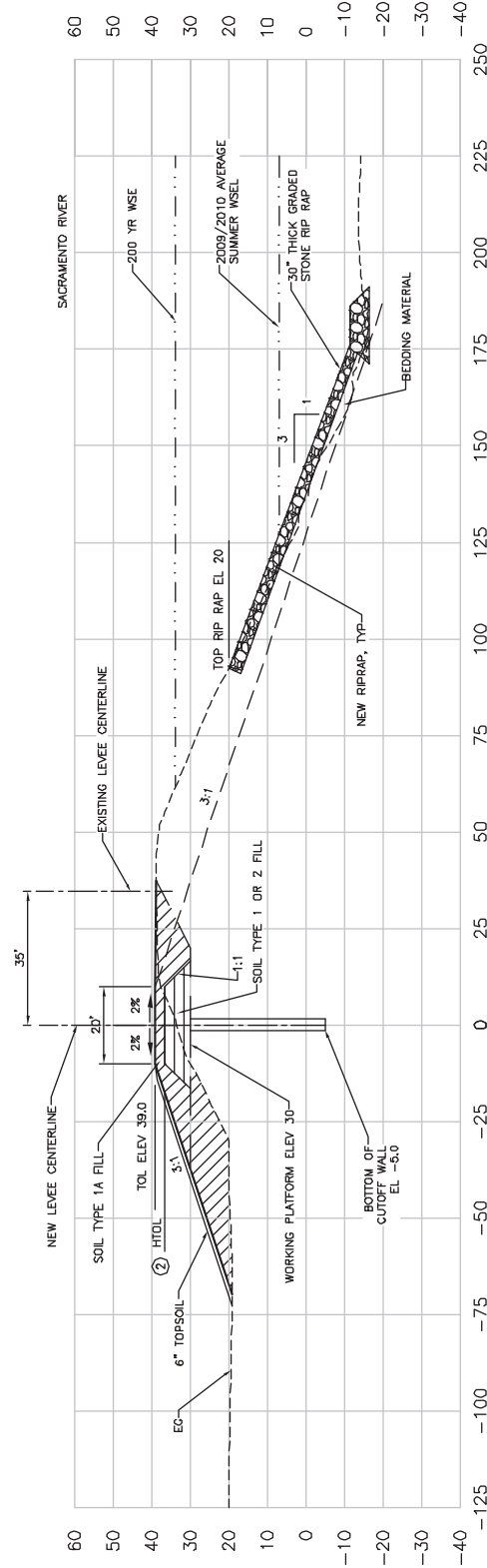

CROSS SECTION 2 — ADJACENT LEVEE W/SEEPAGE BERM
(STA 46+30 TO 49+45)

Source: HDR Engineering, December 2012.



Figure 4a
Typical Levee Sections

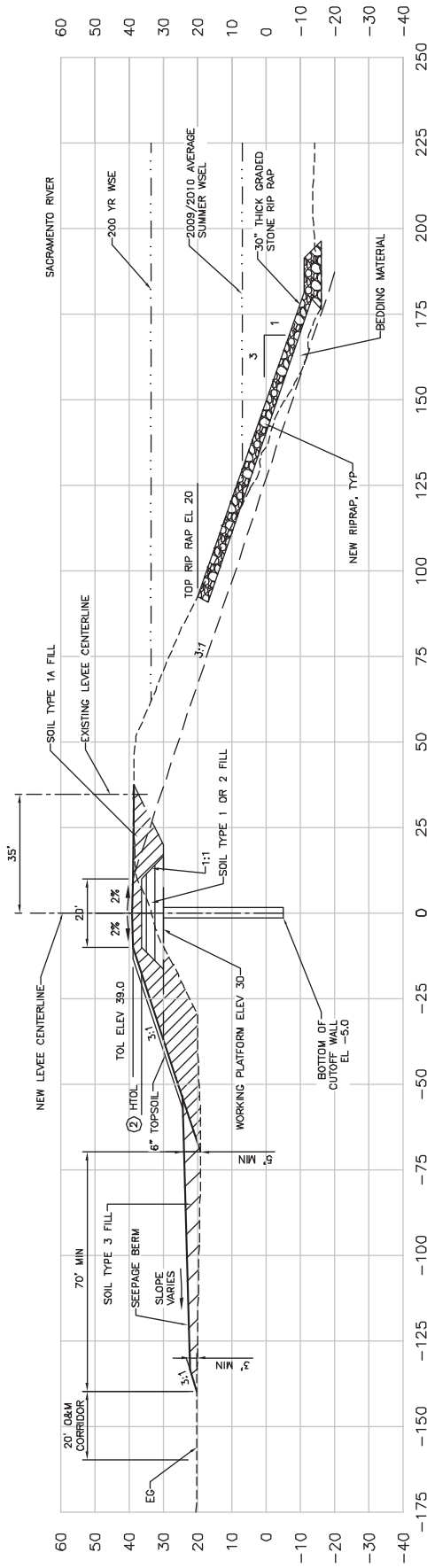

CROSS SECTION 3 - ADJACENT LEVEE W/SEEPAGE BERM
(STA 50+67 TO 69+00)

NOTE: TRANSITION TO FULL WIDTH (70') OF SEEPAGE BERM BETWEEN STA 49+45 AND 50+67

SEEPAGE BERM WIDTH BETWEEN STATION 62+00 AND 64+10 IS 50'

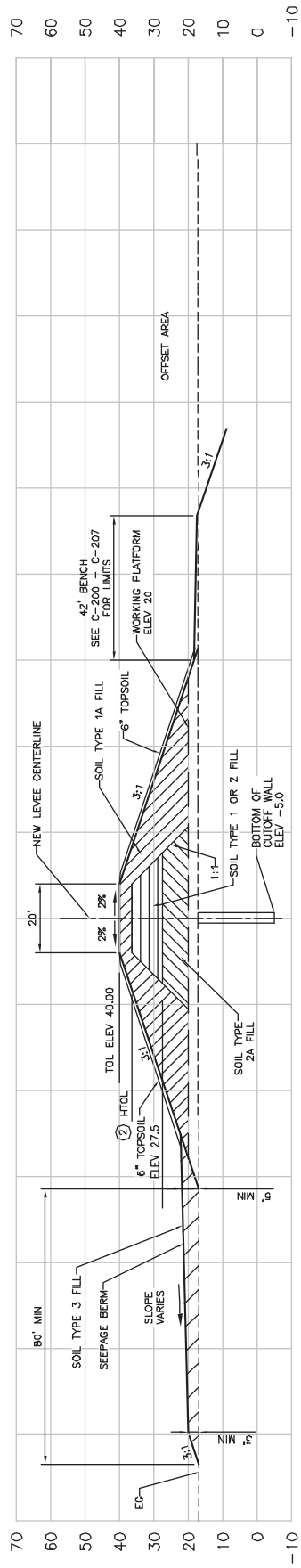

CROSS SECTION 4 - ADJACENT LEVEE W/SEEPAGE BERM
(STA 74+00 TO 148+00)

NOTE: TRANSITION FROM 70' SEEPAGE BERM AT STA 69+00 TO 80' SEEPAGE BERM AT STA 74+00

NOTE: TRANSITION TOL FROM 39 TO 40 BETWEEN STATIONS 74+00 AND 76+00

NOTE:

1. TYPICAL R/W, UTILITY CORRIDOR AND O&M CORRIDOR NOT SHOWN. SEE PLAN/ PROFILE SHEETS.
2. TOP OF CLAY CORE SET AT HDL SEE PLAN AND PROFILE SHEETS FOR ELEVATION.

Source: HDR Engineering, December 2012.

Figure 4b
Typical Levee Sections

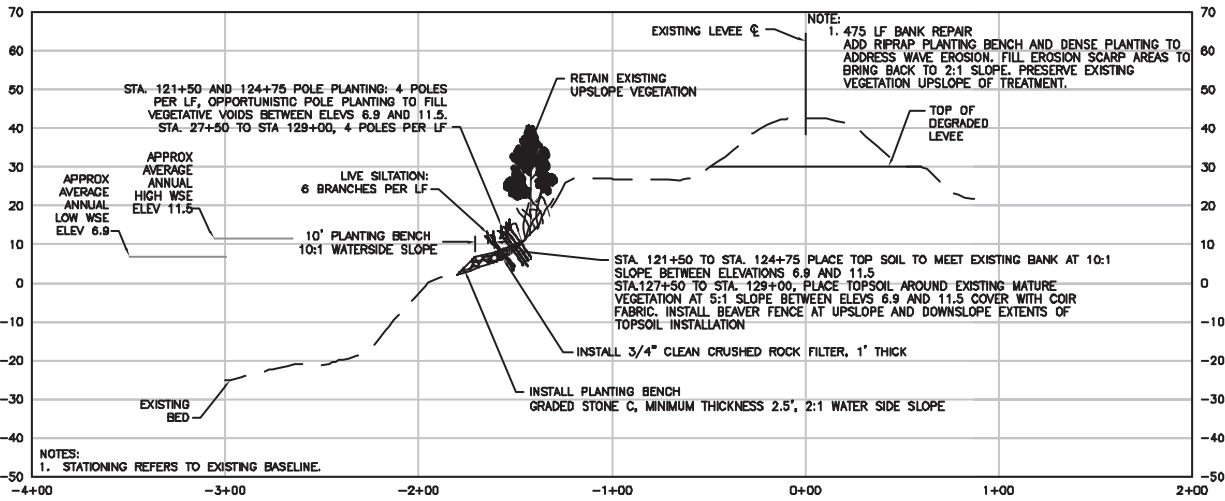

CROSS SECTION 5: TYPICAL SECTION OF BANK ARMORING AND POLE PLANTINGS – STATION 121+50 TO 124+75 AND 127+50 TO 129+00

7
C-202

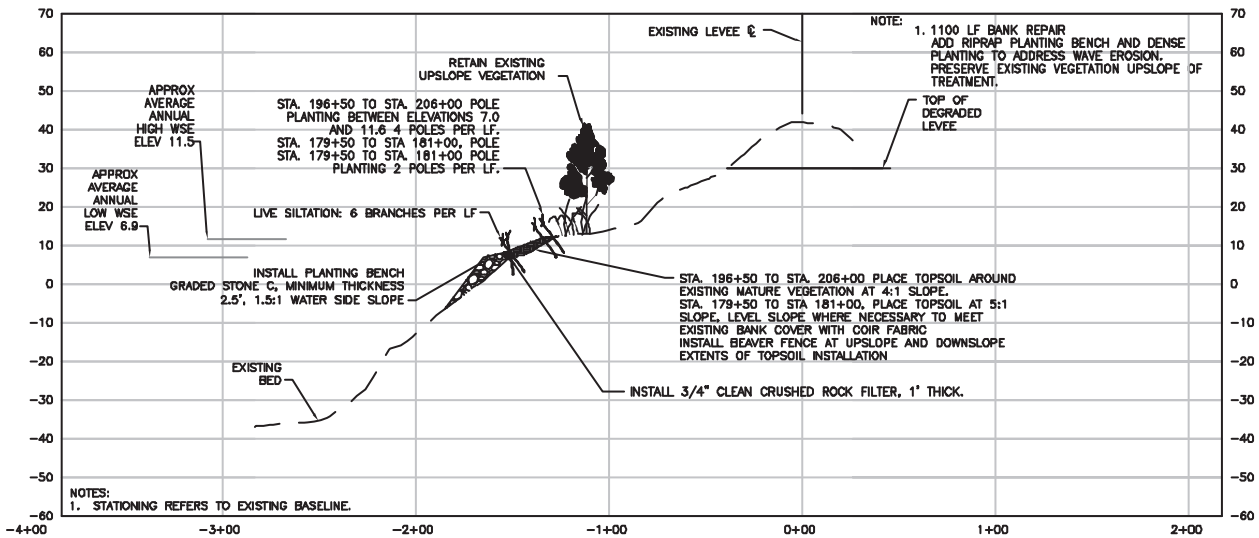

CROSS SECTION 6: TYPICAL SECTION OF BANK ARMORING, FILL, AND POLE PLANTINGS – STATION 179+50 TO 181+75 AND 196+50 TO 206+00

8
C-203

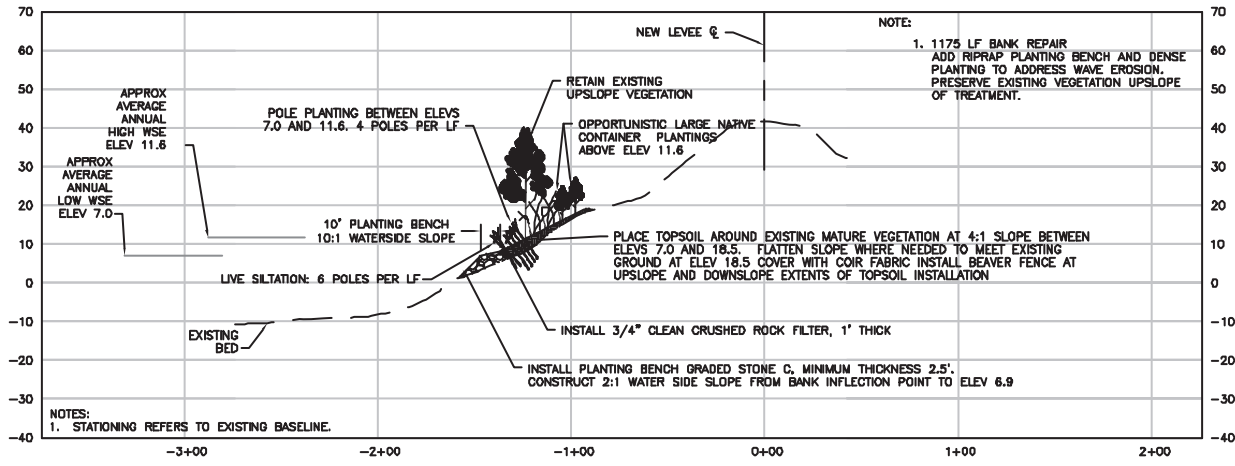

CROSS SECTION 7: TYPICAL SECTION OF BANK ARMORING, POLE PLANTING, AND SLOPE FLATTENING – STATION 225+50 TO 237+00 AND 239+50 TO 239+75

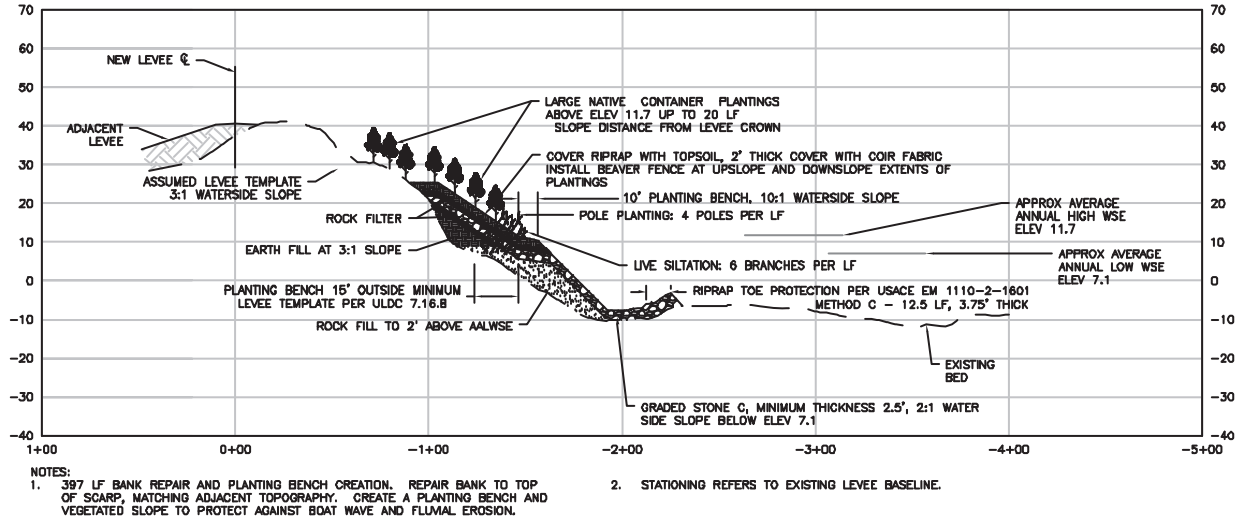

CROSS SECTION 8: TYPICAL SECTION OF BANK ARMORING, FILL, AND POLE PLANTINGS – STATION 274+50 TO 278+00

Graphics ... 0007112 (4-14-13)



Figure 4d
Typical Bank Armoring Sections

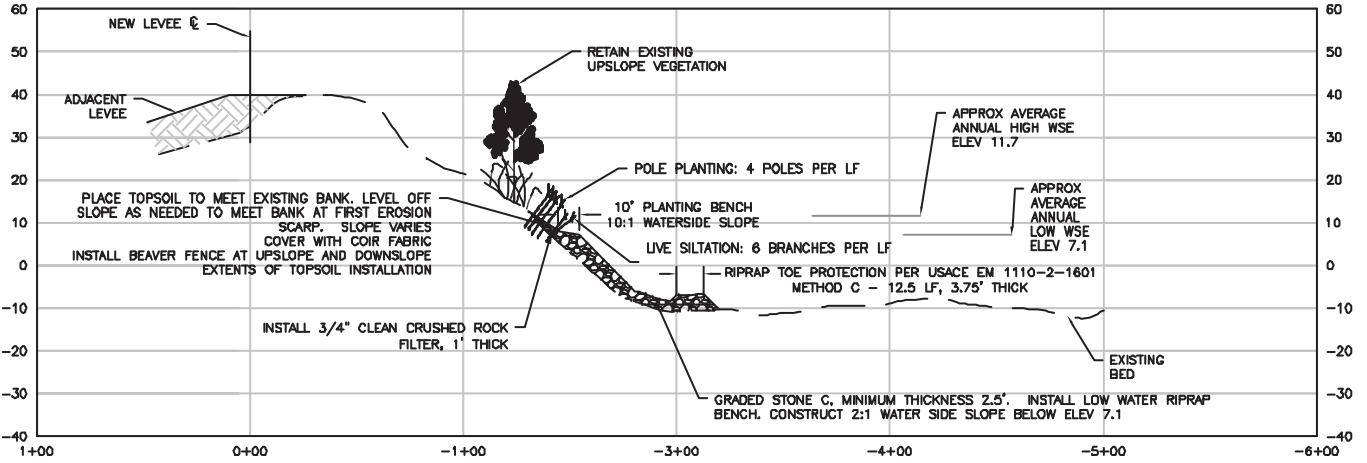

NOTES:

1. 313 LF BANK STABILIZATION: ADD RIPRAP PLANTING BENCH AND DENSE PLANTING TO ADDRESS WAVE EROSION. PRESERVE EXISTING VEGETATION UPSLOPE OF TREATMENT.
2. STATIONING REFERS TO EXISTING LEVEL BASELINE.

CROSS SECTION 9: TYPICAL SECTION OF BANK ARMORING AND POLE PLANTINGS – STATION 284+80 TO 286+00

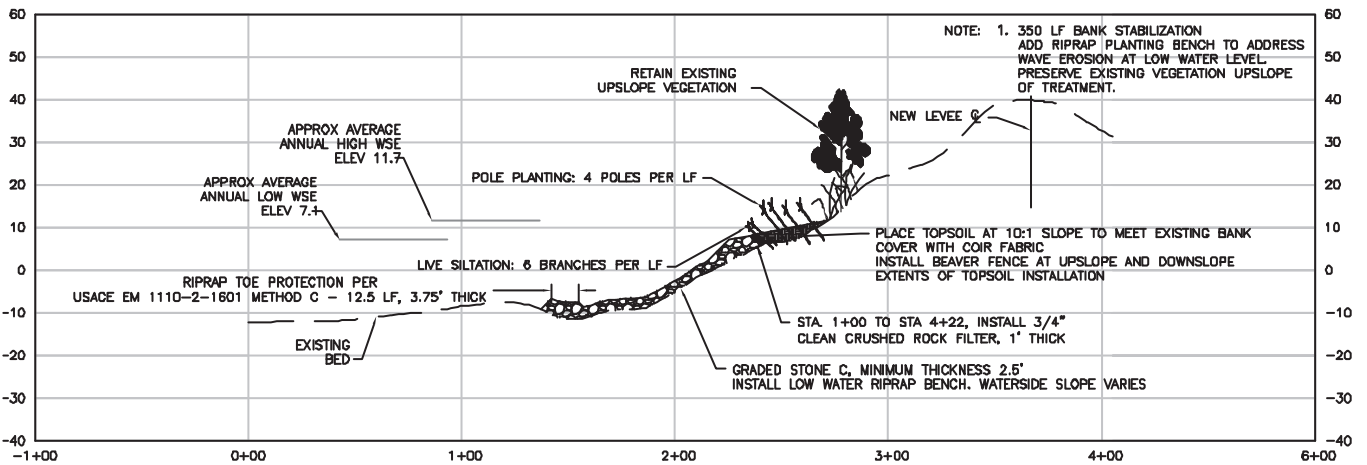

CROSS SECTION 10: TYPICAL SECTION OF BANK ARMORING AND POLE PLANTINGS – STATION 286+00 TO 289+50



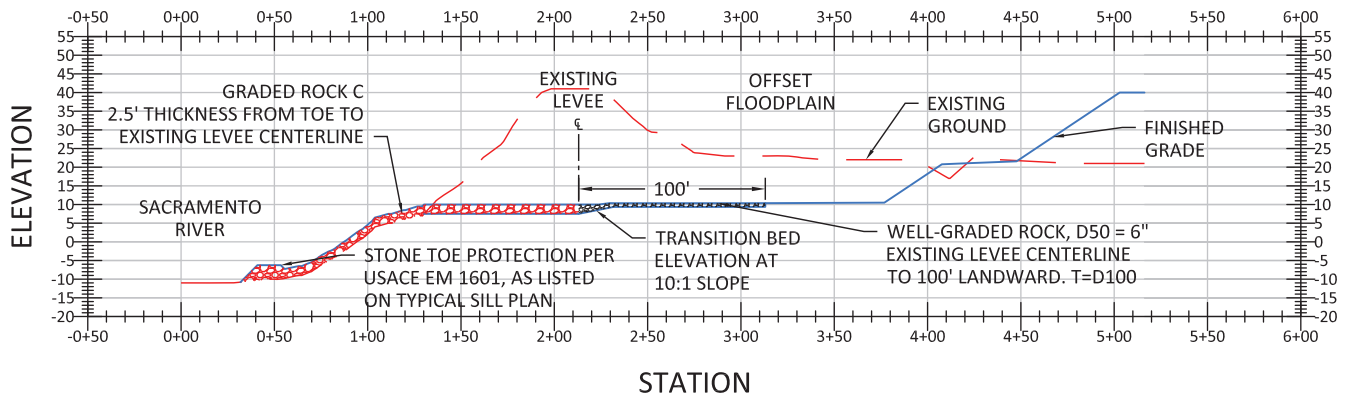

CROSS SECTION 11: TYPICAL LEVEE BREACH SECTION

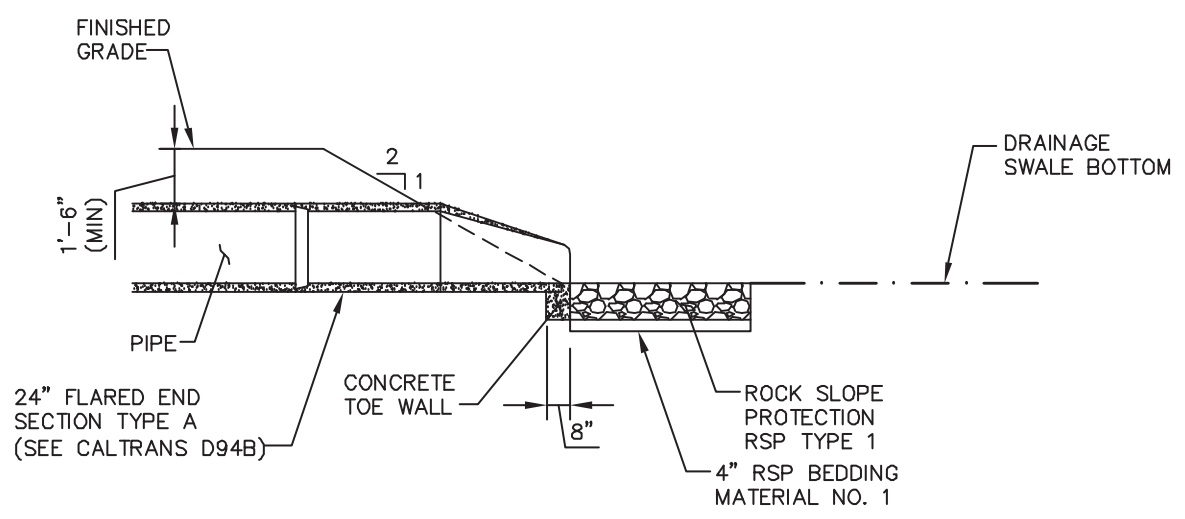
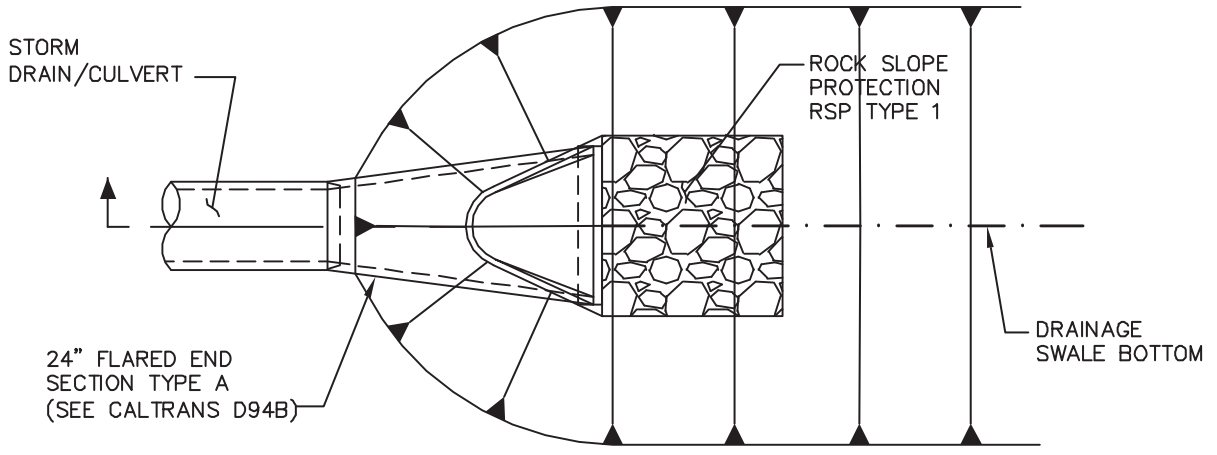

TYPICAL FLARED END DETAIL 

Graphics ... 0007112 (4-14-13)



Figure 5
Typical Drainage Details

Appendix B

Addresses of Adjoining Property Owners

Appendix B
Adjacent Property Owners

APN	Property Owner	Address	City	State	Zip Code
046 010 14	Dianne McCray	2590 S River Road	West Sacramento	CA	95691
046 010 44	City of West Sacramento	1110 W Capitol Avenue	West Sacramento	CA	95691
046 010 52	Laudenshlager Trust et al.	2550 S River Road	West Sacramento	CA	95691
046 030 04	Cathy Yokoyama	3000 S River Road	West Sacramento	CA	95691
046 030 07	Occupant	1150 Linden Road	West Sacramento	CA	95691
046 030 15	Seecon Financial & Construction Co. Inc.	4021 Port Chicago Hwy	Concord	CA	94520
046 030 16	Seecon Financial & Construction Co. Inc.	4021 Port Chicago Hwy	Concord	CA	94520
046 040 06	South River LLC	3260 French Avenue	West Sacramento	CA	95691
046 040 08	William Barker	1155 Linden Road	West Sacramento	CA	95691
046 040 11	Coast Capital Income	4000 Stevens Creek Blvd	San Jose	CA	95129
046 050 33	Paik Family Trust et al.	2825 Paseo Del Mar	Palos Verdes Estates	CA	90274
046 100 01	Paik Family Trust et al.	19818 S Alameda Street	East Rancho Dominguez	CA	90221
046 100 05	Sharon Downey	1980 Davis Road	West Sacramento	CA	95691
046 100 07	Sharon Downey	1980 Davis Road	West Sacramento	CA	95691
046 100 08	City of West Sacramento	1110 W Capitol Avenue	West Sacramento	CA	95691
046 100 09	Paik Family Trust et al.	2825 Paseo Del Mar	Palos Verdes Estates	CA	90274
046 100 13	Donald Fenocchio	3501 S River Road	West Sacramento	CA	95691
046 100 14	Donald Fenocchio	3505 S River Road	West Sacramento	CA	95691
046 230 13	4560 S River Road LLC	8320 E Hartford Drive #101	Scottsdale	AZ	85255
046 230 14	Elah Investment Partners	4455 S River Road	West Sacramento	CA	95691
046 230 28	Sacramento & San Joaquin Drainage District	P.O. Box 942836	Sacramento	CA	94236
046 230 31	Sacramento & San Joaquin Drainage District	P.O. Box 942836	Sacramento	CA	94236
046 230 48	Cathy Yokoyama	3000 S River Road	West Sacramento	CA	95691
046 230 50	Brett Culbreth & Terry Annesley	4400 S River Road	West Sacramento	CA	95691
046 230 52	Calfee & Konwinski Prof Corp Profit Sharing Plan	611 North Street	Woodland	CA	95695
046 250 05	Sacramento & San Joaquin Drainage District	P.O. Box 942836	Sacramento	CA	94236
046 250 07	Walton Beverly et al.	P.O. Box 3105	El Macero	CA	95618
046 250 11	Vichai Aruntakasm	4360 S River Road	West Sacramento	CA	95691
046 250 16	Sun M Capital LLC c/o Michael Smith	75 Malaga Cove, Suite 14	Palos Verdes Estates	CA	90274
046 250 17	Albert Rogers	4440 S River Road	West Sacramento	CA	95691
046 250 18	Scott Rodgers	4364 S River Road	West Sacramento	CA	95691
046 260 03	Sun M Capital LLC c/o Michael Smith	75 Malaga Cove, Suite 14	Palos Verdes Estates	CA	90274
046 260 05	Sun M Capital LLC c/o Michael Smith	75 Malaga Cove, Suite 14	Palos Verdes Estates	CA	90274
046 260 06	Kubo Family Trust	5610 Garden Highway	Sacramento	CA	95837
046 260 13	Sun M Capital LLC c/o Michael Smith	75 Malaga Cove, Suite 14	Palos Verdes Estates	CA	90274
046 260 14	Sun M Capital LLC c/o Michael Smith	75 Malaga Cove, Suite 14	Palos Verdes Estates	CA	90274
046 270 29	Sun M Capital LLC c/o Michael Smith	75 Malaga Cove, Suite 14	Palos Verdes Estates	CA	90274
046 270 35	Sun M Capital LLC c/o Michael Smith	75 Malaga Cove, Suite 14	Palos Verdes Estates	CA	90274
046 990 08	City of West Sacramento	1110 W Capitol Avenue	West Sacramento	CA	95691

Legend

- Construction Area Boundary
- Permanent Fill (25,659 acres)
- Ordinary High Water Mark (OHWM)
- Segment Boundary
- Sacramento River Mile
- Pond
- Ditch
- Project Elements**
- Cutoff Wall
- Offset Area Grading
- Proposed Road
- O&M Corridor
- Seepage Berm
- Adjacent Levee
- Setback Levee
- Levee Slope Flattening
- Bank Stabilization
- Levee Breach Protection
- Staging Area

W = Average Width

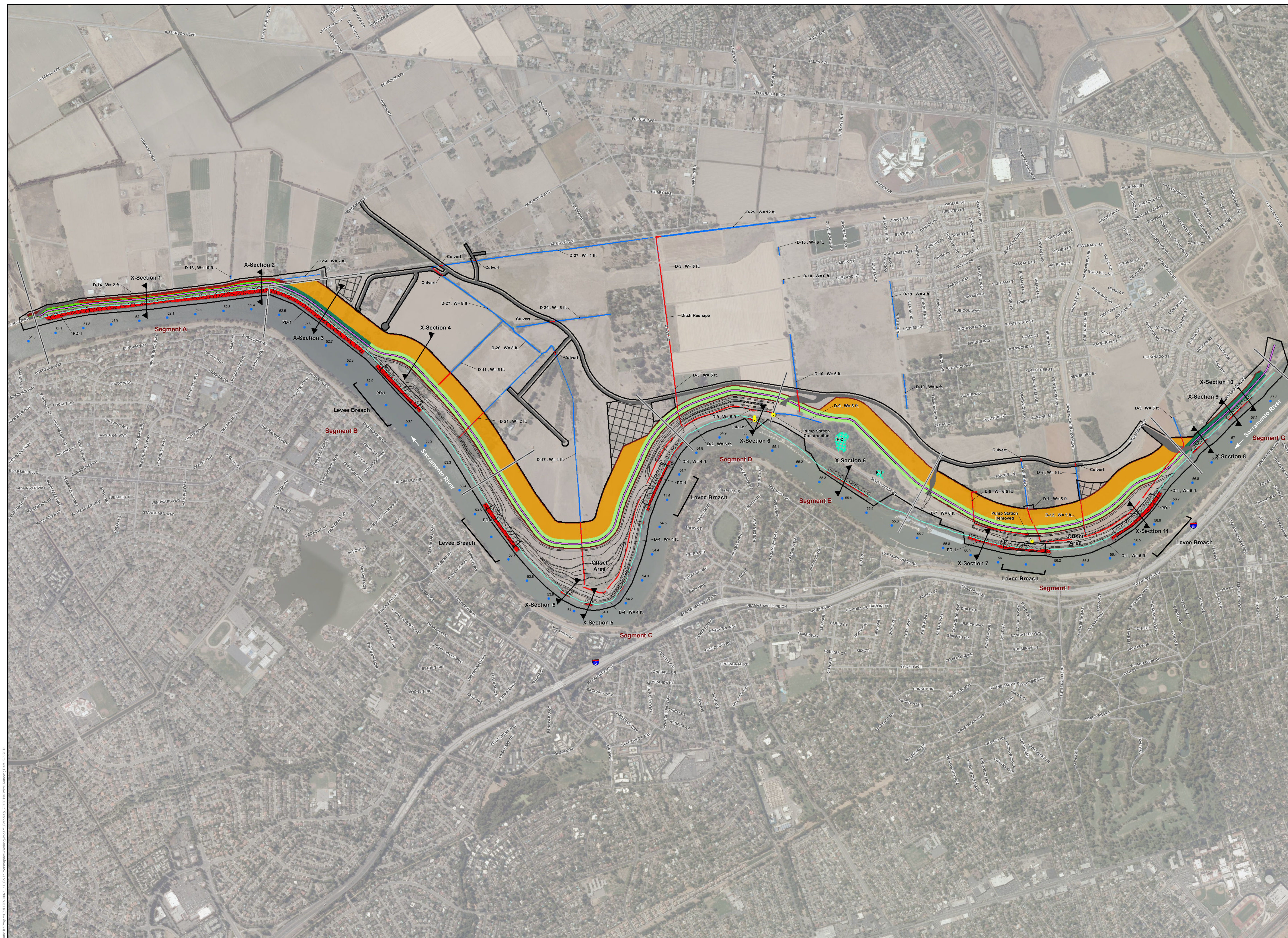

Notes:
 Source: Project Elements, HDR 12/20/2012
 Base Map Source: ICF, 2012
 Imagery Source: NAIP 2010
 USGS Topo Quad: Sacramento West
 PLSS: Wetlands Land Grant

Prepared By: ICF, International 916.737.3000
 Drawn By: Edward Douglas, February 5, 2013

Figure 3
 Project Plan View Showing Impacts to Potential Waters of the United States, Including Wetlands

Appendix I.2
**Revised Permit Application Materials for the Southport
Sacramento River Early Implementation Project DA
Permit Application**



Transmittal

Date:	March 29, 2013										
To:	Marc Fugler Senior Project Manager U.S. Army Corps of Engineers, Sacramento District 1325 J Street, Room 1350 Sacramento, CA 95814 (916) 557-5255										
From:	Michael Vondergeest Regulatory Compliance Specialist										
Subject:	Revised Permit Application Materials for the Southport Early Implementation Project DA Permit Application SPK # 2012-00462 (ICF# 00071.11 004)										
Method of Transmission:	<input type="checkbox"/> Mail <input type="checkbox"/> Overnight <input checked="" type="checkbox"/> Courier										
Purpose of Transmission:	<input type="checkbox"/> Per your request <input type="checkbox"/> For your review <input checked="" type="checkbox"/> For your information or use <input type="checkbox"/> Other:										
Items Being Transmitted:	<table border="1"><thead><tr><th>Quantity</th><th>Description</th></tr></thead><tbody><tr><td>3</td><td>Cover letter from WSAFCA</td></tr><tr><td>3</td><td>Folded 24" x 36" Figure 3 Map</td></tr><tr><td>3</td><td>Revised Additional Pages to the DA Permit Application</td></tr><tr><td>3</td><td>Revised Figures 3 (strip map and map book, 4a-d, 5a-e, and 6</td></tr></tbody></table>	Quantity	Description	3	Cover letter from WSAFCA	3	Folded 24" x 36" Figure 3 Map	3	Revised Additional Pages to the DA Permit Application	3	Revised Figures 3 (strip map and map book, 4a-d, 5a-e, and 6
Quantity	Description										
3	Cover letter from WSAFCA										
3	Folded 24" x 36" Figure 3 Map										
3	Revised Additional Pages to the DA Permit Application										
3	Revised Figures 3 (strip map and map book, 4a-d, 5a-e, and 6										

Hi Marc,

Enclosed is WSAFCA's letter response to the incomplete letter received on February 11, 2013 for the Southport EIP Project, revised pages for the DA permit application, and updated figures showing the proposed project which is also Alternative 5 in the revised 3rd Administrative Draft EIS/EIR you will be receiving next week. If you have any questions, please let me know.

Thank you,

Michael Vondergeest
Regulatory Compliance Specialist
(916) 231-9570
Michael.Vondergeest@icfi.com.

March 29, 2013

Marc Fugler
Senior Project Manager
U.S. Army Corps of Engineers
California Delta Branch
1325 J Street, Room 1350
Sacramento, CA 95814

Subject: Additional Information in Response to the February 11, 2013 Incomplete Application Letter for the Southport Sacramento River Early Implementation Project Yolo County, CA (SPK-2012-00462)

Dear Mr. Fugler:

This letter concerns the pending Department of the Army (DA) permit authorization for the Southport Sacramento River Early Implementation Project (proposed project) and provides you with the information you requested in your February 11 letter and revisions and updates to the DA permit application materials you received on January 25, 2013. This letter and the attached supporting materials should complete the DA application and initiate your processing of the DA permit.

Information Requested to Complete the DA Permit Application:

1. The application materials you received in January included Table 11, which indicated 25.66 acres of impacts on waters of the United States (waters) and Figure 3, which indicated 21.14 acres of impacts on waters. The number on Figure 3 was incorrect and should have been 25.66 acres. However, as you noticed, 25.66 acres did not match the impact number reported for the Third ADEIS/EIR Applicant Preferred Alternative (APA), Alternative 5, which was 15.73 acres. The reason for this difference was that the DA permit application's proposed project had been updated to include recently designed bank stabilization measures, including breach location armoring and pump station relocation impacts that were not incorporated into Alternative 5 at the time the Third ADEIR/EIS was prepared and released. Both documents were reporting accurate impact numbers based on the projects they described, but Alternative 5 was not the same as the proposed project described in the DA permit.

To correct this discrepancy, the Project Team, in coordination with the Operations and Regulatory Branch of the USACE, decided to add the bank stabilization treatments described for Segments C, D, E, and F in the DA permit application to the Revised Third ADEIS/EIR Alternative 5 and add the bank stabilization treatment described for Segment G of Alternative 5 in the ADEIR/EIS into the DA permit application. By revising both the

ADEIS/EIR and DA permit application, Alternative 5 becomes the proposed project, which must be described in the DA permit application. Attached to this letter are revisions to the DA permit blocks, figures, and impact numbers for you to amend the permit application with APA, Alternative 5.

2. The application materials you received in January included Table 1 on page 7 that errantly omitted bank stabilization in Segments C, D, E, and F. Table 1 should have identified bank stabilization in all segments. The revised permit blocks contain a corrected Table 1.
3. The levee breaches (inlets) will be created during low flow conditions so no water rushes through them when the levee sections are removed. If necessary, sheet piles may be installed along the toe of the levee and across the breach segments to keep unwanted river flows out during levee breaching. The breaches include channels to direct river flows into the offset area and back out thorough downstream breaches. The channels and offset area grading would be completed prior to levee breaching. Levee breach armoring consisting of rock that extends down the waterside slope to the river bed would be installed as typical rock slope protection using barges and cranes. Breach armoring would be installed during the low flow season. The completed breaches will be subject to extreme flows during high-water stages. Figures 5a through 5e show plan and profile views of levee breaches.
4. The DA permit application stated on page 23 that some preparation of construction might occur during 2013. The applicant would ensure this preparatory work would not cause impacts on waters and would not be subject to a DA permit. Work may include preliminary equipment staging, utility relocations, vegetation removal, and roadway grading, etc. outside of environmentally sensitive areas.
5. The ADEIS/EIR describes vegetation impacts in section 3-08. Riprap would be placed in areas after vegetation is removed, including trees; however, most of the river bank within the project reach already contains some riprap. In these areas, very little woody vegetation would be removed. Woody vegetation removal would mostly occur at the levee breaches and existing trees saved, where practicable. With the exception of Segment A and G, the bank stabilization areas would be bioengineered to increase vegetation in the offset floodplain area and reduce erosion. River bank vegetation impacts are of special concern to the U.S. Fish and Wildlife Service and the National Marine Fisheries Service. The biological assessments will include a Standard Assessment Method analysis to asses shaded riverine aquatic impacts and determine appropriate mitigation ratios. Figures 4a through 4e show cross sections of bank stabilization areas and bioengineering techniques.
6. The project impacts section on page 25 of the permit application was meant to summarize impacts and refer the reader to Table 11 for details. The section should have stated that all sections would receive some level of bank stabilization. This section has been corrected in the revised attachment to the DA permit application.

The project leads have reviewed the list of items you identified as required before issuing a permit and thank you for the notice. The items you list are already in preparation and will be provided to you in the upcoming months.

Marc Fugler
March 29, 2013
Page 3 of 3

If you have any questions about the application revisions or figures attached to this letter or need any additional material, please contact me at (916) 617-4674.

Sincerely,



John Powderly
Associate Planner/Southport Environmental Manager

CC:

Adam Riley, USACE
Tanis Toland, USACE
Kate Dadey, USACE
Ken Ruzich, WSAFCA
Greg Fabun, WSAFCA
Paul Dirksen, WSAFCA
Michael Vondergeest, ICF
Megan Smith, ICF
Chris Elliott, ICF

REVISED Additional Pages to the Standard Department of the Army Permit Application for the Southport Early Implementation Project

The following pages describe the proposed project, which has been revised to be the same as Alternative 5 in the ADEIS/EIR prepared for the project. These sheets and the figures that follow (dated March 2013) replace the pages dated January 2013 and submitted with the Department of the Army permit application.

Box 15. Location of Proposed Project

The proposed Southport Early Implementation Project (Southport project) is located in and west of the Sacramento River between Latitude 38.5572° North, Longitude 121.5177° West and Latitude 28.5030° North, Longitude 121.5599° West.

Box 16. Other Location Descriptions

The Southport project construction footprint extends approximately 5.6 miles along the Sacramento River South Levee from the termination of the U.S. Army Corps of Engineers (USACE) Sacramento River Bank Protection Project (SRBPP) at River Mile (RM) 57.2 south to the South Cross Levee at RM 51.6, in the Southport community of West Sacramento. The 3.6-square-mile project area encompasses the flood risk-reduction measure construction footprint along the river corridor, staging areas, relocated roadway alignments, and potential soil borrow sites located in the study area. The project area covers all or portions of Sections 10, 15, 21, 22, 28, 29, and 32, Township 8 North, and Range 4 East, Mount Diablo Meridian, Yolo County, California.

Box 18. Nature of Activity

Project Background

The project is proposed by the West Sacramento Area Flood Control Agency (WSAFCA) under a framework known as the West Sacramento Levee Improvements Program (WSLIP). To protect human health and safety and prevent adverse effects on property and its economy, the City of West Sacramento (City), as part of WSAFCA, and in partnership with the California Department of Water Resources (DWR), embarked on a comprehensive evaluation of the condition of the city's levees in 2006. The evaluation was necessary to determine the level of flood protection provided by the existing levee system, identify the magnitude and severity of deficiencies, and propose potential flood risk-reduction measures. The results of the comprehensive evaluation revealed several deficiencies necessitating implementation of flood risk-reduction measures to meet current flood

protection standards as implemented federally by the USACE as levee design criteria and by the Central Valley Flood Protection Board (CVFBP) at the state level for target levels of protection.

DWR administers a program for constructing Early Implementation Projects (EIPs), termed as such as advance efforts in coordination with the comprehensive Central Valley Flood Protection Plan (CVFPP). Three such projects have been constructed by WSAFCA, beginning with the I Street Bridge EIP in 2008 and the California Highway Patrol (CHP) Academy and The Rivers EIPs in 2011. The proposed project would be the fourth EIP by WSAFCA.

WSAFCA's levees have been evaluated according to the latest USACE criteria for stability, seepage, erosion, geometry, and levee height. Data collected from the evaluation show that much of the existing system does not provide protection from the 100-year flood event (the event having a 1% chance of occurring in any given year). In addition, an emergency preparedness mapping study analyzed two hypothetical levee failures and determined the rate and depth at which water would flood the city if a levee failure occurred in the studied reaches. This study predicted flooding depths near 15 feet associated with the 100-year flood event.

The City engaged a consultant engineering team to prepare a problem identification report to determine the types, location, and severity of deficiencies in the WSAFCA flood management system. The deficiencies present in the Southport reach are through seepage, under-seepage, slope stability, geometry, erosion, encroachments, and noncompliant vegetation.

To implement the project, WSAFCA is requesting permission from USACE, Operations Division, pursuant to Section 14 of the Rivers and Harbors Act of 1899 (Title 33 of the United States Code [USC], Section 408, [33 USC 408]), for the alteration of the Federal flood control project; and USACE, Regulatory Division, pursuant to Section 404 of the Clean Water Act (CWA) for regulation of dredged or fill material in jurisdictional waters of the United States and Section 10 of the Rivers and Harbors Act of 1899 for regulation of navigable waters. USACE's responsibilities include these three approvals, the necessary NEPA compliance in granting those approvals, and compliance with other applicable laws such as the federal Endangered Species Act (ESA) and National Historic Preservation Act (NHPA). The Operations Division is preparing an Environmental Impact Statement and will be initiating consultations under ESA Section 7 with the U.S. Fish and Wildlife Service (USFWS) and National Marine Fisheries Service (NMFS), and Section 106 with the State Historic Preservation Officer.

Project Setting

The 3.6-square-mile Southport project area encompasses the area of levee flood-risk reduction along the river corridor and potential soil borrow sites located throughout the Southport area of West Sacramento (Figures 1 and 2). Within the project's reach, seven segments have been defined, lettered A through G from south to north (Figure 3). South River Road runs along the top of the levee for the majority of this reach. At Segment A, the road diverts off of the levee top and runs along the landside toe for a short distance. The landside of Segments A through D is bordered mainly by private agricultural lands containing rural residences. The landside of Segment of E is bordered by two small bodies of water referred to as Bees Lakes. Two marinas and multiple boat docks are located along the waterside of the levee in Segments E and F. Rural residences border the landside of Segment F, and a residential development closely borders Segment G.

A 10-foot-wide drained stability berm is present on the landside levee slope along the extent of the reach. This flood risk-reduction measure was completed between 1990 and 1993 as part of the

Sacramento Urban Levee Reconstruction Project. Two critical erosion sites north of Linden Road in Segments F and G were repaired with rock slope protection as part of the SRBPP and the Flood Control and Coastal Storm Emergency Act (Public Law [PL] 84-99) Rehabilitation Assistance Program.

The project area also includes several adjacent and nearby locations at which suitable borrow material may be available for use in constructing the project. As shown on Figure 1, potential borrow sites are located both close to the levee footprint, to the east and west of southern Jefferson Boulevard, and along the Deep Water Ship Channel.

Project Description

WSAFCA is proposing the Southport project to implement flood risk–reduction measures along the Sacramento River South Levee in order to provide 200-year flood event protection consistent with the goal for urbanized areas, as well as providing opportunities for ecosystem restoration and public recreation. The overall project involves the following elements.

- Flood risk–reduction measures, including setback levee, adjacent levee, slope flattening, seepage berms, slurry cutoff walls, levee slope bank stabilization, and utilities and operations and maintenance (O&M) easements.
- Road construction.
- Levee breaches to open up the offset areas to Sacramento River flows.
- Offset area bank stabilization, and habitat restoration.

Each of the project components above will result in a discharge of fill material to waters considered jurisdictional under Section 404 of the Clean Water Act. Some of these activities will occur in the Sacramento River, a navigable waterway, and are described in detail below.

Flood Risk–Reduction Measures

In order to address levee deficiencies, several flood risk–reduction measures would be constructed in the project area. These measures consist of a setback levee, an adjacent levee, strengthening in place (slope flattening), seepage berms, slurry cutoff walls, and levee slope bank stabilization. The levee flood risk–reduction measure footprint also includes the following elements: a waterside O&M easement (where available), the levee from toe to toe, and the landside O&M and utility easement. The waterside O&M easement is assumed to be 20 feet wide, and the landside O&M easement is assumed to be 50 feet wide. The utility corridor is included largely within the landside O&M area. In Segment G, the landside O&M easement is assumed to vary between the proposed flood risk–reduction measure toe and the existing residential lot lines, a distance varying from approximately a few feet to 100 feet. The approximate linear length of each flood risk–reduction measure proposed for each segment is provided in Table 1, below, and is displayed in Figure 3.

Table 1. Project Flood Risk–Reduction and Erosion Control Measures

Segment	Approximate Linear Length ¹	Measures
A	4,850	Waterside slope flattening, slurry cutoff wall, and levee slope bank stabilization
B	800	Adjacent levee, slurry cutoff wall, and levee slope bank stabilization
	1,600	Adjacent levee, slurry cutoff wall, landside seepage berm, and levee slope bank stabilization
	3,050	Setback levee, slurry cutoff wall, and landside seepage berm, and offset area bank stabilization
C	5,300	Setback levee, slurry cutoff wall, landside seepage berm, offset area bank stabilization
D	2,000	Setback levee, slurry cutoff wall, and offset area bank stabilization
E	1,200	Setback levee and slurry cutoff wall
	2,100	Setback levee, slurry cutoff wall, landside seepage berm, and offset area bank stabilization
F	5,500	Setback levee, slurry cutoff wall, landside seepage berm, and offset area bank stabilization
G	2,100	Adjacent levee, slurry cutoff wall, and levee slope bank stabilization

¹ Total length of the Federal levee would be reduced to approximately 5.4 miles from its present length of 5.6 miles due to the landward alignment of the proposed setback levee

Each of the proposed flood risk–reduction measures are described below. Though not a flood risk–reduction measure, bank stabilization will also be placed on the river side bank of the offset area (the former levee structure) to control erosion. “Bank stabilization”, generally, refers to both levee slope and offset area erosion control functions. See Figures 4a through 4d for cross sectional views through levee sections and biotechnical bank stabilization areas. Postconstruction, the levee slopes, areas used for construction staging, and any other disturbed areas would be hydroseeded with a native seed mix.

Setback Levee

Objective

A setback levee is an entirely new section of levee constructed at some distance behind the landside of the existing levee. The existing levee remains in place or is removed or breached, depending on conditions. The new section of levee is tied into the existing levee and then becomes the Federal project levee.

A setback levee can address the following deficiencies:

- Through-seepage
- Slope stability and geometry
- Erosion*
- Noncompliant vegetation
- Encroachments

*Adequacy of this measure for correcting an erosion deficiency is dependent on physical and environmental site conditions.

Design and Construction

The new levee section is constructed to meet current design standards, including height and slope requirements. To begin construction activities, the area required to construct the new levee is cleared, grubbed, and stripped. To construct the new section of levee, bulldozers excavate and stockpile borrow material from a nearby permitted borrow site. Front-end loaders load haul trucks with the borrow material. The haul trucks transport the material to the new levee site, where motor graders spread it evenly. Sheepsfoot rollers compact the material, and water trucks distribute water over the material to ensure proper moisture for compaction. Levee slopes are graded to a 3:1 slope, and a crown at least 20 feet wide is created. For the purpose of levee inspection, an aggregate base, all-weather patrol road is constructed on the crown of the new levee.

If the material from the existing levee is of sufficient quality and not intended to remain in place, it may be excavated and used as fill for the new setback levee. If the existing levee is excavated, grading may be necessary in the offset area (between the new levee and the river) to ensure proper drainage.

Equipment and materials necessary to construct a setback levee are listed in Table 2. Postconstruction, construction staging areas, levee slopes, and any other disturbed areas would be hydroseeded with a native seed mix.

Table 2. Setback Levee—Phases, Equipment, and Materials

Phases of Construction	Equipment	Materials
Site preparation (clearing, grubbing, and stripping)	Scraper	Embankment fill material
Embankment fill material placement	Excavator or track hoe	Water
Finish grading	Bulldozer	Aggregate base rock
Site restoration and demobilization	Front-end loader Haul truck Motor grader Sheepsfoot roller Water truck	Hydroseed

Operations and Maintenance

Postconstruction, the only permanent facility is the modified levee. Typical levee O&M in the Southport project area currently includes the following actions.

- Vegetation maintenance up to four times a year by mowing or applying herbicide.
- Control of burrowing rodent activity monthly by baiting with pesticide.
- Slope repair, site-specific and as needed, by re-sloping and compacting.
- Patrol road reconditioning up to once a year by placing, spreading, grading, and compacting aggregate base or substrate.
- Visual inspection at least monthly, by driving on the patrol road on the crown and maintenance roads at the base of the levee.

Impacts on Waters of the United States

Construction of the setback levee would result in the fill of several ditches within the Southport project area. In addition to the ditches that would be filled, portions of the irrigation ditches within the offset area would be cut off from the rest of the ditch system on the landside of the new setback levee. These ditches would be considered permanently impacted, as described in Table 11 under "Project Impacts", below.

Adjacent Levee

Objective

The adjacent levee involves the construction of a new levee embankment adjacent to the existing levee. This treatment may address the following deficiencies:

- Through-seepage
- Slope stability
- Erosion*
- Noncompliant vegetation
- Encroachments

Adequacy of this measure for correcting an erosion deficiency is dependent on physical and environmental site conditions.

Design and Construction

The adjacent levee essentially adds material to increase the cross section of the levee, thereby allowing the prescribed 3:1 landside slopes and 20-foot-wide crown to be established. The adjacent levee is constructed on the landward side of the levee.

The first construction phase is clearing, grubbing, and stripping the work site and any construction staging areas, if necessary. A trapezoidal trench is cut at the toe of the slope and the levee embankment may be cut in a stair-step fashion to allow the new material to key into the existing material. Bulldozers then excavate and stockpile borrow material from a nearby borrow site. Front-end loaders load haul trucks with the borrow material, and the haul trucks subsequently transport it

to the adjacent levee site. The haul trucks dump the material, and dozers spread it evenly. Sheepsfoot rollers compact the material, and water trucks distribute water over the material to ensure proper moisture for compaction. The landside levee typically is graded at a 3:1 slope, and the levee crown is at least 20 feet wide. The slope may be track-walked with a dozer.

The levee crown is finished with an aggregate base or paved road, depending on the type and level of access desired. Either condition requires importation of material with dump trucks, placement with a loader and motor grader, and compaction. A paver is required for asphalt placement.

Equipment and materials necessary to construct an adjacent levee are listed in Table 3. Postconstruction, the levee slopes, areas used for construction staging, and any other disturbed areas would be hydroseeded with a native seed mix.

Table 3. Adjacent Levee—Phases, Equipment, and Materials

Phases of Construction	Equipment	Materials
Site preparation (clearing, grubbing, and stripping)	Scraper	Embankment fill material
Material placement and rough grading	Excavator or track hoe	Aggregate base rock
Finish grading	Bulldozer	Hydroseed
Paving (optional)	Front-end loader	Asphalt concrete (optional)
Site restoration and demobilization	Haul truck Motor grader Sheepsfoot roller Water truck Paver (optional)	

Operations and Maintenance

Postconstruction, the only permanent facility is the modified levee. O&M would be the same as for a typical levee, described under Setback Levee.

Impacts on Waters of the United States

Construction of an adjacent levee would result in the fill of a portion of a ditch in Segment A.

Slope Flattening

Objective

Slope-flattening is a mechanical method to repair or reshape slopes that do not meet standards for geometry and stability. Levee slopes are typically subject to a standard of 3H:1V, but this may vary based on site-specific conditions and supporting engineering analysis. Slope-flattening addresses deficiency related to slope stability and geometry.

Design and Construction

To begin slope-flattening activities, the area is cleared, grubbed, and stripped to provide space for construction and reshaping slopes. Additional embankment fill material may be necessary to achieve slope-flattening. If so, bulldozers excavate and stockpile borrow material from a nearby

permitted borrow site. Front-end loaders load haul trucks with the borrow material. The haul trucks transport the material to the slope-flattening site. Motor graders spread material evenly according to levee design plans, and sheepsfoot rollers compact the material. Water trucks distribute water over the material to ensure proper moisture for compaction.

To reshape a waterside slope, the existing crown of the levee is shifted farther landward, and the waterside slope is trimmed and reshaped typically to a 3:1 slope. The shifted levee crown would be a minimum of 20 feet wide, with a 3:1 slope on the landward side, except in cases where the existing slope is 2:1 and it would be maintained. An all-weather patrol road made of aggregate base rock is constructed on the levee crown.

Equipment and materials necessary to implement slope-flattening treatment are listed in Table 4. Postconstruction, the construction staging areas, levee slopes, and any other disturbed areas would be hydroseeded with a native seed mix.

Table 4. Slope Flattening—Phases, Equipment, and Materials

Phases of Construction	Equipment	Materials
Site preparation (clearing, grubbing, and stripping)	Scraper	Embankment fill material
Reshaping of slopes and placement of additional fill (if necessary)	Excavator or track hoe	Water
Finish grading	Bulldozer	Aggregate base rock
Site restoration and demobilization	Front-end loader Haul truck Motor grader Sheepsfoot roller Water truck	Hydroseed

Operation and Maintenance

Postconstruction, the only permanent facility is the modified levee. Maintenance of the new levee surfaces would consist of:

- Vegetation maintenance up to four times a year by mowing or applying herbicide.
- Control of burrowing rodent activity monthly by baiting with pesticide.
- Slope repair, site-specific and as needed, by re-sloping and compacting.
- Patrol road reconditioning up to once a year by placing, spreading, grading, and compacting aggregate base or substrate.
- Visual inspection at least monthly, by driving on the patrol road on the crown and maintenance roads at the base of the levee.

Impacts on Waters of the United States

Levee slope flattening would result in the fill of one ditch in Segment A.

Seepage Berm

Objective

Seepage berms are wide embankment structures made up of low-permeability to semi-pervious materials that resist accumulated water pressure and safely release seeping water. A seepage berm is typically one third the height of the levee; however, seepage berms in the proposed project and Alternative 5 are 300 feet in width, extending outward from the landside levee toe and laterally along the levee as needed relative to the seepage conditions. For the purpose of conservatively determining environmental effects of the action alternatives within the ADEIS/EIR, a 300-foot-wide seepage berm was assumed. However, it is expected this width may be reduced considerably as project design efforts continue and more data is gathered. A seepage berm addresses the levee deficiency of under-seepage.

Design and Construction

Seepage berms are 300 feet in width. Typical height of berms is 5 feet at the levee landside toe, tapering to 3 feet at the berm toe, regardless of the berm width. Lateral length depends on seepage conditions along the area of identified levee deficiency.

Construction consists of clearing, grubbing, and stripping the ground surface. Soil used to construct a berm would be stockpiled from levee degradation, excavated from nearby borrow pits, or trucked on site from off-site locations (if on-site material is not adequately available.) During the degrading, soil would be stockpiled at the proposed berm site. If constructing the project does not require levee degradation, all soil material used to construct a berm would come from nearby borrow sites. At the borrow sites, bulldozers excavate and stockpile borrow material. Front-end loaders load haul trucks, and the haul trucks subsequently transport the borrow material to the site. The haul trucks dump the material, and motor graders spread it evenly, placing approximately 3 to 5 feet of embankment fill material. Material used for berm construction has greater permeability than the native blanket material. However, depending on material availability, a lower permeability material may be used. Adjustments to berm width are made in such cases, as appropriate. During the embankment placement, material is placed in a maximum of 1- to 2-foot loose lifts, thereby allowing the compactors to achieve the specified compaction requirements. Sheepsfoot rollers compact the material, and water trucks distribute water over the material to ensure proper moisture for compaction and reduce fugitive dust emissions.

Seepage berms may have an optional feature of a drainage relief trench under the toe of the berm. Drained seepage berms include the installation of a drainage layer (gravel or clean sand) beneath the seepage berm backfill and above the native material at the levee landside toe. A drained seepage berm would likely decrease the overall footprint of the berm.

Equipment and materials necessary to construct a seepage berm are listed in Table 5.

Table 5. Semi-Pervious Berm—Phases, Equipment, and Materials

Phases of Construction	Equipment	Materials
Site preparation (clearing, grubbing, and stripping)	Scraper	Embankment fill material
Embankment fill material placement	Excavator or track hoe	Water
Finish grading	Bulldozer	Aggregate base rock
Site restoration and demobilization	Front-end loader Haul truck Motor grader Sheepsfoot roller Water truck	Hydroseed

Areas used for construction staging, levee slopes, the berm, and any other disturbed areas would be hydroseeded with a native seed mix.

Operation and Maintenance

The only postconstruction permanent facility is the berm. Maintenance of the berm would be similar to the typical O&M practices presently in place for maintenance of levee surfaces.

- Vegetation maintenance up to four times a year by mowing or applying herbicide.
- Control of burrowing rodent activity monthly by baiting with pesticide.
- Slope repair, site-specific and as needed, by re-sloping and compacting.
- Patrol road reconditioning up to once a year by placing, spreading, grading, and compacting aggregate base or substrate.
- Visual inspection at least monthly by driving on the patrol road on the crown and maintenance roads at the base of the levee.

Impacts on Waters of the United States

Construction of the seepage berm would result in the fill of several ditches within the Southport project area. In addition to the ditches that would be filled, portions of the irrigation ditches within the offset area would be cut off from the rest of the ditch system on the landside of the new setback levee. These ditches would be considered permanently impacted, as described in Table 11 under “Project Impacts,” below.

Slurry Cutoff Wall

Objective

A slurry cutoff wall consists of impermeable material that is placed parallel to the levee, typically through the center of the levee crown. While slurry cutoff walls may be constructed using a variety of methods, three possible methods for constructing a slurry cutoff wall may be used for this proposed project: (1) conventional slot trench, (2) deep soil mixing (DSM), and (3) jet grouting. For the purpose of this project, the first two methods are being considered for application over longer areas, and jet grouting is a spot application used when conditions limit application of the primary

methods. A slurry cutoff wall addresses the levee deficiency of seepage (through- and under-seepage).

Shallow cutoff walls are those that extend through the levee embankment and a portion of the levee foundation. They do not finish into a low permeability aquitard but serve to 'tie together' surface layers, causing them to function more as a blanket layer, and increasing the seepage path. Together, these effects can reduce the seepage exit gradient. Shallow cutoff walls also serve to cutoff localized seepage pathways, such as high permeability crevasse splay deposits, root pathways, or other subsurface structures. As such, they replace the need for installing an inspection trench beneath or adjacent to new levees. Sometimes the reduction in the seepage gradient shallow cutoff walls provide is not below the maximum allowable limit, and an additional seepage berm or relief well may be required. The feasibility and design of these features is evaluated based on local conditions. Fully penetrating conventional cutoff walls (open trench installation with track-hoe) extend through the levee embankment and levee foundation and finish into a low permeability aquitard. Fully penetrating conventional cutoff walls generally are preferred for this proposed project, if feasible to construct, because they are the least costly compared to cutoff walls installed using the DSM, while still providing the advantage that all cutoff walls provide of minimizing construction disturbance outside the levee footprint.

If a fully penetrating wall is not feasible because of the foundation conditions (the lower impervious layer is nonexistent or at a depth impossible to reach with the existing equipment), shallow cutoff walls supplemented with additional methods of seepage control (such as seepage berms or relief wells) may be used.

Conventional Slot Trench Method

Design and Construction

To begin construction, the construction site and any necessary construction staging or slurry mixing areas are cleared, grubbed, and stripped.

In the conventional slot trench method using a soil-bentonite wall, the levee is degraded one-half its height and a trench excavated through the levee center from the top of the levee and into subsurface materials. The size of the trench is based on the severity of the seepage but is typically 3 feet wide and up to 85 feet deep. For the proposed project, slurry cutoff walls would vary from 30- to 84-foot-deep. As the trench is excavated, it is filled temporarily with bentonite water slurry to prevent collapse of the trench. The soil from the excavated trench is hauled to a nearby location where it is mixed with hydrated bentonite to reduce permeability. The soil-bentonite mixture then is returned to the levee and backfilled into the trench. This mixture hardens and creates the impermeable barrier wall in the levee.

Degradation of the levee crown is required for prevention of hydro-fracturing of the levee, or, in the case of a soil-bentonite wall, to prevent slope failures through the slurry wall caused by extremely low trench strength. Degradation also provides a working platform to accommodate seepage berm construction activities, typically a minimum of 55 feet, and allow equipment to reach lower impervious layers. The excavated degradation material is hauled to a nearby stockpile area. Following completion of the slurry cutoff wall, the material is hauled back to the levee to restore the levee to its original dimensions. The material may need to be hauled off site, and borrow material may need to be imported if the in-situ levee material is found to be unsuitable for current levee standards.

One construction crew typically is able to construct 200 to 250 linear feet of slurry wall (approximately 70 to 80 feet deep) in an 8-hour shift. Equipment needed for the crew includes a long-reach track hoe, three or four dump trucks (15-cubic yard capacity each), two loaders at the mixing location, bulldozers, excavators, a rough terrain forklift, compactors, maintainers, and a water truck. Vertical clearance of about 40 feet is needed for the excavator boom. Horizontal clearance of about 30 feet beyond the levee crest may be required for excavator swing when loading dump trucks.

A mixing area is located at the construction staging area. The mixing area is to prepare the soil-bentonite mixture and supply bentonite-water slurry. The mixing area is contained to avoid inadvertent dispersal of the mixing materials. Dump trucks haul material between the excavator and the mixing area along the levee.

An all-weather patrol road made of aggregate base rock is constructed on the levee crown to enable regular levee inspections.

The construction equipment and materials necessary to construct a slurry cutoff wall by this method are listed in Table 6. Postconstruction, areas used for construction staging, mixing, the levee crown, slopes, and any other disturbed areas would be hydroseeded with a native seed mix.

Table 6. Conventional Slot Trench Slurry Wall—Phases, Equipment, and Materials

Phases of Construction	Equipment	Materials
Site preparation (clearing, grubbing, and stripping)	Scraper	Cement
Work platform and trench excavation	Excavator or track hoe	Bentonite
Mixing/placement of soil-bentonite mix	Long-reach track hoe	Aggregate base rock
Replacement of levee material	Bulldozer	Hydroseed
Finish grading	Front-end loader	Water (if no available domestic supply)
Site restoration and demobilization	Haul truck	
	Compactor	Miscellaneous construction support materials
	Maintainer	Embankment fill material (if existing material is of poor quality)
	Water truck	
	Rough terrain forklift	

Operations and Maintenance

Postconstruction, the only permanent facility is the slurry cutoff wall. Observation for seepage during high-water events would be the only O&M activity needed.

Deep Soil Mixing Method

Design and Construction

The DSM method of constructing a slurry cutoff wall uses a crane-supported set of three mixing augers (typically 36 inches in diameter) set side by side. These augers are drilled through the levee

crown and foundation to the required depth (capable of a maximum depth of about 130 feet dependent on the subsurface conditions). As the augers are inserted and withdrawn, a cement-bentonite grout is injected through the augers and mixed with the native soil. Cement may also be added to the mixture to increase strength and reduce curing time when needed. An overlapping series of mixed columns is drilled to create a continuous seepage cutoff barrier.

In the DSM method using a soil-bentonite wall, the levee is degraded one-half its height and a trench excavated through the levee center from the top of the levee and into subsurface materials. Where a soil-bentonite-cement wall is used, the levee is degraded one-third its height. Material is scraped and stockpiled at a nearby stockpile area. Dependent on the depth of the wall required, vertical clearance for the crane also may be needed. An excavator manipulates injector return spoils near the DSM rig, and transport trucks are used to haul spoils off site. A crane is used for in-place sampling of DSM material and also for loading bentonite into the batch plant hopper. A mobile batch plant (diesel-powered) is required near each DSM rig at the work area to prepare the cement-bentonite grout. The grout is transported to the DSM rig through flexible hoses. Each batch plant requires a pad of 50 by 100 feet. Hauling at the work area involves scraper runs along the levee to the staging area and deliveries of cement and bentonite to the batch plant.

During DSM slurry wall construction, one DSM rig typically can construct 20 linear feet of DSM wall per 8-hour shift (for wall depths up to 130 feet). An all-weather patrol road made of aggregate base rock is constructed on the levee crown to enable regular levee inspections.

The equipment and materials necessary to construct a DSM slurry wall are listed in Table 7. Postconstruction, areas used for construction staging, the levee slopes, and any other disturbed areas would be hydroseeded with a native seed mix.

Table 7. Deep Soil Mixing Slurry Wall—Phases, Equipment, and Materials

Phases of Construction	Equipment	Materials
Site preparation (clearing, grubbing, and stripping)	Scraper	Cement
Work platform excavation	Excavator or track hoe	Bentonite
Deep soil mixing (DSM)	DSM crane	Hydroseed
Replacement of levee material	Bulldozer	Water (if no available domestic supply)
Finish grading	Front-end loader	Aggregate base rock
Site restoration and demobilization	Haul truck	Miscellaneous construction support materials
	Paddle wheel scraper	Embankment fill material (if existing material is of poor quality)
	Water truck	
	Mobile batch plant	

Operation and Maintenance

Postconstruction, the only permanent facility is the slurry cutoff wall. The only O&M activity would be observation for seepage during high-water events.

Jet Grouting Method: Design and Construction

Jet grouting involves injecting fluids or binders into the soil at very high pressure. The injected fluid can be grout; grout and air; or grout, air, and water. Jet grouting breaks up soil and, with the aid of a binder, forms a homogenous mass that solidifies over time to create a mass of low permeability. Jet grouting typically is used in constructing a slurry cutoff wall to access areas other methods cannot. In this regard, it is typically a spot application rather than a treatment to be applied on a large scale. Jet grouting addresses the levee deficiency of seepage (through- and under-seepage).

Equipment required for jet grouting consists of a drill rig fitted with a special drill string; a high pressure, high flow pump; and an efficient batching plant with sufficient capacity for the required amount of grout and water. The high-pressure pump conveys the grout, air, and/or water through the drill string to a set of nozzles located just above the drill bit. The diameter of the jet grout column is dependent on site-specific variables such as soil conditions, grout mix, nozzle diameter, rotation speed, withdrawal rate, and grout pressure. Jet-grouted columns range from 1 to 16 feet in diameter and typically are interconnected to form cutoff barriers or structural sections. One construction crew, consisting of a site supervisor, pump operator, batch plant operator, chuck tender, and driller under ideal conditions, can construct two 6-foot-diameter, 50-foot columns per day consisting of approximately 100 cubic yards of grout injected per 8-hour shift. Ideal conditions would be characterized by no technical issues such as loss of fluid pressure, breakdown of equipment, or subsurface obstructions to drilling operations occurring at either the batch plant or the drilling site.

To initiate jet grouting, a borehole is drilled through the levee crown and foundation to the required depth (to a maximum depth of approximately 130 feet) by rotary or rotary-percussive methods using water, compressed air, bentonite, or a binder as the flushing medium. When the required depth is reached, the grout is injected at a very high pressure as the drill string is rotated and slowly withdrawn. Rotation speeds range between 10 and 30 rotations per minute (rpm), and the withdrawal rates vary between 2 and 12 inches per minute. Use of the double, triple, and superjet systems create eroded spoil materials that are expelled out of the top of the borehole. The spoil material contains significant grout content and frequently is used as a construction fill.

To provide a wide enough working platform on the levee crown, the upper portion of some segments of the levee may require degradation with a paddle wheel scrapper. Material is scraped and stockpiled at a nearby stockpile area. Hauling at the work area involves scraper runs along the levee to the staging area and grout, bentonite, and water deliveries to the batch plant.

Batch plants typically are centrally located to the injection site, with pipelines for mixed grout that run the length of the work. Grout mixing and injection equipment consists of grout mixers, high-powered grout pumps and supporting generators and air compressors, holding tanks, and water tanks, with bulk silos of grout typically used to feed large mixers. Smaller equipment can be used in combination with the single phase-fluid system and can be permanently trailer-mounted to permit efficient mobilization and easy movement at the job site.

Prior to jet grouting, a field test program typically is completed to evaluate injection parameters and to assess jet grout column geometries, and mechanical and permeability properties. Where possible, jet grout test elements are exposed by excavation and properties are obtained by direct measurement. Bulk samples are collected and delivered to a laboratory for unconfined compressive strength and permeability testing, as required. Where excavation is not possible, core drilling is employed to obtain samples from the jet grout test columns for strength testing.

Types of Jet Grouting Systems

A single phase jet grouting system uses the binder to break up and provide soil mixing of the soils surrounding the drill rods. The single jet grouting system is the most versatile; it can be applied at any inclination and in areas where space is restricted. Set up and excavation times are considerably shorter; the method is also less expensive, cleaner, and less noisy than the three-fluid jet grouting system.

A double phase jet grouting system improves the range of influence of the single phase jet grouting system using an aureole of compressed air concentric about the jet of binder. The diameter of a column of soil treated by the single phase jet grouting system can be increased by adding the air component. Additional equipment includes a two-way coaxial drill string and an air compressor.

The triple-phase or Kajima jet grouting system uses water and air to break up the soil to produce partial substitution of the finer soil particles to create a column of stabilized material that may have a diameter exceeding 6 feet. Additional equipment includes a three-way coaxial drill string, an air compressor, and an additional pump and lines for the water phase.

The superjet grouting system is a modified double-phase jet grouting system that uses tooling design efficiencies and increased energy that allow the construction of large columns, up to 16 feet in diameter. The superjet system operates by mechanically and hydraulically focusing the injection of the grout for pinpoint cutting and erosion of very large volumes of soil in situ. The excess soil-grout mixture is simultaneously expelled at the surface, preventing subsurface pressurization and hydrofracturing. A listing of equipment and materials necessary to construct the jet grouting system is provided in Table 8. Areas used for construction staging, the levee slope, and any other disturbed areas would be restored and hydroseeded following construction.

Table 8. Jet Grouting Phases, Equipment, and Materials

Phases of Construction	Equipment	Materials
Site preparation (clearing, grubbing, and stripping)	Scraper	
Work platform excavation	Excavator or track hoe	
Jet grouting	Jet grouting drill rig	
	Mobile batch plant	Cement, bentonite
	High pressure, high flow pump	Water
	Piping from drill rig to batch plant (spoil line)	
	Piping from batch plant to drill rig	
Replacement of levee material	Bulldozer	Water
	Haul truck	Embankment fill material
Finish grading	Bulldozer	
Site restoration and demobilization	Haul truck	Miscellaneous construction support materials
	Front-end loader	Embankment fill material
	Paddle wheel scraper	
	Water truck	

Operations and Maintenance

Postconstruction, the only permanent facility is the slurry cutoff wall. Observation for seepage during high-water events would be the only O&M activity needed.

Impacts on Waters of the United States

Construction of the slurry cut off walls would not result in the fill of waters of the United States.

Relief Wells

Objective

Relief wells are passive systems that are constructed near the levee landside toe to provide a low-resistance pathway for under-seepage to exit to the ground surface in a controlled and observable manner. A low-resistance pathway releases water pressure under the upper impermeable layer, allowing under-seepage to exit without creating sand boils or piping levee foundation materials. Relief wells are an option only in segments where geotechnical analyses have identified continuous sand and gravel layers and the presence of an adequate impermeable layer. Relief wells are used to address the levee deficiency of under-seepage. Relief wells would be applied only on a limited basis for site-specific conditions rather than a segment-wide application.

Design and Construction

Relief wells are constructed using soil-boring equipment to drill a hole vertically through the upper fine-grained layer (usually clays or silty clays), through the coarse-grained aquifer layer of sand or gravel, and into the lower fine-grained clay layer beneath. Pipe casings and gravel/sand filters are installed to allow water to flow freely while preventing transportation and removal of material from the levee foundation, which can undermine the levee foundation. The water then is collected and discharged into RD 900's drainage system utilizing a series of ditches or an underground piping system. Relief wells generally are spaced at 50- to 150-foot intervals, dependent on the amount of under-seepage, and extend to depths of up to 150 feet. Areas for relief well construction are cleared, grubbed, and stripped. During relief well construction, a typical well-drilling rig is used to drill to the required depth and construct the well (including well casing, gravel pack material, and well seal) beneath the ground surface. The drill rig likely would be an all-terrain, track-mounted rig that could access the well locations from the levee toe.

Areas along the levee toe may be used to store equipment and supplies during construction of each well. Construction of each well and the lateral drainage system typically takes 10 to 20 days. Additional time may be required for site restoration.

Equipment and materials necessary to construct a relief well are listed in Table 9.

Table 9. Relief Wells—Phases, Equipment, and Materials

Phases of Construction	Equipment	Materials
Site preparation (clearing, grubbing, and stripping)	Scraper	Well casing
Drilling and well installation	Trench excavator or track hoe	Sand and gravel
Finish grading	Drill rig	Concrete
Site restoration and demobilization	Equipment support vehicle	Drain pipe
	Haul truck	Hydroseed
	Motor grader	
	Sheepsfoot roller	
	Water truck	
	Small compactor	

Postconstruction, areas used for construction staging, the levee slopes, and any other disturbed areas would be hydroseeded with a native seed mix.

Operation and Maintenance

Relief wells require regular maintenance to ensure proper operation. Piezometers, also called monitoring wells, could be installed between relief wells to allow monitoring of groundwater levels to ensure the wells are relieving the pressure within the aquifer.

Permanent facilities associated with relief wells include the wells themselves and associated lateral drains. Inspection of the relief wells is required at least annually, and observation of flow from the wells is required during high river stages. The wells are test-pumped every 2 years, and the discharge water from those tests is trucked off site to a central disposal, if necessary. The collection ditch is maintained to allow free flow of water.

Impacts on Waters of the United States

Construction of relief wells would not result in the fill of waters of the United States.

Rock Slope Protection

Objective

Portions of the levee slopes may be protected by the placement of rock slope protection. Rock is placed in a layer approximately 2.5 feet thick on the waterside of the levee to protect against erosional forces that threaten levee stability, such as wind, waves, and boat wake. Rock slope protection addresses the levee deficiency of erosion.

Twelve bank erosion sites were identified along the Sacramento River in the project reaches that require repairs. In many instances, these sites would be addressed by the placement of rock slope protection proposed under the project. However, other sites would require additional work to address erosion problems where there is no overlap with proposed flood risk–reduction measures. Erosion sites not repaired in conjunction with proposed flood risk–reduction measure construction would be addressed through additional rock slope protection placement.

Where compliant with USACE levee vegetation policy, the bank protection at the erosion sites is designed both to control erosion and to maintain existing vegetation and IWM. This can be accomplished by incorporating rock benches that serve as buffers against erosion while providing space for planting riparian vegetation and creating a platform to support aquatic habitat features. Such features would be subject to and designed in compliance with USACE levee vegetation guidance, where applicable.

Design and Construction

The placement of rock onto the levee slope would occur either from atop the levee or from the waterside by means of barges, or both. Rock required within the channel, both below and slightly above the surface of the water at the time of placement, would be placed by a crane located on a barge and then spread by an excavator located on top of the levee. Construction would require two barges—one barge would carry the crane while the other barge would hold the stockpile of rock to be placed on the channel slopes—and one excavator located on top of the levee. Rock required on the upper portions of the slopes would be placed by an excavator located on top of the levee. Rock placement from atop the levee would require one excavator and one loader for each potential placement site. The loader brings the rock from a permitted source within 25 miles of the project area and dumps it within 100 feet of the levee. The excavator then moves the rock from the stockpile to the waterside of the levee. Soil may be placed in the interstitial spaces, followed by hand installation of native vegetation where outside the vegetation-free zone, consistent with USACE levee vegetation policy. Equipment and materials necessary for rock slope protection are listed in Table 10. Postconstruction, areas disturbed by the equipment or the rock stockpile area would be hydroseeded with a native seed mix.

Table 10. Rock Slope Protection—Phases, Equipment, and Materials

Phases of Construction	Equipment	Materials
Site preparation (dependent on site conditions: clearing, grubbing, and stripping)	Scraper	Rock and soil (optional)
Rock placement	Crane	Rock, hydroseed
	Excavator	
	Loader	
	Barges	
Biotechnical element installation	Hand tools	Geotextiles, coir logs, and stakes (optional)
Site restoration and demobilization	Haul truck	Pole cuttings, container stock, and transplanted vegetation (optional)

Operation and Maintenance

Postconstruction, only the rock slope protection and native vegetation and other biotechnical features are permanent. O&M for plantings may include irrigation, weeding, and monitoring during an establishment period.

Impacts on Waters of the United States

The placement of riprap below the OHWM of the Sacramento River would impact navigable waters of the United States, as described in Table 11.

Road Construction, Marina Access, and Bees Lakes

A majority of South River Road traffic would be relocated to the landside of the Sacramento River South Levee to the future Village Parkway alignment. Year 1 would include the construction of this section of the future Village Parkway and the associated marina access roads (Figure 3).

Village Parkway would be extended to the project area's southern extent, moving South River Road traffic to the landside of the levee. Marina access would be maintained through extension of Davis Road and Linden Road to connect Village Parkway and South River Road. A direct connection from Village Parkway to Gregory Avenue would be added 0.3 mile south of Bevan Road. In order to maintain access to the marinas, two new roads would be constructed that would be routed over the levee crown. The first road would be constructed just north of the Bees Lakes area, and the second would be constructed on the southern side of the Bees Lakes area. Where practicable, culverts would be constructed in ditches that are crossed by proposed roadways and O&M corridors would parallel alongside roads.

The project would not implement measures to hydraulically connect Bees Lakes and the Sacramento River. The road embankments, acting as levees and linked to the setback levee and the existing levee, would create an isolation ring levee around Bees Lakes. This ring levee would prevent hydraulic surface connectivity between Bees Lakes and the Sacramento River. Access roads and appurtenant ramps would be constructed atop the proposed setback and adjacent levees, as well as within the offset area.

Impacts on Waters of the United States

Construction of culverts to allow road crossings would impact ditches. These impacts and fill quantities are provided in Table 11 under "Project Impacts", below. A typical culvert design is shown on Figure 5.

Levee Breaches (Inlets)

Objective

Portions of the existing levee would be breached to allow Sacramento River flows into the offset areas. The breach shoulders would be armored with rock placed in a layer approximately 2.5 feet thick extending the entire length of the breach and would include the top of the adjacent degraded levee shoulders for 100 feet on each side of the breach. Laterally, the revetment would extend from the toe of the riverbank to 100 feet landward of the centerline of the degraded levee. Some areas that would receive rock slope protection are currently riprapped. See Figures 5a to 5e to see a plan and cross sections of levee breaches.

Wherever possible, the bank protection at the breaches is designed both to control erosion and to maintain existing vegetation and IWM as much as possible. This can be accomplished by incorporating rock benches that serve as buffers against extreme toe scour and shear stress while providing space for planting riparian vegetation and creating a platform to support aquatic habitat features. The breach locations would not be subject to USACE levee vegetation guidance and would

be vegetated using biotechnical designs. The final design of the breaches would be included in the Offset Area Restoration Plan still in preparation.

Design and Construction

The placement of rock onto the levee slope would occur either from atop the levee or from the waterside by means of barges, or both. Rock required within the channel, both below and slightly above the surface of the water at the time of placement, would be placed by a crane located on a barge and then spread by an excavator located on top of the levee. Construction would require two barges—one barge would carry the crane while the other barge would hold the stockpile of rock to be placed on the channel slopes—and one excavator located on top of the levee. Rock required on the upper portions of the slopes would be placed by an excavator located on top of the levee. Rock placement from atop the levee would require one excavator and one loader for each potential placement site. The loader brings the rock from a permitted source within 25 miles of the project area and dumps it within 100 feet of the levee. The excavator then moves the rock from the stockpile to the waterside of the levee. Soil may be placed in the interstitial spaces, followed by hand installation of native vegetation consistent with USACE levee vegetation policy. Equipment and materials necessary for rock slope protection are listed in Table 10 above.

Impacts on Waters of the United States

The placement of riprap below the OHWM of the Sacramento River would impact navigable waters of the United States, as described in Table 11.

Offset Floodplain Area

The offset floodplain area, or offset area, refers to the expanded floodway waterside of the proposed setback levee that is created when portions of the existing levee are breached to allow Sacramento River water to flow into the offset area. Project activities in this area would include floodplain and habitat restoration and borrow excavation.

The offset floodplain area mitigates the losses of existing habitat values due to project effects, as well as maximizes the potential habitat value in the Sacramento River floodplain.

Where excavated material is appropriate for reuse, it would be used in construction of the setback levee. After excavation, disturbed areas would be finished and graded to allow creation of restored habitats. Once construction of the setback levee is complete, the existing levee would be degraded and breached in several locations to allow inlet and outlet of floodplain-inundating flows.

The target habitats in the offset floodplain area consist of riparian forest, shaded riverine aquatic habitat, seasonal wetlands, and upland grasslands. Elevations in the offset floodplain area would vary from approximately +7.0 feet NAVD 88 to +20.0 feet NAVD 88 in order to provide broad habitat variability for a range of environmental and hydrodynamic conditions.

Upper terraces would support riparian habitat that transitions from willow scrub at lower elevations to mixed riparian forest at higher elevations. Native riparian plant species would be installed as container plants and pole cuttings at a regular spacing interval throughout the offset floodplain area. Both overstory and understory species would be installed to mimic the natural structure of riparian forests along the Sacramento River. Supplemental irrigation would be provided for several years during the plant establishment period and then discontinued, with the source possibly pumped from the river or by agreement with an owner of an adjacent water supply. To

avoid trampling or disturbance of the plantings during the establishment period, signs would be posted at appropriate intervals providing notice that access to the restoration areas is not allowed. Exclusionary fencing for these purposes likely would not be allowed by the CVFPB.

A network of seasonal wetland channels would be excavated in the offset floodplain area and inundate during high-water events on the Sacramento River to provide habitat for special-status native fish species, including Sacramento splittail and steelhead. To mimic some natural floodplain conditions that species like splittail depend on for spawning and rearing, the channels would be constructed at an elevation that provides shallow, low-velocity, off-channel habitat in the spring during smaller flood events. Channel margins would be gently sloping to maximize edge habitat during flood events. IWM structures could be installed in some of the channels to provide cover from predators. In larger flood events during the winter and spring, the upper riparian terraces would be inundated and provide additional areas of habitat for fish as well as contribute to the productivity of the ecological foodweb.

The created channels would follow the slope of the river and have several connections to the main river channel in order to maximize connectivity and minimize potential stranding as floodwaters recede. The channels would fully dewater by the early summer in order to discourage use by nonnative fish.

Areas of upland grassland in the offset floodplain area would serve as potential floodplain rearing habitat for native fish as well as foraging habitat for raptors during periods of low water.

Habitat restoration in the offset area, along the degraded levee and within the levee breaches, is further described under “Mitigation” in Box 23, below.

Grading of the offset areas would result in the fill of several ditches, which are listed in Table 11 under “Project Impacts,” below.

Construction Details

Construction Schedule

Primary construction of the project would occur in more than one annual construction season (typically April 15 to October 31, subject to conditions), with construction of Segments C, D, E, F, and G preceding construction of Segments A and B. Construction of the first segments is scheduled to begin during the 2014 construction season, and construction of segments A and B would begin during the 2015 construction season. Regrading of borrow sites would be ongoing; regrading of any sites used during Year 2 would be completed in a third year of project construction. Some preparation of construction may occur during the 2013 construction season, but no changes would be made to the existing levee prism and this work would not require a DA permit. Year-round offseason construction would also occur when permissible under permit conditions, weather allowing.

At the end of each construction season, the flood protection system would be restored, at a minimum, to the level of protection existing at the project outset. During construction Year 1, “tie-ins” would be built connecting the existing levee up- and downstream to the segments constructed that season. These tie-ins would be achieved by benching the existing levee and installing

compacted lifts to completely bond the new and existing levee materials. During the flood season, maintenance of the baseline level of flood protection would be undertaken by the maintaining agency, RD 900.

Borrow Material Excavation

To meet borrow material demands for constructing the flood risk–reduction measures, multiple sources are being considered, including:

- Embankment fill material excavated from the existing levee structure as part of construction.
- Material excavated from borrow sites located on open land within the city.
- Dredged material previously removed from the deep water ship channel (presently stockpiled on high-terrace, upland benches adjacent to the west of the channel).
- Material purchased from permitted commercial borrow locations within 20 miles of the project site.

Embankment fill material excavated as part of construction would be evaluated for reuse, and that deemed suitable would be used as part of construction of the new levees and berms.

Ongoing borrow analysis has identified potential borrow sites in the Southport project area from which suitable borrow may be excavated (Figure 1). These potential borrow sites range in location from immediately adjacent to the levee construction to approximately 3.5 miles away. If local borrow sites are used, existing top soil would be scraped and set aside and borrow material excavated from the site. Excavation depths would vary, depending on landowner agreement; however, wherever feasible, depths of excavation would not encroach upon the water table. Following material extraction, Southport-area borrow sites would be graded to a depth of no greater than 3 feet and returned to preproject drainage and irrigation conditions.

To maximize the use of local borrow sites, high plasticity clay may be used as deeply buried setback levee core fill material. To increase the workability and load-bearing characteristics of high plasticity clay, lime treatment may be performed prior to borrow material excavation using high calcium quicklime (hydrated lime, commercial lime slurry, or dry quicklime). To treat borrow material with lime, the contractor would scarify the area to be treated, spreading the lime at a uniform rate. The lime would be mixed into the soil with a rotary pulverizing mixer, adding water during mixing. The initial mixture cures for 16 to 48 hours, then would be remixed using the same equipment. Upon completion of the remixing, the treated material would be excavated and transported to the fill site for placement and compaction.

Where feasible, excess embankment fill material deemed unsuitable for reuse could be placed in the borrow site pits and compacted, and the top soil replaced, returning the site to its original elevation. The borrow sites then would be reseeded and returned to pre-use vegetated conditions. Excavation of borrow material would not occur in waters of the United States

Management of Woody Vegetation

Woody vegetation remaining on levees after construction would be managed according to levee vegetation inspection criteria and consistent with the CVFPP. The inspection criteria establish a vegetation management zone in which trees are trimmed up to 5 feet above the ground (12-foot clearance above the crown road) and thinned for visibility and access. Brush, weeds, and other such

vegetation over 12 inches high are to be removed in an authorized manner. The vegetation management zone includes the entire landside levee slope plus 15 feet beyond the landside toe (or less, if the existing easement is less than 15 feet), the levee crown, and the top 20 feet (slope length) of the waterside levee slope.

Waterside vegetation below the vegetation management zone would remain in place without trimming or thinning, unless it poses an unacceptable threat to levee integrity.

Vegetation that was introduced, allowed, required as mitigation, or endorsed by a previous USACE action as necessary to comply with environmental requirements, and/or was present when the levee system was transferred from the USACE to a non-Federal sponsor, would not be removed (unless changed conditions cause such vegetation to pose an unacceptable threat or it creates a visibility problem within the vegetation management zone).

The CVFPP proposes a long-term, adaptive, vegetation life-cycle management (LCM) plan that will lead to the eventual elimination of trees and other woody vegetation through removal of immature trees and woody vegetation. LCM will be implemented in the vegetation management zone, as described above.

This plan will allow existing “legacy” trees and other woody vegetation beyond a certain size to live out their normal life cycles on the levee unless they pose an unacceptable threat. Under the LCM plan, removal of immature trees and woody vegetation less than 4 inches in diameter at breast height will be conducted in consultation with the appropriate resources agencies.

Per the Urban Levee Design Criteria (ULDC), before any tree removal, an engineering inspection and evaluation should be conducted to identify trees and woody vegetation (alive or dead) that pose an unacceptable threat to the integrity of the levee.

Structure and Road Demolition and Utility Relocation

Structure and road demolition activities would consist of removing standing structures within the flood risk-reduction measure corridor and removing sections of two-lane asphalt rural road in the project area. Implementation of the project would require the demolition of 19 structures (12 residences) in Segment A, 37 structures (including 12 residences) in Segment B, one structure in Segment C, three structures in Segment D (including 1 residence), 10 structures in Segment F, (including 5 residences), and one residence in Segment G. South River Road would be removed along the levee crown in Segments B through F and on the landside of the levee in Segment A, but replaced in Segment E.

Existing facilities located within the flood risk-reduction measure footprints may require removal and nearby replacement, abandonment, or relocation. The project would require demolition of RD 900's inactive irrigation pump station located in the project area on the landside of the levee just south of the intersection of Linden Road and South River Road. The project would also require removal and relocation of the following facilities: a cell tower near Linden Road, an overhead power line located along the landside toe of the existing levee, and underground telecommunication lines within the levee prism.

Vegetation Removal

Vegetation clearing activities would consist of removing larger woody vegetation, such as trees and shrubs. Grubbing activities consist of removing roots, and stripping activities consist of excavating

approximately 6 inches of organic material from the levee surface. The vegetation on the existing Sacramento River levee mostly would be retained, with the exception of the five breach locations, because the levee no longer would provide flood-risk reduction function or be subject to the USACE vegetation guidelines. Some vegetation would be removed as part of construction of the new setback levee, seepage berms, and the landside utility O&M corridor.

Staging Areas and Equipment Access

As depicted on Figure 3, three staging areas would be used in the project area. These staging areas are located on the landside of the levee at Segments B, C, and F and would occupy approximately 3.2, 11.0, and 13.1 acres, respectively. These areas would be used for staging construction activities and to provide space to house construction equipment and materials before and during construction activities. The staging area at Segment B (3.2 acres) would correspond with Segment A and B construction, and the staging areas at Segments C (11.0 acres) and F (13.1 acres) would be used for the construction of Segments C through G.

To facilitate project construction, temporary earthen ramps would be constructed to ease equipment access between the levee crown and the staging area(s). The earthen ramps would not affect any delineated water bodies and would be removed when construction is complete.

Summary of Project Impacts on Waters of the United States

The reason, impact acreage, and quantity of fill discharged to each water body is provided in Table 11. The quantity of fill into ditches was estimated by multiplying the length of fill by the average width of the ditch, by an assumed 1 foot depth.

Table 11. Impacts to Waters of the United States

Water Body	Reason for Discharge	Permanent Impact (acres)	Linear Feet	Estimated Quantity of Fill (cubic yards)
PD-1: Perennial Drainage (Sacramento River)	Bank Stabilization	22.240	13,021	140,613 cy of riprap
	Levee Breach	13.518	6,590	207,331 cy of riprap
D-01: Agricultural Ditch	Setback Levee	0.057	3,708	140 cy soil
	Seepage Berm	0.084		
	Offset Area	0.266		
	Roads	0.006		
	O&M Corridor	0.013		
D-02: Agricultural Ditch	Offset Area	0.125	1,085	193 cy soil
D-03: Agricultural Ditch	Setback Levee	0.013	597	111 cy soil 2 cy riprap
	Offset Area	0.040		2 cy concrete
	Roads	0.006		1 pipe culvert
	O&M Corridor	0.009		
D-04: Agricultural Ditch	Offset Area	0.306	3,257	462 cy soil
D-05: Riparian Ditch	Seepage Berm	0.007	113	26 cy soil
	O&M Corridor	0.006		
D-06: Riparian Ditch	Seepage Berm	0.020	282	40 cy soil
	Roads	0.006		2 cy riprap
	O&M Corridor	0.006		2 cy concrete 1 pipe culvert
D-07: Riparian Ditch	Offset Area	0.086	1,031	250 cy soil
	O&M Corridor	0.056		
D-08: Riparian Ditch	Setback Levee	0.019	644	158 cy soil
	Seepage Berm	0.055		
	Offset Area	0.002		
	O&M Corridor	0.018		
D-09: Riparian Ditch	Offset Area	0.046	398	72 cy soil
D-10: Riparian Ditch	Setback Levee	0.035	407	50 cy soil
	Roads	0.028		4 cy riprap
	O&M Corridor	0.011		4 cy concrete 2 pipe culvert
D-11: Riparian Ditch	Setback Levee	0.001	325	61 cy soil
	Seepage Berm	0.038		
	O&M Corridor	0.007		

Water Body	Reason for Discharge	Permanent Impact (acres)	Linear Feet	Estimated Quantity of Fill (cubic yards)
D-12: Riparian Scrub Ditch	Setback Levee	0.014	439	82 cy soil
	Seepage Berm	0.015		
	Offset Area	0.019		
	O&M Corridor	0.002		
D-13: Riparian Scrub Ditch	O&M Corridor	0.001	5	1 cy soil
D-14: Roadside Ditch	Levee Slope Flattening	0.168	3,897	278 cy soil
	O&M Corridor	0.005		
	Adjacent Levee	0.006		
D-17: Agricultural Ditch	Setback Levee	0.014	1,231	169 cy soil 2 cy riprap 2 cy concrete 1 pipe culvert
	Seepage Berm	0.034		
	Offset Area	0.078		
	Roads	0.011		
	O&M Corridor	0.008		
D-20: Agricultural Ditch	Roads	0.011	92	2 cy riprap 2 cy concrete 1 pipe culvert
D-21: Agricultural Ditch	Setback Levee	0.006	680	34 cy soil
	Seepage Berm	0.014		
	Offset Area	0.008		
	O&M Corridor	0.003		
D-27: Agricultural Ditch	Roads	0.053	352	6 cy riprap 6 cy concrete 3 pipe culvert
Perennial Drainages (Sacramento River)		35.758	19,611	347,962 cy riprap
Agricultural and Roadside Ditches		1.347	14,899	1,738 cy soil
Riparian and Riparian Scrub Ditches		0.499	3,644	20 cy concrete
Total:		37.604	38,154	10 pipe culverts

Box 23. Avoidance, Minimization, and Compensation

Avoidance and Minimization

The Southport project has been designed to avoid and minimize impacts on waters of the United States to the maximum extent practicable while still meeting SAFCA's need for flood protection. For example:

- Seepage berms will be the minimum width necessary to avoid additional impacts on landside drainages.
- All borrow excavation outside of the construction footprint will avoid waters of the United States entirely.

- Culverts placed in ditches will be sized to accommodate expected high water flows and maintain preproject downstream flows.
- Rock or concrete aprons will be placed at the upstream and downstream ends of the culverts to prevent erosion and sedimentation to waters.
- All temporary culvert or flat car crossings of ditches needed for vehicle and equipment access will be removed when construction is completed.
- Once construction is completed, all temporarily disturbed areas will be restored to preproject conditions and will be revegetated with a native grass mix or hydroseeded.

Stormwater Pollution Prevention Plan

Because ground disturbance would be greater than 1 acre, WSAFCA will obtain coverage under the U.S. Environmental Protection Agency's (EPA's) National Pollutant Discharge Elimination System (NPDES) general construction activity stormwater permit. The Central Valley Regional Water Quality Control Board (Regional Water Board) administers the NPDES stormwater permit program in Yolo County. Obtaining coverage under the NPDES general construction activity permit generally requires that the project applicant prepare a stormwater pollution prevention plan (SWPPP) that describes the best management practices (BMPs) that will be implemented to control accelerated erosion, sedimentation, and other pollutants during and after project construction. The SWPPP will be prepared prior to commencing earth-moving construction activities.

The specific BMPs that will be incorporated into the erosion and sediment control plan and SWPPP will be site-specific and will be prepared by the construction contractor in accordance with the Regional Water Board Field Manual. However, the plan likely will include, but not be limited to, one or more of the following standard erosion and sediment control BMPs.

- **Timing of construction.** The construction contractor will conduct all construction activities during the typical construction season to avoid ground disturbance during the rainy season.
- **Staging of construction equipment and materials.** To the extent possible, equipment and materials will be staged in areas that have already been disturbed. No equipment or materials would be stored in the floodway during the flood season.
- **Minimize soil and vegetation disturbance.** The construction contractor will minimize ground disturbance and the disturbance/destruction of existing vegetation. This will be accomplished in part through the establishment of designated equipment staging areas, ingress and egress corridors, and equipment exclusion zones prior to the commencement of any grading operations.
- **Stabilize grading spoils.** Grading spoils generated during the construction will be temporarily stockpiled in staging areas. Silt fences, fiber rolls, or similar devices will be installed around the base of the temporary stockpiles to intercept runoff and sediment during storm events. If necessary, temporary stockpiles may be covered with an appropriate geotextile to increase protection from wind and water erosion.
- **Install sediment barriers.** The construction contractor may install silt fences, fiber rolls, or similar devices to prevent sediment-laden runoff from leaving the construction area.
- **Stormwater drain inlet protection.** The construction contractor may install silt fences, drop inlet sediment traps, sandbag barriers, and/or other similar devices.

- **Permanent site stabilization.** The construction contractor will install structural and vegetative methods to permanently stabilize all graded or otherwise disturbed areas once construction is complete. Structural methods may include the installation of biodegradable fiber rolls and erosion control blankets. Vegetative methods may involve the application of organic mulch and tackifier and/or the application of an erosion control native seed mix. Implementation of a SWPPP will substantially minimize the potential for project-related erosion and associated adverse effects on water quality.

Bentonite Slurry Spill Contingency Plan (Frac-Out Plan)

Before excavation begins, WSAFCA will ensure the contractor will prepare and implement a bentonite slurry spill contingency plan (BSSCP) for any excavation activities that use pressurized fluids (other than water). If the contractor prepares the plan, it will be subject to approval by USACE, NMFS, and WSAFCA before excavation can begin. The BSSCP will include measures intended to minimize the potential for a frac-out (short for “fracture-out event”) associated with excavation and tunneling activities; provide for the timely detection of frac-outs; and ensure an organized, timely, and “minimum-effect” response in the event of a frac-out and release of excavation fluid (bentonite). The BSSCP will require, at a minimum, the following measures.

- If a frac-out is identified, all work will stop, including the recycling of the bentonite fluid. In the event of a frac-out into water, the location and extent of the frac-out will be determined, and the frac-out will be monitored for 4 hours to determine whether the fluid congeals (bentonite will usually harden, effectively sealing the frac-out location).
- NMFS, DFG, and the Regional Water Board will be notified immediately of any spills and will be consulted regarding clean-up procedures. A Brady barrel will be on site and used if a frac-out occurs. Containment materials, such as straw bales, also will be on site prior to and during all operations, and a vacuum truck will be on retainer and available to be operational on site within 2 hours’ notice. The site supervisor will take any necessary follow-up response actions in coordination with agency representatives. The site supervisor will coordinate the mobilization of equipment stored at staging areas (e.g., vacuum trucks) as needed.
- If the frac-out has reached the surface, any material contaminated with bentonite will be removed by hand to a depth of 1 foot, contained, and properly disposed of, as required by law. The drilling contractor will be responsible for ensuring that the bentonite is either properly disposed of at an approved Class II disposal facility or properly recycled in an approved manner.
- If the bentonite fluid congeals, no other actions, such as disturbance of the streambed, will be taken that potentially would suspend sediments in the water column.
- The site supervisor has overall responsibility for implementing this BSSCP. The site supervisor will be notified immediately when a frac-out is detected. The site supervisor will be responsible for ensuring that the biological monitor is aware of the frac-out; coordinating personnel, response, cleanup, regulatory agency notification and coordination to ensure proper clean-up; disposal of recovered material; and timely reporting of the incident. The site supervisor will ensure all waste materials are properly containerized, labeled, and removed from the site to an approved Class II disposal facility by personnel experienced in the removal, transport, and disposal of drilling mud.
- The site supervisor will be familiar with the contents of this BSSCP and the conditions of approval under which the activity is permitted to take place. The site supervisor will have the

authority to stop work and commit the resources (personnel and equipment) necessary to implement this plan. The site supervisor will ensure that a copy of this plan is available (on site) and accessible to all construction personnel. The site supervisor will ensure that all workers are properly trained and familiar with the necessary procedures for response to a frac-out prior to commencement of excavation operations.

Spill Prevention, Control, and Countermeasure Plan

A spill prevention, control, and countermeasure plan (SPCCP) is intended to prevent any discharge of oil into navigable water or adjoining shorelines. WSAFCA or its contractor will develop and implement an SPCCP to minimize the potential for and effects from spills of hazardous, toxic, or petroleum substances during construction and operation activities. The SPCCP will be completed before any construction activities begin. Implementation of this measure will comply with state and Federal water quality regulations. The SPCCP will describe spill sources and spill pathways in addition to the actions that will be taken in the event of a spill (e.g., an oil spill from engine refueling will be immediately cleaned up with oil absorbents). The SPCCP will outline descriptions of containments facilities and practices such as double-walled tanks, containment berms, emergency shutoffs, drip pans, fueling procedures, and spill response kits. It will describe how and when employees are trained in proper handling procedure and spill prevention and response procedures.

WSAFCA will review and approve the SPCCP before onset of construction activities and routinely inspect the construction area to verify that the measures specified in the SPCCP are properly implemented and maintained. WSAFCA will notify its contractors immediately if there is a noncompliance issue and will require compliance.

The Federal reportable spill quantity for petroleum products, as defined in 40 CFR 110, is any oil spill that:

- Violates applicable water quality standards.
- Causes a film or sheen on or discoloration of the water surface or adjoining shoreline.
- Causes a sludge or emulsion to be deposited beneath the surface of the water or adjoining shorelines.

If a spill is reportable, the contractor's superintendent will notify WSAFCA, and WSAFCA will take action to contact the appropriate safety and cleanup crews to ensure that the SPCCP is followed. A written description of reportable releases must be submitted to the Regional Water Board. This submittal must contain a description of the release, including the type of material and an estimate of the amount spilled, the date of the release, an explanation of why the spill occurred, and a description of the steps taken to prevent and control future releases. The releases will be documented on a spill report form.

If an appreciable spill occurs and results determine that project activities have adversely affected surface or groundwater quality, a detailed analysis will be performed by a registered environmental assessor or professional engineer to identify the likely cause of contamination. This analysis will conform to American Society for Testing and Materials (ASTM) standards and will include recommendations for reducing or eliminating the source or mechanisms of contamination. Based on this analysis, WSAFCA and its contractors will select and implement measures to control contamination, with a performance standard that surface water quality and groundwater quality must be returned to baseline conditions.

Turbidity Monitoring in Adjacent Water Bodies

WSAFCA or its contractor will monitor turbidity in the adjacent water bodies, where applicable criteria apply, to determine whether turbidity is being affected by construction and ensure that construction does not affect turbidity levels, which ultimately increase the sediment loads.

The Regional Water Board's Water Quality Control Plan (2009) (Basin Plan) contains turbidity objectives for the Sacramento River. Specifically, the plan states that where natural turbidity is between 5 and 50 nephelometric turbidity units (NTUs), turbidity levels may not be elevated by 20% above ambient conditions. Where ambient conditions are between 50 and 100 NTUs, conditions may not be increased by more than 10 NTUs.

WSAFCA or its contractor will monitor ambient turbidity conditions upstream during construction and adhere to the Surface Water Quality Ambient Monitoring Program (SWAMP) requirements for turbidity monitoring. Monitoring will continue approximately 300 feet downstream of construction activities to determine whether turbidity is being affected by construction. Grab samples will be collected at a downstream location that is representative of the flow near the construction site. If there is a visible sediment plume being created from construction, the sample will represent this plume. Monitoring will occur hourly when construction encroaches into the Sacramento River. If construction does not encroach into the river, the monitoring will occur once a week on a random basis.

If turbidity limits exceed Basin Plan standards, construction-related earth-disturbing activities will slow to a point that results in alleviating the problem. WSAFCA will notify the Regional Water Board of the issue and provide an explanation of the cause.

Federally-listed Species

The federally-listed species that are known to occur or have the potential to occur in the Southport project area are listed in Table 12, below.

Table 12. Federally Listed Threatened and Endangered Species

Common and Scientific Names	Federal Status	Potential Occurrence in Affected Area
Valley elderberry longhorn beetle <i>Desmocerus californicus dimorphus</i>	T	High—two CNDDDB (2012) occurrences in the project area and approximately 58 shrub locations (potential VELB habitat) found in the project area during field surveys (2005–2011)
Giant garter snake <i>Thamnophis gigas</i>	T	Moderate—CNDDDB occurrences within 3 miles of project area.
Delta smelt <i>Hypomesus transpacificus</i>	T	High
Central Valley steelhead <i>Oncorhynchus mykiss</i>	T	High—spawning during migration
Sacramento River winter-run Chinook salmon <i>Oncorhynchus tshawytscha</i>	E	High—spawning during migration
Central Valley spring-run Chinook salmon <i>Oncorhynchus tshawytscha</i>	T	High—spawning during migration

Common and Scientific Names	Federal Status	Potential Occurrence in Affected Area
Central Valley fall-/late fall-run Chinook salmon <i>Oncorhynchus tshawytscha</i>	SC	High—spawning during migration
Green sturgeon (southern DPS) <i>Acipenser medirostris</i>	T	High—spawning during migration

E = Listed as endangered under the federal Endangered Species Act (ESA).
T = Listed as threatened under ESA.
SC = Species of concern.

Biological assessments are currently being prepared to support formal Section 7 consultation between USACE and the U.S. Fish & Wildlife Service (USFWS) and the National Marine Fisheries Service (NMFS). Measures to avoid and minimize impacts on the habitat of the species in Table 12 are provided below.

Valley Elderberry Longhorn Beetle

Before any ground-disturbing activities occur, WSAFCA will ensure that a minimum 4-foot-tall, temporary plastic mesh-type construction fence (Tensor Polygrid or equivalent) is installed at least 20 feet from the dripline of the elderberry shrub. This fencing is intended to prevent encroachment by construction vehicles and personnel. The exact location of the fencing will be determined by a qualified biologist, with the goal of protecting sensitive biological resources (habitat for VELB). The fencing will be strung tightly on posts set at a maximum interval of 10 feet. The fencing will be installed in a way that prevents equipment from enlarging the work area beyond what is necessary to complete the work. The fencing will be checked and maintained weekly until all construction is completed. This buffer zone will be marked by a sign stating:

This is habitat of the valley elderberry longhorn beetle, a threatened species, and must not be disturbed. This species is protected by the Endangered Species Act of 1973, as amended. Violators are subject to prosecution, fines, and imprisonment.

No construction activity, including grading, will be allowed until this condition is satisfied. The fencing and a note reflecting this condition will be shown on the construction plans.

WSAFCA will ensure that dust control measures are implemented for all ground-disturbing activities in the project area. These measures may include application of water to graded and disturbed areas that are unvegetated. To avoid attracting Argentine ants, at no time will water be sprayed within the driplines of elderberry shrubs.

Elderberry shrubs growing within 20 feet of proposed construction areas will require transplanting prior to any ground-disturbing activities. In the event that elderberry shrubs determined to be directly affected can be retained on site but occur within 20 feet of proposed construction activities, dust control measures will be required to minimize direct effects on these shrubs. Therefore, the applicant will implement one of the following mitigation measures for each elderberry shrub that occurs within 20 feet of proposed construction activities.

- All elderberry shrubs that occur in proposed development areas will be transplanted to a USFWS-approved conservation area in accordance with the Conservation Guidelines for Valley Elderberry Longhorn Beetle (U.S. Fish and Wildlife Service 1999). These elderberry shrubs will be transplanted when they are dormant (after they lose their leaves), in the period starting

approximately in November and ending in the first 2 weeks of February. A qualified specialist familiar with elderberry shrub transplantation procedures will supervise the transplanting. The location of the conservation area transplantation site will be approved by USFWS before removal of the shrubs.

OR

- If it is determined that elderberry shrubs can be avoided but that construction activities will occur within 20 feet of the shrubs, the applicant will ensure that dust control measures (e.g., watering) are implemented in the vicinity of the shrub. To further minimize effects associated with dust accumulation, the elderberry shrubs will be covered by a protective cloth (burlap) during all ground-disturbing activities occurring within 20 feet of the shrubs. The cloth will be removed daily and immediately after ground-disturbing activities are completed. In addition, temporary construction fencing will be placed around the dripline of the elderberry shrubs before the start of construction activities to ensure that the shrub is not inadvertently removed.

Giant Garter Snake

WSAFCA will implement the following measures to minimize effects on giant garter snake and its habitat.

- Staging areas will be located at least 200 feet from suitable giant garter snake habitat.
- Any dewatered habitat will remain dry for at least 15 consecutive days after April 15 and prior to excavating or filling of the dewatered habitat.
- Vegetation clearing within 200 feet of the banks of suitable giant garter snake aquatic habitat will be limited to the minimum area necessary. Avoided giant garter snake habitat within or adjacent to the project area will be flagged and designated as an environmentally sensitive area, to be avoided by all construction personnel.
- The movement of heavy equipment within 200 feet of the banks of suitable giant garter snake aquatic habitat will be confined to designated haul routes to minimize habitat disturbance.

Fish Species

WSAFCA will minimize fish stranding by developing and implementing a drainage and grading plan that minimizes the extent of ponding and facilitates complete drainage of the active floodplain to the main river. As part of the final offset area design, WSAFCA will determine the specific topographic and hydrologic characteristics of the levee offset area and will define the flooding regime (depth, duration, and extent of flooding), drainage patterns, and potential fish stranding risks. The final project design will include re-contouring as necessary to facilitate complete drainage and unimpeded fish passage to the main river as floodwaters recede from the levee offset area. Features with substantial stranding risk will be filled and/or graded to minimize this risk.

A mitigation and monitoring plan will be developed by a qualified biologist on behalf of WSAFCA and will be approved by NMFS, USFWS, and DFG before implementation of the levee setback. The mitigation and monitoring plan will evaluate the effectiveness of the grading and drainage features in preventing or reducing fish stranding and will include provisions for remediation should the design fail to meet established performance or success criteria.

Mitigation

The project has been designed to avoid and minimize impacts on waters of the United States where practicable. Unavoidable impacts on ditches and the Sacramento River will be compensated for as follows:

Ditches

The Southport project will mitigate for ditch impacts by expanding the existing ditch system on the landward side of the proposed project levee. The plans for the new ditches will be provided when available.

Sacramento River

The Sacramento River will be impacted by the placement of riprap below the ordinary high water mark and the removal of shaded riverine aquatic habitat. Most of the Sacramento River through the impacted reaches is already riprapped and the additional riprap will be filling in eroded areas that have failed or strengthening the rock armor by thickening it. The impacts resulting in riprap would be more than adequately offset through creation of 120 acres of floodplain in the offset areas.

Offset Floodplain Area Design

A draft restoration plan for the offset areas is being developed and will be submitted to USACE upon completion. The restoration objectives developed for the project include:

- Provide compensatory mitigation credits for impacts on protected land cover types and to special-status species and potential habitat for these species
- Maximize shaded riverine aquatic (SRA)/channel margin habitat, over and above current erosion stabilization efforts using biotechnical methods.
- Enhance offset ecological values using topographic and vegetation/habitat heterogeneity.
- Restore portions of the historic Sacramento River floodplain (i.e., waters of the United States).
- Restore riparian and oak woodland habitat on the restored floodplain that will create continuous habitat corridors for wildlife movement
- Design habitat features to minimize future maintenance obligations (e.g., reduce opportunities for sediment and debris accumulation).
- Design floodplain planting and vegetation management schemes to avoid undesirable hydraulic and sediment transport impacts on the offset levee and offset area.
- Comply with current USACE levee vegetation policy to balance habitat needs with flood management objectives.

The preliminary target habitats to be restored are riparian, shaded riverine aquatic, seasonal wetlands, and upland grasslands. These targets were identified based on an evaluation of the current extent and condition of riparian and upland habitat, the historical conditions of the Sacramento River floodplain and its associated habitat values, the postproject floodplain conditions, and a review of similar projects in the region.

Approximately 120 acres of habitat floodplain habitat and 21,000 linear feet of SRA habitat will be restored or enhanced as part of the project implementation. The required portion of these acres of riparian habitat and SRA habitat will be used as project mitigation.

Design of the restoration project in the offset area is underway. Based on designs for the Southport EIP, which are currently being finalized, its anticipated that the offset area would be excavated down to a floodplain elevation of approximately 10.0' NAVD 88 and the excavated material would be utilized in constructing portions of the new flood control features. A low-flow swale would be excavated within the restored floodplain with an invert elevation at approximately +7.0' NAVD 88 to provide access to the vegetated floodplain terrace and a drainage point back to the main river channel to minimize the potential for fish stranding during flood water recession. Other elevations in the offset floodplain area would vary from approximately +7.0 feet NAVD 88 to +20.0 feet NAVD 88 in order to provide broad habitat variability for a range of environmental and hydrodynamic conditions. The existing Sacramento River levee would be excavated to a lower elevation or completely breached in places to create effective hydrologic connectivity between the restored floodplain and the main river channel.

Seasonal inundation of the floodplain, including restored riparian, woodland, and grassland habitats, would provide seasonal rearing habitat for juvenile salmonids. Based on a habitat suitability index (HSI) developed for juvenile salmonids by ICF International, the restored floodplain is likely to provide optimal or near-optimal rearing habitat for juvenile salmonids. Floodplain and riparian habitat inundation may also benefit other native fishes, including Sacramento splittail and steelhead trout. After young salmon have dispersed from spawning areas, the distribution and abundance of young salmon is determined largely by their preferences for shallow water and low water velocities, which in large rivers are found mostly along channel margins, floodplains, and other off-channel habitats.

Existing riparian habitat in the Southport EIP project area is limited to a narrow, discontinuous band of riparian vegetation on the Sacramento River levee and at isolated locations in the levee offset area. The primary area for restoring SRA habitat would be focused along the existing riverbank of the Sacramento River. The existing levee is generally positioned along the top of the riverbank. With implementation of the Southport EIP, the new levee would be set back and the existing levee will be degraded, partially or wholly, along the riverbank. Removing the existing levee from the riverbank will allow for substantial lengths of channel margin to be enhanced with riparian vegetation, slope flattening, and in-stream habitat structures. Riparian scrub and cottonwood forest habitat would be established on portions of the restored and/or lowered floodplain relatively close to the Sacramento River and would be subject to recurrent inundation. Riparian shrub habitat would include several willow species, buttonbush, and seedlings of other native riparian species. Cottonwood forest habitat would be subject to recurrent flooding and would include an overstory composed of cottonwood, sycamore, willow, box elder and Oregon ash. Understory riparian species such as California grape and California blackberry would be included in both planting palates to provide diversity in vegetative structure. Elderberry shrubs may be included in the restoration design as long as they don't present a conflict with managing the flood control features. Current project designs call for areas to be stabilized with biotechnical treatments to minimize bank erosion in critical areas. These erosion treatments may be modified to better maximize benefits provided to aquatic species with additional plantings and habitat structures such as root wads or engineered log jams.

Between the riverbank and the new offset levee alignment, a system of swales will be designed that will form the primary riparian and aquatic habitat corridors that will also provide for floodplain drainage of the offset area. Substantial aquatic to terrestrial transition 'edge' habitat will be created along these swales. In addition, topographic heterogeneity will be incorporated into the project design grading plans that will allow for a mosaic of seasonal wetland, riparian wetland, and riparian upland habitats. Seasonal wetland areas will be enhanced with wetland vegetation, while riparian upland habitats will include a variety of willow-scrub, cottonwood forest, and oak woodland plantings.

Finally, other enhancements may be incorporated, such as the inclusion of large woody material (root wads/engineered log jams) to provide for additional flow diversity and habitat refugia valuable for aquatic habitats in the offset area.

Construction

Construction of the restoration project will begin with fine grading of the offset area (major grading will be conducted as part of the Southport EIP) in compliance with the construction documents and any earthworks measures associated with the SRA/channel margin enhancement elements. This will involve grading the channel margin slope grading to a flatter profile, installation of instream woody material, and placement of rock reinforcement as required. Following this, installation of the irrigation system for the restoration plantings will occur. Once the irrigation system is installed and confirmed to be working per the construction drawings, the plantings will be installed. This will include installation of container plants or pole cuttings.

Once all planting and irrigation installation activities are complete, final site stabilization will occur with the application of an appropriate restoration seed mix and/or other erosion control measures.

As-built record drawings of the completed project will be prepared once all construction activities have been completed and the completed project has been accepted by the site owner or its designee.

Performance Monitoring

Annual performance of the riparian plantings and SRA/channel margin habitat will take place for the first ten years following construction and will consist of the following:

- vegetation monitoring conducted in accordance with the methodology developed by the California Native Plant Society which includes collection of data along transects or within quadrats, as appropriate to the habitat type,
- qualitative and quantitative monitoring of the physical structure of the channel margin habitat, including persistence of instream woody material installation, recruitment of additional woody material, and performance of rock reinforcement
- documentation of hydrological conditions, animal species observed or detected, integrity of signage and other general conditions, and corrective measures that may be appropriate to ensure relevant success criteria, and
- initial establishment of photodocumentation locations and collection of photographic data.

An annual monitoring report documenting the annual performance monitoring effort will be prepared for submittal to the appropriate resource agencies. The annual report will address the maintenance activities conducted the previous year, monitoring methods, results from the annual vegetation monitoring, photos from the designated photo stations, wildlife observations/detections,

and detailed information on the exotic vegetation removal efforts. In addition, each annual report will include the qualitative field information and the summary of the documentation of the planting area conditions.

Special Status Species

Valley Elderberry Longhorn Beetle

WSAFCA will compensate for direct effects (including transplanting) on all elderberry stems measuring 1 inch or more at ground level (i.e., VELB habitat) that are located within 20 feet of construction activities. Compensation will include planting replacement elderberry seedlings or cuttings and associated native plantings in a USFWS-approved conservation area, at a ratio between 1:1 and 8:1 (ratio = new plantings to affected stems), depending on the diameter of the stem at ground level, the presence or absence of exit holes, and whether the shrub is located in riparian habitat.

Mitigation credits for VELB would be purchased at a USFWS-approved mitigation bank or created in an on-site or off-site conservation area. A management plan for the mitigation sites would be developed and implemented according to USFWS Conservation Guidelines for Valley Elderberry Longhorn Beetle. Final compensation requirements and mitigation ratios for VELB will be determined through consultation with USFWS.

Giant Garter Snake

To compensate for the permanent loss of suitable aquatic and upland habitat for giant garter snake, WSAFCA will purchase off-site giant garter snake habitat credits from a USFWS-approved conservation area servicing the project area. Compensation requirements and mitigation ratios for GGS will be determined through consultation with USFWS.

Fish Species

To compensate for losses of riparian vegetation and shaded riverine aquatic (SRA) cover on the waterside slope of the existing levee, WSAFCA will incorporate riparian and wetland vegetation in the design of the offset area. Compensation requirements will be determined following quantification of SRA cover losses and determination of compensation ratios. Breaching the existing levee and lowering the floodplain to achieve frequent inundation of the floodplain will provide an opportunity to compensate and expand the amount of riparian habitat and SRA cover available to fish over a broad range of flows. Compensation and enhancement of SRA cover will be important objectives of the final design. The current conceptual restoration design includes the creation of one or more floodplain swales bordered by wetland and riparian benches to facilitate drainage of the floodplain and movements of fish between the river and floodplain during flood events. These swales and wetland/riparian benches will interface with the Sacramento River at low-elevation transition areas that extend from the floodplain to the river channel at the levee breaches. SRA cover along these swales will be available to fish on a seasonal or year-round basis depending on flows. Full compensation of SRA cover losses will likely take several years as vegetation matures, but SRA cover values within the breach areas will likely exceed the values that will be lost on the existing levee within 10-15 years.

WSAFCA will also implement hand installation of native vegetation outside the vegetation-free zone in the bank stabilization area. This onsite planting would provide additional SRA mitigation in

riprapped areas. However, compliance with the USACE levee vegetation policy and other regulatory or engineering constraints may limit the ability to achieve full on-site compensation.

Box 26. Required Permits and Approvals

The following permits and approvals are required to construct the proposed project. No permit applications have been submitted to date to the CVRWQCB, CDFW, or CVFPB.

Responsible Agency	Permit, Approval, or Consultation
U.S. Fish and Wildlife Service (USFWS)	A Biological Assessment is being prepared by ICF to facilitate formal consultation with USFWS by USACE Operations Division.
National Marine Fisheries Service (NMFS)	A Biological Assessment is being prepared by ICF to facilitate formal consultation with NMFS by USACE Operations Division.
State Office of Historic Preservation	A Programmatic Agreement has been prepared by ICF and submitted by USACE Operations Division to SHPO for review.
Central Valley Regional Water Quality Control Board (CVRWQCB)	Section 401 Water Quality Certification: Application will be filed subsequent to EIS/EIR draft release. NPDES for Construction Activity: a SWPPP will be prepared prior to the commencement of construction activities.
California Department of Fish and Wildlife (CDFW)	An application for a Section 1602 Lake and Streambed Alteration Agreement from DFG will be filed subsequent to EIS/EIR draft release.

Appendix A
Figures

Path: K:\Projects_1\HDRV00071_11_SouthPort\mapdoc\Working\Fig_1_Location_Impact_20130115.mxd AA 1/15/2013

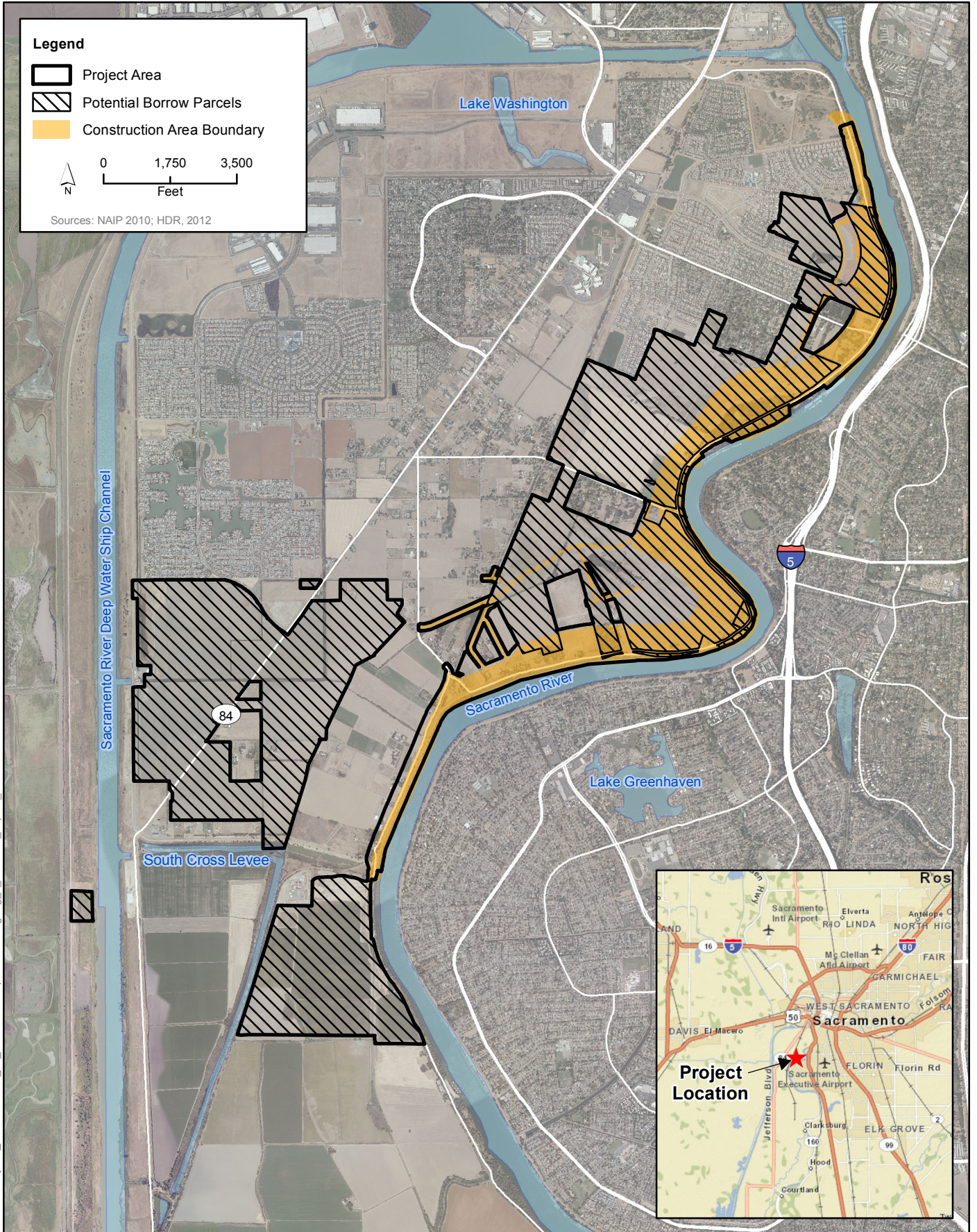
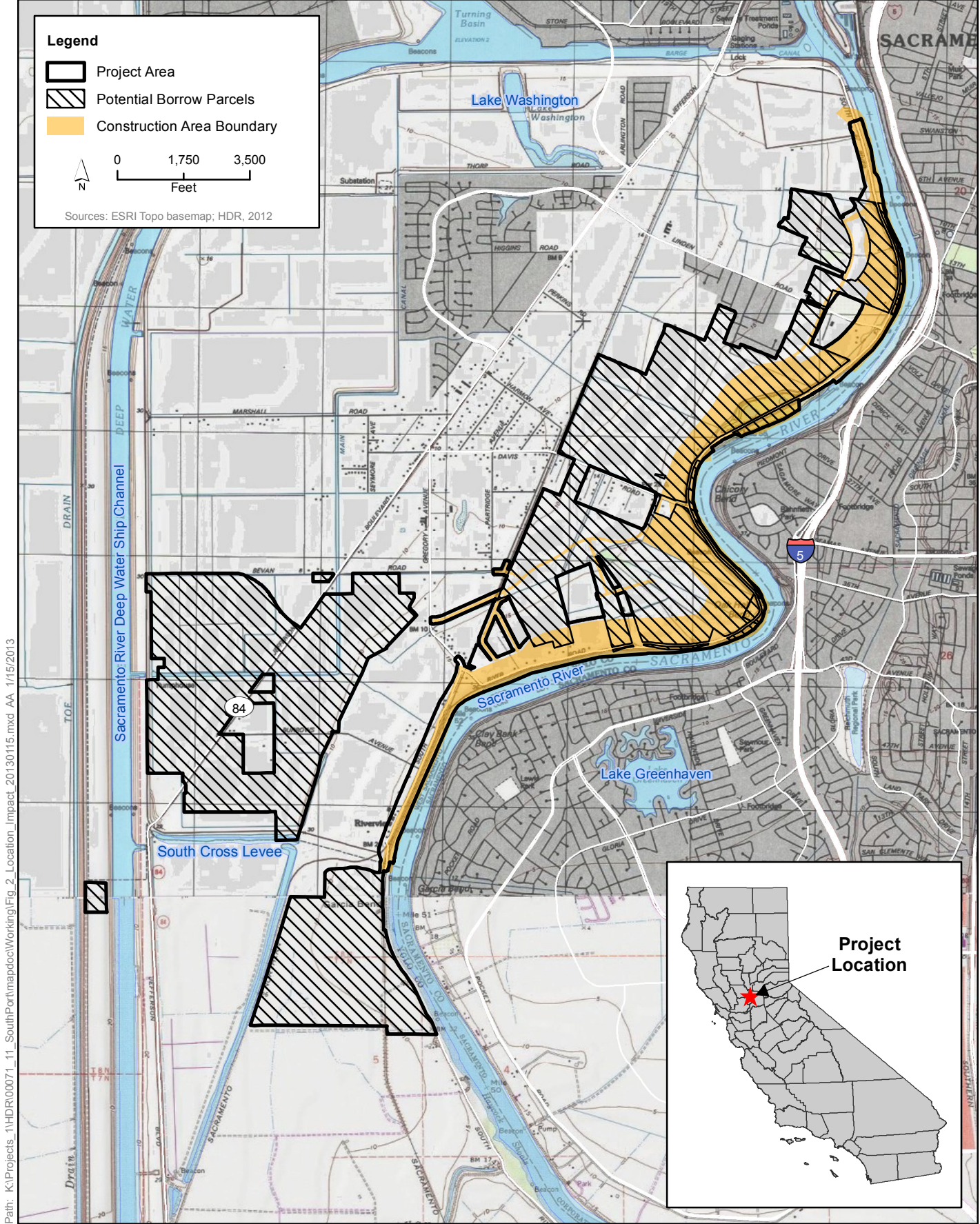

Figure 1
Project Location





Path: K:\Projects_1\HDR\00071_11_SouthPort\mapdoc\Working\Fig_2_Location_Impact_20130115.mxd AA_1/15/2013

Figure 2
Project Location



121°31'10"W

121°31'0"W

121°30'50"W

38°33'20"N

38°33'10"N

121°31'10"W

121°31'0"W

121°30'50"W

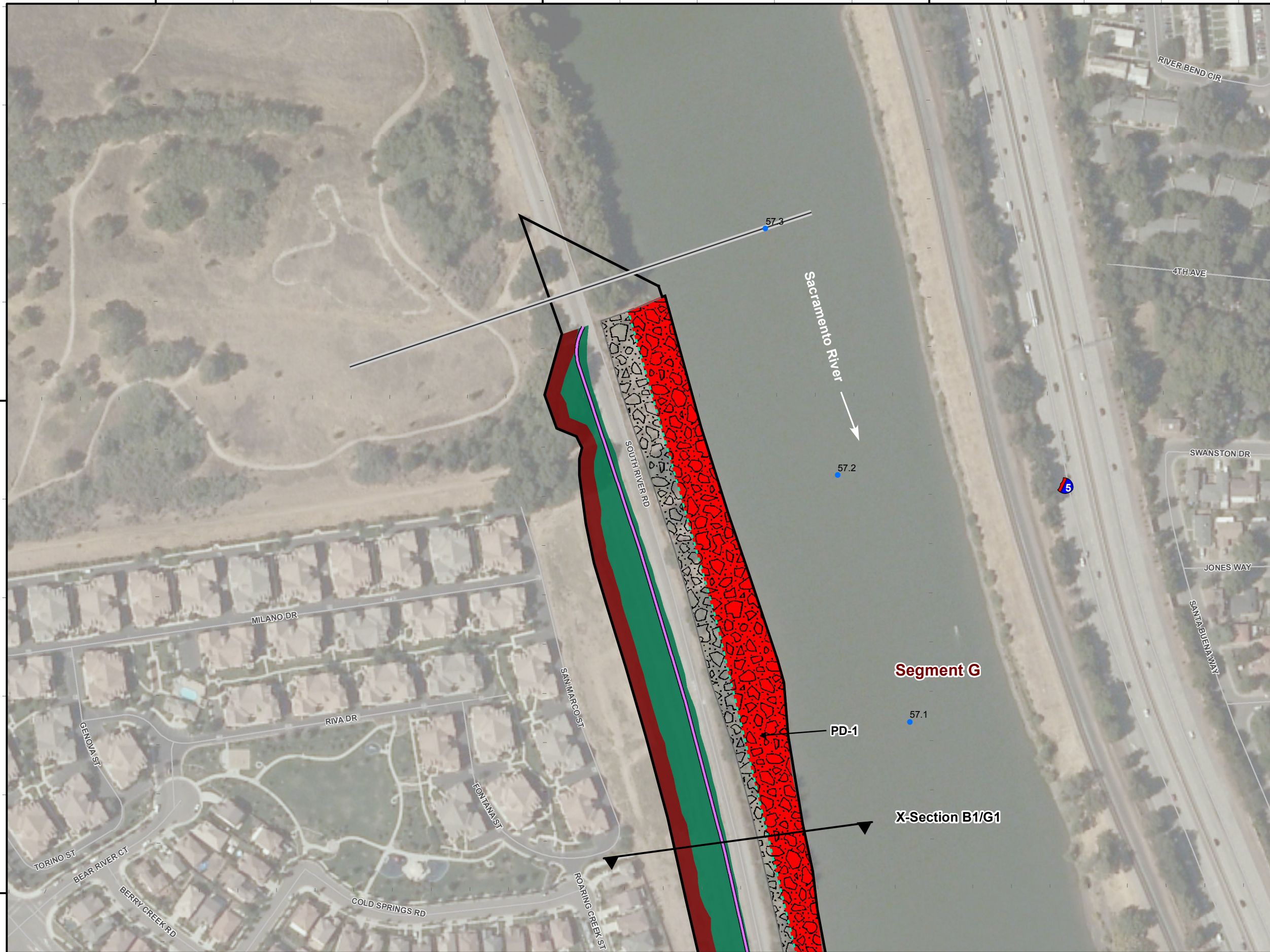

Figure 3
Project Plan View Showing Impacts
to Potential Waters of the
United States, Including Wetlands

Southport Sacramento River
 Early Implementation Project
 March 2013
 SPK-2012-00462
 Sheet 1 of 19

Legend

- Construction Area Boundary
- Permanent Fill (37.604 acres)
- Ordinary High Water Mark (OHWM)
- Segment Boundary
- Sacramento River Mile
- Pond
- Ditch
- Project Elements**
- Cutoff Wall
- Offset Area Grading
- Proposed Road
- O&M Corridor
- Seepage Berm
- Adjacent Levee
- Setback Levee
- Levee Slope Flattening
- Bank Stabilization
- Levee Breach Armoring
- Staging Area

W = Average Width at
 Ordinary High Water Mark

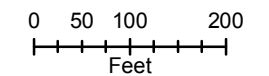

1 inch = 200 feet

Notes:
 Source: Project Elements, HDR, January 2013
 Base Map Source: ICF, 2012
 Imagery Source: NAIP 2010
 USGS Topo Quad: Sacramento West
 PLSS: Wetlands Land Grant

Prepared By: ICF, International 916.737.3000
 Drawn By: Edward Douglas, March 28, 2013
 Revised April 2, 2013

Path: K:\Projects_1\HDR\00071_11_SouthPort\mapdoc\Working\Impact_Mapbook_20130402.mxd; Author: ; Date: 4/2/2013

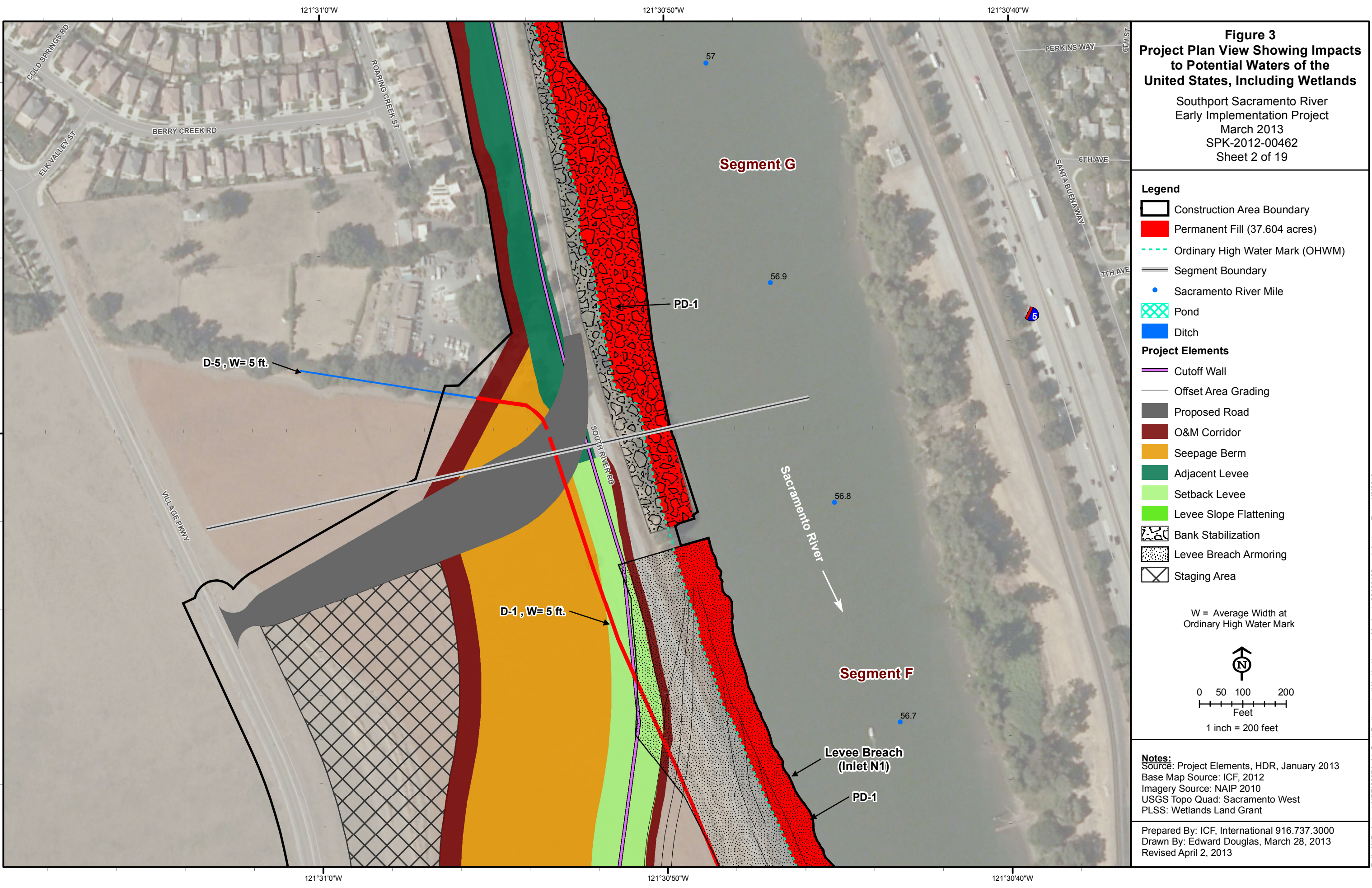

Figure 3
Project Plan View Showing Impacts to Potential Waters of the United States, Including Wetlands
 Southport Sacramento River
 Early Implementation Project
 March 2013
 SPK-2012-00462
 Sheet 2 of 19

Legend

- Construction Area Boundary
- Permanent Fill (37.604 acres)
- Ordinary High Water Mark (OHWM)
- Segment Boundary
- Sacramento River Mile
- Pond
- Ditch

Project Elements

- Cutoff Wall
- Offset Area Grading
- Proposed Road
- O&M Corridor
- Seepage Berm
- Adjacent Levee
- Setback Levee
- Levee Slope Flattening
- Bank Stabilization
- Levee Breach Armoring
- Staging Area

W = Average Width at Ordinary High Water Mark

0 50 100 200
 Feet
 1 inch = 200 feet

Notes:
 Source: Project Elements, HDR, January 2013
 Base Map Source: ICF, 2012
 Imagery Source: NAIP 2010
 USGS Topo Quad: Sacramento West
 PLSS: Wetlands Land Grant

Prepared By: ICF, International 916.737.3000
 Drawn By: Edward Douglas, March 28, 2013
 Revised April 2, 2013

Path: K:\Projects_1\HDR\00071_11_SouthPort\mapdoc\Working\Impact_Mapbook_20130402.mxd; Author: ; Date: 4/2/2013

Figure 3
Project Plan View Showing Impacts to Potential Waters of the United States, Including Wetlands

Southport Sacramento River
 Early Implementation Project
 March 2013
 SPK-2012-00462
 Sheet 3 of 19

- Legend**
- Construction Area Boundary
 - Permanent Fill (37.604 acres)
 - Ordinary High Water Mark (OHWM)
 - Segment Boundary
 - Sacramento River Mile
 - Pond
 - Ditch
- Project Elements**
- Cutoff Wall
 - Offset Area Grading
 - Proposed Road
 - O&M Corridor
 - Seepage Berm
 - Adjacent Levee
 - Setback Levee
 - Levee Slope Flattening
 - Bank Stabilization
 - Levee Breach Armoring
 - Staging Area

W = Average Width at Ordinary High Water Mark

0 50 100 200
 Feet

1 inch = 200 feet

Notes:
 Source: Project Elements, HDR, January 2013
 Base Map Source: ICF, 2012
 Imagery Source: NAIP 2010
 USGS Topo Quad: Sacramento West
 PLSS: Wetlands Land Grant

Prepared By: ICF, International 916.737.3000
 Drawn By: Edward Douglas, March 28, 2013
 Revised April 2, 2013

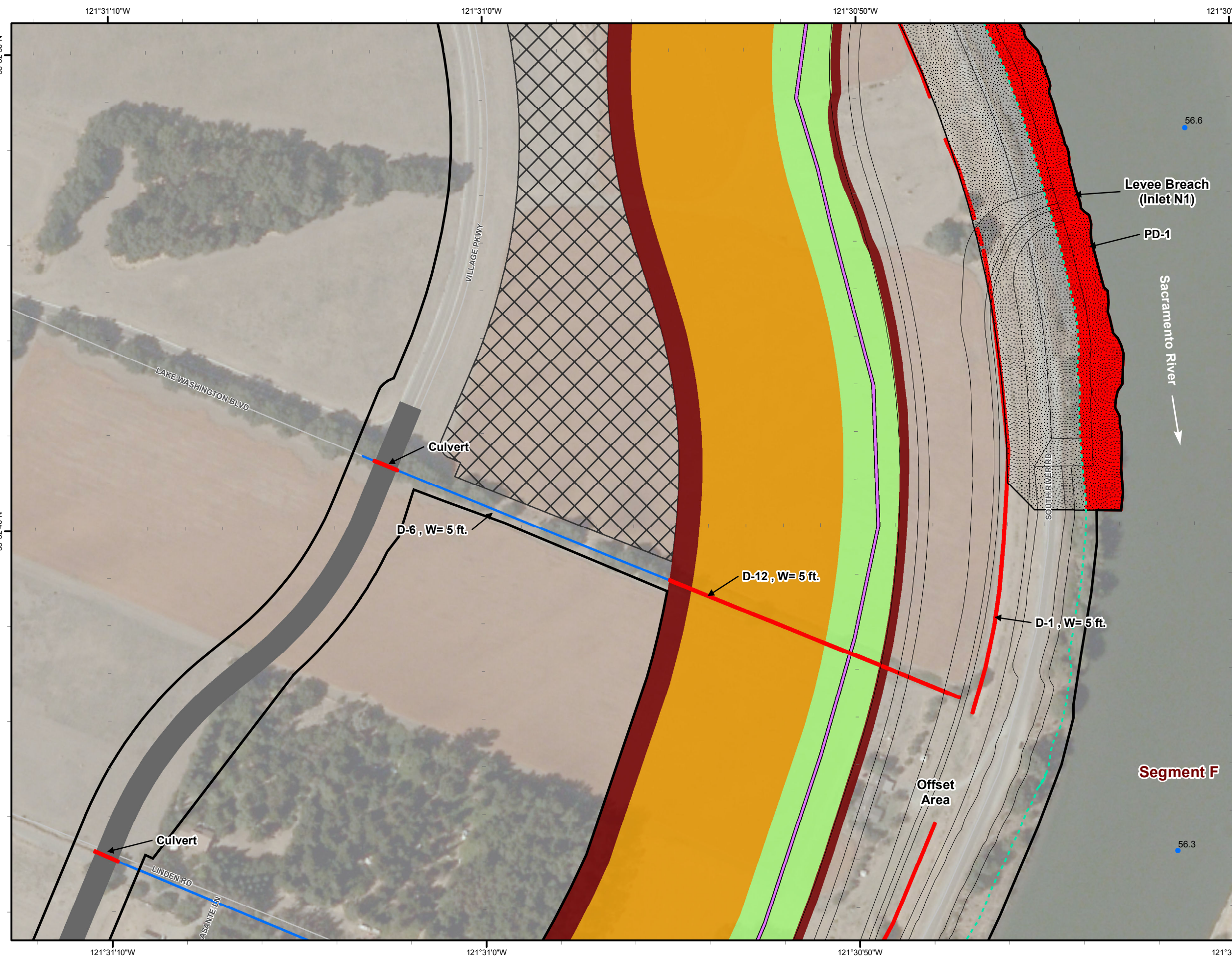

Path: K:\Projects_1\HDR\00071_11_SouthPortmapdoc\Working\Impact_Mapbook_20130402.mxd; Author: ; Date: 4/2/2013

Figure 3
Project Plan View Showing Impacts to Potential Waters of the United States, Including Wetlands
 Southport Sacramento River
 Early Implementation Project
 March 2013
 SPK-2012-00462
 Sheet 4 of 19

- Legend**
- Construction Area Boundary
 - Permanent Fill (37.604 acres)
 - Ordinary High Water Mark (OHWM)
 - Segment Boundary
 - Sacramento River Mile
 - Pond
 - Ditch
- Project Elements**
- Cutoff Wall
 - Offset Area Grading
 - Proposed Road
 - O&M Corridor
 - Seepage Berm
 - Adjacent Levee
 - Setback Levee
 - Levee Slope Flattening
 - Bank Stabilization
 - Levee Breach Armoring
 - Staging Area

W = Average Width at Ordinary High Water Mark

1 inch = 200 feet

Notes:
 Source: Project Elements, HDR, January 2013
 Base Map Source: ICF, 2012
 Imagery Source: NAIP 2010
 USGS Topo Quad: Sacramento West
 PLSS: Wetlands Land Grant

Prepared By: ICF, International 916.737.3000
 Drawn By: Edward Douglas, March 28, 2013
 Revised April 2, 2013

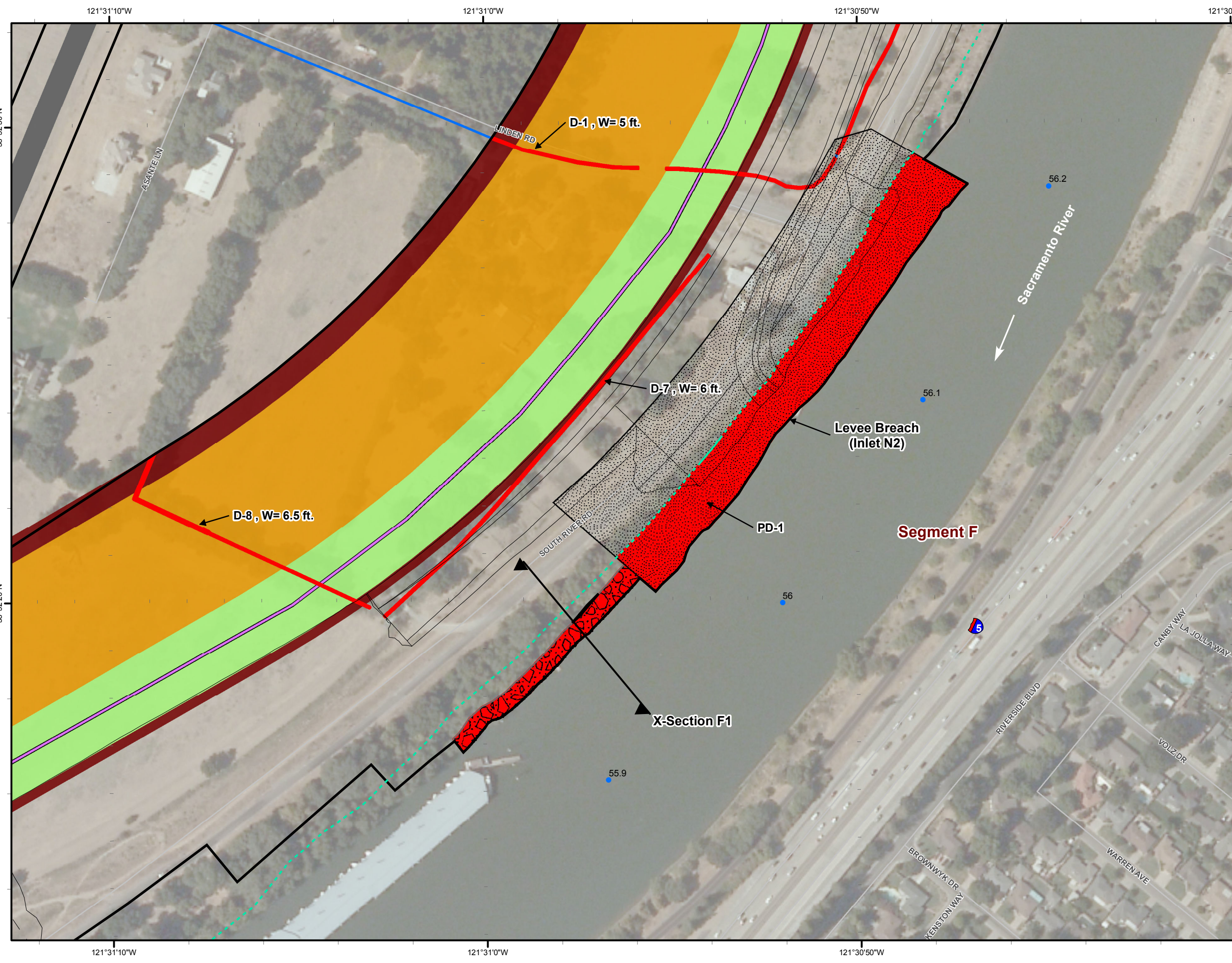

Path: K:\Projects_1\HDR\00071_11_SouthPort\mapdoc\Working\Impact_Mapbook_20130402.mxd; Author: ; Date: 4/2/2013

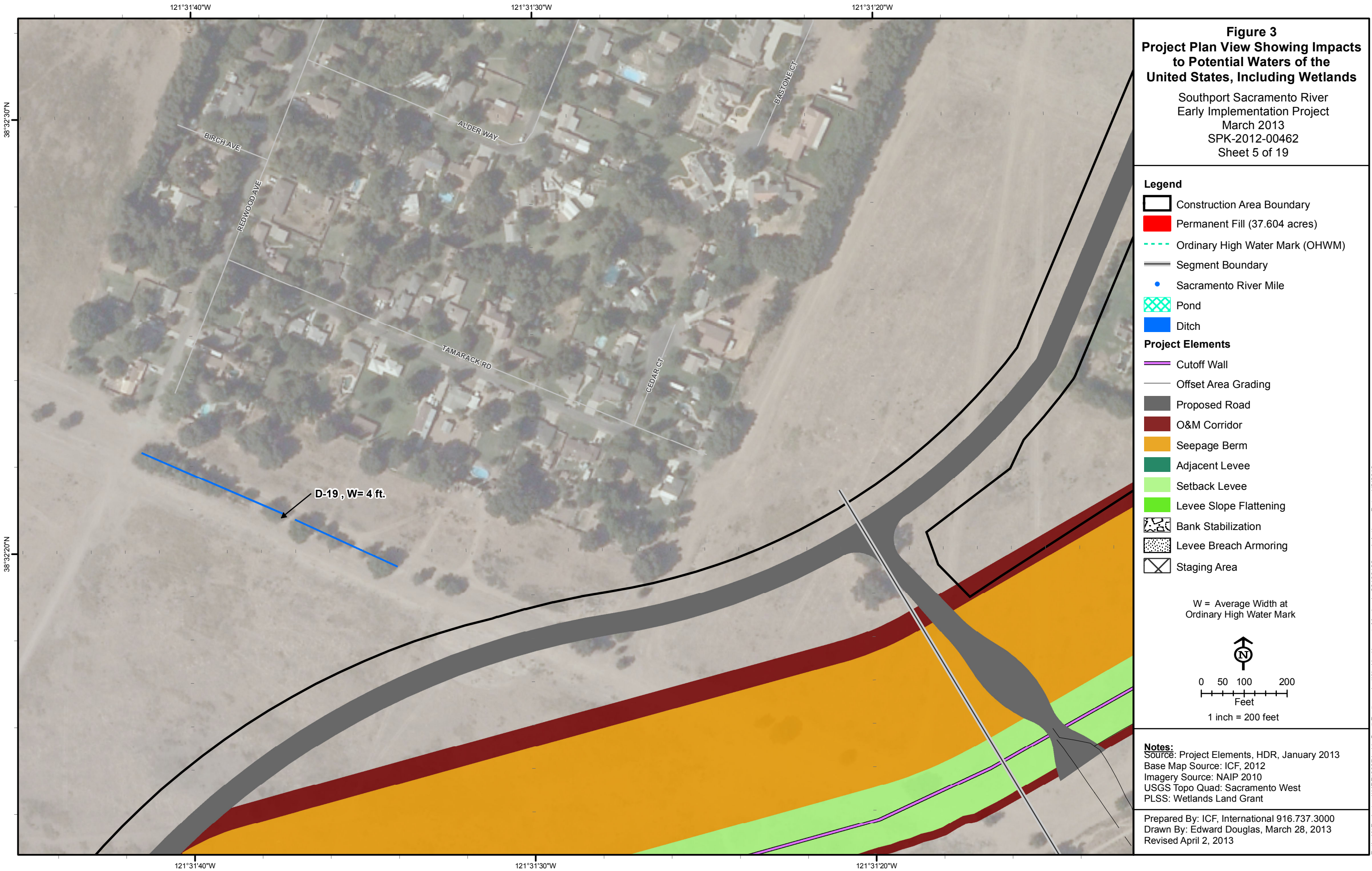

Figure 3
Project Plan View Showing Impacts to Potential Waters of the United States, Including Wetlands
 Southport Sacramento River
 Early Implementation Project
 March 2013
 SPK-2012-00462
 Sheet 5 of 19

- Legend**
- Construction Area Boundary
 - Permanent Fill (37.604 acres)
 - Ordinary High Water Mark (OHWM)
 - Segment Boundary
 - Sacramento River Mile
 - Pond
 - Ditch
- Project Elements**
- Cutoff Wall
 - Offset Area Grading
 - Proposed Road
 - O&M Corridor
 - Seepage Berm
 - Adjacent Levee
 - Setback Levee
 - Levee Slope Flattening
 - Bank Stabilization
 - Levee Breach Armoring
 - Staging Area

W = Average Width at Ordinary High Water Mark

↑
N

0 50 100 200
 Feet
 1 inch = 200 feet

Notes:
 Source: Project Elements, HDR, January 2013
 Base Map Source: ICF, 2012
 Imagery Source: NAIP 2010
 USGS Topo Quad: Sacramento West
 PLSS: Wetlands Land Grant

Prepared By: ICF, International 916.737.3000
 Drawn By: Edward Douglas, March 28, 2013
 Revised April 2, 2013

Path: K:\Projects_1\HDR\00071_11_SouthPort\mapdoc\Working\Impact_Mapbook_20130402.mxd; Author: ; Date: 4/2/2013

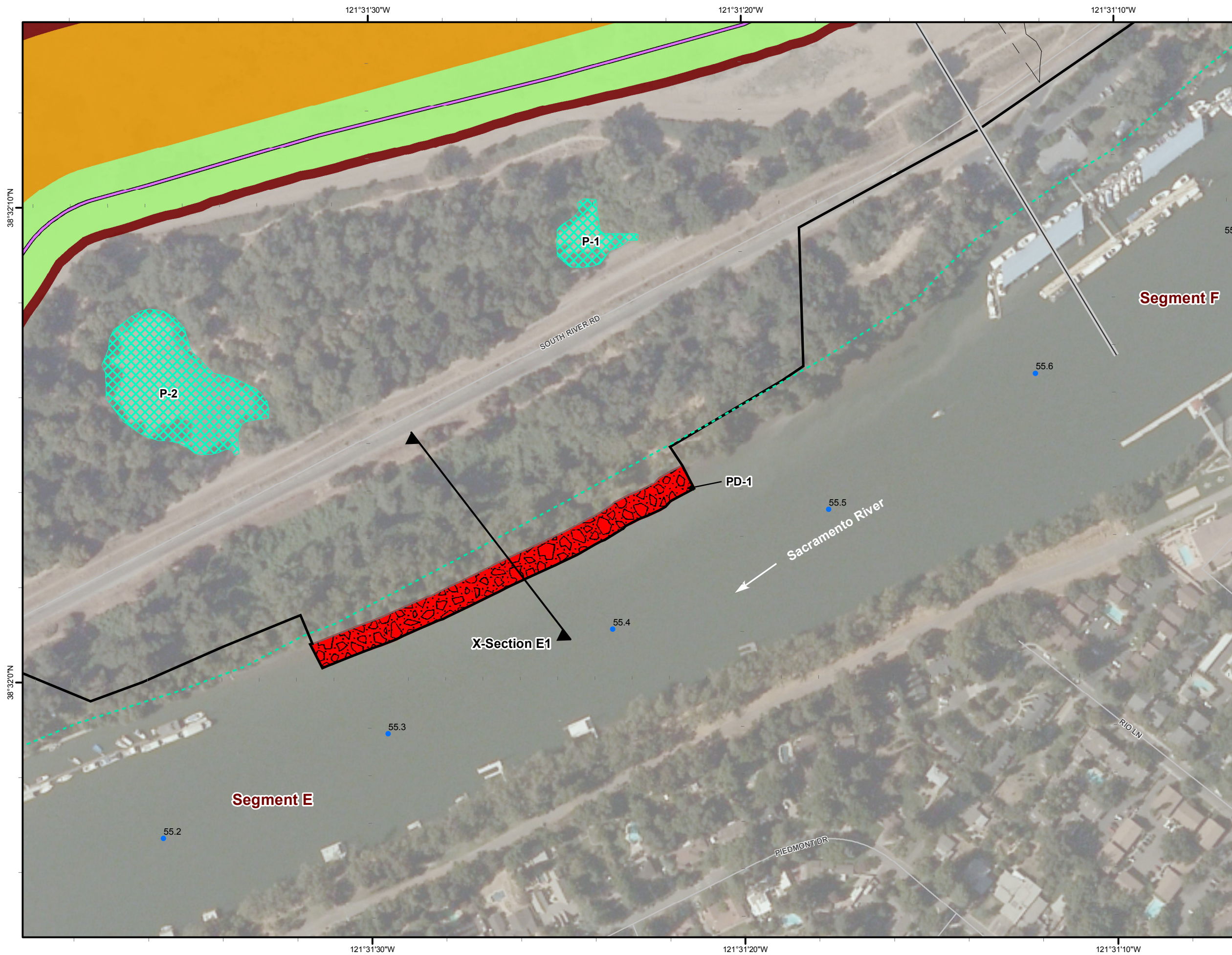

Figure 3
Project Plan View Showing Impacts to Potential Waters of the United States, Including Wetlands
 Southport Sacramento River
 Early Implementation Project
 March 2013
 SPK-2012-00462
 Sheet 6 of 19

- Legend**
- Construction Area Boundary
 - Permanent Fill (37.604 acres)
 - Ordinary High Water Mark (OHWM)
 - Segment Boundary
 - Sacramento River Mile
 - Pond
 - Ditch
- Project Elements**
- Cutoff Wall
 - Offset Area Grading
 - Proposed Road
 - O&M Corridor
 - Seepage Berm
 - Adjacent Levee
 - Setback Levee
 - Levee Slope Flattening
 - Bank Stabilization
 - Levee Breach Armoring
 - Staging Area

W = Average Width at Ordinary High Water Mark

1 inch = 200 feet

Notes:
 Source: Project Elements, HDR, January 2013
 Base Map Source: ICF, 2012
 Imagery Source: NAIP 2010
 USGS Topo Quad: Sacramento West
 PLSS: Wetlands Land Grant

Prepared By: ICF, International 916.737.3000
 Drawn By: Edward Douglas, March 28, 2013
 Revised April 2, 2013

Path: K:\Projects_1\HDR\00071_11_SouthPort\mapdoc\Working\Impact_Mapbook_20130402.mxd; Author: ; Date: 4/2/2013

121°32'10"W

121°32'0"W

121°31'50"W

121°31'40"W

38°32'10"N

38°32'0"N

121°32'10"W

121°32'0"W



















121°31'50"W

121°31'40"W

Figure 3
Project Plan View Showing Impacts to Potential Waters of the United States, Including Wetlands

Southport Sacramento River
 Early Implementation Project
 March 2013
 SPK-2012-00462
 Sheet 7 of 19

Legend

-  Construction Area Boundary
-  Permanent Fill (37.604 acres)
-  Ordinary High Water Mark (OHWM)
-  Segment Boundary
-  Sacramento River Mile
-  Pond
-  Ditch
- Project Elements**
-  Cutoff Wall
-  Offset Area Grading
-  Proposed Road
-  O&M Corridor
-  Seepage Berm
-  Adjacent Levee
-  Setback Levee
-  Levee Slope Flattening
-  Bank Stabilization
-  Levee Breach Armoring
-  Staging Area

W = Average Width at Ordinary High Water Mark

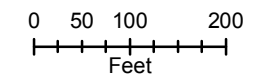

1 inch = 200 feet

Notes:

Source: Project Elements, HDR, January 2013
 Base Map Source: ICF, 2012
 Imagery Source: NAIP 2010
 USGS Topo Quad: Sacramento West
 PLSS: Wetlands Land Grant

Prepared By: ICF, International 916.737.3000
 Drawn By: Edward Douglas, March 28, 2013
 Revised April 2, 2013

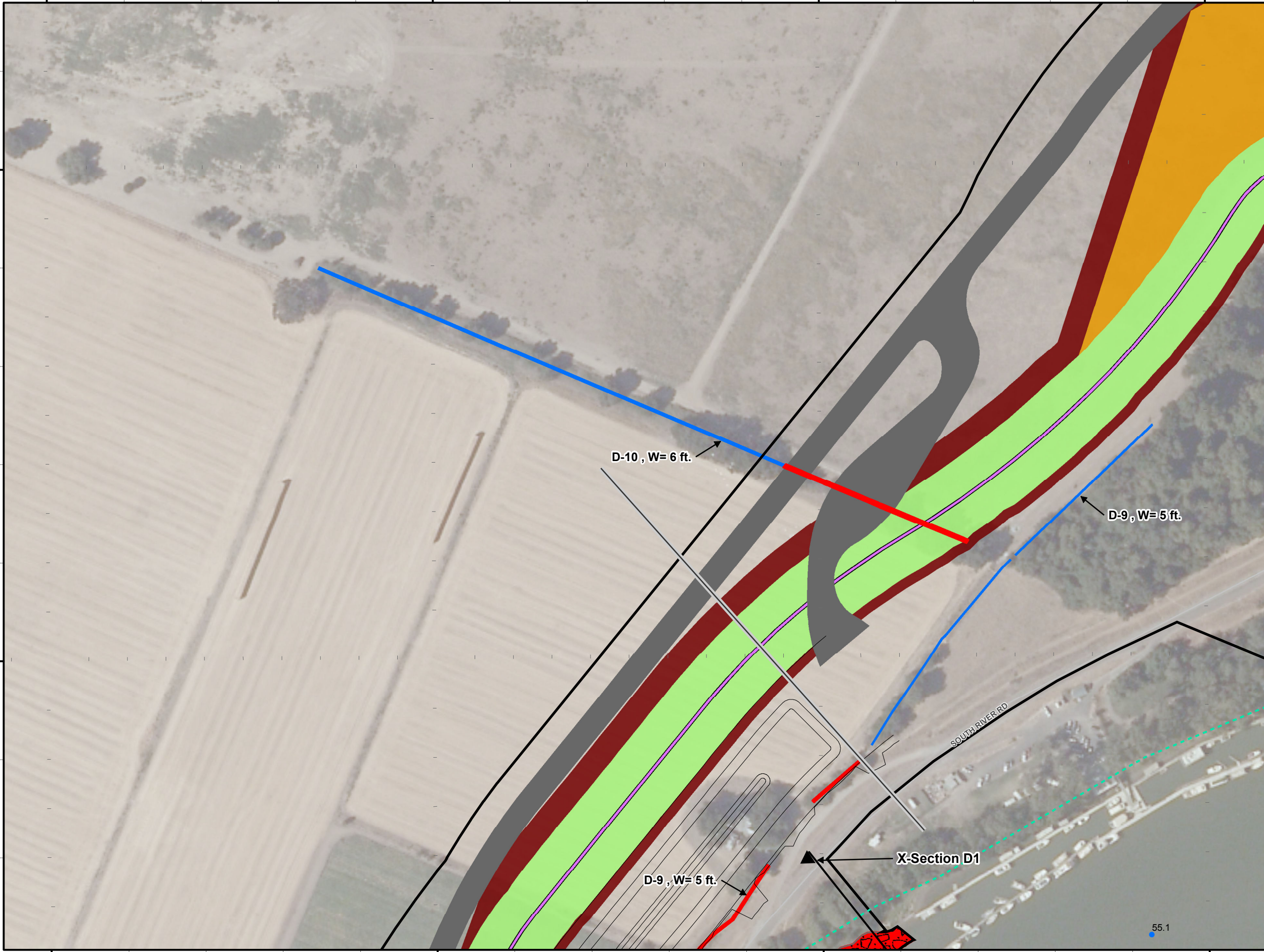

Path: K:\Projects_1\HDR\00071_11_SouthPort\mapdoc\Working\Impact_Mapbook_20130402.mxd; Author: ; Date: 4/2/2013

121°32'10"W

121°32'0"W

121°31'50"W

121°32'10"W

121°32'0"W



















121°31'50"W

38°31'50"N

38°31'40"N

Figure 3
Project Plan View Showing Impacts to Potential Waters of the United States, Including Wetlands
 Southport Sacramento River
 Early Implementation Project
 March 2013
 SPK-2012-00462
 Sheet 8 of 19

Legend

-  Construction Area Boundary
-  Permanent Fill (37.604 acres)
-  Ordinary High Water Mark (OHWM)
-  Segment Boundary
-  Sacramento River Mile
-  Pond
-  Ditch
- Project Elements**
-  Cutoff Wall
-  Offset Area Grading
-  Proposed Road
-  O&M Corridor
-  Seepage Berm
-  Adjacent Levee
-  Setback Levee
-  Levee Slope Flattening
-  Bank Stabilization
-  Levee Breach Armoring
-  Staging Area

W = Average Width at Ordinary High Water Mark

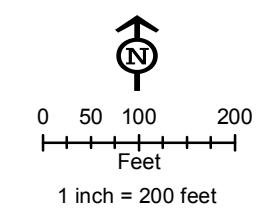

Notes:
 Source: Project Elements, HDR, January 2013
 Base Map Source: ICF, 2012
 Imagery Source: NAIP 2010
 USGS Topo Quad: Sacramento West
 PLSS: Wetlands Land Grant

Prepared By: ICF, International 916.737.3000
 Drawn By: Edward Douglas, March 28, 2013
 Revised April 2, 2013

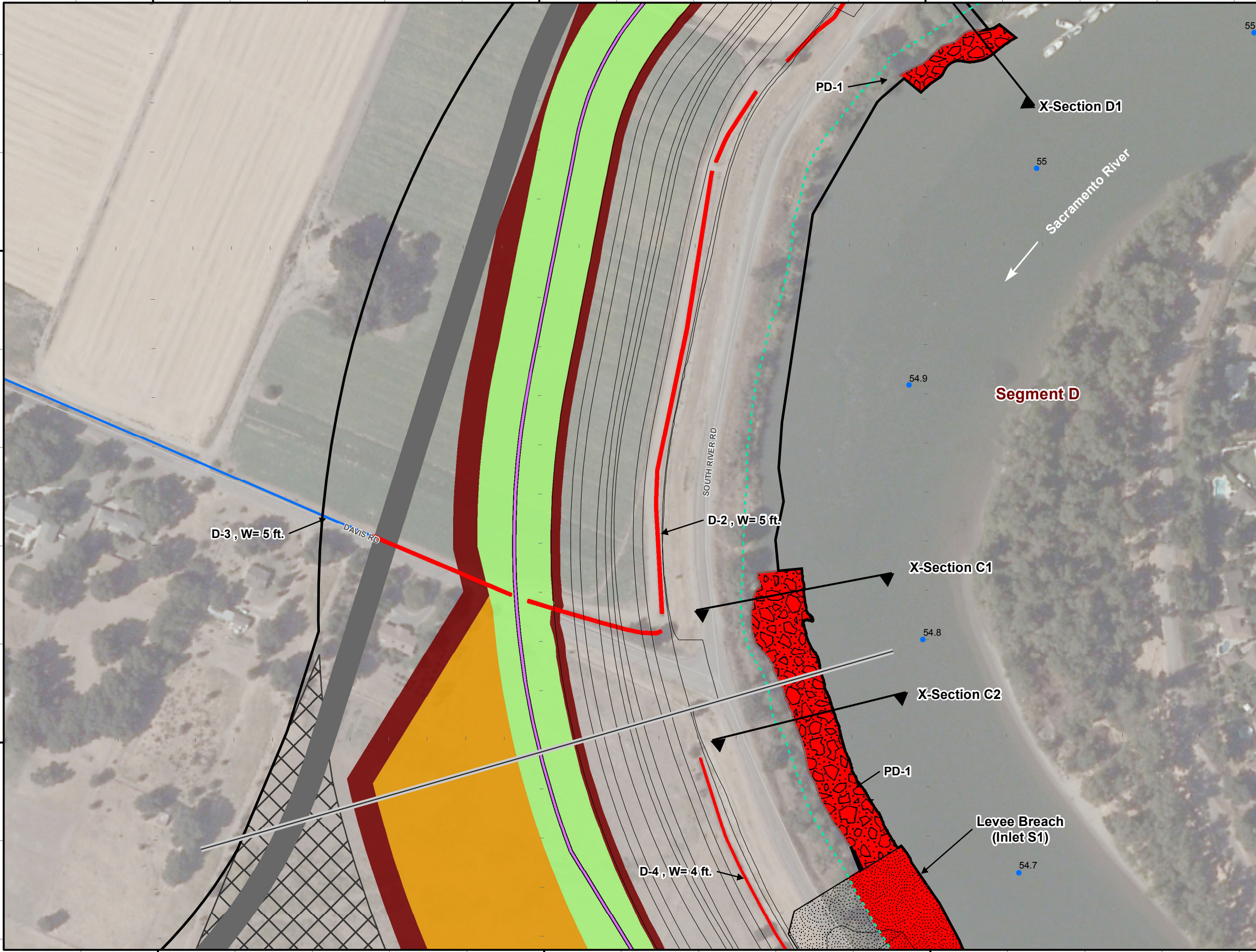



















Path: K:\Projects_1\HDR\00071_11_SouthPort\mapdoc\Working\Impact_Mapbook_20130402.mxd; Author: ; Date: 4/2/2013



Figure 3
Project Plan View Showing Impacts to Potential Waters of the United States, Including Wetlands

Southport Sacramento River
 Early Implementation Project
 March 2013
 SPK-2012-00462
 Sheet 9 of 19

Legend

-  Construction Area Boundary
-  Permanent Fill (37.604 acres)
-  Ordinary High Water Mark (OHWM)
-  Segment Boundary
-  Sacramento River Mile
-  Pond
-  Ditch
- Project Elements**
-  Cutoff Wall
-  Offset Area Grading
-  Proposed Road
-  O&M Corridor
-  Seepage Berm
-  Adjacent Levee
-  Setback Levee
-  Levee Slope Flattening
-  Bank Stabilization
-  Levee Breach Armoring
-  Staging Area

W = Average Width at Ordinary High Water Mark

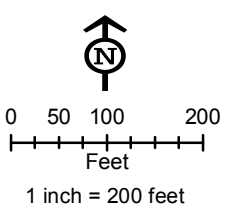

Notes:
 Source: Project Elements, HDR, January 2013
 Base Map Source: ICF, 2012
 Imagery Source: NAIP 2010
 USGS Topo Quad: Sacramento West
 PLSS: Wetlands Land Grant

Prepared By: ICF, International 916.737.3000
 Drawn By: Edward Douglas, March 28, 2013
 Revised April 2, 2013

Path: K:\Projects_1\HDR\00071_11_SouthPort\mapdoc\Working\Impact_Mapbook_20130402.mxd; Author: ; Date: 4/2/2013

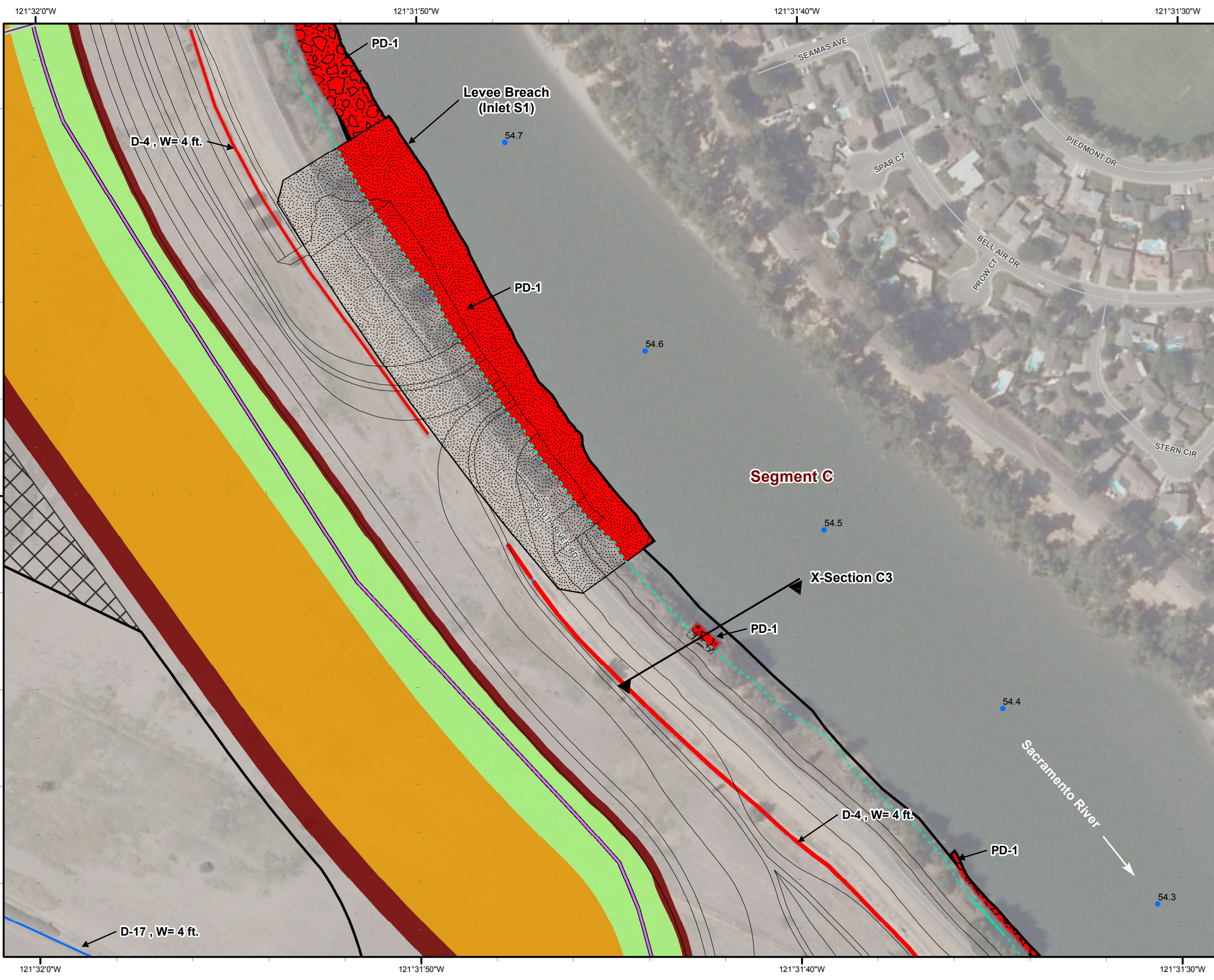

Figure 3
Project Plan View Showing Impacts to Potential Waters of the United States, Including Wetlands
 Southport Sacramento River
 Early Implementation Project
 March 2013
 SPK-2012-00462
 Sheet 10 of 19

- Legend**
- Construction Area Boundary
 - Permanent Fill (37.604 acres)
 - Ordinary High Water Mark (OHWM)
 - Segment Boundary
 - Sacramento River Mile
 - Pond
 - Ditch
- Project Elements**
- Cutoff Wall
 - Offset Area Grading
 - Proposed Road
 - O&M Corridor
 - Seepage Berm
 - Adjacent Levee
 - Setback Levee
 - Levee Slope Flattening
 - Bank Stabilization
 - Levee Breach Armoring
 - Staging Area

W = Average Width at Ordinary High Water Mark

0 50 100 200
 Feet
 1 inch = 200 feet

Notes:
 Source: Project Elements, HDR, January 2013
 Base Map Source: ICF, 2012
 Imagery Source: NAIP 2010
 USGS Topo Quad: Sacramento West
 PLSS: Wetlands Land Grant

Prepared By: ICF, International 916.737.3000
 Drawn By: Edward Douglas, March 28, 2013
 Revised April 2, 2013

Path: K:\Projects_1\HDR\00071_11_SouthPort\mapdoc\Working\Impact_Mapbook_20130402.mxd; Author: ; Date: 4/2/2013

121°32'30"W

121°32'20"W

121°32'10"W

121°32'0"W

38°31'30"N

38°31'20"N

121°32'30"W

121°32'20"W



















121°32'10"W

121°32'0"W

Figure 3
Project Plan View Showing Impacts to Potential Waters of the United States, Including Wetlands

Southport Sacramento River
 Early Implementation Project
 March 2013
 SPK-2012-00462
 Sheet 11 of 19

Legend

-  Construction Area Boundary
-  Permanent Fill (37.604 acres)
-  Ordinary High Water Mark (OHWM)
-  Segment Boundary
-  Sacramento River Mile
-  Pond
-  Ditch
- Project Elements**
-  Cutoff Wall
-  Offset Area Grading
-  Proposed Road
-  O&M Corridor
-  Seepage Berm
-  Adjacent Levee
-  Setback Levee
-  Levee Slope Flattening
-  Bank Stabilization
-  Levee Breach Armoring
-  Staging Area

W = Average Width at Ordinary High Water Mark



0 50 100 200
 Feet

1 inch = 200 feet

Notes:

Source: Project Elements, HDR, January 2013
 Base Map Source: ICF, 2012
 Imagery Source: NAIP 2010
 USGS Topo Quad: Sacramento West
 PLSS: Wetlands Land Grant

Prepared By: ICF, International 916.737.3000
 Drawn By: Edward Douglas, March 28, 2013
 Revised April 2, 2013

Culvert

D-17, W= 4 ft.

Path: K:\Projects_1\HDR\00071_11_SouthPort\mapdoc\Working\Impact_Mapbook_20130402.mxd; Author: ; Date: 4/2/2013

Figure 3
Project Plan View Showing Impacts to Potential Waters of the United States, Including Wetlands
 Southport Sacramento River
 Early Implementation Project
 March 2013
 SPK-2012-00462
 Sheet 12 of 19

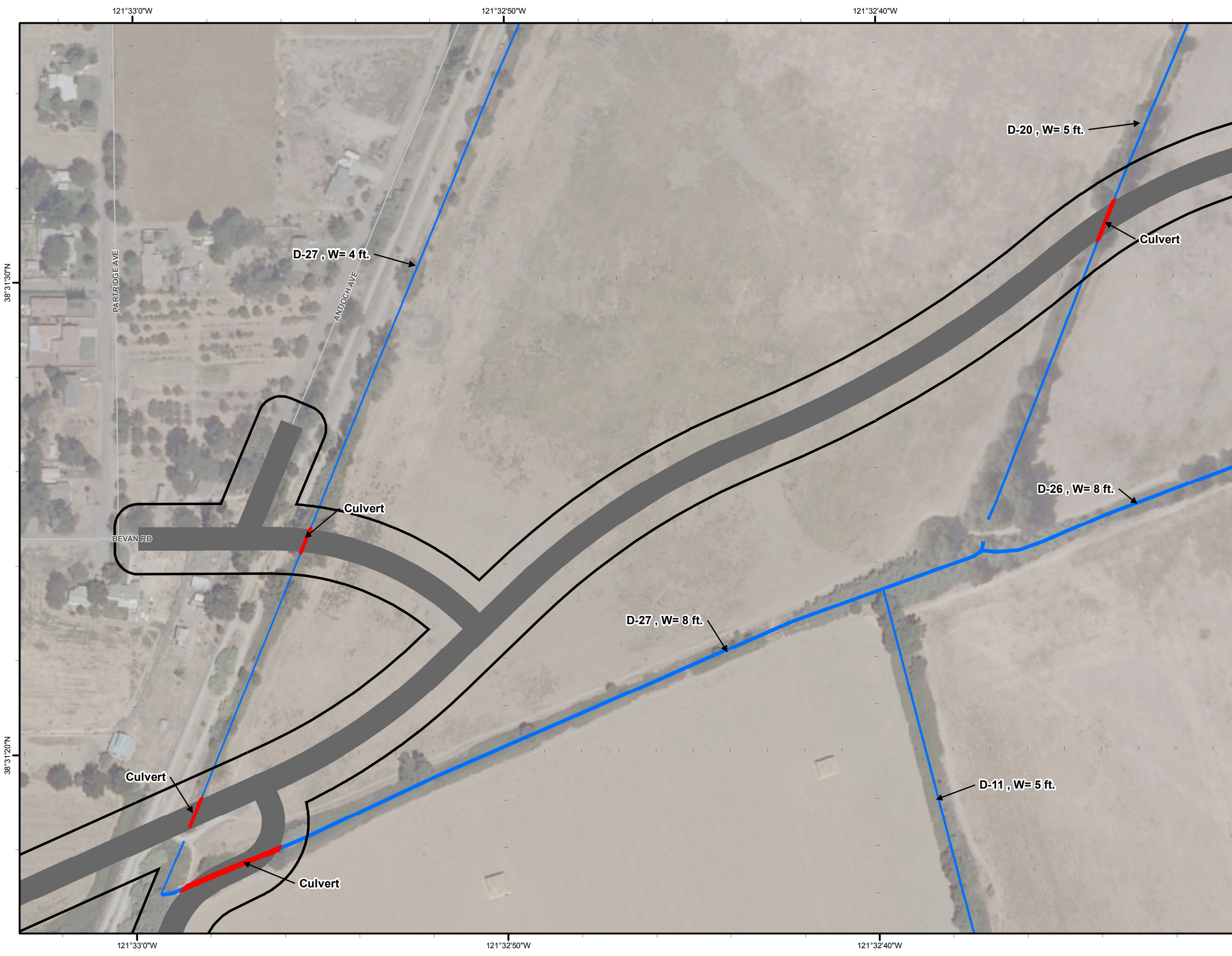

- Legend**
- Construction Area Boundary
 - Permanent Fill (37.604 acres)
 - Ordinary High Water Mark (OHWM)
 - Segment Boundary
 - Sacramento River Mile
 - Pond
 - Ditch
- Project Elements**
- Cutoff Wall
 - Offset Area Grading
 - Proposed Road
 - O&M Corridor
 - Seepage Berm
 - Adjacent Levee
 - Setback Levee
 - Levee Slope Flattening
 - Bank Stabilization
 - Levee Breach Armoring
 - Staging Area

W = Average Width at Ordinary High Water Mark

↑
N

0 50 100 200
 Feet
 1 inch = 200 feet

Notes:
 Source: Project Elements, HDR, January 2013
 Base Map Source: ICF, 2012
 Imagery Source: NAIP 2010
 USGS Topo Quad: Sacramento West
 PLSS: Wetlands Land Grant

Prepared By: ICF, International 916.737.3000
 Drawn By: Edward Douglas, March 28, 2013
 Revised April 2, 2013

Path: K:\Projects_1\HDR\00071_11_SouthPort\mapdoc\Working\Impact_Mapbook_20130402.mxd; Author: ; Date: 4/2/2013

121°33'30"W

121°33'20"W

121°33'10"W

38°31'10"N

121°33'30"W



















121°33'20"W

121°33'10"W

Figure 3
Project Plan View Showing Impacts to Potential Waters of the United States, Including Wetlands

Southport Sacramento River
 Early Implementation Project
 March 2013
 SPK-2012-00462
 Sheet 13 of 19

Legend

-  Construction Area Boundary
-  Permanent Fill (37.604 acres)
-  Ordinary High Water Mark (OHWM)
-  Segment Boundary
-  Sacramento River Mile
-  Pond
-  Ditch
- Project Elements**
-  Cutoff Wall
-  Offset Area Grading
-  Proposed Road
-  O&M Corridor
-  Seepage Berm
-  Adjacent Levee
-  Setback Levee
-  Levee Slope Flattening
-  Bank Stabilization
-  Levee Breach Armoring
-  Staging Area

W = Average Width at Ordinary High Water Mark



0 50 100 200
 Feet

1 inch = 200 feet

Notes:
 Source: Project Elements, HDR, January 2013
 Base Map Source: ICF, 2012
 Imagery Source: NAIP 2010
 USGS Topo Quad: Sacramento West
 PLSS: Wetlands Land Grant

Prepared By: ICF, International 916.737.3000
 Drawn By: Edward Douglas, March 28, 2013
 Revised April 2, 2013

Path: K:\Projects_1\HDR\00071_11_SouthPort\mapdoc\Working\Impact_Mapbook_20130402.mxd; Author: ; Date: 4/2/2013

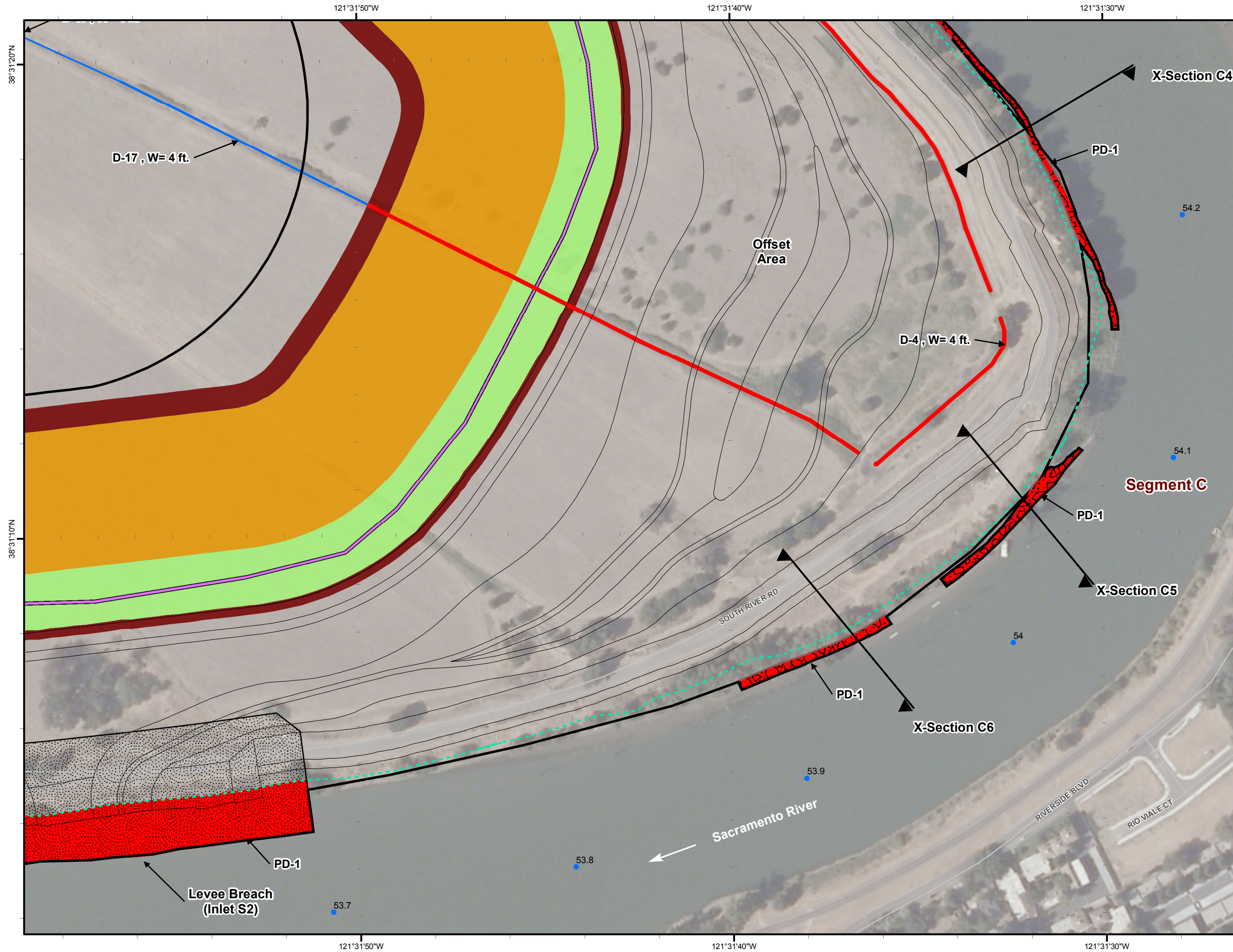

Figure 3
Project Plan View Showing Impacts to Potential Waters of the United States, Including Wetlands
 Southport Sacramento River
 Early Implementation Project
 March 2013
 SPK-2012-00462
 Sheet 14 of 19

Legend

- Construction Area Boundary
- Permanent Fill (37.604 acres)
- Ordinary High Water Mark (OHWM)
- Segment Boundary
- Sacramento River Mile
- Pond
- Ditch

Project Elements

- Cutoff Wall
- Offset Area Grading
- Proposed Road
- O&M Corridor
- Seepage Berm
- Adjacent Levee
- Setback Levee
- Levee Slope Flattening
- Bank Stabilization
- Levee Breach Armoring
- Staging Area

W = Average Width at Ordinary High Water Mark

0 50 100 200
 Feet
 1 inch = 200 feet

Notes:
 Source: Project Elements, HDR, January 2013
 Base Map Source: ICF, 2012
 Imagery Source: NAIP 2010
 USGS Topo Quad: Sacramento West
 PLSS: Wetlands Land Grant

Prepared By: ICF, International 916.737.3000
 Drawn By: Edward Douglas, March 28, 2013
 Revised April 2, 2013



















Path: K:\Projects_1\HDR\00071_11_SouthPortMapdoc\Working\Impact_Mapbook_20130402.mxd; Author: ; Date: 4/2/2013

121°32'30"W 121°32'20"W 121°32'10"W 121°32'0"W

Figure 3
Project Plan View Showing Impacts to Potential Waters of the United States, Including Wetlands

Southport Sacramento River
 Early Implementation Project
 March 2013
 SPK-2012-00462
 Sheet 15 of 19

Legend

-  Construction Area Boundary
-  Permanent Fill (37.604 acres)
-  Ordinary High Water Mark (OHWM)
-  Segment Boundary
-  Sacramento River Mile
-  Pond
-  Ditch
- Project Elements**
-  Cutoff Wall
-  Offset Area Grading
-  Proposed Road
-  O&M Corridor
-  Seepage Berm
-  Adjacent Levee
-  Setback Levee
-  Levee Slope Flattening
-  Bank Stabilization
-  Levee Breach Armoring
-  Staging Area

W = Average Width at Ordinary High Water Mark

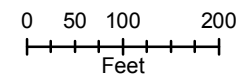

1 inch = 200 feet

Notes:

Source: Project Elements, HDR, January 2013
 Base Map Source: ICF, 2012
 Imagery Source: NAIP 2010
 USGS Topo Quad: Sacramento West
 PLSS: Wetlands Land Grant

Prepared By: ICF, International 916.737.3000
 Drawn By: Edward Douglas, March 28, 2013
 Revised April 2, 2013

38°31'10"N

38°31'0"N

121°32'30"W 121°32'20"W 121°32'10"W 121°32'0"W

Segment B

Segment C

Sacramento River

SOUTH RIVER RD

D-21, W=2 ft.

Levee Breach (Inlet S2)

PD-1

53.3

53.4

53.5

53.2

53.1

Path: K:\Projects_1\HDR\00071_11_SouthPort\mapdoc\Working\Impact_Mapbook_20130402.mxd; Author: ; Date: 4/2/2013

Figure 3
Project Plan View Showing Impacts to Potential Waters of the United States, Including Wetlands
 Southport Sacramento River
 Early Implementation Project
 March 2013
 SPK-2012-00462
 Sheet 16 of 19



Legend

- Construction Area Boundary
- Permanent Fill (37.604 acres)
- Ordinary High Water Mark (OHWM)
- Segment Boundary
- Sacramento River Mile
- Pond
- Ditch

Project Elements

- Cutoff Wall
- Offset Area Grading
- Proposed Road
- O&M Corridor
- Seepage Berm
- Adjacent Levee
- Setback Levee
- Levee Slope Flattening
- Bank Stabilization
- Levee Breach Armoring
- Staging Area

W = Average Width at Ordinary High Water Mark

0 50 100 200
 Feet
 1 inch = 200 feet

Notes:
 Source: Project Elements, HDR, January 2013
 Base Map Source: ICF, 2012
 Imagery Source: NAIP 2010
 USGS Topo Quad: Sacramento West
 PLSS: Wetlands Land Grant

Prepared By: ICF, International 916.737.3000
 Drawn By: Edward Douglas, March 28, 2013
 Revised April 2, 2013

Path: K:\Projects_1\HDR\00071_11_SouthPortMapdoc\Working\Impact_Mapbook_20130402.mxd; Author: ; Date: 4/2/2013

121°33'20"W 121°33'10"W 121°33'0"W 121°32'50"W

38°31'0"N

38°30'50"N

121°33'20"W 121°33'10"W 121°33'0"W 121°32'50"W

Figure 3
Project Plan View Showing Impacts to Potential Waters of the United States, Including Wetlands
 Southport Sacramento River
 Early Implementation Project
 March 2013
 SPK-2012-00462
 Sheet 17 of 19

Legend

- Construction Area Boundary
- Permanent Fill (37.604 acres)
- Ordinary High Water Mark (OHWM)
- Segment Boundary
- Sacramento River Mile
- Pond
- Ditch

Project Elements

- Cutoff Wall
- Offset Area Grading
- Proposed Road
- O&M Corridor
- Seepage Berm
- Adjacent Levee
- Setback Levee
- Levee Slope Flattening
- Bank Stabilization
- Levee Breach Armoring
- Staging Area

W = Average Width at Ordinary High Water Mark

0 50 100 200
 Feet
 1 inch = 200 feet

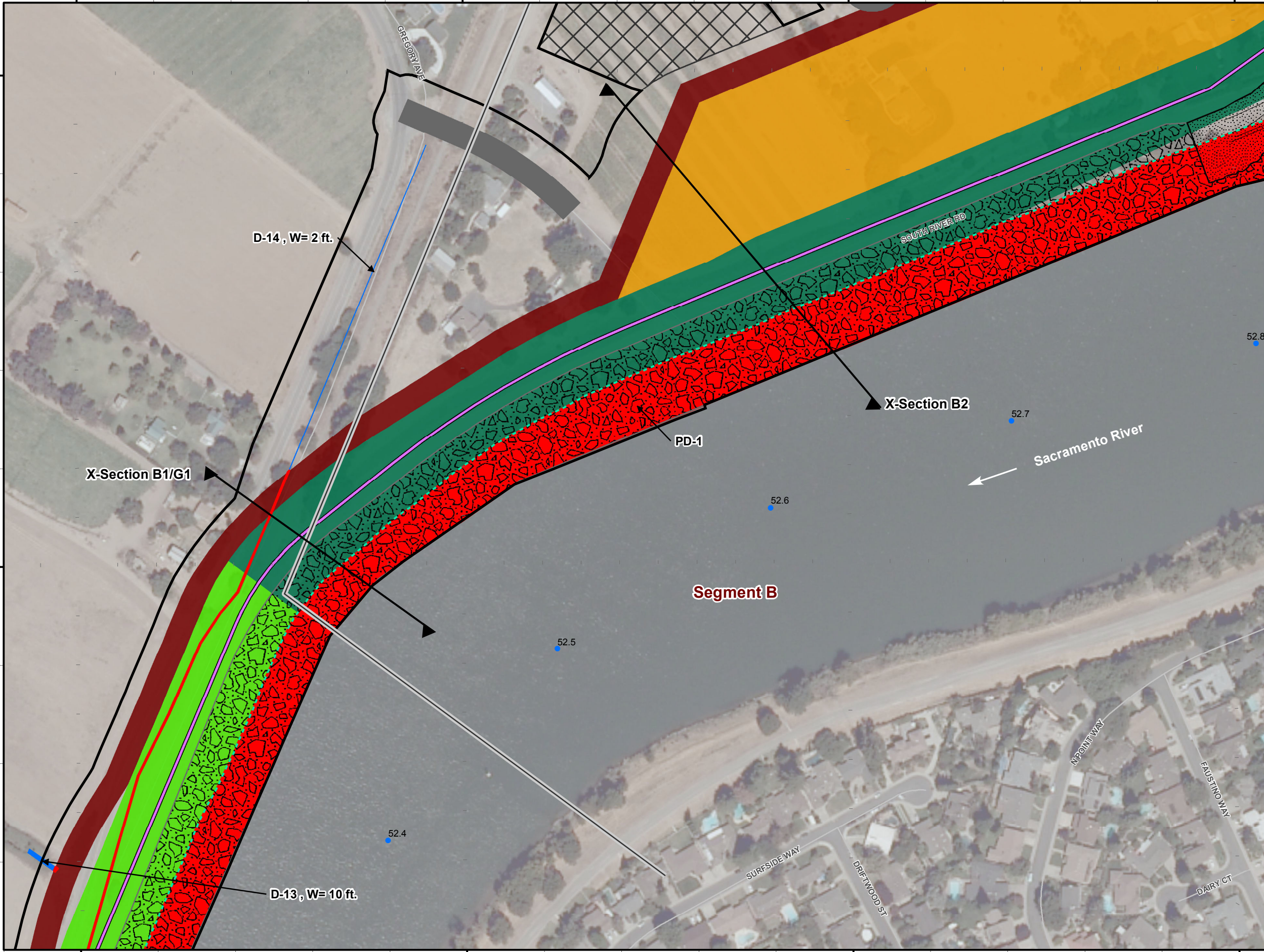

Notes:
 Source: Project Elements, HDR, January 2013
 Base Map Source: ICF, 2012
 Imagery Source: NAIP 2010
 USGS Topo Quad: Sacramento West
 PLSS: Wetlands Land Grant

Prepared By: ICF, International 916.737.3000
 Drawn By: Edward Douglas, March 28, 2013
 Revised April 2, 2013

Path: K:\Projects_1\HDR\00071_11_SouthPort\mapdoc\Working\Impact_Mapbook_20130402.mxd; Author: ; Date: 4/2/2013

121°33'30"W

121°33'20"W

121°33'10"W

38°30'40"N

38°30'30"N

121°33'30"W



















121°33'20"W

121°33'10"W

Figure 3
Project Plan View Showing Impacts
to Potential Waters of the
United States, Including Wetlands

Southport Sacramento River
 Early Implementation Project
 March 2013
 SPK-2012-00462
 Sheet 18 of 19

Legend

-  Construction Area Boundary
-  Permanent Fill (37.604 acres)
-  Ordinary High Water Mark (OHWM)
-  Segment Boundary
-  Sacramento River Mile
-  Pond
-  Ditch
- Project Elements**
-  Cutoff Wall
-  Offset Area Grading
-  Proposed Road
-  O&M Corridor
-  Seepage Berm
-  Adjacent Levee
-  Setback Levee
-  Levee Slope Flattening
-  Bank Stabilization
-  Levee Breach Armoring
-  Staging Area

W = Average Width at
 Ordinary High Water Mark



0 50 100 200
 Feet

1 inch = 200 feet

Notes:
 Source: Project Elements, HDR, January 2013
 Base Map Source: ICF, 2012
 Imagery Source: NAIP 2010
 USGS Topo Quad: Sacramento West
 PLSS: Wetlands Land Grant

Prepared By: ICF, International 916.737.3000
 Drawn By: Edward Douglas, March 28, 2013
 Revised April 2, 2013

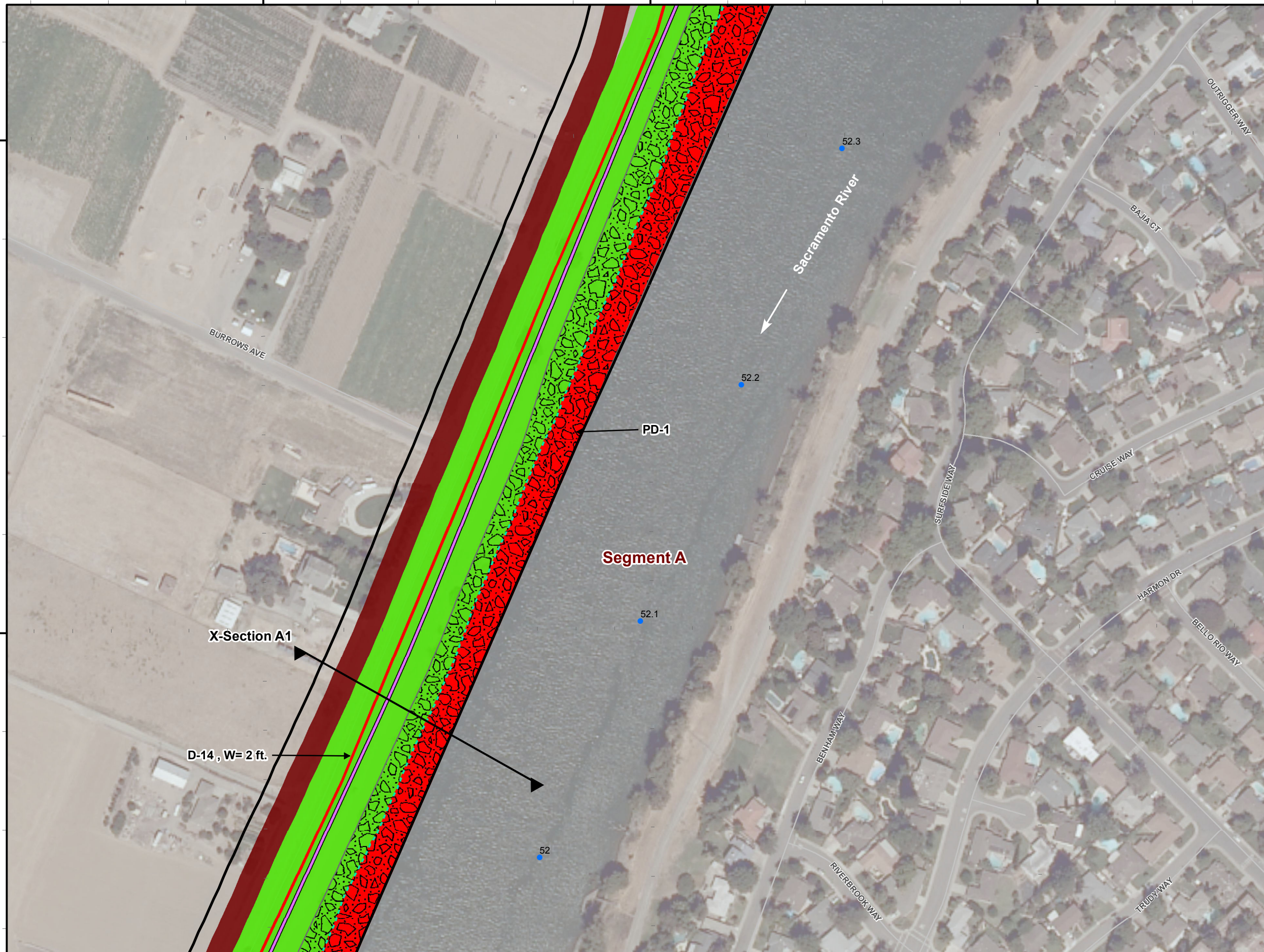

121°33'40"W

121°33'30"W

121°33'20"W

38°30'20"N

38°30'10"N

121°33'40"W



















121°33'30"W

121°33'20"W

Figure 3
Project Plan View Showing Impacts
to Potential Waters of the
United States, Including Wetlands

Southport Sacramento River
 Early Implementation Project
 March 2013
 SPK-2012-00462
 Sheet 19 of 19

Legend

-  Construction Area Boundary
-  Permanent Fill (37.604 acres)
-  Ordinary High Water Mark (OHWM)
-  Segment Boundary
-  Sacramento River Mile
-  Pond
-  Ditch
- Project Elements**
-  Cutoff Wall
-  Offset Area Grading
-  Proposed Road
-  O&M Corridor
-  Seepage Berm
-  Adjacent Levee
-  Setback Levee
-  Levee Slope Flattening
-  Bank Stabilization
-  Levee Breach Armoring
-  Staging Area

W = Average Width at
 Ordinary High Water Mark

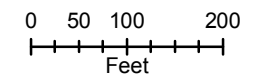

1 inch = 200 feet

Notes:
 Source: Project Elements, HDR, January 2013
 Base Map Source: ICF, 2012
 Imagery Source: NAIP 2010
 USGS Topo Quad: Sacramento West
 PLSS: Wetlands Land Grant

Prepared By: ICF, International 916.737.3000
 Drawn By: Edward Douglas, March 28, 2013
 Revised April 2, 2013

D-14, W= 2 ft.

51.9

Sacramento River

51.8

Segment A

PD-1

51.7

51.6

RIVER RD

ARABELLA WAY

BENHAM WAY

HARMON DR

TRUDYWAY

Path: K:\Projects_1\HDR\00071_11_SouthPort\mapdoc\Working\Impact_Mapbook_20130402.mxd; Author: ; Date: 4/2/2013

Legend

- Construction Area Boundary
- Permanent Fill (37,604 acres)
- Ordinary High Water Mark (OHWM)
- Segment Boundary
- Sacramento River Mile
- Pond
- Ditch
- Project Elements**
- Cutoff Wall
- Offset Area Grading
- Proposed Road
- O&M Corridor
- Seepage Berm
- Adjacent Levee
- Setback Levee
- Levee Slope Flattening
- Bank Stabilization
- Levee Breach Arming
- Staging Area

W = Average Width at Ordinary High Water Mark

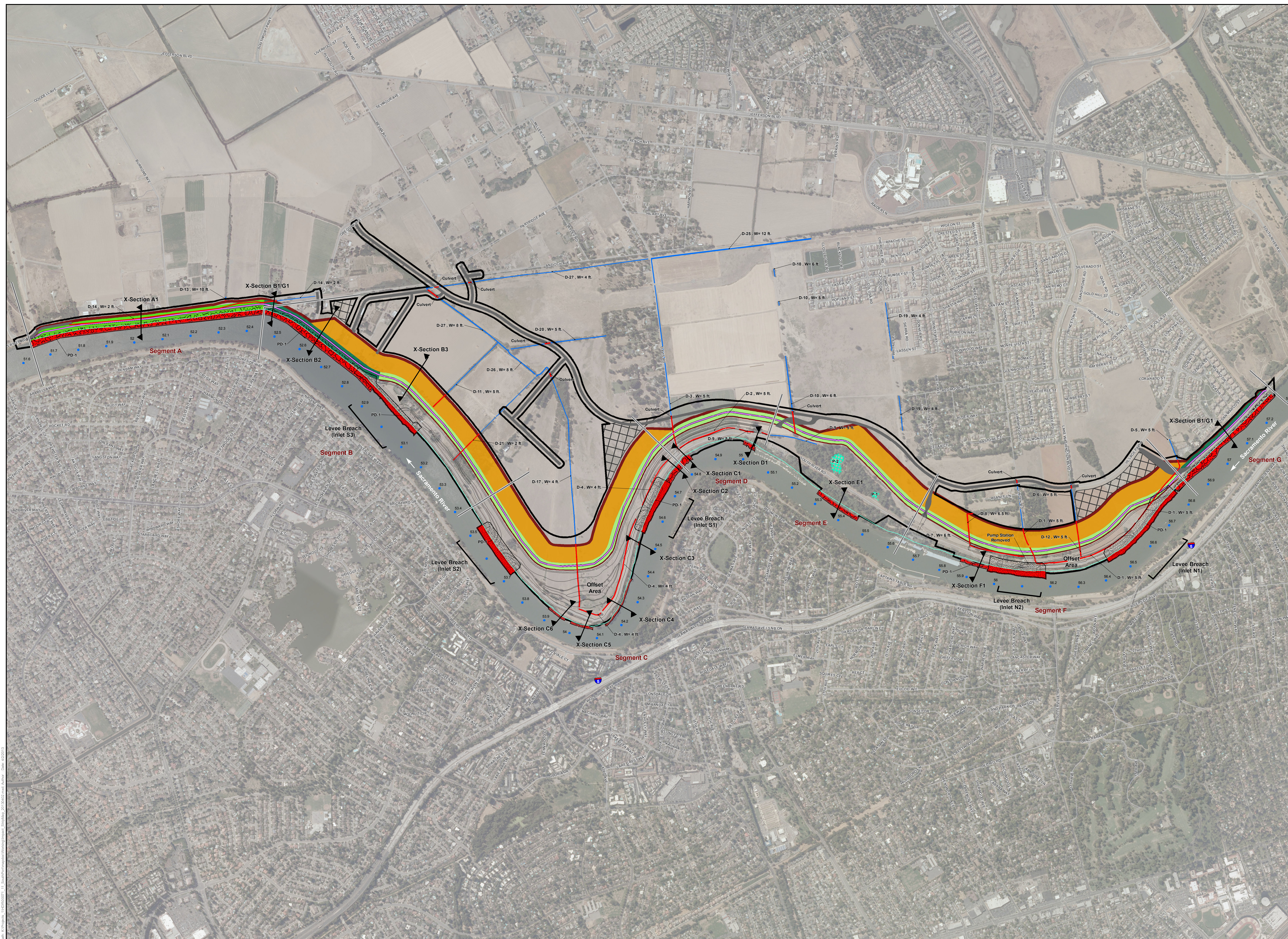

Notes:
Source: Project Elements, HDR, January 2013
Base Map Source: ICF, 2012
Imagery Source: NAIP 2010
USGS Topo Quad: Sacramento West
PLSS: Wetlands Land Grant

Prepared By: ICF, International 916.737.3000
Drawn By: Edward Douglas, March 28, 2013
Revised April 2, 2013

Figure 3
Project Plan View Showing Impacts to Potential Waters of the United States, Including Wetlands

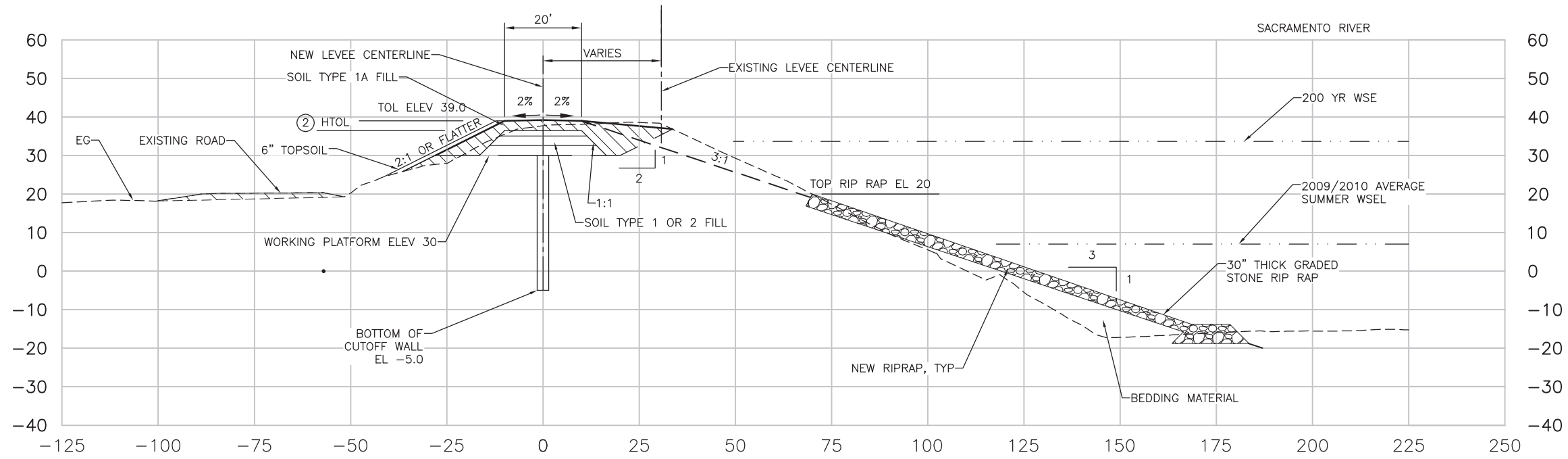

Cross Section A1 - Strengthen In-Place w/Cutoff Wall

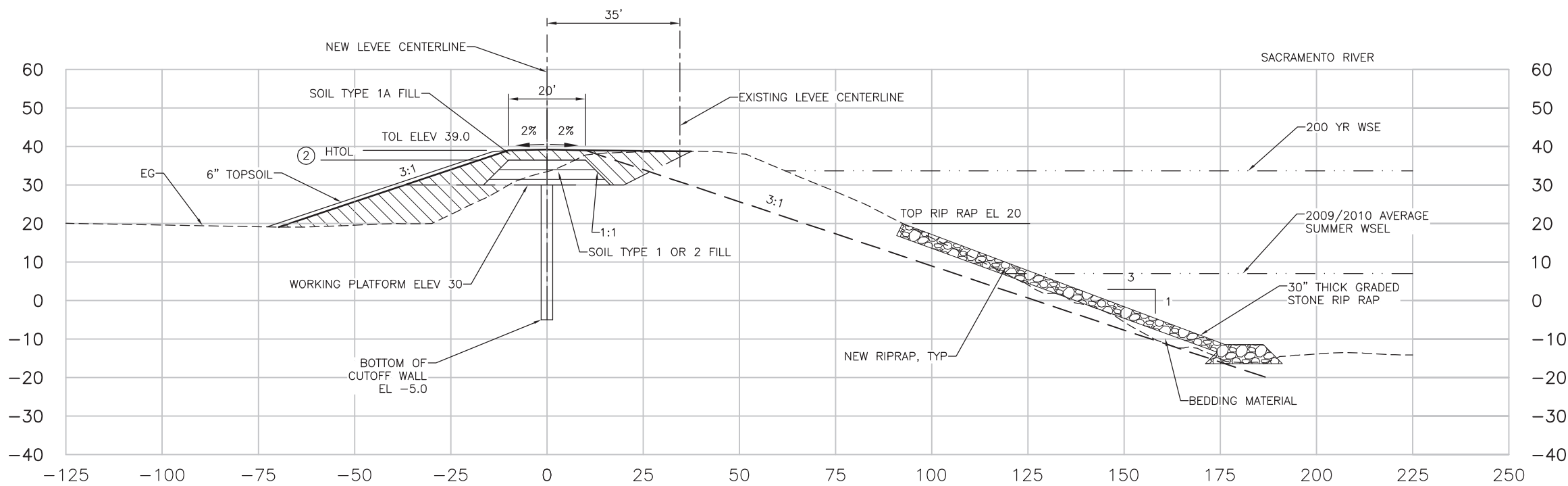

Cross Section B1/G1 - Adjacent Levee w/Cutoff Wall

Source: HDR, 2013

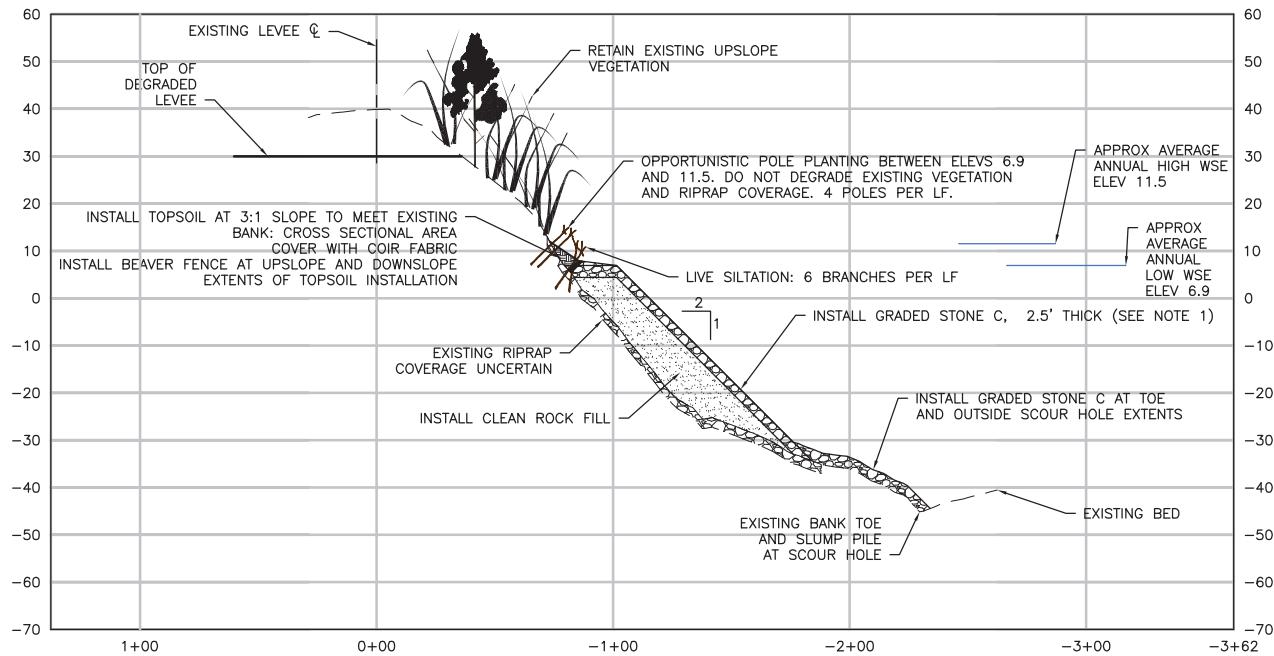

- NOTE:
1. INSTALL THICKENED RIPRAP SECTION AT UPSTREAM AND DOWNSTREAM EXTENTS OF SCOUR HOLE SPOT REPAIR. THICKENED SECTION SHALL EXTEND UP AND DOWN THE BANK AND SHALL BE 5' THICK AND 12.5' WIDE. TRANSITION Laterally TO 2.5' THICKNESS AT 1:1 SLOPE. THICKENED SECTION VOLUME ACCOUNTED FOR IN SCOUR HOLE QUANTITY
 2. SPOT REPAIR OF SCOUR HOLE WITH TOE PROTECTION. 195 LF TOP LENGTH, TAPERING AT BOTTOM.
 3. STATIONING REFERS TO THE EXISTING LEVEL BASELINE.

Cross Section C1 - Bank Armoring, Fill, and Pole Plantings

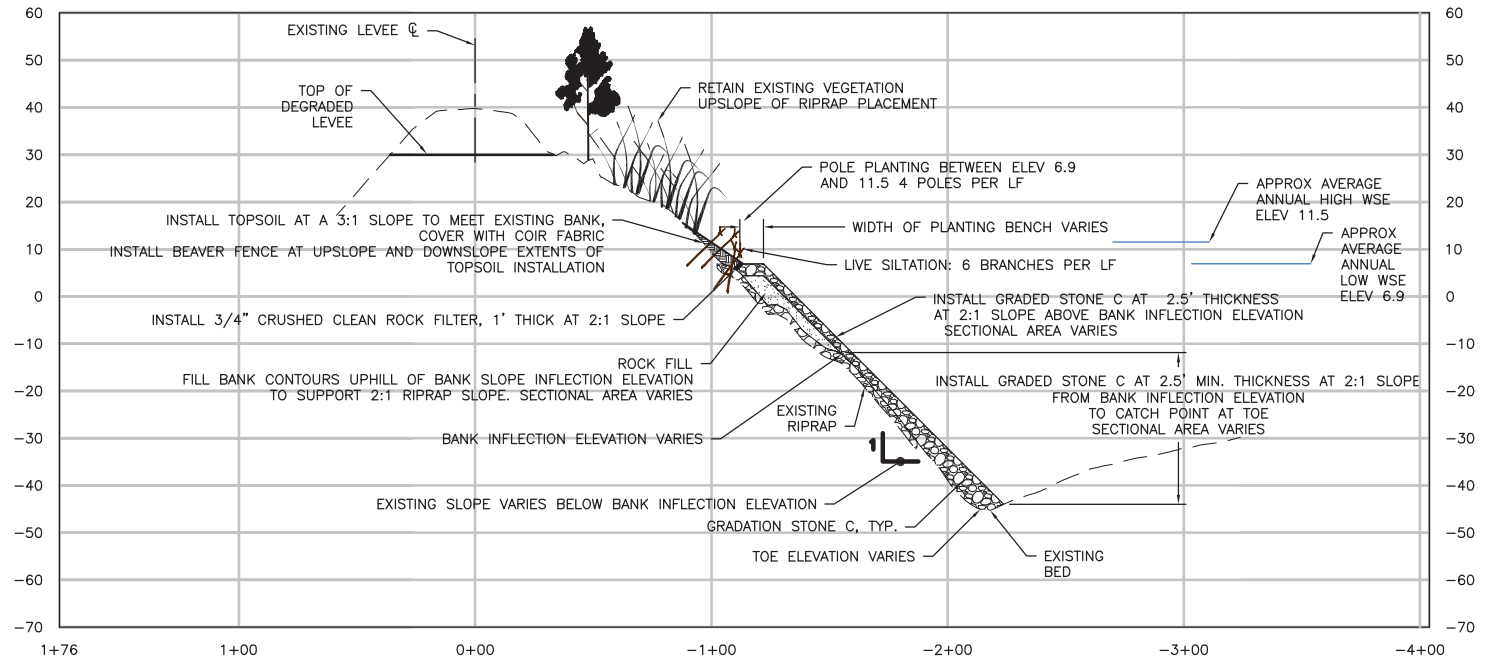

- NOTES:
1. 575 LF BANK REPAIR: ADD RIPRAP PLANTING BENCH AND DENSE PLANTING TO ADDRESS WAVE EROSION. PRESERVE EXISTING VEGETATION UPSLOPE OF TREATMENT. CONTINUE REPAIR DOWNSTREAM OF IDENTIFIED SITE, TERMINATE AT FLOODPLAIN INLET
 2. STATIONING REFERS TO EXISTING LEVEL BASELINE.

Cross Section C2 - Bank Armoring, Fill, and Pole Plantings

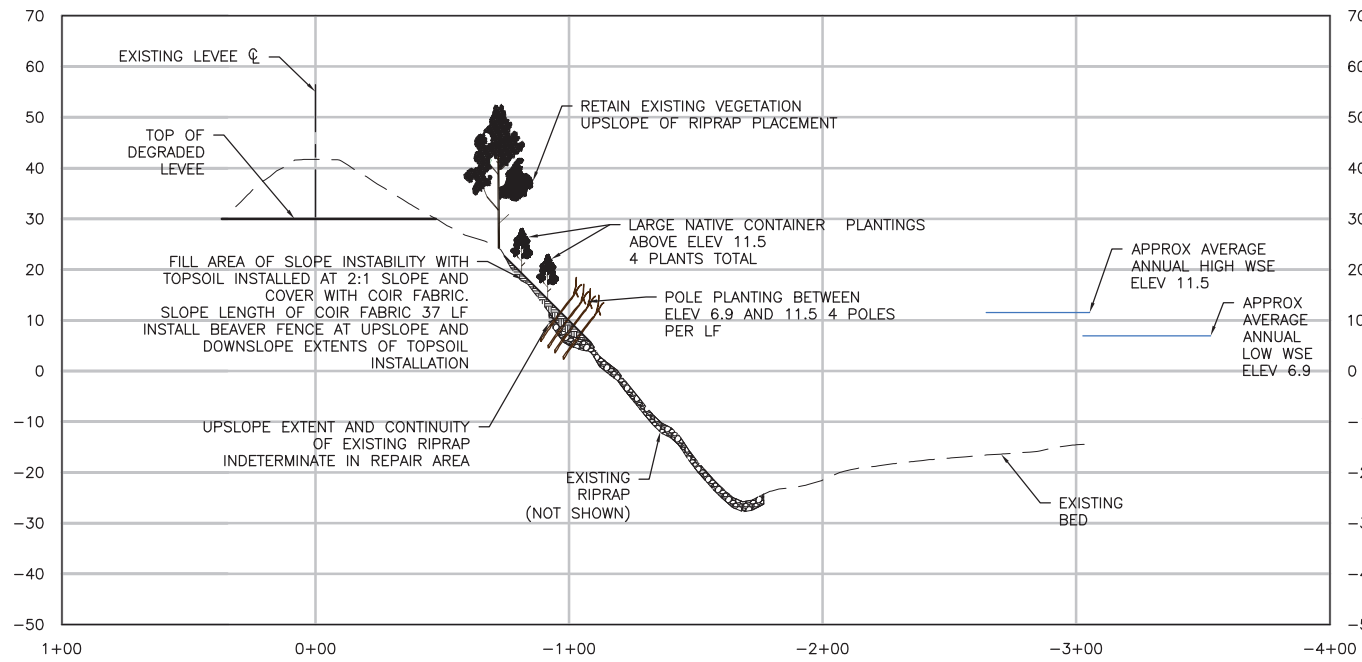

- NOTES:
1. 60 LF BANK REPAIR: SPOT REPAIR OF SLOPE INSTABILITY. DENSE PLANTING TO STABILIZE SLOPE.
 2. STATIONING REFERS TO THE EXISTING LEVEL BASELINE.

Cross Section C3 - Bank Fill and Pole Plantings

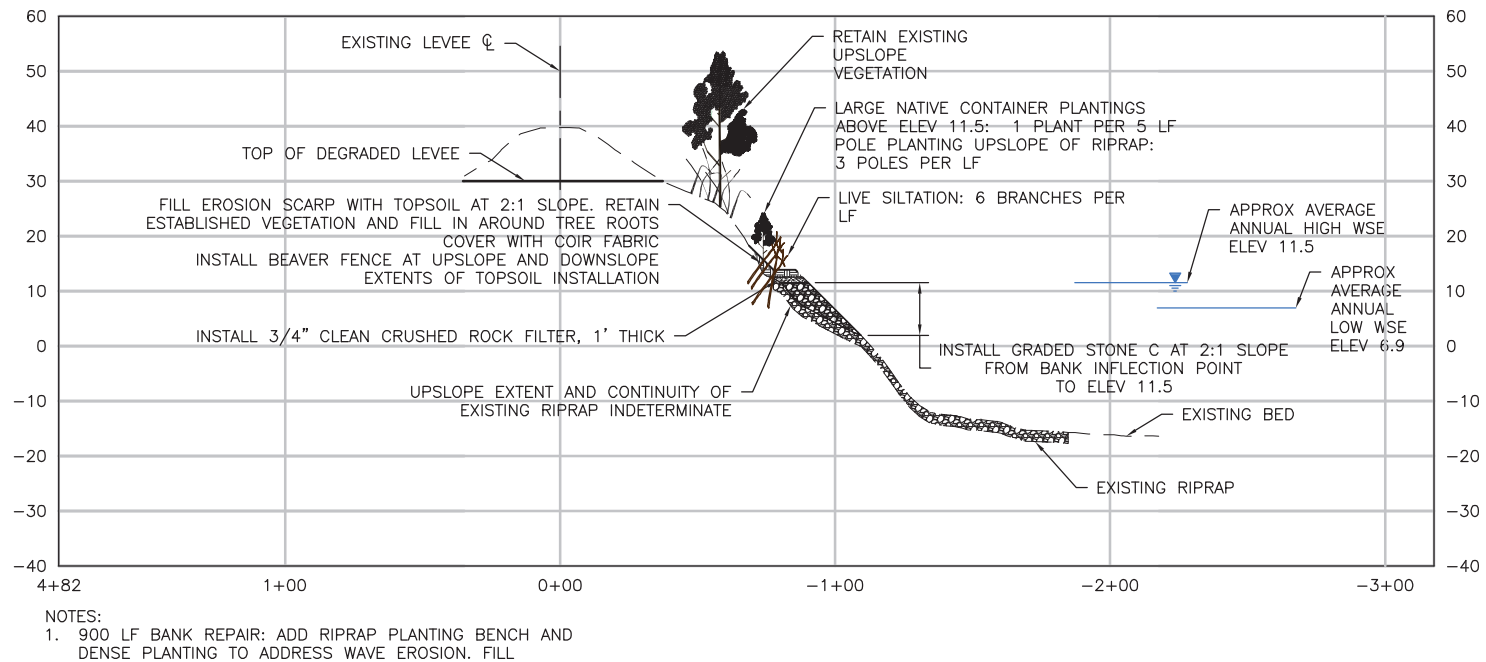

- NOTES:
1. 900 LF BANK REPAIR: ADD RIPRAP PLANTING BENCH AND DENSE PLANTING TO ADDRESS WAVE EROSION. FILL EROSION SCARP AREAS TO BRING BACK TO 2:1 SLOPE. PRESERVE EXISTING VEGETATION UPSLOPE OF TREATMENT.
 2. STATIONING REFERS TO THE EXISTING LEVEL ALIGNMENT.

Cross Section C4 - Bank Armoring, Fill, and Pole Plantings

Source: HDR, 2013



Figure 4C
Typical Bank Armoring Sections

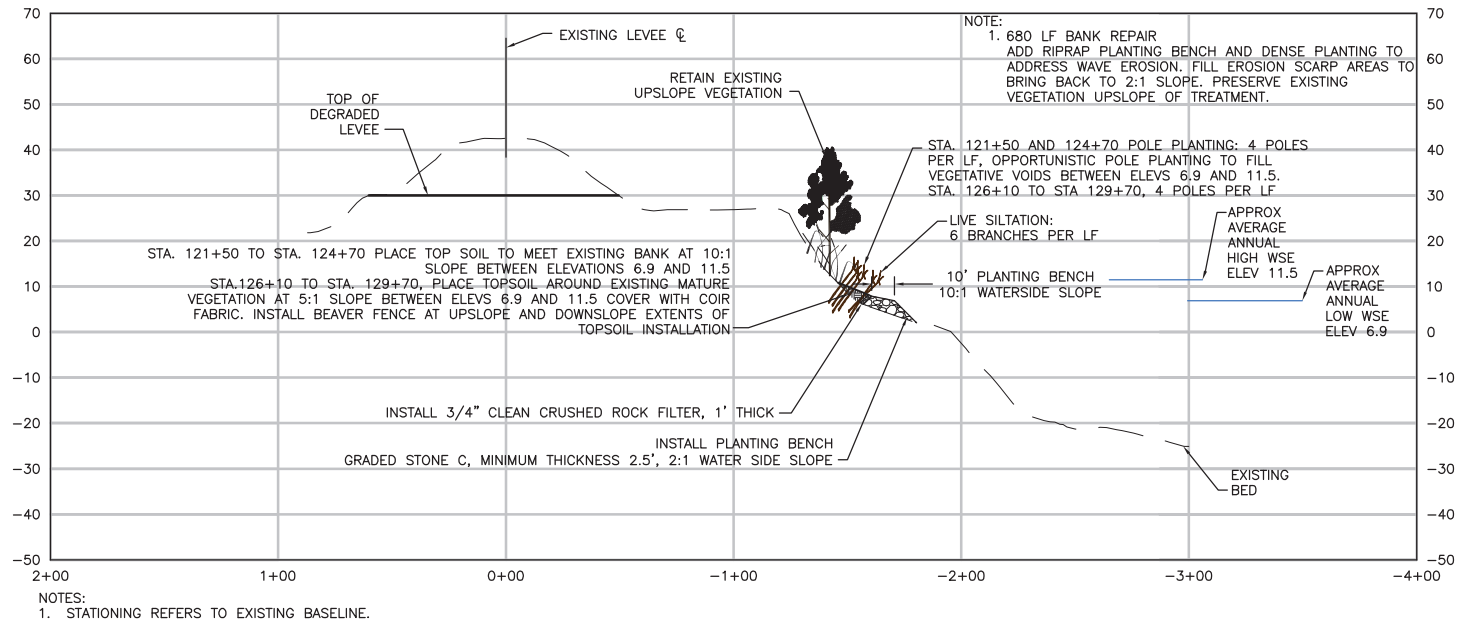

Cross Sections C5 and C6 - Bank Armoring and Pole Plantings

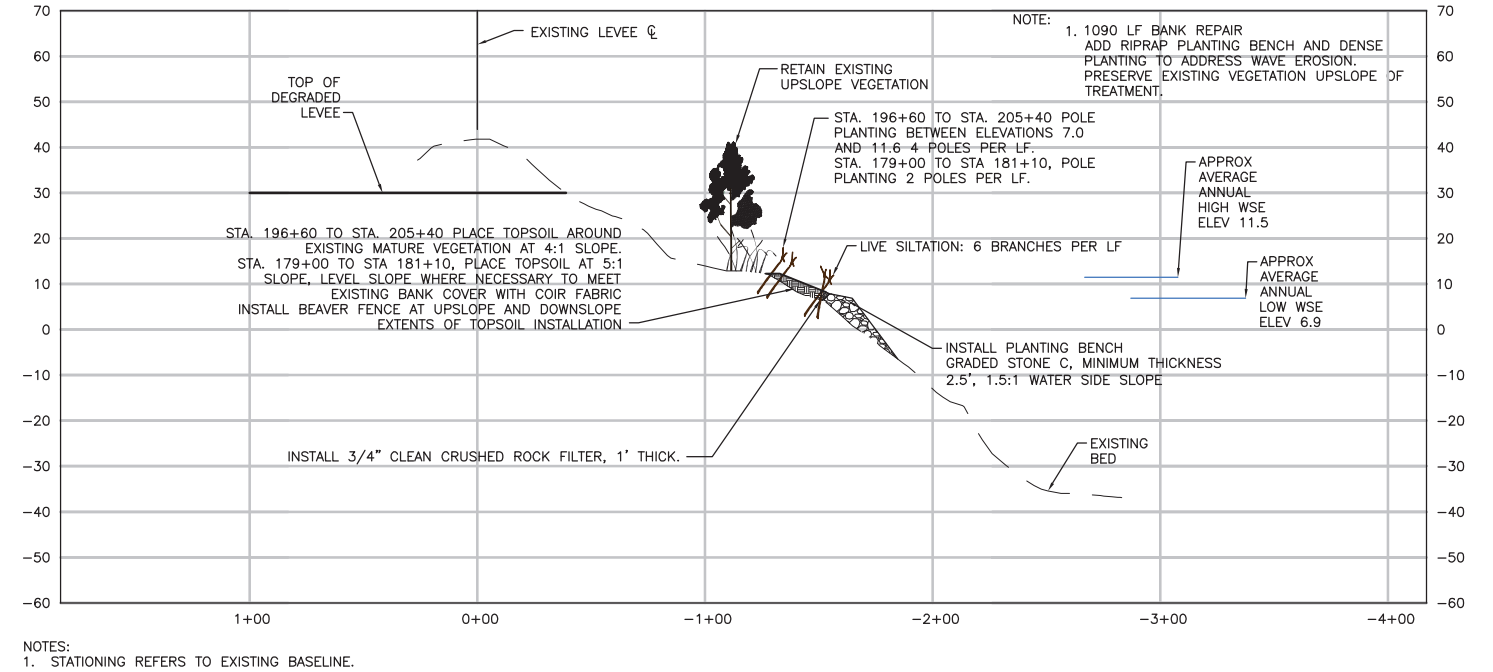

Cross Sections D1 and E1 - Bank Armoring, Fill, and Pole Plantings

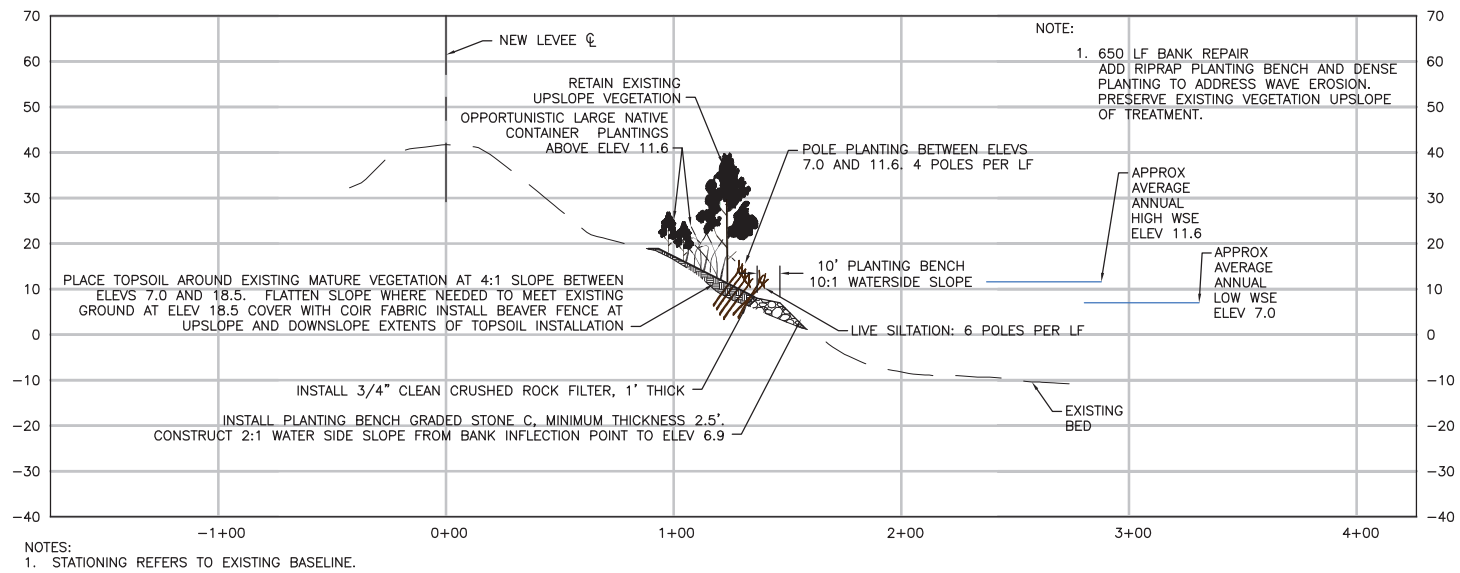

Cross Section F1 - Bank Armoring, Pole Planting, and Slope Flattening

Graphics...0007112(3/28/13) AB

Source: HDR, 2013



Figure 4D
Typical Bank Armoring Sections

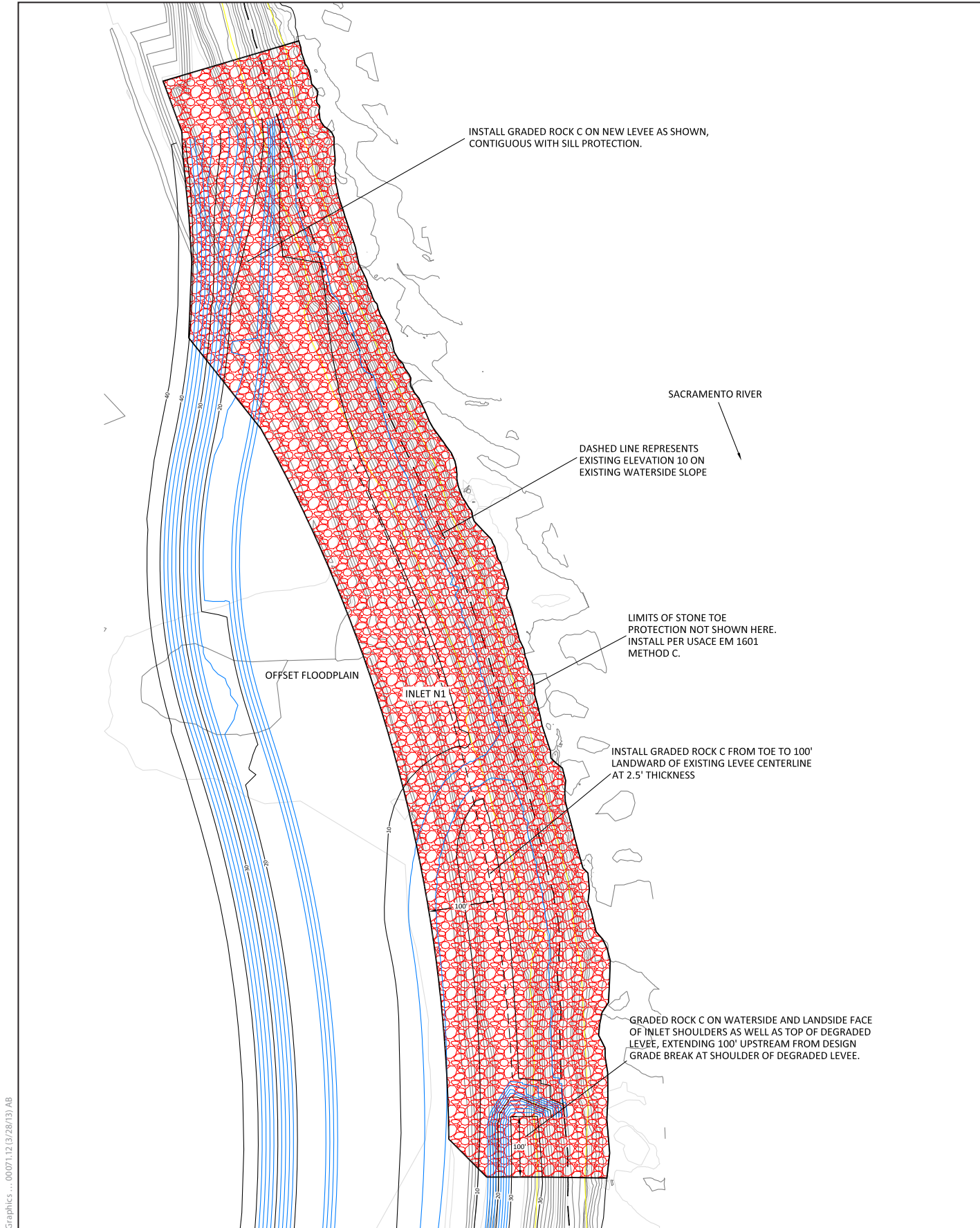
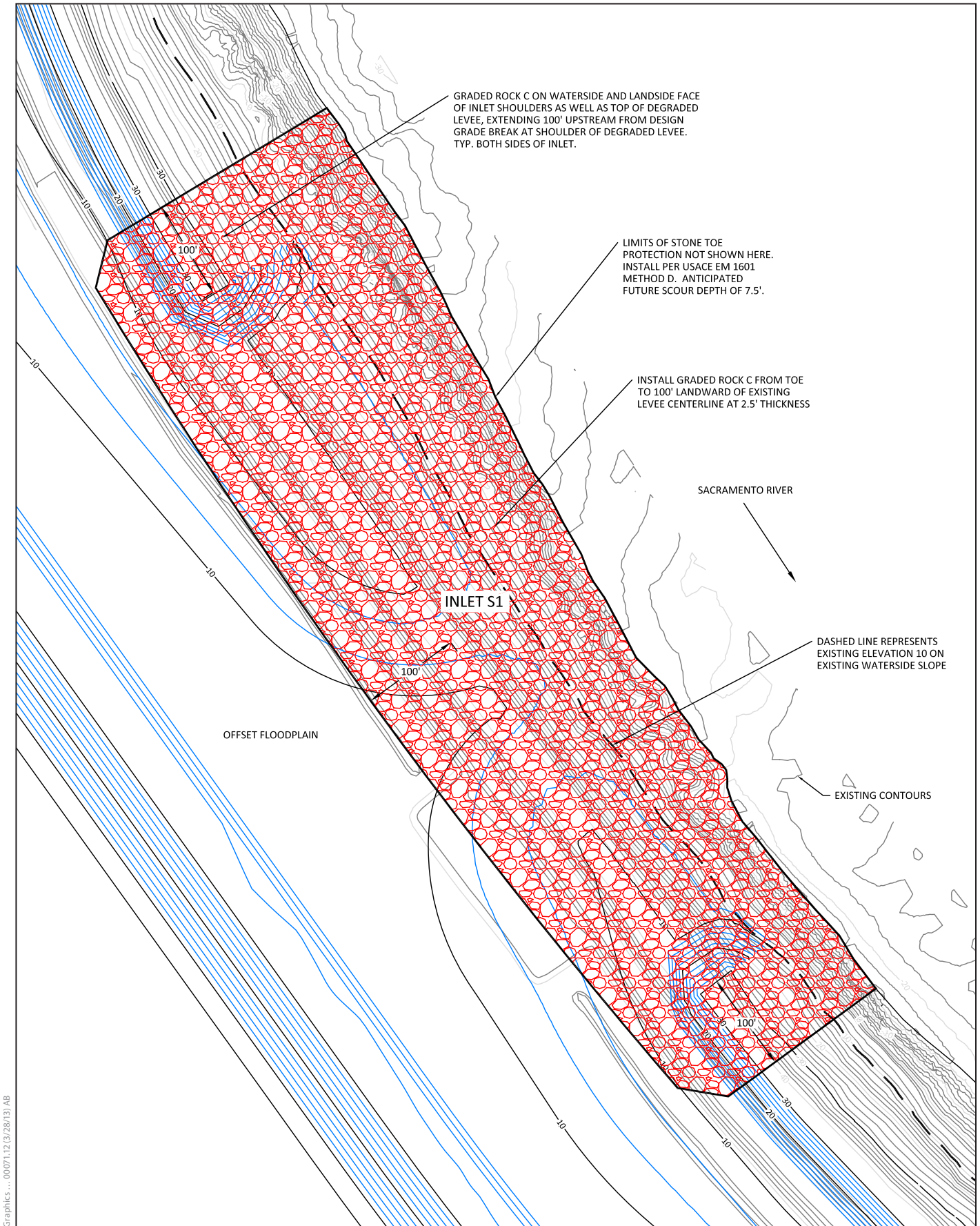

Figure 5A
Inlet N1 Plan View



Graphics... 00071.12 (3/28/13) AB



Figure 5B
Inlet S1 Plan View

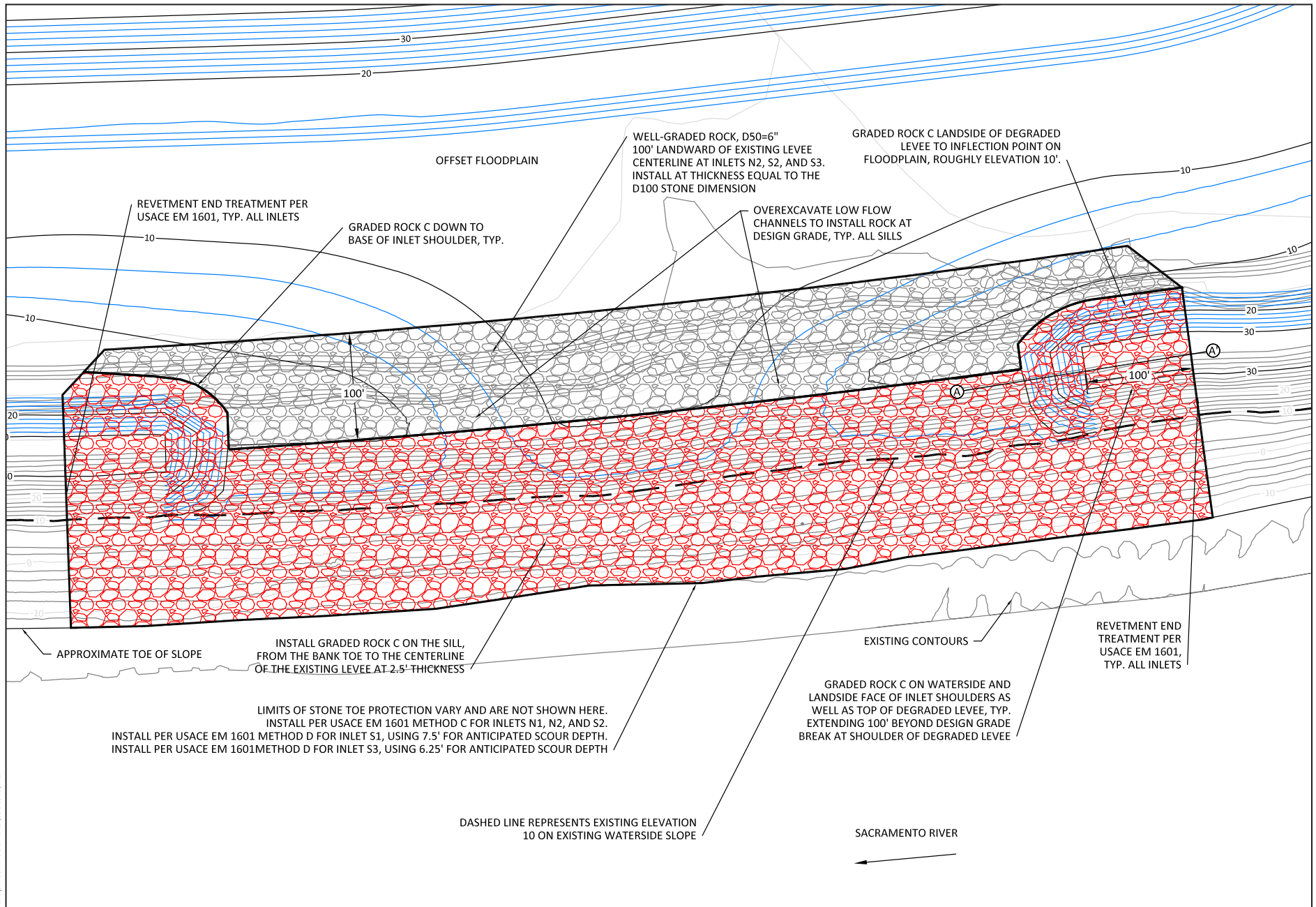

Figure 5C
Inlet S2 Plan View

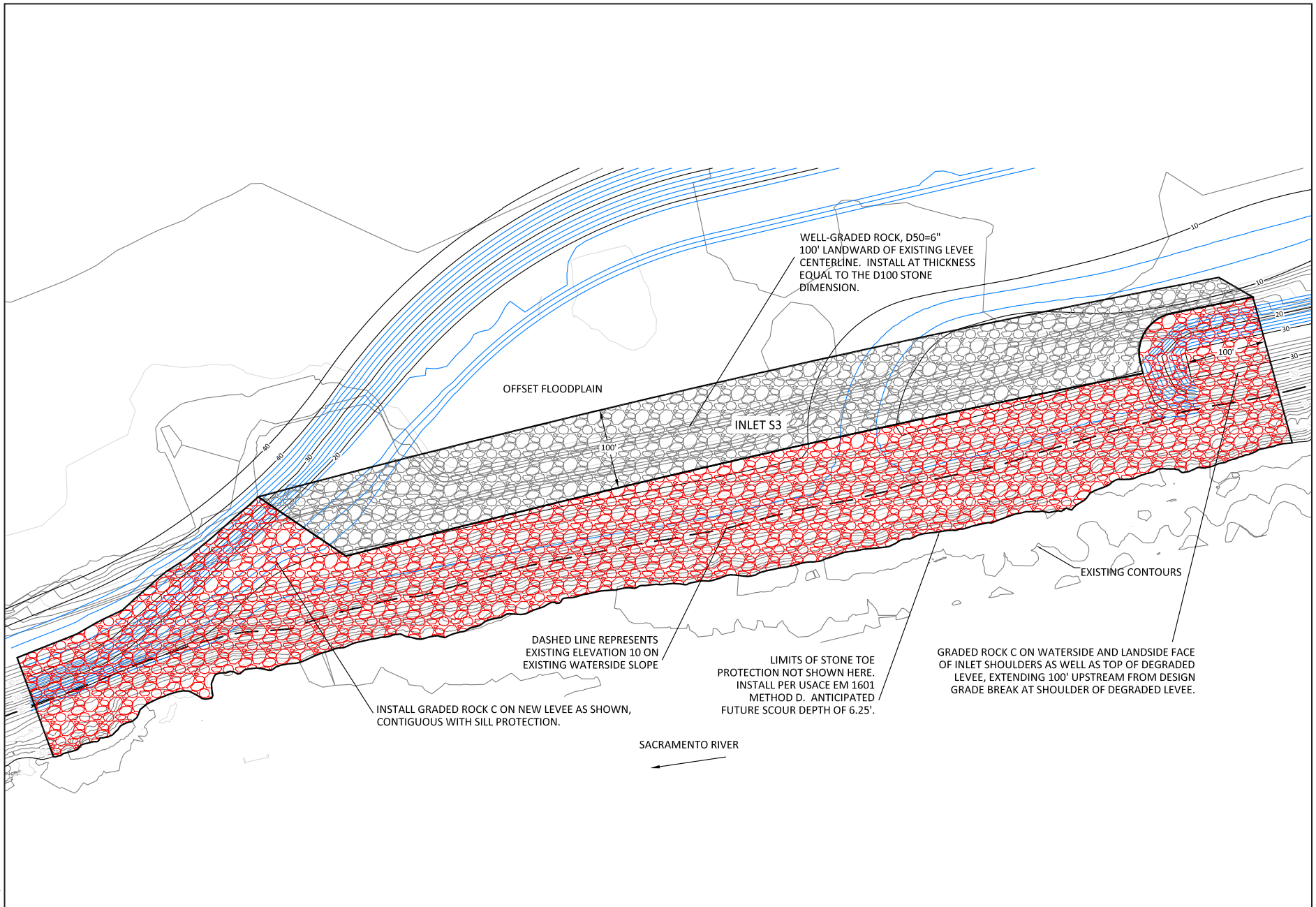
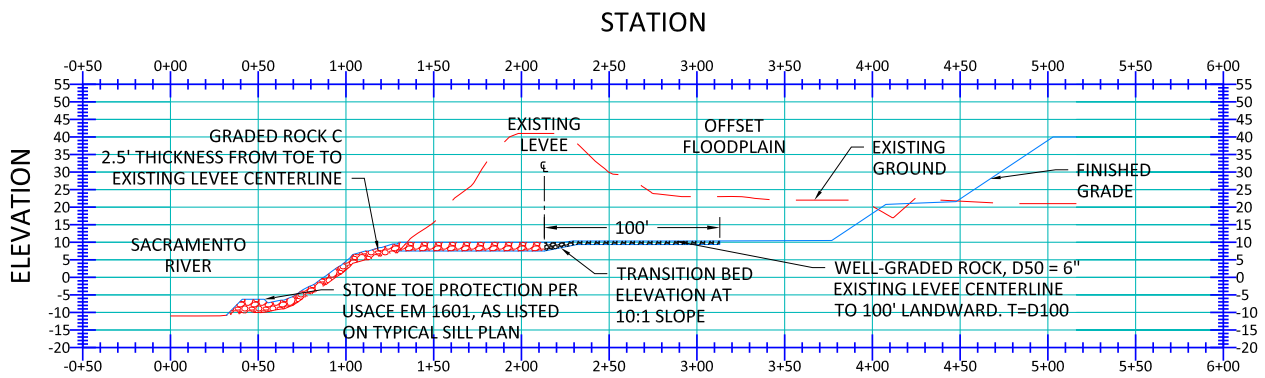
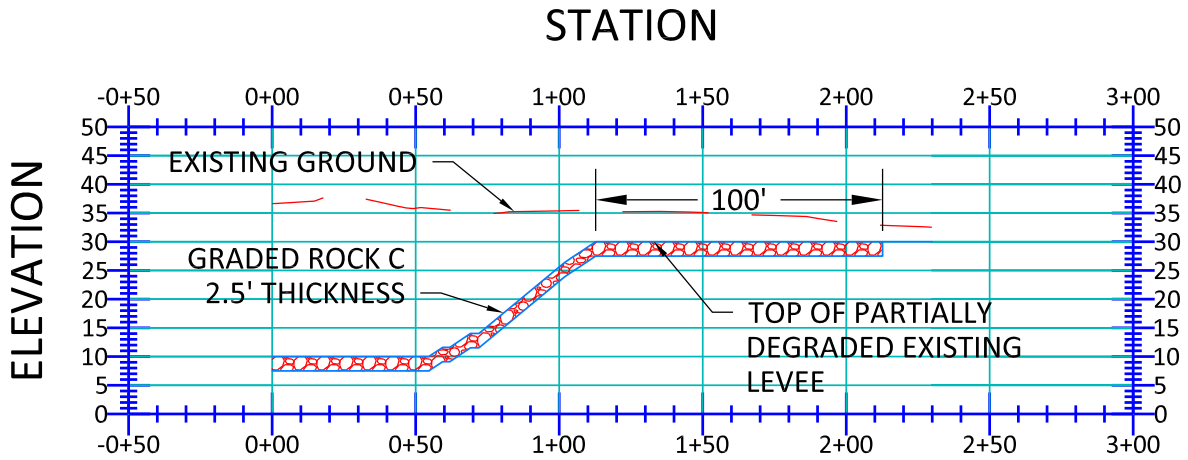

Figure 5D
Inlet S3 Plan View



Typical Inlet Sill Cross Section



Typical Inlet Shoulder Cross Section

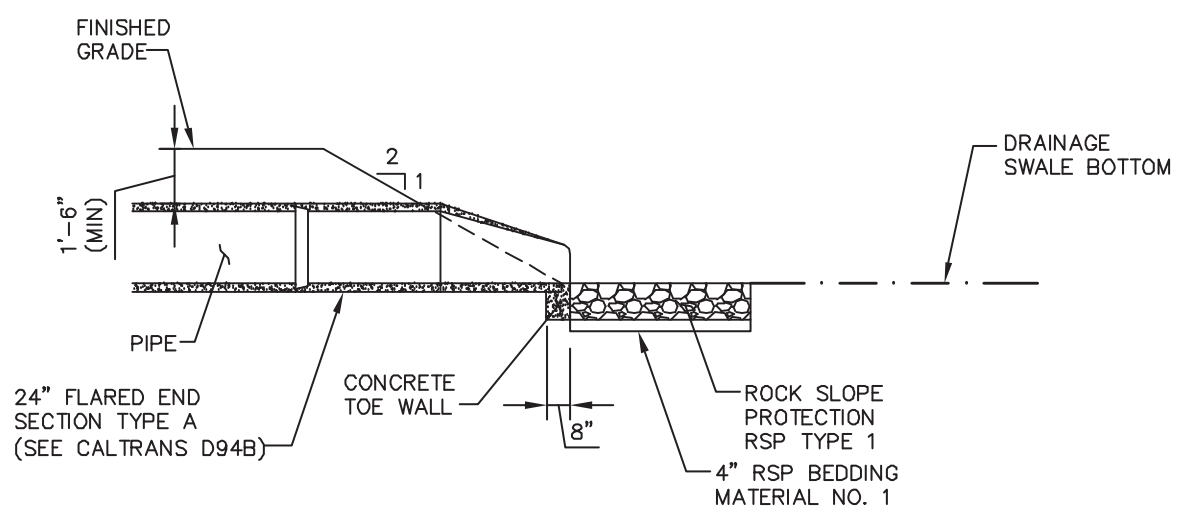
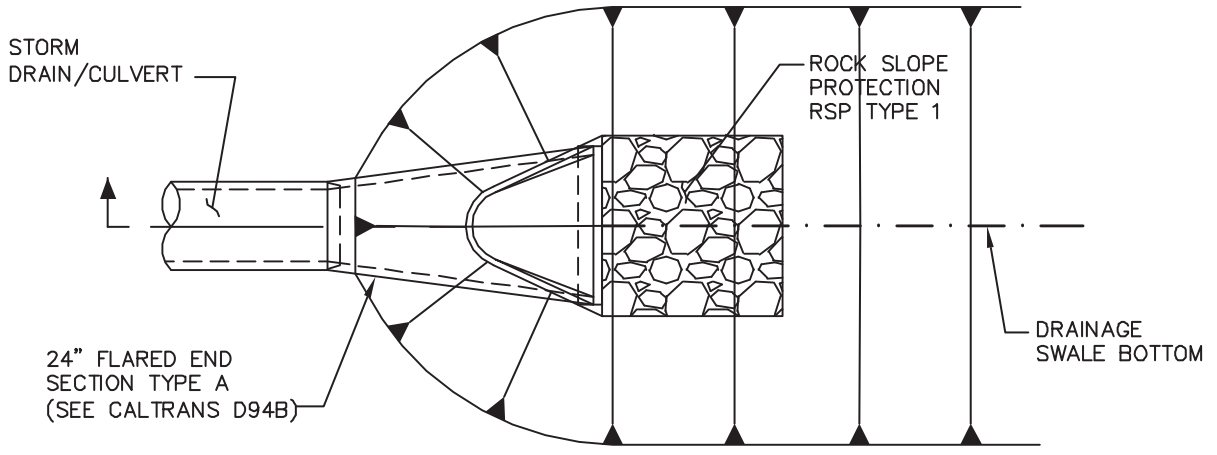

TYPICAL FLARED END DETAIL

Graphics ... 0007112 (3/28/13) AB



Figure 6
Typical Drainage Details