

Brine Zero Liquid Discharge (ZLD) Fundamentals and Design

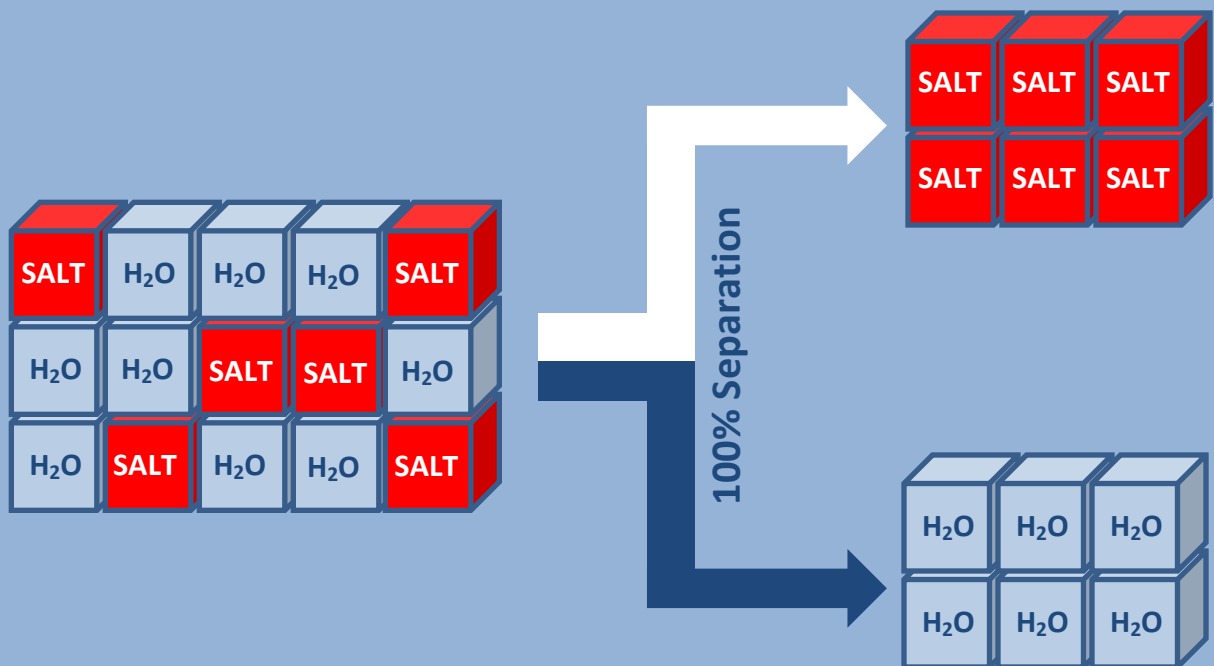

Phone: +31 152 610 900

Email: info@lenntech.com

LENNTech
WATER TREATMENT SOLUTIONS

A guide to the basic conceptualization of the ZLD/MLD process design and the relative technologies involved

When I first started researching into Zero Liquid Discharge (ZLD), I found out that there no compact guides for this process online. This is how the idea for a ZLD booklet was born. This rough guide is meant to help you understand the basics and to decide what's best for your Brine Treatment case. Our Team in Lenntech B.V. will be happy to help you out with the details and to find the best available options that will decrease the cost and increase the efficiency of your project.

Christos Charisiadis

R&D engineer

christos@lenntech.com

September 2018

'Zuinigheid met vlijt' (Thrift and diligence). Be frugal, work hard! The Dutch uphold these two virtues above everything.

INDEX

CHAPTER 1: Brine Fundamentals	1
1. What is Brine?	1
2. Desalination Brine	1
2.1 Quantity	3
2.2 Quality	3
2.3 Physical and chemical properties of brine	4
2.3.1 Antiscalants	5
CHAPTER 2: Conventional Brine Treatment Methods	8
1. Conventional Brine Disposal	8
2. Comparison	9
2.1 Cost Comparison	10
3. Regulatory legislations	11
4. Implementation	11
5. Footprint	11
6. Reliability and Operational Limitations	11
7. Surface Water Brine Discharge	13
7.1 Potential Environmental Impacts	15
7.2 Potential SWRO Brine Treatment Requirements	15
7.3 Surface Water Discharge Costs	16
8. Brine Co-Disposal with Wastewater Effluent	18
8.1 Potential Environmental Impacts	18
8.2 Impact on Wastewater Treatment Plant Operations	18

8.3 Effect on Water Reuse	19
8.4 Costs for Brine Sewer Discharge	19
9. Brine Deep Well Injection	20
9.1 Potential Environmental Impacts	21
9.2 Criteria and Methods for Feasibility Assessment	21
9.3 Injection Well Costs	22
10. Brine Evaporation Ponds	23
10.1 Potential Environmental Impacts	23
10.2 Criteria and Methods for Feasibility Assessment	24
10.3 Evaporation Pond Costs	24
11. Brine Land Application	26
11.1 Potential Environmental Impacts	26
11.1.1 Irrigation	26
11.1.2 Rapid Infiltration	27
11.2 Criteria and Methods for Feasibility Assessment	27
CHAPTER 3: ZLD Fundamental Design	28
1. What is ZLD?	28
2. Drivers	29
3. Applications	30
4. Determining Factors	31
5. Operation costs	31
6. Basic Design - ZLD Blocks	32
6.1. Pre-concentration	33
6.1.1. Electrodialysis/ Electrodialysis Reversal	33

6.1.2. Forward Osmosis	34
6.1.3. Membrane Distillation	34
6.1.4 The importance of Pre-Concentration in a ZLD Process	34
6.2 Evaporation and Crystallization	36
7. Electrodialysis/ED Reversal	38
7.1 EDR Process Function	39
7.2 Advantages and Disadvantages	40
7.3 Process Industry Applications	41
8. Forward Osmosis	42
8.1 Process Function	43
8.2 Advantages and Disadvantages	45
8.3 Process Industry Applications	46
9. Direct Contact Membrane Distillation	47
9.1 Process Function	47
9.2 Advantages and Disadvantages	49
9.3 Process Industry Applications	50
10. Evaporators	51
10.1 Selection of suitable evaporator	51
10.2 Single-Effect vs. Multiple-Effect	52
10.3 Evaporator Types	54
10.4 Process explanation	55
10.5 Energy saving	56
10.5.1 Mechanical Vapor Compression	57
11. Crystallizers	59

11.1 Process Explanation	59
11.2 Highly Soluble Salts and Evaporator BPR	60
12. Minimal Liquid Discharge (MLD)	62
12.1 ZLD vs MLD	62
12.2 Why MLD?	62
12.3 Reduced costs & environmental impact	64
12.4 Evaluating MLD needs	64
CHAPTER 4: ZLD Brine Recovery Options	66

CHAPTER 1: Brine Fundamentals

1. What is Brine?

Brine in the wider term is a liquid solution with increased salinity and temperature that is the product of many industrialized and mining processes.

Sources of brine include,

- 1) Desalination
- 2) Mining Processes
- 3) Solution Mining of Salt Domes for Hydrocarbon Storage

2. Desalination Brine

Desalination Brine is a by-product liquid stream coming from the desalination process containing in higher concentrations most of the feed dissolved solids and some of the pretreatment additives (residual amounts of coagulants, flocculants, and antiscalants), microbial contaminants, and particulates that are rejected by the RO membranes.

Supply demand during the last decade has steeped both for potable and industrial good quality water. With the decrease of freshwater sources, the increase of population and new advancements made in desalination technology, the water providers have turned to the treatment of brackish water (BW) and seawater (SW) to see these demands met.

By 2007 the total produced water worldwide rose up to 47.6 m³/d and by 2015 to double with 97.5 m³/d with 45% being in the Middle East. 70% of the desalination plants after 2000 were membrane processes which brings in total Reverse Osmosis (RO) to 63% of the operations. 23% are Multi Stage Flash (MSF), 8% Multi Effect Distillation (MED) and the rest are Electrodialysis (ED)/ Electrodialysis Reversal (EDR) and hybrids. Seawater RO (SWRO) can concentrate the salt concentration 1.3 to 1.7 times higher and MSF 1.1 to 1.5 times. These processes generate the product water and a liquid residual with high concentration of Sodium Chloride (NaCl) and other dissolved salts and is called Brine.

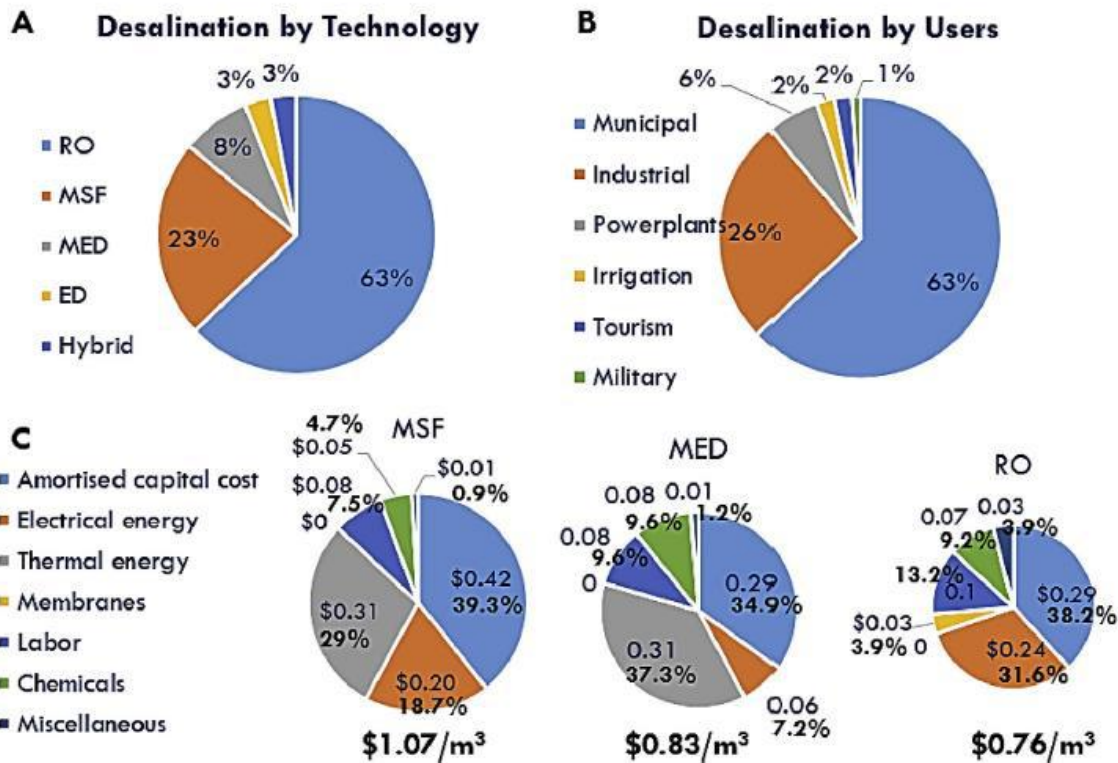

Fig.1, Desalination industry by technology, users, and cost components (Costs assume a \$0.05/kWh electricity cost and an oil price of \$60/bbl), Desalination and sustainability - An appraisal and current perspective, Veera Ganeswar Gude, *Water Research* 89 (2016)

Brine is a very loose term in the water industry but here we will use it for salinities of 65,000-85,000 ppm (mg/L) Total Dissolved Solids (TDS) which can't be treated by the conventional desalination processes like RO (RO osmotic pressure limit 70,000 ppm). Its disposal though can be problematic as 1) increases the salinity of the receiving water bodies, 2) impacts the local marine life, 3) it contains pretreatment and membrane cleaning chemicals, 4) it contains metals from the corrosion of the systems (Cu, Fe, Ni, Mo, Cr), 5) it creates aesthetic issues (colorization), 6) it impacts the nearby aquifers from leaks in the brine pipes, 7) it creates permanent damage due to the discharge infrastructure works.

Brine is either directly disposed or minimized before disposal but due to increasingly tighter government legislations, conventional brine management methods like surface/ deep water discharge, deep well injection or discharge to wastewater treatment plants may not be a feasible choice in the near future.

2.1 Quantity

Brine quantity depends from the desalination plant's production capacity and its recovery rate which is expressed as the percentage (%) of the volume of freshwater produced to the total volume of saline source water. BWRO has recoveries usually of 70 to 90% and SWRO typically 40 to 55%. Higher recovery results in smaller concentrate volume (higher salinity) and vice versa. The volume of brine produced by the desalination plant, can be calculated as follows,

$$V_b = V_p \times (1-R)/R \quad (1)$$

where,

V_p = permeate volume

V_b = brine volume

R = permeate recovery rate (%)

2.2 Quality

Brine quality depends on,

1. the feed's salinity
2. the desalination membranes' salt rejection
3. the total recovery

BWRO concentration factor is typically 4 to 10 while SWRO usually is 1.5 to 2.0 times. Brine TDS (TDS_b) depends from the feed and permeate TDS concentrations (TDS_f and TDS_p) and the plant recovery (Y),

$$TDS_b = TDS_f \times 1/(1-R) \times (R \times TDS_p)/(100 \times (1-Y)) \quad (2)$$

The concentration can be calculated as,

$$CF(\%) = 1/(1-R) \quad (3)$$

If the membrane salt passage (SP) is known, CF can be calculated as,

$$CF(\%) = [1 - (R \times SP)]/(1-R) \quad (4)$$

where

$$\text{SP (\%)} = 1 - \% \text{ salt rejection} = \text{permeate TDS (TDS}_p\text{)}/\text{feed TDS (TDS}_f\text{)} \quad (5)$$

The salt CF is mainly limited by the brine's increasing osmotic pressure. For SWRO, this limit is ca. 65,000 to 80,000 mg/L. Optimum recovery for a single-pass SWRO system is 40 to 45% and the CF moves in a range of 1.5 to 1.8. For comparison BWRO plants typically have recoveries of 70 to 90% and concentration factors of 4 to 10.

Depending on the feed quality we can use the following rules to predict the brine quality

1. the brine pH is higher than the feed because it has higher alkalinity.
2. RO membranes reject heavy metals in a similar ratio as calcium and magnesium
3. most organics are rejected in < 95% (except for those with low molecular weight (MW))
4. groundwater (GW) BWRO brine, is likely be to be anaerobic and contain hydrogen sulphide (H₂S)

If pretreatment is included in the desalination process, the RO feed water will have reduced levels of certain constituents such as dissolved metals, microorganisms, and particles but also slightly increased concentration of inorganic ions such as sulphate, chloride, and iron if coagulants are used. Brine may also contain residual organics from source water conditioning with polymers and antiscalants.

The generated brine has low turbidity (usually < 2 NTU), low total suspended solids (TSS) and biochemical oxygen demand (BOD) (typically < 5 mg/L) because most of the particulates contained in feed due to their removal from the pretreatment. But if the plant's pretreatment side streams are mixed and discharged with the brine, the mix may have increased turbidity, TSS, and occasionally BOD. Acids and scale inhibitors added to the feed water are rejected by the SWRO membrane and also affect the mineral content and quality of the brine. Scale inhibitor levels in the concentrate are usually < 20 mg/L.

2.3 Physical and chemical properties of brine

The conversion rate of RO processes (Fig.2) ranges between 20 to 50 %.

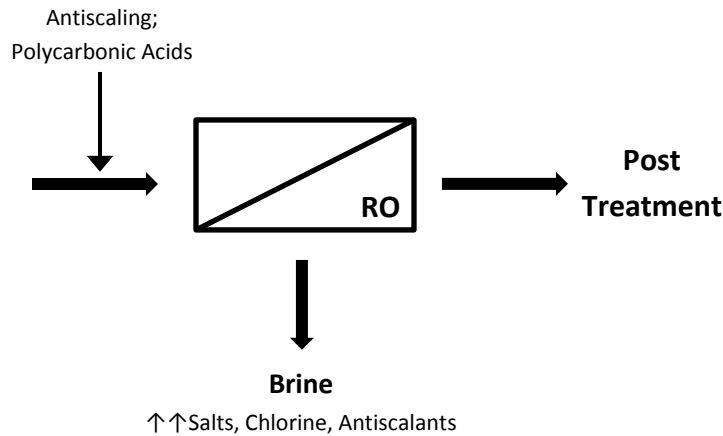

Fig.2, Schematic of the chemical additives in the RO process.

2.3.1 Antiscalants

Scaling species in RO plants are mainly calcium carbonate, calcium sulphate and barium sulphate. In order to apply scale controls, acid treatment and antiscalant dosage are. In RO sulphuric acid was most commonly used but the use of antiscalants, such as polyphosphates, phosphonates or polycarbonic acids has become very common due to the negative effects of inorganic acid treatment.

Table 1 ,Physical and chemical properties of brine from seawater desalination and the potential environmental/ecological impacts from its disposal.

	RO plants	MSF plants	Environmental/ecological impacts
<i>Physical properties</i>			
Salinity and temperature	65,000-85,000 mg/L at ambient seawater temperature	About 50,000 mg/L, ± 5-15 °C above ambient seawater temperature	Can be harmful; reduces vitality and biodiversity at higher values; harmless after good dilution
Plume density	Negatively buoyant	Positively, neutrally or negatively buoyant depending on the process, mixing with cooling water from collocated power plants and ambient density stratification	Can be harmful; can have local impact on biodiversity
Dissolved oxygen (DO)	If well intakes used: typically below ambient seawater DO because of the low DO content of the source water If open intakes used: approximately the same as the ambient seawater DO concentration	Could be below ambient seawater DO because of physical deaeration and use of oxygen scavengers	/

<i>Biofouling control additives and by-products</i>			
Chlorine	If chlorine or other oxidants are used to control biofouling, these are typically neutralized before the water enters the membranes to prevent membrane damage	Approx. 10-25% of source water feed dosage, if not neutralized	Very toxic for many organisms in the mixing zone, but rapidly degraded, THM - RO - MSF
Halogenated organics	Typically low content below harmful levels	Varying composition and concentrations, typically trihalomethanes	Carcinogenic effects; possible chronic effects, more persistent, dispersal with current, main route of loss is thorough evaporation
<i>Removal of suspended solids</i>			
Coagulants (e.g. iron-III-chloride)	May be present if source water is conditioned and the filter backwash water is not treated. May cause effluent coloration if not equalized prior to discharge	Not present (treatment not required)	Non-toxic; increased local turbidity /may disturb Photosynthesis; possible accumulation in sediments
Coagulant aids (e.g. polyacrylamide)	May be present if source water is conditioned and the filter backwash water is not treated	Not present (treatment not required)	/
<i>Scale control additives</i>			
Antiscalants acid (H2SO4)	Not present (reacts with seawater to cause harmless compounds, i.e. water and sulfates; the acidity is consumed by the naturally alkaline seawater, so that the discharge pH is typically similar or slightly lower than that of ambient seawater). Typically low content below toxic levels	Typically low content below toxic levels (reacts with seawater to cause harmless compounds, i.e. water and sulfates; the acidity is consumed by the naturally alkaline seawater, so that the discharge pH is typically similar or slightly lower than that of ambient seawater)	Poor or moderate degradability + high total loads →accumulation, chronic effects, unknown side-effects
<i>Foam control additives</i>			
Antifoaming agents (e.g. polyglycol)	Not present (treatment not required)	Typically low content below harmful levels	Non-toxic in concentration levels; good degradability
<i>Contaminants due to corrosion</i>			
Heavy metals	May contain elevated levels of iron, chromium, nickel, molybdenum if low quality stainless steel is used	May contain elevated copper and nickel concentrations if inappropriate materials are used for the heat exchangers	Copper- MSF (15-100 mg/L)- Low acute toxicity for most species; high danger of accumulation and long term effects; bioaccumulation Only traces metals; partly natural seawater components; no toxic or long term effects (except maybe for Ni in MSF)

<i>Cleaning chemicals</i>			
<i>Cleaning chemicals</i>	Alkaline (pH 11-12) or acidic (pH 2-3) solutions with additives such as: detergents (e.g. dodecylsulfate), complexing agents (e.g. EDTA), oxidants (e.g. sodium perborate), biocides (e.g. formaldehyde)	Acidic (pH 2) solution containing corrosion inhibitors such as benzotriazole derivatives	Highly acidic or alkaline cleaning solutions that may cause toxicity without neutralization, disinfectants highly toxic at very low concentrations, detergents moderate toxicity; complexing agents very poorly degradable MSF cleaning solutions - Low pH, corrosion inhibitor - Highly acidic cleaning solutions that cause toxicity without neutralization low toxicity; poor degradability

CHAPTER 2:

Conventional Brine Treatment Methods

1. Conventional Brine Disposal

The five conventional brine management options in the United States (Table 2 & Fig.3),

1. surface water discharge (45%)
2. sewer disposal (27%)
3. deep-well injection (13%)
4. land application (8%)
5. evaporation ponds (4%)

Table 2, Most common brine disposal methods in the United States

Brine disposal method	Principle and description	% of total capacity
<i>Deep well injection</i>	Brine is injected into porous subsurface rock formations	13
<i>Land application</i>	Brine is used for irrigation of salt-tolerant crops and grasses	8

<i>Evaporation ponds</i>	Brine is allowed to evaporate in ponds while the remaining salts accumulate in the base of the pond	4
<i>Sewer discharge</i>	Discharge of brine into an existing sewage collection system. Low in cost and energy	27
<i>Seawater discharge; Surface</i>	Brine is discharged on the surface of seawater. The most common method for all big desalination facilities worldwide	45
<i>Seawater discharge; Submerged</i>	Brine is discharged off shore through multiport diffusers installed on the bottom of the sea	

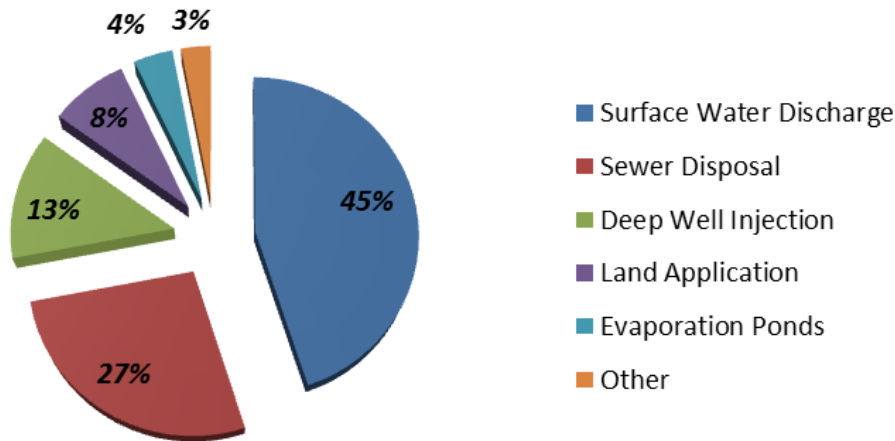

Fig.3, Most common brine disposal methods in the US

Surface water discharge is the most common alternative because it can be applied to all desalination plant sizes. Sewer disposal is the mostly applied method for the discharges of small desalination plants. Deep well injection application is most suitable for medium and large-size inland BW plants. Land application and evaporation ponds are usually applied for small and medium-size plants where the climate and soil conditions provide for high evaporation rates and year-round growth and harvesting of halophytic vegetation.

2. Comparison

The main advantages and disadvantages of the most common brine management options are presented in Table 4.

Table 4, Comparison of Brine Management Methods

Brine management method	Advantages	Disadvantages
<i>Surface water discharge</i>	<ol style="list-style-type: none"> 1. Can be used for all plant sizes 2. Cost effective for medium to large brine flow rates 	<ol style="list-style-type: none"> 1. Brine may have negative impact in the aquatic ecosystem 2. Difficult and complex permit procedures
<i>Sewer discharge</i>	<ol style="list-style-type: none"> 1. Low construction and operation costs 2. Easy to implement 3. Low energy consumption 	<ol style="list-style-type: none"> 1. Limited to small size brine flows 2. Potential adverse effects on WWTP operations
<i>Deep well injection</i>	<ol style="list-style-type: none"> 1. Suitable for inland desalination plants 2. Moderate costs 3. Low energy consumption 	<ol style="list-style-type: none"> 1. Possible only if deep confined saline aquifer is available 2. Potential groundwater pollution
<i>Evaporation ponds</i>	<ol style="list-style-type: none"> 1. Easy to construct and operate 2. Inland and coastal use 	<ol style="list-style-type: none"> 1. Limited to small brine flows 2. High footprint and costs
<i>Land Application</i>	<ol style="list-style-type: none"> 1. Easy to implement and operate 2. Inland and coastal use 	<ol style="list-style-type: none"> 1. High footprint and costs 2. Limited to small plants

2.1 Cost Comparison

Table 5, presents the construction costs for 40,000 m³/day BWRO and SWRO desalination plants at 80% recovery - 10,000 m³/d brine and 45% recovery - 48,900 m³/d brine respectively.

Table 5, Construction Costs for brine disposal methods of theoretical 40,000 m³/ day desalination plant

Brine Disposal Method	BWRO (\$ mm)	SWRO (\$ mm)
<i>Surface water discharge</i>	2-10	6.5-30
<i>Sewer discharge</i>	0.5-2	1.5-6
<i>Deep well injection</i>	4-8	15-25
<i>Evaporation Pond</i>	30-50	140-180

<i>Spray Irrigation</i>	8-10	30-40
-------------------------	------	-------

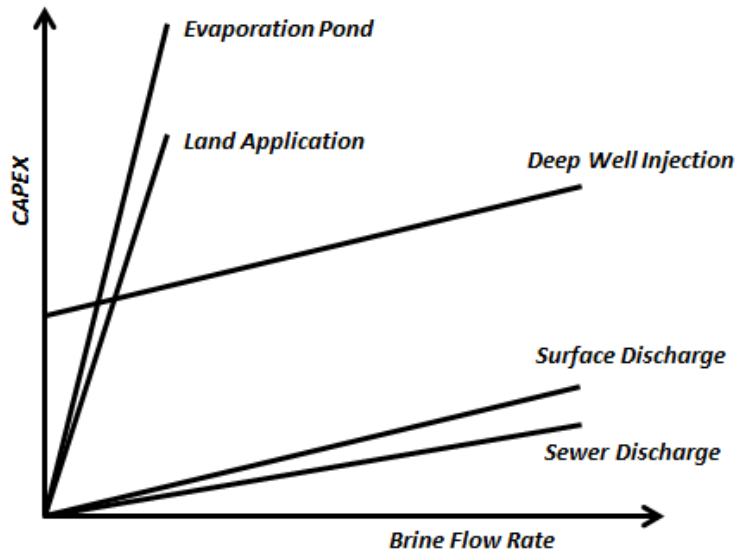

Fig. 4, Rough brine conventional disposal methods cost comparison

3. Regulatory legislations

Typically brine discharge to the sewer (limited to small brine flows) or to surface waters (sea, ocean, or river) are entailed better in legislations due to their common use. Lined evaporation ponds with a leakage monitoring system usually are easier to get a permit rather than land application (RIB disposal and spray irrigation) because it is more protective of local aquifers.

4. Implementation

The duration of construction of some brine disposal systems, like for example long ocean outfalls with complex diffuser structures, is often the same to the construction time of the desalination plant itself and involves prolonged environmental studies and regulatory review. Also the RIBs and deep injection wells involve detailed and often six-month to one-year-long studies of site suitability and constraints. Discharge to a sanitary sewer is usually the easiest way to implement a concentrate management alternative.

5. Footprint

The smallest site typically belongs to sewer discharge and evaporation ponds usually have the largest site requirements.

6. Reliability and Operational Limitations

Deep injection wells are not suitable in seismic zones and require the availability of deep and high-saline-confined aquifers. The injection wells will need periodical inspection and

maintenance, which requires either a backup disposal alternative or installation of backup wells.

Shallow beach wells are not suitable when their location has high beach erosion.

Brine management options like evaporation ponds or land application may be seasonal in nature, and in this case a backup alternative is needed to improve their reliability.

7. Surface Water Brine Discharge

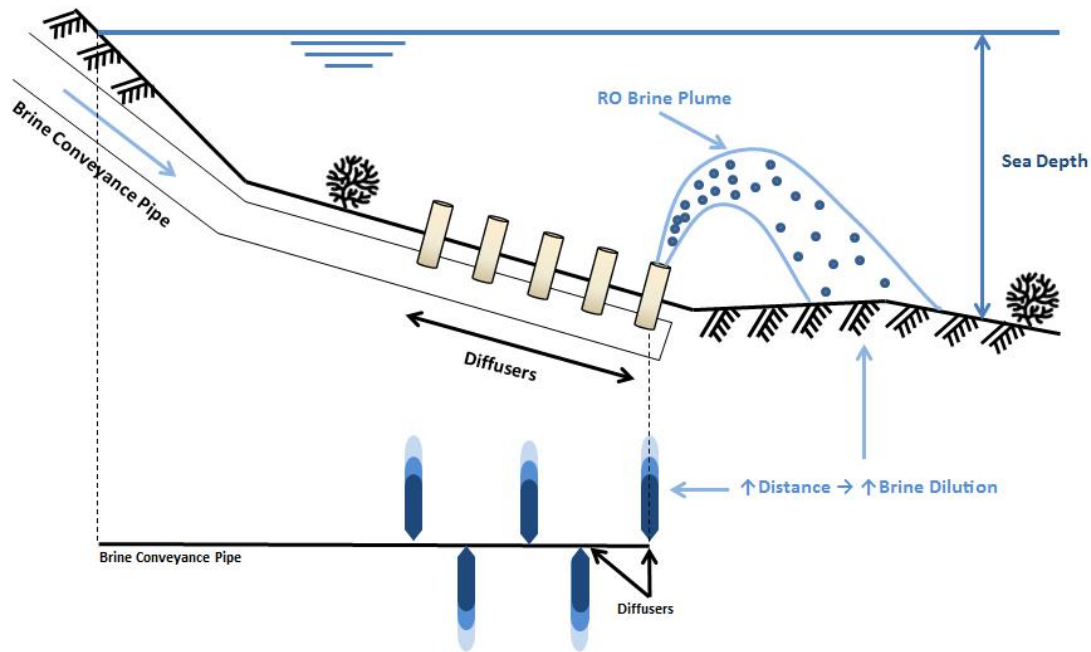

Fig. 5, Brine is discharged on the surface of seawater or off shore through multiport diffusers installed on the bottom of the sea.

The surface water brine discharge to an open water body such as,

- a bay
- a tidal lake
- a brackish canal
- an ocean

The most used methods for brine discharge to surface water bodies are,

- 1) near or off-shore direct surface discharge
- 2) discharge to wastewater treatment plant

✔ Advantages (+)	✘ Disadvantages (-)
Can be used for all plant sizes	Negative impact to aquatic ecosystem
Cost effective for medium to large brine flow rates	Difficult and complex permit procedures

Surface discharge of brine and the rest of the desalination plant waste streams (near or off-shore) is applied mainly for SW desalination projects of all sizes. More than 90% of the large SW desalination plants worldwide get rid of their brine this way like for example the 462,000 m³/day SWRO plant in Hadera, Israel, the 136,000 m³/day Tuas SW desalination plant in Singapore, the 64,000 m³/day Larnaka desalination facility in Cyprus, and the majority of large SWRO plants in Spain, Australia, and the Middle East.



The brine outfalls are designed to discharge the concentrate so as to minimize the size of the zone in which the salinity is elevated beyond the TDS tolerance of the aquatic ecosystem.

This is performed by accelerating the mixing of brine with the water of the receiving water body by,

- 1) the mixing capacity of the local tidal (surf) zone
- 2) discharging the brine beyond the tidal zone and installing diffusers at the end of the discharge pipe in order to improve mixing

Near-shore tidal zones usually have limited capacity of transporting and dissipating the high salinity load. If the salt load exceeds the capacity of the tidal zone's transport capacity, the excess salts will accumulate, resulting in a long-term salinity increase usually beyond the level of capacity of the aquatic ecosystem. The salinity mixing/transport capacity of the tidal zones can be determined using hydrodynamic modeling.

For small desalination plants ($\leq 1,000$ m³/day), the outfall is typically constructed as an open-ended pipe that extends several hundred meters into the receiving water body, relying on the mixing turbulence of the tidal zone to dissipate the brine and to reduce the salinity to ambient conditions. Most large seawater desalination plants usually extend their brine discharge beyond the tidal zone and equip their pipes with diffusers in order to provide the necessary mixing that will prevent the heavy saline plume from accumulating at the ocean bottom, taking into consideration hydrodynamic of the site-specific conditions.

7.1 Potential Environmental Impacts

The main issues for an appropriate location for a brine discharge system are,

- 1) find an area with no endangered species and stressed aquatic ecosystems
- 2) find a location with strong underwater currents that allows for fast and efficient dissipation of the high salinity discharge
- 3) avoid areas with ships traffic that could damage the brine discharge system and alter the mixing patterns
- 4) identify a discharge location in relatively shallow waters and close to the shoreline so as to minimize the construction costs

Key environmental related issues associated with brine disposal to surface waters include,

- 1) salinity tolerance of the local aquatic ecosystem
- 2) raising the concentration of some water constituents to damaging levels
- 3) discoloration and low oxygen content

The feasibility evaluation of a brine disposal to a surface water body include the following key issues

- 1) assessment of the discharge plume's dispersion and recirculation
- 2) evaluation of the discharge toxicity
- 3) evaluation of whether the discharge water quality meets the water quality standards by the relative regulatory agencies
- 4) assessment of the local aquatic ecosystem salinity capacity in order to design the discharge within a minimal distance

7.2 Potential SWRO Brine Treatment Requirements

Typically, SW desalination brine from open ocean intakes does not require treatment prior to discharge. Due to the fact that its ion composition is similar to that of that of the discharge ocean area and therefore does not usually pose an ion-imbalance threat to the local ecosystem. The brine then is discharged using a diffuser system or is blended with source seawater down to a salinity level that is safe for direct discharge (usually $\leq 40,000$ mg/L) without need for further diffusion.

However if we use a well to collect feed seawater, the desalination concentrate may be discolored due to an increased concentration of iron, have a low concentration of oxygen or contain constituents that arise the need of treatment prior to discharge in the ocean.

Feed seawater collected from alluvial coastal aquifers by beach wells may contain high levels of iron (Fe) and manganese (Mn) in reduced form. In RO pretreatment the feed is kept without exposure to air or oxygen, which keeps Fe and Mn in a dissolved reduced form in which they are colorless. RO membranes easily reject the dissolved ions and they are retained in the desalination brine. If this concentrate is exposed to air, iron will convert from reduced form (typically ferric sulfide, Fe_2S_3) to oxidized form (ferric hydroxide, $\text{FeO}(\text{OH})$). $\text{FeO}(\text{OH})$ has red color and it can degrade the visual appearance of the discharge area. So Fe in the feed water in reduced form needs to be oxidized and removed in the pretreatment system or the brine needs to be treated by sedimentation to remove the $\text{FeO}(\text{OH})$.

Also a large brine discharge with low-Dissolved Oxygen (DO) could cause oxygen depletion and stress to the local aquatic ecosystem. In such a case the brine has to be re-aerated.

7.3 Surface Water Discharge Costs

The costs for construction of surface water brine discharge are a function of the following site-specific factors,

- 1) brine discharge flow rate
- 2) near or off- shore discharge
- 3) materials of construction
- 4) complexity of the discharge diffuser system
- 5) costs of conveying the brine from the desalination plant to the surface water discharge outfall
- 6) brine treatment costs (if needed)
- 7) environmental monitoring of the discharge

We also have to take into consideration installation costs of the outfall pipeline above or below ground which will have affect the overall cost. Unusual ground conditions can significantly increase the cost of pipeline system installation. Underwater trenching is usually 3 to 5 times more expensive than trench excavation on dry land. So instead of installing the outfall in a trench, it is often laid down on the ocean bottom and secured by concrete blocks located at every 5 to 10 m along the entire outfall length.

The costs for concentrate conveyance are proportional to the brine flow rate and the distance between the desalination plant and the discharge outfall. The outfall construction costs, the outfall size and the diffuser system configuration (which is affected by the 1) brine volume, 2) salinity and 3) hydrodynamic conditions) are site-specific.

A rough approach for the construction costs for near-shore ocean discharges as a function of the brine flow rate is presented on Figure 6. Figure 7 depicts the unit construction cost of HDPE

pipeline and of concrete tunnel outfalls in US\$/linear meter of outfall length without incorporating the costs of brine conveyance from the desalination plant to the outfall structure, for brine treatment (if such needed) or for offshore monitoring of the discharge. Environmental monitoring costs may be significant, especially if the discharge is in an environmentally sensitive area.

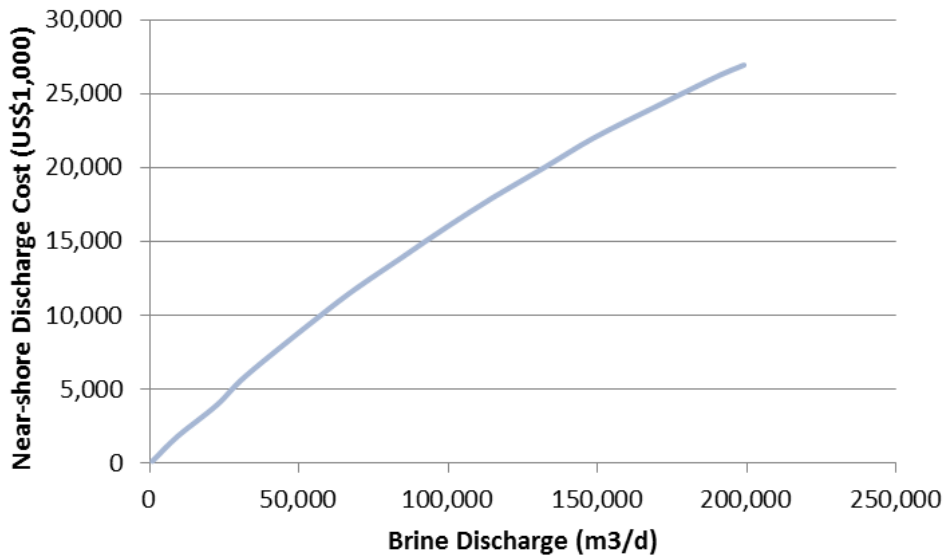

Fig.6, Construction costs of near-shore brine discharge

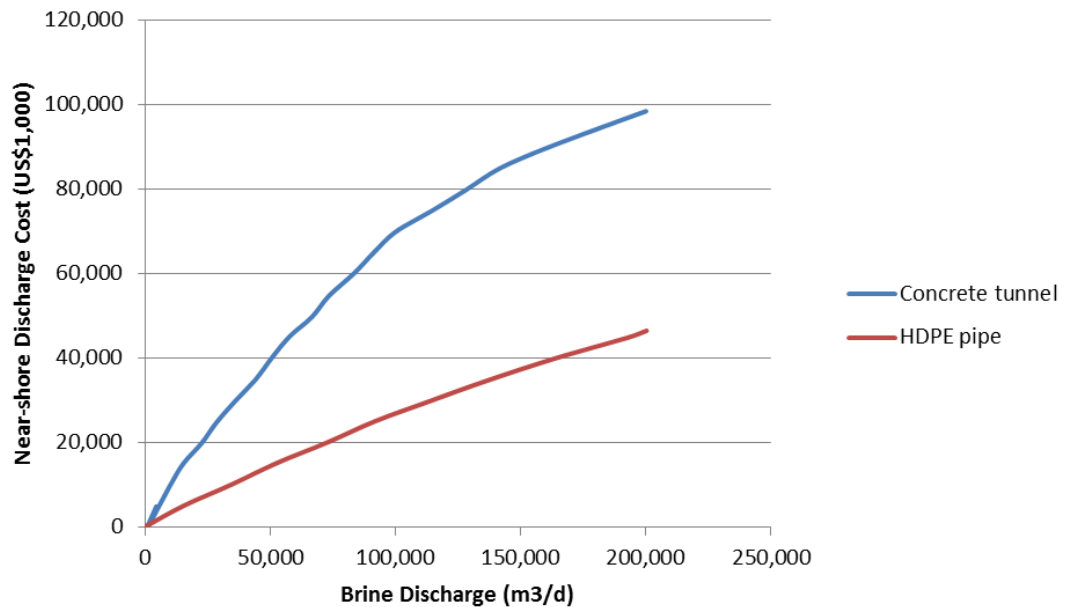

Fig.7, Near-shore brine discharge costs

Typically near-shore discharges are the least expensive option. A HDPE outfall of the same size is <30% more expensive and an underground tunnel is even more costly.

8. Brine Co-Disposal with Wastewater Effluent

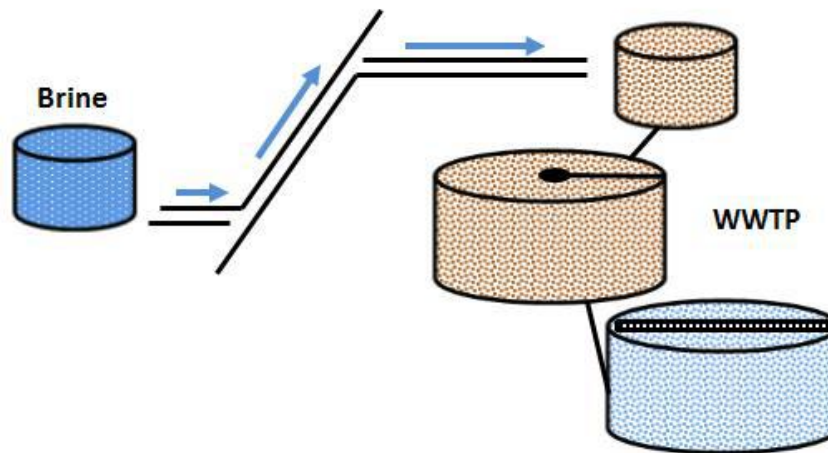

Fig. 8, Discharge of brine into an existing sewage collection system

Brine discharge to the nearest wastewater system is only suitable for small volumes into large-capacity WWTPs, due to the potential impact of the brine’s high TDS to the WWTP operations. In most countries, brine discharge to a WWTP is regulated by the requirements applicable to industrial discharges of the responsible authority.

✔ Advantages (+)	✘ Disadvantages (-)
Low construction and operation costs	Limited to small size flows
Easy implementation	Potential adverse effects to WWTP operations
Low Energy Consumption	/

8.1 Potential Environmental Impacts

Desalination plant discharge to a sanitary sewer could potentially have environmental impacts similar to those of co-discharge of concentrate and WWTP effluent.

8.2 Impact on Wastewater Treatment Plant Operations

This brine disposal method is limited by the hydraulic capacity of the WW collection system and the capacity of the WWTP processes.

A WWTP biological treatment process is usually constricted by high salinity (TDS > 3000 mg/L). So the WWTP's salinity tolerance must be assessed before discharging the desalination plant brine to the sewer. Accounting for the influent TDS being ≥ 1000 mg/L in many facilities located along the ocean coast, and that the SWRO brine TDS is $\geq 65,000$ mg/L, the WWTP's capacity has to be 30 to 35 times higher than the daily volume of brine discharge so as to maintain the influent TDS concentration <3000 mg/L.



8.3 Effect on Water Reuse

If there's reuse of the WWTP's effluent, the brine intake is limited by,

- 1) its salinity
- 2) the concentrations of sodium, chlorides, and boron

These constituents could severely impact the reuse of the WWTP effluent especially if it is used for irrigation due to the treatment processes of a typical WWTP not removing a sizeable amount of these contaminants. Although there are crops and plants that have >1,000 mg/L TDS tolerance, most plants cannot tolerate chloride levels > 250 mg/L. Typical WWTP effluent has chloride levels ≤ 150 mg/L, while SW brine could have > 40,000 mg/L.

8.4 Costs for Brine Sewer Discharge

Brine sewer discharge is typically the lowest-cost disposal method, especially if there's already a wastewater collection system is available near the desalination plant site, and the WWTP can manage the brine intake.

Conditions and therefore costs are site-specific, and the main costs are for the discharge conveyance (pump station and pipeline) and the fees for connecting to the sewer and for the treatment/disposal (can vary from very low to several orders of magnitude larger than the conveyance costs).

9. Brine Deep Well Injection

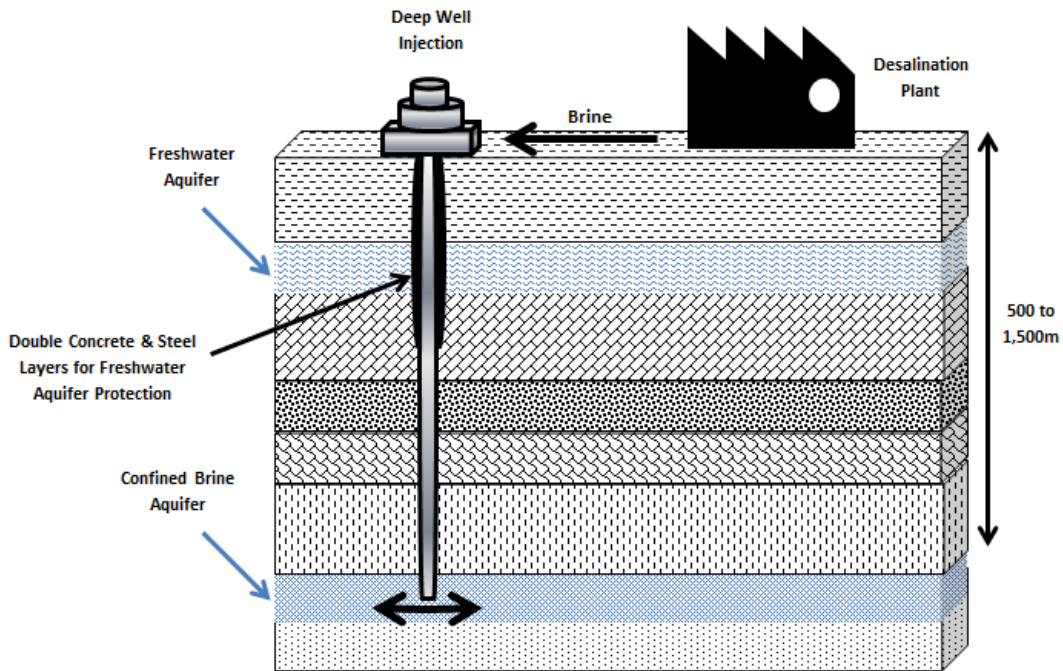

Fig. 9, Brine is injected into porous subsurface rock formations

In this the desalination brine from every plant size is injected into an adequate deep underground aquifer (500 to 1500 m) that is separated from freshwater or BW aquifers above.

Brine disposal wells typically consist of three or more concentric layers of pipe: surface casing, long string casing, and injection tubing. A deep injection well consists of a wellhead (equipped with pump, if needed) and a lined well shaft protected by multiple layers of casing and grouting.

Shallow exfiltration beach well systems could also be used. Beach well disposal discharge the brine into a relatively shallow unconfined coastal aquifer that ultimately conveys the brine into the open ocean through the bottom sediments. Discharge beach wells are mainly used for small to medium size SW desalination plants.

✔ Advantages (+)	✘ Disadvantages (-)
Suitable for inland plants	Only if confined saline aquifer available
Moderate Costs	Potential groundwater contamination
Low Energy Consumption	/

9.1 Potential Environmental Impacts

From the 20 year experience of brine disposal with the deep well injection method in the United States, it has proven to be reliable with a low probability of negative effects for the environment. But during the planning of its implementation, we should pay attention to the following factors that might allow for upward migration of the brine and possible contamination of shallow aquifers,

- 1) corrosion or excessive feed pressure could result in a failure of the injection well casing and leaking of the brine through the well bore
- 2) vertical propagation of the brine outside of the well casing to the shallow aquifer
- 3) if the overlying confining bed has high permeability, solution channels, joints, faults, or fractures we'll have vertical brine migration
- 4) nearby wells, which are inappropriately cemented or plugged or have an inadequate casing could provide a pathway for the injected brine

During the well operation there's a continuous monitoring of brine flow and the wellhead pressure. Increasing pressure during steady operation could indicate possible clogging, while a sudden decrease in pressure is indicative of leaks within the casing, grout, or seal. We must also ensure with monthly testings that the well is not leaking into underground soils or water sources. Plugging, contamination, and wide



variations in brine flow rates and pressures should be avoided. Plugging can be due to bacterial growth, suspended solids precipitation or entrained air.

9.2 Criteria and Methods for Feasibility Assessment

In order to apply a deep well injection systems for brine disposal we must have confined aquifers of large storage capacity with good soil transmissivity. We must avoid areas of high seismic activity or sites near geologic faults that can result in a direct hydraulic connection between the storage and a freshwater aquifer.

Usually legislation permits will need the storage aquifer's transmissivity and TDS, the presence of a structurally isolating and confining layer between the receiving aquifer, and the presence of overlying with < 10,000 mg/L TDS.

9.3 Injection Well Costs

Deep injection well costs are mainly influenced by the well depth and the diameter of the well tubing and the casing rings. The following table gives a rough approach of the construction costs for deep injection wells as a function of brine discharge flow (m^3/d) and well depth (m).

Table 6, Construction Costs of Brine Disposal Deep Injection Wells

Well Diameter (m)	Typical Discharge Capacity (m^3/d)	Construction Costs (\$) as a function of Brine Flow Rate, Q (m^3/d) and Well Depth, H (m)
100	1,000-2,000	$165 \times Q + 310 \times H + 100,000$
200	4,500-6,500	$180 \times Q + 1,250 \times H + 160,000$
300	10,000-15,000	$165 \times Q + 2,000 \times H + 290,000$
400	15,000-30,000	$160 \times Q + 2,800 \times H + 330,000$
500	30,000-50,000	$150 \times Q + 4,500 \times H + 370,000$

10. Brine Evaporation Ponds

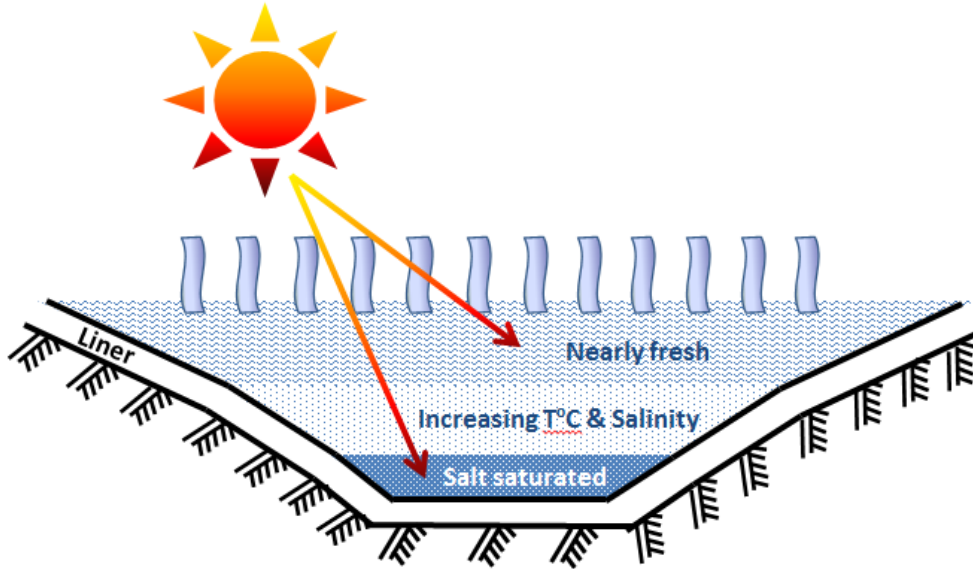



Fig. 10, Brine is allowed to evaporate in ponds while the remaining salts accumulate in the base of the pond

Evaporation ponds are shallow, lined earthen basins in which concentrate evaporates naturally as a result of solar irradiation. As fresh water evaporates from the ponds, the minerals in the concentrate are precipitated in salt crystals, which are harvested periodically and disposed off-site. Evaporation ponds could be classified as,

 Advantages (+)	 Disadvantages (-)
Easy implementation and operation	High footprint and costs
Inland and coastal use	Limited to small plants

- 1) conventional
- 2) solar salinity gradient

Conventional evaporation ponds are designed solely for brine disposal, while solar ponds generate electricity from solar energy.

10.1 Potential Environmental Impacts

Usually quality regulations demand for the evaporation ponds to be constructed with impervious lining for the protection of underlying aquifers. If the brine contains high concentrations of toxic contaminants (e.g. high levels of trace metals), then a double-lined pond may need to be constructed.

If the ponds are not lined or the point liner is damaged, a portion of the brine may percolate to the water aquifer beneath the pond and deteriorate its water quality. So an underground leak-detection systems that are installed beneath the liner or use a minimum 3 groundwater monitoring well system, one installed up-gradient to the groundwater flow, one down-gradient, and one in the middle of the pond system with monthly readings.



10.2 Criteria and Methods for Feasibility Assessment

Evaporation ponds are climate dependent with higher local temperature and solar irradiation providing us with higher evaporation rates and making this brine disposal option more viable. In general solar evaporation is a feasible only in relatively warm, dry climates with,

- 1) high evaporation rates
- 2) low precipitation rates
- 3) low humidity

We also need a flat terrain and low land cost. This brine disposal method isn't applicable for regions with an annual evaporation rate < 1.0 m/y and annual rainfall rate >0.3 m/y (high rainfall rate reduces evaporation rates).

The higher the humidity, the lower the evaporation rate. When the average annual is $>60\%$, evaporation ponds aren't a viable brine disposal option.

Evaporation rate decreases as solids and salinity levels in the ponds increase so minimization of brine volume is beneficial.

10.3 Evaporation Pond Costs

The main factors affecting the cost of evaporation ponds are,

- 1) the evaporation rate (local climate)
- 2) brine volume and salt concentration
- 3) land and earthwork costs
- 4) liner costs

Figure 11 gives a rough approach for the construction cost of an evaporation pond system as a function of the evaporation rate and the concentrate flow.

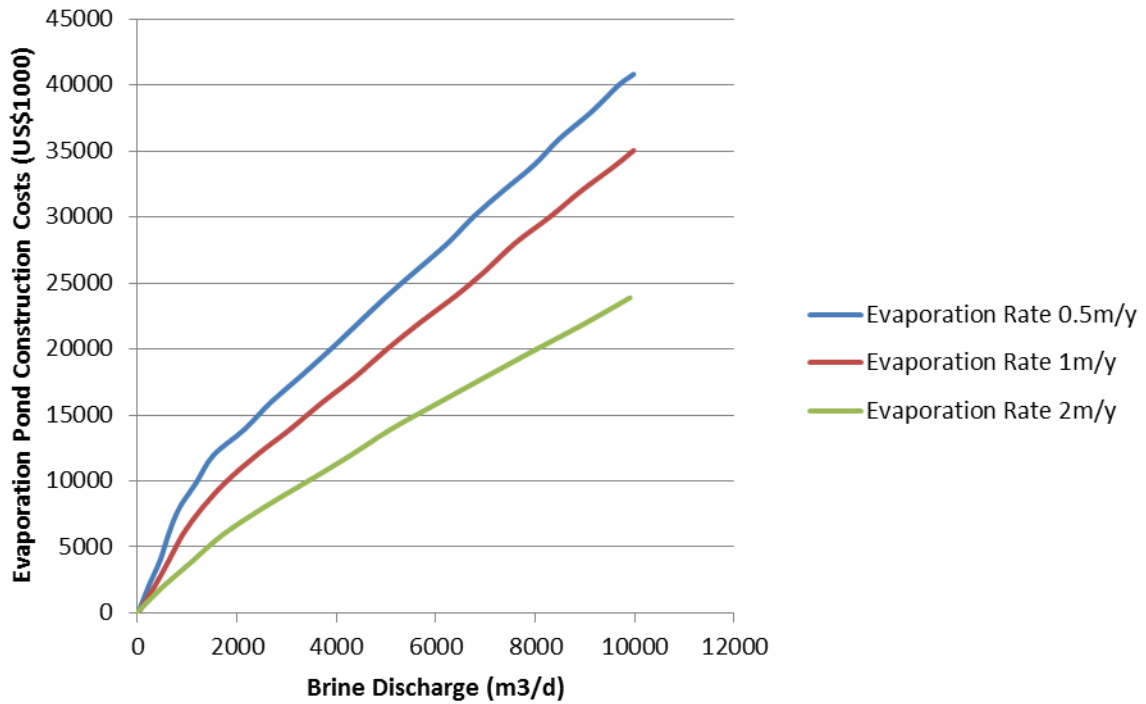

Figure 11, Construction cost for an evaporation brine disposal pond system

11. Brine Land Application

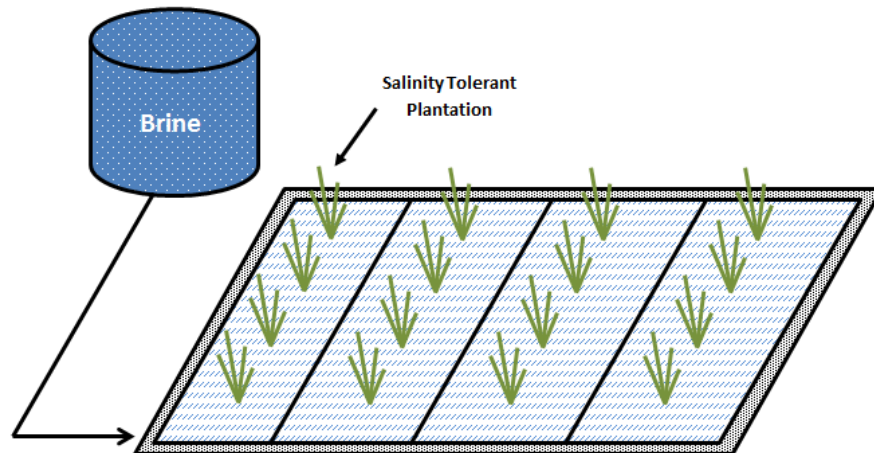

Fig. 12, Brine is used for irrigation of salt-tolerant crops and grasses

Disposing brine with the land application method is usually applied for small size desalination plants and its application is constricted by climate, seasonal application and the existence of available land and groundwater conditions. The method has two available pathways,

- 1) spray irrigation of brine on salt-tolerant plants
- 2) infiltration of brine through earthen rapid infiltration basins (RIBs)

11.1 Potential Environmental Impacts

11.1.1 Irrigation

Brine irrigation may affect negatively the underlying groundwater aquifer and due to the fact that shallow groundwater aquifers which are usually of lower salinity. Exceptions are shallow saline coastal aquifers or deep confined aquifers isolated from direct or indirect interaction with the concentrate.



11.1.2 Rapid Infiltration

Disposal of brine with infiltration will usually have problems getting a permit if the concentrate contains arsenic, nitrates, or other contaminants regulated in drinking water. An option, if allowed, is to dilute it to meet the desired standards. Monitoring wells are employed to assess the RIB systems impact on groundwater aquifers.

11.2 Criteria and Methods for Feasibility Assessment

The main feasibility factors for the use of land application for concentrate disposal are,

- 1) climate
- 2) availability and cost of land
- 3) percolation rate
- 4) irrigation needs
- 5) water-quality of the underlying groundwater aquifers
- 6) salinity tolerance of the irrigated vegetation
- 7) the ability of the land application system operation to comply with pertinent regulatory requirements and groundwater quality standards

For successfully using the method there must be an available low cost site near the desalination plant with relatively low ground water level and a warm, dry climate. In cold climate conditions and for specific vegetation, we may need to use storage tanks may during the period when the brine cannot be applied (usually 2 to 6 months) or have a backup disposal option.

As the brine salinity increases, it's becoming more difficult to use land application for brine disposal so in many cases the brine has to be diluted in order to meet the quality constraints and/or vegetation salinity tolerance limits. Typically we use wastewater effluent or low-salinity water extracted from shallow aquifers.

Soil type is also of high importance with loamy and sandy soils being usually suitable. Neutral and alkaline soils are preferable because they minimize trace metal leaching. Sites with a groundwater level lower than 2m are preferred. If site groundwater level is less than 3m from the surface, then a drainage system is needed. Typically slopes of up to 20% are suitable for land application.

CHAPTER 3: ZLD

Fundamental Design

1. What is ZLD?

Zero Liquid Discharge (ZLD) is a treatment process that its goal is to remove all the liquid waste from a system. The focus of ZLD is to reduce economically wastewater and produce clean water that is suitable for reuse.

ZLD technologies consist traditionally from brine concentrators and crystallizers that use thermal evaporation to turn the brine into highly purified water and solid dry product ready for landfill disposal or for salt recovery. While evaporator/crystallizer systems are the most commonly used in ZLD processes, other promising technologies (ED/EDR, FO and MD which will be explained later) with high recoveries have taken foothold and are used in different combinations in order to lower the cost and raise the efficiency of the systems.

The increasingly tighter government regulations on the discharge of brine due to the environmental effect make ZLD necessary when water is scarce or the local water bodies are protected by law. Thus many industrial facilities and brine effluent contributors that up to now where either discharging brine to nearby available surface water or the sea and to wastewater treatment plants, are trying to find new ways to tackle this issue.

2. Drivers

The industrial involvement with brine is twofold. Many industrial processes require water which they contaminate and releasing it may cause irreversible damages to the local environment.

In India and during the last decade due to heavy contamination of local waters by industrial wastewater was followed by strict regulations that make ZLD necessary in order to ensure the future of their rivers and lakes. In Europe and North America, the drive towards zero ZLD has been applied due to the high costs of wastewater disposal at inland facilities. These costs increase exponentially by government fines and the costs of disposal technologies.

ZLD can also be used to recover valuable resources from the wastewater which can be sold or reused in the industrial process. Some examples are as follows,

- Generation of valuable potassium sulfate (K_2SO_4) fertilizer from a salt mine
- Concentration of caustic soda (NaOH) to 50 and 99% purity
- Recovery of pure, saleable sodium sulfate ($NaSO_4$) from a battery manufacturing facility
- Reduction of coal mine wastewater treatment costs by recovering pure sodium chloride (NaCl) which can be sold as road salt
- Lithium (Li) has been found in USA oil field brines at almost the same level as South American salars
- Gypsum ($CaSO_4 \cdot 2H_2O$) can be recovered from mine water and flue gas desalinization (FGD) wastewater, which can then be sold to use in drywall manufacturing

Other advantages to the application of ZLD are:

- ✓ Decreased volume of wastewater lowers the costs of waste management.
- ✓ Recycling water on site thus decreasing the need for water intake and meeting with treatment needs.
- ✓ Reduce the truck transportation costs for off-site disposal and the related environmental risks.
- ✓

Table 6, ZLD Drivers

1. Meeting tight brine disposal government regulations
2. Recovery of valuable materials in the waste streams

3. Decreased waste volumes and management costs
4. Recycling water on-site
5. Reducing truck costs for off-site disposal

3. Applications

There is a wide diversity of sources for discharge flow streams that include:

- ❖ Cooling tower blowdown in heavy industry and power plants
- ❖ Ion exchange regenerative streams particularly in food and beverage processing
- ❖ Flue gas desulfurization, wet wastewater stream
- ❖ Municipal potable water systems, wastewater streams
- ❖ Process water reuse from agricultural, industrial and municipal streams
- ❖ Various industrial wastewater streams from the textile, coal-to-chemical, food and dairy or battery industries

More in particular, we can refer to the following applications (Table 7),

Table 7, ZLD Wastewater Stream Applications

Membrane System Reject (NF, MF, UF, RO)	Mine Drainage
Flue Gas Desulfurization (FGD) Blowdown / Purge	Refinery, Gas to Liquid (GTL), and Coal to Chemical (CTX) Wastewaters
Produced Water (Conventional, Fracking, SAGD)	Scrubber Blowdown
NO_x Injection Water	Demineralization Waste
Integrated Gasification Combined Cycle (IGCC) Gray Water	Landfill Leachate

The discharge sources can be further categorized according to volume and complexity. A ZLD solution must take the latter into consideration along with the location of the waste stream.

4. Determining Factors

The most important factors that determine the ZLD design depend on,

1. The specific contaminants in the discharge stream
2. The volume of the dissolved material
3. The required design flow rate

The contaminants of concern are presented in Table 8,

Table 8, Typical Chemical Constituents of Concern

Sodium (Na^+)	TDS/TSS	Phosphate (PO_4^{3-})	Strontium (S^{2+})	Sulfate (SO_4^{2-})
Potassium (K^+)	COD/TOC/BOD	Ammonia (NH_3)	Oil & Grease	Fluoride (F^-)
Calcium (Ca^{2+})	pH	Boron (B^+)	Barium (Ba^{2+})	Nitrate (NO_3^-)
Magnesium (Mg^{2+})	Chloride (Cl^-)	Alkalinity	Silica	-

These parameters need to be accurately measured before requesting a quote in order so as to get an accurate estimation of the system's cost. If the feed is prone to changes in flow and the concentration of the contaminants, inlet buffering tanks regulate the peaks.

5. Operation costs

Each technology that makes up the ZLD chain has a certain purchasing cost, but an important parameter for calculating the costs and eventually the payback period are the operating costs. The OPEX can change drastically based on what process is selected especially for electrical power and steam-generating facilities. For a long term investment the benefits and drawbacks

Brine Treatment Technology	Electrical Energy (KWh/m ³)	Thermal Energy (KWh/m ³)	Total El. Equivalent (KWh/m ³)	Typical Size (m ³ /d)	Investment (\$/m ³ /d)	max TDS (mg/L)
MSF	3.68	77.5	38.56	<75,000	1,800	250,000
MED	2.22	69.52	33.50	<28,000	1,375	250,000
MVC	14.86	0	14.86	<3,000	1,750	250,000
ED/EDR	6.73	0	6.73	/	/	150,000
FO	0.475	65.4	29.91	/	/	200,000
MD	2.03	100.85	47.41	/	/	250,000

of each choice have to be weighed as well as what works better for each company and their working staff. This will help to get an initial versus a long-term cost investment.

Table 9, Specific Energy Consumptions (SECs) of Brine Treatment Technologies, Multistage Flash (MSF), Multi-Effect Distillation (MED), Mechanical Vapor Compression (MVC), Electrodialysis (ED/EDR), Forward Osmosis (FO), Membrane Distillation. The energy consumption values are the average of 13 comparative studies on ZLD technologies ranging from 2004 -2107. Clarifications are needed for ED/EDR, FO and MD. 1) ED/EDR SEC depends on the salinity of the feed as higher salinities require higher SECs, 2) FO SEC depends on the Draw Solution and the Regeneration Method. Most papers assume the use of thermolytic salts and their regeneration at a 60°C temperature. 90% of the thermal energy needed can be acquired by waste heat if it's available, 3) MD SEC depends on the configuration. Most common MD configuration in the studies is Direct Contact MD (DCMD) due to its simplicity. 90% of the thermal energy needed can be acquired by waste heat if it's available and finally 4) the total electrical equivalent was taken using the following, Total El. Equivalent = El. Energy + 0.45 x Thermal Energy due to modern power plant efficiency (according to relevant paper).

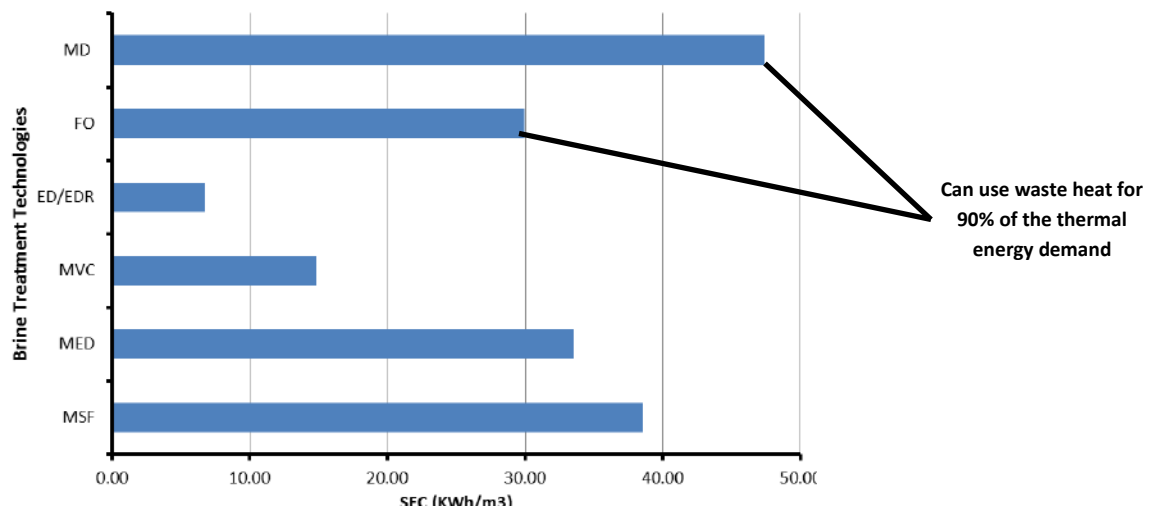

Fig.12 Brine Treatment Technologies SECs graph comparison (see clarifications in the description of table 4)

On a last note for a cost benefit analysis you must always take into consideration factors like,

- 1) Taxes or additional purchasing fees
- 2) Possible utility costs in the installation area
- 3) Environmental regulatory fees or permits
- 4) Regular compliance testing

6. Basic Design - ZLD Blocks

Despite the variable sources of a wastewater stream, a ZLD system is generally comprised by two steps which are represented in Figure 13.

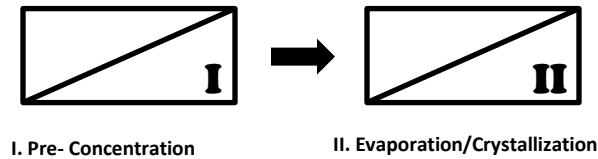

Fig.13, ZLD Basic Blocks

1. **Pre-Concentration;** Pre-concentrating the brine is usually achieved with membrane brine concentrators or electrodialysis (ED). These technologies concentrate the stream to a high salinity and are able to recover up to 60–80% of the water.
2. **Evaporation/Crystallization;** The next step with thermal processes or evaporation, evaporates all the leftover water, collect it, and drives it for reuse. The waste that is left behind then goes to a crystallizer which boils all the water until all the impurities crystallize and are filtered out as a solid.

6.1. Pre-concentration

The pre-concentration of the liquid waste stream is a very important step due to the fact that it reduces the volume of the waste and downsizes significantly the very costly evaporation/crystallization step. Usually it is achieved with electrodialysis (ED) or membrane processes which consist of Forward Osmosis (FO) and Membrane Distillation (MD) (Figure 13).

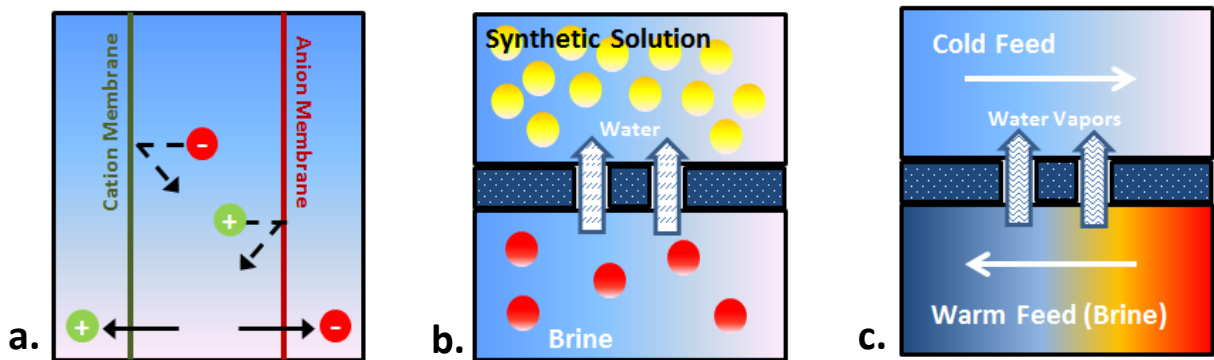

Fig.13, Brine treatment technologies, (a) Electrodialysis, (b) Forward Osmosis, (c) Membrane Distillation

ED, FO and MD can function efficiently with a much higher salinity content than RO (150,000 ppm, 200,000 ppm, 250,000 ppm and 70,000 ppm respectively).

6.1.1. Electrodialysis/ Electrodialysis Reversal

Electrodialysis is a membrane process that uses electrodes to create an electric field which pushes negative and positive ions through semipermeable membranes with attached positively or negatively charged species respectively. ED is used in multiple stages to concentrate the brine to saturation levels. It is often used together with RO for very high water recovery. ED

differs from RO because it removes the ions and not the water and vice versa for RO. Due to this fact silica and dissolved organics are not removed with ED which is important if the clean stream is to be reused. ED requires solids, as does RO, solids and organics removal from the feed.

Electrodialysis reversal (EDR)

In EDR the polarity of the electrodes is reversed several times an hour and the fresh water and the concentrated wastewater are exchanged within the membrane stack to remove fouling and scaling.

6.1.2. Forward Osmosis

FO is an osmotic membrane process with a semipermeable membrane that unlike RO doesn't use applied pressure in order to achieve separation of water from dissolved solutes like ions, molecules and larger particles. That means a lot less of energy for the process in comparison to RO. In general FO uses thermal and electrical energy. Thermal energy can be substituted with low grade waste heat which can be found everywhere in most industrial or nearby areas.

6.1.3. Membrane Distillation

MD is a thermally driven transport process that uses hydrophobic membranes. The driving force in the method is the vapor pressure difference between the two sides of the membrane pores, allowing for mass and heat transfer of the volatile solution components (e.g. water). The simplicity of MD along with the fact that it can use waste heat and/or alternative energy sources, such as solar and geothermal energy, enables MD to be combined with other processes in integrated systems, making it a promising separation technique.

6.1.4 The importance of Pre-Concentration in a ZLD Process

The pre-concentration technologies have very high recoveries but usually not enough like the typical thermal evaporation technologies to drive the brine into saturation concentration levels. So why are they so important? The reason is the CAPEX/OPEX of the evaporators/crystallizers. 1) Due to the corrosive nature of the brine it takes more and more resistant metal alloys in order to resist corrosion as the concentration rises. That means that the bigger is the evaporation/crystallizer module, the bigger will be the CAPEX required (which can be 60-70% of the whole process). 2) High energy demand due to the rise of the boiling point of the brine as concentration goes higher. Both points will be explained more analytically in the evaporation/crystallization Lenntech webpages.

Let’s try to formulate a visual example of the situation. Let’s suppose that we have 100 m³/d brine and we want to treat it with a MD-MVC-Crystallizer combination. Let’s suppose that we have (rough approaches from available values in related papers),

- MD (75% recovery)/available waste heat combination → 90% of Thermal Energy can be substituted by waste heat → Energy consumption will go from 47.41 down to 6.57 KWh/m³
- MVC with 90% recovery → Average of 14.86 KWh/m³
- Crystallizer with 50% recovery → Average of 50 KWh/m³

So given all the latter date, let’s see how the brine process will play out.

100 m³ Brine → MD (-75%) → 25m³ Brine → MVC (-90%) → 2.5 m³ Brine → Crystallizer (-50%) → 1.25 m³ Brine → Driven to Centrifuge or Belt Press

This translates into 100 m³ x 6.57 KWh/m³ + 25 m³ x 14.86 KWh/m³ + 2.5 m³ x 50 KWh/m³ = 657KWh + 371.5 KWh + 125 KWh = 1,153.5 KWh/100 m³ Brine

If we hadn’t a pre-concentration step and drove straight the brine to an evaporator then the energy demand would be,

100 m³ x 14.86 KWh/m³ + 10 m³ x 50 KWh/m³ = 1,486 KWh + 500 KWh = 1,986 KWh/ 100 m³ Brine

1,986 KWh (MVC-Crystallizer)/ 1,153.5 KWh (MD-MVC-Crystallizer) = 1.72 or 172% increase to the energy consumption of the brine treatment without a pre-concentration step!

Table 10, Relative water recoveries (%) of each combination (with and without pre-concentration) along with the SECs for each technology.

	ZLD with Pre-Concentration		ZLD without Pre-Concentration	
	Recovery (%)	SEC (KWh/m ³)	Recovery (%)	SEC (KWh/m ³)
MD	75	6.57	0	0
MVC	97.5	14.86	90	14.86
Crystallizer	98.75	50	95	50

The graphical visualization of Table 10 gives us Figure 14,

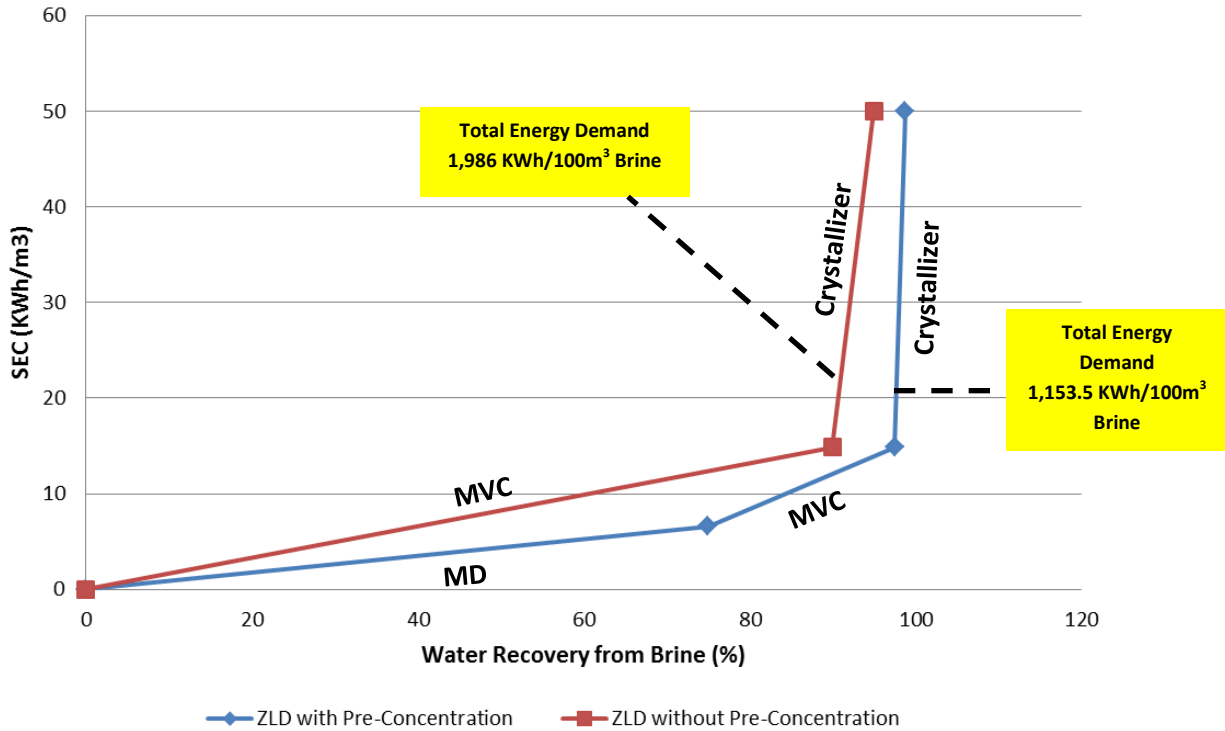

Fig.14, Relative water recoveries (%) of each combination (with and without pre-concentration) along with the SECs for each technology

So the pre-concentration step not only decreased the energy costs to less than half but also increased the recovery availability of the system. Not to mention the possible downsizing of the MVC from 100 to 25m³ and the Crystallizer from 10 to 2.5m³ which means huge savings in CAPEX/OPEX.

Here it's important that we start talking about the concept of Minimum Liquid Discharge (MLD). MLD is a high recovery system without going all the way to ZLD due to the costs and complexity related to the latter. MLD is discussed further on later.

6.2 Evaporation and Crystallization

After pre-concentration of the waste stream the next step is to use thermal processes or evaporation to generate solid and reuse the evaporated water. Evaporation is essentially heat transfer to a boiling liquid with the intent to concentrate a non-volatile solute from a solvent, which is usually water, by boiling off the solvent. The evaporation process normally stops just before the solute begins to precipitate, otherwise it is considered as crystallization.

Falling film evaporation is an energy efficient method of evaporation that concentrates the water up to the initial crystallization point (super saturation). Adding acid will neutralize the solution so, when heating it, as to prevent scaling and harming the heat exchangers. De-

7. Electrodialysis/ED Reversal

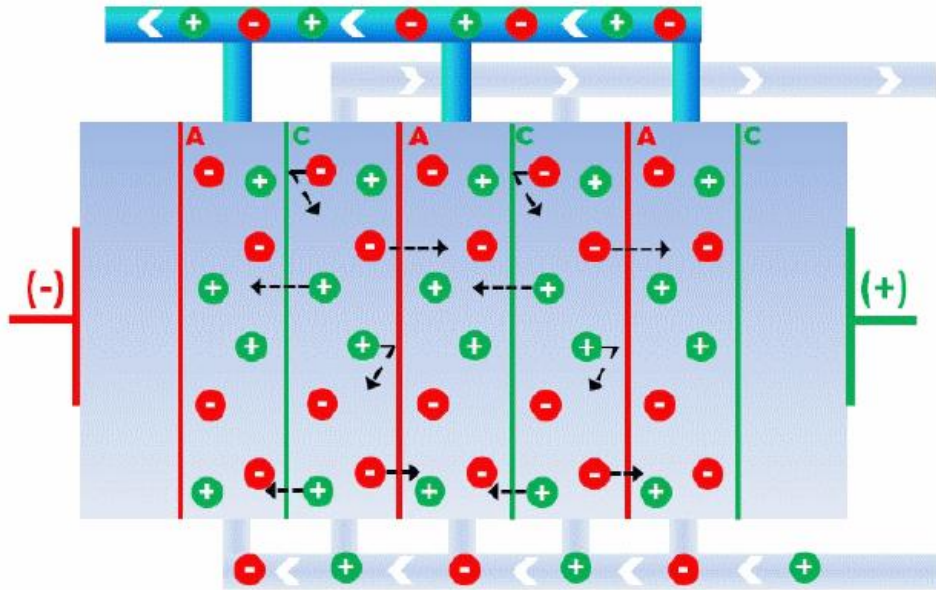

Fig.16, Electrodes create an electric field which pushes negative and positive ions through semipermeable anion and cation membranes with attached positively or negatively charged species respectively. ED is used in multiple stages to concentrate the brine to saturation levels.

Electrodialysis is a membrane process that uses alternating Anion-selective membranes (AMs) and Cation-selective membranes (CMs), placed between an Anode (+) and a Cathode (-). Due to the applied electric field, anions will move towards the Anode and cations will move towards the Cathode. Anions are stopped by the CMs and the cations by the AMs, creating a process flow with low ion concentration (Dilutant) and a process flow with high ion concentration (Concentrate).

A pair of a CM and a AM and both areas between these membranes is a Cell Pair. A Cell Pair is the basis unit of a stack, and is repeated “(n)” times. The number of cell pairs in an actual stack varies depending on the electrodialysis system, with as many as 600 cell pairs in a typical industry-scale system.

In electrodialysis suspended solids which carry

✔ Advantages (+)	✘ Disadvantages (-)
Treating >70,000 ppm (RO limit), No concentration limit	Current Density Limit
No applied Pressure → ↓ Fouling	Doesn't remove microorganisms and organic contaminants
↓ Fouling & No regeneration chemicals required → ↓ ↓ Chemicals	↑ Energy as ↑ Salt Feed Concentration
< Energy than Distillation processes (MED, MVC)	↑ CAPEX for ↓ Salt Feed Concentration
↑ Membrane life	-
↑ ↑ Recovery	-
⚡ Energy Consumption; 6.73 KWh/m ³ (high salinities require high SEC)	
<div style="display: flex; align-items: center;"> <div style="margin-right: 10px;">⚙️</div> <div> <p style="text-align: center;"><i>Applications</i></p> <ol style="list-style-type: none"> 1) Treatment of >70,000 ppm saline solution (Brine) 2) Demineralization (e.g. Boiler Feed, Food, Chemical industries) 3) Recovery of Electrolytes, Acids 4) Desalination of Industrial Wastewater for Reuse </div> </div>	

positive or negative electrical charges can increase the resistance of the membrane dramatically, are deposited on the membrane surface. However, in electro dialysis the problem has been eliminated to a large extent by reversing in certain time intervals the polarity of the applied electrical potential which results in a removal of charged particles that have been precipitated on the membranes. This technique is referred to as **electrodialysis reversal (EDR)**.

7.1 EDR Process Function

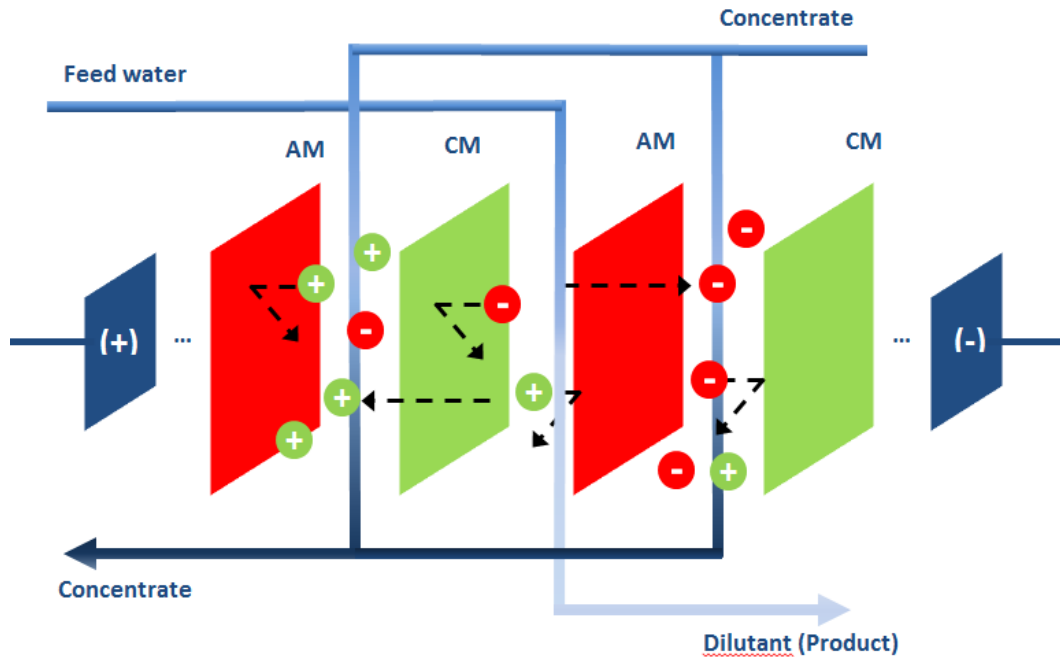

Fig.17, Schematic description of the electro dialysis reversal process

In each EDR stack there are two electrodes on the outer side which are submerged in a watery salt solution that is able to conduct electrical current and allows for an electrical field to be placed around the stack. The salt solution is pumped around in order to maintain the ion balance. Because salt solution (feed current) is also found between the ion exchange membranes, the electrical field will result in ion transport. In the spaces between electrodes, marked as “Dilutant”, the cations will diffuse through the CM to the negative electrode (cathode) while the anions will diffuse through the AM to the positive electrode (anode).

The ions leaving the dilutant feed are moving to the neighboring concentrate feed chamber which leads to a drop in concentration of ions in the dilutant chambers of the EDR process. In the concentrate chambers, the cations will try to move to the negative electrode but they will be blocked by the AM and the anions will try to move to the positive electrode but will be blocked by the CM. This leads to an increase of their respective concentrations in the concentrate chambers.

In EDR, the voltage at the electrodes is reversed every 30 - 60 min which reverses also the direction of ion transport and causes the removal from the membrane surface of electrically charged substances that may cause serious, perhaps irreparable damage. It is generally recommended to remove in advance,

- dispersed particles,
- colloid
- humus acids
- oils and fats

The average life-span of ED membranes is between 5 and 7 years.

7.2 Advantages and Disadvantages

Advantages:

EDR has advantageous characteristics that constitute it as a success. First is EDR's ability to perform at very high water recovery due to its polarity reversal which allows for treatment, without any chemicals, of feeds with concentrated salt scale factors well beyond saturation. With the addition of an antiscalant EDR pushes its salt tolerance even further.

Unlike RO, which is a pressure driven process, EDR works by flowing feed water over the surface of ion exchange membranes, while an electric field removes ions across the latter. EDR doesn't have a compact fouling layer like RO which limits its recovery efficiency.

Disadvantages:

A major drawback is that beyond a particular current density (Current Density Limit), the diffusion of ions through the EDR membranes is no longer linear to the applied voltage but leads to water dissociation (water splitting into H^+ and OH^- ions) and lowers the system's efficiency. So EDR must always operate below the current density limit. Experimental measuring procedures are available to determine the CDL for a particular feed.

Another disadvantage of EDR is that it doesn't remove microorganisms and organic contaminants, thus a post treatment is always necessary if high quality water is required.

7.3 Process Industry Applications

1. Brine Concentration
2. Demineralization (e.g. Boiler Feedwater)
3. Desalination of Industrial Wastewater for Reuse
4. Demineralization of food products
5. Recover of valuable electrolytes or acids from rinsing baths in metal (surface) treatments
6. Sectors where ions need to be removed from a process flow or must be concentrated (e.g. chemicals industry)

8. Forward Osmosis

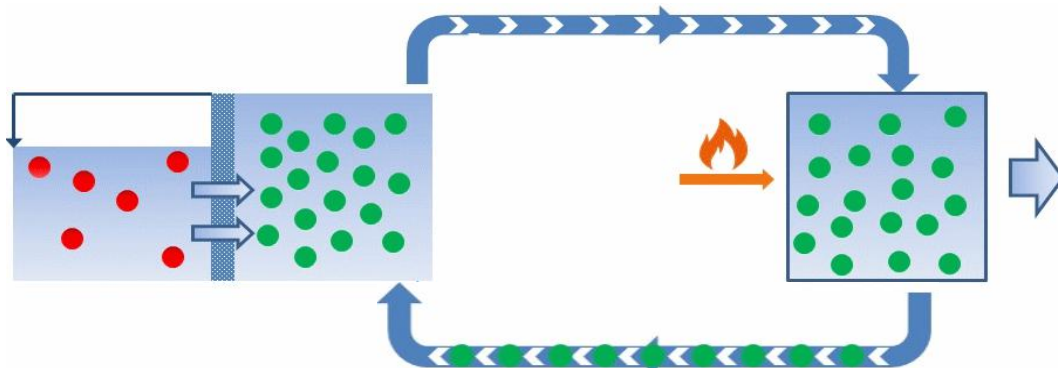

Fig.18, The Brine Solution is separated from a Synthetic Solution by a Semipermeable Membrane that allows only for water molecules to pass. The difference in concentration (Salts -red molecules << Draw Species - green molecules) creates a water flux to the Synthetic Solution. The diluted Synthetic Solution is driven to a regeneration step where the Draw Species are driven back into the process and the water is taken as product.

Forward Osmosis (FO) is an osmotic membrane process with a semipermeable membrane that unlike Reverse Osmosis (RO) doesn't use applied pressure in order to achieve separation of water from dissolved solutes like ions, molecules and larger particles. That means a lot less of energy for the process in comparison to RO. In general FO uses thermal and electrical energy. Thermal energy can be substituted with low grade waste heat which can be found everywhere in most industrial or nearby areas.

$$\text{Energy}_{\text{Forward Osmosis}} = \text{Thermal (Waste Heat)} + \text{Electrical} (\ll \text{Electrical}_{\text{Applied Pressure}})$$

✔ Advantages (+)	✘ Disadvantages (-)
Treating >70,000 ppm	Internal Concentration Polarization
↓Energy	Reverse Salt Flux
Reversible Fouling	Choosing the right Draw Solution
↓↓Chemicals	Choosing the right membrane
↑ Rejection of Boron & TrOCs	-
⚡ Energy Consumption; 29. 91 KWh/m ³ = 0.46 KWh/m ³ Electrical + 29.45 KWh/m ³ Thermal	
<div style="display: flex; align-items: center;"> <p><u>Applications</u></p> </div> <ol style="list-style-type: none"> 1) Treatment of >70,000 ppm saline solution (Brine) 2) Oil & Gas Wastewater 3) Heavy Metal Wastewater (Mining & Metallurgy) 4) ↑ Organic WW (e.g. Landfill Leachate) 	

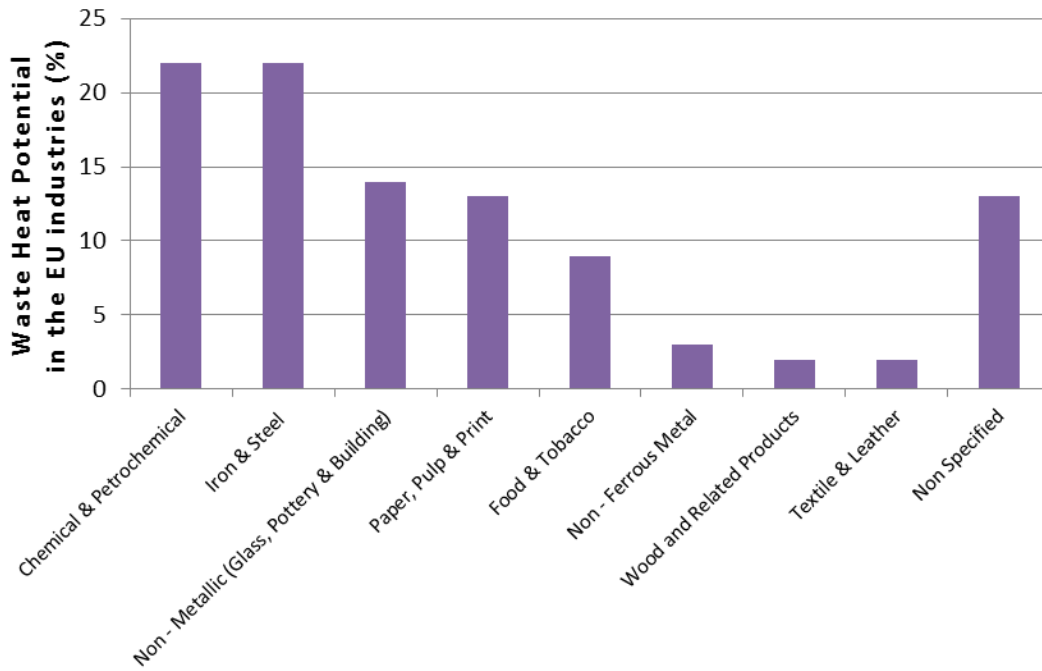

Fig.19, Waste heat potential per industrial sector in the EU (%), Preliminary assessment of waste heat potential in major European industries (2017)

8.1 Process Function

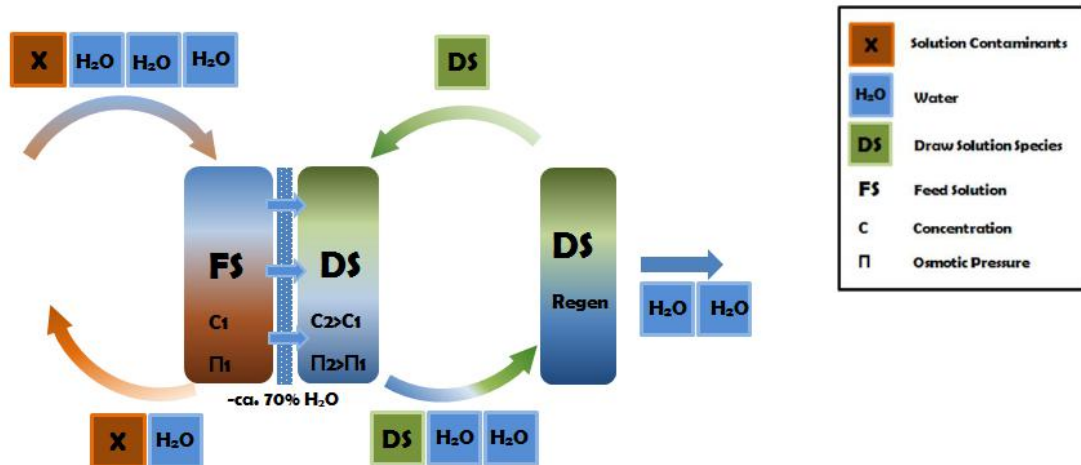

Fig.20, Simplified schematic of the FO process

FO uses the difference of osmotic pressure ($\Delta\pi$) between the feed solution (concentration C_1) and a synthetic draw solution (DS), which we prepare with $C_2 > C_1 \rightarrow \pi_2 > \pi_1 \rightarrow \Delta\pi = \pi_2 - \pi_1$. Due to $\Delta\pi$, the water molecules from the feed will start moving to the draw solution, creating a water flux that removes ca. 70% water from the feed (max 65% recovery (R) for Seawater RO, SWRO and 80% for Brackish Water RO, BWRO). Also due to the fact that FO doesn't use applied

pressure to overcome the osmotic pressure, it can deal with much higher TDS levels than RO (ca. 200,000 ppm (mg/L) for FO and 70,000 ppm (mg/L) for RO). That fact makes FO ideal to deal with high salinity brines.

FO → ca. 70 % Water Recovery, up to 200,000 ppm (mg/L) Feed TDS tolerance

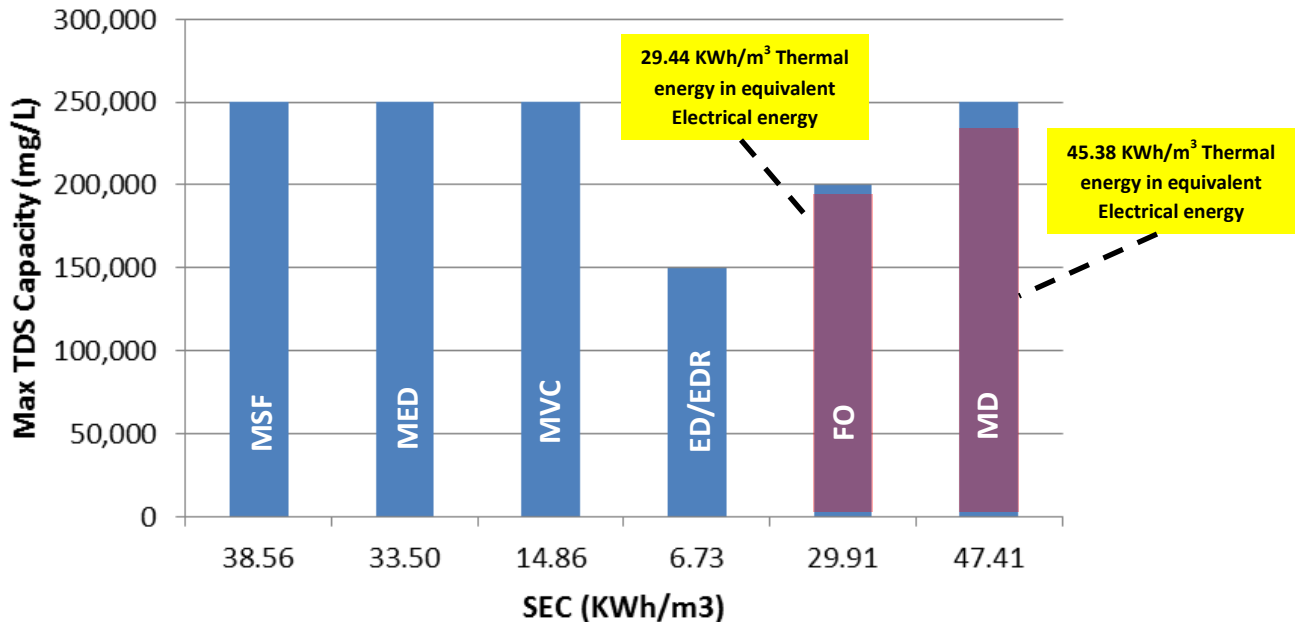

Fig.21, Specific Energy Consumptions (SECs) of Brine Treatment technologies in KWh/m³ versus their Max TDS Capacity in mg/L (ppm). In series we have Multi Stage Flash (MSF), Multiple Effect Distillation (MED), Mechanical Vapor Compression (MVC), Electrodialysis/ Electrodialysis Reversal (ED/EDR), Forward Osmosis (FO), Membrane Distillation (MD). FO and MD can make use of waste heat for up to 90% of their Thermal Energy Demand.

The water flux in FO depends from,

- 1) The osmotic pressure difference
- 2) The membrane structure
- 3) The DS species
- 4) The fouling properties of the feed

FO membranes are of simple structure (CTA) and composite structure (TFC). TFC membranes have shown better performance in the lab scale worldwide.

The DS species are usually inorganic salts that can be retained in the regeneration loop for a long time before we need to add more in the process.

8.2 Advantages and Disadvantages

Advantages:

Due to not using applied pressure the fouling layer on the membrane surface is not compact which means that physical cleaning methods can recover the water flux of the membrane (Fig.4). This means less use of chemicals, improved membrane life and less costs overall.

FO → TFC membranes ↑ performance, Inorganic Salts for DS, ↓↓ Fouling than RO (reversible for FO), ↓↓ Chemicals involved

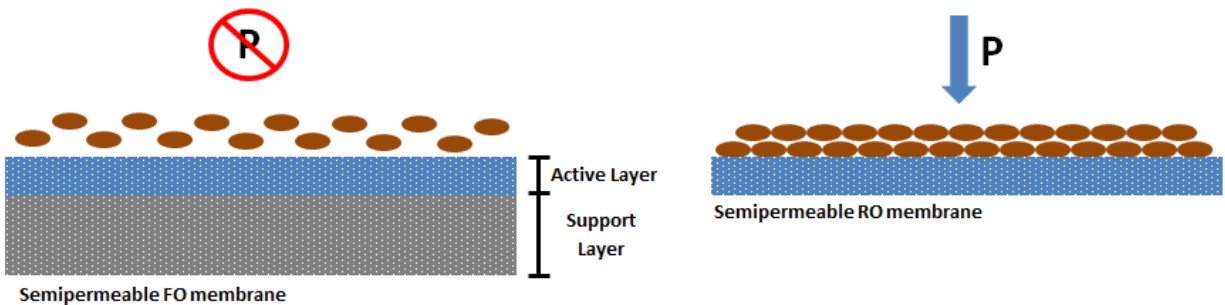

Fig.22, Explanation of the reversible fouling nature of FO. On the right we have a typical RO membrane where we apply pressure in order to push the water through. The applied pressure creates a 'cake layer' of the feedwater contaminants on the membrane surface. On the other hand, on the left we have a FO membrane where no pressure is applied, thus the deposition of the contaminants is very loose and they can be removed by physical methods (e.g. osmotic backwash)

Disadvantages:

Forward Osmosis suffer from two main problems,

- 1) Concentration Polarization (CP)
- 2) Reverse Salt Flux

Concentration Polarization in FO membranes is External (ECP) and internal (ICP). ECP is a common phenomenon in the RO processes and can be reduced with improved cross-flow conditions by using spacers on the surface of the membranes.

In ICP DS molecules build up within the pores of the membrane and lower the osmotic pressure gradient, thus lowering the osmotic pressure difference that is the moving force of the FO process. In the last years there has been an extensive effort by the scientific community to battle the ICP effect and there have been some very promising results with physical methods that can improve the already high efficiency of FO.

FO → ↓Water flux by ICP (can be mitigated with physical methods), DS species can contaminate the Feed with Reverse Salt Flux (have to be careful with the DS selection)

8.3 Process Industry Applications

7. Brine Concentration
8. Oil & Gas
9. Mineral Wastewater (Mining and Metallurgy)
10. Landfill Leachate
11. Cooling Towers Blowdown Treatment
12. Food & Beverages

9. Direct Contact Membrane Distillation

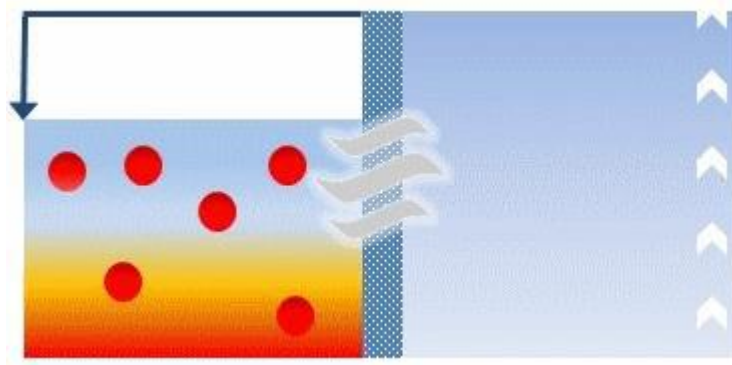

Fig.23, The warm Brine Solution is separated from cooled water by a Hydrophobic Membrane that allows only for vapors to pass. As water vapors pass through the membrane, the Brine volume is minimized significantly. The product goes through a heat exchanger to maintain the circulation.

Membrane Distillation (MD) is a thermally driven transport process that uses hydrophobic membranes. The driving force in the method is the vapor pressure difference between the two sides of the membrane pores, allowing for mass and heat transfer of the volatile solution components (e.g. water). The simplicity of MD along with the fact that it can use waste heat and/or alternative energy sources, such as solar and geothermal energy, enables MD to be combined with other processes in integrated systems, making it a promising separation technique.

9.1 Process Function

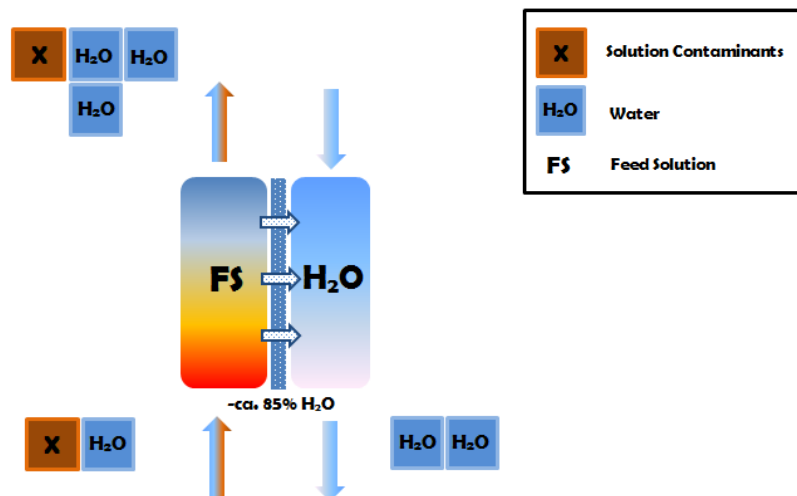

Fig.24, Simplified schematic of the MD process.

The driving force for MD process is given by the vapor pressure difference which is generated by a temperature difference across the membrane. As the driving force is not a pure thermal

driving force, MD can be held at a much lower temperature (30-60°C) than conventional thermal distillation. The hydrophobic nature of the membrane prevents entry to the water molecules due to surface tensions. The latter doesn't apply for the water vapors though, which create a pressure difference and travel through the membrane pore system, condensating on the opposite cool side of the membrane. The process removes ca. 85% water from the feed solution and can be summarized in three steps: (1) formation of a vapor gap at the hot feed solution–membrane interface; (2) transport of the vapor phase through the microporous system; (3) condensation of the vapor at the cold side membrane–permeate solution interface.

The way the vapor pressure difference is created across the membrane is determined by the MD module configuration. In the most commonly used configuration, direct contact membrane distillation (DCMD), the permeate-side consists of a condensation liquid (often clean water) that is in direct contact with the membrane. Alternatively, the evaporated solvent can be collected on a condensation surface that can be separated from the membrane via an air gap (AGMD) or a vacuum (VMD), or can be discharged via a cold, inert sweep gas (SGMD).

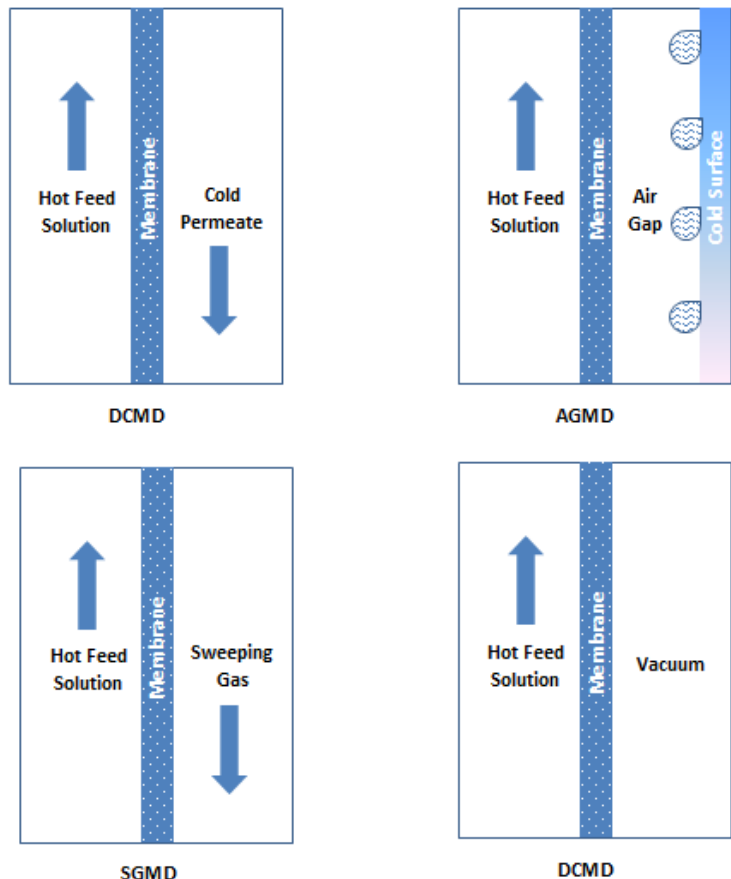

Fig.25, MD configurations.

The selection of the membrane is the most crucial factor in MD separation performance. There are two common types of membrane configurations,

- 1) Hollow fiber membrane mainly prepared from polypropylene (PP), polyvinylidene fluoride (PVDF) and PVDF - Polytetrafluoroethylene (PTFE), composite material
- 2) Flat sheet membrane mainly prepared from PP, PTFE, and PVDF

PTFE has the highest hydrophobicity, good chemical and thermal stability and oxidation resistance, but it has the highest conductivity which will cause greater heat transfer through PTFE membranes (thus reducing the temperature difference and the vapor transfer). PVDF has good hydrophobicity, thermal resistance and mechanical strength and can be easily prepared into membranes with versatile pore structures. PP exhibits good thermal and chemical resistance.

9.2 Advantages and Disadvantages

Advantages:

- 1) Low energy requirements
- 2) Isn't affected much by Concentration Polarization
- 3) 100% theoretical rejection of non-volatile components, no limit on feed concentration

The advantages of MD, in comparison with conventional separation methods are mainly the lower pressure and the low temperature requirements (30-60°C) which lead to lower energy costs and less taxing mechanical properties for the modules. Contrary to distillation and RO the feed solution can be separated at a temperature below its boiling point (at atmospheric pressure). With the low grade heat requirements the industrial waste heat can be used, as well as renewable energy sources such as solar, wind and geothermal.

Also in comparison with RO, MD is less susceptible to flux limitations caused by concentration polarization. Very low feed temperatures can produce reasonably high rates of product water and may be more practical considering the nature of some water impurities (e.g. scaling issues at high temperature). Theoretically, MD offers 100% retention for non-volatile dissolved substances, whereby there is no limit on the supply concentration.

Disadvantages:

- 1) Relatively high energy consumption (although the energy source is low grade temperature)
- 2) Relatively high module cost
- 3) Low flux in comparison to other pressure driven membranes
- 4) Surfactants or amphiphilic contaminants may cause wetting of the membrane (saline feed leaks through the membrane, contaminating the permeate)

The main factors that still hinder the industrial application MD are the relatively low permeate flux in comparison with pressure-based membrane processes, flux reductions caused by concentration polarization, fouling and pore wetting of the membrane, the high cost of MD modules and the high thermal energy consumption.

9.3 Process Industry Applications

<i>13. Brine Concentration</i>
<i>14. Cooling Towers Blowdown Treatment</i>
<i>15. Removal of volatile components (e.g. Ammonia)</i>
<i>16. Water purification in the pharmaceutical, chemical and textile industries</i>
<i>17. Food & Beverages</i>
<i>18. Resource concentration</i>

10. Evaporators

Evaporation like drying, removes volatile substances from a solution but the two processes differ in the following,

- Evaporation
 - Removal of most water from solution
 - Normally takes place at boiling point of water
- Drying
 - Removal of small amount of water from solid material (moisture)
 - Occurs at temperature below boiling point and is typically influenced by humidity

Evaporators include a heat exchanger which task is to boil the solution and they also have a method to separate the vapor from the boiling solution. Evaporator types can be categorized according to their length and the positioning (horizontal or vertical) of the evaporator tubes (Fig.1) which can be inside or outside of the main vessel.

Most materials are not tolerable to high temperatures so normally evaporators operate at reduced pressure so that the boiling point (BP) is reduced. This means that a vacuum pump or a jet ejector vacuum system on the last effect of the evaporator is required.

10.1 Selection of suitable evaporator

Selecting the right evaporator case-by-case is done according to a number of factors, which are,

1. Feed
2. Solution viscosity (and its increase during evaporation)
3. Nature of the product and the solvent (e.g. heat sensitivity and corrosiveness)

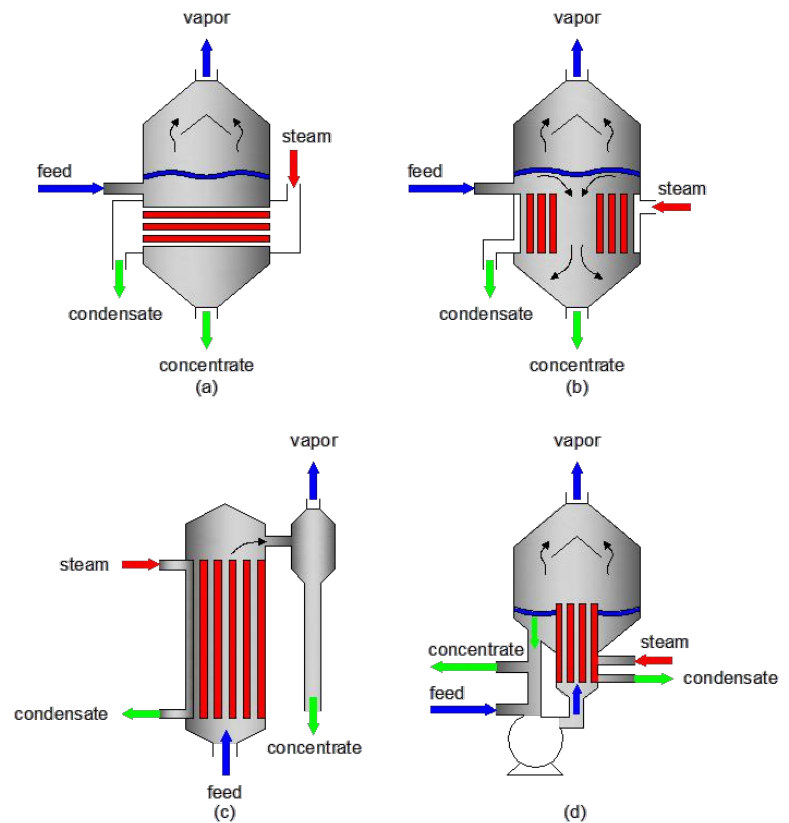

Fig.26, Evaporator types. (a) Horizontal-tube, (b) Vertical –tube, (c) Long-tube vertical and (d) Forced circulation

4. Fouling characteristics
5. Foaming characteristics

Evaporator Type	Feed Condition							Suitable for heat sensitive material
	Viscosity, cP			Foaming	Scaling or Fouling	Crystals production	Solids in Suspension	
	High >1000	Medium 100-1000	Low <100					
<i>Calandria (short tube vertical)</i>								✗
<i>Forced Circulation</i>								✓
<i>Falling Film</i>								✗
<i>Natural Circulation</i>								✗
<i>Agitated Film (single pass)</i>								✓
<i>Long Tube Falling Film</i>								✓
<i>Long Tube Raising Film</i>								✓

10.2 Single-Effect vs. Multiple-Effect

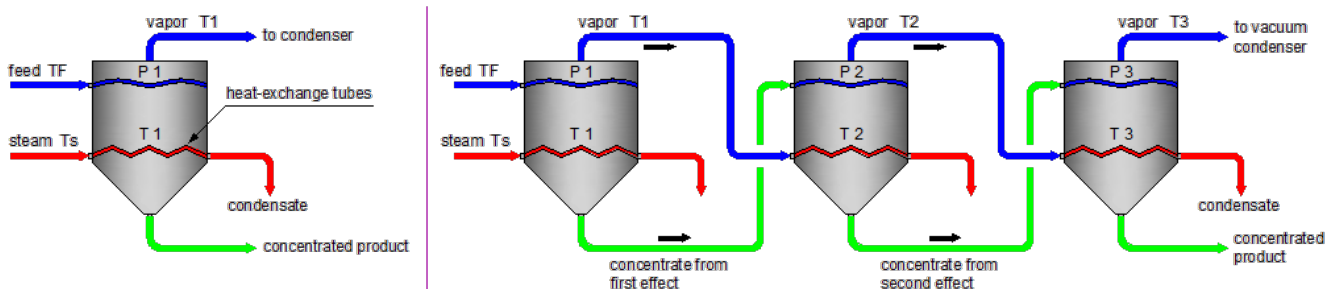

Fig.26, Single and Multiple Effect Evaporators configurations.

There are three criteria that affect performance of an evaporator,

1. Capacity (kg vaporized / time)
2. Economy (kg vaporized / kg steam input)
3. Steam Consumption (kg / hr)

Where Consumption = Capacity / Economy.

Economy (or steam economy) is the kilograms of water vaporized from all the effects (per kilogram of steam used). For single effect evaporator, the steam economy is ca. 0.8 (<1), which translates to 0.8 tons of steam needed to evaporate 1 ton of water.

So as to decrease the evaporator steam economy, the multiple-effect design uses the exhaust vapors from the product to heat the downstream evaporation effect and reduce the steam consumption.

The capacity of a multiple effect evaporator (n effects) is ca. n*single effect evaporator capacity and the economy is about 0.8*n.

Evaporators need also pumps, interconnecting pipes and valves that are required for transfer of liquid from one effect to another effect and they increase both the CAPEX and OPEX of the process.

Table 11, Decrease of the evaporator steam economy by using a three effect evaporator

	Live Steam	Vapor	Steam Economy
1-effect plant	1 kg/h	1 kg/h	100%
3-effect plant	1 kg/h	3 kg/h	33%

Single Effect (SE)

- Small capacity but wasteful energy (1 kg steam vaporize 1 kg water)
- Overall temperature drop for single effect is somewhat equal to multiple effect

Multiple Effect (ME)

- Each individual effect will have a smaller temperature difference, thus high area of heating surfaces
- Capital cost more costly
- Operating cost- steam economy, only required for the first effect (1 kg steam vaporizes 3 kg water)

10.3 Evaporator Types

The temperature of the feed has an important effect on the evaporator's economy and performance. If it is not already at its boiling point, then heat effects must take place. If the feed is above the boiling point, flash evaporation is used at the entry.

Normally, the feed solution is heated with a pre-heat exchanger to reduce the evaporation heat demand by transferring heat from the hot condensate to the feed stream.

The heated feed is then mixed with the evaporator liquid and the mixture is heated by the main heat exchanger which can use steam, electricity, hot oil, or other forms of available energy. The mixture boils, producing a concentrated liquid stream and a water vapor stream which can be discharged or condensed.

Vapor compression (VC) evaporation has been the norm ZLD technology for the last decades, recovering ca. 95 % water from the feed. The concentrated liquid stream (brine) can then be driven to a crystallizer in order to be solidified.

Evaporation is rather expensive and not economically feasible with large feed flow rates, which is why a pre-concentration step is applied to the ZLD process.

There are different kinds of evaporators,

- a. falling film
- b. rising film
- c. forced circulation
- d. scraped surface/thin film
- e. combination evaporator

The main ones are,

a. Falling Film Evaporators (FFE)

FFEs have many energy-saving, multiple-effect evaporation and mechanical vapor re-compression features. A FFE operates with a very small operating temperature and allows,

- 1) easy controls
- 2) fast start up and shut down due to a minimal liquid hold-up

FFEs are chosen for viscous streams with small concentrations of suspended solids. A FFE has small to large flow rates capacity.

b. Forced Circulation Evaporators (FCEs)

Because of the high circulation flow-rate and the evaporation taking place externally to the heat exchanger, FCEs are chosen for highly viscous streams containing a large concentration of suspended solids and fouling contaminants. It has medium to large flow rates capacity.

c. Thin Film Evaporators (TFEs)/ Dryers

TFEs are mostly chosen in order to decrease the water content down to < 5% (crystallization). Like the FFEs, this technology is easy to control and fast to start up and shut down due to a very low liquid hold-up. TFEs are chosen for highly scaling products and highly viscous fluids. It has small to medium flow rates capacity.

Evaporators distillate stream is usually < 10 ppm TDS (Total Dissolved Solids). The most used is the FFE (also called brine concentrator) that can lead the feed concentration up to 300,000 ppm which leads to a boiling point rise (BPR) of the brine and requires either a large heat-transfer area (large CAPEX) or a large heat temperature (large OPEX).

10.4 Process explanation

Evaporators can treat streams high chlorides concentration and theoretically separate the water from all of the dissolved species producing a stable solid product that can be landfilled and a high-quality distilled water product.

The steps in the evaporation process are (Fig.27),

- 1) chemical addition (feed tank)
- 2) preheating (feed preheater)
- 3) deaeration
- 4) primary evaporation (brine concentrator)

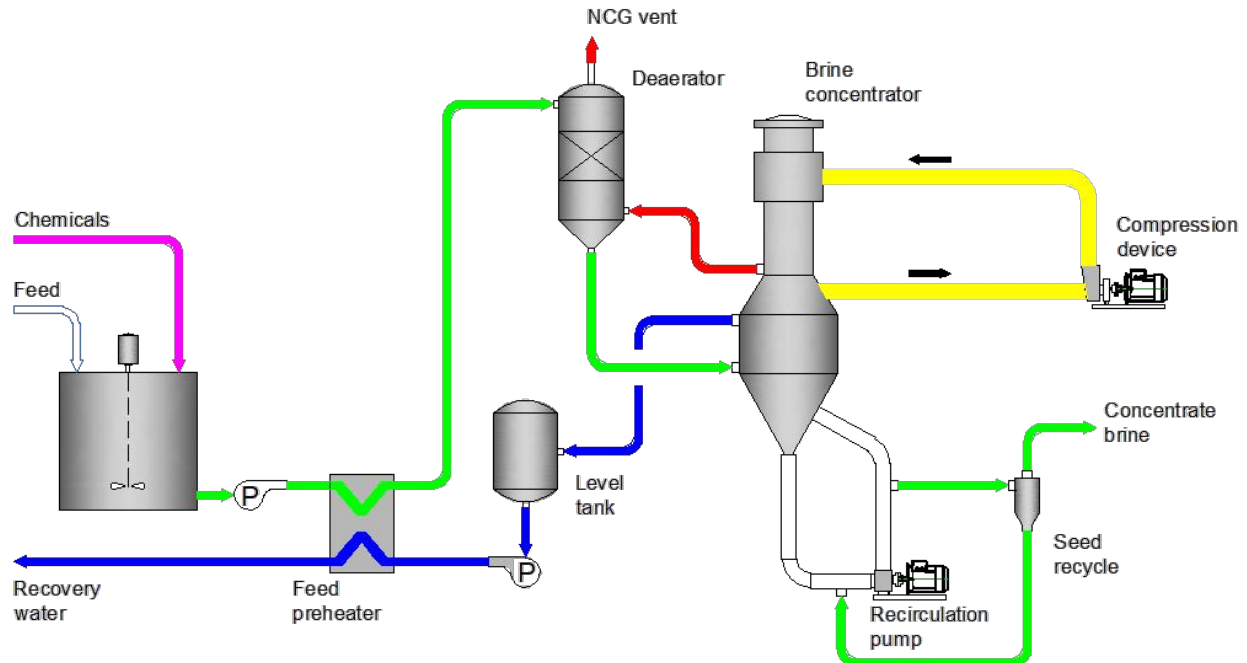

Fig.27, Evaporation process flow diagram

Steps 1&2; Acid is added to the feed tank to neutralize bicarbonate alkalinity in order for the solution to be preheated in the plate heat exchangers. Antiscalants are also added for preventing scaling in the preheaters with calcium carbonate.

Step 3; The pre-heated stream is degassed using steam from the evaporator (red line in Figure 3) to remove the dissolved carbon dioxide (alkalinity reduction), dissolved oxygen, and any other non-condensable gases in order to reduce the potential for corrosion of the evaporator.

Step 4; Most of the water evaporation takes place inside the brine concentrator vessel which is seeded with calcium sulfate to minimize scaling. The wastewater is typically saturated with calcium sulfate, which will precipitate and form scaling on the evaporator tubes. By using calcium sulfate seed crystals the dissolved calcium sulfate precipitates preferentially on the seed crystals rather than the evaporator tubes.

The process also requires electricity for the mechanical vapor compression (MVC) cycle. As MVC recycles the latent heat of vaporization, the energy input is quite low, in the range of 15 kWh/m³ of feed (GIVE LINK TO TABLE 4 FROM ZLD PAGE). To minimize the size and cost of the vapor separator and compressor, evaporation occurs at atmospheric pressure.

10.5 Energy saving

Some of the methods applied for minimizing the energy consumption of the evaporation plants include,

- Multiple effect arrangement (ME)
- Thermal vapor recompression (TVR)
- Mechanical vapor recompression (MVR)
- Mechanical vapor compression (MVC)
- Usage of waste energy

For evaporators, the MVC approach is the most widely used.

10.5.1 Mechanical Vapor Compression

In the MVC evaporator, heat is transferred to the circulating stream by condensing vapor from the compressor(s) (increasing the vapor's temperature and pressure). In doing so it requires much less energy than a default evaporator.

During process (Fig.4), the vapor generated from the circulating stream has a large amount of energy in the

form of latent heat at a temperature of the boiling wastewater. In order for the main heat exchanger to work, a higher temperature will be required. In order to get to the needed higher temperature, the vapor is compressed by the vapor compressor. Compressing the vapor raises its pressure (thus its saturation temperature as well) and produces the needed heat transfer in the main heat exchanger allowing for recycling the energy contained by the vapor, greatly improving the total energy efficiency.

1. Feed wastewater goes from the feed pump to the feedstock heat exchanger and in the circulating stream. The feedstock heat exchanger heats transfers sensible heat from the hot condensate to the cooler feed.

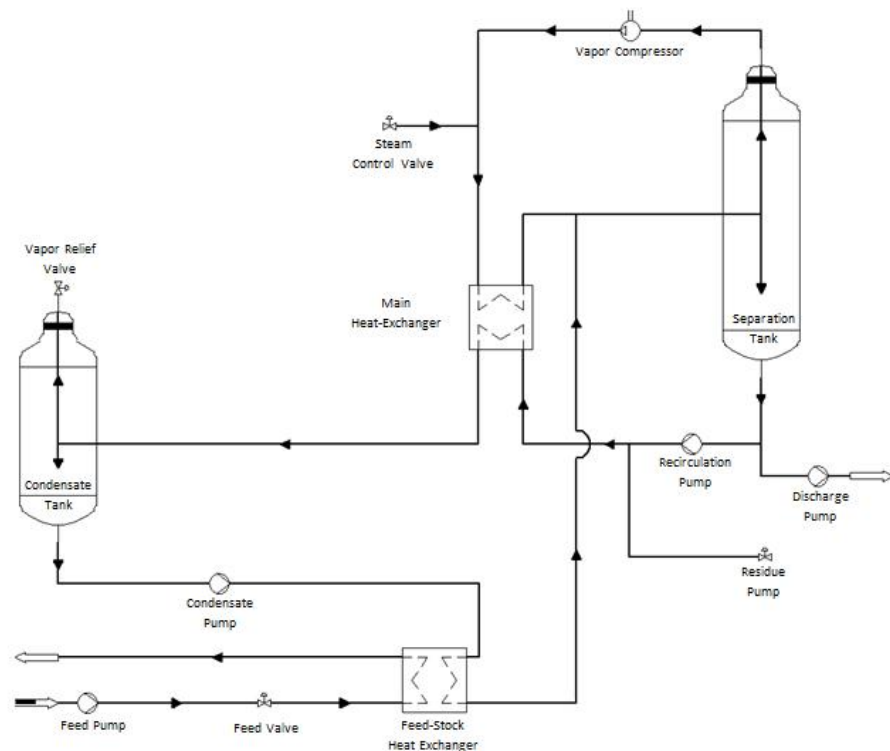

Fig.28, Mechanical Vapor Compression process

2. The recirculation pump circulates wastewater from the separation tank through the main heat exchanger, to the orifice plate, and back into the separation tank. The latent heat from the compressed vapor is transferred to the wastewater via the main heat exchanger.
3. An orifice plate is used to reduce the pressure of the circulating stream. The downstream pressure is low enough to allow flashing of the circulating stream into liquid and vapor components.
4. The liquid and vapor then flow to the separation tank where they are separated. The liquid steam exits the tank at the bottom and flows back to the recirculation pump. The vapor stream exits the tank at the top and flows to the vapor compressor(s).
5. A mist pad is provided at the top of the separation tank to remove small droplets of liquid from the vapor.
6. The vapor compressor compresses the vapor (raising the temperature and pressure), and sends the vapor to the main heat exchanger, where it transfers its latent heat to the wastewater in the recirculation loop.
7. High temperature condensate exits the main heat exchanger and flows to the condensate tank, where any remaining vapor is separated. The hot condensate is then pumped to the feedstock heat exchanger, where it transfers sensible heat to the incoming feed wastewater.
8. Upon reaching steady-state at the target concentration, the concentrated wastewater is purged from the recirculation loop, using the residue valve. Depending on the energy balance, energy can be added to the system by electric heaters / process steam or excess energy can be removed from the system by the steam relief valve.

11. Crystallizers

Crystallization is the production of a solid (crystal or precipitate) formed from a homogeneous, liquid which is concentrated to supersaturation levels (concentration > solubility) at that temperature.

The available crystallization processes are the following three,

1. Supersaturation by cooling the solution with trivial evaporation
2. Supersaturation by evaporation of the solvent with little cooling
3. Evaporation by a combination of cooling and evaporation in adiabatic evaporators (vacuum crystallizers)

Crystallizers can put up with the continuous crystallization of all sparingly and highly soluble sodium salts such as sodium chloride and sodium sulfate, without excessive scaling and cleaning frequencies. This means higher specific energy consumption (OPEX) and higher specific capital cost (CAPEX).

They normally use live steam but can also use MVR (forced circulation) technology to recycle the vapor in order to reduce the energy consumption and thus the OPEX. Forced circulation crystallizers concentrate brine blowdown from upstream concentration equipment, although small waste water flows are sometimes treated directly with a forced circulation crystallizer. The solid by-products give the option of recovering the valuable salts at the end of the ZLD process.

11.1 Process Explanation

Crystallization occurs in the forced-circulation evaporator-crystallizer, where we have the generation and augmentation of the crystals within the bulk solution (Fig.29). The evaporator/crystallizer scheme is followed by a dewatering device (centrifuge or pressure filter), which separates the salt crystals from the product slurry. The mother liquor is returned to the crystallizer for further concentration.

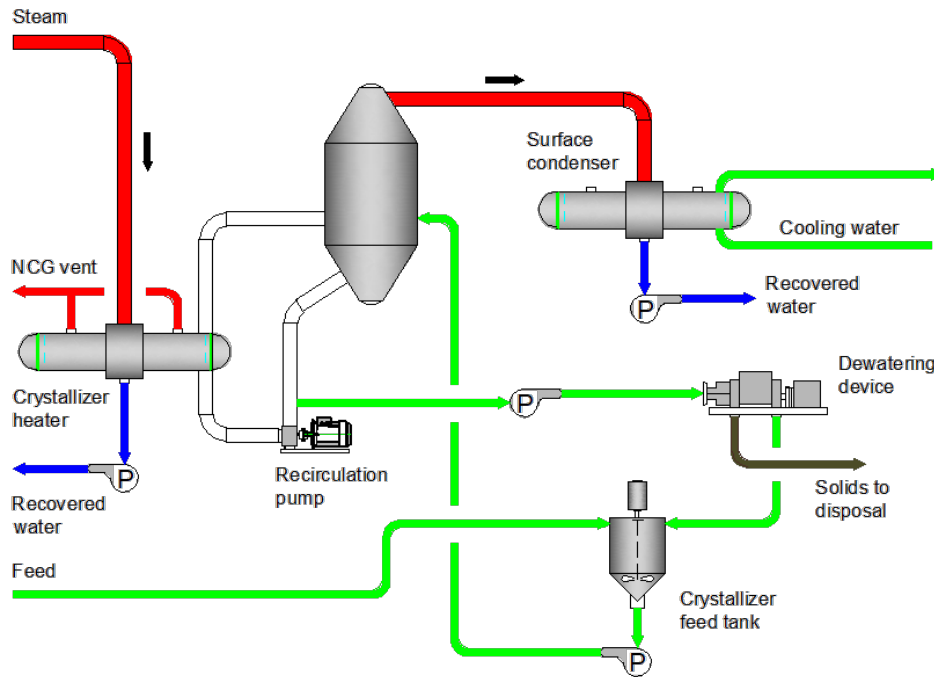

Fig.29, Crystallizer process.

The forced-circulation evaporator is normally fed by an external source of steam heating which is used due to the high boiling point rise (BPR) of the solution at high concentration. The crystallizer needs ca. a bit more than 1 ton of steam to evaporate 1 ton of water.

11.2 Highly Soluble Salts and Evaporator BPR

Using a falling film evaporator for brine volume minimization we are able to remove 75% to 95% of the water. In the presence of highly soluble salts in the feed stream, the last 5% to 25% of water is difficult to evaporate.

When the ion concentration of the salts increases, the boiling temperature of the solution increases as well. The increase in boiling temperature of a solution above that of water at a given pressure is called the BPR.

Let's take for example calcium chloride (CaCl_2) which is the main dissolved salt in wet limestone FGD blowdown. The diagram in Figure 30 shows the increase of the boiling point temperature as the concentration of calcium chloride increases in the solution. The two curves intersect at the solubility limit of calcium chloride in a boiling solution. Calcium chloride is very soluble in water; as a solution is concentrated by evaporation at 1 atmosphere (atm), its boiling point continues to rise, until the solubility limit of about 75% by weight is reached and calcium chloride dihydrate ($\text{CaCl}_2 \cdot 2\text{H}_2\text{O}$) crystallizes out from solution. Figure 2 further shows that a saturated solution of calcium chloride at a pressure of 1 atm has a boiling temperature of almost 176.6°C (350F), a BPR of 58.8°C (138F).

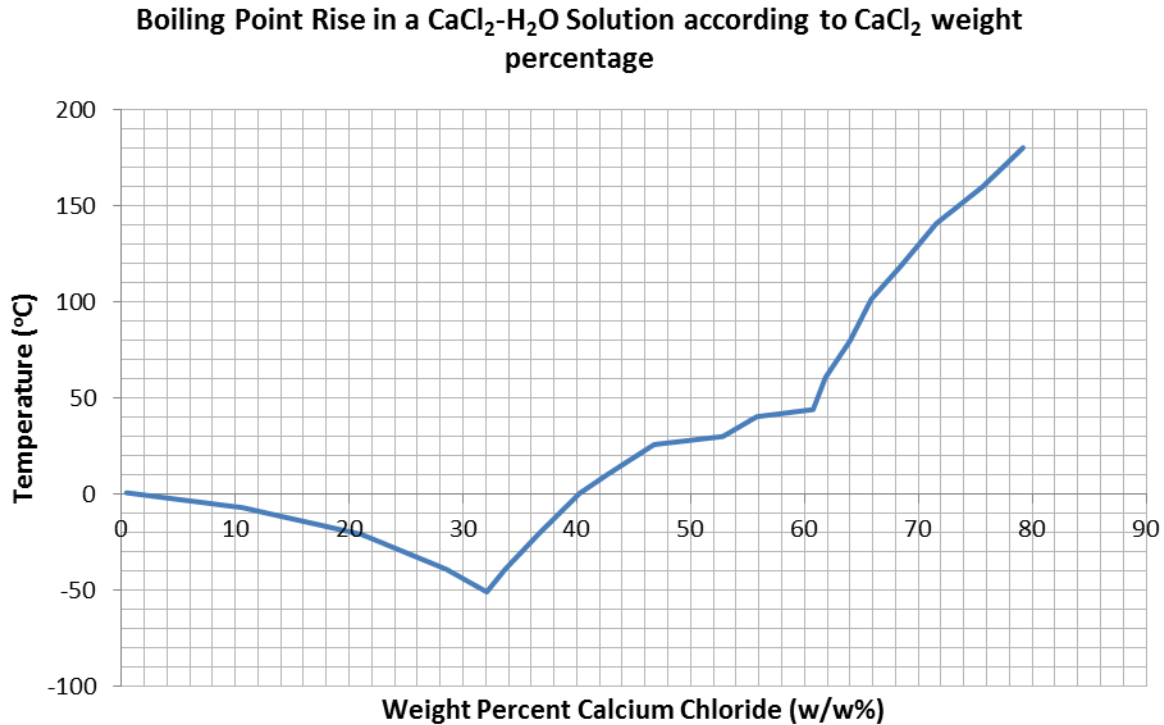

Fig.30, Graphical representation of the relationship between the boiling temperature for pure calcium chloride solution against its solubility curve at atmospheric pressure. As the weight percentage of the calcium chloride increases in solution, so does the boiling point of the solution.

At this high temperature, calcium chloride, like magnesium chloride (MgCl₂) and ammonium chloride (NH₄Cl), sustains hydrolysis in water which means that it releases hydrochloric acid which will aggressively attack steel. The higher the temperature, the higher the rate of hydrolysis, so evaporator vessels and heat transfer surface need construction materials will be able to resist the extremely corrosive nature of these salts at high concentrations and temperatures. These are very expensive noble alloys, such as palladium-alloyed titanium and high nickel-chrome-molybdenum alloys which skyrocket the CAPEX and constitute the use of a crystallizer economically challenging in most of the ZLD applications.

12. Minimal Liquid Discharge (MLD)

12.1 ZLD vs MLD

For a long time ZLD has been suggested as an environmentally friendly way to help the industry meet with increasingly strict discharge requirements and for recycling their wastewater streams. However ZLD processes are

- 1) technically complex
- 2) very expensive
- 3) not necessarily environmentally friendly due to the additional material and energy they require

So more and more end users, in order to improve their water footprint, are adopting a minimal liquid discharge (MLD) approach to the wastewater treatment problem by using dependable filtration-based technologies that can achieve high water recovery at a fraction of ZLD's costs.

12.2 Why MLD?

Taking an MLD approach to your process can help users to significantly minimize their CAPEX and OPEX, since removing the final 5 to 10% of liquid in order to achieve ZLD can prove horrendously costly. In order to understand this better, we'll take the MD-MVC- Crystallizer from Lenntech's ZLD page (give link) but this time we'll start counting the total water recovery from a single pass SWRO (with 45% recovery).

100 m³ feed water → Pretreatment → Single Pass RO (45% recovery) → 100 (1-0.45) = 55 m³ Brine → MD (75% recovery) → 55 x (1-0.75) = 13.75 m³ Brine → MVC (90% recovery) → 13.75 x (1-0.9) = 1.375 m³ Brine → Crystallizer (50% recovery) → 1.375 (1-0.5) = 0.68 m³ Brine → Centrifuge of Belt Press

The energy required for this scheme is,

100 m³ x 3.5 KWh/m³ (RO) + 55 x 3.88 KWh/m³ (MD) + 13.75 m³ x 18.3 KWh/m³ + 1.375 m³ x 50 KWh/m³ = 350 KWh (RO) + 361.35 KWh (MD) + 204.33 KWh (MVC) + 68.75 KWh (Crystallizer) = 984.43 KWh/ 100m³ feed water

So up to MD the system has recovered [100 m³ x 0.45 = 45 m³ (RO)] + [55 m³ x 0.75 = 41.25 m³ (MD)] = 86.25 m³ permeate at a cost of 350 KWh (RO) + 361.35 KWh (MD) = 711.55 KWh.

From MVC forward the system is recovering [(100 – 86.25 = 13.75) m³ x 0.9 = 12.375 m³ (MVC)] + [(13.75 - 12.375 = 1.375) m³ x 0.5 = 0.688 m³ (Crystallizer)] = 13.06 m³ permeate at a cost of 201.33 KWh (MVC) + 68.75 KWh = 270.08 KWh.

What we end up with is **711.55 KWh for 86.25 m³ permeate (Single RO – MD) and 270.08 KWh for 13.06 m³ permeate (MVC – Crystallizer)**. That is to say that the (Single RO-MD) is producing permeate at a $711.55 \text{ KWh} / 86.25 \text{ m}^3 = 8.25 \text{ KWh/m}^3$ cost and the (MVC – Crystallizer) is producing permeate at a $270.08 \text{ KWh} / 13.06 \text{ m}^3 = 20.66 \text{ KWh/m}^3$. Let us take a look at this point at Table 12 and its graphical representation Figure 31,

Table 12, Recovery and SEC values of the RO-MD-MVC-Crystallizer water treatment process scheme.

	Recovery (%)	SEC (KWh/m ³)
RO	45	3.5
MD	86.25	6.57
MVC	98.625	14.86
Crystallizer	99.313	50

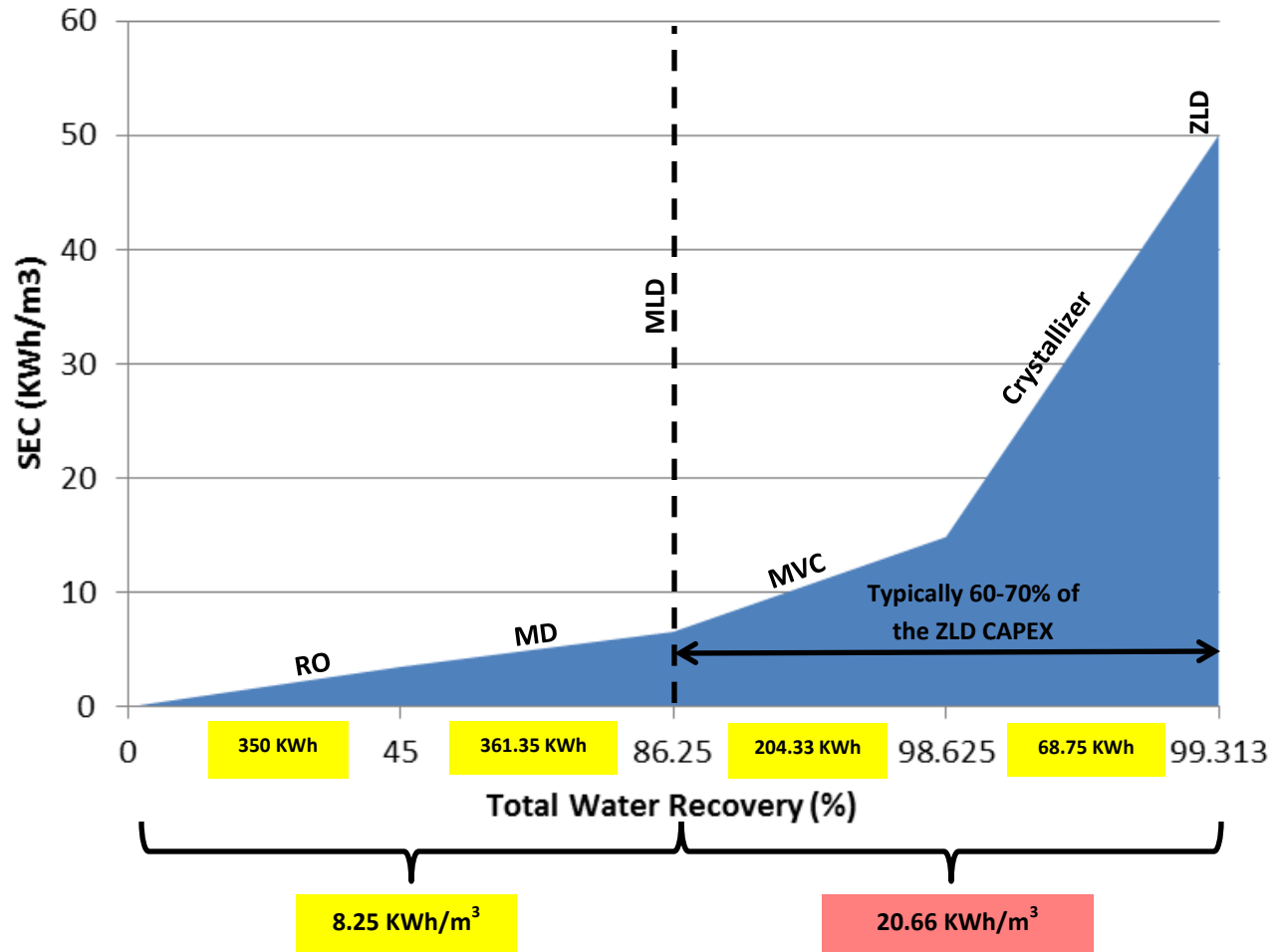

Fig.31, Total water recovery of the RO-MD-MCV-Crystallizer process versus their respective SECs. In the graph are also the values of the energy demand at each stage of the process along with the energy demand/m³ of the MLD and the ZLD stage. The process reaches a MLD stage right after MD and a ZLD after the Crystallizer.

As we can see, the energy demand for further recovery after MD goes up by a whopping 20.66 KWh/m³ / 8.25 KWh/m³ = 2.50 or 250%! At this point every user must decide if the extra step forward is really worth it.

ZLD may be useful when tight legislations are present or in water-sensitive regions of the world, when every drop counts but is very economically challenging. The last few steps needed to achieve complete ZLD can nearly double the costs.

An excellent MLD real-life example took place at the General Motors (GM) vehicle assembly plant in San Luis Potosi, Mexico. The plant is located in an arid, remote area with no receiving stream or municipal sewer available to discharge wastewater. By using a combination of RO technology, a high-rate chemical softening process and other technologies, the plant recovers and re-uses 90% of its tertiary wastewater, with the rest 10% of the liquid waste discharged into adjacent solar ponds for evaporation.

Other technology options such as HPRO, EDR, FO and MD, their combinations and hybrids can also raise high the recovery (70-80%) and they require much less energy than thermal evaporation, reducing the size of the latter and consequently the crystallizer (if ZLD is required)

12.3 Reduced costs & environmental impact

The strongest argument in the pursue of MLD is the reduction of CAPEX and OPEX when compared to the ZLD design. The costs of membrane and filtration processes are proportionally minimal in comparison the thermal ZLD technologies.

The new technological advancements can minimize the size of evaporators and crystallizers and perhaps even eliminate their use. At the same time these very technologies have higher recovery capacity. Especially since some of them can make use of waste heat it's highly important to consider them for additional cost-saving and efficiency benefits in a MLD process design.

12.4 Evaluating MLD needs

In order to understand if a certain case is appropriate for MLD the first question is if water reuse is needed. If it is so, then the MLD approach could be what is needed. If local legislations need to be met concerning effluent discharge, then MLD can be a part of the solution which might include ZLD/ evaporation ponds/ groundwater injection.

Next step is to identify your waste streams in terms of flow, their contaminants and their respective concentrations. Not every case requires the same treatment. By checking the waste streams, we can calculate a more economical and sustainable approach to each case. For example condensate and stormwater require very little treatment while waste streams with

high concentrations of organic compounds, salts, metals and suspended solids are more likely to require extensive treatment.

From the water needs, legislations and environmental requirements, as well the CAPEX and OPEX budget, MLD can prove to be a good option for a wide range of industrial and municipal sites who want to improve cost-effectively their water footprint.

CHAPTER 4: ZLD Brine Recovery Options

Desalination of high saline waters is becoming more and more common for supporting a growing water demand around the world. Desalination though doesn't come cheap. There are multiple problems associated with desalination, which are mainly,

1. CAPEX and OPEX
2. Brine management and disposal



Brine disposal can be a significant portion of total project costs, depending on,

1. Volume
2. Type of discharge

In order to deal with brine management, there have been increasing efforts worldwide to reduce brine volumes with zero liquid discharge (ZLD) technologies.

One option to decrease the ZLD-relative costs is by recovering the valuable contaminants in the desalination brine streams. This way the recovered materials could be sold and thus raise the profits of a desalination plant. Alternatively the recovered materials could be used within the industrial facility using the desalination process and so reduce the operation cost.

The feasibility of the material recovery process from brine depends from the technical limitations of the available technologies and their energy and cost considerations, but also from the market fluctuations for the materials that are recovered.

A rough approach for the feasibility of a mineral recovery project is the following algorithm, where the potentially profitable stream contaminants need to fulfill the inequality,

$$P * C * Q_c - OM > 0 \tag{6}$$

Where,

P = market price of the material

C = concentration of the element in the brine

Q_c = flow rate of the brine

OM = the operational and maintenance (O&M) costs

In the following table we present the main opportunities for material recovery from desalination brine,

Table 13, Mineral recovery options from the desalination brine.

<i>Element</i>	<i>Main commodities</i>	<i>Market opportunities</i>
<i>Bromine</i>	Elemental bromine (Br ₂) Organobromide fertilizers Flame retardants Gasoline additives	- ↑ demand expected in Asia and South America - Boron reserves will satisfy global demand for the foreseeable future

<p><i>Calcium</i></p>	<p>Calcium carbonate, Lime (CaO) Calcium sulfate Calcium chloride</p>	<ul style="list-style-type: none"> - ↑ demand expected in USA - ↑ production of gypsum from coal-fired power plant scrubbers expected - possible applications for low quality commodities: CaCl₂ in dust suppression; and CaCl₂ or CaSO₄ use in sodic soil remediation - CaCO₃ pellets produced at BWRO facility and sold
<p><i>Cesium</i></p>	<p>Cesium metal</p>	<ul style="list-style-type: none"> - ↓ market as drilling fluid, drill pipe unsticking, and treatment of some tumors
<p><i>Chlorine and Sodium Hydroxide</i></p>	<p>Chlorine gas (Cl₂) Hypochlorous acid Solid NaOH Concentrated liquid NaOH</p>	<ul style="list-style-type: none"> - ↑ demand for sodium hydroxide for the last 5 years - ↓ Chlorine demand due to the global economic recession
<p><i>Magnesium</i></p>	<p>Magnesium metal Magnesia Mg(SO₄), Mg(OH)₂, MgCl₂, MgO-Synthetic</p>	<ul style="list-style-type: none"> - production of magnesium metal from seawater is not competitive with current methods of production - ↑ demand expected for caustic calcined magnesia and magnesium hydroxide in the near future - U.S. currently imports the majority of consumed magnesia

<p><i>Nitrogen</i></p>	<p>Ammonia, Urea</p> <p>Ammonium nitrate</p> <p>Ammonium phosphates</p> <p>Ammonium sulfate</p> <p>Nitric acid</p>	<ul style="list-style-type: none"> - ↑ demand expected worldwide for nitrogen consumption for fertilizers - because of stable natural gas prices, nitrogen fixing production is expanding
<p><i>Potassium</i></p>	<p>Potash (K₂O) in the form of either potassium chloride, potassium sulfate, or potassium magnesium sulfate</p>	<ul style="list-style-type: none"> - ↑ by 4% annually worldwide for potash consumption due to population growth and increased fertilizer demand - Potassium as a fertilizer has no substitutes.
<p><i>Rubidium</i></p>	<p>Rubidium metal</p> <p>Rubidium carbonate</p> <p>Rubidium chloride</p> <p>Rubidium hydroxide</p> <p>Rubidium silver iodide</p>	<ul style="list-style-type: none"> - probable ↑ interest in the use of rubidium for quantum computing, in atomic clocks and superconductors, and for biomedical uses. - little demand
<p><i>Sodium</i></p>	<p>Salt</p> <p>Sodium Hydroxide</p> <p>Sodium sulfate</p>	<ul style="list-style-type: none"> - Sodium compounds are consumed in ↑ quantities by a variety of end users and industries
<p><i>Strontium</i></p>	<p>Strontium metal</p> <p>Strontium carbonate</p> <p>Strontium nitrate</p> <p>Strontium oxide (strontia)</p> <p>Strontium hydroxide</p> <p>Strontium peroxide</p>	<ul style="list-style-type: none"> - ↓ strontium demand since 1997 - Strontium consumption is expected to ↑ in the near future, in traditional applications (e.g., ceramics, glasses and magnets), and advanced applications (e.g., pharmaceuticals)

	Celestite (strontium sulfate)	
<i>Lithium</i>	<p>Lithium carbonate</p> <p>Lithium hydroxide</p> <p>Lithium chloride</p>	<p>- ↑ demand expected due to ↑ lithium-ion battery production.</p>
<i>Uranium</i>	<p>Triuranium octoxide</p>	<p>- ↑ worldwide demand projected to reach 110 kton-U/yr by 2030.</p> <p>- Uranium extracted from seawater costs could be between 220-280\$/ kg-U with the prices reported to fall between 689–2850/ kg-U</p>



LENNTECH

info@lenntech.com Tel. +31-152-610-900

www.lenntech.com Fax. +31-152-616-289