

2178 AND ALL THAT

N. J. A. SLOANE

ABSTRACT. For integers $g \geq 3$, $k \geq 2$, call a number N a (g, k) -reverse multiple if the reversal of N in base g is equal to k times N . The numbers 1089 and 2178 are the two smallest $(10, k)$ -reverse multiples, their reversals being $9801 = 9 \cdot 1089$ and $8712 = 4 \cdot 2178$. In 1992, A. L. Young introduced certain trees in order to study the problem of finding all (g, k) -reverse multiples. By using modified versions of her trees, which we call *Young graphs*, we determine the possible values of k for bases $g = 2$ through 100, and then show how to apply the transfer-matrix method to enumerate the (g, k) -reverse multiples with a given number of base- g digits. These Young graphs are interesting finite directed graphs, whose structure is not at all well understood.

1. INTRODUCTION

For integers (g, k) with $g \geq 3$, $2 \leq k < g$, call a number N a (g, k) -reverse multiple if the reversal of the base- g expansion of N is the base- g expansion of the product kN . The decimal numbers 1089 and 2178 are the two smallest $(10, k)$ -reverse multiples, their reversals being respectively $9801 = 9 \cdot 1089$ and $8712 = 4 \cdot 2178$. There are no other 4-digit examples in base 10. In 1940, G. H. Hardy [6] famously remarked that the existence of these two numbers was “likely to amuse amateurs”, but was not of interest to mathematicians, since this result is “not capable of any significant generalization”.

It seems fair to say that Hardy was wrong, since references [5], [7], [8], [10], [13], [16], [18], [21], [22] discuss generalizations. References [2], [3], [4], [19] also mention the problem. The bibliography lists all the articles or books known to the author that discuss this topic. There may well be other references, since—partly no doubt because of Hardy’s comment—*Mathematical Reviews* does not cover this subject, and the author would appreciate hearing about them. A more appropriate title for the present paper would have been “1089 and all that”, but this was already in use [1], prompted by another interesting property of 1089, namely that if one takes any three-digit decimal number abc with $a > c + 1$, $c \neq 0$, and performs the successive operations of reverse, subtract, reverse, add, the result is always 1089. For generalizations of this property, see [17].

Hardy’s book was published in 1940, but apparently it was not until 1966 that the problem was taken up again, by Alan Sutcliffe [16]. His paper and subsequent papers by Kaczynski [8], Klosinski and Smolarski [10], Grimm and Ballew [5], and Pudwell [13] concentrate on finding all (g, k) -reverse multiples in arbitrary bases g with a specified (and small) number of digits. These papers demonstrate that this is a fairly difficult problem, which even for two- or three-digit numbers is still not completely solved (see, for example, the table on page 286 of [16]).

In 1992, Young [21], [22] introduced certain trees in order to study the problem of finding all (g, k) -reverse multiples for a fixed base g . The present paper extends her work. We replace her trees with certain finite directed graphs that we refer to as “Young graphs”. (“Young diagram” would have been a better name, but that term is already in use.) Once one has

the Young graph for a particular pair (g, k) , it is easy to generate as many examples of (g, k) -reverse multiples as one wishes. It is also easy to program a computer to determine whether the Young graph exists, and hence to find, for any given value of g , the possible values of the multiplier k (see Table 1 in §4 for bases $3 \leq g \leq 20$). Furthermore, by applying the transfer-matrix method from combinatorics [15, §4.7] to the Young graph, one can obtain a generating function for the number of (g, k) -reverse multiples with a given number of digits.

In the base-10 case, it is well known that if a $(10, k)$ -reverse multiple exists then k must be 4 or 9. The papers by Klosinski and Smolarski [10], Grimm and Ballew [5], and very recently Webster and Williams [18] show how to find all solutions in this case. This is especially easy to do using the $(10, 4)$ and $(10, 9)$ Young graphs (see Figs. 4 and 5).

Incidentally, it seems that none of the above authors noticed that the n -digit reverse multiples in the base 10 case (and in many other cases) are essentially enumerated by the Fibonacci numbers (see (3.2)–(3.4) below; the first mention of this fact appears to have been by D. W. Wilson [20] in 1997, in a comment on one of the sequences in [12]).

Another property that these authors overlooked is that in many (but not all) cases the (g, k) -reverse multiples are precisely the numbers $\gamma\beta$, where γ is a constant (depending on g and k) and β ranges over all numbers whose base- g expansion is palindromic, with a restricted set of digits, and satisfies certain simple rules. In the case of the $(10, 9)$ -reverse multiples, for example, $\gamma = 99$ and β is any positive palindromic decimal number whose digits are 0 or 1 and whose decimal expansion does not contain any singleton 0's or 1's (again this was first noticed by Wilson [20]). Similarly, the $(18, 7)$ -reverse multiples are the numbers $\gamma\beta$ where $\gamma = (1, 17, 3, 5, 12, 13)_{18}$ and β is any positive number whose base-18 expansion is palindromic, contains only the digits 0 or 1, and does not contain any run of 0's of length less than 3 or any pair of adjacent 1's (see §4). On the other hand, the $(24, 17)$ - and $(40, 13)$ -reverse multiples are not palindromic in this sense (see the last two examples in §4).

The Young graphs are defined in §2, and the transfer-matrix method is described in §3. Sections 3.2, 3.3, 3.4 discuss three particular families of Young graphs: the “1089” graph shown in Figs. 4, 5, which appears to occur if and only if $k + 1$ divides g , and is consequently the most common Young graph; the complete graphs K_m (see Figs. 7, 8); and the cyclic graphs Z_m illustrated in Figs. 9, 12. Section 3.2 explains why Fibonacci numbers arise from the 1089 graph. The computer-generated results for bases $g \leq 20$ appear in §4 (see especially Table 1, which lists all Young graphs with $g \leq 20$). The final section lists several open problems.

Notation. A nonnegative number N with base- g expansion

$$N = \sum_{i=0}^{n-1} a_i g^i \quad (1.1)$$

($0 \leq a_i < g$, $a_{n-1} \neq 0$) will also be written as

$$N = (a_{n-1}, a_{n-2}, \dots, a_1, a_0)_g. \quad (1.2)$$

We refer to the a_i as “digits”, even if $g \neq 10$, and say that N has “length” n . For the convenience of readers who wish to refer to Young’s papers, for the most part this paper uses her notation.

2. YOUNG GRAPHS

2.1. **The equations.** We assume always that $g \geq 3$, $2 \leq k < g$. Suppose N , given by (1.1) and (1.2), is a (g, k) -reverse multiple, so that

$$kN = (a_0, a_1, \dots, a_{n-2}, a_{n-1})_g. \tag{2.1}$$

This implies that $a_0 \neq 0$ (since $kN > N$) and

$$\begin{aligned} ka_0 &= a_{n-1} + r_0 g, \\ ka_1 + r_0 &= a_{n-2} + r_1 g, \\ &\dots \\ ka_i + r_{i-1} &= a_{n-1-i} + r_i g, \\ &\dots \\ ka_{n-2} + r_{n-3} &= a_1 + r_{n-2} g, \\ ka_{n-1} + r_{n-2} &= a_0, \end{aligned} \tag{2.2}$$

where the ‘‘carry’’ digits r_0, \dots, r_{n-2} satisfy $0 \leq r_i < g$. Young’s approach [21], [22] proceeds as follows. Equations (2.2) imply that

$$r_0 > 0, \quad r_i < k \text{ for } i = 0, \dots, n - 2 \tag{2.3}$$

(the latter inequality has an easy proof by induction). We also set $r_{-1} = r_{n-1} = 0$. The equations can be combined in pairs, the i -th pair being

$$\begin{aligned} ka_i + r_{i-1} &= a_{n-1-i} + r_i g, \\ ka_{n-1-i} + r_{n-2-i} &= a_i + r_{n-1-i} g, \end{aligned} \tag{2.4}$$

for $i = 0, 1, \dots, \lfloor \frac{n}{2} \rfloor$. If n is odd, the final pair consists of two identical equations.

These equations are solved recursively. For $i = 0, 1, \dots$, we suppose we have found

$$a_0, \dots, a_{i-1}, \quad a_{n-i}, \dots, a_{n-1}, \quad r_0, \dots, r_{i-1}, \quad r_{n-1-i}, \dots, r_{n-2}, \tag{2.5}$$

and we attempt to find all possibilities for the four unknowns

$$a_i, a_{n-1-i}, r_i, r_{n-2-i}. \tag{2.6}$$

From Eq. (2.4) we have

$$\begin{aligned} k\mathbf{a}_i + r_{i-1} &\equiv \mathbf{a}_{n-1-i} \pmod{g}, \\ 0 &\leq \mathbf{a}_i + r_{n-1-i} g - k\mathbf{a}_{n-1-i} < k. \end{aligned} \tag{2.7}$$

where the unknowns a_i and a_{n-1-i} are shown in bold face for emphasis. By direct search, one finds all pairs a_i, a_{n-1-i} with $0 \leq a_i < g$, $0 \leq a_{n-1-i} < g$ that satisfy (2.7). For each such pair, define

$$\begin{aligned} r_i &= \frac{ka_i + r_{i-1} - a_{n-1-i}}{g}, \\ r_{n-2-i} &= a_i + r_{n-1-i} g - ka_{n-1-i}. \end{aligned} \tag{2.8}$$

2.2. The graph $H(g, k)$. We keep a record of the solutions in the form of a finite, directed graph. Young uses a potentially infinite tree for this, but a finite graph is more suitable for enumerating the solutions. The equations (2.7) involve r_{i-1} and r_{n-1-i} , but do not involve any of the other variables in (2.5) that we are assuming are known. So we take the nodes of the graph to be the ordered pairs $[r_{n-1-i}, r_{i-1}]$. There are potentially k^2 nodes $[r', r]$, with $0 \leq r' < k, 0 \leq r < k$. For each solution (2.6), we draw a directed edge from node $[r_{n-1-i}, r_{i-1}]$ to node $[r_{n-2-i}, r_i]$, with edge-label (a_{n-1-i}, a_i) :

$$[r_{n-1-i}, r_{i-1}] \xrightarrow{(a_{n-1-i}, a_i)} [r_{n-2-i}, r_i].$$

There may be zero, one or several solutions (2.6), and so zero, one or several edges emanating from a node.

It may happen that either a_i or a_{n-1-i} (or both) are 0 in a solution to (2.7). This is allowed only if $i \neq 0$ (since N may not begin or end with 0). To handle this problem, we introduce a special *starting node* $[[0, 0]]$ (written with double brackets, and indicated in the drawings by a slightly larger black circle), where we start the recursion, and which has the property that no edge emanating from it can have the label $(0, 0)$. The starting node has no incoming edges, by definition. If the starting node is included, there are a maximum of $k^2 + 1$ nodes in the Young graph. However, it is more natural to ignore the starting node and the edges emanating from it when discussing these graphs. The $(8, 5)$ Young graph in Fig. 6, for example, is best described as an 8-node, 16-edge graph.

The graph is then constructed by beginning at the starting node (with $i = 0$), and solving (2.7) recursively, until we have found all edges that emanate from every node we have encountered. If (g, k) -reverse multiples exist, an internal (non-starting) node $[0, 0]$ will always occur. The graph may also contain loops (a loop is an edge directed from a node to itself). However, there is at most one edge directed from any one node to another (see §2.7).

Let $H(g, k)$ denote the resulting directed graph. This is not yet the Young graph, for there is one further condition that must be satisfied.

2.3. Young's theorem. The following is a restatement of the main result of Young [21].

Theorem 2.1. (i) A (g, k) -reverse multiple exists if and only if the graph $H(g, k)$ contains either a node $[r, r]$ with $r \neq 0$, or a pair of nodes $[r', r] \rightarrow [r, r']$ joined by an edge, with $r' \neq r$.
(ii) The (g, k) -reverse multiples with an even number $n = 2t$ of digits are in one-to-one correspondence with paths that go from the starting node to a node $[r, r]$, where now r may be 0, as shown in Fig. 1.
(iii) The (g, k) -reverse multiples with an odd number $n = 2t + 1$ of digits are in one-to-one correspondence with paths that **either** go from the starting node to the first of a pair of adjacent nodes $[r', r] \rightarrow [r, r']$ with $r' \neq r$, as shown in Fig. 2, **or** go from the starting node to a node $[r, r]$ with a loop, where again r may be 0, as shown in Fig. 3.

We refer to [21] (Theorems 1, 2, 3 and Corollaries 1, 2) for the proof. We will call any node $[r, r]$ (including the non-starting node $[0, 0]$) an *even pivot node*, and any node $[r, r]$ with a loop (again r may be 0) or the initial node $[r', r]$ of a pair $[r', r] \rightarrow [r, r']$ with $r' \neq r$, an *odd pivot node*. For examples, see Figs. 4, 5, 6, 10, 11.

2.4. Young graphs. We can now construct the (g, k) Young graph. For it to exist, the graph $H(g, k)$ must contain at least one (even or odd) nonzero pivot node. If so, there may be some nodes ("dead ends") which can be reached from the starting node but which do not lead to

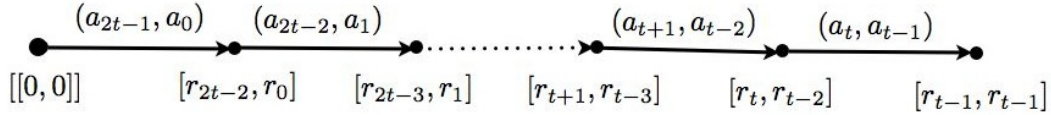

FIGURE 1. There is a one-to-one correspondence between these paths in the Young graph and reverse multiples with an even number of digits; $[r_{t-1}, r_{t-1}]$ is an even pivot node.

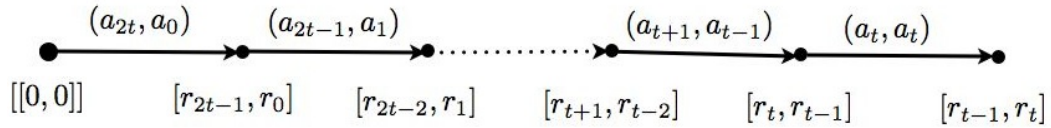

FIGURE 2. There is a one-to-one correspondence between the paths shown in this figure and Fig. 3 and reverse multiples with an odd number of digits. Here $r_t \neq r_{t-1}$; $[r_t, r_{t-1}]$ is an odd pivot node.

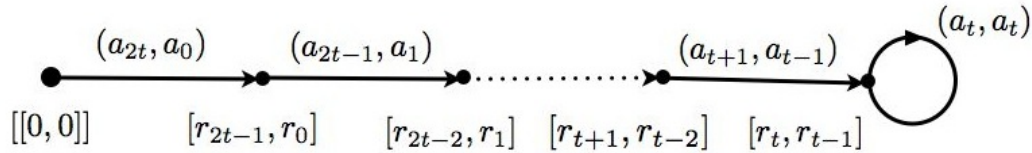

FIGURE 3. Here $r_t = r_{t-1}$; $[r_t, r_{t-1}]$ is an odd pivot node.

any pivot node. These nodes and all edges leading to them are now removed (or “pruned”) from $H(g, k)$: the result is the (g, k) Young graph.

Figures 4 and 5 show the $(10, 4)$ and $(10, 9)$ Young graphs. Here no pruning is necessary: these are the graphs $H(10, 4)$ and $H(10, 9)$. On the other hand, the graph $H(8, 3)$ (not shown) has seven nodes. One of them, however, has three incoming edges and no outgoing edges, and another has two incoming edges and no outgoing edges. When these two nodes and the five edges are removed, the result, the $(8, 3)$ Young graph, is the same graph that underlies Figs. 4 and 5 (with yet a third set of labels). $H(12, 7)$ (also not shown) is an example of a graph which contains no pivot nodes, so the $(12, 7)$ Young graph does not exist.

2.5. Correspondence between paths and (g, k) -reverse multiples. Once we have the (g, k) Young graph and a list of the pivot nodes, equations (2.2) and (2.4) imply that the correspondence between the paths of the three forms shown in Figs. 1, 2, 3 and the (g, k) -reverse multiples is as follows.

The path in Fig. 1. The right-most t digits a_0, \dots, a_{t-1} of the corresponding $2t$ -digit number N (see (1.1)) are obtained by reading the right-hand labels on the edges as we proceed from the starting node $[[0, 0]]$, following the arrows until we reach the pivot node $[r_{t-1}, r_{t-1}]$. The remaining t digits a_t, \dots, a_{2t-1} of N are obtained by reading the left-hand labels on the edges as we return to the starting node, going against the arrows, and exactly retracing the forward path.

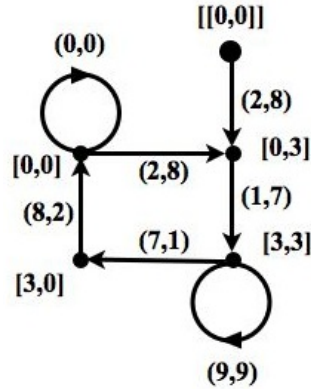

FIGURE 4. The $(10, 4)$ Young graph. $[0, 0]$ is both an even pivot node and an odd pivot node; so is $[3, 3]$.

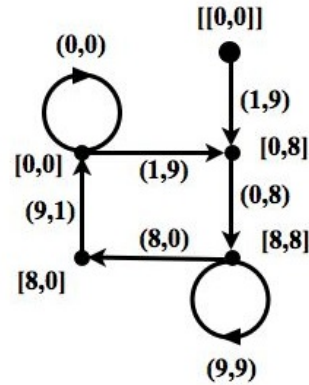

FIGURE 5. The $(10, 9)$ Young graph. $[0, 0]$ is both an even pivot node and an odd pivot node; so is $[8, 8]$.

Similarly, the check digits $r_{-1} = 0, r_0, \dots, r_{t-1}$ are obtained by reading the right-hand node labels along the path from the starting node to the pivot node, and the check digits $r_{t-2}, \dots, r_{2t-2}, r_{2t-1} = 0$ by reading the left-hand node labels as we return to the starting node going against the arrows. We use only one copy of the pair of identical labels r_{t-1} on the pivot node.

For example, consider the case $g = 8, k = 5$. The $(8, 5)$ Young graph is shown in Fig. 6. (In this case $H(8, 5)$ is the Young graph.) Look at the path $[[0, 0]] \rightarrow [0, 3] \rightarrow [1, 1] \rightarrow [3, 3]$ to the pivot node $[3, 3]$. Reading along the edge labels gives the number $N = (1, 0, 2, 5, 1, 5)_8$, and we verify that this is an $(8, 5)$ -reverse multiple by multiplying it by 5 mod 8:

$$\begin{array}{r}
 N \quad = \quad 1 \ 0 \ 2 \ 5 \ 1 \ 5 \\
 \qquad \qquad \qquad \qquad \qquad \qquad \times 5 \\
 \hline
 5N \quad = \quad 5 \ 1 \ 5 \ 2 \ 0 \ 1 \\
 \text{carries} = \quad 0 \ 0 \ 1 \ 3 \ 1 \ 3 \ 0
 \end{array}$$

The seven carry digits $r_{-1} = 0, r_0 = 3, r_1 = 1, \dots, r_4 = 0, r_5 = 0$ (reading from right to left) are shown at the bottom of the tableau, and match the node labels along the path.

The path in Fig. 2. Again, we first read the right-hand edge labels a_0, \dots, a_{t-1} on the path from the starting node to the pivot node $[r_t, r_{t-1}]$. Then we take a_t from the last edge in Fig. 2, and the remaining digits a_{t+1}, \dots, a_{2t} are obtained by reading the left-hand labels on the edges as we return to the starting node, going against the arrows. We only take one copy of a_t from the last edge in Fig. 2.

The check digits $r_{-1} = 0, \dots, r_{t-1}, r_t, \dots, r_{2t} = 0$ are obtained by reading the right-hand node labels along the path from the starting node to the pivot node, and then reading the left-hand node labels as we return to the starting node going against the arrows. The final node in Fig. 2 is not used when we record the check digits.

For example, consider the path $[[0, 0]] \rightarrow [0, 3] \rightarrow [1, 4] \rightarrow [4, 1]$ in Fig. 6 where $[1, 4]$ is the pivot node. Reading along the edge labels gives the number $N = (1, 1, 1, 6, 5)_8$, and again we verify that this is an $(8, 5)$ -reverse multiple:

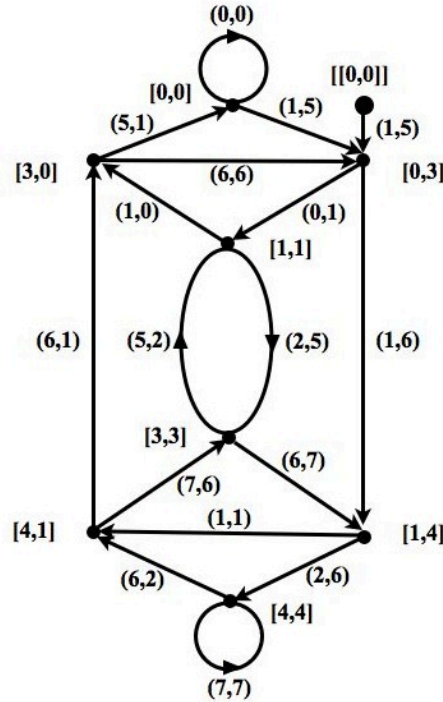

FIGURE 6. The $(8, 5)$ Young graph. Even pivot nodes: $[0, 0]$, $[1, 1]$, $[3, 3]$, $[4, 4]$; odd pivot nodes: $[0, 0]$, $[1, 4]$, $[3, 0]$, $[4, 4]$.

$$\begin{array}{r}
 N \quad = \quad 1 \ 1 \ 1 \ 6 \ 5 \\
 \qquad \qquad \qquad \qquad \times 5 \\
 \hline
 5N \quad = \quad 5 \ 6 \ 1 \ 1 \ 1 \\
 \hline
 \text{carries} \quad = \quad 0 \ 0 \ 1 \ 4 \ 3 \ 0
 \end{array}$$

The six carry digits $r_{-1} = 0, r_0 = 3, r_1 = 4, r_2 = 1, r_3 = 0, r_4 = 0$ (reading from right to left) are shown at the bottom of the tableau, and match the node labels along the path (ignoring the node $[4, 1]$).

The path in Fig. 3. Once again, we first read the right-hand edge labels a_0, \dots, a_{t-1} on the path from the starting node to the pivot node $[r_t, r_{t-1}]$. Then we take a_t from the loop, and the remaining digits a_{t+1}, \dots, a_{2t} are obtained by reading the left-hand labels on the edges as we return to the starting node, going against the arrows. We only take one copy of a_t from the loop.

Again, the check digits $r_{-1} = 0, \dots, r_{t-1}, r_t, \dots, r_{2t} = 0$ are obtained by reading the right-hand node labels along the path from the starting node to the pivot node, and then reading the left-hand node labels as we return to the starting node going against the arrows.

We give two examples. (i) In Fig. 6 consider the path $[[0, 0]] \rightarrow [0, 3] \rightarrow [1, 4] \rightarrow [4, 4]$ to the pivot node $[4, 4]$, using the loop at $[4, 4]$ once. Reading along the edge labels gives the number $N = (1, 1, 2, 7, 6, 6, 5)_8$, and we verify that this is an $(8, 5)$ -reverse multiple:

$$\begin{array}{r}
 N \qquad = \quad 1 \ 1 \ 2 \ 7 \ 6 \ 6 \ 5 \\
 \qquad \qquad \qquad \qquad \qquad \qquad \times 5 \\
 \hline
 5N \qquad = \quad 5 \ 6 \ 6 \ 7 \ 2 \ 1 \ 1 \\
 \hline
 \text{carries} = \quad 0 \ 0 \ 1 \ 4 \ 4 \ 4 \ 3 \ 0
 \end{array}$$

The eight carry digits $r_{-1} = 0, r_0 = 3, r_1 = 4, \dots, r_5 = 0, r_5 = 0$ (reading from right to left) are shown at the bottom of the tableau, and match the node labels along the path. Of course we could have traversed the loop at $[4, 4]$ any number of times: this would simply have increased the number of 7's in the middle of N .

(ii) Here is a more elaborate example, to illustrate the use of the (non-starting) node $[0, 0]$ as the pivot node. Consider the following path in Fig. 6 from the starting node $[[0, 0]]$ to the pivot node $[0, 0]$:

$$[[0, 0]] \rightarrow [0, 3] \rightarrow [1, 4] \rightarrow [4, 4] \rightarrow [4, 1] \rightarrow [3, 0] \rightarrow [0, 0].$$

We then follow the loop at $[0, 0]$ once. Reading along the edge labels gives the number $N = (1, 1, 2, 6, 6, 5, 0, 1, 1, 2, 6, 6, 5)_8$, and again we verify that this is an $(8, 5)$ -reverse multiple:

$$\begin{array}{r}
 N \qquad = \quad 1 \ 1 \ 2 \ 6 \ 6 \ 5 \ 0 \ 1 \ 1 \ 2 \ 6 \ 6 \ 5 \\
 \qquad \qquad \qquad \qquad \qquad \qquad \qquad \qquad \times 5 \\
 \hline
 5N \qquad = \quad 5 \ 6 \ 6 \ 2 \ 1 \ 1 \ 0 \ 5 \ 6 \ 6 \ 2 \ 1 \ 1 \\
 \hline
 \text{carries} = \quad 0 \ 0 \ 1 \ 4 \ 4 \ 3 \ 0 \ 0 \ 0 \ 1 \ 4 \ 4 \ 3 \ 0
 \end{array}$$

Returning to the base-10 case, by following the paths from the starting node in Fig. 4 to the two pivot nodes, we obtain all the $(10, 4)$ -reverse multiples, which are:

$$2178, 21978, 219978, 2199978, 21782178, 21999978, 217802178, 219999978, \dots, \quad (2.9)$$

and from Fig. 5 the $(10, 9)$ -reverse multiples:

$$1089, 10989, 109989, 1099989, 10891089, 10999989, 108901089, 109999989, \dots \quad (2.10)$$

See entries A008918, A001232, A008919 in the *On-Line Encyclopedia of Integer Sequences* [12] for more terms. (Six-digit numbers prefixed by A will always refer to entries in [12].) We return to the discussion of these numbers in §3.1 and §3.2.

2.6. Summary. The (g, k) -reverse multiples N with an *even* number of digits are in one-to-one correspondence with paths in the (g, k) Young graph that go from the starting node $[[0, 0]]$ to a pivot node $[r, r]$ by following the arrows, and then return to the starting node by exactly retracing the path, only now going against the arrows. The path may go through intermediate nodes (including pivot nodes that are not acting as pivots) any number of times, and may traverse edges any number of times.

The (g, k) -reverse multiples N with an *odd* number of digits have a similar description, only now the outward path ends at either a pivot node which is the first of a pair of adjacent nodes $[r', r] \rightarrow [r, r']$ (with $r' \neq r$) or a pivot node $[r, r]$ with a loop.

The resulting paths of course can get very complicated. The great merit of the transfer-matrix method (see §3) is that it makes it easy to count the paths of any length and so to find the number of reverse multiples with any given number of digits.

2.7. Properties of Young graphs. The following are some useful properties of Young graphs. Properties (P1) and (P3) were (essentially) stated and proved by Young [21], [22].

(P1) The label on an edge is determined by the labels on its two end-nodes. For we can solve (2.4) to obtain:

$$\begin{aligned} a_i &= \frac{kr_i g - kr_{i-1} + r_{n-1-i} g - r_{n-2-i}}{k^2 - 1}, \\ a_{n-1-i} &= \frac{kr_{n-1-i} g - kr_{n-2-i} + r_i g - r_{i-1}}{k^2 - 1}. \end{aligned} \tag{2.11}$$

(P2) There is at most one edge between any two nodes. This follows from (P1).

(P3) If the graph contains an edge $[r, s] \xrightarrow{(a,b)} [t, u]$ then it also contains nodes $[s, r]$ and $[u, t]$ and an edge $[u, t] \xrightarrow{(b,a)} [s, r]$. Sketch of proof: Let $N = (a_{n-1}, \dots, a_0)_g$ be a (g, k) -reverse multiple for which the corresponding path contains the first edge. Then $(a_{n-1}, \dots, a_0, a_{n-1}, \dots, a_0)_g$ is also a (g, k) -reverse multiple, and its path consists of the path for N followed by that same path with all the node-labels, edge-labels and arrows reversed, and therefore contains the second edge.

(P4) The graph always contains a (non-starting) node $[0, 0]$. This follows from (P3), since we have the node $[[0, 0]]$.

(P5) If the graph contains an edge $[r', r] \xrightarrow{(a,b)} [r, r']$ with $r' \neq r$, or if a node $[r, r]$ has a loop with label (a, b) , then $a = b$. Again this follows at once from (P3).

(P6) It follows from the definition of the Young graph that the node labels are all distinct. The edge labels are also all distinct. For suppose on the contrary that the same label appeared on two different edges:

$$[r_{n-1-i}, r_{i-1}] \xrightarrow{(a_{n-1-i}, a_i)} [r_{n-2-i}, r_i], \quad [s_{n-1-i}, s_{i-1}] \xrightarrow{(a_{n-1-i}, a_i)} [s_{n-2-i}, s_i].$$

From (2.11) we have

$$\begin{aligned} kr_i g - kr_{i-1} + r_{n-1-i} g - r_{n-2-i} &= ks_i g - ks_{i-1} + s_{n-1-i} g - s_{n-2-i}, \\ kr_{n-1-i} g - kr_{n-2-i} + r_i g - r_{i-1} &= ks_{n-1-i} g - ks_{n-2-i} + s_i g - s_{i-1}. \end{aligned}$$

If we collect terms, and subtract the second equation from k times the first equation, we obtain $g(r_i - s_i) = r_{i-1} - s_{i-1}$. If $r_i \neq s_i$, the left-hand side is greater than g in magnitude, while the right-side is not. So $r_i = s_i$, $r_{i-1} = s_{i-1}$. Similarly we obtain $r_{n-1-i} = s_{n-1-i}$ and $r_{n-2-i} = s_{n-2-i}$.

(P7) Sutcliffe [16, Theorem 2] shows that for $g \geq 4$, there is a two-digit (g, k) -reverse multiple for some k if and only if $g + 1$ is composite. This corresponds to an edge $[0, 0] \xrightarrow{(b,a)} [r, r]$ with $a = r(kg - 1)/(k^2 - 1)$, $b = r(g - k)/(k^2 - 1)$. (See also Conjecture 3.7 in §3.3.)

2.8. Further remarks. (i) The only difference between the $(10, 4)$ and $(10, 9)$ Young graphs (shown in Figs. 4 and 5) is in the labels on the nodes and edges. The underlying abstract directed graphs are the same and the pivot nodes are the same. In such a case we say that the two Young graphs are *isomorphic* (see also the first open question in §5).

(ii) Some of the references mention that fact that in base 10, reverse multiples are never prime (for example, $1089 = 3^2 \times 11^2$). In fact, no (g, k) -reverse multiple N can ever be prime, for if we add all the equations (2.2) and read the result mod $g - 1$, we find that $(k - 1) \sum_{i=0}^{n-1} a_i \equiv 0 \pmod{g - 1}$. This implies that N (see (1.1)) is a multiple of $g - 1$ (in the case $g = 10$, this is “casting out 9’s”).

3. COUNTING REVERSE MULTIPLES

3.1. **Adjacency matrices.** Let c_t denote the number of (g, k) -reverse multiples with t digits, with generating function

$$C(x) = \sum_{t \geq 0} c_t x^t, \tag{3.1}$$

and let $\mathcal{P}(x) = \sum_{t \geq 0} c_{2t} x^{2t}$, $\mathcal{Q}(x) = \sum_{t \geq 0} c_{2t+1} x^{2t+1}$, with $C(x) = \mathcal{P}(x) + \mathcal{Q}(x)$.

We will calculate these generating functions using the transfer-matrix method [15, §4.7]. Suppose the (g, k) Young graph has v nodes (including the starting node) and e edges. We label the nodes V_0, V_1, \dots, V_{v-1} , where we take V_0 to be the starting node $[[0, 0]]$ and V_1 to be the node $[0, 0]$. We then construct a $v \times v$ adjacency matrix A for the graph, by setting $A|_{i,j}$ equal to x^2 if there is a directed edge from V_i to V_j , and 0 otherwise (the entry is x^2 rather than x , because each edge is used twice, once in the direction of the arrow, once going against the arrow).

The key observation (this is the essence of the transfer-matrix method) is that if $V_i = [r, r]$ is a pivot node, the (V_0, V_i) entry of A^t will be $m x^{2t}$ if there are m paths of length t from the starting node to V_i , which by Theorem 2.1 means that there are m (g, k) -reverse multiples of length $2t$ for which the corresponding path has pivot node V_i .

The sum of the entries (V_0, V_i) in A^t over all pivot nodes $V_i = [r, r]$ is therefore equal to $c_{2t} x^{2t}$. Summing on t , we see that the generating function $\mathcal{P}(x)$ is the sum over all pivot nodes $V_i = [r, r]$ of the (V_0, V_i) entries in the matrix

$$B = A + A^2 + A^3 + \dots = A(I - A)^{-1}.$$

Similarly, $c_{2t+1} x^{2t+1}$ is equal to x times the sum of the entries (V_0, V_i) in A^t for which V_i is a pivot node for a reverse multiple with an odd number of digits (meaning V_i is either a node $[r, r]$ with a loop or the first of a pair of adjacent nodes $[r', r] \rightarrow [r, r']$ with $r' \neq r$). The generating function $\mathcal{Q}(x)$ is the sum of the (V_0, V_i) entries in B over all such pivot nodes.

For example, consider the $(10, 9)$ Young graph in Fig. 5. Let V_2, V_3, V_4 denote the nodes $[0, 8], [8, 8], [8, 0]$ respectively. The adjacency matrix A is

$$\begin{bmatrix} 0 & 0 & x^2 & 0 & 0 \\ 0 & x^2 & x^2 & 0 & 0 \\ 0 & 0 & 0 & x^2 & 0 \\ 0 & 0 & 0 & x^2 & x^2 \\ 0 & x^2 & 0 & 0 & 0 \end{bmatrix}.$$

The pivot nodes $[r, r]$ are V_1 and V_3 , and any computer algebra system will tell us that

$$B|_{0,1} = \frac{x^4(1-x^2)}{1-2x^2+x^4-x^8},$$

$$B|_{0,3} = \frac{x^8}{1-2x^2+x^4-x^8},$$

whose sum is the generating function for (10, 9)-reverse multiples with an even number of digits:

$$\begin{aligned} \mathcal{P}(x) &= \frac{x^4}{1 - x^2 - x^4} \\ &= \sum_{t=2}^{\infty} F_{t-1}x^{2t} \\ &= x^4 + x^6 + 2x^8 + 3x^{10} + 5x^{12} + 8x^{14} + \dots, \end{aligned} \tag{3.2}$$

where F_n is the n -th Fibonacci number.

Both V_1 and V_3 are also pivot nodes for reverse multiples with an odd number of digits, and so $\mathcal{Q}(x) = x\mathcal{P}(x)$, and

$$\begin{aligned} \mathcal{C}(x) &= \mathcal{P}(x) + \mathcal{Q}(x) \\ &= \frac{x^4(1+x)}{1 - x^2 - x^4} \\ &= \sum_{t=4}^{\infty} F_{\lfloor \frac{t}{2} \rfloor - 1} x^t \\ &= x^4 + x^5 + x^6 + x^7 + 2x^8 + 2x^9 + 3x^{10} + 3x^{11} + 5x^{12} + 5x^{13} + \dots. \end{aligned} \tag{3.3}$$

The coefficients form entry A103609 in [12].

Isomorphic Young graphs have the same generating function, so the generating function for the number of (10, 4)-reverse multiples is also given by (3.3).

If we are only interested in the number of base-10 reverse multiples with t digits, regardless of the multiplier, the generating function is

$$\frac{2x^4(1+x)}{1 - x^2 - x^4} = 2x^4 + 2x^5 + 2x^6 + 2x^7 + 4x^8 + 4x^9 + 6x^{10} + 6x^{11} + 10x^{12} + 10x^{13} + \dots, \tag{3.4}$$

with coefficients $2F_{\lfloor \frac{t}{2} \rfloor - 1}$ that are twice Fibonacci numbers. The first 2 refers to the two numbers in the Hardy story mentioned in the opening paragraph. Would this generating function have changed Hardy’s opinion of the problem?

3.2. The “1089” graph. We call any Young graph that is isomorphic to the (10, 4) and (10, 9) graphs of Figs. 4 and 5 a *1089 graph*. As can be seen from the entries labeled a in Table 1 of §4, there are many occurrences of this graph. If true, the following conjecture would explain all these cases.

Conjecture 3.1. *A necessary and sufficient condition for the (g, k) Young graph to be isomorphic to the 1089 graph is that $k + 1$ divides g .*

The conjecture is certainly true for $g \leq 40$. Checking the conjecture for larger values of g is laborious, because many of the larger graphs $H(g, k)$ require extensive pruning before the Young graph can be identified.

The next theorem characterizes the reverse multiples arising from the 1089 graph.

Theorem 3.2. *If $k+1$ divides g , and the (g, k) Young graph is the 1089 graph, let $b = g/(k+1)$. (i) The labels on the Young graph are obtained by replacing the numbers 1, 2, 3, 7, 8 and 9 on the (10, 4) Young graph shown in Fig. 4 by $b - 1$, b , $k - 1$, $kb - 1$, kb and $g - 1$, respectively. The two pivot nodes have labels $[0, 0]$ and $[k - 1, k - 1]$. (ii) The generating function $\mathcal{C}(x)$ is given by (3.3). (iii) The (g, k) -reverse multiples are all the numbers of the form $\gamma\beta$, where*

$\gamma = b(g^2 - 1) = (b - 1, g - 1, kb)_g$ and β is any positive number whose base- g expansion is palindromic, contains only the digits 0 and 1, and does not contain any single 0's or 1's (i.e., any run of consecutive equal digits must have length at least 2). (iv) The shortest reverse multiple has length 4, and there are $F_{\lfloor \frac{t}{2} \rfloor - 1}$ reverse multiples of length $t \geq 4$.

Proof. (i) Let $N_0 = (b, b - 1, kb - 1, kb)_g$. The following calculation shows that N_0 is a (g, k) -reverse multiple, and via Theorem 2.1 gives the labels on the Young graph:

$$\begin{array}{rcccccccc} N_0 & = & & b & & b - 1 & & kb - 1 & & kb \\ & & & & & & & & & \times k \\ \hline kN_0 & = & & kb & & kb - 1 & & b - 1 & & b \\ \hline \text{carries} & = & 0 & 0 & & k - 1 & & k - 1 & & 0 \end{array}$$

(ii) The generating function (which does not depend on the labels) was calculated in §3.1. (iii) Let W_n denote the number

$$(b, b - 1, g - 1, g - 1, \dots, g - 1, g - 1, kb - 1, kb)_g,$$

with $n - 4$ copies of $g - 1$ in the center of the number (so $W_4 = N_0$). Inspection of the possible paths in the 1089 graph from the starting node to either of the pivot nodes shows that every (g, k) -reverse multiple has a unique representation as a nonempty ‘word’ over the ‘alphabet’ $\{0, W_4, W_5, W_6, \dots\}$, using the terminology of formal language theory, cf. [11]. For the path to the first pivot gives W_4 . Going around the loop at this pivot several times changes W_4 to W_5, W_6, \dots . Proceeding to the next pivot introduces another W_4 , going around the loop at the second pivot introduces 0's into the number, and so on. The reverse multiples of lengths 4 through 10 are $W_4, \dots, W_8, W_9, W_4 0 W_4, W_{10}, W_5^2, W_4 0^2 W_4$.

It is easy to see that $W_n = \gamma \times (1, 1, \dots, 1)_g$, with $n - 2$ 1's, where $\gamma = (b - 1, g - 1, kb)_g$, $W_n 0 W_n = \gamma \times (1, 1, \dots, 1, 0, 0, 1, \dots, 1)_g$, and so on. We conclude that any (g, k) reverse multiple is equal to $\gamma \times \beta$, where β is a positive number whose base- g expansion contains only 0's and 1's, is palindromic, and consists of strings of 1's of length at least 2, separated by strings of 0's of length at least 2. (iv) This follows at once from the Taylor series expansion of the generating function. \square

We can now give a direct explanation for why the Fibonacci numbers arise in this problem. It is enough to consider the reverse multiples of even length, with generating function (3.2). Let u_n denote the number of length- $(2n)$ choices for β . It is easy to see that $u_n = u_{n-1} + u_{n-2}$ for $n \geq 3$. (Look at the left-hand halves $u_1 \dots u_n$ of the strings β . The strings of length n are obtained by mapping strings $u_1 \dots u_{n-2}$ of length $n - 2$ to $u_1 u_2 \dots u_{n-2} u_{n-2} (1 - u_{n-2})$, and strings $u_1 \dots u_{n-1}$ of length $n - 1$ to $u_1 u_2 \dots u_{n-1} u_{n-1}$.) Since this is also the recurrence for the Fibonacci numbers, we have $u_n = F_n$.

As an illustration, consider the case $g = 10$. The divisors of 10 are 1, 2, 5 and 10, and so the conjecture asserts, correctly, that for $k = 4$ and $k = 9$ the Young graph is the graph under discussion. When $k = 4$, we have $b = 10/5 = 2$, $\gamma = 2(10^2 - 1) = 198$, and the theorem asserts, again correctly, that the $(10, 4)$ -reverse multiples, given in (2.9), are 198 times one of the base-10 numbers

$$11, 111, 1111, 11111, 110011, 111111, 1100011, 1111111, 11000011, 11100111, \dots \tag{3.5}$$

that are palindromic and contain no singleton 0's or 1's (see A061851). Similarly, when $k = 9$, $b = 1$, $\gamma = 99$, and the $(10, 9)$ -reverse multiples, given in (2.10), are 99 times the numbers in (3.5).

Conjecture 3.1 is certainly true when $k = g - 1$:

Theorem 3.3. *(g, g - 1)-reverse multiples exist for every $g \geq 3$, and the (g, g - 1) Young graph is the 1089 graph.*

Proof. (Sketch.) It is easy to find all solutions to (2.7) when $k = g - 1$. We must start with $a_{n-1} = 1$, $a_0 = g - 1$ (or else $(k - 1)a_{n-1}$ would exceed g). This implies $r_0 = g - 2$, $r_{n-2} = 0$. Next, with $i = 1$, the equations (2.7) become $a_1 + a_{n-2} + 2 \equiv 0 \pmod{g}$, $0 \leq a_1 - (g - 1)a_{n-2} < g - 1$. If $a_{n-2} \geq 1$ then $a_1 \geq g - 1$, implying $a_1 = g - 1$, and the equivalence has no solution. Therefore $a_{n-2} = 0$, which implies $a_1 = g - 1$ and then $r_1 = r_{n-3} = g - 2$. Continuing in this way we find that the graph in Fig. 5 contains all possible solutions. We omit the details. \square

The next result is related to Conjecture 3.1.

Theorem 3.4. *If N (given by (1.1)) is a (g, k)-reverse multiple then $a_0 + a_{n-1} \leq g$. If $a_0 + a_{n-1} = g$ then $k + 1$ divides g .*

Proof. The 0-th pair in (2.4) states that

$$ka_0 = a_{n-1} + r_0g, \quad ka_{n-1} + r_{n-2} = a_0. \tag{3.6}$$

Hence $(k - 1)(a_0 + a_{n-1}) = r_0g - r_{n-2}$, and so, since $r_0 \leq k - 1$,

$$a_0 + a_{n-1} = \frac{r_0g - r_{n-2}}{k - 1} \leq g.$$

If equality holds then $r_0 = k - 1$, $r_{n-2} = 0$, and (3.6) gives $(k^2 - 1)a_{n-1} = g(k - 1)$, and so $k + 1$ divides g . \square

If true, Conjecture 3.1 would imply that the converse holds: if $k + 1$ divides g , then any (g, k) -reverse multiple satisfies $a_0 + a_{n-1} = g$ (since then, by Theorem 3.2, $a_0 = kb$ and $a_{n-1} = b$).

The next conjecture would follow from Conjecture 3.1 and Theorem 3.4. We state it as a separate conjecture since it will be used in §3.4. It may also have a proof independent of Conjecture 3.1.

Conjecture 3.5. *If there is a (g, k)-reverse multiple with $a_0 + a_{n-1} = g$ then the Young graph is the 1089 graph. If the graph is the 1089 graph then every reverse multiple satisfies $a_0 + a_{n-1} = g$.*

3.3. The complete Young graphs K_m . Another frequently occurring Young graph is the complete graph K_m . This is the complete directed graph on m nodes, with a directed edge from every node to every node, for a total of m^2 edges, together with the starting node $[[0, 0]]$ which is connected to every node except $[0, 0]$. Every node (except the starting node) has a loop and is both an even and odd pivot. The (5, 2) Young graph K_2 and the (11, 3) Young graph K_3 are shown in Figs. 7 and 8.

As a second illustration of the transfer-matrix method, consider the (5, 2) graph K_2 . The adjacency matrix A (taking the nodes in the order $[[0, 0]]$, $[0, 0]$, $[1, 1]$) is

$$\begin{bmatrix} 0 & 0 & x^2 \\ 0 & x^2 & x^2 \\ 0 & x^2 & x^2 \end{bmatrix}. \tag{3.7}$$

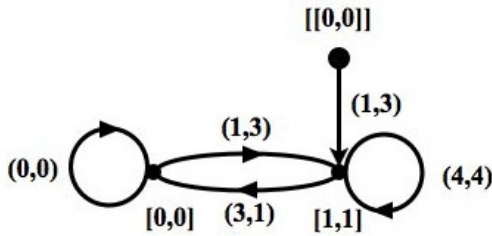

FIGURE 7. The $(5, 2)$ Young graph, the complete graph K_2 on two nodes plus the starting node.

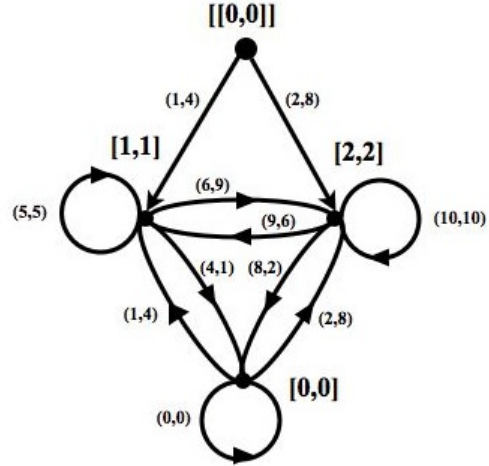

FIGURE 8. The $(11, 3)$ Young graph, the complete graph K_3 on three nodes plus the starting node.

Then

$$\begin{aligned}
 \mathcal{P}(x) &= B|_{0,1} + B|_{0,2} \\
 &= \frac{x^4}{1-2x^2} + \frac{x^2(1-x^2)}{1-2x^2} \\
 &= \frac{x^2}{1-2x^2} \\
 &= x^2 + 2x^4 + 4x^6 + 8x^8 + 16x^{10} + \dots,
 \end{aligned}
 \tag{3.8}$$

and

$$\begin{aligned}
 \mathcal{C}(x) &= (1+x)\mathcal{P}(x) = \frac{x^2(1+x)}{1-2x^2} \\
 &= x^2 + x^3 + 2x^4 + 2x^5 + 4x^6 + 4x^7 + 8x^8 + 8x^9 + \dots.
 \end{aligned}
 \tag{3.9}$$

In this case it is easy to explain the coefficients: at each step in a path there are two choices for the next node.

The following result gives a partial characterization of those Young graphs that are complete graphs.

Theorem 3.6. *A necessary and sufficient condition for a Young graph to be a complete graph is that every node label has the form $[r, r]$.*

Proof. (i) Suppose the Young graph is a complete graph, but there is a node labeled $[r', r]$ with $r' \neq r$. By (P5), the edge from $[r', r]$ to $[r, r']$ has label (i, i) for some i , and the edge from $[r, r']$ to $[r', r]$ is also labeled (i, i) . Suppose the edge from $[[0, 0]]$ to $[r', r]$ is labeled (j, h) , and consider the path

$$[[0, 0]] \xrightarrow{(j,h)} [r', r] \xrightarrow{(i,i)} [r, r'].$$

Taking the right-hand node $[r, r']$ to be the pivot, we see that $N = (j, i, i, i, h)_g$ is a (g, k) -reverse multiple. Equations (2.4) imply $kh = j + rg$, $ki + r = i + r'g$, $ki + r' = rg + i$, and the latter two equations imply $(r' - r)g = r - r'$, so $r = r'$, a contradiction.

(ii) Conversely, suppose all node labels have the form $[r, r]$. Since the graph is connected, there is an edge $[[0, 0]] \xrightarrow{(b,a)} [r, r]$ for some r . From (2.11), $a = r(kg - 1)/(k^2 - 1)$, $b = r(g - k)/(k^2 - 1)$, which imply $a + b = r(g - 1)/(k - 1) \leq g - 1$, and so $N = (b, a + b, a)_g$ is a (g, k) -reverse multiple, and therefore there is a loop at $[r, r]$ with edge-label $(a + b, a + b)$. Similar arguments show that if there are edges $[[0, 0]] \xrightarrow{(b,a)} [r, r]$ and $[[0, 0]] \xrightarrow{(d,c)} [s, s]$, then there is an edge $[r, r] \xrightarrow{(a+d,b+c)} [s, s]$; and if there is a pair of edges $[[0, 0]] \xrightarrow{(b,a)} [r, r] \xrightarrow{(f,e)} [s, s]$, then there is an edge $[[0, 0]] \xrightarrow{(f-a,e-b)} [s, s]$. Iterating these arguments shows that there is a directed edge between every pair of nodes, and every node has a loop. \square

If true, the following conjecture, would explain when the complete graph K_m occurs:

Conjecture 3.7. *A necessary and sufficient condition for the (g, k) Young graph to be the complete graph K_m is that there are exactly $m - 1$ distinct integers r such that*

$$a = r \frac{kg - 1}{k^2 - 1} < g \text{ and } b = r \frac{g - k}{k^2 - 1} \tag{3.10}$$

are positive integers.

Theorem 3.8. (i) *If the conditions of Conjecture 3.7 hold and the (g, m) Young graph is the complete graph K_m , then (ignoring the starting node) the node labels are $[ir_0, ir_0]$, $0 \leq i \leq m - 1$, where r_0 is the smallest of the $m - 1$ values of r . The edge from the starting node (or from the node $[0, 0]$) to $[ir_0, ir_0]$ has label $(ir_0(g - k)/(k^2 - 1), ir_0(kg - 1)/(k^2 - 1))$. (ii) The generating function $\mathcal{C}(x)$ is*

$$\frac{(m - 1)x^2(1 + x)}{1 - mx^2} = (m - 1)(x^2 + x^3 + mx^4 + mx^5 + m^2x^6 + m^2x^7 + m^3x^8 + \dots). \tag{3.11}$$

(iii) *The (g, k) -reverse multiples are all numbers of the form $\gamma\beta$, where $\gamma = (r_0(g - k)/(k^2 - 1), r_0(kg - 1)/(k^2 - 1))_g$ and β is any positive number whose base- g expansion is palindromic and contains only the digits $0, 1, \dots, m - 1$.*

Proof. (Sketch) (i) The only thing to be proved is that the values of r are multiples of the smallest value, r_0 , but this is easily shown. (ii) This follows from the adjacency matrix, analogous to the proof of (3.9). (iii) From the Young graph we know γ is the smallest reverse multiple and that all the two-digit reverse multiples are the numbers $i\gamma$ for $1 \leq i \leq m - 1$. If we write $\gamma = (b, a)_g$, then as in the proof of Theorem 3.6 we have $(m - 1)(a + b) < g$. This means that when we calculate $\gamma\beta$ (where β is as in the statement of the theorem) by ‘long multiplication’, there are no carries. We know $k\gamma = \text{Reverse}(\gamma)$. Since there are no carries, $k\gamma\beta = (k\gamma)\beta = \text{Reverse}(\gamma)\beta = \text{Reverse}(\gamma\beta)$, showing that $\gamma\beta$ is a reverse multiple. On the other hand a counting argument shows that the generating function for the number of β ’s of given length is equal to (3.11) with the factor x^2 in the numerator replaced by x . The generating function for the $\gamma\beta$ ’s therefore coincides with (3.11), and it follows that we have found all the reverse multiples. \square

It appears that the first occurrence of K_m is when $g = m^2 + m - 1$ and $k = m$ (and the values of r in (3.10) are simply 1 through $m - 1$). This is certainly true for $m \leq 9$, and explains the $(5, 2)$, $(11, 3)$, $(19, 4)$, $(29, 5)$, $(41, 6)$, ... Young graphs.

We end this section with a conjecture which is much stronger than the result in Theorem 3.6. It is, however, consistent with all the data.

Conjecture 3.9. *A necessary and sufficient condition for a Young graph to be a complete graph is that there is at least one node label $[r, r]$, $r \neq 0$.*

3.4. The cyclic Young graphs Z_m . The complete graphs described in the previous section have the maximum number of edges for the given number of nodes. In the other direction, if there are $m \geq 3$ nodes (not counting the starting node) then it appears that the *minimum* number of edges in any Young graph is $m + 2$. This is certainly true for $g \leq 100$.

Furthermore, it appears that a Young graph with $m \geq 3$ nodes and $m + 2$ edges is always the “cyclic” graph Z_{m-1} , which we define to consist of a directed cycle of $m - 1$ nodes, in which one of the edges is paralleled by a path of length two passing through the node $[0, 0]$, where there is a loop. We also define Z_1 to be C_2 , the two-node complete graph in Fig. 7. The graphs Z_2, Z_3, Z_4 are shown in Fig. 9 and Z_5 in Fig. 12. In Z_m , the node $[0, 0]$ is always an odd pivot. If $m > 1$ is odd there are two even pivot nodes, namely $[0, 0]$ and the node half-way around the cycle (e.g., $[8, 8]$ in Z_3). If m is even, $[0, 0]$ is the only even pivot node and there is a second odd pivot half-way around the cycle (e.g., $[5, 10]$ in Z_4).

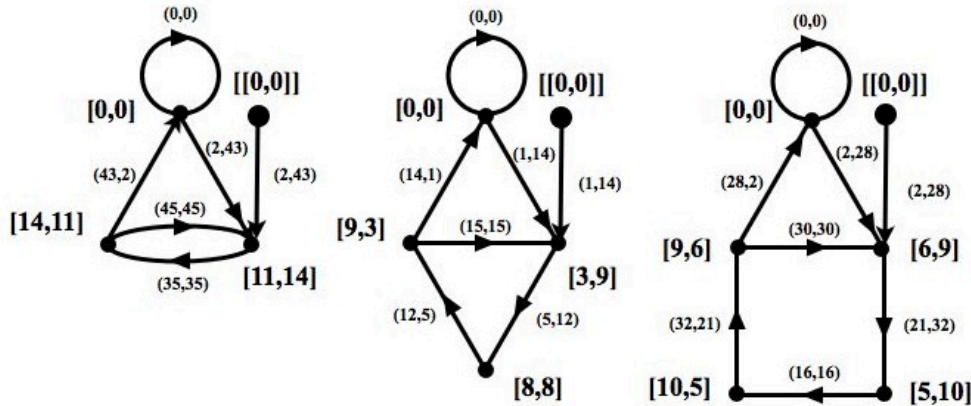

FIGURE 9. Cyclic $(49,16)$, $(17,11)$ and $(34,11)$ Young graphs Z_2, Z_3 and Z_4 .

These cyclic graphs appear to be harder to analyze than the complete graphs: we have no analog of Conjecture 3.7 and only a conjectural analog of Theorem 3.8. The sequence of pairs (g, k) where the cyclic graphs Z_1, Z_2, \dots, Z_9 first occur is

$$(5, 2), (49, 16), (17, 11), (34, 11), (18, 7), (33, 14), (49, 39), (77, 46), (63, 40), \tag{3.12}$$

which has no apparent pattern.

Conjecture 3.10. (i) *For $m \geq 1$, there exists a pair (g, k) for which the Young graph is Z_m .*
(ii) *If the (g, k) Young graph is K_m , then the generating function $C(x)$ is*

$$C(x) = \frac{x^{m+1}(1+x)(1-x+x^m)}{1-x^2-x^{2m}}. \tag{3.13}$$

(iii) *Let γ denote the smallest reverse multiple, of length $m + 1$. The (g, k) -reverse multiples are all numbers of the form $\gamma\beta$, where β is any positive number whose base- g expansion is*

palindromic and contains only the digits 0 and 1, does not contain 11, and in which any run of consecutive 0's has length at least $m - 1$.

Parts (ii) and (iii) would be a theorem if Conjecture 3.5 were known to be true. The proof would be similar to that of Theorem 3.8. We obtain the generating function from the adjacency matrix, which is a bordered circulant matrix. The smallest reverse multiple γ can be read off the graph. The difficulty lies in showing that $\gamma\beta$ is a reverse multiple: for this we need to know that the sum of the first and last digits of γ is less than g , which would follow from Theorem 3.4 and Conjecture 3.5. The final step in the proof uses a simple counting argument to show that if u_n denotes the number of length- n choices for β , then $u_n = u_{n-2} + u_{n-2m}$, giving a generating function which coincides with (3.13), and showing that we have indeed found all the reverse multiples. (The sequence $\{u_n\}$ is C-finite, and the 'C-finite Ansatz' [9], [23] makes this final step routine.)

4. RESULTS FOR BASES $g \leq 20$.

A computer was used to find all values of k for which a (g, k) -reverse multiple exists, for $g \leq 100$, and (with one exception) to determine the generating functions $\mathcal{P}(x)$, $\mathcal{Q}(x)$, $\mathcal{C}(x)$ for the numbers of reverse multiples. The calculations were carried out using Maple 16. The main program computed the graphs $H(g, k)$, but did not do any pruning, since the dead ends do not affect the generating functions. Up to $g = 100$, the two largest graphs are $H(58, 45)$, with 588 nodes and 640 edges, and $H(99, 68)$, with 784 nodes and 848 edges. The program was able to compute the generating functions for all except $H(99, 68)$, where it was unable to compute the matrix B .

Two other programs were used to prune the graphs (for $g \leq 40$) and to make a list of the first 50 or so reverse multiples by following the paths through the graph. (Although there is an algorithm for enumerating the paths through a directed graph [14], it does not work well on graphs with as many circuits as these Young graphs.)

The results for $g \leq 20$ are summarized in Table 1. For an extended version of this table, see entry A222817 in [12]; the number of values of k for each g is given in A222819.

g	k	g	k
3	2^a	12	$2^a, 3^a, 5^a, 11^a$
4	3^a	13	$5^b, 6^b, 12^a$
5	$2^b, 4^a$	14	$2^b, 3^j, 4^b, 6^a, 9^j, 13^a$
6	$2^a, 5^a$	15	$2^a, 3^b, 4^a, 7^b, 11^h, 14^a$
7	$3^b, 6^a$	16	$3^a, 7^a, 15^a$
8	$2^b, 3^a, 5^h, 7^a$	17	$2^b, 4^i, 5^c, 8^b, 10^i, 11^e, 16^a$
9	$2^a, 4^b, 8^a$	18	$2^a, 5^a, 7^f, 8^a, 17^a$
10	$4^a, 9^a$	19	$3^c, 4^d, 6^i, 7^b, 9^b, 14^m, 18^a$
11	$2^b, 3^c, 5^b, 7^i, 10^a$	20	$2^b, 3^a, 4^a, 6^b, 9^a, 13^j, 19^a$

TABLE 1. (g, k) values for which reverse multiples exist for $g \leq 20$; letters specify the Young graph. See A222817, A222819 in [12] for $g \leq 100$.

For $g \leq 20$, up to isomorphism, only ten different Young graphs appear, indicated in Table 1 by superscripts a, b, c, \dots . The meaning of these letters is given below. In this list we do not

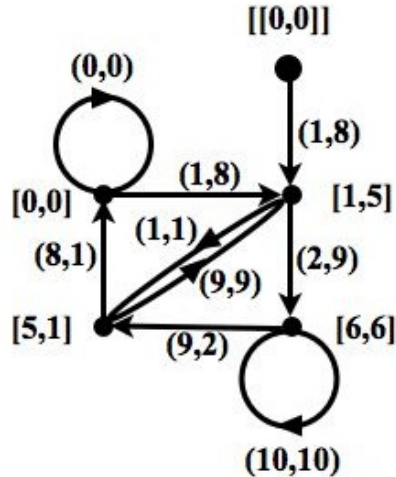

FIGURE 10. The (11, 7) Young graph. All nodes are pivot nodes.

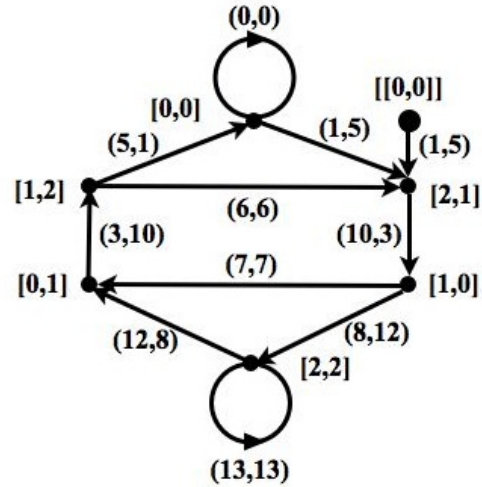

FIGURE 11. The (14, 3) Young graph. Even pivot nodes: [0, 0], [2, 2]; odd pivot nodes: [0, 0], [1, 0], [1, 2], [2, 2].

count the starting node or the edges connected to it when giving the numbers of nodes and edges. All the graphs in the table are palindromic (see §1). If the graph is the 1089 graph or a complete or cyclic graph, the exact form of the reverse multiples has already been discussed.

- a. The 1089 graph (§3.2).
- b, c, d. The complete graphs K_2, K_3, K_4 (§3.3).
- e, f. The cyclic graphs Z_3, Z_5 (§3.4).
- h. The graph shown in Fig. 6, with eight nodes and 16 edges. The generating function is

$$\mathcal{C}(x) = \frac{x^4(1+x)}{1-2x^2} = x^4 + x^5 + 2x^6 + 2x^7 + 4x^8 + 4x^9 + 8x^{10} + 8x^{11} + \dots \quad (4.1)$$

The reverse multiples are the numbers $\gamma\beta$, where $\gamma = (1, 0, 1, 5)_8$ if $(g, k) = (8, 5)$, $\gamma = (1, 0, 2, 11)_{15}$ if $(g, k) = (15, 11)$, and the base- g expansion of β is palindromic and contains only 0's and 1's.

- i. The graph shown in Fig. 10, with four nodes and eight edges, and

$$\mathcal{C}(x) = \frac{x^3(1+x)}{1-2x^2} = x^3 + x^4 + 2x^5 + 2x^6 + 4x^7 + 4x^8 + 8x^9 + 8x^{10} + \dots \quad (4.2)$$

This is the first time that the smallest (g, k) -reverse multiple has an odd number of digits (e.g., the $(11, 7)$ -reverse multiple $(1, 1, 8)_{11}$). At first this is rather worrying, since the Sutcliffe-Kaczynski theorem ([16], [8], [13]) states that if there is a 3-digit reverse multiple then there is also a two-digit reverse multiple.¹ The explanation is that their theorem allows one to change the multiplier k . Here there is a three-digit $(11, 7)$ -reverse multiple. There are no two-digit $(11, 7)$ -reverse multiples, but there *is* a two-digit $(11, 3)$ -reverse multiple, $(1, 4)_{11}$.

¹The assertion in [13] that Kaczynski shows that “if there exists a 3-digit solution . . . , then deleting the middle digit gives a 2-digit solution” is based on a mis-reading of [8].

For this graph the reverse multiples are the numbers $\gamma\beta$, where the base- g expansion of β is again a binary palindrome, and γ is a 3-digit number ($(1, 1, 8)_{11}$ if $(g, k) = (11, 7)$, $(2, 5, 9)_{17}$ if $(g, k) = (17, 4)$, ...).

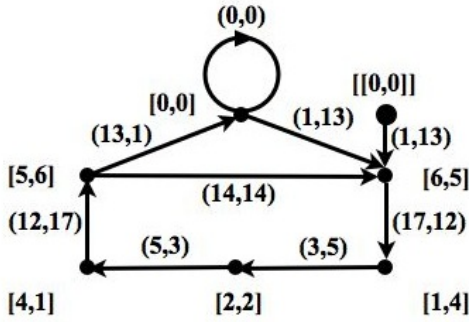

FIGURE 12. The $(18, 7)$ Young graph Z_5 .

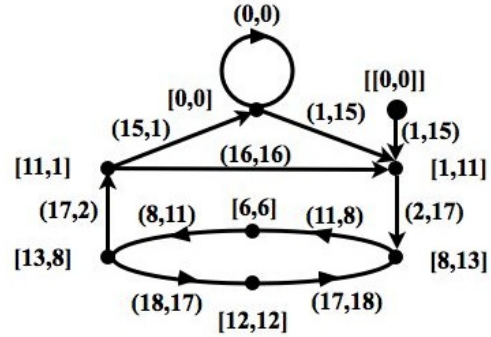

FIGURE 13. The $(19, 14)$ Young graph.

j. The graph shown in Fig. 11, with six nodes and ten edges, and

$$\mathcal{C}(x) = \frac{x^5(1+x)}{1-x^2-x^4} = x^5+x^6+x^7+x^8+2x^9+2x^{10}+3x^{11}+3x^{12}+5x^{13}+5x^{14}+8x^{15}+\dots \quad (4.3)$$

The (g, k) -reverse multiples are the numbers $\gamma\beta$, where γ is a 4-digit number (e.g., $(1, 8, 12, 5)_{14}$ if $(g, k) = (14, 3)$) and the base- g expansion of β is palindromic, binary, and does not contain any single 0's or 1's. As in the case of the 1089 graph, γ is not itself a reverse multiple.

m. The graph shown in Fig. 13, with seven nodes and ten edges;

$$\mathcal{C}(x) = \frac{x^6(1+x)(1-x+x^4)}{1-x^2-x^8} = x^6+x^{10}+x^{11}+x^{12}+x^{13}+2x^{14}+x^{15}+2x^{16}+x^{17}+\dots \quad (4.4)$$

where the coefficients satisfy $c_t = c_{t-2} + c_{t-8}$ for $n > 11$ (A226517). This is x times the generating function for Z_4 . The reverse multiples are the numbers $\gamma\beta$, where β is palindromic, binary, and does not contain any run of 0's of length less than 3 or any pair of adjacent 1's. For $(g, k) = (19, 14)$, $\gamma = (1, 2, 11, 8, 17, 15)_{19}$.

For $g > 20$ more complicated graphs appear. We give three further examples.

For $(g, k) = (24, 13)$, the graph $H(24, 13)$ has (ignoring the starting node) 24 nodes and 36 edges. Eight nodes disappear during the pruning process, and the resulting 16-node 26-edge Young graph is shown in Fig. 14. The pivot nodes are $[0, 0]$, $[3, 12]$, $[5, 5]$, $[5, 12]$, $[7, 0]$, $[7, 7]$, $[9, 0]$, and $[12, 12]$. The generating function is surprisingly simple:

$$\mathcal{C}(x) = \frac{x^9(1+x)}{1-x^2-x^6} = x^9+x^{10}+x^{11}+x^{12}+x^{13}+x^{14}+2x^{15}+2x^{16}+3x^{17}+3x^{18}+4x^{19}+\dots \quad (4.5)$$

and the reverse multiples are the numbers of the form $\gamma\beta$, where $\gamma = (23, 9, 8, 0, 16, 13)_{24}$ and β is any positive number whose base-24 expansion is palindromic, contains only 0's and 1's, and in which any run of 0's and 1's has length at least 3. The smallest $(24, 13)$ -reverse multiple is the nine-digit number $(1, 0, 9, 16, 18, 1, 6, 5, 13)_{24} = \gamma(1, 1, 1)_{24}$, which we can read off the path from the starting node to the closest pivot, $[9, 0]$. The coefficients in (4.5) are essentially

the fourteenth-century Narayana cows sequence (A000930) repeated, just as the coefficients in (3.3) and (4.3) are the thirteenth-century Fibonacci rabbits sequence (A000045) repeated.

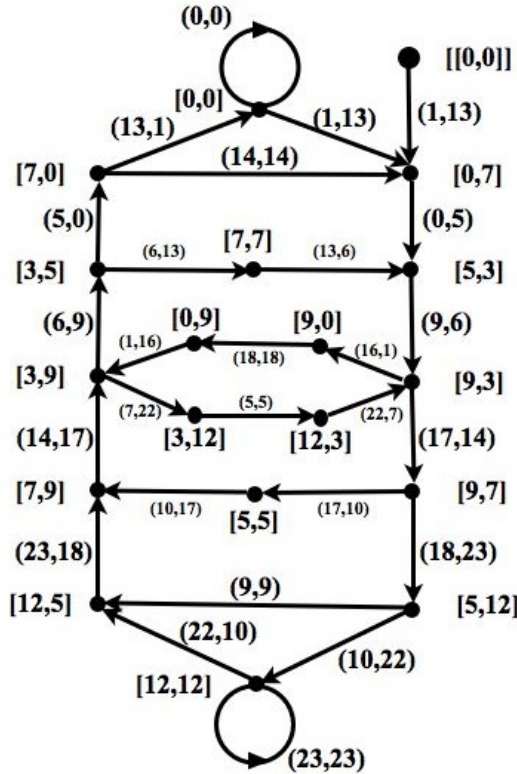

FIGURE 14. The (24, 13) Young graph.

The second example is the (24, 17) Young graph, which after pruning has 26 nodes and 34 edges, and is shown in Fig. 15. Only the node-labels are shown, to avoid making the diagram too cluttered. The edge-labels can be obtained from (2.11). The generating function is

$$C(x) = \frac{x^{12}(1+x)}{1-x^2-x^{10}-x^{14}-x^{16}}. \tag{4.6}$$

This is the smallest example of a Young graph that is not palindromic: there is no value of γ such that the reverse multiples divided by γ are all palindromic in base 24 (one has only to check the divisors γ of the greatest common divisor of the first few reverse multiples, and none of them work).

The third example is the (40, 13) Young graph, with 15 nodes and 22 edges, shown in Fig. 16, which we mention because it is the largest example discussed by Young [22, p. 174]. Again only the node-labels are shown. Figure 16 shows the structure of these (40, 13)-reverse multiples far more clearly than Young’s tree. The generating function is

$$C(x) = \frac{x^5(1+x)(1-x^2+x^4+2x^6)}{1-x^2-x^8-2x^{10}}. \tag{4.7}$$

This example is also not palindromic.

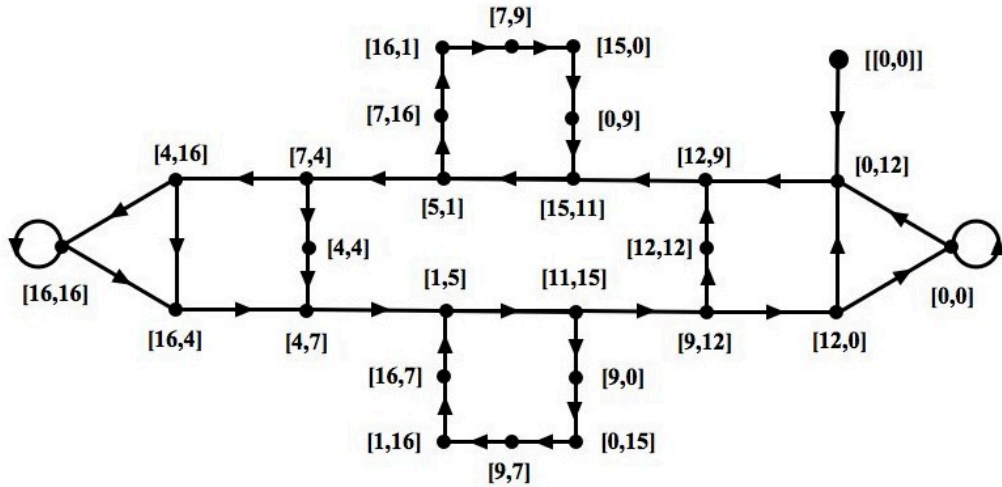

FIGURE 15. The (24, 17) Young graph.

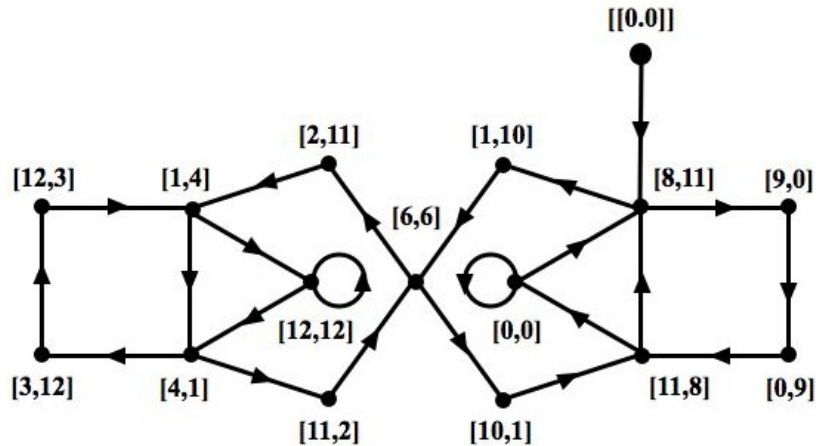

FIGURE 16. The (40, 13) Young graph.

5. OPEN QUESTIONS

This extension of Young’s work [21], [22] has helped clarify the properties of reverse multiples, but it also raises a number of questions. Besides the conjectures in Section 3, we mention three other open problems.

(i) Does the underlying directed graph characterize the Young graph? That is, are there examples of Young graphs which are isomorphic as directed graphs but not as Young graphs (i.e., have non-isomorphic sets of pivot nodes).

To make this precise, let \mathcal{G} be a Young graph with underlying unlabeled directed graph G . Let Φ be the map that acts on the labeled nodes and edges of \mathcal{G} by sending $[r, s]$ to $[s, r]$, and the edge $[r, s] \xrightarrow{(a,b)} [t, u]$ to $[u, t] \xrightarrow{(b,a)} [s, r]$. It follows from (P3) that Φ is an involution on

\mathcal{G} , and from Theorem 3.6 that the complete graphs are the only Young graphs that are fixed by Φ . The map Φ induces an involution of the directed graph G . The question is, could there be two non-isomorphic Young graphs where the underlying directed graphs G are isomorphic, but where the two maps Φ act in different ways on G ? This seems quite possible, although no examples are presently known.

(ii) Which directed graphs can occur as (the underlying directed graphs of) Young graphs? Which ones are “palindromic”?

(iii) Given the base g , which values of k can occur (cf. Table 1)?

6. ACKNOWLEDGMENTS

Thanks to Gregory Rosenthal and Selma Rosenthal for asking questions which led to this paper, and to the referee for many helpful comments.

REFERENCES

- [1] D. Acheson, *1089 and All That*, Oxford Univ. Press, 2002, p. 1.
- [2] W. W. R. Ball and H. S. M. Coxeter, *Mathematical Recreations and Essays*, Macmillan, New York, 1939, page 13; Dover, New York, 13th ed. 1987, pp. 14–15.
- [3] H. Dörrie, *Mathematische Miniaturen*, Ferdinand Hirt, Breslau, Germany, 1943, pp. 337–339.
- [4] M. Gardner, *Mathematical Magic Show*, Vintage Books, NY, 1978, pp. 203–204, 211–212.
- [5] C. A. Grimm and D. W. Ballew, *Reversible Multiples*, *J. Rec. Math.*, **8** (1975-1976), 89–91.
- [6] G. H. Hardy, *A Mathematician’s Apology*, Cambridge Univ. Press, 1940, reprinted 2000, pp. 24–25.
- [7] J. Jonesco (proposer), E.-N. Barisien and [no initials given] Welsch (solvers), *Problème 1622*, *L’Intermédiaire des mathématiciens*, **XV** (1908), 132–133, 278–279.
- [8] T. J. Kaczynski, *Note on a Problem of Alan Sutcliffe*, *Math. Mag.*, **41** (1968), 84–86.
- [9] M. Kauers and P. Paule, *The Concrete Tetrahedron*, Springer, 2011.
- [10] L. F. Klosinski and D. C. Smolarski, *On the Reversing of Digits*, *Math. Mag.*, **42** (1969), 208–210.
- [11] M. Lothaire, *Combinatorics on Words*, Addison-Wesley, 1983.
- [12] OEIS Foundation Inc. (2013), *The On-Line Encyclopedia of Integer Sequences*, <http://oeis.org>.
- [13] L. Pudwell, *Digit Reversal Without Apology*, *Math. Mag.*, **80** (2007), 129–132.
- [14] N. J. A. Sloane, *On Finding the Paths Through A Network*, *Bell Syst. Tech. J.*, **51** (1972), 371–390.
- [15] R. P. Stanley, *Enumerative Combinatorics*, Vol. 1, 2nd. ed., Cambridge Univ. Press, 2012, §4.7.
- [16] A. Sutcliffe, *Integers That Are Multiplied When Their Digits Are Reversed*, *Math. Mag.*, **39** (1966), 282–287.
- [17] R. Webster, *A Combinatorial Problem with a Fibonacci Solution*, *The Fibonacci Quarterly*, **33** (1995), 26–31.
- [18] R. Webster and G. Williams, *On the Trail of Reverse Divisors: 1089 and All that Follow*, *Mathematical Spectrum*, **45** (2012/2013), 96–102.
- [19] D. Wells, *The Penguin Dictionary of Curious and Interesting Numbers*, Penguin Books, London, 1986, entry 1089.
- [20] D. W. Wilson, Comments on Sequence A001232 in [12], Dec. 15, 1997.
- [21] A. L. Young, *k-Reverse Multiples*, *The Fibonacci Quarterly*, **30** (1992), 126–132.
- [22] A. L. Young, *Trees for k-Reverse Multiples*, *The Fibonacci Quarterly*, **30** (1992), 166–174.
- [23] D. Zeilberger, *The C-Finite Ansatz*, *Ramanujan J.*, **31** (2013), 23–32.

MSC2010: 11A63

THE OEIS FOUNDATION, 11 SOUTH ADELAIDE AVENUE, HIGHLAND PARK, NJ 08904, USA
E-mail address: njasloane@gmail.com