

SMARANDACHE NOTIONS JOURNAL

$$\begin{aligned}
 \sum_{d^k m \leq x} \omega^2(m) \mu(d) &= \sum_{d \leq x^{\frac{1}{k}}} \mu(d) \sum_{m \leq x/d^k} \omega^2(m) \\
 &= \sum_{d \leq x^{\frac{1}{k}}} \mu(d) \left(\frac{x}{d^k} (\ln \ln \frac{x}{d^k})^2 + O\left(\frac{x}{d^k} \ln \ln \frac{x}{d^k}\right) \right) \\
 &= x \sum_{d \leq x^{\frac{1}{k}}} \frac{\mu(d)}{d^k} \left(\ln \ln x + \ln \ln \left(1 - \frac{k \ln d}{\ln x}\right) \right)^2 + O(x \ln \ln x) \\
 &= x (\ln \ln x)^2 \sum_{d=1}^{\infty} \frac{\mu(d)}{d^k} + O\left(x \ln \ln x \sum_{d \leq x^{\frac{1}{k}}} \frac{\ln d}{d^k \ln x}\right) + O(x \ln \ln x) \\
 &= \frac{x (\ln \ln x)^2}{\zeta(k)} + O(x \ln \ln x).
 \end{aligned}$$

This journal is an extension of the "Smarandache Function Journal", ISBN 1053-4792, Vol. 1-6, 1990-1995.

SNJ is yearly published (in the Spring or Fall) in a 300-400 pages volume, and 800-1000 copies.

SNJ is a referred journal: reviewed, indexed, cited by the following journals: "Zentralblatt Für Mathematik" (Germany), "Referativnyi Zhurnal" and "Matematika" (Academia Nauk, Russia), "Mathematical Reviews" (USA), "Computing Review" (USA), "Libertas Mathematica" (USA), "Octogon" (Romania), "Indian Science Abstracts" (India), "Ulrich's International Periodicals Directory" (USA), "Gale Directory of Publications and Broadcast Media" (USA), "Historia Mathematica" (USA), "Journal of Recreational Mathematics" (USA), "Abstracts of Papers Presented to the American Mathematical Society" (USA), "Personal Computer World" (U.K.), "Mathematical Spectrum" (U.K.), "Bulletin of Pure and Applied Sciences" (India), Institute for Scientific Information (PA, USA), "Library of Congress Subject Headings" (USA).

Referents:

Murad A. AlDamen, P. O. Box 713330, Hai Nazzal 11171, Amman, Jordan.

Y. V. Chebrakov, Department of Mathematics, St.-Petersburg Technical University, Nevsky 3-11, 191186, Russia.

Ion Goian, Department of Algebra, Number Theory and Logic, State University of Kishinev, Republic of Moldova.

M. Khoshnevisan, School of Accounting and Finance, Griffith University, Australia.

Maohua Le, Department of Mathematics, Zhanjiang Normal College, 29 Cunjin Road, Chikan, Zhanjiang, Guangdong, P. R. China.

Chris Nash, 5000 Bryan Station Road #5, Lexington, KY 40516-9505, USA.

Sebastian Martin Ruiz, Avda. De Regla, 43, Chipiona 11550, Cadiz, Spain.

Copyright 2004

by Sabin & Tatiana Tabirca, University College Cork, Ireland.

ASSOCIATE EDITORIAL BOARD:

Azmy Ariff, PO Box 444, Jalan Sultan, Petaling Jaya 46750, Malaysia.

Charles Ashbacher, Charles Ashbacher Technologies, Box 294, 119 Northwood Drive, Hiawatha, Iowa 52233, USA.

Krassimir Atanassov, Bulgarian Academy of Sciences, PO Box 12 MRL, Sofia, Bulgaria.

Ion Balacenoiu, Department of Mathematics, University of Craiova, Romania.

Mihaly Bencze, Str. Hărmanului 6, 2212 Săcele 3, Jud. Braşov, Romania.

Henry Bottomley, 5 Leydon Close, London SE16 5PF, U.K.

Micha Fleuren, Acaciastraat 16, 6598 BC Heyen, The Netherlands.

H. Gunarto, Ritsumeikan Asia-Pacific University, 1-1 Jumonjibaru, Beppu-shi 874-8577, Oita-ken, Japan.

Henry Ibstedt, Glimminge 2036, 280 60 Broby, Sweden.

Howard Iseri, Department of Mathematics, Mansfield University, Mansfield, PA 16933, USA.

Muneer Jebreel, SS-Math-Hebron, UNRWA, Field Education Officer, Box 19149, Jerusalem, Israel.

W. B. Vasantha Kandasamy, Indian Institute of Technology, Madras, Chennai 600 036, India.

A.A.K. Majumdar, Department of Mathematics, Jahangirnagar University, Savar, Dhaka 1342, Bangladesh.

Leonardo Fernandes Dias da Motta, Av. Conselheiro Furtado, 1574, Apt. 501, Bairro Batista Campos, Belem, PA 66040-100, Brasil.

Felice Russo, Micron Technology Italy, Avezzano (Aq), Italy.

Vasile Seleacu, Department of Mathematics, University of Craiova, Romania.

Y. A. Shmagin, Department of Mathematics, St.-Petersburg Technical University, Nevsky 3-11, 191186, St.-Petersburg, Russia.

Delfim F. M. Torres, Department of Mathematics, University of Aveiro, 3810-193, Portugal.

Angela Vasiu, Mathematics Department, Babes-Bolyai University, Cluj-Napoca, Romania.

Bouzza El Wahbi, Département de Mathématiques et Informatiques, Faculté des Sciences, B.P. 2121 Tétouan, Morocco.

Zhang Wenpeng, Department of Mathematics, Xi'an University of Technology, Xi'an, Shaanxi, P.R. China.

Lamarr Widmer, Department of Mathematics, Messiah College, Grantham, PA 17027, USA.

INDICATION TO AUTHORS

Authors of papers concerning any of Smarandache type functions, numbers, sequences, integer algorithms, paradoxes, Non-Euclidean geometries, etc. are encouraged to submit manuscripts to Editors:

*Prof. Sabin & Tatiana Tabirca
Department of Mathematics
University College Cork, Ireland.*

The submitted manuscripts may be in the format of remarks, conjectures, solved/unsolved or open new proposed problems, notes, articles, miscellaneous, etc. They must be original work and camera ready [typewritten/computerized, format: 8.5 x 11 inches ($\approx 21,6 \times 28$ cm)]. They are not returned, hence we advise the authors to keep a copy.

The title of the paper should be writing with capital letters. The author's name has to apply in the middle of the line, near the title. References should be mentioned in the text by a number in square brackets and should be listed alphabetically. Current address followed by e-mail address should apply at the end of the paper, after the references.

The paper should have at the beginning an up to a half-page abstract, followed by the key words.

All manuscripts are subject to anonymous review by two or more independent sources.

Every letter will be answered.

The authors will receive free copies of the journal.

Papers in electronic form are accepted. They can be e-mailed in Microsoft Word XP (or lower), WordPerfect 7.0 (or lower), PDF 6.0 or lower.

Smarandache Sequences: Explorations and Discoveries with a Computer Algebra System

Paulo D. F. Gouveia pgouveia@ipb.pt Technology and Manag. School Bragança Polytechnic Institute 5301-854 Bragança, Portugal	Delfim F. M. Torres delfim@mat.ua.pt Department of Mathematics University of Aveiro 3810-193 Aveiro, Portugal
---	---

Abstract

We study Smarandache sequences of numbers, and related problems, via a Computer Algebra System. Solutions are discovered, and some conjectures presented.

Mathematics Subject Classification 2000. 11B83, 11-04, 68W30.

Keywords. Smarandache square/cube/prime digital subsequence, Smarandache Lucas/Fibonacci partial digital subsequence, Smarandache odd/even/prime/Fibonacci sequence, Smarandache function, Smarandache 2-2-additive/2-2-subtractive/3-3-additive relationship, Smarandache partial perfect additive sequence, Smarandache bad numbers, Smarandache prime conjecture, mathematical experimentation.

1 Introduction

After a good look on the *Mathematics Unlimited—2001 and Beyond* [5], which addresses the question of the future of Mathematics in the new millennium, it is impossible not to get the deep impression that *Computing* will be an integral part of many branches of Mathematics. If it is true that in the XXst century Mathematics has contributed, in a fundamental way, to technology, now, in the XXIst century, the converse seems to be also a possibility. For perspectives on the role of Computing in Mathematics (and the other way around) see [2, 4, 9].

Many powerful and versatile Computer Algebra Systems are available nowadays, putting at our disposal sophisticated environments of mathematical and scientific computing. They comprise both numerical and symbolic computation through high-level and expressive languages, close to the mathematical one. A large quantity of mathematical knowledge is already available in these scientific systems, providing efficient mathematical methods to perform the desired calculations. This has two important implications: they spare one a protracted

process of programming and debugging, so common to the more conventional computer languages; they permit us to write few lines of code, and simpler programs, more declarative in nature. Our claim is that explorations with such tools can develop intuition, insight, and better qualitative understanding of the nature of the problems. This can greatly assist the proof of mathematical results (see an example in Section § 2.1 below).

It is our aim to show that computer-assisted algebra can provide insight and clues to some open questions related to special sequences in Number Theory. Number Theory has the advantage of being easily amenable to computation and experimentation. Explorations with a Computer Algebra System will allow us to produce results and to formulate conjectures. We illustrate our approach with the mathematics Maple system (all the computational processing was carried with Maple version 8, on an AMD Athlon(TM) 1.66 GHz machine), and with some of the problems proposed by the Romanian mathematician Florentin Smarandache.

Maple was originated more than two decades ago, as a project of the Symbolic Computation Group of the University of Waterloo, Ontario. It is now a registered trademark product of Waterloo Maple Inc. We refer the reader to [19, 13] for a gentle introduction to Maple. For a good account on the Smarandache collection of problems, and for a biography of F. Smarandache, see [10].

We invite and exhort readers to convert our mathematical explorations in the language of their favorite Computer Algebra System; to optimize the algorithms (we have followed the didactic approach, without any attempt of code optimization); and to obtain the results for themselves. The source be with you.

2 Smarandache Digital Subsequences

We begin by considering sequences of natural numbers satisfying some given property together with all their digits.

2.1 Smarandache p-digital subsequences

We are interested in the following *Smarandache p-digital subsequences*. Let $p \geq 2$. From the sequence $\{n^p\}$, $n \in \mathbb{N}_0$, we select those terms whose digits are all perfect p -powers. For $p = 2$ we obtain the *Smarandache square-digital subsequence*: we select only those terms of the sequence $\{n^2\}_{n=0}^{\infty}$ whose digits belong to the set $\{0, 1, 4, 9\}$. With the Maple definitions

```
> pow := (n,p) -> seq(i^p,i=0..n):
> perfectPow := (n,p) -> evalb(n = iroot(n,p)^p):
> digit := (n,num) -> irem(iquo(num,10^(length(num)-n)),10):
> digits := n -> map(digit,[$1..length(n)],n):
> digPerfectPow :=
> (n,p) -> evalb(select(perfectPow,digits(n),p) = digits(n)):
```

the Smarandache square-digital subsequence is easily obtained:

```
> ssds := n -> select(digPerfectPow, [pow(n,2)], 2):
```

We now ask for all the terms of the Smarandache square-digital subsequence which are less or equal than 10000^2 :

```
> ssds(10000);
```

```
[0, 1, 4, 9, 49, 100, 144, 400, 441, 900, 1444, 4900, 9409, 10000, 10404, 11449,
14400, 19044, 40000, 40401, 44100, 44944, 90000, 144400, 419904, 490000,
491401, 904401, 940900, 994009, 1000000, 1004004, 1014049, 1040400,
1100401, 1144900, 1440000, 1904400, 1940449, 4000000, 4004001, 4040100,
4410000, 4494400, 9000000, 9909904, 9941409, 11909401, 14010049, 14040009,
14440000, 19909444, 40411449, 41990400, 49000000, 49014001, 49140100,
49999041, 90440100, 94090000, 94109401, 99400900, 99940009, 100000000]
```

In [3, 18] one finds the following question:

“Disregarding the square numbers of the form $N \times 10^{2k}$, $k \in \mathbb{N}$, N also a perfect square number, how many other numbers belong to the Smarandache square-digital subsequence?”

From the obtained 64 numbers of the Smarandache square-digital subsequence, one can see some interesting patterns from which one easily guess the answer.

Theorem 1. *There exist an infinite number of terms on the Smarandache square-digital subsequence which are not of the form $N \times 10^{2k}$, $k \in \mathbb{N}$, N a perfect square number.*

Theorem 1 is a straightforward consequence of the following Lemma.

Lemma 2. *Any number of the form $(10^{k+1} + 4) \times 10^{k+1} + 4$, $k \in \mathbb{N}_0$ (144, 10404, 1004004, 100040004, ...), belong to the Smarandache square-digital subsequence.*

Proof. Lemma 2 follows by direct calculation:

$$(10^{k+1} + 2)^2 = (10^{k+1} + 4) \times 10^{k+1} + 4.$$

□

We remark that from the analysis of the list of the first 64 terms of the Smarandache square-digital subsequence, one easily finds other possibilities to prove Theorem 1, using different but similar assertions than the one in Lemma 2. For example, any number of the form $(10^{k+2} + 14) \times 10^{k+2} + 49$, $k \in \mathbb{N}_0$ (11449, 1014049, 100140049, ...), belong to the Smarandache square-digital subsequence:

$$(10^{k+2} + 7)^2 = (10^{k+2} + 14) \times 10^{k+2} + 49.$$

Other possibility, first discovered in [12], is to use the pattern $(4 \times 10^{k+1} + 4) \times 10^{k+1} + 1$, $k \in \mathbb{N}_0$ (441, 40401, 4004001, ...), which is the square of $2 \times 10^{k+1} + 1$.

Choosing $p = 3$ we obtain the *Smarandache cube-digital subsequence*.

```
> scds := n -> select(digPerfectPow, [pow(n,3)], 3):
```

Looking for all terms of the Smarandache cube-digital subsequence which are less or equal than 10000^3 we only find the trivial ones:

```
> scds(10000);
```

```
[0, 1, 8, 1000, 8000, 1000000, 8000000, 1000000000, 8000000000, 1000000000000]
```

We offer the following conjecture:

Conjecture 3. *All terms of the Smarandache cube-digital subsequence are of the form $D \times 10^{3k}$ where $D \in \{0, 1, 8\}$ and $k \in \mathbb{N}_0$.*

Many more Smarandache digital subsequences have been introduced in the literature. One good example is the Smarandache prime digital subsequence, defined as the sequence of prime numbers whose digits are all primes (see [18]).

Terms of the Smarandache prime digital subsequence are easily discovered with the help of the Maple system. Defining

```
> primeDig := n -> evalb(select(isprime, digits(n)) = digits(n)):
> spds := n -> select(primeDig, [seq(ithprime(i), i=1..n)]):
```

we find that 189 of the first 10000 prime numbers belong to the Smarandache prime digital subsequence:

```
> nops(spds(10000));
```

189

2.2 Smarandache p-partial digital subsequences

The *Smarandache p-partial digital subsequence* is defined by scrolling through a given sequence $\{a_n\}$, $n \geq 0$, defined by some property p , and selecting only those terms which can be partitioned in groups of digits satisfying the same property p (see [3]). For example, let us consider $\{a_n\}$ defined by the recurrence relation $a_n = a_{n-1} + a_{n-2}$. One gets the *Lucas sequence* by choosing the initial conditions $a_0 = 2$ and $a_1 = 1$; the *Fibonacci sequence* by choosing $a_0 = 0$ and $a_1 = 1$. The Smarandache *Lucas-partial digital subsequence* and the Smarandache *Fibonacci-partial digital subsequence* are then obtained selecting from the respective sequences only those terms n for which there exist a partition of the digits in three groups ($n = g_1g_2g_3$) with the sum of the first two groups equal to the third one ($g_1 + g_2 = g_3$).

In [3, 17, 16] the following questions are formulated:

“Is 123 ($1+2=3$) the only Lucas number that verifies a Smarandache type partition?”

“We were not able to find any Fibonacci number verifying a Smarandache type partition, but we could not investigate large numbers; can you?”

Using the following procedure, we can verify if a certain number n fulfills the necessary condition to belong to the Smarandache *Lucas/Fibonacci*-partial digital subsequence, i.e., if n can be divided in three digit groups, $g_1g_2g_3$, with $g_1+g_2=g_3$.

```
> spds:=proc(n)
>   local nd1, nd2, nd3, nd, g1, g2, g3:
>   nd:=length(n);
>   for nd3 to nd-2 do
>     g3:=irem(n,10^nd3);
>     if length(g3)*2>nd then break; fi;
>     for nd1 from min(nd3,nd-nd3-1) by -1 to 1 do
>       nd2:=nd-nd3-nd1;
>       g1:=iquo(n,10^(nd2+nd3));
>       g2:=irem(iquo(n,10^nd3), 10^nd2);
>       if g2>=g3 then break;fi;
>       if g1+g2=g3 then printf("%d (%d+%d=%d)\n",n,g1,g2,g3);fi;
>     od;
>   od:
> end proc:
```

Now, we can compute the first n terms of the Lucas sequence, using the procedure below.

```
> lucas:=proc(n)
>   local L, i:
>   L:=[2, 1]:
>   for i from 1 to n-2 do L:=[L[],L[i]+L[i+1]]:od:
> end proc:
```

With $n = 20$ we get the first twenty Lucas numbers

```
> lucas(20);
```

```
[2, 1, 3, 4, 7, 11, 18, 29, 47, 76, 123, 199, 322, 521, 843, 1364, 2207, 3571, 5778, 9349]
```

Let L be the list of the first 6000 terms of the Lucas sequence:

```
> L:=lucas(6000):
```

```
(elapsed time: 1.9 seconds) 1
```

It is interesting to remark that the 6000th element has 1254 digits:

¹The most significant time calculations are showed, in order to give an idea about the involved computation effort.

```
> length(L[6000]);
```

1254

The following Maple command permit us to check which of the first 3000 elements belong to a Smarandache *Lucas*-partial digital subsequence.

```
> map(spds, L[1..3000]):
```

```
123 (1+2=3)
20633239 (206+33=239)
```

```
(elapsed time: 7h50m)
```

As reported in [15], only two of the first 3000 elements of the Lucas sequence verify a Smarandache type partition: the 11th and 36th elements.

```
> L[11], L[36];
```

123,20633239

We now address the following question: Which of the next 3000 elements of the Lucas sequence belong to a Smarandache *Lucas*-partial digital subsequence?

```
> map(spds, L[3001..6000]):
```

```
(elapsed time: 67h59m)
```

The answer turns out to be *none*: no number, verifying a Smarandache type partition, was found between the 3001th and the 6000th term of the Lucas sequence.

The same kind of analysis is easily done for the Fibonacci sequence. We compute the terms of the Fibonacci sequence using the pre-defined function `fibonacci`:

```
> with(combinat, fibonacci):
> [seq(fibonacci(i), i=1..20)];
```

```
[1, 1, 2, 3, 5, 8, 13, 21, 34, 55, 89, 144, 233, 377, 610, 987, 1597, 2584, 4181, 6765]
```

Although the 6000th Fibonacci number is different from the 6000th Lucas number

```
> evalb(fibonacci(6000) = L[6000]);
```

false

they have the same number of digits

```
> length(fibonacci(6000));
```

1254

In order to identify which of the first 3000 Fibonacci numbers belong to the Smarandache *Fibonacci*-partial digital subsequence, we execute the following short piece of Maple code:

```
> map(spds, [seq(fibonacci(i), i=1..3000)]):
```

832040 (8+32=040)

(elapsed time: 8h32m)

This is in consonance with the result reported in [15]: only one number, among the first 3000 numbers of the Fibonacci sequence, verifies a Smarandache type partition – the 30th one.

```
> fibonacci(30);
```

832040

As before, with respect to the Lucas sequence, we now want to know which of the next 3000 numbers of the Fibonacci sequence belong to the Smarandache *Fibonacci*-partial digital subsequence.

```
> map(spds, [seq(fibonacci(i), i=3001..6000)]):
```

(elapsed time: 39h57m)

Similarly to the Lucas case, no number, verifying a Smarandache type partition, was found between the 3001th and the 6000th term of the Fibonacci sequence.

3 Smarandache Concatenation-Type Sequences

Let $\{a_n\}$, $n \in \mathbb{N}$, be a given sequence of numbers. The Smarandache concatenation sequence associated to $\{a_n\}$ is a new sequence $\{s_n\}$ where s_n is given by the concatenation of all the terms a_1, \dots, a_n . The concatenation operation between two numbers a and b is defined as follows:

```
> conc := (a,b) -> a*10^length(b)+b:
```

In this section we consider four different Smarandache concatenation-type subsequences: the odd, the even, the prime, and the Fibonacci one.

```

> oddSeq := n -> select(type,[seq(i,i=1..n)],odd):
> evenSeq := n -> select(type,[seq(i,i=1..n)],even):
> primeSeq := n -> [seq(ithprime(i),i=1..n)]:
> with(combinat, fibonacci):
> fibSeq := n -> [seq(fibonacci(i),i=1..n)]:
> # ss = Smarandache Sequence
> ss := proc(F,n)
>   local L, R, i:
>   L := F(n):
>   R := array(1..nops(L)): R[1] := L[1]:
>   for i from 2 while i <= nops(L) do
>     R[i]:=conc(R[i-1],L[i]):
>   end do:
>   evalm(R):
> end proc:

```

Just to illustrate the above definitions, we compute the first five terms of the Smarandache odd, even, prime, and Fibonacci sequences:

```
> ss(oddSeq,10);
```

```
[1, 13, 135, 1357, 13579]
```

```
> ss(evenSeq,10);
```

```
[2, 24, 246, 2468, 246810]
```

```
> ss(primeSeq,5);
```

```
[2, 23, 235, 2357, 235711]
```

```
> ss(fibSeq,5);
```

```
[1, 11, 112, 1123, 11235]
```

Many interesting questions appear when one try to find numbers among the terms of a Smarandache concatenation-type sequence with some given property. For example, it remains an open question to understand how many primes are there in the odd, prime, or Fibonacci sequences. Are they infinitely or finitely in number? The following procedure permit us to find prime numbers in a certain Smarandache sequence.

```

> ssPrimes := proc(F,n)
>   local ar, i:
>   ar := select(isprime,ss(F,n)):
>   convert(ar,list):
> end proc:

```

There are five prime numbers in the first fifty terms of the Smarandache odd sequence;

```
> nops(ssPrimes(oddSeq,100));
```

5

five prime numbers in the first two hundred terms of the Smarandache prime sequence;

```
> nops(ssPrimes(primeSeq,200));
```

5

and two primes (11 and 1123) in the first one hundred and twenty terms of the Smarandache Fibonacci sequence.

```
> ssPrimes(fibSeq,120);
```

[11,1123]

It is clear that only the first term of the Smarandache even sequence is prime. One interesting question, formulated in [1, Ch. 2], is the following:

“How many elements of the Smarandache even sequence are twice a prime?”

A simple search with Maple shows that 2468101214 is the only number twice a prime in the first four hundred terms of the Smarandache even sequence (the term 400 of the Smarandache even sequence is a number with 1147 decimal digits).

```
> ssTwicePrime := proc(n)
>   local ar, i;
>   ar := select(i->isprime(i/2),ss(evenSeq,n));
>   convert(ar,list);
> end proc;
> ssTwicePrime(800);
```

[2468101214]

4 Smarandache Relationships

We now consider the so called *Smarandache function*. This function $S(n)$ is important for many reasons (cf. [10, pp. 91–92]). For example, it gives a necessary and sufficient condition for a number to be prime: $p > 4$ is prime if, and only if, $S(p) = p$. *Smarandache numbers* are the values of the Smarandache function.

4.1 Sequences of Smarandache numbers

The *Smarandache function* is defined in [16] as follows: $S(n)$ is the smallest positive integer number such that $S(n)!$ is divisible by n . This function can be defined in Maple by the following procedure:

```
> S:=proc(n)
>   local i, fact:
>   fact:=1:
>   for i from 2 while irem(fact, n)<>0 do
>     fact:=fact*i:
>   od:
>   return i-1:
> end proc:
```

The first terms of the Smarandache sequence are easily obtained:

```
> seq(S(n),n=1..20);
```

1, 2, 3, 4, 5, 3, 7, 4, 6, 5, 11, 4, 13, 7, 5, 6, 17, 6, 19, 5

A sequence of $2k$ Smarandache numbers satisfy a Smarandache k - k additive relationship if

$$S(n) + S(n+1) + \cdots + S(n+k-1) = S(n+k) + S(n+k+1) + \cdots + S(n+2k-1).$$

In a similar way, a sequence of $2k$ Smarandache numbers satisfy a Smarandache k - k subtractive relationship if

$$S(n) - S(n+1) - \cdots - S(n+k-1) = S(n+k) - S(n+k+1) - \cdots - S(n+2k-1).$$

In [3, 17] one finds the following questions:

“How many quadruplets verify a Smarandache 2-2 additive relationship?”

“How many quadruplets verify a Smarandache 2-2 subtractive relationship?”

“How many sextuplets verify a Smarandache 3-3 additive relationship?”

To address these questions, we represent each of the relationships by a Maple function:

```
> add2_2 := (V, n) -> V[n] + V[n+1] = V[n+2] + V[n+3] :
> sub2_2 := (V, n) -> V[n] - V[n+1] = V[n+2] - V[n+3] :
> add3_3 := (V, n) -> V[n] + V[n+1] + V[n+2] = V[n+3] + V[n+4] + V[n+5] :
```

We compute the first 10005 numbers of the Smarandache sequence:

```
> SSN:=[seq(S(i),i=1..10005)]:
```

```
(elapsed time: 59m29s)
```

With the following procedure, we can identify all the positions in the sequence V that verify the relationship F .

```
> verifyRelation:=proc(F,V)
>   local i, VR: VR:=[]:
>   for i to nops(V)-5 do
>     if F(V,i) then VR:=[VR[], i]: fi:
>   od:
>   return VR;
> end proc:
```

We can answer the above mentioned questions for the first 10000 numbers of the Smarandache sequence.

The positions verifying the Smarandache 2-2 additive relationship are:

```
> V1:=verifyRelation(add2_2,SSN);
```

```
V1 := [6, 7, 28, 114, 1720, 3538, 4313, 8474]
```

Similarly, we determine the positions verifying the Smarandache 2-2 subtractive relationship,

```
> V2:=verifyRelation(sub2_2,SSN);
```

```
V2 := [1, 2, 40, 49, 107, 2315, 3913, 4157, 4170]
```

and the positions verifying the Smarandache 3-3 additive relationship:

```
> V3:=verifyRelation(add3_3,SSN);
```

```
V3 := [5, 5182, 9855]
```

The quadruplets associated with the positions $V1$ (2-2 additive relationship) are given by

```
> map(i->printf("S(%d)+S(%d)=S(%d)+S(%d) [%d+%d=%d+%d]\n",
  i,i+1,i+2,i+3,S(i),S(i+1),S(i+2),S(i+3)), V1):
```

```
S(6)+S(7)=S(8)+S(9) [3+7=4+6]
```

```
S(7)+S(8)=S(9)+S(10) [7+4=6+5]
```

```
S(28)+S(29)=S(30)+S(31) [7+29=5+31]
```

```
S(114)+S(115)=S(116)+S(117) [19+23=29+13]
```

```
S(1720)+S(1721)=S(1722)+S(1723) [43+1721=41+1723]
```

```
S(3538)+S(3539)=S(3540)+S(3541) [61+3539=59+3541]
```

```
S(4313)+S(4314)=S(4315)+S(4316) [227+719=863+83]
```

```
S(8474)+S(8475)=S(8476)+S(8477) [223+113=163+173]
```

We remark that in M. Bencze's paper [3] only the first three quadruplets were found. The quadruplets associated with the positions V2 (2-2 subtractive relationship) are:

```
> map(i->printf("S(%d)-S(%d)=S(%d)-S(%d) [%d-%d=%d-%d]\n",
  i,i+1,i+2,i+3,S(i),S(i+1),S(i+2),S(i+3)), V2):
S(1)-S(2)=S(3)-S(4) [1-2=3-4]
S(2)-S(3)=S(4)-S(5) [2-3=4-5]
S(40)-S(41)=S(42)-S(43) [5-41=7-43]
S(49)-S(50)=S(51)-S(52) [14-10=17-13]
S(107)-S(108)=S(109)-S(110) [107-9=109-11]
S(2315)-S(2316)=S(2317)-S(2318) [463-193=331-61]
S(3913)-S(3914)=S(3915)-S(3916) [43-103=29-89]
S(4157)-S(4158)=S(4159)-S(4160) [4157-11=4159-13]
S(4170)-S(4171)=S(4172)-S(4173) [139-97=149-107]
```

Only the first two and fourth quadruplets were found in [3]. The following three sextuplets verify a Smarandache 3-3 additive relationship:

```
> map(i->printf("S(%d)+S(%d)+S(%d)=S(%d)+S(%d)+S(%d)
  [%d+%d+%d=%d+%d+%d]\n", i, i+1, i+2, i+3, i+4, i+5,
  S(i), S(i+1), S(i+2), S(i+3), S(i+4), S(i+5)), V3):
S(5)+S(6)+S(7)=S(8)+S(9)+S(10) [5+3+7=4+6+5]
S(5182)+S(5183)+S(5184)=S(5185)+S(5186)+S(5187) [2591+73+9=61+2593+19]
S(9855)+S(9856)+S(9857)=S(9858)+S(9859)+S(9860) [73+11+9857=53+9859+29]
```

Only the first sextuplet was found by M. Bencze's in [3]. For a deeper analysis of these type of relationships, see [6, 8].

4.2 An example of a Smarandache partial perfect additive sequence

Let $\{a_n\}$, $n \geq 1$, be a sequence constructed in the following way:

$$\begin{aligned} a_1 &= a_2 = 1; \\ a_{2p+1} &= a_{p+1} - 1; \\ a_{2p+2} &= a_{p+1} + 1. \end{aligned}$$

The following Maple procedure defines a_n .

```
> a:=proc(n)
> option remember;
> if (n=1) or (n=2) then return 1:
> elif type(n, odd) then return a((n-1)/2+1)-1:
> else return a((n-2)/2+1)+1:
> fi:
> end proc:
```

In [3] the first 26 terms of the sequence are presented as being

```
> A:=1,1,0,2,-1,1,1,3,-2,0,0,2,1,1,3,5,-4,-2,-1,1,-1,1,1,3,0,2:
```

One easily concludes, as mentioned in [7], that starting from the thirteenth term the above values are erroneous. The correct values are obtained with the help of our procedure:

```
> seq(a(i),i=1..26);
```

```
1,1,0,2,-1,1,1,3,-2,0,0,2,0,2,2,4,-3,-1,-1,1,-1,1,1,3,-1,1
```

We prove, for $1 \leq p \leq 5000$, that $\{a_n\}$ is a Smarandache partial perfect additive sequence, that is, it satisfies the relation

$$a_1 + a_2 + \dots + a_p = a_{p+1} + a_{p+2} + \dots + a_{2p}. \quad (1)$$

This is accomplished by the following Maple code:

```
> sppasproperty:=proc(n)
>   local SPPAS, p;
>   SPPAS:=[seq(a(i),i=1..n)];
>   for p from 1 to iquo(n,2) do
>     if evalb(add(SPPAS[i], i=1..p)<>add(SPPAS[i], i=p+1..2*p))
>       then return false;
>     fi;
>   od;
>   return true;
> end proc;
> sppasproperty(10000);
```

true

(elapsed time: 11.4 seconds)

We remark that the erroneous sequence A does not verify property (1). For example, with $p = 8$ one gets:

```
> add(A[i],i=1..8)<>add(A[i],i=9..16);
```

$8 \neq 10$

5 Other Smarandache Definitions and Conjectures

The Smarandache prime conjecture share resemblances (a kind of dual assertion) with the famous Goldbach's conjecture: "Every even integer greater than four can be expressed as a sum of two primes".

5.1 Smarandache Prime Conjecture

In [3, 17, 16] the so called *Smarandache Prime Conjecture* is formulated: “Any odd number can be expressed as the sum of two primes minus a third prime (not including the trivial solution $p = p + q - q$ when the odd number is the prime itself)”.

We formulate a strong variant of this conjecture, requiring the odd number and the third prime to be different (not including the situation $p = k + q - p$), that is, we exclude the situation addressed by Goldbach’s conjecture (where the even integer $2p$ is expressed as the sum of two primes k and q).

The number of times each odd number can be expressed as the sum of two primes minus a third prime, are called *Smarandache prime conjecture numbers*. It seems that none of them are known (cf. [3]). Here we introduce the notion of *strong Smarandache n-prime conjecture numbers*: the number of possibilities that each positive odd number can be expressed as a sum of two primes minus a third prime, excluding the trivial solution and imposing our requirement that the odd number and the third prime must be different, using all possible combinations of the first n primes.

Given n , the next procedure determines such numbers for all positive odd integers less or equal than lim .

```
> spcn:=proc(lim, n)
>   local y, z, i, primos, num, mat:
>   mat:=array(1..lim, 1..2, [seq(['?', 0], i=1..lim)]):
>   primos:=seq(ithprime(i), i=1..n);
>   for i from 1 to n do
>     for y in [primos[i..n]] do
>       for z in [primos] do
>         num:=primos[i]+y-z;
>         if (num>=1 and num<=lim and type(num, odd) and
>           z<>primos[i] and z<>y and z<>num) then
>           if mat[num, 2]=0 then mat[num, 1]:=[primos[i], y, z]:
>           fi:
>           mat[num, 2]:=mat[num, 2]+1;
>         ff:
>       od:
>     od:
>   for i by 2 to lim do
>     if mat[i, 2]=0 then printf("%d=? (0 possibilities)\n", i):
>     else printf("%d=%d+%d-%d (%d possibilities)\n", i,
>               op(mat[i, 1]), mat[i, 2]):
>     fi:
>   od:
>   evalm(mat):
> end proc:
```

All positive odd numbers less or equal than 19 can be expressed according to the conjecture, using only the first six primes.²

```
> spcn(19,6):  
1=2+2-3 (6 possibilities)  
3=5+5-7 (3 possibilities)  
5=3+13-11 (2 possibilities)  
7=5+5-3 (2 possibilities)  
9=3+11-5 (7 possibilities)  
11=3+13-5 (3 possibilities)  
13=5+11-3 (2 possibilities)  
15=5+13-3 (5 possibilities)  
17=7+13-3 (3 possibilities)  
19=11+11-3 (3 possibilities)  
  
(elapsed time: 0.0 seconds)
```

As expected, if one uses the first 100 primes, the number of distinct possibilities, for which each number can be expressed as in our conjecture, increases.

```
> spcn(19,100):  
1=2+2-3 (1087 possibilities)  
3=5+5-7 (737 possibilities)  
5=3+13-11 (1015 possibilities)  
7=3+17-13 (1041 possibilities)  
9=3+11-5 (793 possibilities)  
11=3+13-5 (1083 possibilities)  
13=3+17-7 (1057 possibilities)  
15=3+17-5 (770 possibilities)  
17=3+19-5 (1116 possibilities)  
19=3+23-7 (1078 possibilities)  
  
(elapsed time: 1.8 seconds)
```

How many odd numbers less or equal to 10000 verify the conjecture?³

```
> SPCN1:=spcn(10000,600):  
  
(elapsed time: 30m59s)  
  
> n:=0: for i by 2 to 10000 do if SPCN1[i,2]>0 then n:=n+1; fi; od: n;
```

4406

Using the first 600 primes, only 4406 of the 5000 odd numbers verify the conjecture. And if one uses the first 700 primes?

²For each number, only one of the possibilities is showed.

³In the follow *spcn* procedure calls, we removed from its definition the last *for* loop (*spcn* without screen output).

```

> SPCN2:=spcn(10000,700):

(elapsed time: 49m34s)

> n:=0:
> for i by 2 to 10000 do if SPCN2[i,2]>0 then n:=n+1; fi; od;
> n;

```

5000

Using the first 700 primes, all the odd numbers up to 10000 verify the conjecture. We refer the readers interested in the Smarandache prime conjecture to [14].

5.2 Smarandache Bad Numbers

“There are infinitely many numbers that cannot be expressed as the difference between a cube and a square (in absolute value). They are called *Smarandache Bad Numbers*(!)” – see [3].

The next procedure determines if a number n can be expressed in the form $n = |x^3 - y^2|$ (i.e., if it is a non Smarandache bad number), for any integer x less or equal than x_{max} . The algorithm is based in the following equivalence

$$n = |x^3 - y^2| \Leftrightarrow y = \sqrt{x^3 - n} \vee y = \sqrt{x^3 + n}.$$

For each x between 1 and x_{max} , we try to find an *integer* y satisfying $y = \sqrt{x^3 - n}$ or $y = \sqrt{x^3 + n}$, to conclude that n is a non Smarandache bad number.

```

> nsbn:=proc(n,xmax)
>   local x, x3:
>   for x to xmax do
>     x3:=x^3;
>     if issqr(x3-n) and x3<>n then return n[x, sqrt(x3-n)];
>     elif issqr(x3+n) then return n[x, sqrt(x3+n)]; fi;
>   od:
>   return n['?', '?']
> end proc:

```

F. Smarandache [16] conjectured that the numbers 5, 6, 7, 10, 13, 14, ... are probably bad numbers. We now ask for all the non Smarandache bad numbers which are less or equal than 30, using only the x values between 1 and 19. We use the notation $n_{x,y}$ to mean that $n = |x^3 - y^2|$. For example, $1_{2,3}$ means that $1 = |2^3 - 3^2| = |8 - 9|$.

```

> NSBN:=map(nsbn, [$1..30], 19);

```



```

NSBN := [12,3, 23,5, 31,2, 42,2, 5?,?, 6?,?, 72,1, 81,3, 93,6, 10?,?,
113,4, 1213,47, 1317,70, 14?,?, 151,4, 16?,?, 172,5, 183,3, 195,12, 206,14,
21?,?, 223,7, 233,2, 241,5, 255,10, 263,1, 27?,?, 282,6, 29?,?, 3019,83]

```

As proved by Maohua Le in [11], we have just shown that 7 and 13 are non Smarandache bad numbers: $7 = |2^3 - 1^2|$ and $13 = |17^3 - 70^2|$. The possible Smarandache bad numbers are:

```
> select(n->evalb(op(1,n)='?'), NSBN);
```

```
[5?,?, 6?,?, 10?,?, 14?,?, 16?,?, 21?,?, 27?,?, 29?,?]
```

Finally, we will determine if any of these eight numbers is a non Smarandache bad number, if one uses all the x values up to 10^8 .

```
> map(nsb, [5, 6, 10, 14, 16, 21, 27, 29], 10^8);
```

```
[5?,?, 6?,?, 10?,?, 14?,?, 16?,?, 21?,?, 27?,?, 29?,?]
```

(elapsed time: 14h30m)

From the obtained result, we conjecture that 5, 6, 10, 14, 16, 21, 27, and 29, are bad numbers. We look forward to readers explorations and discoveries.

Acknowledgments

This work was partially supported by the program PRODEP III/5.3/2003, and by the R&D unit CEOC of the University of Aveiro.

References

- [1] C. Ashbacher. *Pluckings from the tree of Smarandache sequences and functions*. American Research Press, Lupton, AZ, 1998.
- [2] D. H. Bailey and J. M. Borwein. Experimental mathematics: recent developments and future outlook. In *Mathematics unlimited—2001 and beyond*, pages 51–66. Springer, Berlin, 2001.
- [3] M. Bencze. Smarandache relationships and subsequences. *Smarandache Notions J.*, 11(1-3):79–85, 2000.
- [4] J. M. Borwein and R. M. Corless. Emerging tools for experimental mathematics. *Amer. Math. Monthly*, 106(10):889–909, 1999.

- [5] B. Engquist and W. Schmid, editors. *Mathematics unlimited—2001 and beyond*. Springer-Verlag, Berlin, 2001.
- [6] H. Ibstedt. A brief account on smarandache 2-2 subtractive relationships. *Smarandache Notions J.*, 12(1-3):99–102, 2001.
- [7] H. Ibstedt. On a Smarandache partial perfect additive sequence. *Smarandache Notions J.*, 12(1-3):103–107, 2001.
- [8] H. Ibstedt. Smarandache k - k additive relationships. *Smarandache Notions J.*, 12(1-3):62–81, 2001.
- [9] P. D. Lax. Mathematics and computing. In *Mathematics: frontiers and perspectives*, pages 417–432. Amer. Math. Soc., Providence, RI, 2000.
- [10] C. T. Le. The most paradoxist mathematician of the world “Florentin Smarandache”. *Bull. Pure Appl. Sci. Sect. E Math. Stat.*, 15(1):81–96, 1996.
- [11] M. Le. A note on the Smarandache bad numbers. *Smarandache Notions J.*, 12(1-3):215–216, 2001.
- [12] M. Le. The reduced Smarandache square-digital subsequence is infinite. *Smarandache Notions J.*, 12(1-3):313–314, 2001.
- [13] K. H. Rosen, J. S. Devitt, T. Vasiga, J. McCarron, E. Murray, and E. Roskos. *Exploring discrete mathematics with Maple*. McGraw-Hill Inc., Boston (MA), 1997.
- [14] F. Russo. On some Smarandache conjectures and unsolved problems. *Smarandache Notions J.*, 12(1-3):172–192, 2001.
- [15] F. Russo. On two problems concerning two Smarandache P-partial digital subsequences. *Smarandache Notions J.*, 12(1-3):198–200, 2001.
- [16] F. Smarandache. Properties of Numbers. *University of Craiova Archives*, 1975. (see also Arizona State University Special Collections, Tempe, AZ, U.S.A.).
- [17] F. Smarandache. Numerology. Oct. 13 2000. Comment: 16 pages. Tables of numbers. Presented to the Pedagogical High School Student Conference in Craiova, 1969. [arXiv.org:math/0010132](http://arXiv.org/math/0010132)
- [18] S. Smith. A set of conjectures on Smarandache sequences. *Smarandache Notions J.*, 11(1-3):86–92, 2000.
- [19] F. Vivaldi. *Experimental mathematics with Maple*. Chapman & Hall/CRC Mathematics. Chapman & Hall/CRC, Boca Raton, FL, 2001.

Palindrome Studies (Part I)

The Palindrome Concept and Its Applications to Prime Numbers

Henry Ibstedt
Glimminge 2036
280 60 Broby
Sweden

Abstract: This article originates from a proposal by M. L. Perez of American Research Press to carry out a study on Smarandache generalized palindromes [1]. The prime numbers were chosen as a first set of numbers to apply the development of ideas and computer programs on. The study begins by exploring regular prime number palindromes. To continue the study it proved useful to introduce a new concept, that of extended palindromes with the property that the union of regular palindromes and extended palindromes form the set of Smarandache generalized palindromes. An interesting observation is proved in the article, namely that the only regular prime number palindrome with an even number of digits is 11.

1. Regular Palindromes

Definition: A positive integer is a palindrome if it reads the same way forwards and backwards.

Using concatenation we can write the definition of a regular palindrome A in the form

$$A = x_1x_2x_3\dots x_n\dots x_3x_2x_1 \text{ or } x_1x_2x_3\dots x_nx_n\dots x_3x_2x_1$$

where $x_k \in \{0, 1, 2, \dots, 9\}$ for $k=1, 2, 3, \dots, n$, except $x_1 \neq 0$

Examples and Identification: The digits 1, 2, ..., 9 are trivially palindromes. The only 2-digit palindromes are 11, 22, 33, ..., 99.

Of course, palindromes are easy to identify by visual inspection. We see at once that 5493945 is a palindrome. In this study we will also refer to this type of palindromes as *regular palindromes* since we will later define another type of palindromes.

As we have seen, palindromes are easily identified by visual inspection, something we will have difficulties to do with, say prime numbers. Nevertheless, we need an algorithm to identify palindromes because we can not use our visual inspection method on integers that occur in computer analysis of various sets of numbers. The

following routine, written in Ubasic, is built into various computer programs in this study:

```

10 'Palindrome identifier, Henry Ibstedt, 031021
20 input " N";N
30 s=n\10 :r=res
40 while s>0
50 s=s\10 :r=10*r+res
60 wend
70 print n,r
80 end

```

This technique of reversing a number is quite different from what will be needed later on in this study. Although very simple and useful it is worth thinking about other methods depending on the nature of the set of numbers to be examined. Let's look at prime number palindromes.

2. Prime Number Palindromes

We can immediately list the prime number palindromes which are less than 100, they are: 2, 3, 5, 7 and 11. We realize that the last digit of any prime number except 2 must be 1, 3, 7 or 9. A three digit prime number palindrome must therefore be of the types: $1x1$, $3x3$, $7x7$ or $9x9$ where $x \in \{0, 1, \dots, 9\}$. Here, numbers have been expressed in concatenated form. When there is no risk of misunderstanding we will simply write $2x2$, otherwise concatenation will be expressed 2_x_2 while multiplication will be made explicit by $2 \cdot x \cdot 2$.

In explicit form we write the above types of palindromes: $101+10x$, $303+10x$, $707+10x$ and $909+10x$ respectively.

A 5-digit palindrome $axyxa$ can be expressed in the form:

$a_000_a+x \cdot 1010+y \cdot 100$ where $a \in \{1, 3, 7, 9\}$, $x \in \{0, 1, \dots, 9\}$ and $y \in \{0, 1, \dots, 9\}$

This looks like complicating things. But not so. Implementing this in a Ubasic program will enable us to look for which palindromes are primes instead of looking for which primes are palindromes. Here is the corresponding computer code (C5):

```

10 'Classical 5-digit Prime Palindromes (C5)
20 'October 2003, Henry Ibstedt
30 dim V(4),U(4)
40 for I=1 to 4 :read V(I):next
50 data 1,3,7,9
60 T=10001
70 for I=1 to 4
80 U=0:'Counting prime palindromes
90 A=V(I)*T
100 for J=0 to 9
110 B=A+1010*J
120 for K=0 to 9
130 C=B+100*K
140 if ntxtprm(C-1)=C then print C :inc U
150 next :next
160 U(I)=U

```

```

170 next
180 for I=1 to 4 :print U(I):next
190 end

```

Before implementing this code the following theorem will be useful.

Theorem: A palindrome with an even number of digits is divisible by 11.

Proof: We consider a palindrome with $2n$ digits which we denote x_1, x_2, \dots, x_n . Using concatenation we write the palindrome

$$A = x_1x_2\dots x_nx_n\dots x_2x_1$$

We express A in terms of x_1, x_2, \dots, x_n in the following way:

$$A = x_1(10^{2n-1}+1) + x_2(10^{2n-2}+10) + x_3(10^{2n-3}+10^2) + \dots + x_n(10^{2n-n}+10^{n-1})$$

or

$$A = \sum_{k=1}^n x_k (10^{2n-k} + 10^{k-1}) \tag{1}$$

We will now use the following observation:

$$10^q - 1 \equiv 0 \pmod{11} \text{ for } q \equiv 0 \pmod{2}$$

and

$$10^q + 1 \equiv 0 \pmod{11} \text{ for } q \equiv 1 \pmod{2}$$

We re-write (1) in the form:

$$A = \sum_{k=1}^n x_k (10^{2n-k} \pm 1 + 10^{k-1} \mp 1) \text{ where the upper sign applies if } k \equiv 1 \pmod{2} \text{ and the lower sign if } k \equiv 0 \pmod{2}.$$

From this we see that $A \equiv 0 \pmod{11}$ for $n \equiv 0 \pmod{2}$.

Corollary: From this theorem we learn that the only prime number palindrome with an even number of digits is 11.

This means that we only need to examine palindromes with an odd number of digits for primality. Changing a few lines in the computer code C5 we obtain computer codes (C3, C7 and C9) which will allow us to identify all prime number palindromes less than 10^{10} in less than 5 minutes. The number of prime number palindromes in each interval was registered in a file. The result is displayed in table 1.

Table 1. Number of prime number palindromes

Number of digits	Number of palindromes of type				Total
	1.....1	3.....3	7.....7	9.....9	
3	5	4	4	2	15
5	26	24	24	19	93
7	190	172	155	151	668

Table 2. Three-digit prime number palindromes
(Total 15)

Interval	Prime Number Palindromes				
100-199	101	131	151	181	191
300-399	313	353	373	383	
700-799	727	757	787	797	
900-999	919	929			

Table 3. Five-digit prime number palindromes
(Total 93)

10301	10501	10601	11311	11411	12421	12721	12821	13331
13831	13931	14341	14741	15451	15551	16061	16361	16561
16661	17471	17971	18181	18481	19391	19891	19991	
30103	30203	30403	30703	30803	31013	31513	32323	32423
33533	34543	34843	35053	35153	35353	35753	36263	36563
37273	37573	38083	38183	38783	39293			
70207	70507	70607	71317	71917	72227	72727	73037	73237
73637	74047	74747	75557	76367	76667	77377	77477	77977
78487	78787	78887	79397	79697	79997			
90709	91019	93139	93239	93739	94049	94349	94649	94849
94949	95959	96269	96469	96769	97379	97579	97879	98389
98689								

Table 4. Seven-digit prime number palindromes
(Total 668)

1003001	1008001	1022201	1028201	1035301	1043401	1055501	1062601
1065601	1074701	1082801	1085801	1092901	1093901	1114111	1117111
1120211	1123211	1126211	1129211	1134311	1145411	1150511	1153511
1160611	1163611	1175711	1177711	1178711	1180811	1183811	1186811
1190911	1193911	1196911	1201021	1208021	1212121	1215121	1218121
1221221	1235321	1242421	1243421	1245421	1250521	1253521	1257521
1262621	1268621	1273721	1276721	1278721	1280821	1281821	1286821
1287821	1300031	1303031	1311131	1317131	1327231	1328231	1333331
1335331	1338331	1343431	1360631	1362631	1363631	1371731	1374731
1390931	1407041	1409041	1411141	1412141	1422241	1437341	1444441
1447441	1452541	1456541	1461641	1463641	1464641	1469641	1486841
1489841	1490941	1496941	1508051	1513151	1520251	1532351	1535351
1542451	1548451	1550551	1551551	1556551	1557551	1565651	1572751
1579751	1580851	1583851	1589851	1594951	1597951	1598951	1600061
1609061	1611161	1616161	1628261	1630361	1633361	1640461	1643461
1646461	1654561	1657561	1658561	1660661	1670761	1684861	1685861
1688861	1695961	1703071	1707071	1712171	1714171	1730371	1734371
1737371	1748471	1755571	1761671	1764671	1777771	1793971	1802081
1805081	1820281	1823281	1824281	1826281	1829281	1831381	1832381
1842481	1851581	1853581	1856581	1865681	1876781	1878781	1879781
1880881	1881881	1883881	1884881	1895981	1903091	1908091	1909091
1917191	1924291	1930391	1936391	1941491	1951591	1952591	1957591
1958591	1963691	1968691	1969691	1970791	1976791	1981891	1982891
1984891	1987891	1988891	1993991	1995991	1998991		
3001003	3002003	3007003	3016103	3026203	3064603	3065603	3072703

3073703	3075703	3083803	3089803	3091903	3095903	3103013	3106013
3127213	3135313	3140413	3155513	3158513	3160613	3166613	3181813
3187813	3193913	3196913	3198913	3211123	3212123	3218123	3222223
3223223	3228223	3233323	3236323	3241423	3245423	3252523	3256523
3258523	3260623	3267623	3272723	3283823	3285823	3286823	3288823
3291923	3293923	3304033	3305033	3307033	3310133	3315133	3319133
3321233	3329233	3331333	3337333	3343433	3353533	3362633	3364633
3365633	3368633	3380833	3391933	3392933	3400043	3411143	3417143
3424243	3425243	3427243	3439343	3441443	3443443	3444443	3447443
3449443	3452543	3460643	3466643	3470743	3479743	3485843	3487843
3503053	3515153	3517153	3528253	3541453	3553553	3558553	3563653
3569653	3586853	3589853	3590953	3591953	3594953	3601063	3607063
3618163	3621263	3627263	3635363	3643463	3646463	3670763	3673763
3680863	3689863	3698963	3708073	3709073	3716173	3717173	3721273
3722273	3728273	3732373	3743473	3746473	3762673	3763673	3765673
3768673	3769673	3773773	3774773	3781873	3784873	3792973	3793973
3799973	3804083	3806083	3812183	3814183	3826283	3829283	3836383
3842483	3853583	3858583	3863683	3864683	3867683	3869683	3871783
3878783	3893983	3899983	3913193	3916193	3918193	3924293	3927293
3931393	3938393	3942493	3946493	3948493	3964693	3970793	3983893
3991993	3994993	3997993	3998993				
7014107	7035307	7036307	7041407	7046407	7057507	7065607	7069607
7073707	7079707	7082807	7084807	7087807	7093907	7096907	7100017
7114117	7115117	7118117	7129217	7134317	7136317	7141417	7145417
7155517	7156517	7158517	7159517	7177717	7190917	7194917	7215127
7226227	7246427	7249427	7250527	7256527	7257527	7261627	7267627
7276727	7278727	7291927	7300037	7302037	7310137	7314137	7324237
7327237	7347437	7352537	7354537	7362637	7365637	7381837	7388837
7392937	7401047	7403047	7409047	7415147	7434347	7436347	7439347
7452547	7461647	7466647	7472747	7475747	7485847	7486847	7489847
7493947	7507057	7508057	7518157	7519157	7521257	7527257	7540457
7562657	7564657	7576757	7586857	7592957	7594957	7600067	7611167
7619167	7622267	7630367	7632367	7644467	7654567	7662667	7665667
7666667	7668667	7669667	7674767	7681867	7690967	7693967	7696967
7715177	7718177	7722277	7729277	7733377	7742477	7747477	7750577
7758577	7764677	7772777	7774777	7778777	7782877	7783877	7791977
7794977	7807087	7819187	7820287	7821287	7831387	7832387	7838387
7843487	7850587	7856587	7865687	7867687	7868687	7873787	7884887
7891987	7897987	7913197	7916197	7930397	7933397	7935397	7938397
7941497	7943497	7949497	7957597	7958597	7960697	7977797	7984897
7985897	7987897	7996997					
9002009	9015109	9024209	9037309	9042409	9043409	9045409	9046409
9049409	9067609	9073709	9076709	9078709	9091909	9095909	9103019
9109019	9110119	9127219	9128219	9136319	9149419	9169619	9173719
9174719	9179719	9185819	9196919	9199919	9200029	9209029	9212129
9217129	9222229	9223229	9230329	9231329	9255529	9269629	9271729
9277729	9280829	9286829	9289829	9318139	9320239	9324239	9329239
9332339	9338339	9351539	9357539	9375739	9384839	9397939	9400049
9414149	9419149	9433349	9439349	9440449	9446449	9451549	9470749
9477749	9492949	9493949	9495949	9504059	9514159	9526259	9529259
9547459	9556559	9558559	9561659	9577759	9583859	9585859	9586859
9601069	9602069	9604069	9610169	9620269	9624269	9626269	9632369
9634369	9645469	9650569	9657569	9670769	9686869	9700079	9709079
9711179	9714179	9724279	9727279	9732379	9733379	9743479	9749479

9752579	9754579	9758579	9762679	9770779	9776779	9779779	9781879
9782879	9787879	9788879	9795979	9801089	9807089	9809089	9817189
9818189	9820289	9822289	9836389	9837389	9845489	9852589	9871789
9888889	9889889	9896989	9902099	9907099	9908099	9916199	9918199
9919199	9921299	9923299	9926299	9927299	9931399	9932399	9935399
9938399	9957599	9965699	9978799	9980899	9981899	9989899	

Of the 5172 nine-digit prime number palindromes only a few in the beginning and at the end of each type are shown in table 5.

Table 5a. Nine-digit prime palindromes of type 1__1
(Total 1424)

100030001	100050001	100060001	100111001	100131001	100161001
100404001	100656001	100707001	100767001	100888001	100999001
101030101	101060101	101141101	101171101	101282101	101292101
101343101	101373101	101414101	101424101	101474101	101595101
101616101	101717101	101777101	101838101	101898101	101919101
101949101	101999101	102040201	102070201	102202201	102232201
102272201	102343201	102383201	102454201	102484201	102515201
102676201	102686201	102707201	102808201	102838201	103000301
103060301	103161301	103212301	103282301	103303301	103323301
103333301	103363301	103464301	103515301	103575301	103696301
195878591	195949591	195979591	196000691	196090691	196323691
196333691	196363691	196696691	196797691	196828691	196878691
197030791	197060791	197070791	197090791	197111791	197121791
197202791	197292791	197343791	197454791	197525791	197606791
197616791	197868791	197898791	197919791	198040891	198070891
198080891	198131891	198292891	198343891	198353891	198383891
198454891	198565891	198656891	198707891	198787891	198878891
198919891	199030991	199080991	199141991	199171991	199212991
199242991	199323991	199353991	199363991	199393991	199494991
199515991	199545991	199656991	199767991	199909991	199999991

Table 5b. Nine-digit prime palindromes of type 3__3
(Total 1280)

300020003	300080003	300101003	300151003	300181003	300262003
300313003	300565003	300656003	300808003	300818003	300848003
300868003	300929003	300959003	301050103	301111103	301282103
301434103	301494103	301555103	301626103	301686103	301818103
301969103	302030203	302070203	302202203	302303203	302313203
302333203	302343203	302444203	302454203	302525203	302535203
302555203	302646203	302676203	302858203	302898203	302909203
303050303	303121303	303161303	303272303	303292303	303373303
303565303	303616303	303646303	303757303	303878303	303929303
303979303	304050403	304090403	304131403	304171403	304191403
394191493	394212493	394333493	394494493	394636493	394696493
394767493	395202593	395303593	395363593	395565593	395616593
395717593	395727593	395868593	395898593	396070693	396191693
396202693	396343693	396454693	396505693	396757693	396808693
396919693	396929693	397141793	397242793	397333793	397555793
397666793	397909793	398040893	398111893	398151893	398232893

398252893	398363893	398414893	398474893	398616893	398666893
398676893	398757893	398838893	398898893	399070993	399191993
399262993	399323993	399464993	399484993	399575993	399595993
399616993	399686993	399707993	399737993	399767993	399878993

Table 5c. Nine-digit prime palindromes of type 7__7
(Total 1243)

700020007	700060007	700090007	700353007	700363007	700404007
700444007	700585007	700656007	700666007	700717007	700737007
700848007	700858007	700878007	700989007	701000107	701141107
701151107	701222107	701282107	701343107	701373107	701393107
701424107	701525107	701595107	701606107	701636107	701727107
701747107	701838107	701919107	701979107	701999107	702010207
702070207	702080207	702242207	702343207	702434207	702515207
702575207	702626207	702646207	702676207	702737207	702767207
702838207	702919207	702929207	702989207	703000307	703060307
703111307	703171307	703222307	703252307	703393307	703444307
795848597	795878597	796060697	796080697	796222697	796252697
796353697	796363697	796474697	796494697	796515697	796636697
796666697	796707697	796717697	796747697	796848697	796939697
797262797	797363797	797393797	797444797	797525797	797595797
797676797	797828797	797898797	797939797	797949797	798040897
798181897	798191897	798212897	798292897	798373897	798383897
798454897	798535897	798545897	798646897	798676897	798737897
798797897	798818897	798838897	798919897	798989897	799050997
799111997	799131997	799323997	799363997	799383997	799555997
799636997	799686997	799878997	799888997	799939997	799959997

Table 5 d. Nine-digit prime palindromes of type 9__9
(Total 1225)

900010009	900050009	900383009	900434009	900484009	900505009
900515009	900565009	900757009	900808009	900838009	900878009
900919009	900929009	901060109	901131109	901242109	901252109
901272109	901353109	901494109	901585109	901606109	901626109
901656109	901686109	901696109	901797109	901929109	901969109
902151209	902181209	902232209	902444209	902525209	902585209
902757209	902828209	902888209	903020309	903131309	903181309
903292309	903373309	903383309	903424309	903565309	903616309
903646309	903727309	903767309	903787309	903797309	903878309
903979309	904080409	904090409	904101409	904393409	904414409
994969499	995070599	995090599	995111599	995181599	995303599
995343599	995414599	995555599	995696599	995757599	995777599
996020699	996101699	996121699	996181699	996242699	996464699
996494699	996565699	996626699	996656699	996686699	996808699
996818699	996878699	996929699	996949699	996989699	997030799
997111799	997393799	997464799	997474799	997555799	997737799
997818799	997909799	997969799	998111899	998121899	998171899
998202899	998282899	998333899	998565899	998666899	998757899
998898899	998939899	998979899	999070999	999212999	999272999
999434999	999454999	999565999	999676999	999686999	999727999

An idea about the strange distribution of prime number palindromes is given in diagram 1. In fact the prime number palindromes are spread even thinner than the diagram makes believe because the horizontal scale is in interval numbers not in decimal numbers, i.e. (100-200) is given the same length as $(1.1 \cdot 10^9 - 1.2 \cdot 10^9)$.

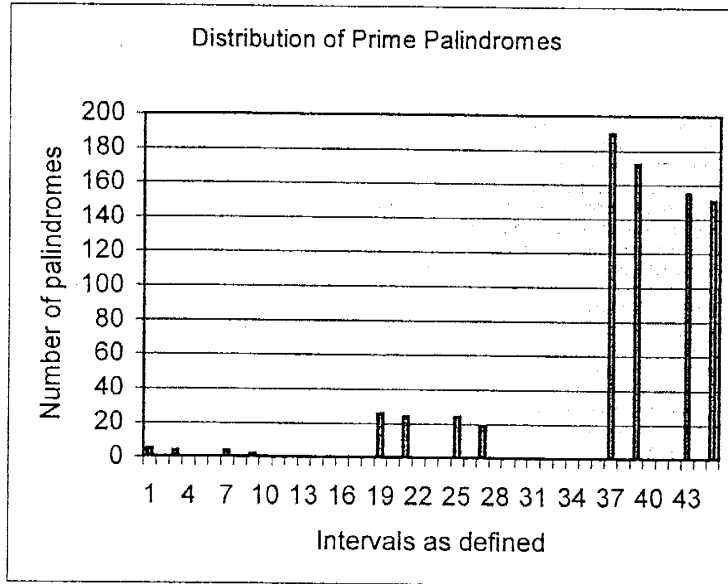

Diagram 1

Intervals 1-9: 3-digit numbers divided into 9 equal intervals.
 Intervals 11-18: 4-digit numbers divided into 9 equal intervals
 Intervals 19-27: 5-digit numbers divided into 9 equal intervals
 Intervals 28-36: 6-digit numbers divided into 9 equal intervals
 Intervals 37-45: 7-digit numbers divided into 9 equal intervals

3. Smarandache Generalized Palindromes

Definition: A Smarandache Generalized Palindrome (SGP) is any integer of the form

$$x_1x_2x_3\dots x_n\dots x_3x_2x_1 \text{ OR } x_1x_2x_3\dots x_nx_n\dots x_3x_2x_1$$

where $x_1, x_2, x_3, \dots, x_n$ are natural numbers. In the first case we require $n > 1$ since otherwise every number would be a SGP.

Briefly speaking $x_k \in \{0, 1, 2, \dots, 9\}$ has been replaced by $x_k \in \mathbb{N}$ (where \mathbb{N} is the set of natural numbers).

Addition: To avoid that the same number is described as a SGP in more than one way this study will require the x_k to be maximum as a first priority and n to be maximum as a second priority (cf. examples below).

Interpretations and examples: Any regular palindrome (RP) is a Smarandache Generalized Palindrome (SGP), i.e. $\{RP\} \subset \{SGP\}$.

3 is a RP and also a SGP

123789 is neither RP nor SGP

123321 is RP as well as SGP

123231 is not a RP but it is a SGP 1_23_23_1

The SGP 334733 can be written in three ways: 3_3_47_3_3, 3_3473_3 and 33_47_33. Preference will be given to 33_47_33, (in compliance with the addition to the definition).

780978 is a SGP 78_09_78, i.e. we will permit natural numbers with leading zeros when they occur inside a GSP.

How do we identify a GSP generated by some sort of a computer application where we can not do it by visual inspection? We could design and implement an algorithm to identify GSPs directly. But it would of course be an advantage if methods applied in the early part of this study to identify the RPs could be applied first followed by a method to identify the GSPs which are not RPs. Even better we could set this up in such a way that we leave the RPs out completely. This leads to us to define in an operational way those GSPs which are not RPs, let us call them Extended Palindromes (EP). The set of EPs must fill the condition

$$\{RP\} \cup \{EP\} = \{GSP\}$$

4. Extended Palindromes

Definition: An Extended Palindrome (EP) is any integer of the form

$$x_1x_2x_3\dots x_n\dots x_3x_2x_1 \text{ or } x_1x_2x_3\dots x_nx_n\dots x_3x_2x_1$$

where $x_1, x_2, x_3, \dots, x_n$ are natural numbers of which at least one is greater than or equal to 10 or has one or more leading zeros. x_1 is not allowed to not have leading zeros. Again x_k should be maximum as a first priority and n maximum as a second priority.

Computer Identification of EPs

The number A to be examined is converted to a string S of length L (leading blanks are removed first). The symbols composing the string are compared by creating substrings from left L_1 and right R_1 . If L_1 and R_1 are found so that $L_1 = R_1$ then A is confirmed to be an EP. However, the process must be continued to obtain a complete split of the string into substrings as illustrated in diagram 2.

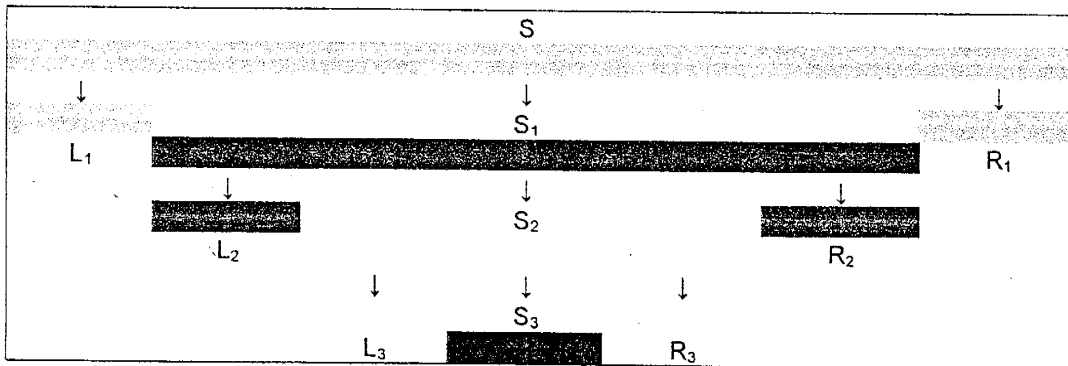

Diagram 2

Diagram 2 illustrates the identification of extended palindromes up to a maximum of 4 elements. This is sufficient for our purposes since a 4 element extended palindrome must have a minimum of 8 digits. A program for identifying extended palindromes corresponding to diagram 2 is given below. Since we have $L_k=R_k$ we will use the notation Z_k for these in the program. The program will operate on strings and the deconcatenation into extended palindrome elements will be presented as strings, otherwise there would be no distinction between 690269 and 692269 which would both be presented as 69_2 (only distinct elements will be recorded) instead of 69_02 and 69_2 respectively.

Comments on the program

It is assumed that the programming in basic is well known. Therefore only the main structure and the flow of data will be commented on:

Lines 20 – 80: Feeding the set of numbers to be examined into the program. In the actual program this is a sequence of prime numbers in the interval $a_1 < a < a_2$.

Lines 90 – 270: On line 130 A is sent off to a subroutine which will exclude A if it happens to be a regular palindrome. The routine will search sub-strings from left and right. If no equal substrings are found it will return to the feeding loop otherwise it will print A and the first element Z_1 while the middle string S_1 will be sent of to the next routine (lines 280 – 400). The flow of data is controlled by the status of the variable u and the length of the middle string.

Lines 280 – 400: This is more or less a copy of the above routine. S_1 will be analyzed in the same way as S in the previous routine. If no equal substrings are found it will print S_1 otherwise it will print Z_2 and send S_2 to the next routine (lines 410 – 520).

Lines 410 – 520: This routine is similar to the previous one except that it is equipped to terminate the analysis. It is seen that routines can be added one after the other to handle extended palindromes with as many elements as we like. The output from this routine consists in writing the terminal elements, i.e. S_2 if A is a 3-element extended palindrome and Z_3 and S_3 if A is a 4-element extended palindrome.

Lines 530 – 560: Regular palindrome identifier described earlier.

```

10 'EPPRSTR, 031028
20 input "Search interval a1 to a2:";A1,A2
30 A=A1
40 while A<A2
50 A=nxtprm(A)
60 gosub 90
70 wend
80 end
90 S=str(A)
100 M=len(S)
110 if M=2 then goto 270
120 S=right(S,M-1)
130 U=0:gosub 530
140 if U=1 then goto 270
150 I1=int((M-1)/2)
160 U=0
170 for I=1 to I1

```

```

180  if left(S,I)=right(S,I) then
190  :Z1=left(S,I)
200  :M1=M-1-2*I:S1=mid(S,I+1,M1)
210  :U=1
220  endif
230  next
240  if U=0 then goto 270
250  print A;" ";Z1;
260  if M1>0 then gosub 280
270  return
280  I2=int(M1/2)
290  U=0
300  for J=1 to I2
310  if left(S1,J)=right(S1,J) then
320  :Z2=left(S1,J)
330  :M2=M1-2*J:S2=mid(S1,J+1,M2)
340  :U=1
350  endif
360  next
370  if U=0 then print " ";S1:goto 400
380  print " ";Z2;
390  if M2>0 then gosub 410 else print
400  return
410  I3=int(M2/2)
420  U=0
430  for K=1 to I3
440  if left(S2,K)=right(S2,K) then
450  :Z3=left(S2,K)
460  :M3=M2-2*K:S3=mid(S2,K+1,M3)
470  :U=1
480  endif
490  next
500  if U=0 then print " ";S2:goto 520
510  print " ";Z3;" ";S3
520  return
530  T=""
540  for I=M to 1 step -1:T=T+mid(S,I,1):next
550  if T=S then U=1:'print "a=";a;"is a RP"
560  return

```

5. Extended Prime Number Palindromes

The computer program for identification of extended palindromes has been implemented to find extended prime number palindromes. The result is shown in tables 7 to 9 for prime numbers $< 10^7$. In these tables the first column identifies the interval in the following way: 1 - 2 in the column headed $x \cdot 10$ means the interval $1 \cdot 10$ to $2 \cdot 10$. EP stands for the number of extended prime number palindromes, RP is the number regular prime number palindromes and P is the number of prime numbers. As we have already concluded the first extended prime palindromes occur for 4-digit numbers and we see that primes which begin and end with one of the digits 1, 3, 7 or 9 are favored. In table 8 the pattern of behavior becomes more explicit. Primes with an even number of digits are not regular palindromes while extended prime palindromes occur for even as well as odd digit primes. It is easy to estimate from the tables that about 25% of the primes of types $1\dots 1$, $3\dots 3$, $7\dots 7$ and $9\dots 9$ are extended

prime palindromes. There are 5761451 primes less than 10^8 , of these 698882 are extended palindromes and only 604 are regular palindromes.

Table 7. Extended and regular palindromes
Intervals 10 -100, 100 - 1000 and 1000 -10000

x 10	EP	RP	P	x 10 ²	EP	RP	P	x 10 ³	EP	RP	P
1 - 2	0	1	4	1 - 2	0	5	21	1 - 2	33		135
2 - 3	0		2	2 - 3	0		16	2 - 3	0		127
3 - 4	0		2	3 - 4	0	4	16	3 - 4	28		120
4 - 5	0		3	4 - 5	0		17	4 - 5	0		119
5 - 6	0		2	5 - 6	0		14	5 - 6	0		114
6 - 7	0		2	6 - 7	0		16	6 - 7	0		117
7 - 8	0		3	7 - 8	0	4	14	7 - 8	30		107
8 - 9	0		2	8 - 9	0		15	8 - 9	0		110
9 - 10	0		1	9 - 10	0	2	14	9 - 10	27		112

Table 8. Extended and regular palindromes
Intervals 10^4 - 10^5 and 10^5 - 10^6

x 10 ⁴	EP	RP	P	X 10 ⁵	EP	RP	P
1 - 2	242	26	1033	1 - 2	2116		8392
2 - 3	12		983	2 - 3	64		8013
3 - 4	230	24	958	3 - 4	2007		7863
4 - 5	9		930	4 - 5	70		7678
5 - 6	10		924	5 - 6	70		7560
6 - 7	9		878	6 - 7	69		7445
7 - 8	216	24	902	7 - 8	1876		7408
8 - 9	10		876	8 - 9	63		7323
9 - 10	203	19	879	9 - 10	1828		7224

Table 9. Extended and regular palindromes
Intervals 10^5 - 10^6 and 10^6 - 10^7

x 10 ⁵	EP	RP	P	x 10 ⁷	EP	RP	P
1 - 2	17968	190	70435	1 - 2	156409		606028
2 - 3	739		67883	2 - 3	6416		587252
3 - 4	16943	172	66330	3 - 4	148660		575795
4 - 5	687		65367	4 - 5	6253		567480
5 - 6	725		64336	5 - 6	6196		560981
6 - 7	688		63799	6 - 7	6099		555949
7 - 8	16133	155	63129	7 - 8	142521		551318
8 - 9	694		62712	8 - 9	6057		547572
9 - 10	15855	151	62090	9 - 10	140617		544501

We recall that the sets of regular palindromes and extended palindromes together form the set of Smarandache Generalized Palindromes. Diagram 3 illustrates this for 5-digit primes.

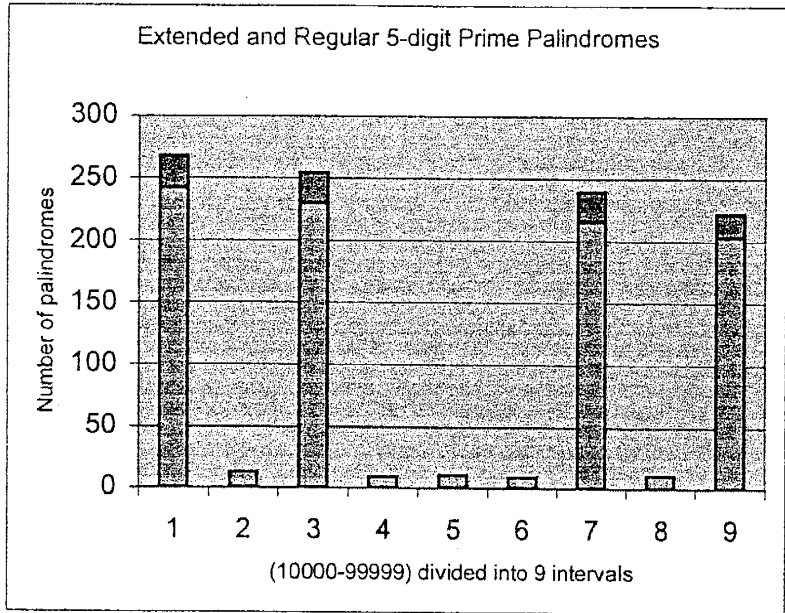

Diagram 3. Extended palindromes shown with blue color, regular with red.

Part II of this study is planned to deal with palindrome analysis of other number sequences.

References:

[1] F. Smarandache, Generalized Palindromes, Arizona State University Special Collections, Tempe.

Chains of Smarandache Semifields

A.S.Muktibodh
Mohota Science College,
Umred Road,
Nagpur 440025, (M.S.)
India
E-mail: amukti2000@yahoo.com

V.M. Wagh
107,above SBI,Jaiprakash nagar
Nagpur -440025 (M.S.)
India.
E-mail: cesedu@sancharnet.in

Abstract

In this paper we have constructed two chains of semifields. All semifields in the chains are Smarandache semifields. Every member of the chain is an extension semifield of Ordered equilateral Integral triangles with Zero triangle such that it is a semivector space over R_{α}^I .

Key words: Ordered integral triangle, Zero triangle, Equilateral integral triangle Smarandache semiring, Smarandache semifield, Smarandache semivector space.

1. Introduction

Recently there has been an increasing interest in the study of Smarandache semirings and associated structures. We propose to construct two chains of infinite Smarandache semifields by defining Equilateral triangles.

An ordered integral triangle as defined in [1] is a triplet (a, b, c) where (a, b, c) are positive integers satisfying $a \geq b \geq c, b + c > a$.

Let us consider a set $R_{\alpha}^I = \{(a, b, c) / a, b, c \in I^+, a \geq b \geq c, b + c > a\} \cup \{0\}$ where $0 = (0, 0, 0)$. We shall call 0 as a Zero triangle.

We define the sum + and the product \cdot of triangles as

$$(a_1, b_1, c_1) + (a_2, b_2, c_2) = (a_1 + a_2, b_1 + b_2, c_1 + c_2) \quad (1)$$

and

$$(a_1, b_1, c_1)(a_2, b_2, c_2) = (a, b, c) \quad (2)$$

where

$$a = \Sigma a_1 a_2 - (b_1 c_2 + c_1 b_2)$$

$$b = \Sigma a_1 a_2 - (a_1 c_2 + c_1 a_2)$$

$$c = \Sigma a_1 a_2 - (a_1 b_2 + b_1 a_2)$$

where

$$\Sigma a_1 a_2 = a_1 a_2 + b_1 b_2 + c_1 c_2$$

It is not difficult to see that;

i) $(R_\Delta^I, +)$ is a commutative semigroup with identity $(0, 0, 0)$.

ii) (R_Δ^I, \cdot) is a semigroup (in fact a monoid)

iii) Multiplication distributes over addition.

iv) $(1, 1, 1)$ is the multiplicative identity.

v) Commutativity holds for multiplication.

Thus, $(R_\Delta^I, +, \cdot)$ is a commutative semiring.

Also,

$$\text{vi) } (a_1, b_1, c_1) + (a_2, b_2, c_2) = (0, 0, 0) \Rightarrow a_1 = a_2 = b_1 = b_2 = c_1 = c_2 = 0$$

Thus, $(R_\Delta^I, +, \cdot)$ is a strict commutative semiring with unity $(1, 1, 1)$. See [2].

vii) Let $x \cdot y = 0$ where $x, y \in R_\Delta^I$. Then $x = 0$ or $y = 0$

We conclude that

- **A1** $(R_\Delta^I, +, \cdot)$ is a semifield.

A triplet (a, b, c) where (a, b, c) are positive rational numbers satisfying $a \geq b \geq c, b + c > a$ is called an ordered rational triangle.

Consider the following set

$R_\Delta^Q = \{(a, b, c) / a, b, c \in \mathcal{Q}^+, a \geq b \geq c, b + c > a\} \cup \{0\}$ where 0 is a zero triangle. Then, it can be verified that $(R_\Delta^Q, +, \cdot)$ is a strict commutative semiring with unity $(1, 1, 1)$.

Also, R_Δ^Q is without zero divisors.

Thus,

- **A2** $(R_\Delta^Q, +, \cdot)$ is a semifield.

A triplet (a, b, c) where (a, b, c) are positive real numbers satisfying $a \geq b \geq c, b + c > a$ is called an ordered real triangle.

Consider the set

$R_\Delta^R = \{(a, b, c) / a, b, c \in \mathcal{R}^+, a \geq b \geq c, b + c > a\} \cup \{0\}$ where 0 is a zero triangle. Then, it can be verified that $(R_\Delta^R, +, \cdot)$ is a strict commutative semiring with unity $(1, 1, 1)$.

Also, R_Δ^R is without zero divisors.

Thus,

- **A3** $(R_\Delta^R, +, \cdot)$ is a semifield.

Consider the set,

$R_\Delta = \{(a, b, c) / a, b, c \in \mathcal{R}^+, a \geq b \geq c\} \cup \{0\}$ where 0 is a zero triangle. Then, it can be verified that $(R_\Delta, +, \cdot)$ is a strict commutative semiring with unity $(1, 1, 1)$.

Also, R_Δ is without zero divisors.

Thus,

- **A4** $(R_\Delta, +, \cdot)$ is a semifield.

Result: From **A1**, **A2**, **A3** and **A4** we obtain a chain of semifields as

- **(A)** $R_\Delta \supset R_\Delta^R \supset R_\Delta^Q \supset R_\Delta^I \supset R_{\Delta_7}^I$

Where $R_{\Delta_7}^I$ is a real equilateral triangle defined in **(A₇)**

Ordered equilateral triangles lead us to a new chain of semifields. A triplet (a, a, a) where $a \in \mathcal{R}^+$ is called an ordered equilateral real triangle.

Consider the following set

$$R_{e_a}^R = \{(a, a, a)/a \in R^+\} \cup \{0\} \text{ where } 0 = (0, 0, 0).$$

Then, $(R_{e_a}^R, +, \cdot)$ is a strict commutative semiring with unity $(1, 1, 1)$ and is without zero divisors.

Thus,

- **A5** $(R_{e_a}^R, +, \cdot)$ is a semifield.

Similarly, triplet (a, a, a) where $a \in Q^+$ is called an ordered equilateral rational triangle.

Consider the following set

$$R_{e_a}^Q = \{(a, a, a)/a \in Q^+\} \cup \{0\} \text{ where } 0 = (0, 0, 0).$$

Then, $(R_{e_a}^Q, +, \cdot)$ is a strict commutative semiring with unity $(1, 1, 1)$ and is without zero divisors.

Thus,

- **A6** $(R_{e_a}^Q, +, \cdot)$ is a semifield.

Similarly, a triplet (a, a, a) where $a \in I^+$ is called an ordered equilateral Integral triangle.

Consider the following set

$$R_{e_a}^I = \{(a, a, a)/a \in I^+\} \cup \{0\} \text{ where } 0 = (0, 0, 0).$$

Then, $(R_{e_a}^I, +, \cdot)$ is a strict commutative semiring with unity $(1, 1, 1)$ and is without zero divisors.

Thus,

- **A7** $(R_{e_a}^I, +, \cdot)$ is a semifield.

Result: From **A1**, **A2**, **A5**, **A6** and **A7** we obtain a chain of semifields as

- **(B)** $R_{e_a} \supset R_{e_a}^R \supset R_{e_a}^Q \supset R_{e_a}^I$

2. Some Observations

1. Members of ordered equilateral triangles act as scalar multiples for every semifield in the chain.

E.g. let $(a, a, a) \in R_{e_a}^R$ and $(x, y, z) \in R_{e_a}$. Then

$$(a, a, a)(x, y, z) = (ax, ay, az) = a(x, y, z).$$

Thus, multiplication by $(a, a, a) \in R_{e_a}^R$ amounts to component wise multiplication. Hence, we call (a, a, a) a magnifier.

2. There is a chain of magnifiers
 $R_{e_a}^R \supset R_{e_a}^Q \supset R_{e_a}^I$
3. Every semifield in the chains **(A)** and **(B)** is of characteristic 0.
4. Every semiring except $R_{e_a}^I$ in chains **(A)** and **(B)** is a Smarandache semiring.
5. Every semifield in the chains **(A)** and **(B)** is an extension semifield of $R_{e_a}^I$.
6. $R_{e_a}^I$ is a prime semifield as it has no proper subsemifield.
7. All the members in the chains are semivector spaces over the semifield $R_{e_a}^I$.
8. All the semifields in the chains **(A)** and **(B)** are Smarandache semi fields because they contain A as a proper subset where A is
 - a. $A = \{(0, 0, 0), (p, p, p), (2p, 2p, 2p), \dots, (rp, rp, rp)\}$ which is isomorphic

with $A' = \{0, p, 2p \dots rp \dots\}$ which is a k-semi algebra [2].

Acknowledgement: Authors would like to thank UGC for supporting this work under the project F.No. 47-111/2002.

References:

1. Mithilesh Kumar Singh and Bishnudeo Sah, Fermat's Last Theorem for Integral Triangles, Mathematics Student, Vol.70, No. 1-4, 191-198, 2001.
2. W.B.Kandasamy, Smarandache Semirings and Semifields, Smarandache Notions J., Vol.13, 88-91, 2002.

On Numbers That Are Pseudo-Smarandache And Smarandache Perfect

Charles Ashbacher
Charles Ashbacher Technologies
Box 294
Hiawatha, IA 52233

In a paper that is scheduled to be published in volume 31(3) of *Journal of Recreational Mathematics*, entitled "On A Generalization of Perfect Numbers"[1], Joseph L. Pe defines a generalization of the definition of perfect numbers. The standard definition is that a number n is perfect if it is the sum of its proper divisors.

$$n = \sum_{i=1}^k d_i$$

Pe expands this by applying a function to the divisors. Therefore, a number n is said to be **f-perfect** if

$$n = \sum_{i=1}^k f(d_i)$$

for f an arithmetical function.

The Pseudo-Smarandache function is defined in the following way:

For any integer $n \geq 1$, the value of the Pseudo-Smarandache function $Z(n)$ is the smallest integer m such that $1 + 2 + 3 + \dots + m$ is evenly divisible by n .

This function was examined in detail in [2].

The purpose of this paper is to report on a search for numbers that are Pseudo-Smarandache and Smarandache perfect.

A computer program was written to search for numbers that are Pseudo-Smarandache perfect. It was run up through 1,000,000 and the following three Pseudo-Smarandache perfect numbers were found.

$n = 4$ factors 1, 2
 $n = 6$ factors 1, 2, 3
 $n = 471544$ factors 1, 2, 4, 8, 58943, 117886, 235772

This leads to several additional questions:

- a) Are there any other Pseudo-Smarandache perfect numbers?
- b) If the answer to part (a) is true, are there any that are odd?
- c) Is there any significance to the fact that the first three nontrivial factors of the only large number are powers of two?

The Smarandache function is defined in the following way:

For any integer $n > 0$, the value of the Smarandache function $S(n)$ is the smallest integer m such that n evenly divides m factorial.

A program was also written to search for numbers that are Smarandache perfect. It was run up through 1,000,000 and only one solution was found.

$n = 12$ factors - 1, 2, 3, 4, 6

This also leads to some additional questions:

- d) Are there any other Smarandache perfect numbers?
- e) If the answer to part (a) is true, are there any that are odd?
- f) Is there any significance to the fact that n has the first three nontrivial integers as factors?

References

1. Joseph L. Pe, "On a Generalization of Perfect Numbers", *Journal of Recreational Mathematics*, 31(3) to appear.
2. Kenichiro Kashihara, *Comments and Topics on Smarandache Notions and Problems*, Erhus University Press, 1996.

Near Pseudo Smarandache Function

A. W. Vyawahare

H. O. D. Mathematics Department,
M. M. College Of Science,
Umred Road, Sakkardara, Nagpur University,
Nagpur, PIN :- 440009, INDIA
E-mail : vanant_ngp@sancharnet.in

K. M. Purohit

H. O. D. Mathematics Department,
V.M.V. Com., J.M.T. Arts & J.J.P. Science College ,
Wardhaman Nagar, Nagpur University, Nagpur, PIN : – 440008 , INDIA
E-mail : kiritpurohit@hotmail.com

Abstract.

The *Pseudo Smarandache Functions* $Z(n)$ are defined by David Gorski [1].

This new paper defines a new *function* $K(n)$ where $n \in N$, which is a slight modification of $Z(n)$ by adding a *smallest natural number* k . Hence this function is “*Near Pseudo Smarandache Function (NPSF)*”.

Some properties of $K(n)$ are presented here, separately, according to as n is *even* or *odd*. A *continued fraction* consisting *NPSF* is shown to be *convergent* [3]. Finally some properties of $K^{-1}(n)$ are also obtained.

MS Classification No: 11-XX

Keywords: *Smarandache Functions, Pseudo Smarandache Functions, Diphantine Equation, Continued Fractions, Covergence.*

1.1 Definition

Near Pseudo Smarandache Function (NPSF) K is defined as follows.

$K : N \rightarrow N$ defined by $K(n) = m$, where $m = \Sigma n + k$ and k is the *smallest natural number* such that n divides m .

1.2 Following are values of $K(n)$ for $n \leq 15$

n	Σn	k	$K(n)$
1	1	1	2
2	3	1	4
3	6	3	9
4	10	2	12
5	15	5	20
6	21	3	24
7	28	7	35
8	36	4	40
9	45	9	54
10	55	5	60
11	66	11	77
12	78	6	84
13	91	13	104
14	105	7	112
15	120	15	135

For more such values see appendix A

2.1 Properties

(i) $k = n$ if n is odd and $n/2$ if n is even.

(a) Let n be odd.

Then $(n + 1)$ is even and hence $(n + 1)/2$ is an integer.

$\therefore \Sigma n = n(n + 1)/2$, being multiple of n , is divisible by n .

Hence n divides $\Sigma n + k$ iff n divides k i.e. iff k is a multiple of n . However, as k is smallest $k = n$.

(b) Let n be even.

Then $\Sigma n + k = n(n + 1)/2 + k = n^2/2 + n/2 + k$

As n is even hence $n/2$ is an integer and $n^2/2$ is divisible by n .

Hence n divides $\Sigma n + k$ iff n divides $n/2 + k$

i.e. iff $n \leq n/2 + k$ or $k \geq n/2$.

However, as k is smallest $k = n/2$.

- (ii) $K(n) = n(n+3)/2$ if n is odd and $K(n) = n(n+2)/2$ if n is even.

$$K(n) = \sum n + k = n(n+1)/2 + k$$

If n is odd then $k = n$ and hence $K(n) = n(n+3)/2$

If n is even then $k = n/2$ and hence $K(n) = n(n+2)/2$.

- (iii) For all $n \in N$; $n(n+2)/2 \leq K(n) \leq n(n+3)/2$

We know $K(n)$ is either $n(n+2)/2$ Or $n(n+3)/2$ depending upon whether n is even or odd.

Hence for all $n \in N$; $n(n+2)/2 \leq K(n) \leq n(n+3)/2$

- (iv) For all $n \in N$; $K(n) > n$.

As $K(n) \geq n(n+2)/2 = n + n^2/2 > n$

Hence $K(n) > n$ for all $n \in N$.

- (v) K is strictly monotonic increasing function of n .

Let $m < n \therefore m+1 \leq n$ i.e. $m + (3-2) \leq n$

Or $m+3 \leq n+2$. So $m < n$ and $m+3 \leq n+2$

$$\therefore m(m+3) < n(n+2)$$

$$\text{Or } m(m+3)/2 < n(n+2)/2$$

$$\therefore K(m) < K(n)$$

Hence $K(n)$ is strictly monotonic increasing function of n .

- (vi) $K(m+n) \neq K(m) + K(n)$

and $K(m \cdot n) \neq K(m) \cdot K(n)$

We know $K(2) = 4$, $K(3) = 9$, $K(5) = 20$, & $K(6) = 24$

So $K(2) + K(3) = 4 + 9 = 13$ & $K(2+3) = K(5) = 20$

Hence $K(2+3) \neq K(2) + K(3)$

Also $K(2) \cdot K(3) = 4 \cdot 9 = 36$ & $K(2 \cdot 3) = K(6) = 24$

Hence $K(2 \cdot 3) \neq K(2) \cdot K(3)$

$$2.2 \quad (i) \quad K(2n+1) - K(2n) = 3n + 2$$

$$K(2n+1) = (2n+1)(2n+4)/2 = 2n^2 + 5n + 2$$

$$K(2n) = 2n(2n+2)/2 = 2n^2 + 2n$$

$$\text{Hence } K(2n+1) - K(2n) = 3n + 2$$

$$(ii) \quad K(2n) - K(2m) = 2(n-m)(n+m+1)$$

$$K(2n) = 2n(2n+2)/2 = 2n^2 + 2n$$

$$\therefore K(2n) - K(2m) = 2(n^2 - m^2) + 2(n-m)$$

$$\text{Hence } K(2n) - K(2m) = 2(n-m)(n+m+1)$$

$$(iii) \quad K(2n+1) - K(2n-1) = 4n+3$$

$$K(2n+1) = (2n+1)(2n+4)/2 = 2n^2 + 5n + 2$$

$$K(2n-1) = (2n-1)(2n+2)/2 = 2n^2 + n - 1$$

$$\text{Hence } K(2n+1) - K(2n-1) = 4n+3$$

$$(iv) \quad K(n) - K(m) = \frac{n-m}{n+m} K(n+m) \text{ where } m, n \text{ are even and } n > m.$$

$$K(n) - K(m) = \frac{n}{2}(n+2) - \frac{m}{2}(m+2)$$

$$= \frac{1}{2}(n^2 + 2n - m^2 - 2m)$$

$$= \frac{1}{2} \{ (n^2 - m^2) + 2(n-m) \}$$

$$= \left(\frac{n-m}{2} \right) (n+m+2)$$

$$= (n-m) \frac{1}{n+m} \frac{n+m}{2} (n+m+2)$$

$$= \frac{n-m}{n+m} K(n+m)$$

(v) Let $K(n) = m$ and

(a) Let n be even then $n \cdot m$ is a perfect square iff $(n+2)/2$ is a perfect square.

(b) Let n be odd then $n \cdot m$ is a perfect square iff $(n+3)/2$ is a perfect square.

(c) $n \cdot m$ is a perfect cube iff $n = 2$ or 3 .

(a) If n is even then $K(n) = m = n(n+2)/2$

$\therefore n \cdot m = n^2(n+2)/2$ Hence if n is even then $n \cdot m$ is a perfect square iff $(n+2)/2$ is a perfect square.

(b) If n is odd then $K(n) = m = n(n+3)/2$

$\therefore n \cdot m = n^2(n+3)/2$ Hence if n is odd then $n \cdot m$ is a perfect square iff $(n+3)/2$ is a perfect square.

(c) Let n be even and let $n = 2p$

Then $m = K(n) = K(2p) = 2p/2(2p+2)$

$\therefore n \cdot m = (2p) \cdot p \cdot 2(p+1) = (2p) \cdot (2p) \cdot (p+1)$

$\therefore n \cdot m$ is a perfect cube iff $p+1 = 2p$

i.e. iff $p = 1$ i.e. iff $n = 2$

Let n be odd and let $n = 2p-1$

Then $m = K(n) = K(2p-1) = (2p-1)(2p-1+3)/2$
 $= (2p-1)(p+1)$

$\therefore n \cdot m = (2p-1) \cdot (2p-1) \cdot (p+1)$

$\therefore n \cdot m$ is a perfect cube iff $p+1 = 2p-1$

i.e. iff $p = 2$ i.e. iff $n = 3$

$\therefore n = 2$ and $n = 3$ are the only two cases where $n \cdot m$ is a perfect cube.

Verification :- $K(2) = 4$ & $2 \cdot 4 = 8 = 2^3$

$K(3) = 9$ & $3 \cdot 9 = 27 = 3^3$

2.3 Ratios

$$(i) \quad \frac{K(n)}{K(n+1)} = \frac{n}{n+1} \quad \text{if } n \text{ is odd.}$$

As n is odd $\therefore n+1$ is even. Hence $K(n) = n(n+3)/2$

$$\begin{aligned} \text{and } K(n+1) &= (n+1)(n+1+2)/2 \\ &= (n+1)(n+3)/2 \end{aligned}$$

$$\text{Hence } \frac{K(n)}{K(n+1)} = \frac{n}{n+1} \quad \text{if } n \text{ is odd.}$$

$$(ii) \quad \frac{K(n)}{K(n+1)} = \frac{n(n+2)}{(n+1)(n+4)} \quad \text{if } n \text{ is even.}$$

As n is even $\therefore n+1$ is odd. Also $K(n) = n(n+2)/2$ and

$$K(n+1) = (n+1)(n+1+3)/2 = (n+1)(n+4)/2$$

$$\text{Hence } \frac{K(n)}{K(n+1)} = \frac{n(n+2)}{(n+1)(n+4)} \quad \text{if } n \text{ is even.}$$

$$(iii) \quad \frac{K(2n)}{K(2n+2)} = \frac{n}{n+2}$$

$$K(2n) = 2n(2n+2)/2 = 2n(n+1)$$

$$K(2n+2) = (2n+2)(2n+4)/2 = 2(n+1)(n+2)$$

$$\text{Hence } \frac{K(2n)}{K(2n+2)} = \frac{n}{n+2}$$

2.4 Equations

$$(i) \quad \text{Equation } K(n) = n \text{ has no solution.}$$

We know $K(n) = n(n+2)/2$ OR $n(n+3)/2$

$$\therefore K(n) = n \text{ iff } n(n+2)/2 = n \text{ OR } n(n+3)/2 = n$$

i.e. iff $n=0$ OR $n=-1$ which is not possible as $n \in \mathbb{N}$.

Hence Equation $K(n) = n$ has no solution.

$$(ii) \quad \text{Equation } K(n) = K(n+1) \text{ has no solution.}$$

If n is even (or odd) then $n+1$ is odd (or even)

Hence $K(n) = K(n+1)$

$$\text{iff } n(n+2)/2 = (n+1)(n+4)/2$$

$$\text{OR } n(n+3)/2 = (n+1)(n+3)/2$$

$$\text{i.e. iff } n(n+2) = (n+1)(n+4)$$

$$\text{OR } n(n+3) = (n+1)(n+3)$$

$$\text{i.e. iff } n^2 + 2n = n^2 + 5n + 4 \quad \text{OR } n^2 + 3n = n^2 + 4n + 3$$

$$\text{i.e. iff } 3n + 4 = 0 \quad \text{OR } n + 3 = 0$$

$$\text{i.e. iff } n = -4/3 \quad \text{OR } n = -3 \text{ which is not possible as } n \in \mathbb{N}.$$

Hence Equation $K(n) = K(n+1)$ has no solution.

(iii) Equation $K(n) = K(n+2)$ has no solution.

If n is even (or odd) then $n+2$ is even (or odd) .

$$\text{Hence } K(n) = K(n+2)$$

$$\text{iff } n(n+2)/2 = (n+2)(n+4)/2$$

$$\text{OR } n(n+3)/2 = (n+2)(n+5)/2$$

$$\text{i.e. iff } n(n+2) = (n+2)(n+4)$$

$$\text{OR } n(n+3) = (n+2)(n+5)$$

$$\text{i.e. iff } n^2 + 2n = n^2 + 6n + 8 \quad \text{OR } n^2 + 3n = n^2 + 7n + 10$$

$$\text{i.e. iff } 4n + 8 = 0 \quad \text{OR } 4n + 10 = 0$$

$$\text{i.e. iff } n = -2 \quad \text{OR } n = -5/2 \text{ which is not possible as } n \in \mathbb{N}.$$

Hence Equation $K(n) = K(n+2)$ has no solution.

(iv) To find n for which $K(n) = n^2$

(a) Let n be even.

$$\text{Then } K(n) = n^2 \text{ iff } n(n+2)/2 = n^2$$

$$\text{i.e. iff } n^2 + 2n = 2n^2 \quad \text{Or } n(n-2) = 0$$

$$\text{i.e. iff } n = 0 \text{ or } n = 2. \text{ Hence } n = 2 \text{ is the only}$$

even value of n for which $K(n) = n^2$

(b) Let n be odd.

$$\text{Then } K(n) = n^2 \text{ iff } n(n+3)/2 = n^2$$

$$\text{i.e. iff } n^2 + 3n = 2n^2 \quad \text{Or } n(n-3) = 0$$

$$\text{i.e. iff } n = 0 \text{ or } n = 3. \text{ Hence } n = 3 \text{ is the only}$$

odd value of n for which $K(n) = n^2$

So 2 and 3 are the only solutions of $K(n) = n^2$

2.5 Summation and product

(i) For n odd $\Sigma K(2n) - \Sigma K(2n-1) = K(n)$
 $\Sigma K(2n) = \Sigma n(2n+2) = 2\Sigma n(n+1) = 2\Sigma(n^2+n)$
 $\Sigma K(2n-1) = \Sigma(2n-1)(2n+2)/2n$
 $= \Sigma(2n-1)(n+1) = \Sigma(2n^2+n-1)$
 $\therefore \Sigma K(2n) - \Sigma K(2n-1) = \Sigma(n+1) = n(n+1)/2 + n$
 $= n(n+3)/2 = K(n)$

Hence for n odd $\Sigma K(2n) - \Sigma K(2n-1) = K(n)$

(ii) $\sum_{m=1}^{m=n} K(a^m) = K(a) + K(a^2) + K(a^3) + \dots + K(a^n)$
 $= \frac{a(a^n-1)}{2(a^2-1)} (a^{n+1} + 3a + 2)$ if a is even
 $= \frac{a(a^n-1)}{2(a^2-1)} (a^{n+1} + 4a + 3)$ if a is odd

(a) Let a is even. Then

$$\begin{aligned} \sum_{m=1}^{m=n} K(a^m) &= K(a) + K(a^2) + K(a^3) + \dots + K(a^n) \\ &= a(a+2)/2 + a^2(a^2+2)/2 + a^3(a^3+2)/2 \\ &\quad + \dots + a^n(a^n+2)/2 \\ &= (a^2/2 + a) + (a^4/2 + a^2) + \\ &\quad (a^6/2 + a^3) + \dots + (a^{2n}/2 + a^n) \\ &= (1/2) \{a^2 + a^4 + a^6 + \dots + a^{2n}\} \\ &\quad + \{a + a^2 + a^3 + \dots + a^n\} \\ &= (1/2) \{a^2 + (a^2)^2 + (a^2)^3 + \dots + (a^2)^n\} \\ &\quad + \{a + a^2 + a^3 + \dots + a^n\} \\ &= \frac{1}{2} a^2 \frac{(a^{2n}-1)}{a^2-1} + \frac{a(a^n-1)}{a-1} \\ &= \frac{a^2}{2} \frac{(a^n-1)(a^n+1)}{(a-1)(a+1)} + \frac{a(a^n-1)}{a-1} \\ &= \frac{a(a^n-1)}{2(a-1)} \left\{ \frac{a(a^n+1)}{(a+1)} + 2 \right\} \\ &= \frac{a(a^n-1)}{2(a-1)} \left\{ \frac{a^{n+1} + a + 2a + 2}{(a+1)} \right\} \end{aligned}$$

$$= \frac{a(a^n - 1)}{2(a^2 - 1)} (a^{n+1} + 3a + 2)$$

Hence $K(a) + K(a^2) + K(a^3) + \dots + K(a^n)$

$$= \frac{a(a^n - 1)}{2(a^2 - 1)} (a^{n+1} + 3a + 2) \text{ if } a \text{ is even}$$

(b) Let a is odd. Then

$$\begin{aligned} \sum_{m=1}^{m=n} K(a^m) &= K(a) + K(a^2) + K(a^3) + \dots + K(a^n) \\ &= a(a+3)/2 + a^2(a^2+3)/2 + a^3(a^3+3)/2 \\ &\quad + \dots + a^n(a^n+3)/2 \\ &= (1/2) \{ a^2 + 3a + a^4 + 3a^2 + a^6 \\ &\quad + 3a^3 + \dots + a^{2n} + 3a^n \} \\ &= (1/2) \{ a^2 + a^4 + a^6 + \dots + a^{2n} \} \\ &\quad + \{ a + a^2 + a^3 + \dots + a^n \} \\ &= (1/2) \{ [a^2 + (a^2)^2 + \dots + (a^2)^n] \\ &\quad + 3 \{ (a + a^2 + a^3 + \dots + a^n) \} \} \\ &= \frac{1}{2} \left\{ a^2 \frac{(a^{2n} - 1)}{a^2 - 1} + \frac{3a(a^n - 1)}{a - 1} \right\} \\ &= \frac{a(a^n - 1)}{2(a - 1)} \left\{ \frac{a(a^n + 1)}{(a + 1)} + 3 \right\} \\ &= \frac{a(a^n - 1)}{2(a - 1)} \left\{ \frac{a^{n+1} + a + 3a + 3}{(a + 1)} \right\} \\ &= \frac{a(a^n - 1)}{2(a^2 - 1)} (a^{n+1} + 4a + 3) \end{aligned}$$

Hence $K(a) + K(a^2) + K(a^3) + \dots + K(a^n)$

$$= \frac{a(a^n - 1)}{2(a^2 - 1)} (a^{n+1} + 4a + 3) \text{ if } a \text{ is odd}$$

(iii) $\Pi K(2n) = 2^n \cdot n! \cdot (n+1)!$

$$\begin{aligned} \Pi K(2n) &= \Pi 2n(2n+2)/2 = \Pi 2n(n+1) \\ &= \Pi 2 \cdot \Pi n \cdot \Pi(n+1) \\ &= 2n \cdot n! \cdot (n+1)! \end{aligned}$$

Hence $\Pi K(2n) = 2^n \cdot n! \cdot (n+1)!$

$$\begin{aligned}
\text{(iv)} \quad \Pi K(2n-1) &= (1/2^n) \cdot 2n! \cdot n! \cdot (n+1) \\
\Pi K(2n-1) &= \Pi (2n-1)(2n+2)/2 \\
&= \Pi (2n-1)(n+1) \\
&= \Pi (2n-1)(n+1) \\
&= \Pi (2n-1) \Pi (n+1) \\
&= (2n-1)! (n+1)! \\
&= (1/2^n) \cdot 2n! \cdot n! \cdot (n+1)
\end{aligned}$$

2.6 Inequalities

(i) (a) For even numbers a and $b > 4$; $K(a \cdot b) > K(a) \cdot K(b)$

Assume that $K(a \cdot b) \leq K(a) \cdot K(b)$

$$\text{i.e. } ab(ab+2)/2 \leq a(a+2)/2 \cdot b(b+2)/2$$

$$\therefore ab+2 \leq (a+2) \cdot (b+2) / 2$$

$$\text{i.e. } ab \leq 2(a+b) \dots \dots \dots \text{(A)}$$

Now as a and $b > 4$ so let $a = 4 + h$, $b = 4 + k$ for some

$$h, k \in \mathbb{N} \therefore \text{(A)} \Rightarrow (4+h)(4+k) \leq (8+2h) + (8+2k)$$

$$\text{i.e. } 16 + 4h + 4k + hk \leq 16 + 2h + 2k$$

$$\text{i.e. } 2h + 2k + hk \leq 0 \dots \dots \dots \text{(I)}$$

But as $h, k \in \mathbb{N}$, hence $2h + 2k + hk > 0$

This contradicts (I) Hence if both a and b are even and

$$a, b > 4 \text{ then } K(a \cdot b) > K(a) \cdot K(b)$$

(b) For odd numbers $a, b \geq 7$; $K(a \cdot b) > K(a) \cdot K(b)$

Let $K(a \cdot b) \leq K(a) \cdot K(b)$

$$\text{i.e. } ab(ab+3)/2 \leq a(a+3)/2 \cdot b(b+3)/2$$

$$\therefore ab+3 \leq (a+3) \cdot (b+3) / 2$$

$$\text{i.e. } 2ab+6 \leq ab+3a+3b+9$$

$$\text{or } ab \leq 3a+3b+3 \dots \dots \dots \text{(B)}$$

Now as $a, b \geq 7$ so let $a = 7 + h$, $b = 7 + k$ for some $h, k \in \mathbb{W}$

$$\therefore \text{(B)} \Rightarrow (7+h)(7+k) \leq 3(7+h) + 3(7+k) + 3$$

$$\text{i.e. } 49 + 7h + 7k + hk \leq 45 + 3h + 3k$$

$$\text{i.e. } 4 + 4h + 4k + hk \leq 0 \dots \dots \dots \text{(II)}$$

But $h, k \in \mathbb{W}$ hence $4 + 4h + 4k + hk > 0$

This contradicts (II) Hence $K(a \cdot b) > K(a) \cdot K(b)$

(c) For a odd, b even and $a, b > 5$; $K(a \cdot b) > K(a) \cdot K(b)$

Let $K(a \cdot b) \leq K(a) \cdot K(b)$

i.e. $ab(ab+2)/2 \leq a(a+3)/2 \cdot b(b+2)/2$

$\therefore ab+2 \leq (a+3) \cdot (b+2) / 2$

i.e. $ab \leq 2a + 3b + 2 \dots \dots \dots$ (C)

Now $a, b > 5$ so let $a = 6 + h$ and $b = 6 + k$

for some $h, k \in \mathbb{W}$

\therefore (C) $\Rightarrow (6+h)(6+k) \leq 2(6+h) + 3(6+k) + 2$

i.e. $36 + 6h + 6k + hk \leq 12 + 2h + 18 + 3k + 2$

i.e. $4h + 3k + hk + 4 \leq 0 \dots \dots \dots$ (III)

But $h, k \in \mathbb{W} \therefore 4h + 3k + hk + 4 > 0$

This contradicts (III) Hence $K(a \cdot b) > K(a) \cdot K(b)$

Note :- It follows from (xii) (a), (b) and (c) that in general if $a, b > 5$ then $K(a \cdot b) > K(a) \cdot K(b)$

(ii) If $a > 5$ then for all $n \in \mathbb{N}$; $K(a^n) > n K(a)$

As $a > 5 \therefore K(a^n) = K(a \cdot a \cdot a \dots n \text{ times})$

$> K(a) \cdot K(a) \cdot K(a) \text{ up to } n \text{ times}$

$> \{K(a)\}^n \geq n K(a)$

Hence if $a > 5$ then for all $n \in \mathbb{N}$; $K(a^n) > n K(a)$

2.7 Summation of reciprocals.

(i) $\sum_{n=1}^{n=\infty} \frac{1}{K(2n)}$ is convergent.

$K(2n) = 2n(2n+2)/2 = 2n(n+1)$

$\therefore \frac{1}{K(2n)} = \frac{1}{2n(n+1)} = \frac{1}{2n^2(1+1/n)} \leq 1/n^2$

So series is dominated by convergent series and hence it is convergent.

(ii) $\sum_{n=1}^{n=\infty} \frac{1}{K(2n-1)}$ is convergent.

$$K(2n-1) = (2n-1)(2n+2)/2 = (2n-1)(n+1)$$

$$\begin{aligned} \therefore \frac{1}{K(2n-1)} &= \frac{1}{(2n-1)(n+1)} \\ &= \frac{1}{n^2(2 - 1/n)(1 + 1/n)} \\ &\leq 1/n^2 \end{aligned}$$

Hence by comparison test series is convergent.

(iii) $\sum_{n=1}^{n=\infty} \frac{1}{K(n)}$ is convergent.

$$K(n) \geq n(n+2)/2$$

$$\therefore \frac{1}{K(n)} \leq \frac{2}{n^2(1 + 2/n)} \leq 1/n^2$$

Hence series is convergent.

(iv) $\sum_{n=1}^{n=\infty} \frac{K(n)}{n}$ is divergent.

$$\frac{K(n)}{n} \geq \frac{n+2}{2} \geq \frac{n}{2}$$

Hence series is divergent.

2.8 Limits.

(i) $\lim_{n \rightarrow \infty} \frac{K(2n)}{\sum 2n} = 2$

$$K(2n) = 2n(2n+2)/2 = 2n(n+1)$$

$$\sum 2n = 2 \sum n = n(n+1)$$

$$\frac{K(2n)}{\sum 2n} = \frac{2n(n+1)}{n(n+1)} = 2$$

$$\therefore \lim_{n \rightarrow \infty} \frac{K(2n)}{\sum 2n} = 2$$

$$(ii) \quad \lim_{n \rightarrow \infty} \frac{K(2n-1)}{\sum (2n-1)} = 2$$

$$K(2n-1) = (2n-1)(2n-1+3)/2 \\ = (2n-1)(2n+2)/2 = (2n-1)(n+1)$$

$$\sum 2n-1 = 2n(n+1)/2 - n = n^2$$

$$\therefore \frac{K(2n-1)}{\sum (2n-1)} = \frac{(2n-1)(n+1)}{n^2} = (2 - \frac{1}{n})(1 + \frac{1}{n})$$

$$\therefore \lim_{n \rightarrow \infty} \frac{K(2n-1)}{\sum (2n-1)} = 2$$

$$(iii) \quad \lim_{n \rightarrow \infty} \frac{K(2n+1)}{K(2n-1)} = 1$$

$$K(2n+1) = (2n+1)(2n+1+3)/2 \\ = (2n+1)(n+2)$$

$$K(2n-1) = (2n-1)(2n-1+3)/2 \\ = (2n-1)(2n+2)/2 = (2n-1)(n+1)$$

$$\therefore \frac{K(2n+1)}{K(2n-1)} = \frac{(2n+1)(n+2)}{(2n-1)(n+1)}$$

$$\text{OR } \frac{K(2n+1)}{K(2n-1)} = \frac{(2 + \frac{1}{n})(1 + \frac{2}{n})}{(2 - \frac{1}{n})(1 + \frac{1}{n})}$$

$$\therefore \lim_{n \rightarrow \infty} \frac{K(2n+1)}{K(2n-1)} = 1$$

$$(iv) \quad \lim_{n \rightarrow \infty} \frac{K(2n+2)}{K(2n)} = 1$$

$$K(2n+2) = (2n+2)(2n+2+2)/2 \\ = 2(n+1)(n+2)$$

$$K(2n) = 2n(2n+2)/2 = 2n(n+1)$$

$$\therefore \frac{K(2n+2)}{K(2n)} = \frac{2(n+1)(n+2)}{2n(n+1)}$$

$$\text{OR } \frac{K(2n+2)}{K(2n)} = (1 + \frac{2}{n})$$

$$\therefore \lim_{n \rightarrow \infty} \frac{K(2n+2)}{K(2n)} = 1$$

2.9 Additional Properties.

- (i) Let C be the *continued fraction* of the sequence $\{K(n)\}$

$$C = K(1) + \frac{K(2)}{K(3) + \frac{K(4)}{K(5) + \frac{K(6)}{K(7) + \dots}}}}$$

$$= K(1) + \frac{K(2)}{K(3) + \frac{K(4)}{K(5) + \frac{K(6)}{K(7) + \dots}}}}$$

The n^{th} term $T_n = \frac{K(2n)}{K(2n+1)} = \frac{2n^2 + 2n}{2n^2 + 5n + 2}$

Hence $T_n < 1$ for all n and \therefore with respect to [3], C is convergent and $2 < C < 3$.

- (ii) $K(2^n - 1) + 1$ is a *triangular number*.

Let $x = 2n$ then

$$K(2n-1) + 1 = K(x-1) + 1$$

$$= \{ (x-1)(x+2)/2 \} + 1$$

$$= \{ x^2 + x \} / 2$$

$$= x(x+1)/2 \text{ which is a triangular number.}$$

- (iii) *Fibonacci sequence does not exist in the sequence $\{K(n)\}$*

- (a) If possible then let $K(n) + K(n+1) = K(n+2)$ for some n where n is even.

$$\therefore n(n+2)/2 + (n+1)(n+4)/2 = (n+2)(n+4)/2$$

$$\therefore (n^2 + 2n) + (n^2 + 5n + 4) = n^2 + 6n + 8$$

$$\therefore n^2 + n - 4 = 0 \text{ OR } n = \frac{-1 \pm \sqrt{17}}{2} \text{ which is not}$$

possible as $n \in \mathbb{N}$.

- (b) Let $K(n) + K(n+1) = K(n+2)$ for some n where n is odd.

$$\therefore n(n+3)/2 + (n+1)(n+3)/2 = (n+2)(n+5)/2$$

$$\therefore (n+3)(2n+1) = n^2 + 7n + 10$$

$$\therefore n^2 = 7 \text{ OR } n = \sqrt{7} \text{ which is not possible as } n \in \mathbb{N}.$$

Hence there is no *Fibonacci sequence* in $\{K(n)\}$

Similarly there is no *Lucas sequence* in $\{K(n)\}$

- (iv) $K(n) > \max \{K(d) : \text{Where } d \text{ is a proper divisor of } n \text{ and } n \text{ is composite}\}.$

As d is a proper divisor of $n \therefore d < n$ and as function K is

strictly monotonic increasing hence $K(d) < K(n)$.

So for each proper divisor d we have $K(n) > K(d)$

and hence $K(n) > \max \{K(n)\}$

- (v) **Palindromes in $\{K(n)\}$**

$$K(11) = 77, \quad K(21) = 252, \quad K(29) = 464,$$

$$K(43) = 989, \quad K(64) = 212$$

are only Palindromes for $n \leq 100$.

- (vi) **Pythagorean Triplet**

We know that $(5, 12, 13)$ is a Pythagorean Triplet.

Similarly $(K(5), K(12), K(13))$ is a Linear Triplet because

$$K(5) + K(12) = K(13).$$

- (vii) $K(2^n) = 2^n(2^n + 2)/2 = 2^{2n-1} + 2^n$

$$\therefore K(2^3) = 2^5 + 2^3 = 32 + 8 = 40 \text{ and } 40 + 1 = 41 \text{ is prime.}$$

Similarly $K(2^4) = 2^7 + 2^4 = 128 + 16 = 144$ and $144 - 1 = 139$ is prime.

Hence it is conjectured that $K(2^n) - 1$ or $K(2^n) + 1$ is prime.

3.1 To find K^{-1} when n is odd

$$\therefore K(n) = n(n+3)/2 = t \text{ (say)}$$

$$\therefore n = K^{-1}(t) \text{ Also as } n(n+3)/2 = t$$

$$\therefore n = \frac{-3 + \sqrt{9+8t}}{2} \text{ OR } K^{-1}(t) = n = \frac{-3 + \sqrt{9+8t}}{2}$$

$$\text{OR } K^{-1}(t_r) = \frac{-3 + \sqrt{9+8t_r}}{2} = n_r$$

Note:

- (I) In the above expression plus sign is taken to ensure that $K^{-1}(t_r) \in N$.
- (II) Also $K^{-1}(t_r) \in N$ iff $\sqrt{9 + 8t_r}$ is an odd integer. and for this $9 + 8t_r$ should be a perfect square.

From above two observations we get possible values of t_r as 2, 9, 20, 35 etc . . .

3.2 Following are some examples of $K^{-1}(t_r)$

r	t_r	$K^{-1}(t_r) = n_r$	$q_r = t_r / n_r$
1	2	1	2
2	9	3	3
3	20	5	4
4	35	7	5
5	54	9	6
6	77	11	7
7	104	13	8

3.3 Following results are obvious.

- (i) $K^{-1}(t_r) = n_r = 2r - 1$
- (ii) $t_r = t_{r-1} + (4r - 1)$
- (iii) $t_r = n_r q_r = (2r - 1) q_r$
- (iv) $n_r = q_r + (r - 2)$
- (v) $\Sigma t_r = \Sigma t_{r-1} + r \cdot n_r$
- (vi) Every t_{r+1} is a triangular number.
- (vii) As $t_r - t_{r-1} = 4r - 1$
- \therefore Second difference $D^2(t_r) = 4r - 1 - [4(r - 1) - 1] = 4$

3.4 To find K^{-1} when n is even

$$\therefore K(n) = n(n+2)/2 = t \text{ (say)}$$

$$\therefore n = K^{-1}(t) \text{ Also as } n(n+2)/2 = t$$

$$\therefore n = \frac{-2 + \sqrt{4+8t}}{2} \text{ OR } K^{-1}(t) = n = -1 + \sqrt{1+2t}$$

$$\text{OR } K^{-1}(t_r) = -1 + \sqrt{1+2t_r} = n_r$$

Note:

(I) In the above expression plus sign is taken to ensure that

$$K^{-1}(t_r) \in N.$$

(II) Also $K^{-1}(t_r) \in N$ iff $\sqrt{1+2t_r}$ is an odd integer.

and for this first of all $1+2t_r$ should be a perfect square of some odd integer.

From above two observations we get possible values of t_r

as 4, 12, 24, 40 etc . . .

3.5 Following are some examples of $K^{-1}(t_r)$

r	t_r	$K^{-1}(t_r) = n_r$	$q_r = t_r / n_r$
1	4	2	2
2	12	4	3
3	24	6	4
4	40	8	5
5	60	10	6
6	84	12	7
7	112	14	8

3.6 Following results are obvious.

(i) $K^{-1}(t_r) = n_r = 2r$

(ii) $t_r = t_{r-1} + 4r$

(iii) $t_r = n_r q_r = 2r \cdot q_r$

(iv) $n_r = q_r + (r-1)$

(v) $\Sigma t_r = \Sigma t_{r-1} + (r+1) \cdot n_r$

(vi) $t_r = n_r [n_r - r + 1]$

(vi) Every t_r is a multiple of 4.

(vii) $t_r = 4p$ where p is a triangular number.

(viii) For $r = 8$, $t_r = 144$, $n_r = 16$ and $q_r = 9$. So for $r = 8$; t_r , n_r , and q_r

are all *perfect square*.

(ix) As $t_r - t_{r-1} = 4r$

\therefore Second difference $D^2(t_r) = 4r - [4(r-1)] = 4$

3.7 Monoid

Let $M = \{K^{-1}(2), K^{-1}(4), K^{-1}(9), K^{-1}(12) \dots\}$ be the collection of *images* of K^{-1} including both *even* and *odd* n .

Let \bullet stands for multiplication. Then (M, \bullet) is a *Monoid*.

For it satisfies (I) *Closure* (II) *Associativity* (III) *Identity*

Here *identity* is $K^{-1}(2)$.

In fact (M, \bullet) is a *Commutative Monoid*.

As *inverse* of an element does not exist in M hence it is not a *group*.

Coincidentally, M happens to be a *cyclic monoid* with operation $+$.

Because $K^{-1}(9) = [K^{-1}(2)]^3$

References :-

- [1] Ashbacher C : *Introduction to Smarandache Functions.*
(*Journal of Recreational Mathematics* 1996, P. 249)
 - [2] David Gorski : *The Pseudo Smarandache Functions.*
(*Smarandache Notion Journal* Vol. 12, 2000, P. 140)
 - [3] Castrillo Jose : *Smarandache Continued Fractions.*
(*Smarandache Notion Journal* Vol. 9, 1998, P. 40)
-

Appendix – [A]

Values of K (n) for n = 1 To 100

n	Σn	k	K(n)
1	1	1	2
2	3	1	4
3	6	3	9
4	10	2	12
5	15	5	20
6	21	3	24
7	28	7	35
8	36	4	40
9	45	9	54
10	55	5	60
11	66	11	77
12	78	6	84
13	91	13	104
14	105	7	112
15	120	15	135
16	136	8	144
17	153	17	170
18	171	9	180
19	190	19	209
20	210	10	220
21	231	21	252
22	253	11	264
23	276	23	299
24	300	12	312
25	325	25	350

n	Σn	k	K(n)
26	351	13	364
27	378	27	405
28	406	14	420
29	435	29	464
30	465	15	480
31	496	31	527
32	528	16	544
33	561	33	594
34	595	17	612
35	630	35	665
36	666	18	684
37	703	37	740
38	741	19	760
39	780	39	819
40	820	20	840
41	861	41	902
42	903	21	924
43	946	43	989
44	990	22	1012
45	1035	45	1080
46	1081	23	1104
47	1128	47	1175
48	1176	24	1200
49	1225	49	1274
50	1275	25	1300

n	Σn	k	K(n)
51	1326	51	1377
52	1378	26	1404
53	1431	53	1484
54	1485	27	1512
55	1540	55	1595
56	1596	28	1624
57	1653	57	1710
58	1711	29	1740
59	1770	59	1829
60	1830	30	1860
61	1891	61	1952
62	1953	31	1984
63	2016	63	2079
64	2080	32	2112
65	2145	65	2210
66	2211	33	2244
67	2278	67	2345
68	2346	34	2380
69	2415	69	2484
70	2485	35	2520
71	2556	71	2627
72	2628	36	2664
73	2701	73	2774
74	2775	37	2812
75	2850	75	2925

n	Σn	k	K(n)
76	2926	38	2964
77	3003	77	3080
78	3081	39	3120
79	3160	79	3239
80	3240	40	3280
81	3321	81	3402
82	3403	41	3444
83	3486	83	3569
84	3570	42	3612
85	3655	85	3740
86	3741	43	3784
87	3828	87	3915
88	3916	44	3960
89	4005	89	4094
90	4095	45	4140
91	4186	91	4277
92	4278	46	4324
93	4371	93	4464
94	4465	47	4512
95	4560	95	4655
96	4656	48	4704
97	4753	97	4850
98	4851	49	4900
99	4950	99	5049
100	5050	50	5100

ON THE k -POWER FREE NUMBER SEQUENCE

ZHANG TIANPING

Department of Mathematics , Northwest University
Xi'an, Shaanxi, P.R.China

ABSTRACT. The main purpose of this paper is to study the distribution properties of k -power free numbers, and give an interesting asymptotic formula.

1. INTRODUCTION AND RESULTS

A natural number n is called a k -power free number if it can not be divided by any p^k , where p is a prime number. One can obtain all k -power free number by the following method: From the set of natural numbers (except 0 and 1)

-take off all multiples of 2^k (i.e. $2^k, 2^{k+1}, 2^{k+2} \dots$).

-take off all multiples of 3^k .

-take off all multiples of 5^k .

...and so on (take off all multiples of all k -power primes).

Now the k -power free number sequence is 2, 3, 4, 5, 6, 7, 9, 10, 11, 12, 13, 14, 15, 17, ...
In reference [1], Professor F. Smarandache asked us to study the properties of the k -power free number sequence. About this problem, it seems that none had studied it before. In this paper, we use the analytic method to study the distribution properties of this sequence, and obtain an interesting asymptotic formula. For convenience, we define $\omega(n)$ as following: $\omega(n) = r$, if $n = p_1^{\alpha_1} p_2^{\alpha_2} \dots p_r^{\alpha_r}$. Then we have the following:

Theorem. *Let A denotes the set of all k -power free numbers. Then we have the asymptotic formula*

$$\sum_{\substack{n \leq x \\ n \in A}} \omega^2(n) = \frac{x(\ln \ln x)^2}{\zeta(k)} + O(x \ln \ln x),$$

where $\zeta(k)$ is the Riemann zeta-function.

Key words and phrases. k -power free numbers; Mean Value; Asymptotic formula.

2. SEVERAL LEMMAS

Lemma 1. For any real number $x \geq 2$, we have the asymptotic formula

$$\begin{aligned}\sum_{n \leq x} \omega(n) &= x \ln \ln x + Ax + O\left(\frac{x}{\ln x}\right), \\ \sum_{n \leq x} \omega^2(n) &= x(\ln \ln x)^2 + O(x \ln \ln x).\end{aligned}$$

where $A = \gamma + \sum_p \left(\ln\left(1 - \frac{1}{p}\right) + \frac{1}{p}\right)$.

Proof. (See reference [2]).

Lemma 2. Let $\mu(n)$ is Möbius function, then for any real number $x \geq 2$, we have the following identity

$$\sum_{n=1}^{\infty} \frac{\mu(n)\omega(n)}{n^s} = -\frac{1}{\zeta(s)} \sum_p \frac{1}{p^s - 1}.$$

Proof. From the definition of $\omega(n)$ and $\mu(n)$, we have

$$\begin{aligned}\sum_{n=1}^{\infty} \frac{\mu(n)\omega(n)}{n^s} &= \sum_{n=2}^{\infty} \frac{\mu(n) \sum_{p|n} 1}{n^s} = \sum_p \sum_{\substack{n=1 \\ (n,p)=1}}^{\infty} \frac{\mu(np)}{n^s p^s} = -\sum_p \frac{1}{p^s} \sum_{\substack{n=1 \\ (n,p)=1}}^{\infty} \frac{\mu(n)}{n^s} \\ &= -\sum_p \frac{1}{p^s} \left(\sum_{n=1}^{\infty} \frac{\mu(n)}{n^s} \right) \left(1 - \frac{1}{p^s}\right)^{-1} = -\frac{1}{\zeta(s)} \sum_p \frac{1}{p^s - 1}.\end{aligned}$$

This proves Lemma 2.

Lemma 3. Let $k \geq 2$ is a fixed integer, then for any real number $x \geq 2$, we have the asymptotic formula

$$\sum_{d^k m \leq x} \omega^2(m)\mu(d) = \frac{x(\ln \ln x)^2}{\zeta(k)} + O(x \ln \ln x).$$

Proof. From Lemma 1, we have

$$\begin{aligned}\sum_{d^k m \leq x} \omega^2(m)\mu(d) &= \sum_{d \leq x^{\frac{1}{k}}} \mu(d) \sum_{m \leq x/d^k} \omega^2(m) \\ &= \sum_{d \leq x^{\frac{1}{k}}} \mu(d) \left(\frac{x}{d^k} (\ln \ln \frac{x}{d^k})^2 + O\left(\frac{x}{d^k} \ln \ln \frac{x}{d^k}\right) \right) \\ &= x \sum_{d \leq x^{\frac{1}{k}}} \frac{\mu(d)}{d^k} \left(\ln \ln x + \ln \ln \left(1 - \frac{k \ln d}{\ln x}\right) \right)^2 + O(x \ln \ln x) \\ &= x (\ln \ln x)^2 \sum_{d=1}^{\infty} \frac{\mu(d)}{d^k} + O\left(x \ln \ln x \sum_{d \leq x^{\frac{1}{k}}} \frac{\ln d}{d^k \ln x} \right) + O(x \ln \ln x) \\ &= \frac{x(\ln \ln x)^2}{\zeta(k)} + O(x \ln \ln x).\end{aligned}$$

This proves Lemma 3.

Lemma 4. For any real number $x \geq 2$, we have the estimate

$$\sum_{d^k m \leq x} \omega^2(d) \mu(d) = O(x).$$

Proof. From Lemma 1, we have

$$\begin{aligned} \sum_{d^k m \leq x} \omega^2(d) \mu(d) &= \sum_{d \leq x^{\frac{1}{k}}} \omega^2(d) \mu(d) \sum_{m \leq x/d^k} 1 = \sum_{d \leq x^{\frac{1}{k}}} \omega^2(d) \mu(d) \left[\frac{x}{d^k} \right] \\ &= x \sum_{d \leq x^{\frac{1}{k}}} \frac{\omega^2(d) \mu(d)}{d^k} + O \left(\sum_{d \leq x^{\frac{1}{k}}} \omega^2(d) \mu(d) \right) = O(x). \end{aligned}$$

This proves Lemma 4.

Lemma 5. For any real number $x \geq 2$, we have the estimate

$$\sum_{d^k m \leq x} \omega^2((d, m)) \mu(d) = O(x).$$

Proof. Assume that (u, v) is the greatest common divisor of u and v , then we have

$$\begin{aligned} \sum_{d^k m \leq x} \omega^2((d, m)) \mu(d) &= \sum_{d \leq x^{\frac{1}{k}}} \mu(d) \sum_{\substack{u|d \\ u|m}} \sum_{m \leq x/d^k} \omega^2(u) = \sum_{d \leq x^{\frac{1}{k}}} \mu(d) \sum_{u|d} \omega^2(u) \left[\frac{x}{ud^k} \right] \\ &= x \sum_{d=1}^{\infty} \frac{\mu(d) \sum_{u|d} \frac{\omega^2(u)}{u}}{d^k} + O \left(\sum_{d \leq x^{\frac{1}{k}}} \mu(d) \sum_{u|d} \omega^2(u) \right) = O(x). \end{aligned}$$

This proves Lemma 5.

Lemma 6. For any real number $x \geq 2$, we have the asymptotic formula

$$\sum_{d^k m \leq x} \omega(d) \omega(m) \mu(d) = Cx \ln \ln x + O(x),$$

where $C = -\frac{1}{\zeta(k)} \sum_p \frac{1}{p^k - 1}$.

Proof. From Lemma 1 and Lemma 2 we have

$$\begin{aligned} \sum_{d^k m \leq x} \omega(d) \omega(m) \mu(d) &= \sum_{d \leq x^{\frac{1}{k}}} \omega(d) \mu(d) \sum_{m \leq x/d^k} \omega(m) \\ &= \sum_{d \leq x^{\frac{1}{k}}} \omega(d) \mu(d) \left(\frac{x \ln \ln \frac{x}{d^k}}{d^k} + \frac{Ax}{d^k} + O \left(\frac{x}{d^k \ln \frac{x}{d^k}} \right) \right) \\ &= x \sum_{d \leq x^{\frac{1}{k}}} \frac{\omega(d) \mu(d)}{d^k} \left(\ln \ln x + \ln \ln \left(1 - \frac{k \ln d}{\ln x} \right) \right) + Ax \sum_{d \leq x^{\frac{1}{k}}} \frac{\omega(d) \mu(d)}{d^k} + O \left(\frac{x}{\ln x} \right) \\ &= (x \ln \ln x + Ax) \sum_{d=1}^{\infty} \frac{\omega(d) \mu(d)}{d^k} + O \left(x \sum_{d \leq x^{\frac{1}{k}}} \frac{\ln d}{d^k \ln x} \right) + O \left(\frac{x}{\ln x} \right) \\ &= Cx \ln \ln x + O(x). \end{aligned}$$

This proves Lemma 6.

3. PROOF OF THE THEOREM

In this section, we shall complete the proof of the Theorem. For convenience we define the characteristic function of k -power free numbers as follows:

$$u(n) = \begin{cases} 1, & \text{if } n \text{ is a } k\text{-power free number;} \\ 0, & \text{otherwise.} \end{cases}$$

From Lemma 3, Lemma 4, Lemma 5 and Lemma 6, we have

$$\begin{aligned} \sum_{\substack{n \leq x \\ n \in A}} \omega^2(n) &= \sum_{n \leq x} \omega^2(n) \sum_{d^k | n} \mu(d) = \sum_{d^k m \leq x} \omega^2(d^k m) \mu(d) \\ &= \sum_{d^k m \leq x} (\omega(d) + \omega(m) - \omega((d, m)))^2 \mu(d) \\ &= \sum_{d^k m \leq x} \omega^2(m) \mu(d) + \sum_{d^k m \leq x} \omega^2(d) \mu(d) + \sum_{d^k m \leq x} \omega^2((d, m)) \mu(d) \\ &\quad + 2 \left(\sum_{d^k m \leq x} \omega(d) \omega(m) \mu(d) \right) + O \left(\sum_{d^k m \leq x} \omega(d) \omega(m) \right) \\ &= \left(\frac{x(\ln \ln x)^2}{\zeta(k)} + O(x \ln \ln x) \right) + 2(Cx \ln \ln x + O(x)) + O(x \ln \ln x) \\ &= \frac{x(\ln \ln x)^2}{\zeta(k)} + O(x \ln \ln x). \end{aligned}$$

This completes the proof of the Theorem .

REFERENCES

1. F. Smarndache, *ONLY PROBLEMS, NOT SOLUTION!*, Xiquan Publishing House, Chicago, 1993, pp. 27.
2. G. H. Hardy and S. Ramanujan, *The normal number of prime factors of a number n*, Quart. J. Math. **48** (1917), 76-92.
3. Tom M. Apostol, *Introduction to Analytic Number Theory*, Springer-Verlag, New York, 1976.

ON THE k -POWER COMPLEMENT AND k -POWER FREE NUMBER SEQUENCE

ZHU WEIYI

College of Mathematics and Physics Science, Zhejiang Normal University
Jinhua, Zhejiang, P.R.China

ABSTRACT. The main purpose of this paper is to study the distribution properties of k -power free numbers and k -power complement numbers, and give an interesting asymptotic formula.

1. INTRODUCTION AND RESULTS

Let $k \geq 2$ is a positive integer, a natural number n is called a k -power free number if it can not be divided by any p^k , where p is a prime number. One can obtain all k -power free number by the following method: From the set of natural numbers (except 0 and 1)

-take off all multiples of 2^k (i.e. $2^k, 2^{k+1}, 2^{k+2} \dots$).

-take off all multiples of 3^k .

-take off all multiples of 5^k .

...and so on (take off all multiples of all k -power primes).

For instance, the k -power free number sequence is called cube free sieve if $k = 3$, this sequence is the following 2, 3, 4, 5, 6, 7, 9, 10, 11, 12, 13, 14, 15, 17, \dots

Let $n \geq 2$ is any integer, $a(n)$ is called a k -power complement about n if $a(n)$ is the smallest integer such that $n \times a(n)$ is a perfect k -power, for example $a(2) = 2^{k-1}$, $a(3) = 3^{k-1}$, $a(2^k) = 1, \dots$

In reference [1], Professor F. Smarandache asked us to study the properties of the k -power free number sequence and k -power complement number sequence. About these problems, it seems that none had studied them before. In this paper, we use the elementary method to study the distribution properties of these sequences, and obtain an interesting asymptotic formula. For convenience, we define $\Omega(n)$ and $\omega(n)$ as following: $\Omega(n) = \alpha_1 + \alpha_2 + \dots + \alpha_r$, $\omega(n) = r$, if $n = p_1^{\alpha_1} p_2^{\alpha_2} \dots p_r^{\alpha_r}$ be the factorization of n into prime powers. Then we have the following Theorem.

Key words and phrases. k -power free numbers; k -power complement numbers, Mean Value; Asymptotic formula.

Theorem. Let \mathcal{A} denotes the set of all k -power free numbers. Then for any real number $x \geq 2$, we have the asymptotic formula

$$\sum_{\substack{n \leq x \\ n \in \mathcal{A}}} \Omega(a(n)) = \frac{(k-1)x \ln \ln x}{\zeta(k)} + u(k)x + O\left(\frac{x}{\ln x}\right),$$

where $\zeta(s)$ is the Riemann zeta-function, $u(k)$ is a constant depending only on k .

2. SEVERAL LEMMAS

Lemma 1. For any real number $x \geq 2$, we have the asymptotic formula

$$\sum_{n \leq x} \omega(n) = x \ln \ln x + Ax + O\left(\frac{x}{\ln x}\right),$$

$$\sum_{n \leq x} \Omega(n) = x \ln \ln x + Bx + O\left(\frac{x}{\ln x}\right).$$

where $A = \gamma + \sum_p \left(\ln \left(1 - \frac{1}{p} \right) + \frac{1}{p} \right)$, $B = A + \sum_p \frac{1}{p(p-1)}$.

Proof. (See reference [2]).

Lemma 2. For any real number $x \geq 2$, we have the asymptotic formula

$$\sum_{\substack{n \leq x \\ n \in \mathcal{A}}} \omega(n) = \zeta^{-1}(k)x \ln \ln x + Ax\zeta^{-1}(k) + Cx + O\left(\frac{x}{\ln x}\right).$$

Proof. Let (u, v) denotes the greatest common divisor of u and v . Then from Lemma 1 we have

$$\begin{aligned} \sum_{\substack{n \leq x \\ n \in \mathcal{A}}} \omega(n) &= \sum_{n \leq x} \omega(n) \sum_{d^k | n} \mu(d) = \sum_{d^k n \leq x} \omega(nd^k) \mu(d) = \sum_{d \leq x^{\frac{1}{k}}} \mu(d) \sum_{n \leq x/d^k} \omega(nd^k) \\ &= \sum_{d \leq x^{\frac{1}{k}}} \mu(d) \left[\sum_{n \leq x/d^k} (\omega(n) + \omega(d) - \omega((n, d))) \right] \\ &= \sum_{d \leq x^{\frac{1}{k}}} \mu(d) \sum_{n \leq x/d^k} \omega(n) + \sum_{d \leq x^{\frac{1}{k}}} \mu(d) \omega(d) \left[\frac{x}{d^k} \right] - \sum_{d \leq x^{\frac{1}{k}}} \mu(d) \sum_{\substack{u|d \\ u|n}} \sum_{n \leq x/d^k} \omega(u) \\ &= \sum_{d \leq x^{\frac{1}{k}}} \mu(d) \left[\frac{x}{d^k} \ln \ln \frac{x}{d^k} + \frac{Ax}{d^k} + O\left(\min\left(1, \frac{x}{d^k \ln \frac{x}{d^k}} \right) \right) \right] \\ &\quad + x \sum_{d \leq x^{\frac{1}{k}}} \frac{\mu(d)\omega(d)}{d^k} + O\left(x^{\frac{1}{k}} \ln x\right) - \sum_{d \leq x^{\frac{1}{k}}} \mu(d) \sum_{u|d} \omega(u) \left[\frac{x}{ud^k} \right] \end{aligned}$$

$$\begin{aligned}
&= x \ln \ln x \sum_{d=1}^{\infty} \frac{\mu(d)}{d^k} + Ax \sum_{d=1}^{\infty} \frac{\mu(d)}{d^k} + x \sum_{d=1}^{\infty} \frac{\mu(d)\omega(d)}{d^k} - x \sum_{d=1}^{\infty} \frac{\mu(d) \sum_{u|d} \frac{\omega(u)}{u}}{d^k} + O\left(\frac{x}{\ln x}\right) \\
&= \zeta^{-1}(k)x \ln \ln x + Ax\zeta^{-1}(k) + Cx + O\left(\frac{x}{\ln x}\right).
\end{aligned}$$

where

$$C = \sum_{d=1}^{\infty} \frac{\mu(d)\omega(d)}{d^k} - \sum_{d=1}^{\infty} \frac{\mu(d) \sum_{u|d} \frac{\omega(u)}{u}}{d^k}.$$

This proves Lemma 2.

Lemma 3. For any real number $x \geq 2$, we have the asymptotic formula

$$\sum_{\substack{n \leq x \\ n \in \mathcal{A}}} \Omega(n) = \zeta^{-1}(k)x \ln \ln x + Bx\zeta^{-1}(k) + Dx + O\left(\frac{x}{\ln x}\right).$$

Proof. From Lemma 1, we have

$$\begin{aligned}
\sum_{\substack{n \leq x \\ n \in \mathcal{A}}} \Omega(n) &= \sum_{n \leq x} \Omega(n) \sum_{d^k | n} \mu(d) = \sum_{d^k n \leq x} \Omega(nd^k) \mu(d) = \sum_{d \leq x^{\frac{1}{k}}} \mu(d) \sum_{n \leq x/d^k} \Omega(nd^k) \\
&= \sum_{d \leq x^{\frac{1}{k}}} \mu(d) \left[\sum_{n \leq x/d^k} (\Omega(n) + k\Omega(d)) \right] \\
&= \sum_{d \leq x^{\frac{1}{k}}} \mu(d) \sum_{n \leq x/d^k} \Omega(n) + \sum_{d \leq x^{\frac{1}{k}}} \mu(d) k\Omega(d) \left[\frac{x}{d^k} \right] \\
&= \sum_{d \leq x^{\frac{1}{k}}} \mu(d) \left[\frac{x}{d^k} \ln \ln \frac{x}{d^k} + \frac{Bx}{d^k} + O\left(\min\left(1, \frac{x}{d^k \ln \frac{x}{d^k}}\right)\right) \right] \\
&\quad + kx \sum_{d \leq x^{\frac{1}{k}}} \frac{\mu(d)\Omega(d)}{d^k} + O\left(x^{\frac{1}{k}} \ln x\right) \\
&= x \ln \ln x \sum_{d=1}^{\infty} \frac{\mu(d)}{d^k} + Bx \sum_{d=1}^{\infty} \frac{\mu(d)}{d^k} + kx \sum_{d=1}^{\infty} \frac{\mu(d)\Omega(d)}{d^k} \\
&= \zeta^{-1}(k)x \ln \ln x + Bx\zeta^{-1}(k) + Dx + O\left(\frac{x}{\ln x}\right),
\end{aligned}$$

where

$$D = k \sum_{d=1}^{\infty} \frac{\mu(d)\Omega(d)}{d^k}.$$

This proves Lemma 3.

3. PROOF OF THE THEOREM

In this section, we shall complete the proof of the Theorem. According to the definition of k -power complement number and k -power free number, and applying Lemma 2, 3, we have

$$\sum_{\substack{n \leq x \\ n \in \mathcal{A}}} \Omega(n \times a(n)) = k \sum_{\substack{n \leq x \\ n \in \mathcal{A}}} \omega(n) = \sum_{\substack{n \leq x \\ n \in \mathcal{A}}} \Omega(n) + \sum_{\substack{n \leq x \\ n \in \mathcal{A}}} \Omega(a(n)).$$

or

$$\begin{aligned}
\sum_{\substack{n \leq x \\ n \in \mathcal{A}}} \Omega(a(n)) &= k \sum_{\substack{n \leq x \\ n \in \mathcal{A}}} \omega(n) - \sum_{\substack{n \leq x \\ n \in \mathcal{A}}} \Omega(n) \\
&= k \left[\zeta^{-1}(k)x \ln \ln x + Ax\zeta^{-1}(k) + Cx + O\left(\frac{x}{\ln x}\right) \right] \\
&\quad - \left[\zeta^{-1}(k)x \ln \ln x + Bx\zeta^{-1}(k) + Dx + O\left(\frac{x}{\ln x}\right) \right] \\
&= \frac{(k-1)x \ln \ln x}{\zeta(k)} + u(k)x + O\left(\frac{x}{\ln x}\right).
\end{aligned}$$

where

$$u(k) = \frac{kA - B}{\zeta(k)} + kC - D$$

This completes the proof of the Theorem .

REFERENCES

1. F. Smarndache, *ONLY PROBLEMS, NOT SOLUTION!*, Xiquan Publishing House, Chicago, 1993, pp. 26-27.
2. G. H. Hardy and S. Ramanujan, *The normal number of prime factors of a number n*, Quart. J. Math. **48** (1917), 76-92.
3. Tom M. Apostol, *Introduction to Analytic Number Theory*, Springer-Verlag, New York, 1976.

On the 80th Problem of F.Smarandache(I)

He Xiaolin Guo Jimbao

College of Mathematics and Computer Science, Yanan University, Shaanxi China 716000

Abstract Using analytic method, this paper studies the first power mean of $a(n)$ and its generation, and gives a mean value formula, where $a(n)$ is the sequence in problem 80 of "only problems not solutions" which was presented by professor F.Smarandache.

Keywords number-theoretic function; mean-value; asymptotic formula

In 1993, number-theoretic expert F.Smarandache presented 100 unsolved problems in [1], it arose great interests for scholars. Among them, the 80th problem is:

Square root: 0, 1, 1, 1, 2, 2, 2, 2, 2, 3, 3, 3, 3, 3, 3, 3, 4, 4, 4, 4, 4, 4, 4, 4, 5, 5, 5, 5, 5, 5, 5, 5, 6, 6, 6, 6, 6, 6, 6, 6, 7, 7, 7, 7, 7, 7, 7, 7, 7, 7, 7, 7, 7, 7, 8, 8, ...

Study this sequences.

We denote the sequence in problem 80 as $a(n)$, it is not difficult to show that $a(n) = [\sqrt{n}]$, where $[x]$ is the maximal integer that is no more than x .

1. Mean-value about $a(n)$

Theorem 1 Let n be a positive integer, and $a(n) = [\sqrt{n}]$, then

$$\sum_{n \leq x} a(n) = \sum_{n \leq x} [\sqrt{n}] = \frac{2}{3}x^{\frac{3}{2}} + \frac{3}{2}x + O(x^{\frac{1}{2}})$$

Proof For an arbitrary positive NUMBER x , there must exist a positive integer N , such that $N^2 \leq x < (N+1)^2$, so we have

$$\begin{aligned} \sum_{n \leq x} a(n) &= \sum_{n \leq x} [\sqrt{n}] \\ &= \sum_{1^2 \leq i < 2^2} [\sqrt{i}] + \sum_{2^2 \leq i < 3^2} [\sqrt{i}] + \cdots + \sum_{N^2 \leq i \leq x < (N+1)^2} [\sqrt{i}] + O(N) \\ &= 3 \cdot 1 + 5 \cdot 1 + \cdots + [(N+1)^2 - N^2] \cdot N + O(N) \\ &= \sum_{j \leq N} (2j+1)j + O(N) \\ &= 2 \sum_{j \leq N} j^2 + \sum_{j \leq N} j + O(N) \\ &= 2 \cdot \frac{1}{6}N(N+1)(2N+1) + \frac{1}{2}N(N+1) + O(N) \\ &= \frac{2}{3}N^3 + \frac{3}{2}N^2 + O(N) \\ &= \frac{2}{3}x^{\frac{3}{2}} + \frac{3}{2}x + O(x^{\frac{1}{2}}) \end{aligned}$$

2. Generalized mean-value about $a(n)$

Theorem 2 Let n be a positive integer, and $a(n) = [n^{\frac{1}{3}}]$, then

$$\sum_{n \leq x} a(n) = \sum_{n \leq x} [n^{\frac{1}{3}}] = \frac{3}{4}x^{\frac{4}{3}} + \frac{5}{2}x + \frac{11}{4}x^{\frac{2}{3}} + O(x^{\frac{1}{3}})$$

Proof

$$\begin{aligned} \sum_{n \leq x} a(n) &= \sum_{n \leq x} [n^{\frac{1}{3}}] \\ &= \sum_{1^3 \leq i < 2^3} [i^{\frac{1}{3}}] + \sum_{2^3 \leq i < 3^3} [i^{\frac{1}{3}}] + \cdots + \sum_{N^3 \leq i \leq x < (N+1)^3} [i^{\frac{1}{3}}] + O(N) \\ &= 7 \cdot 1 + 19 \cdot 2 + \cdots + [(N+1)^3 - N^3] \cdot N + O(N) \\ &= \sum_{j \leq N} [(j+1)^3 - j^3] + O(N) \\ &= 3 \sum_{j \leq N} j^3 + 3 \sum_{j \leq N} j^2 + \sum_{j \leq N} j + O(N) \\ &= 3 \left[\frac{1}{2} N(N+1) \right]^2 + 3 \cdot \frac{1}{6} N(N+1)(2N+1) + \frac{1}{2} N(N+1) + O(N) \\ &= \frac{3}{4} N^4 + \frac{5}{2} N^3 + \frac{11}{4} N^2 + O(N) \\ &= \frac{3}{4} x^{\frac{4}{3}} + \frac{5}{2} x + \frac{11}{4} x^{\frac{2}{3}} + O(x^{\frac{1}{3}}) \end{aligned}$$

Generally, we have the following

Theorem 3 Let n be a positive integer, and $a(n) = [n^{\frac{1}{k}}]$, then

$$\sum_{n \leq x} a(n) = \sum_{n \leq x} [n^{\frac{1}{k}}] = \frac{k}{k+1} x^{\frac{k+1}{k}} + O(x)$$

Proof

$$\begin{aligned} \sum_{n \leq x} a(n) &= \sum_{n \leq x} [n^{\frac{1}{k}}] \\ &= \sum_{1^k \leq i < 2^k} [i^{\frac{1}{k}}] + \sum_{2^k \leq i < 3^k} [i^{\frac{1}{k}}] + \cdots + \sum_{N^k \leq i \leq x < (N+1)^k} [i^{\frac{1}{k}}] + O(N) \\ &= \sum_{j \leq N} [(j+1)^k - j^k] + O(N) \\ &= \sum_{j \leq N} \binom{k}{1} j^k + \sum_{j \leq N} \binom{k}{2} j^{j-k} + \cdots + \sum_{j \leq N} \binom{k}{k} j + O(N) \end{aligned}$$

$$\begin{aligned}
&= \sum_{j \leq N} \sum_{l=1}^k \binom{k}{l} j^{k-l+1} + O(N) \\
&= k \cdot \frac{N^{k+1}}{N+1} + O(N^k) + O(N) \\
&= \frac{k}{k+1} x^{\frac{k+1}{k}} + O(x)
\end{aligned}$$

If we generaliz it from other view ,we can also have

Theorem 4 Let n be a positive integer, and $b(n) = (a(n))^2 = [\sqrt{n}]^2$, then

$$\sum_{n \leq x} b(n) = \sum_{n \leq x} [\sqrt{n}]^2 = \frac{1}{2}x^2 + \frac{4}{3}x^{\frac{3}{2}} + O(x)$$

Proof
$$\sum_{n \leq x} b(n) = \sum_{n \leq x} [\sqrt{n}]^2$$

$$\begin{aligned}
&= \sum_{1^2 \leq i < 2^2} [\sqrt{i}]^2 + \sum_{2^2 \leq i < 3^2} [\sqrt{i}]^2 + \cdots + \sum_{N^2 \leq i \leq x < (N+1)^2} [\sqrt{i}]^2 + O(N^2) \\
&= 3 \cdot 1 + 5 \cdot 4 + \cdots + [(N+1)^2 - N^2]N^2 + O(N^2) \\
&= \sum_{j \leq N} [(j+1)^2 - j^2]j^2 + O(N^2) \\
&= 2 \sum_{j \leq N} j^3 + \sum_{j \leq N} j^2 + O(N^2) \\
&= 2 \cdot \left[\frac{1}{2}N(N+1) \right]^2 + \frac{1}{6}[N(N+1)(2N+1)] + O(N^2) \\
&= \frac{1}{2}N^4 + \frac{4}{3}N^3 + O(N^2) \\
&= \frac{1}{2}x^2 + \frac{4}{3}x^{\frac{3}{2}} + O(x)
\end{aligned}$$

Theorem 5 Let n be a positive integer, and $b(n) = (a(n))^3 = [\sqrt{n}]^3$, then

$$\sum_{n \leq x} b(n) = \sum_{n \leq x} [\sqrt{n}]^3 = \frac{2}{5}x^{\frac{5}{2}} + \frac{5}{4}x^2 + O(x^{\frac{3}{2}})$$

Proof
$$\sum_{n \leq x} b(n) = \sum_{n \leq x} [\sqrt{n}]^3$$

$$\begin{aligned}
&= \sum_{1^2 \leq i < 2^2} [\sqrt{i}]^3 + \sum_{2^2 \leq i < 3^2} [\sqrt{i}]^3 + \cdots + \sum_{N^2 \leq i \leq x < (N+1)^2} [\sqrt{i}]^3 + O(N^3) \\
&= 3 \cdot 1 + 5 \cdot 8 + \cdots + [(N+1)^2 - N^2]N^3 + O(N^3) \\
&= \sum_{j \leq N} [(j+1)^2 - j^2]j^3 + O(N^3) \\
&= 2 \sum_{j \leq N} j^4 + \sum_{j \leq N} j^3 + O(N^3)
\end{aligned}$$

$$\begin{aligned}
&= 2 \cdot \frac{1}{30} N(N+1)(2N+1)(3N^2+3N-1) + \left[\frac{1}{2}[N(N+1)]^2 + O(N^3)\right] \\
&= \frac{2}{5} N^5 + \frac{5}{4} N^4 + O(N^3) \\
&= \frac{2}{5} x^{\frac{5}{2}} + \frac{5}{4} x^2 + O(x^{\frac{3}{2}})
\end{aligned}$$

Theorem 6 Let n be a positive integer, and $b(n) = (a(n))^k = [\sqrt{n}]^k$, then

$$\sum_{n \leq x} b(n) = \sum_{n \leq x} [\sqrt{n}]^k = \frac{2}{k+2} x^{\frac{k+2}{2}} + O(x^{\frac{k+1}{2}})$$

Proof
$$\sum_{n \leq x} b(n) = \sum_{n \leq x} [\sqrt{n}]^k$$

$$\begin{aligned}
&= \sum_{1^2 \leq i < 2^2} [\sqrt{i}]^k + \sum_{2^2 \leq i < 3^2} [\sqrt{i}]^k + \cdots + \sum_{N^2 \leq i \leq x < (N+1)^2} [\sqrt{i}]^k + O(N^k) \\
&= 3 \cdot 1^k + 5 \cdot 2^k + \cdots + [(N+1)^2 - N^2] N^k + O(N^k) \\
&= \sum_{j \leq N} [(j+1)^2 - j^2] j^k + O(N^k) \\
&= 2 \sum_{j \leq N} j^{k+1} + \sum_{j \leq N} j^k + O(N^k) \\
&= 2 \cdot \frac{N^{k+2}}{k+2} + O(N^{k+1}) \\
&= \frac{2}{k+2} x^{\frac{k+2}{2}} + O(x^{\frac{k+1}{2}})
\end{aligned}$$

References

- [1] F. Smarandache, Only problems not solutions. Chicago: Xiquan Publishing House, 1993, 74.

On the 80th Problem of F.Smarandache(II)

He Xiaolin Guo Jinbao

College of Mathematics and Computer Science, Yanan University, Shaanxi China 716000

Abstract The main purpose of this paper is to study the first power mean of $d(a(n))$; $\varphi(a(n))$ and their generations, and a series of regular results is obtained, where $\varphi(n)$ is Euler totient function, $d(n)$ is divisor function and $a(n)$ is the sequence in problem 80 of "only problems not solutions" which was presented by professor F.Smarandache.

Keywords number-theoretic function; mean-value; asymptotic formula

In 1993, professor F.Smarandache presented 100 unsolved problems in [1], it aroused great interests for scholars. Among them, the 80th problem is:

Square root: 0, 1, 1, 1, 2, 2, 2, 2, 2, 3, 3, 3, 3, 3, 3, 3, 4, 4, 4, 4, 4, 4, 4, 5, 5, 5, 5, 5, 5, 5, 5, 6, 6, 6, 6, 6, 6, 6, 6, 6, 7, 7, 7, 7, 7, 7, 7, 7, 7, 7, 7, 7, 7, 7, 8, 8, ...

Study this sequences.

We denote the sequence in problem 80 as $a(n)$, it is not difficult to show that $a(n) = [\sqrt{n}]$, where $[x]$ is the maximal integer that is no more than x .

1. Mean-value of $d(a(n))$ and its generalization

Theorem 1 Let n be a positive integer, and $a(n) = [\sqrt{n}]$, $d(n)$ be divisor function, then

$$\sum_{n \leq x} d(a(n)) = \sum_{n \leq x} d([\sqrt{n}]) = \frac{1}{2}x \log x + \left(2c - \frac{1}{2}\right)x + O(x^{\frac{3}{4}})$$

Where c is Euler's constant.

Proof
$$\sum_{n \leq x} d(a(n)) = \sum_{n \leq x} d([\sqrt{n}])$$

$$\begin{aligned} &= \sum_{1^2 \leq i < 2^2} d([\sqrt{i}]) + \sum_{2^2 \leq i < 3^2} d([\sqrt{i}]) + \dots + \sum_{N^2 \leq i \leq (N+1)^2} d([\sqrt{i}]) + O(N^\epsilon) \\ &= 3 \cdot d(1) + 5 \cdot d(2) + \dots + [(N+1)^2 - N^2]d(N) + O(N^\epsilon) \\ &= \sum_{j \leq N} (2j+1)d(j) + O(N^\epsilon) \end{aligned}$$

Let $A(N) = \sum_{j \leq N} d(j) = N \log N + (2c-1)N + O(N^{\frac{1}{2}})^{[2]}$, $f(j) = 2j+1$, by Abel's identity^[2], we have

$$\begin{aligned} \sum_{j \leq N} (2j+1)d(j) &= A(N)f(N) - A(1)f(1) - \int_1^N A(t)f'(t)dt \\ &= [N \log N + (2c-1)N + O(N^{\frac{1}{2}})](2N+1) - A(1)f(1) - \int_1^N [t \log t - (2c-1)t + O(N^{\frac{1}{2}})] \cdot 2dt \end{aligned}$$

$$\begin{aligned}
&= 2N^2 \log N + 2(2c-1)N^2 + O(N^{\frac{3}{2}}) - 2 \int_1^N t \log t dt - 2 \int_1^N (2c-1)t dt - 2 \int_1^N O(t^{\frac{1}{2}}) dt \\
&= 2N^2 \log N - 2(2c-1)N^2 + O(N^{\frac{3}{2}}) - N^2 \log N^2 + \frac{1}{2}N^2 - 2(2c-1)N^2 + O(N^{\frac{3}{2}}) \\
&= N^2 \log N + \left(2c - \frac{1}{2}\right) N^2 + O(N^{\frac{3}{2}})
\end{aligned}$$

So

$$\begin{aligned}
\sum_{j \leq N} d(a(n)) &= \sum_{j \leq N} (2j+1)d(j) + O(N^\epsilon) \\
&= N^2 \log N + \left(2c - \frac{1}{2}\right) N^2 + O(N^{\frac{3}{2}}) + O(N^\epsilon) \\
&= \frac{1}{2}x \log x + \left(2c - \frac{1}{2}\right) x + O(x^{\frac{3}{4}})
\end{aligned}$$

Similarly, we have

Theorem 2 Let n be a positive integer, and $a(n) = [n^{\frac{1}{3}}]$, $d(n)$ be divisor function, then

$$\sum_{n \leq x} d(a(n)) = \sum_{n \leq x} d([n^{\frac{1}{3}}]) = \frac{1}{3}x \log x + \left(2c - \frac{1}{3}\right) x + O(x^{\frac{5}{6}})$$

Where c is Euler's constant.

Proof
$$\sum_{n \leq x} d(a(n)) = \sum_{n \leq x} d([n^{\frac{1}{3}}])$$

$$\begin{aligned}
&= \sum_{1^3 \leq i < 2^3} d([i^{\frac{1}{3}}]) + \sum_{2^3 \leq i < 3^3} d([i^{\frac{1}{3}}]) + \cdots + \sum_{N^3 \leq i \leq x < (N+1)^3} d([i^{\frac{1}{3}}]) + O(N^\epsilon) \\
&= 7 \cdot d(1) + 19 \cdot d(2) + \cdots + [(N+1)^3 - N^3]d(N) + O(N^\epsilon) \\
&= \sum_{j \leq N} (3j^2 + 3j + 1)d(j) + O(N^\epsilon)
\end{aligned}$$

Let $A(N) = \sum_{j \leq N} d(j) = N \log N + (2c-1)N + O(N^{\frac{1}{2}})^{[2]}$, $f(j) = 3j^2 + 3j + 1$, simi-

larly, we have

$$\begin{aligned}
\sum_{j \leq N} (3j^2 + 3j + 1)d(j) &= A(N)f(N) - A(1)f(1) - \int_1^N A(t)f'(t)dt \\
&= [N \log N + (2c-1)N + O(N^{\frac{1}{2}})](3N^2 + 3N + 1) - \int_1^N [t \log t - (2c-1)t + O(t^{\frac{1}{2}})](6t+3)dt \\
&= 3N^3 \log N + 3(2c-1)N^3 + O(N^{\frac{5}{2}}) + 3N^2 \log N + 3(2c-1)N^2 + N \log N + (2c-1)N \\
&\quad - 7(2c-1)N - \int_1^N 6t^2 \log t dt - \int_1^N 6(2c-1)t^2 dt + O\left(\int_1^N 6t^{\frac{3}{2}} dt\right) - \int_1^N 3t \log t dt - \int_1^N 3(2c-1)t dt
\end{aligned}$$

Because

$$\int_1^N 6t^2 \log t dt = 2N^3 \log N - \frac{2}{3}N^3 + c_1,$$

$$\int_1^N 6(2c-1)t^2 dt = 2(2c-1)N^3 + c_2,$$

$$\int_1^N 3t \log t dt = \frac{3}{2}N^2 \log N - \frac{3}{4}N^2 + c_3,$$

So

$$\begin{aligned} \sum_{j \leq N} (3j^2 + 3j + 1)d(j) &= 3N^3 \log N + 3(2c-1)N^3 - 2N^3 \log N + \frac{2}{3}N^3 - 2(2c-1)N^3 + O(N^{\frac{5}{2}}) \\ &= N^3 \log N + \left(2c - \frac{1}{3}\right)N^3 + O(N^{\frac{5}{2}}) \end{aligned}$$

As a result, we have

$$\begin{aligned} \sum_{j \leq N} d(a(n)) &= \sum_{j \leq N} d(\lfloor n^{\frac{1}{3}} \rfloor) \\ &= \sum_{j \leq N} (3j^2 + 3j + 1)d(j) + O(N^\epsilon) \\ &= N^3 \log N + \left(2c - \frac{1}{3}\right)N^3 + O(N^{\frac{5}{2}}) + O(N^\epsilon) \\ &= \frac{1}{3}x \log x + \left(2c - \frac{1}{3}\right)x + O(x^{\frac{5}{6}}) \end{aligned}$$

Theorem 3 Let n be a positive integer, and $a(n) = \lfloor n^{\frac{1}{k}} \rfloor$, $d(n)$ be divisor function, then

$$\sum_{n \leq x} d(a(n)) = \sum_{n \leq x} d(\lfloor n^{\frac{1}{k}} \rfloor) = \frac{1}{k}x \log x + O(x)$$

Proof $\sum_{n \leq x} d(a(n)) = \sum_{n \leq x} d(\lfloor n^{\frac{1}{k}} \rfloor)$

$$\begin{aligned} &= \sum_{1^k \leq i < 2^k} d(\lfloor i^{\frac{1}{k}} \rfloor) + \sum_{2^k \leq i < 3^k} d(\lfloor i^{\frac{1}{k}} \rfloor) + \cdots + \sum_{N^k \leq i \leq x < (N+1)^k} d(\lfloor i^{\frac{1}{k}} \rfloor) + O(N^\epsilon) \\ &= (2^k - 1)d(1) + (3^k - 2^k)d(2) + \cdots + [(N+1)^k - N^k]d(N) + O(N^\epsilon) \\ &= \sum_{j \leq N} [(j+1)^k - j^k]d(j) + O(N^\epsilon) \end{aligned}$$

Let $A(N) = \sum_{j \leq N} d(j) = N \log N + (2c-1)N + O(N^{\frac{1}{2}})^{[2]}$, $f(j) = [(j+1)^k - j^k]$, then

$$\begin{aligned} \sum_{j \leq N} [(j+1)^k - j^k]d(j) &= A(N)f(N) - A(1)f(1) - \int_1^N A(t)f'(t)dt \\ &= [N \log N + (2c-1)N + O(N^{\frac{1}{2}})][(N+1)^k - N^k] - A(1)f(1) \end{aligned}$$

$$\begin{aligned}
& - \int_1^N [t \log t + (2c-1)t + O(t^{\frac{1}{2}})](k(t+1)^{k-1} - kt^{k-1}) dt \\
& = [N \log N + (2c-1)N + O(N^{\frac{1}{2}})] \left(\sum_{l=1}^k \binom{k}{l} N^{k-l} \right) \\
& - k \int_1^N [t \log t - 2(2c-1)t + O(t^{\frac{1}{2}})] \left(\sum_{l=1}^{k-1} \binom{k-1}{l} t^{k-l-1} \right) dt \\
& = \binom{k}{1} N^k \log N - \binom{k-1}{1} \int_1^N kt^{k-1} \log k dt + O(N^k) \\
& = \binom{k}{1} N^k \log N - \binom{k-1}{1} N^k \log N + O(N^k) \\
& = N^k \log N + O(N^k)
\end{aligned}$$

So

$$\begin{aligned}
\sum_{n \leq x} d(a(n)) & = \sum_{n \leq x} d([n^{\frac{1}{k}}]) \\
& = \sum_{j \leq N} [(j+1)^k - j^k] d(j) + O(N^\epsilon) \\
& = N^k \log N + O(N^k) + O(N^\epsilon) \\
& = \frac{1}{k} x \log x + O(x)
\end{aligned}$$

2. Mean-value of $\varphi(a(n))$ and it's generalization

Theorem 4 Let n be a positive integer, and $a(n) = [\sqrt{n}]$, $\varphi(n)$ be Euler totient function, then

$$\sum_{n \leq x} \varphi(a(n)) = \sum_{n \leq x} \varphi([\sqrt{n}]) = \frac{4}{\pi^2} x^{\frac{3}{2}} + O(x \log x)$$

Proof
$$\sum_{n \leq x} \varphi(a(n)) = \sum_{n \leq x} \varphi([\sqrt{n}])$$

$$\begin{aligned}
& = \sum_{1^2 \leq i < 2^2} \varphi([\sqrt{i}]) + \sum_{2^2 \leq i < 3^2} \varphi([\sqrt{i}]) + \cdots + \sum_{N^2 \leq i \leq x < (N+1)^2} \varphi([\sqrt{i}]) + O(N) \\
& = 3\varphi(1) + 5\varphi(2) + \cdots + [(N+1)^2 - N^2]\varphi(N) + O(N) \\
& = \sum_{j \leq N} (2j+1)\varphi(j) + O(N)
\end{aligned}$$

Let $A(N) = \sum_{j \leq N} \varphi(j) = \frac{3}{\pi^2} N^2 + O(N \log N)^{[2]}$, $f(j) = 2j + 1$, then

$$\begin{aligned} \sum_{j \leq N} (2j + 1)\varphi(j) &= A(N)f(N) - A(1)f(1) - \int_1^N A(t)f'(t)dt \\ &= \left[\frac{3}{\pi^2} N^2 + O(N \log N) \right] (2N + 1) - \int_1^N \left[\frac{3}{\pi^2} t^2 + O(t \log t) \right] 2dt \\ &= \frac{6}{\pi^2} N^3 + O(N^2 \log N) - \frac{2}{\pi^2} N^3 + O(N^2 \log N) \\ &= \frac{4}{\pi^2} N^3 + O(N^2 \log N) \end{aligned}$$

Then

$$\begin{aligned} \sum_{n \leq x} \varphi([\sqrt{n}]) &= \sum_{j \leq N} (2j + 1)\varphi(j) + O(N) \\ &= \frac{4}{\pi^2} N^3 + O(N^2 \log N) + O(N) \\ &= \frac{4}{\pi^2} x^{\frac{3}{2}} + O(x \log x) \end{aligned}$$

Similarly, we have

Theorem 5 Let n be a positive integer, and $a(n) = [n^{\frac{1}{3}}]$, $\varphi(n)$ be Euler totient function, then

$$\sum_{n \leq x} \varphi(a(n)) = \sum_{n \leq x} \varphi([n^{\frac{1}{3}}]) = \frac{9}{2\pi^2} x^{\frac{4}{3}} + O(x \log x)$$

Proof $\sum_{n \leq x} \varphi(a(n)) = \sum_{n \leq x} \varphi([n^{\frac{1}{3}}])$

$$\begin{aligned} &= \sum_{1^3 \leq i < 2^3} \varphi([i^{\frac{1}{3}}]) + \sum_{2^3 \leq i < 3^3} \varphi([i^{\frac{1}{3}}]) + \cdots + \sum_{N^3 \leq i \leq x < (N+1)^3} \varphi([i^{\frac{1}{3}}]) + O(N) \\ &= 7\varphi(1) + 9\varphi(2) + \cdots + [(N+1)^3 - N^3]\varphi(N) + O(N) \\ &= \sum_{j \leq N} (3j^2 + 3j + 1)\varphi(j) + O(N) \end{aligned}$$

Let $A(N) = \sum_{j \leq N} \varphi(N) = \frac{3}{\pi^2} N^2 + O(N \log N)^{[2]}$, $f(j) = 3j^2 + 3j + 1$, then

$$\begin{aligned} \sum_{j \leq N} (3j^2 + 3j + 1)\varphi(j) &= A(N)f(N) - A(1)f(1) - \int_1^N A(t)f'(t)dt \\ &= \left[\frac{3}{\pi^2} N^2 + O(N \log N) \right] (3N^2 + 3N + 1) - \int_1^N \left[\frac{3}{\pi^2} t^2 + O(t \log t) \right] (6t + 3)dt \\ &= \frac{9}{\pi^2} N^4 - \frac{9}{2\pi^2} N^4 + O(N^3 \log N) \end{aligned}$$

So

$$\begin{aligned}\sum_{n \leq x} \varphi([i^{\frac{1}{3}}]) &= \sum_{j \leq N} (3j^2 + 3j + 1)\varphi(j) + O(N) \\ &= \frac{9}{2\pi^2} N^4 + O(N^3 \log N) + O(N) \\ &= \frac{9}{2\pi^2} x^{\frac{4}{3}} + O(x \log x)\end{aligned}$$

Theorem 6 Let n be a positive integer, and $a(n) = [n^{\frac{1}{k}}]$, $\varphi(n)$ be Euler totient function, then

$$\sum_{n \leq x} \varphi(a(n)) = \sum_{n \leq x} \varphi([n^{\frac{1}{k}}]) = \frac{6k}{(k+1)\pi^2} x^{\frac{k+1}{k}} + O(x \log x)$$

Proof

$$\begin{aligned}\sum_{n \leq x} \varphi(a(n)) &= \sum_{n \leq x} \varphi([n^{\frac{1}{k}}]) \\ &= \sum_{1^k \leq i < 2^k} \varphi([i^{\frac{1}{k}}]) + \sum_{2^k \leq i < 3^k} \varphi([i^{\frac{1}{k}}]) + \cdots + \sum_{N^k \leq i \leq x < (N+1)^k} \varphi([i^{\frac{1}{k}}]) + O(N) \\ &= \sum_{j \leq N} [(j+1)^k - j^k] \varphi(j) + O(N)\end{aligned}$$

Let $A(N) = \sum_{j \leq N} \varphi(j) = \frac{3}{\pi^2} N^2 + O(N \log N)^{[2]}$, $f(j) = [(j+1)^k - j^k]$, then

$$\begin{aligned}\sum_{j \leq N} [(j+1)^k - j^k] \varphi(j) &= A(N)f(N) - A(1)f(1) - \int_1^N A(t)f'(t) dt \\ &= \left[\frac{3}{\pi^2} N^2 + O(N \log N) \right] [(N+1)^k - N^k] - \int_1^k \left[\frac{3}{\pi^2} t^2 + O(t \log t) \right] k[(t+1)^{k-1} - t^{k-1}] dt \\ &= \frac{3k}{\pi^2} N^{k+1} + O(N^k \log N) - \frac{k(k-1)}{k+1} \frac{3}{\pi^2} N^{k+1} \\ &= \frac{6k}{(k+1)\pi^2} N^{k+1} + O(N^k \log N)\end{aligned}$$

So

$$\begin{aligned}\sum_{n \leq x} \varphi(a(n)) &= \sum_{n \leq x} \varphi([n^{\frac{1}{k}}]) \\ &= \sum_{j \leq N} [(j+1)^k - j^k] \varphi(j) + O(N) \\ &= \frac{6k}{(k+1)\pi^2} N^{k+1} + O(N^k \log N) + O(N) \\ &= \frac{6k}{(k+1)\pi^2} x^{\frac{k+1}{k}} + O(x \log x)\end{aligned}$$

References

- [1] F.Smarandache, Only problems not solutions. Chicago: Xiquan Publishing House, 1993, 74.
- [2] T.M.Apostol, Introduction to analytic number theory. New York: Springer-Verlag, 1976.

Smarandache Concatenated Magic Squares

Muneer Jebreel Karama
ssmathhebron@yahoo.com

SS-Math-Hebron / UNRWA / Field Education Officer /
Box 19149 / Jerusalem / Israel.

Abstract:

In this article, I present the results of investigation of Smarandache Concatenate Magic Squares formed from the magic squares, and report some conjectures.

Key words:

Magic Square, Smarandache Concatenate Magic Squares, Smarandache Prime - Concatenate Magic Squares.

1) Introduction:

A magic square consists of the distinct positive integers , 1 ,2 ,..., n , such that the sum of the n numbers in any horizontal , vertical , or main diagonal line is always the same constant, for more details see [1],[2],and [3].

2) Smarandache Concatenated Magic Squares (SCMS):

SCMS is formed from concatenation of numbers in magic squares such that the sum of the n numbers in any horizontal, vertical, line is always the same constant, but not necessary main diagonal the same constant.

3) Examples:

Consider the following magic square (4x4), figure .1

14	24	25	11
19	17	16	22
15	21	20	18
26	12	13	23

Figure .1

Then we can formed many *Smarandache Concatenated Magic Squares*,

such as in figure.2 (concatenation the numbers in magic squares horizontally)

1424	2425	2511	1114
1917	1716	1622	2219
1521	2120	2018	1815
2612	1213	1323	2326

Figure .2

Or as in figure.3 (concatenation the numbers in magic squares vertically)

1419	2417	2516	1122
1915	1721	1620	2218
1526	2112	2013	1823
2614	1224	1325	2311

Figure .3

or many concatenation digits such as in figure .4,5 and 6 .

142425	242511	251114	111424
191716	171622	162219	221917
152120	212018	201815	181521
261213	121323	132326	232612

Figure .4

14242511	24251114	25111424	11142425
19171622	17162219	16221917	22191716
15212018	21201815	20181521	18152120
26121323	12132326	13232612	23261213

Figure .5

1424251114	2425111424	2511142425	1114242511
1917162219	1716221917	1622191716	2219171622
1521201815	2120181521	2018152120	1815212018
2612132326	1213232612	1323261213	2326121323

Figure .6

4) Conjectures:

- 1) There are infinitely many *Smarandache Concatenated Magic Squares* formed from one magic square.
- 2) The sum of the n numbers in any horizontal, vertical, line is always the same constant , and follow concatenated pattern, for example the concatenate pattern in figures 1,2,3,4,5 and 6 , follow concatenate pattern which is : 74, 7474,747474 ,74747474,7474747474 ..., and so on .

5) Smarandache Prime - Concatenate Magic Squares: is formed from concatenation of only primes numbers in magic squares [see , JRM,30:1,p297] such that the sum of the n numbers in any horizontal, vertical, line is always the same constant, but not necessary main diagonal the same constant.

Example : this example found in [JRM,30:1,p297]

101	029	083
053	071	089
059	113	041

Figure .7

Then we can form the following Smarandache Prime - Concatenate Magic Squares , Figure.8 and 9 .

101029	029083	083101
053071	071089	089053
059113	113041	041059

Figure .8

101029083	029083101	083101029
053071089	071089053	089053071
059113041	113041059	041059113

Figure .9

The sum of the n numbers in any horizontal, vertical, line is always the same constant , and follow concatenated pattern, for example the concatenate pattern in figures 7,8, and 9 , follow concatenate pattern which is : 213, 213213,213213213 ..., and so on .

6) Conjectures:

There are infinitely many *Smarandache Prime - Concatenated Magic Squares* formed from only prime's magic squares.

7) Open Question:

- 1) Are there *Smarandache Prime - Back Concatenated Magic Squares*?
- 2) Are there *Smarandache Back Concatenated Magic Squares*?

References:

- 1) <http://www.Magic-squares.de>.
- 2) <http://www.mathworld.wolfram.com>
- 3) <http://www.mathforum.org>
- 4) Ashbacher.C, Smarandache Magic (problem number 2466), *Journal of Recreational Mathematics*, 30:1, p.297, 2002.

PROOF OF FUNCTIONAL SMARANDACHE ITERATIONS

ZHENG JIANFENG

Shaanxi Financi & Economics Professional College
Xianyang, Shaanxi, P. R. China

ABSTRACT: The paper makes use of method of Mathematics Analytic to prove Functional Smarandache Iterations of three kinds.

1. Proving Functional Smarandache Iterations of First Kind.

Kind 1.

Let $f: A \rightarrow A$ be a function, such that $f(x) \leq x$ for all x , and $\min\{f(x), x \in A\} \geq m_0$, different from negative infinity.

Let f have $p \geq 1$ fix points: $m_0 \leq x_1 < x_2 < \dots < x_p$. [The point x is called fix, if $f(x) = x$.].

Then:

$SII(x) =$ the smallest number of iterations k such that

$$\underbrace{f(f(\dots f(x)\dots))}_{\text{iterated } k \text{ times}} = \text{constant.}$$

Proof: I. When $A \subseteq \mathbb{Q}$ or $A \subseteq \mathbb{R}$, conclusion is false.

Counterexample:

Let $A = [0, 1]$ with $f(x) = x^2$, then $f(x) \leq x$, and $x_1 = 0$, $x_2 = 1$ are fix points.

Denote: $A_n(x) = \underbrace{f(f(\dots f(x)\dots))}_{n \text{ times}}$, $A_1(x) = f(x)$, ($n=1, 2, \dots$).

then $A_n(x) = x^{2^n}$ ($n=1, 2, \dots$).

For any fixed $x \neq 0$, $x \neq 1$, assumed that the smallest positive integer k exist, such that $A_n(x) = a$ (constant), hence, $A_{k+1}(x) = f(A_k(x)) = f(a) = a$, that is to say a be fix point.

So $x^{2^{k+1}} = 0$ or 1 , $\Rightarrow x = 0$ or 1 , this appear contradiction. If $A \subseteq \mathbb{Z}$, let A be set of all rational number on $[0, 1]$ with $f(x) = x^2$, using the same methods we can also deduce contradictory result.

This shows the conclusion is false where $A \subseteq \mathbb{Q}$ or $A \subseteq \mathbb{R}$.

II. when $A \subseteq \mathbb{Z}$, the conclusion is true.

(1). If $x = x_i$ (x_i is fix point, $i=1, \dots, p$). Then $f(x) = f(x_i) = x_i = A_1(x)$. So for any positive integer n , $A_n(x) = x_i$ ($i=1, \dots, p$), $\Rightarrow SII(x) = 1$.

Keywords and phrases. Functional iterations; fix point; limit.

(2). Let $x \neq x_i$ (x is fixed, $i=1, \dots, p$), if $f(x) = x_i$ ($i=1, \dots, p$), then $SI1(x)=1$, if $f(x) \neq x_i$ but $f(f(x)) = A_2(x) = x_i$ ($i=1, \dots, p$), then $SI1(x)=2$. In general, for fixed positive integer k , if $A_1(x) \neq x_i, A_2(x) \neq x_i \dots A_{k-1}(x) \neq x_i$, but $A_k(x) = x_i$ then $SI1(x)=k$.

(3). Let $x \neq x_i$ (x is fixed), and for $\forall n \in \mathbb{N} A_n(x) \neq x_i$ ($i=1, \dots, p$), this case is no exist.

Because x is fix point, $m_0 < \dots < A_n(x) < \dots < A_2(x) < A_1(x) < x$. So sequence $\{A_n(x)\}$ is descending and exist boundary, this makes know that $\{A_n(x)\}$ is convergent. But, each item of $\{A_n(x)\}$ is integer, it is not convergent, this appear contradiction. This shows that the case is no exist.

(4). Let $x \neq x_i$ (x is fixed, $i=1, \dots, p$), if exist the smallest positive integer k such that $A_k(x) = a$ ($a \neq x_i$), it is yet unable. Because $A_{k+1}(x) = A_k(x) = a$, $A_{k+1}(x) = f(A_k(x)) = f(a) = a$, this shows that a is fix point, namely, $a = x_i$, this also appear contradiction.

Combining (1), (2), (3) and (4) we have

$SI1(x)$ = the smallest number of iterations k such that

$$\underbrace{f(f(\dots f(x)\dots))}_{\text{iterated } k \text{ times}} = x_i \quad (x_i \text{ is fix point, } i=1, \dots, p).$$

This proves Kind 1.

We easily give a simple deduction.

Let $f: A \rightarrow A$ be a function, such that $f(x) \leq x$ for all x , and $\min\{f(x), x \in A\} \geq m_0$, different from negative infinity.

Let $f(m_0) = m_0$, namely, m_0 is fix point, and only one.

Then: $SI1(x)$ = the smallest number of iterations k such that

$$\underbrace{f(f(\dots f(x)\dots))}_{\text{iterated } k \text{ times}} = m_0.$$

2. Proving Functional Smarandache Iterations of Second Kind.

Kind 2.

Let $g: A \rightarrow A$ be a function, such that $g(x) > x$ for all x , and let $b > x$.

Then:

$SI2(x, b)$ = the smallest number of iterations k such that

$$\underbrace{g(g(\dots g(x)\dots))}_{\text{iterated } k \text{ times}} \geq b.$$

Proof: Firstly, denote: $B_n(x) = \underbrace{g(g(\dots g(x)\dots))}_{n \text{ times}}$, ($n=1, 2, \dots$).

I. Let $A \subseteq \mathbb{Z}$, for $\forall x < b$, $x \in \mathbb{Z}$, assumed that there are not the smallest positive integer k such that $B_k(x) \geq b$, then for $\forall n \in \mathbb{N}$ have $B_n(x) < b$, so

$$x < B_1(x) < B_2(x) < \dots < B_n(x) < \dots < b.$$

This makes know that $\{B_n(x)\}$ is convergent, but it is not convergent. This appear contradiction, then, there are the smallest k such that $B_n(x) \geq b$.

II. Let $A \subseteq \mathbb{Q}$ or $A \subseteq \mathbb{R}$.

(1). For fixed $x < b$. If $g(x) \geq g(b) > b$, then $B_n(x) \geq g(x) > b$ ($n \in \mathbb{N}$), $SI2(x, b) = 1$,
if $g(x) < g(b)$ but $B_2(x) \geq g(b) > b$, then $B_n(x) \geq g(b) > b$ ($n \geq 2$), $SI2(x, b) = 2$. In
general, if $B_1(x) < g(b)$, $B_2(x) < g(b)$, \dots $B_{k-1}(x) < g(b)$, but $B_k(x) \geq g(b) > b$, then
 $SI2(x, b) = k$.

(2). For fixed $x < b$, $B_n(x) < g(b)$, ($n \in \mathbb{N}$) then

$$x < B_1(x) < B_2(x) < \dots < B_n(x) < \dots < g(b),$$

so $\{B_n(x)\}$ is convergent. Let $\lim_{n \rightarrow \infty} B_n(x) = b^* \because B_n(x) < g(b)$ ($n \in \mathbb{N}$), $\therefore b^* \leq g(b)$.

1). $b^* = g(b)$. $\because \lim_{n \rightarrow \infty} B_n(x) = b^* \therefore$ for $\varepsilon = g(b) - b > 0$, \exists positive integer k , when $n > k$ such that $|B_n(x) - g(b)| < \varepsilon$. So $B_n(x) > g(b) - \varepsilon = g(b) - (g(b) - b) = b$. That is to say there are the smallest k such that $B_n(x) > b$. 2). $b^* < g(b)$. $\because g(b^*) > b^*$, $\therefore \{B_n(x)\}$ does not converge at $g(b^*)$. So $\exists \varepsilon_0 > 0$, for $\forall N$, $\exists n_1$, when $n_1 > N$, such that $|B_{n_1}(x) - g(b^*)| \geq \varepsilon_0$, then, $B_{n_1}(x) \geq g(b^*) + \varepsilon_0 \therefore B_{n_1}(x) > b^* + \varepsilon_0$. On the other hand, $B_n(x) \leq b^*$ ($n \in \mathbb{N}$), $\therefore B_{n_1}(x) \leq b^*$ then $b^* + \varepsilon_0 < B_{n_1}(x) \leq b^*$, but this is unable. This makes know that there is not the case.

By (1) and (2) we can deduce the conclusion is true in the case of A belong to \mathbb{Q} or \mathbb{R} .

Combining I. and II., we have: for any fixed $x > b$ there is

$SI2(x, b)$ = the smallest number of iterations k such that

$$\underbrace{g(g(\dots g(x)\dots))}_{\text{iterated } k \text{ times}} \geq b.$$

This proves Kind 2.

3. Proving Functional Smarandache Iterations of Second Kind.

Kind 3.

Let $h: A \rightarrow A$ be a function, such that $h(x) < x$ for all x , and let $b < x$.

Then:

$SI_3(x,b)$ = the smallest number of iterations k such that

$$\underbrace{h(h(\dots h(x)\dots))}_{\text{iterated } k \text{ times}} \leq b.$$

Using similar methods of proving Kind 2 we also can prove Kind 3, we will not prove again in the place.

We complete the proofs of Functional Smarandache Iterations of all kinds in the place.

REFERNECES

1. "Functional Iterations" at <http://www.gallup.unm.edu/~smarandache/bases.txt>
2. East China Normal University Department of Mathematics Writing, Mathematics Analytic, People's Education Press, Shanghai, 1982-4.

ON THE INFERIOR AND SUPERIOR k -TH POWER PART OF A POSITIVE INTEGER AND DIVISOR FUNCTION

ZHENG JIANFENG

Shaanxi Financial & Economics Professional College,
Xianyang, Shaanxi, P.R.China

ABSTRACT: For any positive integer n , let $a(n)$ and $b(n)$ denote the inferior and superior k -th power part of n respectively. That is, $a(n)$ denotes the largest k -th power less than or equal to n , and $b(n)$ denotes the smallest k -th power greater than or equal to n . In this paper, we study the properties of the sequences $\{a(n)\}$ and $\{b(n)\}$, and give two interesting asymptotic formulas.

Key words and phrases: Inferior and superior k -th power part; Mean value; Asymptotic formula.

1. INTRODUCTION

For a fixed positive integer $k > 1$, and any positive integer n , let $a(n)$ and $b(n)$ denote the inferior and superior k -th power part of n respectively. That is, $a(n)$ denotes the largest k -th power less than or equal to n , $b(n)$ denotes the smallest k -th power greater than or equal to n . For example, let $k=2$ then $a(1)=a(2)=a(3)=1, a(4)=a(5)=\dots=a(7)=4, \dots, b(1)=1, b(2)=b(3)=b(4)=4, b(5)=b(6)=\dots=b(8)=8 \dots$; let $k=3$ then $a(1)=a(2)=\dots=a(7)=1, a(8)=a(9)=\dots=a(26)=8, \dots, b(1)=1, b(2)=b(3)=\dots=b(8)=8, b(9)=b(10)=\dots=b(27)=27 \dots$. In problem 40 and 41 of [1], Professor F. Smarandache asks us to study the properties of the sequences $\{a(n)\}$ and $\{b(n)\}$. About these problems, Professor Zhang Wenpeng [4] gave two interesting asymptotic formulas of the cure part of a positive integer. In this paper, we give asymptotic formulas of the k -th power part of a positive integer. That is, we shall prove the following:

Theorem 1. For any real number $x > 1$, we have the asymptotic formula

$$\sum_{n \leq x} d(a(n)) = \frac{1}{k!} \left(\frac{6}{k\pi^2} \right)^{k-1} A_0 x \ln^k x + A_1 x \ln^{k-1} x + \dots + A_{k-1} x \ln x + A_k x + O(x^{1-\frac{1}{2k}+\varepsilon}),$$

where A_0, A_1, \dots, A_k are constants, especially when k equals to 2, $A_0=1$; $d(n)$ denotes the Dirichlet divisor function, ε is any fixed positive number.

For the sequence $\{b(n)\}$, we can also get similar result.

Theorem 2. For any real number $x > 1$, we have the asymptotic formula

$$\sum_{n \leq x} d(b(n)) = \frac{1}{k!} \left(\frac{6}{k\pi^2} \right)^{k-1} A_0 x \ln^k x + A_1 x \ln^{k-1} x + \dots + A_{k-1} x \ln x + A_k x + O(x^{1-\frac{1}{2k}+\varepsilon})$$

2. A SIMPLE LEMMA

To complete the proof of the theorems, we need following

Lemma 1. For any real number $x > 1$, we have the asymptotic formula

$$\sum_{n \leq x} d(n^k) = \frac{1}{k!} \left(\frac{6}{\pi^2}\right)^{k-1} B_0 x \ln^k x + B_1 x \ln^{k-1} x + \cdots + B_{k-1} x \ln x + B_k x + O(x^{\frac{1}{2}+\varepsilon}).$$

where B_0, B_1, \dots, B_k are constants, especially when $k=2, A_0=1$; ε is any fixed positive number.

Proof. Let $s = \sigma + it$ be a complex number and $f(s) = \sum_{n=1}^{\infty} \frac{d(n^k)}{n^s}$.

Note that $d(n^k) \ll n^\varepsilon$, So it is clear that $f(s)$ is a Dirichlet series absolutely convergent in $\text{Re}(s) > 1$, by the Euler Product formula [2] and the definition of $d(n)$ we have

$$\begin{aligned} f(s) &= \prod_p \left(1 + \frac{d(p^k)}{p^s} + \frac{d(p^{2k})}{p^{2s}} + \cdots + \frac{d(p^{kn})}{p^{ns}} + \cdots \right) \\ &= \prod_p \left(1 + \frac{k+1}{p^s} + \frac{2k+1}{p^{2s}} + \cdots + \frac{kn+1}{p^{ns}} + \cdots \right) \\ &= \zeta^2(s) \prod_p \left(1 + (k-1) \frac{1}{p^s} \right) \\ &= \zeta^2(s) \prod_p \left(\left(1 + \frac{1}{p^s}\right)^{k-1} - C_{k-1}^2 \frac{1}{p^{2s}} - \cdots - \frac{1}{p^{(k-1)s}} \right) \\ &= \frac{\zeta^{k+1}(s)}{\zeta^{k-1}(2s)} g(s). \end{aligned} \tag{1}$$

where $\zeta(s)$ is Riemann zeta-function and \prod_p denotes the product over all primes.

From (1) and Perron's formula [3] we have

$$\sum_{n \leq x} d(n^k) = \frac{1}{2\pi i} \int_{\sigma-iT}^{\sigma+iT} \frac{\zeta^{k+1}(s)}{\zeta^{k-1}(2s)} g(s) \frac{x^s}{s} ds + O\left(\frac{x^{2+\varepsilon}}{T}\right), \tag{2}$$

where $g(s)$ is absolutely convergent in $\text{Re}(s) > \frac{1}{2} + \varepsilon$. We move the integration in (2) to

$\text{Re}(s) = \frac{1}{2} + \varepsilon$. The pole at $s=1$ contributes to

$$\frac{1}{k!} \left(\frac{6}{\pi^2}\right)^{k-1} B_0 x \ln^k x + B_1 x \ln^{k-1} x + \cdots + B_{k-1} x \ln x + B_k x, \tag{3}$$

where B_0, B_1, \dots, B_k are constants, especially when $k=2, B_0=1$.

For $\frac{1}{2} \leq \sigma < 1$, note that $\zeta(s) = \zeta(\sigma + it) \leq |t|^{\frac{1-\sigma}{2}+\varepsilon}$. Thus, the horizontal integral contributes to

$$O\left(x^{\frac{1}{2}+\varepsilon} + \frac{x^2}{T}\right), \quad (4)$$

and the vertical integral contributes to

$$O\left(x^{\frac{1}{2}+\varepsilon} \ln^4 T\right). \quad (5)$$

On the line $\operatorname{Re}(s) = \frac{1}{2} + \varepsilon$, taking parameter $T = x^{\frac{3}{2}}$, then combining (2), (3), (4) and (5) we

have

$$\sum_{n \leq x} d(n^k) = \frac{1}{k!} \left(\frac{6}{\pi^2}\right)^{k-1} B_0 x \ln^k x + B_1 x \ln^{k-1} x + \cdots + B_k x + O\left(x^{\frac{1}{2}+\varepsilon}\right).$$

This proves Lemma 1.

3. PROOFS OF THE THEOREMS

Now we complete the proof of the Theorems. First we prove Theorem 1.

For any real number $x > 1$, Let M be a fixed positive integer such that

$$M^k \leq x < (M+1)^k, \quad (6)$$

then, from the definition of $a(n)$, we have

$$\begin{aligned} \sum_{n \leq x} d(a(n)) &= \sum_{m=2}^M \sum_{(m-1)^k \leq n < m^k} d(a(n)) + \sum_{M^k \leq n \leq x} d(a(n)) \\ &= \sum_{m=1}^{M-1} \sum_{m^k \leq n < (m+1)^k} d(m^k) + \sum_{M^k \leq n \leq x} d(M^k) \\ &= \sum_{m=1}^{M-1} (C_k^1 m^{k-1} + C_k^2 m^{k-2} + \cdots + 1) d(m^k) + O\left(\sum_{M^k \leq n \leq (M+1)^k} d(M^k)\right), \\ &= k \sum_{m=1}^M m^{k-1} d(m^k) + O(M^{k-1+\varepsilon}), \end{aligned} \quad (7)$$

where we have used the estimate $d(n) \ll n^\varepsilon$.

Let $B(y) = \sum_{n \leq y} d(n^k)$, then by Abel's identity and Lemma 1, we have

$$\begin{aligned} \sum_{m=1}^M m^{k-1} d(m^k) &= M^{k-1} B(M) - (k-1) \int_1^M y^{k-2} B(y) dy + O(1) \\ &= M^{k-1} \left(\frac{1}{k!} \left(\frac{6}{\pi^2}\right)^{k-1} B_0 M \ln^k M + B_1 M \ln^{k-1} M + \cdots + B_k M \right) \end{aligned}$$

$$\begin{aligned}
& - (k-1) \int_1^M \left(\frac{1}{k!} \left(\frac{6}{\pi^2} \right)^{k-1} B_0 y^{k-1} \ln^k y + B_1 y^{k-1} \ln^{k-1} y + \cdots + B_k y^{k-1} \right) dy \\
& + O \left(M^{k-\frac{1}{2}+\varepsilon} \right) \\
& = \frac{1}{kk!} \left(\frac{6}{\pi^2} \right)^{k-1} B_0 M^k \ln^k M + C_1 M^k \ln^{k-1} M + \cdots + C_{k-1} M^k + O \left(M^{k-\frac{1}{2}+\varepsilon} \right). \quad (8)
\end{aligned}$$

Applying (7) and (8) we obtain the asymptotic formula

$$\sum_{n \leq x} d(a(n)) = \frac{1}{k!} \left(\frac{6}{\pi^2} \right)^{k-1} B_0 M^k \ln^k M + C_1 M^k \ln^{k-1} M + \cdots + C_{k-1} M^k + O \left(M^{k-\frac{1}{2}+\varepsilon} \right), \quad (9)$$

where B_0, C_1, \dots, C_{k-1} are constants.

From (6) we have the estimates

$$\begin{aligned}
0 \leq x - M^k & < (M+1)^k - M^k = kM^{k-1} + C_k^2 M^{k-2} + \cdots + 1 \\
& = M^{k-1} \left(k + C_k^2 \frac{1}{M} + \cdots + \frac{1}{M^{k-1}} \right) \ll x^{\frac{k-1}{k}}, \quad (10)
\end{aligned}$$

and

$$\ln^k x = k^k \ln^k M + O \left(\frac{\ln^{k-1} x}{x^{\frac{1}{k}}} \right) = k^k \ln^k M + O \left(x^{-\frac{1}{k}+\varepsilon} \right). \quad (11)$$

Combining (9), (10) and (11) we have

$$\sum_{n \leq x} d(a(n)) = \frac{1}{kk!} \left(\frac{6}{k\pi^2} \right)^{k-1} A_0 x \ln^k x + A_1 x \ln^{k-1} x + \cdots + A_{k-1} x \ln x + A_k x + O \left(x^{1-\frac{1}{2k}+\varepsilon} \right),$$

where A_0 equals to B_0 .

This proves Theorem 1.

Using the methods of proving Theorem 1 we can also prove Theorem 2. This completes the proof of the Theorems.

Acknowledgments

The author expresses his gratitude to professor Zhang Wenpeng for his very helps and detailed instructions.

REFERENCES:

1. F.Smarandache, Only problems, not Solutions, Xiquan Publ. House, Chicago, 1993, PP. 35.
2. T.M.Apostol, Introduction to Analytic Number Theory, Springer-Verlag, New York, 1976.
3. Pan Chengdong and Pan Chengbiao, Foundation of Analytic Number Theory, Science Press, Beijing, 1997, PP. 98.
4. Zhang Wenpeng, On the cube part sequence of a positive integer (to appear).

ON SOME RECURRENCE TYPE SMARANDACHE SEQUENCES

A.A.K. MAJUMDAR and H. GUNARTO

Ritsumeikan Asia-Pacific University, 1-1 Jumonjibaru, Beppu-shi 874-8577, Oita-ken, Japan.

ABSTRACT. In this paper, we study some properties of ten recurrence type Smarandache sequences, namely, the Smarandache odd, even, prime product, square product, higher-power product, permutation, consecutive, reverse, symmetric, and pierced chain sequences.

AMS (1991) Subject Classification : 11A41, 11A51.

1. INTRODUCTION

This paper considers the following ten recurrence type Smarandache sequences.

(1) Smarandache Odd Sequence : The Smarandache odd sequence, denoted by $\{OS(n)\}_{n=1}^{\infty}$, is defined by (Ashbacher [1])

$$OS(n) = \overline{135 \dots (2n-1)}, n \geq 1. \quad (1.1)$$

A first few terms of the sequence are

$$1, 13, 135, 1357, 13579, 1357911, 135791113, 13579111315, \dots$$

(2) Smarandache Even Sequence : The Smarandache even sequence, denoted by $\{ES(n)\}_{n=1}^{\infty}$, is defined by (Ashbacher [1])

$$ES(n) = \overline{24 \dots (2n)}, n \geq 1. \quad (1.2)$$

A first few terms of the sequence are

$$2, 24, 246, 2468, 246810, 24681012, 2468101214, \dots,$$

of which only the first is a prime number.

(3) Smarandache Prime Product Sequence : Let $\{p_n\}_{n=1}^{\infty}$ be the (infinite) sequence of primes in their natural order, so that $p_1=2, p_2=3, p_3=5, p_4=7, p_5=11, p_6=13, \dots$

The Smarandache prime product sequence, denoted by $\{PPS(n)\}_{n=1}^{\infty}$, is defined by (Smarandache [2])

$$PPS(n) = \overline{p_1 p_2 \dots p_n + 1}, n \geq 1. \quad (1.3)$$

(4) Smarandache Square Product Sequences : The Smarandache square product sequence of the first kind, denoted by $\{SPS_1(n)\}_{n=1}^{\infty}$, and the Smarandache square product sequence of the second kind, denoted by $\{SPS_2(n)\}_{n=1}^{\infty}$, are defined by (Russo [3])

$$SPS_1(n) = \overline{(1^2)(2^2) \dots (n^2) + 1} = (n!)^2 + 1, n \geq 1, \quad (1.4a)$$

$$SPS_2(n) = \overline{(1^2)(2^2) \dots (n^2) - 1} = (n!)^2 - 1, n \geq 1. \quad (1.4b)$$

A first few terms of the sequence $\{SSP_1(n)\}_{n=1}^{\infty}$ are

$$SPS_1(1)=2, SPS_1(2)=5, SPS_1(3)=37, SPS_1(4)=577, SPS_1(5)=14401,$$

$$SPS_1(6)=518401=13 \times 39877, SPS_1(7)=25401601=101 \times 251501,$$

$$SPS_1(8)=1625702401=17 \times 95629553, SPS_1(9)=131681894401,$$

of which the first five terms are each prime.

A first few terms of the sequence $\{SPS_2(n)\}_{n=1}^{\infty}$ are

$$SPS_2(1)=0, SPS_2(2)=3, SPS_2(3)=35, SPS_2(4)=575, SPS_2(5)=14399,$$

$$SPS_2(6)=518399, SPS_2(7)=25401599, SPS_2(8)=1625702399, SPS_2(9)=131681894399,$$

of which, disregarding the first term, the second term is prime, and the remaining terms of the sequence are all composite numbers (see Theorem 6.3).

- (5) Smarandache Higher Power Product Sequences : Let $m (>3)$ be a fixed integer. The Smarandache higher power product sequence of the first kind, denoted by, $\{HPPS_1(n)\}_{n=1}^{\infty}$, and the Smarandache higher power product sequence of the second kind, denoted by, $\{HPPS_2(n)\}_{n=1}^{\infty}$, are defined by

$$HPPS_1(n)=(1^m)(2^m)\dots(n^m)+1=(n!)^m+1, n \geq 1, \quad (1.5a)$$

$$HPPS_2(n)=(1^m)(2^m)\dots(n^m)-1=(n!)^m-1, n \geq 1. \quad (1.5b)$$

- (6) Smarandache Permutation Sequence : The Smarandache permutation sequence, denoted by $\{PS(n)\}_{n=1}^{\infty}$, is defined by (Dumitrescu and Seleacu [4])

$$PS(n)=\overline{135\dots(2n-1)(2n)(2n-2)\dots 42}, n \geq 1. \quad (1.6)$$

A first few terms of the sequence are

$$12, 1342, 135642, 13578642, 13579108642, \dots$$

- (7) Smarandache Consecutive Sequence : The Smarandache consecutive sequence, denoted by $\{CS(n)\}_{n=1}^{\infty}$, is defined by (Dumitrescu and Seleacu [4])

$$CS(n)=\overline{123\dots(n-1)n}, n \geq 1. \quad (1.7)$$

A first few terms of the sequence are

$$1, 12, 123, 1234, 12345, 123456, \dots$$

- (8) Smarandache Reverse Sequence : The Smarandache reverse sequence, denoted by, $\{RS(n)\}_{n=1}^{\infty}$, is defined by (Ashbacher [1])

$$RS(n)=\overline{n(n-1)\dots 21}, n \geq 1. \quad (1.8)$$

A first few terms of the sequence are

$$1, 21, 321, 4321, 54321, 654321, \dots$$

- (9) Smarandache Symmetric Sequence: The Smarandache symmetric sequence, denoted by $\{SS(n)\}_{n=1}^{\infty}$, is defined by (Ashbacher [1])

$$1, 11, 121, 12321, 1234321, 123454321, 12345654321, \dots$$

Thus,

$$SS(n)=\overline{12\dots(n-2)(n-1)(n-2)\dots 21}, n \geq 3; \quad SS(1)=1, SS(2)=11. \quad (1.9)$$

- (10) Smarandache Pierced Chain Sequence : The Smarandache pierced chain sequence, denoted by $\{PCS(n)\}_{n=1}^{\infty}$, is defined by (Ashbacher [1])

$$101, 1010101, 10101010101, 101010101010101, \dots, \quad (1.10)$$

which is obtained by successively concatenating the string 0101 to the right of the preceding terms of the sequence, starting with $PCS(1)=101$.

As has been pointed out by Ashbacher, all the terms of the sequence $\{PCS(n)\}_{n=1}^{\infty}$ is divisible by 101. We thus get from the sequence $\{PCS(n)\}_{n=1}^{\infty}$, on dividing by 101, the sequence $\{PCS(n)/101\}_{n=1}^{\infty}$. The elements of the sequence $\{PCS(n)/101\}_{n=1}^{\infty}$ are

$$1, 10001, 100010001, 1000100010001, \dots \quad (1.11)$$

Smarandache [5] raised the question : How many terms of the sequence $\{PCS(n)/101\}_{n=1}^{\infty}$ are prime?

In this paper, we consider some of the properties satisfied by these ten Smarandache sequences in the next ten sections where we derive the recurrence relations as well.

For the Smarandache odd, even, consecutive and symmetric sequences, Ashbacher [1] raised the question : Are there any Fibonacci or Lucas numbers in these sequences?

We recall that the sequence of Fibonacci numbers, $\{F(n)\}_{n=1}^{\infty}$, and the sequence of Lucas numbers $\{L(n)\}_{n=1}^{\infty}$, are defined by (Ashbacher [1])

$$F(0)=0, F(1)=1; F(n+2)=F(n+1)+F(n), n \geq 0, \quad (1.12)$$

$$L(0)=2, L(1)=1; L(n+2)=L(n+1)+L(n), n \geq 0, \quad (1.13)$$

Based on computer search for Fibonacci and Lucas numbers, Ashbacher conjectures that there are no Fibonacci or Lucas numbers in any of the Smarandache odd, even, consecutive and symmetric sequences (except for the trivial cases). This paper confirms the conjectures of Ashbacher. We prove further that none of the Smarandache prime product and reverse sequences contain Fibonacci or Lucas numbers (except for the trivial cases).

For the Smarandache even, prime product, permutation and square product sequences, the question is : Are there any perfect powers in each of these sequences? We have a partial answer for the first of these sequences, while for each of the remaining sequences, we prove that no number can be expressed as a perfect power. We also prove that no number of the Smarandache higher power product sequences is square of a natural number.

For the Smarandache odd, prime product, consecutive, reverse and symmetric sequences, the question is : How many primes are there in each of these sequences? For the Smarandache even sequence, the question is : How many elements of the sequence are twice a prime? These questions still remain open.

In the subsequent analysis, we would need the following result.

Lemma 1.1 : $3|(10^m+10^n+1)$ for all integers $m, n \geq 0$.

Proof : We consider the following three possible cases separately :

(1) $m=n=0$. In this case, the result is clearly true.

(2) $m=0, n \geq 1$. Here,

$$10^m+10^n+1=10^n+2=(10^n-1)+3,$$

and so the result is true, since $3|10^n-1=9(1+10+10^2+\dots+10^{n-1})$.

(3) $m \geq 1, n \geq 1$. In this case, writing

$$10^m+10^n+1=(10^m-1)+(10^n-1)+3,$$

we see the validity of the result. \square

2. SMARANDACHE ODD SEQUENCE $\{OS(n)\}_{n=1}^{\infty}$

The Smarandache odd sequence is the sequence of numbers formed by repeatedly concatenating the odd positive integers, and the n -th term of the sequence is given by (1.1).

For any $n \geq 1$, $OS(n+1)$ can be expressed in terms of $OS(n)$ as follows : For $n \geq 1$,

$$\begin{aligned} OS(n+1) &= \overline{135 \dots (2n-1)(2n+1)} \\ &= 10^s OS(n) + (2n+1) \quad \text{for some integer } s \geq 1. \end{aligned} \quad (2.1)$$

More precisely,

$$s = \text{number of digits in } (2n+1).$$

Thus, for example, $OS(5) = (10)OS(4) + 7$, while, $OS(6) = (10^2)OS(5) + 11$.

By repeated application of (2.1), we get

$$\begin{aligned} OS(n+3) &= 10^s OS(n+2) + (2n+5) \quad \text{for some integer } s \geq 1 \\ &= 10^s [10^t OS(n+1) + (2n+3)] + (2n+5) \quad \text{for some integer } t \geq 1 \end{aligned} \quad (2.2a)$$

$$= 10^{s+t} [10^u OS(n) + (2n+1)] + (2n+3)10^s + (2n+5) \quad \text{for some integer } u \geq 1, \quad (2.2b)$$

so that

$$OS(n+3) = 10^{s+t+u} OS(n) + (2n+1)10^{s+t} + (2n+3)10^s + (2n+5), \quad (2.3)$$

where $s \geq t \geq u \geq 1$.

Lemma 2.1 : $3 | OS(n)$ if and only if $3 | OS(n+3)$.

Proof : For any s, t with $s \geq t \geq 1$, by Lemma 1.1,

$$3 \mid [(2n+1)10^{s+t} + (2n+3)10^s + (2n+5)] = (2n+1)(10^{s+t} + 10^s + 1) + (10^s + 2).$$

The result is now evident from (2.3). \square

From the expression of $OS(n+3)$ given in (2.2), we see that, for all $n \geq 1$,

$$\begin{aligned} OS(n+3) &= 10^{s+t} OS(n+1) + \overline{(2n+3)(2n+5)} \\ &= 10^{s+t+u} OS(n) + \overline{(2n+1)(2n+3)(2n+5)}. \end{aligned}$$

The following result has been proved by Ashbacher [1].

Lemma 2.2 : $3 \mid OS(n)$ if and only if $3 \mid n$. In particular, $3 \mid OS(3n)$ for all $n \geq 1$.

In fact, it can be proved that $9 \mid OS(3n)$ for all $n \geq 1$.

We now prove the following result.

Lemma 2.3 : $5 \mid OS(5n+3)$ for all $n \geq 0$.

Proof : From (2.1), for any arbitrary but fixed $n \geq 0$,

$$OS(5n+3) = 10^s OS(5n+2) + (10n+5) \text{ for some integer } s \geq 1.$$

The r.h.s. is clearly divisible by 5, and hence $5 \mid OS(5n+3)$.

Since n is arbitrary, the lemma is established. \square

Ashbacher [1] devised a computer program which was then run for all numbers from 135 up through $OS(2999) = 135 \dots 29972999$, and based on the findings, he conjectures that (except for the trivial case of $n=1$, for which $OS(1)=1=F(1)=L(1)$) there are no numbers in the Smarandache odd sequence that are also Fibonacci (or, Lucas) numbers. In Theorem 2.1 and Theorem 2.2, we prove the conjectures of Ashbacher in the affirmative. The proof of the theorems relies on the following results.

Lemma 2.4 : For any $n \geq 1$, $OS(n+1) > 10 OS(n)$.

Proof : From (2.1), for any $n \geq 1$,

$$OS(n+1) = 10^s OS(n) + (2n+1) > 10^s OS(n) > 10 OS(n),$$

where $s \geq 1$ is an integer. We thus get the desired inequality. \square

Corollary 2.1 : For any $n \geq 1$, $OS(n+2) - OS(n) > 9[OS(n+1) + OS(n)]$.

Proof : From Lemma 2.4,

$$OS(n+1) - OS(n) > 9 OS(n) \text{ for all } n \geq 1. \tag{2.4}$$

Now, using the inequality (2.4), we get

$$OS(n+2) - OS(n) = [OS(n+2) - OS(n+1)] + [OS(n+1) - OS(n)] > 9[OS(n+1) + OS(n)],$$

which establishes the lemma. \square

Theorem 2.1 : (Except for $n=1, 2$ for which $OS(1)=1=F(1)=F(2)$, $OS(2)=13=F(7)$) there are no numbers in the Smarandache odd sequence that are also Fibonacci numbers.

Proof : Using Corollary 2.1, we see that, for all $n \geq 1$,

$$OS(n+2) - OS(n) > 9[OS(n+1) + OS(n)] > OS(n+1). \tag{2.5}$$

Thus, no numbers of the Smarandache odd sequence satisfy the recurrence relation (2.10) satisfied by the Fibonacci numbers. \square

By similar reasoning, we have the following result.

Theorem 2.2 : (Except for $n=1$ for which $OS(1)=1=L(2)$) there are no numbers in the Smarandache odd sequence that are Lucas numbers.

Searching for primes in the Smarandache odd sequence (using UBASIC program), Ashbacher [1] found that among the first 21 elements of the sequence, only $OS(2)$, $OS(10)$ and $OS(16)$ are primes. Marimutha [6] conjectures that there are infinitely many primes in the Smarandache odd sequence, but the conjecture still remains to be resolved.

In order to search for primes in the Smarandache odd sequence, by virtue of Lemma 2.2 and Lemma 2.3, it is sufficient to check the terms of the forms $OS(3n \pm 1)$, $n \geq 1$, where neither $3n+1$ nor $3n-1$ is of the form $5k+3$ for some integer $k \geq 1$.

3. SMARANDACHE EVEN SEQUENCE $\{ES(n)\}_{n=1}^{\infty}$

The Smarandache even sequence, whose n -th term is given by (1.2), is the sequence of numbers formed by repeatedly concatenating the even positive integers.

We note that, for any $n \geq 1$,

$$\begin{aligned} ES(n+1) &= \overline{24 \dots (2n)(2n+2)} \\ &= 10^s ES(n) + (2n+2) \text{ for some integer } s \geq 1. \end{aligned} \quad (3.1)$$

More precisely,

$$s = \text{number of digits in } (2n+2).$$

Thus, for example, $ES(4) = 2468 = 10 ES(3) + 8$, while, $ES(5) = 246810 = 10^2 ES(4) + 10$.

From (3.1), the following result follows readily.

Lemma 3.1: For any $n \geq 1$, $ES(n+1) > 10 ES(n)$.

Using Lemma 3.1, we can prove that

$$ES(n+2) - ES(n) > 9[ES(n+1) + ES(n)] \text{ for all } n \geq 1. \quad (3.2)$$

The proof is similar to that given in establishing the inequality (2.1) and is omitted here.

By repeated application of (3.1), we see that, for any $n \geq 1$,

$$\begin{aligned} ES(n+2) &= 10^t ES(n+1) + (2n+4) \text{ for some integer } t \geq 1 \\ &= 10^t [10^u ES(n) + (2n+2)] + (2n+4) \text{ for some integer } u \geq 1 \\ &= 10^{u+t} ES(n) + (2n+2)10^t + (2n+4), \end{aligned}$$

so that

$$\begin{aligned} ES(n+3) &= 10^s ES(n+2) + (2n+6) \text{ for some integer } s \geq 1 \\ &= 10^s [10^t ES(n+1) + (2n+4)] + (2n+6) \\ &= 10^{s+t+u} ES(n) + (2n+2)10^{s+t} + (2n+2)10^s + (2n+6), \end{aligned} \quad (3.3)$$

for some integers s, t and u with $s \geq t \geq u \geq 1$.

From (3.3), we see that

$$\begin{aligned} ES(n+3) &= 10^{s+t} ES(n+1) + \overline{(2n+4)(2n+6)} \\ &= 10^{s+t+u} ES(n) + \overline{(2n+2)(2n+4)(2n+6)}. \end{aligned}$$

Using (3.3), we can prove the following result.

Lemma 3.2: If $3 \mid ES(n)$ for some $n \geq 1$, then $3 \mid ES(n+3)$, and conversely.

Lemma 3.3: For all $n \geq 1$, $3 \mid ES(3n)$.

Proof: The proof is by induction on n . Since $ES(3) = 246$ is divisible by 3, the lemma is true for $n=1$. We now assume that the result is true for some n , that is, $3 \mid ES(3n)$ for some n .

Now, by Lemma 3.2, together with the induction hypothesis, we see that $ES(3n+3) = ES(3(n+1))$ is divisible by 3. Thus the result is true for $n+1$. \square

Corollary 3.1: For all $n \geq 1$, $3 \mid ES(3n-1)$.

Proof: Let $n (\geq 1)$ be any arbitrary but fixed integer. From (3.1),

$$ES(3n) = 10^s ES(3n-1) + (6n) \text{ for some integer } s \geq 1.$$

Now, by Lemma 3.2, $3 \mid ES(3n)$. Therefore, 3 must also divide $ES(3n-1)$.

Since n is arbitrary, the lemma is proved. \square

Corollary 3.2: For any $n \geq 1$, $3 \nmid ES(3n+1)$.

Proof: Let $n (\geq 1)$ be any arbitrary but fixed integer. From (3.1),

$$ES(3n+1) = 10^s ES(3n) + (6n+2) \text{ for some integer } s \geq 1.$$

Since $3 \mid ES(3n)$, but 3 does not divide $(6n+2)$, the result follows. \square

Lemma 3.4 : $4 \mid ES(2n)$ for all $n \geq 1$.

Proof : Since $4 \mid ES(2)=24$ and $4 \mid ES(4)=2468$, we see that the result is true for $n=1,2$. Now, from (3.1), for $n \geq 1$,

$$ES(2n) = 10^s ES(2n-1) + (4n),$$

where s is the number of digits in $(4n)$. Clearly, $s \geq 2$ for all $n \geq 3$. Thus, $4 \mid 10^s$ if $n \geq 3$, and we get the desired result. \square

Corollary 3.3 : For any $n \geq 0$, $4 \nmid ES(2n+1)$.

Proof : Clearly the result is true for $n=0$, since $ES(1)=2$ is not divisible by 4. For $n \geq 1$, from (3.1),

$$ES(2n+1) = 10^s ES(2n) + (4n+2) \text{ for some integer } s \geq 1.$$

By Lemma 3.4, $4 \mid ES(2n)$. Since $4 \nmid (4n+2)$, the result follows. \square

Lemma 3.5 : For all $n \geq 1$, $10 \mid ES(5n)$.

Proof : For any arbitrary but fixed $n \geq 1$, from (3.1),

$$ES(5n) = 10^s ES(5n-1) + (10n) \text{ for some integer } s \geq 1.$$

The result is now evident from the above expression of $ES(5n)$. \square

Corollary 3.4 : $20 \mid ES(10n)$ for all $n \geq 1$.

Proof : follows by virtue of Lemma 3.4 and Lemma 3.5. \square

Based on the computer findings with numbers up through $ES(1499)=2468\dots29962998$, Ashbacher [1] conjectures that (except for the case of $ES(1)=2=F(3)=L(0)$) there are no numbers in the Smarandache even sequence that are also Fibonacci (or, Lucas) numbers. The following two theorems establish the validity of Ashbacher's conjectures. The proofs of the theorems make use of the inequality (3.2) and are similar to those used in proving Theorem 2.1. We thus omit the proof here.

Theorem 3.1 : (Except for $ES(1)=2=F(3)$) there are no numbers in the Smarandache even sequence that are Fibonacci numbers.

Theorem 3.2 : (Except for $ES(1)=2=L(0)$) there are no numbers in the Smarandache even sequence that are Lucas numbers.

Ashbacher [1] raised the question: Are there any perfect powers in $ES(n)$? The following theorem gives a partial answer to the question.

Theorem 3.3 : None of the terms of the subsequence $\{ES(2n-1)\}_{n=1}^{\infty}$ is a perfect square or higher power of an integer (>1).

Proof : Let, for some $n \geq 1$,

$$ES(n) = \overline{24 \dots (2n)} = x^2 \text{ for some integer } x > 1.$$

Now, since $ES(n)$ is even for all $n \geq 1$, x must be even. Let $x=2y$ for some integer $y \geq 1$. Then,

$$ES(n) = (2y)^2 = 4y^2,$$

which shows that $4 \mid ES(n)$.

Now, if n is odd of the form $2k-1$, $k \geq 1$, by Corollary 3.3, $ES(2k-1)$ is not divisible by 4, and hence numbers of the form $ES(2k-1)$, $k \geq 1$, can not be perfect squares. By same reasoning, none of the terms $ES(2n-1)$, $n \geq 1$, can be expressed as a cube or higher powers of an integer. \square

Remark 3.1 : It can be seen that, if n is of the form $k \times 10^s + 4$ or $k \times 10^s + 6$, where k ($1 \leq k \leq 9$) and s (≥ 1) are integers, then $ES(n)$ cannot be a perfect square (and hence, cannot be any even power of a natural number). The proof is as follows : If

$$ES(n) = x^2 \text{ for some integer } x > 1, \tag{*}$$

then x must be an even integer. The following table gives the possible trailing digits of x and the corresponding trailing digits of x^2 :

Trailing digit of x	Trailing digit of x ²
2	4
4	6
6	6
8	4

Since the trailing digit of $ES(k \times 10^s + 4)$ is 8 for all admissible values of k and s , it follows that the representation of $ES(k \times 10^s + 4)$ in the form (*) is not possible. By similar reasoning, if n is of the form $n = k \times 10^s + 6$, then $ES(n) = ES(k \times 10^s + 6)$ with the trailing digit of 2, cannot be expressed as a perfect square (and hence, any even power of a natural number). Thus, it remains to consider the cases when n is one of the forms (1) $n = k \times 10^s$, (2) $n = k \times 10^s + 2$, (3) $n = k \times 10^s + 8$ (where, in all the three cases, k ($1 \leq k \leq 9$) and s (≥ 1) are integers). Smith [7] conjectures that none of the terms of the sequence $\{ES(n)\}_{n=1}^{\infty}$ is a perfect power.

4. SMARANDACHE PRIME PRODUCT SEQUENCE $\{PPS(n)\}_{n=1}^{\infty}$

The n -th term, $PPS(n)$, of the Smarandache prime product sequence is given by (1.3). The following lemma gives a recurrence relation in connection with the sequence.

Lemma 4.1: $PPS(n+1) = p_{n+1} PPS(n) - (p_{n+1} - 1)$ for all $n \geq 1$.

Proof: By definition,

$$PPS(n+1) = p_1 p_2 \dots p_n p_{n+1} + 1 = (p_1 p_2 \dots p_n + 1) p_{n+1} - p_{n+1} + 1,$$

which now gives the desired relationship. \square

From Lemma 4.1, we get

Corollary 4.1: $PPS(n+1) - PPS(n) = [PPS(n) - 1](p_{n+1} - 1)$ for all $n \geq 1$.

Lemma 4.2: (1) $PPS(n) < (p_n)^{n-1}$ for all $n \geq 4$, (2) $PPS(n) < (p_n)^{n-2}$ for all $n \geq 7$,
 (3) $PPS(n) < (p_n)^{n-3}$ for all $n \geq 10$, (4) $PPS(n) < (p_{n+1})^{n-1}$ for all $n \geq 3$,
 (5) $PPS(n) < (p_{n+1})^{n-2}$ for all $n \geq 6$, (6) $PPS(n) < (p_{n+1})^{n-3}$ for all $n \geq 9$.

Proof: We prove parts (3) and (6) only, the proof of the other parts is similar.

To prove part (3) of the lemma, we note that the result is true for $n=10$, since

$$PPS(10) = 6469693231 < (p_{10})^7 = 29^7 = 17249876309.$$

Now, assuming the validity of the result for some integer k (≥ 10), and using Lemma 4.1, we see that,

$$\begin{aligned} PPS(k+1) &= p_{k+1} PPS(k) - (p_{k+1} - 1) < p_{k+1} PPS(k) \\ &< p_{k+1} (p_k)^{n-3} \quad (\text{by the induction hypothesis}) \\ &< (p_{k+1})(p_{k+1})^{n-3} = (p_{k+1})^{n-2}, \end{aligned}$$

where the last inequality follows from the fact that the sequence of primes, $\{p_n\}_{n=1}^{\infty}$, is strictly increasing in n (≥ 1). Thus, the result is true for $k+1$ as well.

To prove part (6) of the lemma, we note that the result is true for $n=9$, since

$$PPS(9) = 223092871 < (p_{10})^6 = 29^6 = 594823321.$$

Now to appeal to the principle of induction, we assume that the result is true for some integer k (≥ 9). Then using Lemma 4.1, together with the induction hypothesis, we get

$$PPS(k+1) = p_{k+1} PPS(k) - (p_{k+1} - 1) < p_{k+1} PPS(k) < p_{k+1} (p_{k+1})^{k-3} = (p_{k+1})^{k-2}.$$

Thus the result is true for $k+1$.

All these complete the proof by induction. \square

Lemma 4.3: Each of $PPS(1)$, $PPS(2)$, $PPS(3)$, $PPS(4)$ and $PPS(5)$ is prime, and for $n \geq 6$, $PPS(n)$ has at most $n-4$ prime factors, counting multiplicities.

Proof : Clearly $PPS(1)=3$, $PPS(2)=7$, $PPS(3)=31$, $PPS(4)=211$, $PPS(5)=2311$ are all primes. Also, since

$PPS(6)=30031=59 \times 509$, $PPS(7)=510511=19 \times 97 \times 277$, $PPS(8)=9699691=347 \times 27953$, we see that the lemma is true for $6 \leq n \leq 8$.

Now, if p is a prime factor of $PPS(n)$, then $p \geq p_{n+1}$. Therefore, if for some $n \geq 9$, $PPS(n)$ has $n-3$ (or more) prime factors (counted with multiplicity), then $PPS(n) \geq (p_{n+1})^{n-3}$, contradicting part (6) of Lemma 4.2.

Hence the lemma is established. \square

Lemma 4.3 above improves the earlier results (Prakash [8], and Majumdar [9]).

The following lemma improves a previous result (Majumdar [10]).

Lemma 4.4 : For any $n \geq 1$ and $k \geq 1$, $PPS(n)$ and $PPS(n+k)$ can have at most $k-1$ number of prime factors (counting multiplicities) in common.

Proof : For any $n \geq 1$ and $k \geq 1$,

$$PPS(n+k) - PPS(n) = p_1 p_2 \dots p_n (p_{n+1} p_{n+2} \dots p_{n+k} - 1). \quad (4.1)$$

If p is a common prime factor of $PPS(n)$ and $PPS(n+k)$, since $p \geq p_{n+k}$, it follows from (4.1) that $p \mid (p_{n+1} p_{n+2} \dots p_{n+k} - 1)$. Now if $PPS(n)$ and $PPS(n+k)$ have k (or more) prime factors in common, then the product of these common prime factors is greater than $(p_{n+k})^k$, which can not divide $p_{n+1} p_{n+2} \dots p_{n+k} - 1 < (p_{n+k})^k$.

This contradiction proves the lemma. \square

Corollary 4.2 : For any integers $n (\geq 1)$ and $k (\geq 1)$, if all the prime factors of $p_{n+1} p_{n+2} \dots p_{n+k} - 1$ are less than p_{n+k} , then $PPS(n)$ and $PPS(n+k)$ are relatively prime.

Proof : If p is any common prime factor of $PPS(n)$ and $PPS(n+k)$, then $p \mid (p_{n+1} p_{n+2} \dots p_{n+k} - 1)$. Also, such $p > p_{n+k}$, contradicting the hypothesis of the corollary. Thus, if all the common prime factors of $PPS(n)$ and $PPS(n+k)$ are less than p_{n+k} , then $(PPS(n), PPS(n+k)) = 1$. \square

The following result has been proved by others (Prakash [8] and Majumdar [10]). Here we give a simpler proof.

Theorem 4.1 : For any $n \geq 1$, $PPS(n)$ is never a square or higher power of an integer (> 1).

Proof : Clearly, none of $PPS(1)$, $PPS(2)$, $PPS(3)$, $PPS(4)$ and $PPS(5)$ can be expressed as powers of integers (by Lemma 4.3).

Now, if possible, let for some $n \geq 6$,

$$PPS(n) = x^\ell \text{ for some integers } x (> 3), \ell (\geq 2). \quad (*)$$

Without loss of generality, we may assume that ℓ is a prime (if ℓ is a composite number, letting $\ell = pr$ where p is prime, we have $PPS(n) = (x^r)^p = N^p$, where $N = x^r$). By Lemma 4.3, $\ell \leq n-4$ and so ℓ cannot be greater than p_{n-5} ($\ell \geq p_{n-4} \Rightarrow \ell > n-4$, since $p_n > n$ for all $n \geq 1$). Hence, ℓ must be one of the primes p_1, p_2, \dots, p_{n-5} . Also, since $PPS(n)$ is odd, x must be odd. Let $x = 2y + 1$ for some integer $y > 0$. Then, from (*),

$$\begin{aligned} p_1 p_2 \dots p_n &= (2y+1)^\ell - 1 \\ &= (2y)^\ell + \binom{\ell}{1} (2y)^{\ell-1} + \dots + \binom{\ell}{\ell-1} (2y). \end{aligned} \quad (**)$$

If $\ell = 2$, we see from (**), $4 \mid p_1 p_2 \dots p_n$, which is absurd. On the other hand, for $\ell \geq 3$, since $\ell \mid p_1 p_2 \dots p_n$, it follows from (**) that $\ell \mid y$, and consequently, $\ell^2 \mid p_1 p_2 \dots p_n$, which is impossible.

Hence, the representation of $PPS(n)$ in the form (*) is not possible. \square

Using Corollary 4.1 and the fact that $PPS(n+1) - PPS(n) > 0$, we get

$$\begin{aligned} PPS(n+2) - PPS(n) &= [PPS(n+2) - PPS(n+1)] + [PPS(n+1) - PPS(n)] \\ &> [PPS(n+1) - 1] (p_{n+2} - 1) \\ &> 2[PPS(n+1) - 1] \text{ for all } n \geq 1. \end{aligned}$$

Hence,

$$\text{PPS}(n+2) - \text{PPS}(n) > \text{PPS}(n+1) \text{ for all } n \geq 1. \quad (4.2)$$

The inequality (4.2) shows that no elements of the Smarandache prime product sequence satisfy the recurrence relation for Fibonacci (or, Lucas) numbers. This leads to the following theorem.

Theorem 4.2 : There are no numbers in the Smarandache prime product sequence that are Fibonacci (or Lucas) numbers (except for the trivial cases of $\text{PPS}(1)=3=F(4)=L(2)$, $\text{PPS}(2)=7=L(4)$).

5. SMARANDACHE SQUARE PRODUCT SEQUENCES $\{\text{SPS}_1(n)\}_{n=1}^{\infty}$, $\{\text{SPS}_2(n)\}_{n=1}^{\infty}$

The n -th terms, $\text{SPS}_1(n)$ and $\text{SPS}_2(n)$, are given in (1.4a) and (1.4b) respectively.

In Theorem 5.1, we prove that, for any $n \geq 1$, neither of $\text{SPS}_1(n)$ and $\text{SPS}_2(n)$ is a square of an integer (>1). To prove the theorem, we need the following results.

Lemma 5.1: The only non-negative integer solution of the Diophantine equation $x^2 - y^2 = 1$ is $x=1, y=0$.

Proof : The given Diophantine equation is equivalent to $(x-y)(x+y)=1$, where both $x-y$ and $x+y$ are integers. Therefore, the only two possibilities are

$$(1) \ x-y=1=x+y, \quad (2) \ x-y=-1=x+y,$$

the first of which gives the desired non-negative solution. \square

Corollary 5.1: Let $N (>1)$ be a fixed number. Then,

(1) The Diophantine equation $x^2 - N = 1$ has no (positive) integer solution x ,

(2) The Diophantine equation $N - y^2 = 1$ has no (positive) integer solution y .

Theorem 5.1 : For any $n \geq 1$, none of $\text{SPS}_1(n)$ and $\text{SPS}_2(n)$ is a square of an integer (>1).

Proof : If possible, let

$$\text{SPS}_1(n) \equiv (n!)^2 + 1 = x^2 \text{ for some integers } n \geq 1, x > 1.$$

But, by Corollary 5.1(1), this Diophantine equation has no integer solution x .

Again, if

$$\text{SPS}_2(n) \equiv (n!)^2 - 1 = y^2 \text{ for some integers } n \geq 1, y > 1,$$

then, by Corollary 5.1(2), this Diophantine equation has no integer solution y .

All these complete the proof of the theorem. \square

In Theorem 5.2, we prove a stronger result, for which we need the results below.

Lemma 5.2 : Let $m (\geq 2)$ be a fixed integer. Then, the only non-negative integer solution of the Diophantine equation $x^2 + 1 = y^m$ is $x=0, y=1$.

Proof : For $m=2$, the result follows from Lemma 5.1. So, it is sufficient to consider the case when $m > 2$. However, we note that it is sufficient to consider the case when m is odd; if m is even, say, $m=2q$ for some integer $q > 1$, then rewriting the given Diophantine equation as $(y^q)^2 - x^2 = 1$, we see that, by Lemma 5.1, the only non-negative integer solution is $y^q=1, x=0$, that is $x=0, y=1$, as required.

So, let m be odd, say, $m=2q+1$ for some integer $q \geq 1$. Then, the given Diophantine equation can be written as

$$x^2 = y^{2q+1} - 1 = (y-1)(y^{2q} + y^{2q-1} + \dots + 1). \quad (***)$$

From (***), we see that $x=0$ if and only if $y=1$, since $y^{2q} + y^{2q-1} + \dots + 1 > 0$.

Now, if $x \neq 0$, from (***), the only two possibilities are

$$(1) \ y-1=x, \ y^{2q} + y^{2q-1} + \dots + 1 = x.$$

But then $y=x+1$, and we are led to the equation $(x+1)^{2q} + (x+1)^{2q-1} + \dots + (x+1)^2 + 2 = 0$, which is impossible.

$$(2) y-1=1, y^{2q}+y^{2q-1}+\dots+1=x^2.$$

Then, $y=2$ together with the equation

$$x^2=2^{2q+1}-1. \quad (5.1)$$

But the equation (5.1) has no integer solution $x (>1)$. To prove this, we first note that any integer x satisfying (5.1) must be odd. Now rewriting (5.1) in the following equivalent form

$$(x-1)(x+1)=2(2^q-1)(2^q+1),$$

we see that the l.h.s. is divisible by 4, while the r.h.s. is not divisible by 4 since both 2^q-1 and 2^q+1 are odd.

Thus, if $x \neq 0$, then we reach to a contradiction in either of the above cases. This contradiction establishes the lemma. \square

Corollary 5.2 : Let $m (\geq 2)$ and $N (>0)$ be two fixed integers. Then, the Diophantine equation $N^2+1=y^m$ has no integer solution y .

Corollary 5.3 : Let $m (\geq 2)$ and $N (>1)$ be two fixed integers. Then, the Diophantine equation $x^2+1=N^m$ has no (positive) integer solution x .

Lemma 5.3 : Let $m (\geq 2)$ be a fixed integer. Then, the only non-negative integer solutions of the Diophantine equation $x^2-y^m=1$ are (1) $x=1, y=0$; (2) $x=3, y=2, m=3$.

Proof : For $m=2$, the lemma reduces to Lemma 5.1. So we consider the case when $m \geq 3$.

From the given Diophantine equation, we see that, $y=0$ if and only if $x=\pm 1$, giving the only non-negative integer solution $x=1, y=0$. To see if the given Diophantine equation has any non-zero integer solution, we assume that $x \neq 1$.

If m is even, say, $m=2q$ for some integer $q \geq 1$, then $x^2-y^m \equiv x^2-(y^q)^2=1$, which has no integer solution y for any $x > 1$ (by Corollary 5.1(2)).

Next, let m be odd, say, $m=2q+1$ for some integer $q \geq 1$. Then, $x^2-y^{2q+1}=1$, that is,

$$(x-1)(x+1)=y^{2q+1}.$$

We now consider the following cases that may arise :

$$(1) x-1=1, x+1=y^{2q+1}.$$

Here, $x=2$ together with the equation $y^{2q+1}=3$, which has no integer solution y .

$$(2) x-1=y, x+1=y^{2q}.$$

Rewriting the second equation in the equivalent form $(y^q-1)(y^q+1)=x$, we see that $(y^q+1) \mid x$.

But this contradicts the first equation $x=y+1$ if $q > 1$, since for $q > 1$, $y^q+1 > y+1=x$.

If $q=1$, then

$$(y-1)(y+1)=x \Rightarrow y-1=1, y+1=x,$$

so that $y=2, x=3, m=3$, which is a solution of the given Diophantine equation.

$$(3) x-1=y^t \text{ for some integer } t \text{ with } 2 \leq t \leq q, q \geq 2 \text{ (so that } x+1=y^{2q-t+1}).$$

In this case, we have

$$2x=y^t[1+y^{2(q-t)+1}].$$

Since x does not divide y , it follows that

$$1+y^{2(q-t)+1}=Cx \text{ for some integer } C \geq 1.$$

Thus,

$$2x=y^t(Cx) \Rightarrow Cy^t=2.$$

If $C=2$, then $y=1$, and the resulting equation $x^2=2$ has no integer solution. On the other hand, if $C \neq 2$, the equation $Cy^t=2$ has no integer solution. Thus, case (3) cannot occur.

All these complete the proof of the lemma. \square

Corollary 5.4 : The only non-negative integer solution of the Diophantine equation $x^2-y^3=1$ is $x=3, y=2$.

Corollary 5.5 : Let $m (>3)$ be a fixed integer. Then, the Diophantine equation $x^2-y^m=1$ has $x=1, y=0$ as its only non-negative integer solution.

Corollary 5.6 : Let $m (>3)$ and $N (>0)$ be two fixed integers. Then, the Diophantine equation $x^2 - N^m = 1$ has no integer solution x .

Corollary 5.7 : Let $m (\geq 3)$ and $N (>1)$ be two fixed integers with $N \neq 3$. Then, the Diophantine equation $N^2 - y^m = 1$ has no integer solution.

We are now in a position to prove the following theorem.

Theorem 5.2 : For any $n \geq 1$, none of the $SPS_1(n)$ and $SPS_2(n)$ is a cube or higher power of an integer (>1).

Proof : is by contradiction. Let, for some integer $n \geq 1$,

$$SPS_1(n) \equiv (n!)^2 + 1 = y^m \text{ for some integers } y > 1, m \geq 3.$$

By Corollary 5.2, the above equation has no integer solution y .

Again, if for some integer $n \geq 1$,

$$SPS_2(n) \equiv (n!)^2 - 1 = z^s \text{ for some integer } z \geq 1, s \geq 3,$$

we have contradiction to Corollary 5.7. \square

The following result gives the recurrence relations satisfied by $SPS_1(n)$ and $SPS_2(n)$.

Lemma 5.4 : For all $n \geq 1$,

$$(1) SPS_1(n+1) = (n+1)^2 SPS_1(n) - n(n+2),$$

$$(2) SPS_2(n+1) = (n+1)^2 SPS_2(n) + n(n+2).$$

Proof : The proof is for part (1) only. Since

$$SPS_1(n+1) = [(n+1)!]^2 + 1 = (n+1)^2 [(n!)^2 + 1] - (n+1)^2 + 1,$$

the result follows. \square

Lemma 5.5 : For all $n \geq 1$,

$$(1) SPS_1(n+2) - SPS_1(n) > SPS_1(n+1),$$

$$(2) SPS_2(n+2) - SPS_2(n) > SPS_2(n+1).$$

Proof : Using Lemma 5.4, it is straightforward to prove that

$$SPS_1(n+2) - SPS_1(n) = SPS_2(n+2) - SPS_2(n) = (n!)^2 [(n+1)^2 (n+2)^2 - 1].$$

Some algebraic manipulations give the desired inequalities. \square

Lemma 5.5 can be used to prove the following results.

Theorem 5.3 : (Except for the trivial cases, $SPS_1(1) = 2 = F(3) = L(0)$, $SPS_1(2) = 5 = F(5)$) there are no numbers of the Smarandache square product sequence of the first kind that are Fibonacci (or Lucas) numbers.

Theorem 5.4 : (Except for the trivial cases, $SPS_2(1) = 0 = F(0)$, $SPS_2(2) = 3 = F(4) = L(2)$) there are no numbers of the Smarandache square product sequence of the second kind that are Fibonacci (or Lucas) numbers.

The question raised by Iacobescu [11] is : How many terms of the sequence $\{SPS_1(n)\}_{n=1}^{\infty}$ are prime?

The following theorem, due to Le [12], gives a partial answer to the above question.

Theorem 5.5 : If $n (>2)$ is an even integer such that $2n+1$ is prime, then $SPS_1(n)$ is not a prime.

Russo [3] gives tables of values of $SPS_1(n)$ and $SPS_2(n)$ for $1 \leq n \leq 20$. Based on computer results, Russo [3] conjectures that each of the sequences $\{SPS_1(n)\}_{n=1}^{\infty}$ and $\{SPS_2(n)\}_{n=1}^{\infty}$ contains only a finite number of primes.

6. SMARANDACHE HIGHER POWER PRODUCT SEQUENCES $\{HPPS_1(n)\}_{n=1}^{\infty}$, $\{HPPS_2(n)\}_{n=1}^{\infty}$

The n -th terms of the Smarandache higher power product sequences are given in (1.5). The following lemma gives the recurrence relation satisfied by $HPPS_1(n)$ and $HPPS_2(n)$.

Lemma 6.1 : For all $n \geq 1$,

(1) $HPPS_1(n+1) = (n+1)^m HPPS_1(n) - [(n+1)^m + 1]$,

(2) $HPPS_2(n+1) = (n+1)^m HPPS_2(n) + [(n+1)^m + 1]$.

Theorem 6.1: For any integer $n \geq 1$, none of $HPPS_1(n)$ and $HPPS_2(n)$ is a square of an integer (>1).

Proof : If possible, let

$$HPPS_1(n) \equiv (n!)^m + 1 = x^2 \text{ for some integer } x > 1.$$

This leads to the Diophantine equation $x^2 - (n!)^m = 1$, which has no integer solution x , by virtue of Corollary 5.6 (for $m > 3$). Thus, if $m > 3$, $HPPS_1(n)$ cannot be a square of a natural number (>1) for any $n \geq 1$.

Next, let, for some integer $n \geq 2$ ($HPPS_2(1) = 0$)

$$HPPS_2(n) \equiv (n!)^m - 1 = y^2 \text{ for some integer } y \geq 1.$$

Then, we have the Diophantine equation $y^2 + 1 = (n!)^m$, and by Corollary 5.3, it has no integer solution y . Thus, $HPPS_2(n)$ cannot be a square of an integer (>1) for any $n \geq 1$. \square

The following two theorems are due to Le [13,14].

Theorem 6.2: If m is not a number of the form 2^ℓ for some $\ell \geq 1$, then the sequence $\{HPPS_1(n)\}_{n=1}^\infty$ contains only one prime, namely, $HPPS_1(1) = 2$.

Theorem 6.3: If both m and $2^m - 1$ are primes, then the sequence $\{HPPS_2(n)\}_{n=1}^\infty$ contains only one prime, $HPPS_2(2) = 2^m - 1$; otherwise, the sequence does not contain any prime.

Remark 6.1 : We have defined the Smarandache higher power product sequences under the restriction that $m > 3$, and under such restriction, as has been proved in Theorem 6.1, none of $HPPS_1(n)$ and $HPPS_2(n)$ is a square of an integer (>1) for any $n \geq 1$. However, if $m = 3$, the situation is a little bit different : For any $n \geq 1$, $HPPS_2(n) = (n!)^3 - 1$ still cannot be a perfect square of an integer (>1), by virtue of Corollary 5.3, but since $HPPS_1(n) = (n!)^3 + 1$, we see that $HPPS_1(2) = (2!)^3 + 1 = 3^2$, that is, $HPPS_1(2)$ is a perfect square. However, this is the only term of the sequence $\{HPPS_1(n)\}_{n=1}^\infty$ that can be expressed as a perfect square.

7. SMARANDACHE PERMUTATION SEQUENCE $\{PS(n)\}_{n=1}^\infty$

For the Smarandache permutation sequence, given in (1.6), the question raised (Dumitrescu and Seleacu [4]) is : *Is there any perfect power among these numbers?*

Smarandache conjectures that there are none. In Theorem 7.1, we prove the conjecture in the affirmative. To prove the theorem, we need the following results.

Lemma 7.1 : For $n \geq 2$, $PS(n)$ is of the form $2(2k+1)$ for some integer $k > 1$.

Proof : Since for $n \geq 2$,

$$PS(n) = \overline{135 \dots (2n-1)(2n)(2n-2) \dots 42}, \tag{7.1}$$

we see that $PS(n)$ is even and after division by 2, the last digit of the quotient is 1. \square

An immediate consequence of the above lemma is the following.

Corollary 7.1 : For $n \geq 2$, $2^\ell \mid PS(n)$ if and only if $\ell = 1$.

Theorem 7.1: For $n \geq 1$, $PS(n)$ is not a perfect power.

Proof : The result is clearly true for $n = 1$, since $PS(1) = 3 \times 2^2$ is not a perfect power. The proof for the case $n \geq 2$ is by contradiction.

Let, for some integer $n \geq 2$,

$$PS(n) = x^\ell \text{ for some integers } x > 1, \ell \geq 2.$$

Since $PS(n)$ is even, so is x . Let $x = 2y$ for some integer $y > 1$. Then,

$$PS(n) = (2y)^\ell = 2^\ell y^\ell,$$

which shows that $2^\ell \mid PS(n)$, contradicting Corollary 7.1. \square

To get more insight into the numbers of the Smaradache permutation sequence, we define a new sequence, called the *reverse even sequence*, and denoted by $\{\text{RES}(n)\}_{n=1}^{\infty}$, as follows :

$$\text{RES}(n) = \overline{(2n)(2n-2)\dots 42}, n \geq 1. \quad (7.2)$$

A first few terms of the sequence are

$$2, 42, 642, 8642, 108642, 12108642, \dots$$

We note that, for all $n \geq 1$,

$$\begin{aligned} \text{RES}(n+1) &= \overline{(2n+2)(2n)(2n-2)\dots 42} \\ &= (2n+2)10^s + \text{RES}(n) \text{ for some integer } s \geq n, \end{aligned} \quad (7.3)$$

where, more precisely,

$$s = \text{number of digits in RES}(n).$$

Thus, for example,

$$\text{RES}(4) = 8 \times 10^3 + \text{RES}(3), \text{RES}(5) = 10 \times 10^4 + \text{RES}(4), \text{RES}(6) = 12 \times 10^6 + \text{RES}(5).$$

Lemma 7.2 : For all $n \geq 1$, $4 \mid [\text{RES}(n+1) - \text{RES}(n)]$.

Proof : Since from (7.3),

$$\text{RES}(n+1) - \text{RES}(n) = (2n+2)10^s \text{ for some integer } s (\geq n \geq 1),$$

the result follows. \square

Lemma 7.3 : The numbers of the reverse even sequence are of the form $2(2k+1)$ for some integer $k \geq 0$.

Proof : The proof is by induction on n . The result is true for $n=1$. So, we assume that the result is true for some n , that is,

$$\text{RES}(n) = 2(2k+1) \text{ for some integer } k \geq 0.$$

But, by virtue of Lemma 7.2,

$$\text{RES}(n+1) - \text{RES}(n) = 4k' \text{ for some integer } k' > 0,$$

which, together with the induction hypothesis, gives,

$$\text{RES}(n+1) = 4k' + \text{RES}(n) = 4(k+k') + 2.$$

Thus, the result is true for $n+1$ as well, completing the proof. \square

Lemma 7.4 : $3 \mid \text{RES}(3n)$ if and only if $3 \mid \text{RES}(3n-1)$.

Proof : Since,

$$\text{RES}(3n) = (6n)10^s + \text{RES}(3n-1) \text{ for some integer } s \geq n,$$

the result follows. \square

By repeated application of (7.3), we get successively

$$\begin{aligned} \text{RES}(n+3) &= (2n+6)10^s + \text{RES}(n+2) \text{ for some integer } s \geq n+2 \\ &= (2n+6)10^s + (2n+4)10^t + \text{RES}(n+1) \text{ for some integer } t \geq n+1 \\ &= (2n+6)10^s + (2n+4)10^t + (2n+2)10^u + \text{RES}(n) \text{ for some integer } u \geq n, \end{aligned} \quad (7.4)$$

so that,

$$\text{RES}(n+3) - \text{RES}(n) = (2n+6)10^s + (2n+4)10^t + (2n+2)10^u, \quad (7.5)$$

where $s > t > u \geq n \geq 1$.

Lemma 7.5 : $3 \mid [\text{RES}(n+3) - \text{RES}(n)]$ for all $n \geq 1$.

Proof : is evident from (7.5), since

$$\begin{aligned} &3 \mid (2n+6)10^s + (2n+4)10^t + (2n+2)10^u \\ &= 10^u [(2n+6)(10^{s-u} + 10^{t-u} + 1) - 2(10^{s-u} + 2)]. \quad \square \end{aligned}$$

Corollary 7.2 : $3 \mid \text{RES}(3n)$ for all $n \geq 1$.

Proof : The result is true for $n=1$, since $\text{RES}(3)=642$ is divisible by 3. Now, assuming the validity of the result for n , so that $3 \mid \text{RES}(3n)$, we get, from Lemma 7.5, $3 \mid \text{RES}(3n+3)=\text{RES}(3(n+1))$, so that the result is true for $n+1$ as well.

This completes the proof by induction. \square

Corollary 7.3 : $3 \mid \text{RES}(3n-1)$ for all $n \geq 1$.

Proof : follows from Lemma 7.4, together with Corollary 7.2. \square

Corollary 7.4 : For any $n \geq 0$, $3 \nmid \text{RES}(3n+1)$.

Proof : Clearly, the result is true for $n=0$. For $n \geq 1$, from (7.3),

$$\text{RES}(3n+1)=(6n+2)10^s+\text{RES}(3n) \text{ for some integer } s \geq 3n.$$

Now, $3 \mid \text{RES}(3n)$ (by Corollary 7.2) but $3 \nmid (6n+2)$. Hence the result. \square

Using (7.4), we that, for all $n \geq 1$,

$$\begin{aligned} & \text{RES}(n+2)-\text{RES}(n) \\ &= [\text{RES}(n+2)-\text{RES}(n+1)] + [\text{RES}(n+1)-\text{RES}(n)] \\ &= [(2n+4)10^t - 1] \text{RES}(n+1) + [(2n+2)10^u - 1] \text{RES}(n), \end{aligned} \quad (7.6)$$

where t and u are integers with $t > u \geq n+1$.

From (7.6), we get the following result.

Lemma 7.6 : $\text{RES}(n+2)-\text{RES}(n) > \text{RES}(n+1)$ for all $n \geq 1$.

$\text{PS}(n)$, given by (7.1), can now be expressed in terms of $\text{OS}(n)$ and $\text{RES}(n)$ as follows : For any $n \geq 1$,

$$\text{PS}(n)=10^s \text{OS}(n)+\text{RES}(n) \text{ for some integer } s \geq n, \quad (7.7)$$

where, more precisely,

$$s = \text{number of digits in } \text{RES}(n).$$

From (7.7), we observe that, for $n \geq 2$, (since $4 \mid 10^s$ for $s \geq n \geq 2$), $\text{PS}(n)$ is of the form $4k+2$ for some integer $k > 1$, since by Lemma 7.3, $\text{RES}(n)$ is of the same form. This provides an alternative proof of Lemma 7.1.

Lemma 7.7 : $3 \mid \text{PS}(3n)$ for all $n \geq 1$.

Proof : follows by virtue of Lemma 2.2 and Corollary 7.2, since

$$\text{PS}(3n)=10^s \text{OS}(3n)+\text{RES}(3n) \text{ for some integer } s \geq 3n. \quad \square$$

Lemma 7.8 : $3 \mid \text{PS}(n)$ if and only if $3 \mid \text{PS}(n+3)$.

Proof : follows by virtue of Lemma 2.1 and Lemma 7.5. \square

Lemma 7.9 : $3 \mid \text{PS}(3n-2)$ for all $n \geq 1$.

Proof : Since $3 \mid \text{PS}(1)=12$, the result is true for $n=1$. To prove by induction, we assume that the result is true for some n , that is, $3 \mid \text{PS}(3n-2)$. But, then, by Lemma 7.8, $3 \mid \text{PS}(3n-1)$, showing that the result is true for $n+1$ as well. \square

Lemma 7.10 : For all $n \geq 1$, $\text{PS}(n+2)-\text{PS}(n) > \text{PS}(n+1)$.

Proof : Since

$$\text{PS}(n+2)=10^s \text{OS}(n+2)+\text{RES}(n+2) \text{ for some integer } s \geq n+2,$$

$$\text{PS}(n+1)=10^t \text{OS}(n+1)+\text{RES}(n+1) \text{ for some integer } t \geq n+1,$$

$$\text{PS}(n)=10^u \text{OS}(n)+\text{RES}(n) \text{ for some integer } u \geq n,$$

where $s > t > u$, we see that

$$\begin{aligned} \text{PS}(n+2)-\text{PS}(n) &= [10^s \text{OS}(n+2)-10^u \text{OS}(n)] + [\text{RES}(n+2)-\text{RES}(n)] \\ &> 10^s [\text{OS}(n+2)-\text{OS}(n)] + [\text{RES}(n+2)-\text{RES}(n)] \\ &> 10^t \text{OS}(n+1) + \text{RES}(n+1) = \text{PS}(n+1), \end{aligned}$$

where the last inequality follows by virtue of (2.4), Lemma 7.6 and the fact that $10^s > 10^t$. \square

Lemma 7.10 can be used to prove the following result.

Theorem 7.1 : There are no numbers in the Smarandache permutation sequence that are Fibonacci (or, Lucas) numbers.

Remark 7.1 : The result given in Theorem 7.1 has also been proved by Le [15]. Note that

$PS(2)=1342=11 \times 122$, $PS(3)=135642=111 \times 1222$, $PS(4)=13578642=1111 \times 12222$, as has been pointed out by Zhang [16]. However, such a representation of $PS(n)$ is not valid for $n \geq 5$. Thus, the theorem of Zhang [16] holds true only for $1 \leq n \leq 4$ (and not for $1 \leq n \leq 9$).

8. SMARANDACHE CONSECUTIVE SEQUENCE $\{CS(n)\}_{n=1}^{\infty}$

The Smarandache consecutive sequence is obtained by repeatedly concatenating the positive integers, and the n -th tem of the sequence is given by (1.7).

Since

$$CS(n+1)=\overline{123\dots(n-1)n(n+1)}, n \geq 1,$$

we see that, for all $n \geq 1$,

$$CS(n+1)=10^s CS(n)+(n+1) \text{ for some integer } s \geq 1, CS(1)=1. \quad (8.1)$$

More precisely,

$$s = \text{number of digits in } (n+1).$$

Thus, for example, $CS(9)=10 CS(8)+9$, $CS(10)=10^2 CS(9)+10$.

From (8.1), we get the following result :

Lemma 8.1 : For all $n \geq 1$, $CS(n+1)-CS(n) > 9 CS(n)$.

Using Lemma 8.1, we get, following the proof of (2.1),

$$CS(n+2)-CS(n) > 9[CS(n+1)+CS(n)] \text{ for all } n \geq 1. \quad (8.2)$$

Thus,

$$CS(n+2)-CS(n) > CS(n+1), n \geq 1. \quad (8.3)$$

Based on computer search for Fibonacci (and Lucas) numbers from 12 up through $CS(2999)=123\dots29982999$, Asbacher [1] conjectures that (except for the trivial case, $CS(1)=1=F(1)=L(1)$) there are no Fibonacci (and Lucas) numbers in the Smarandache consecutive sequence. The following theorem confirms the conjectures of Ashbacher.

Theorem 8.1 : There are no Fibonacci (and Lucas) numbers in the Smarandache consecutive sequence (except for the trivial cases of $CS(1)=1=F(1)=F(2)=L(1)$, $CS(3)=123=L(10)$).

Proof : is evident from (8.3). \square

Remark 8.1 : As has been pointed out by Ashbacher [1], $CS(3)$ is a Lucas number. However, $CS(3) \neq CS(2)+CS(1)$.

Lemma 8.2 : Let $3 \mid n$. Then, $3 \mid CS(n)$ if and only if $3 \mid CS(n-1)$.

Proof : follows readily from (8.1). \square

By repeated application of (8.1), we get,

$$\begin{aligned} CS(n+3) &= 10^s CS(n+2)+(n+3) \text{ for some integer } s \geq 1 \\ &= 10^s [10^t CS(n+1)+(n+2)]+(n+3) \text{ for some integer } t \geq 1 \\ &= 10^{s+t} [10^u CS(n)+(n+1)]+(n+2)10^s+(n+3) \text{ for some integer } u \geq 1 \\ &= 10^{s+t+u} CS(n)+(n+1)10^{s+t}+(n+2)10^s+(n+3), \end{aligned} \quad (8.4)$$

where $s \geq t \geq u \geq 1$.

Lemma 8.3 : $3 \mid CS(n)$ if and only if $3 \mid CS(n+3)$.

Proof : follows from (8.4), since

$$3 \mid [(n+1)10^{s+t}+(n+2)10^s+(n+3)] = [(n+1)(10^{s+t}+10^s+1)+(10^s+2)]. \quad \square$$

Lemma 8.4 : $3 \mid CS(3n)$ for all $n \geq 1$.

Proof : The proof is by induction on n . The result is clearly true for $n=1$, since $3 \mid CS(3)=123$. So, we assume that the result is true for some n , that is, we assume that $3 \mid CS(3n)$ for some n . But then, by Lemma 8.4, $3 \mid CS(3n+3)=CS(3(n+1))$, showing that the result is true for $n+1$ as well, completing induction. \square

Corollary 8.1 : $3 \mid CS(3n-1)$ for all $n \geq 1$.

Proof : From (8.1), for $n \geq 1$,

$$CS(3n)=10^s CS(3n-1)+(3n) \text{ for some integer } s \geq 1.$$

Since, by Lemma 8.4, $3 \mid CS(3n)$, the result follows. \square

Corollary 8.2 : $3 \nmid CS(3n+1)$ for all $n \geq 0$.

Proof : For $n=0$, $CS(1)=1$ is not divisible by 3. For $n \geq 1$, from (8.1),

$$CS(3n+1)=10^s CS(3n)+(3n+1),$$

where, by Lemma 8.4, $3 \mid CS(3n)$. Since $3 \nmid (3n+1)$, we get desired the result. \square

Lemma 8.5 : For any $n \geq 1$, $5 \mid CS(5n)$.

Proof : For $n \geq 1$, from (8.1),

$$CS(5n)=10^s CS(5n-1)+(5n) \text{ for some integer } s \geq 1.$$

Clearly, the r.h.s. is divisible by 5. Hence, $5 \mid CS(5n)$. \square

For the Smarandache consecutive sequence, the question is : How many terms of the sequence are prime? Fleuren [17] gives a table of prime factors of $CS(n)$ for $n=1(1)200$, which shows that none of these numbers is prime. In the Editorial Note following the paper of Stephan [18], it is mentioned that, using a supercomputer, no prime has been found in the first 3,072 terms of the Smarandache consecutive sequence. This gives rise to the conjecture that there is no prime in the Smarandache consecutive sequence. This conjecture still remains to be resolved. We note that, in order to check for prime numbers in the Smarandache consecutive sequence, it is sufficient to check the terms of the form $CS(3n+1)$, $n \geq 1$, where $3n+1$ is odd and is not divisible by 5.

9. SMARANDACHE REVERSE SEQUENCE $\{RS(n)\}_{n=1}^{\infty}$

The Smarandache reverse sequence is the sequence of numbers formed by concatenating the increasing integers on the left side, starting with $RS(1)=1$. The n -th term of the sequence is given by (1.8).

Since,

$$RS(n+1)=\overline{(n+1)n(n-1)\dots 21}, n \geq 1,$$

we see that, for all, $n \geq 1$,

$$RS(n+1)=(n+1)10^s+RS(n) \text{ for some integer } s \geq n \text{ (with } RS(1)=1) \quad (9.1)$$

More precisely,

$$s = \text{number of digits in } RS(n).$$

Thus, for example,

$$RS(9)=9 \times 10^8 + RS(8), RS(10)=10 \times 10^9 + RS(9), RS(11)=11 \times 10^{11} + RS(10).$$

Lemma 9.1 : For all $n \geq 1$, $4 \mid [RS(n+1)-RS(n)]$, $10 \mid [RS(n+1)-RS(n)]$.

Proof : For all $n \geq 1$, from (9.1),

$$RS(n+1)-RS(n)=(n+1)10^s \text{ (with } s \geq n),$$

where the r.h.s. is divisible by both 4 and 10. \square

Corollary 9.1 : For all $n \geq 2$, the terms of $\{RS(n)\}_{n=1}^{\infty}$ are of the form $4k+1$.

Proof : The proof is by induction of n . For $n=2$, the result is clearly true ($RS(2)=21=4 \times 5+1$). So, we assume the validity of the result for n , that is, we assume that

$$RS(n)=4k+1 \text{ for integer } k \geq 1.$$

Now, by Lemma 9.1 and the induction hypothesis,

$$RS(n+1)=RS(n)+4k'=4(k+k')+1 \text{ for some integer } k' \geq 1,$$

showing that the result is true for $n+1$ as well. \square

Lemma 9.2 : Let $3 \mid n$ for some $n (\geq 2)$. Then, $3 \mid RS(n)$ if and only if $3 \mid RS(n-1)$.

Proof : follows immediately from (9.1). \square

By repeated application of (9.1), we get, for all $n \geq 1$,

$$\begin{aligned} RS(n+3) &= (n+3)10^s + RS(n+2) \text{ for some integer } s \geq n+2 \\ &= (n+3)10^s + (n+2)10^t + RS(n+1) \text{ for some integer } t \geq n+1 \\ &= (n+3)10^s + (n+2)10^t + (n+1)10^u + RS(n) \text{ for some integer } u \geq n, \end{aligned} \quad (9.2)$$

where $s > t > u$. Thus,

$$RS(n+3) = 10^u [(n+3)10^{s-u} + (n+2)10^{t-u} + (n+1)] + RS(n). \quad (9.3)$$

Lemma 9.3 : $3 \mid [RS(n+3) - RS(n)]$ for all $n \geq 1$.

Proof : is immediate from (9.3). \square

A consequence of Lemma 9.3 is the following.

Corollary 9.2 : $3 \mid RS(3n)$ if and only if $3 \mid RS(n+3)$.

Using Corollary 9.2, the following result can be established by induction on n .

Corollary 9.3 : $3 \mid RS(3n)$ for all $n \geq 1$.

Corollary 9.4 : $3 \mid RS(3n-1)$ for all $n \geq 1$.

Proof : follows from Corollary 9.3, together with Lemma 9.2. \square

Lemma 9.4 : $3 \nmid RS(3n+1)$ for all $n \geq 0$.

Proof : The result is true for $n=0$. For $n \geq 1$, by (9.1),

$$RS(3n+1) = (3n+1)10^s + RS(3n).$$

This gives the desired result, since $3 \mid RS(3n)$ but $3 \nmid (3n+1)$. \square

The following result, due to Alexander [19], gives an explicit expression for $RS(n)$:

$$RS(n) = 1 + \sum_{i=2}^{n-1} i \cdot 10^{\sum_{j=1}^{i-1} (1 + \lfloor \log j \rfloor)}$$

Lemma 9.5 : For all $n \geq 1$, $RS(n) = 1 + \sum_{i=2}^{n-1} i \cdot 10^{\sum_{j=1}^{i-1} (1 + \lfloor \log j \rfloor)}$

In Theorem 9.1, we prove that (except for the trivial cases of $RS(1)=1=F(1)=F(2)=L(1)$, $RS(2)=21=F(8)$), the Smarandache reverse sequence contains no Fibonacci and Lucas numbers. For the proof of the theorem, we need the following results.

Lemma 9.6 : For all $n \geq 1$, $RS(n+1) > 2RS(n)$.

Proof : Using (9.1), we see that

$$RS(n+1) = (n+1)10^s + RS(n) > 2RS(n) \text{ if and only if } RS(n) < (n+1)10^s,$$

which is true since $RS(n)$ is an s -digit number while 10^s is an $(s+1)$ -digit number. \square

Corollary 9.5 : For all $n \geq 1$, $RS(n+2) - RS(n) > RS(n+1)$.

Proof : Using (9.2), we have

$$\begin{aligned} RS(n+2) - RS(n) &= [RS(n+2) - RS(n+1)] + [RS(n+1) - RS(n)] \\ &= [(n+2)10^t - (n+1)10^u] + 2[RS(n+1) - RS(n)] \\ &> 2[RS(n+1) - RS(n)] \\ &> RS(n+1), \text{ by Lemma 9.6.} \end{aligned}$$

This gives the desired inequality. \square

Theorem 9.1: There are no numbers in the Smarandache reverse sequence that are Fibonacci or Lucas numbers (except for the cases of $n=1,2$).

Proof: follows from Corollary 9.5. \square

For the Smarandache reverse sequence, the question is : How many terms of the sequence are prime? By Corollary 9.2 and Corollary 9.3, in searching for primes, it is sufficient to consider the terms of the sequence of the form $RS(3n+1)$, where $n>1$. In the Editorial Note following the paper of Stephan [18], it is mentioned that searching for prime in the first 2,739 terms of the Smarandache reverse sequence revealed that only $RS(82)$ is prime. This led to the conjecture that $RS(82)$ is the only prime in the Smarandache reverse sequence. However, the conjecture still remains to be resolved. Fleuren [17] presents a table giving prime factors of $RS(n)$ for $n=1(1)200$, except for the cases $n=82,136,139,169$.

10. SMARANDACHE SYMMETRIC SEQUENCE $\{SS(n)\}_{n=1}^{\infty}$

The n -th term, $SS(n)$, of the Smarandache symmetric sequence is given by (1.9).

The numbers in the Smarandache symmetric sequence can be expressed in terms of the numbers of the Smarandache consecutive sequence and the Smarandache reverse sequence as follows : For all $n \geq 3$,

$$SS(n)=10^s CS(n-1)+RS(n-2) \text{ for some integer } s \geq 1, \quad (10.1)$$

with $SS(1)=1, SS(2)=11$, where more precisely,

$$s = \text{number of digits in } RS(n-2).$$

Thus, for example, $SS(3)=10 CS(2)+RS(1), SS(4)=10^2 CS(3)+RS(2)$.

Lemma 10.1 : $3 \mid SS(3n+1)$ for all $n \geq 1$.

Proof : Let $n (\geq 1)$ be any arbitrary but fixed number. Then, from (10.1),

$$SS(3n+1)=10^s CS(3n)+RS(3n-1).$$

Now, by Lemma 8.4, $3 \mid CS(3n)$, and by Corollary 9.4, $3 \mid RS(3n-1)$. Therefore, $3 \mid SS(3n+1)$.

Since n is arbitrary, the lemma is proved. \square

Lemma 10.2 : For any $n \geq 1$, (1) $3 \nmid SS(3n)$, (2) $3 \nmid SS(3n+2)$.

Proof : Using (10.1), we see that

$$SS(3n)=10^s CS(3n-1)+RS(3n-2), n \geq 1.$$

By Corollary 8.1, $3 \mid CS(3n-1)$, and by Lemma 9.4, $3 \nmid RS(3n-2)$. Hence, $SS(3n)$ cannot be divisible by 3.

Again, since

$$SS(3n+2)=10^s CS(3n+1)+RS(3n), n \geq 1,$$

and since $3 \nmid CS(3n+1)$ (by Corollary 8.2) and $3 \mid RS(3n)$ (by Corollary 9.3), it follows that $SS(3n+2)$ is not divisible by 3. \square

Using (8.3) and Corollary 9.5, we can prove the following lemma. The proof is similar to that used in proving Lemma 7.10, and is omitted here.

Lemma 10.3 : For all $n \geq 1$, $SS(n+2)-SS(n) > SS(n+1)$.

By virtue of the inequality in Lemma 10.3, we have the following.

Theorem 10.1 : (Except for the trivial cases, $SS(1)=1=F(1)=L(1), SS(2)=11=L(5)$), there are no members of the Smarandache symmetric sequence that are Fibonacci (or, Lucas) numbers.

The following lemma gives the expression of $SS(n+1)-SS(n)$ in terms of $CS(n)-CS(n-1)$.

Lemma 10.4 : $SS(n+1)-SS(n)=10^{s+t}[CS(n)-CS(n-2)]$ for all $n \geq 3$, where

$$s = \text{number of digits in } RS(n-2), s+t = \text{number of digits in } RS(n-1).$$

Proof : By (10.1), for $n \geq 3$,

$$SS(n) = 10^s CS(n-1) + RS(n-2), \quad SS(n+1) = 10^{s+t} CS(n) + RS(n-1),$$

so that

$$\begin{aligned} SS(n+1) - SS(n) &= 10^s [10^t CS(n) - CS(n-1)] + [RS(n-1) - RS(n-2)] \\ &= 10^s [10^t CS(n) - CS(n-1) + (n-1)] \quad (\text{by (9.1)}). \end{aligned} \quad (****)$$

But,

$$t = \begin{cases} 1, & \text{if } 2 \leq n-1 \leq 9 \\ m+1, & \text{if } 10^m \leq n-1 \leq 10^{m+1} - 1 \quad (\text{for all } m \geq 1) \end{cases} = \text{number of digits in } (n-1).$$

Therefore, by (8.1)

$$CS(n-1) = 10^t CS(n-2) + (n-1),$$

and finally, plugging this expression in (****), we get the desired result. \square

We observe that $SS(2) = 11$ is prime; the next eight terms of the Smarandache symmetric sequence are composite numbers and squares :

$$\begin{aligned} SS(3) &= 121 = 11^2, & SS(4) &= 12321 = (3 \times 37)^2 = 111^2, \\ SS(5) &= 1234321 = (11 \times 101)^2 = 1111^2, & SS(6) &= 123454321 = (41 \times 271)^2 = 11111^2, \\ SS(7) &= 12345654321 = (3 \times 7 \times 11 \times 13 \times 37)^2 = 111111^2, \\ SS(8) &= 1234567654321 = (239 \times 4649)^2 = 1111111^2, \\ SS(9) &= 123456787654321 = (11 \times 1010101)^2 = 11111111^2, \\ SS(10) &= 12345678987654321 = (9 \times 37 \times 333667)^2 = (111 \times 1001001)^2 = 111111111^2. \end{aligned}$$

For the Smarandache symmetric sequence, the question is : How many terms of the sequence are prime? The question still remains to be answered.

11. SMARANDACHE PIERCED CHAIN SEQUENCE $\{PCS(n)\}_{n=1}^{\infty}$

In this section, we give answer to the question posed by Smarandache [5] by showing that, starting from the second term, all the successive terms of the sequence $\{PCS(n)/101\}_{n=1}^{\infty}$, given by (1.11), are composite numbers. This is done in Theorem 11.1 below.

We first observe that the elements of the Smarandache pierced chain sequence, $\{PCS(n)\}_{n=1}^{\infty}$, satisfy the following recurrence relation :

$$PCS(n+1) = 10^4 PCS(n) + 101, \quad n \geq 2; \quad PCS(1) = 101. \quad (11.1)$$

Lemma 11.1 : The elements of the sequence $\{PCS(n)\}_{n=1}^{\infty}$ are

$$101, 101(10^4+1), 101(10^8+10^4+1), 101(10^{12}+10^8+10^4+1), \dots,$$

and in general,

$$PCS(n) = 101[10^{4(n-1)} + 10^{4(n-2)} + \dots + 10^4 + 1], \quad n \geq 1. \quad (11.2)$$

Proof : The proof of (11.2) is by induction on n . The result is clearly true for $n=1$. So, we assume that the result is true for some n .

Now, from (11.1) together with the induction hypothesis, we see that

$$\begin{aligned} PCS(n+1) &= 10^4 PCS(n) + 101 \\ &= 10^4 [101(10^{4(n-1)} + 10^{4(n-2)} + \dots + 10^4 + 1)] + 101 \\ &= 101(10^{4n} + 10^{4(n-1)} + \dots + 10^4 + 1), \end{aligned}$$

which shows that the result is true for $n+1$. \square

It has been mentioned in Ashbacher [1] that $PCS(n)$ is divisible by 101 for all $n \geq 1$, and Lemma 11.1 shows that this is indeed the case. Another consequence of Lemma 11.1 is the following corollary.

Corollary 11.1 : The elements of the sequence $\{PCS(n)/101\}_{n=1}^{\infty}$ are
 $1, x+1, x^2+x+1, x^3+x^2+x+1, \dots,$

and in general,

$$PCS(n)/101 = x^{n-1} + x^{n-2} + \dots + 1, n \geq 1, \quad (11.3)$$

where $x \equiv 10^4$.

Theorem 11.1 : For all $n \geq 2$, $PCS(n)/101$ is a composite number.

Proof : The result is true for $n=2$. In fact, the result is true if n is even as shown below : If n (≥ 4) is even, let $n=2m$ for some integer m (≥ 2). Then, from (11.3),

$$\begin{aligned} PCS(2m)/101 &= x^{2m-1} + x^{2m-2} + \dots + x + 1 \\ &= x^{2m-2}(x+1) + \dots + (x+1) \\ &= (x+1)(x^{2m-2} + x^{2m-4} + \dots + 1) \end{aligned}$$

that is, $PCS(2m)/101 = (10^4+1)[10^{8(m-1)} + 10^{8(m-2)} + \dots + 1]$, (11.4)

which shows that $PCS(2m)/101$ is a composite number for all m (≥ 2).

Next, we consider the case when n is prime, say $n=p$, where p (≥ 3) is a prime. In this case, from (11.3),

$$PCS(p)/101 = x^{p-1} + x^{p-2} + \dots + 1 = (x^p - 1)/(x - 1).$$

Let $y = 10^2$ (so that $x = y^2$). Then,

$$\begin{aligned} \frac{PCS(p)}{101} &= \frac{x^p - 1}{x - 1} = \frac{y^{2p} - 1}{y^2 - 1} = \frac{(y^p - 1)(y^p + 1)}{(y + 1)(y - 1)} \\ &= \frac{\{(y - 1)(y^{p-1} + y^{p-2} + \dots + 1)\} \{(y + 1)(y^{p-1} - y^{p-2} + \dots + 1)\}}{(y + 1)(y - 1)} \\ &= \frac{(y^{p-1} - y^{p-2} + y^{p-3} - \dots + 1)(y^{p-1} + y^{p-2} + y^{p-3} + \dots + 1)}{(y + 1)(y - 1)} \end{aligned}$$

that is, $PCS(p)/101 = [10^{2(p-1)} - 10^{2(p-2)} + 10^{2(p-3)} + \dots + 1][10^{2(p-1)} + 10^{2(p-2)} + \dots + 1]$, (11.5)

so that $PCS(p)/101$ is a composite number for each prime p (≥ 3).

Finally, we consider the case when n is odd but composite. Then, letting $n=pr$ where p is the largest prime factor of n and r (≥ 2) is an integer, we see that

$$\begin{aligned} PCS(n)/101 &= PCS(pr)/101 \\ &= x^{pr-1} + x^{pr-2} + \dots + 1 \\ &= x^{p(r-1)}(x^{p-1} + x^{p-2} + \dots + 1) + x^{p(r-2)}(x^{p-1} + x^{p-2} + \dots + 1) + \dots \\ &\quad + (x^{p-1} + x^{p-2} + \dots + 1) \\ &= (x^{p-1} + x^{p-2} + \dots + 1)[x^{p(r-1)} + x^{p(r-2)} + \dots + 1] \end{aligned}$$

that is, $PCS(n)/101 = [10^{4(p-1)} + 10^{4(p-2)} + \dots + 1][10^{4p(r-1)} + 10^{4p(r-2)} + \dots + 1]$, (11.6)

and hence, $PCS(n)/101 = PCS(pr)/101$ is also a composite number.

All these complete the proof of the theorem. \square

Remark 11.1 : The Smarandache pierced chain sequence has been studied by Le [20] and Kashihara [21] as well. Following different approaches, they have proved by contradiction that for $n \geq 2$, $PCS(n)/101$ is not prime. In Theorem 11.1, we have proved the same result by actually finding out the factors of $PCS(n)/101$ for all $n \geq 2$. Kashihara [21] raises the question : Is the sequence $PCS(n)/101$ square-free for $n \geq 2$? From (11.4), (11.5) and (11.6), we see that the answer to the question of Kashihara is yes.

ACKNOWLEDGEMENT

The present work was done under a research grant from the Ritsumeikan Center for Asia-Pacific Studies of the Ritsumeikan Asia Pacific University. The authors gratefully acknowledge the financial support.

REFERENCES

- [1] Ashbacher, Charles. (1998) *Pluckings from the Tree of Smarandache Sequences and Functions*. American Research Press, Lupton, AZ, USA.
- [2] Smarandache, F. (1996) *Collected Papers–Volume II*. Tempus publishing House, Bucharest, Romania.
- [3] Russo, F. (2000) “Some Results about Four Smarandache U-Product Sequences”. *Smarandache Notions Journal*, **11**, pp. 42–49.
- [4] Dumitrescu, D. and V. Seleacu. (1994) *Some Notions and Questions in Number Theory*. Erhus University Press, Glendale.
- [5] Smarandache, F. (1990) *Only Problems, Not Solutions!* Xiquan Publishing House, Phoenix, Chicago.
- [6] Marimutha H. (1997) “Smarandache Concatenated Type Sequences”. *Bulletin of Pure and Applied Sciences*, **E16**, pp. 225–226.
- [7] Smith S. (2000) “A Set of Conjectures on Smarandache Sequences”. *Smarandache Notions Journal*, **11**, pp. 86–92.
- [8] Prakash, K. (1990) “A Sequence Free from Powers”. *Mathematical Spectrum*, **22(3)**, pp. 92–93.
- [9] Majumdar, A.A.K. (1996/7) “A Note on a Sequence Free from Powers”. *Mathematical Spectrum*, **29(2)**, pp. 41 (Letters to the Editor). Also, *Mathematical Spectrum*, **30(1)**, pp. 21 (Letters to the Editor).
- [10] Majumdar, A.A.K. (1998) “A Note on the Smarandache Prime Product Sequence”. *Smarandache Notions Journal*, **9**, pp. 137–142.
- [11] Iacobescu F. (1997) “Smarandache Partition Type Sequences”. *Bulletin of Pure and Applied Sciences*, **E16**, pp. 237–240.
- [12] Le M. (1998) “Primes in the Smarandache Square Product Sequence”. *Smarandache Notions Journal*, **9**, pp. 133.
- [13] Le M. (2001) “The Primes in the Smarandache Power Product Sequences of the First Kind”. *Smarandache Notions Journal*, **12**, pp. 230–231.
- [14] Le M. (2001) “The Primes in the Smarandache Power Product Sequences of the Second Kind”. *Smarandache Notions Journal*, **12**, pp. 228–229.
- [15] Le M. (1999) “Perfect Powers in the Smarandache Permutation Sequence”, *Smarandache Notions Journal*, **10**, pp. 148–149.
- [16] Zhang W. (2002) “On the Permutation Sequence and Its Some Properties”. *Smarandache Notions Journal*, **13**, pp. 153–154.
- [17] Fleuren, M. (1999) “Smarandache Factors and Reverse Factors”. *Smarandache Notions Journal*, **10**, pp. 5–38.
- [18] Stephan R.W. (1998) “Factors and Primes in Two Smarandache Sequences”. *Smarandache Notions Journal*, **9**, pp. 4–10.
- [19] Alexander S. (2001) “A Note on Smarandache Reverse Sequence”, *Smarandache Notions Journal*, **12**, pp. 250.
- [20] Le M. (1999) “On Primes in the Smarandache Pierced Chain Sequence”, *Smarandache Notions Journal*, **10**, pp. 154–155.
- [21] Kashihara, K. (1996) *Comments and Topics on Smarandache Notions and Problems*. Erhus University Press, AZ, U.S.A.

THE FULFILLED EUCLIDEAN PLANE

ADRIAN VASIU* ANGELA VASIU**

* MATH. DEPARTMENT "UNIVERSITY OF ARIZONA"

TUCSON, ARIZONA, U.S.A.

** MATH. DEPARTMENT, "BABEȘ-BOLYAI UNIVERSITY"

CLUJ-NAPOCA, ROMANIA

ABSTRACT. The fulfilled euclidean plane is the real projective plane $\bar{\Pi}$ completed with the infinite point of its infinite line denoted $\bar{\Pi}^c$. This new incidence structure is a structure with neighbouring elements, in which the unicity of the line through two distinct points is not assured. This new Geometry is a Smarandacheian structure introduced in [10] and [11], which generalizes and unites in the same time: Euclid, Bolyai Lobacewski Gauss and Riemann Geometries.

Key words: Non-euclidean Geometries, Hjelmslev-Barbilian Geometry, Smarandache Geometries, the fulfilled Euclidean plane.

1. HJELMSLEV-BARBILIAN INCIDENCE STRUCTURES

When the first Non-euclidean Geometry was introduced by Bolyai and Lobacewski even the great Gauss said that people were not prepared to receive a new Geometry. Now we know and accept many kinds of new Geometries. In 1969 Florentin Smarandache had put the problem to study a new Geometry in which the parallel from a point to a line to be unique only for some points of points and lines and for the others: none or more. More general: An axiom is said Smarandachely denied if the axiom behaves in at least two different ways within the same space (i.e., validated and invalided, or only invalided but in multiple distinct ways). Thus, a

Smarandache Geometry is a geometry which has at least one Smarandachely denied axiom.

Are nowadays people surprise for such new ideas and new Geometries? Certainly not. After the formalized theories were introduced in Mathematics, a lot of new Geometries could be accepted and semantically to be proved to be non-contradictory by the models created for them as in [1], [2], [3], [4], [5], [6], [8], [9], [12].

Definition 1.1. We consider $\mathcal{P}, \mathcal{D}, I$ the sets which verify:

$$(1) \quad \mathcal{P} \times \mathcal{D} = \emptyset$$

$$(2) \quad I \subset \mathcal{P} \times \mathcal{D}$$

The elements of \mathcal{P} are called points, the elements of \mathcal{D} are called lines and I defines an incidence relation on the set $\mathcal{P} \times \mathcal{D}$. $(\mathcal{P}, \mathcal{D}, I)$ is called an **incidence structure**.

If $(P, d) \in I$ we say that the point $P \in \mathcal{P}$ and the line $d \in \mathcal{D}$ are incident.

In the incidence structures introduced by D. Hilbert were accepted the axiom:

Axiom 1.1. $P_i \in \mathcal{P}, d_j \in \mathcal{D}, (P_i, d_j) \in I, i, j = 1, 2$ imply $P_1 = P_2$ or $d_1 = d_2$.

In [3] J. Hjelmslev generalized these incidence structures considering $(\mathcal{P}, \mathcal{D}, I)$ in which this axiom is denied, and the uniqueness of a line incident with two different points is not assured.

Definition 1.2. Two distinct points $P_1, P_2 \in \mathcal{P}$ of a $(\mathcal{P}, \mathcal{D}, I)$ are said to be **neighbouring**, denoted $P_1 \circ P_2$, if there are at least $d_1, d_2 \in \mathcal{D}, d_1 \neq d_2$ such that:

$$(3) \quad (P_i, d_j) \in I, \quad i, j = 1, 2.$$

An incidence structure $(\mathcal{P}, \mathcal{D}, I)$ with a neighbouring relation is denoted $(\mathcal{P}, \mathcal{D}, I, \circ)$.

D. Barbilian proved that such incidence structures are consistent, considering in [1] a Projective Geometry over a ring. Later such structures were studied in [2], [4], [5], [6], [8], [9], [12].

2. THE FULFILLED EUCLIDEAN PLANE

The mathematical model for the real projective plane $\bar{\Pi}$ is:

$$(4) \quad \mathcal{P}' := \{(\rho X, \rho Y, \rho Z) \mid X, Y, Z, \rho \in \mathbb{R}, \rho \neq 0\} \setminus \{(0, 0, 0)\}$$

where (X, Y, Z) are homogeneous coordinates for a point

$$(5) \quad \mathcal{D}' = \{[qa, qb, qc] \mid a, b, c, q \in \mathbb{R}, q \neq 0\} \setminus \{[0, 0, 0]\}$$

is the set of the lines of the $\bar{\Pi}$ plane.

The incidence between a point $M(X, Y, Z)$ and a line $[a, b, c]$ is defined through the condition

$$(6) \quad aX + bY + cZ = 0$$

The infinite line denoted through $[\infty]$ has the equations $[0, 0, 1]$ or:

$$(7) \quad Z = 0.$$

The infinite points of the $\bar{\Pi}$ plane have homogeneous coordinates of the type:

$$(8) \quad (X, Y, 0), \quad X^2 + Y^2 \neq 0$$

Let us observe that in $\bar{\Pi}$ any line has its infinite point - except the infinite line $[\infty]$. In this note we introduce it.

Definition 2.1. The infinite point of the infinite line $[\infty]$ is $U(0, 0, 0)$ (the unique point which were not considered in \mathcal{P}' in (4)).

From (6) and (8) we can see that $U(0, 0, 0)$ an infinite point incident with any line from \mathcal{D}' .

Definition 2.2. The real projective plane $\bar{\Pi}$ completed with the point $U(0, 0, 0)$ is called the completed real projective plane or the **fulfilled euclidean plane**, denoted $\bar{\Pi}^c$.

Definition 2.3. We denote $\mathcal{P}'' := \mathcal{P}' \cup \{(0, 0, 0)\}$ or $\mathcal{P}'' := \mathcal{P}' \cup \{U\}$. The incidence relation $I \subset \mathcal{P}' \times \mathcal{D}'$ now we prolonge it at I' , $I' \subset \mathcal{P}'' \times \mathcal{D}'$ such that:

$$(9) \quad I'|_{\mathcal{P}' \times \mathcal{D}'} = I$$

and

$$(10) \quad UI'a, \forall a \in \mathcal{D}'$$

3. THE INCIDENCE STRUCTURE WITH NEIGHBOURING OF ORDER k

Definition 3.1. In an incidence structure $(\mathcal{P}, \mathcal{D}, I, \circ)$ with neighbouring elements we define an **order of neighbouring** of two lines $d_i \in \mathcal{D}$, $i = 1, 2$. The lines d_1 and d_2 are called neighbouring of order k if there are exactly k distinct points incident with them, that is:

$$(11) \quad (d_i, P_j) \in I, \quad i = 1, 2, \quad j = 1, k$$

Definition 3.2. An incidence structure $(\mathcal{P}, \mathcal{D}, I, \circ)$ in which any two lines are neighbouring elements of order k is called a Hjlemslev Barbilian plane of order k .

Theorem 3.1. *The fulfilled euclidean plane $\bar{\Pi}^c$ is an incidence structure with neighbouring lines Hjlemslev Barbiliab of order two.*

Proof. Any two lines from $\bar{\Pi}$ are incident with exactly one point, $\bar{\Pi}$ being a projective plane. In $\bar{\Pi}^c$ any two lines are incident also with the point $U(0, 0, 0)$ which was not considered in $\bar{\Pi}$.

If two lines a and b from $\bar{\Pi}$ are incident with the P point, that is:

$$(12) \quad PIa, b$$

then in $\bar{\Pi}^c$ the lines a and b are incident with the two points P and U . Such we have:

$$(13) \quad P \circ U$$

that is – after definition 1.2 – P and U are neighbouring points.

The lines a and b of \mathcal{D}' are neighbouring lines of order two:

$$(14) \quad a \circ_2 b,$$

because we have:

$$(15) \quad P, U I' a, b, \quad a \neq b,$$

for any two distinct lines from $\bar{\Pi}^c$.

If a or b is the infinite line $[\infty]$ then P from (12) is an infinite point. If a and b are different of the line $[\infty]$ then P is a propre point of \mathcal{P}' .

In any case a and b are always incident with exactly two points from $\bar{\Pi}^c$. Such we proved that $\bar{\Pi}^c$ is a Hjelmlev-Barbilian plane of order two.

If $\bar{\Pi}$ is the real projective plane of a Π -euclidean plane we can see that:

$$(16) \quad \Pi \subset \bar{\Pi} \subset \bar{\Pi}^c$$

Definition 3.3. In the real space we consider a sphere \mathcal{S} tangent in P to a Π euclidean plane and let be N the diametral opposite point of P on the \mathcal{S} . We define the stereographic projection of the pole N from \mathcal{S} to $\bar{\Pi}^c$:

$$(17) \quad f : \mathcal{S} \rightarrow \bar{\Pi}^c$$

$$f(M) := M' \text{ where } \{M'\} = NM \cap \bar{\Pi}$$

and

$$f(N) := U.$$

Such through f we obtain a bijection between the all points of S and the points of $\overline{\Pi}^c$.

Some others applications of $\overline{\Pi}^c$ we gave in [14] as a transdisciplinary study given after the notions given in [7].

REFERENCES

- [1] D. Barbilian, *Zur Axiomatik der projectiven Ringgeometrie*, I, II Jber. Deutsch. math. Verein, 50(1940), 179-229; 51(1941), 34-76.
- [2] W. Benz, *Geometrie und Geometrie von Hjelmslev*, Math. Annalen 164(1966), 118-123.
- [3] J. Hjelmslev, *Die Geometrie der Wirklichkeit*, Acta Math. 40(1916).
- [4] W. Klingenberg, *Projective und affine Ebenen mit Nachbarelementen*, Math. Zeitschr. 60(1954), 384-406.
- [5] W. Lingenberg, *Desauguessche Ebenen mit Nachbarelementen*, Abh. Math. Sem. Univ. Hamburg, 20(1955), 97-111.
- [6] W. Leissner, *Affine Barbilian Ebenen*, I, II J. of Geometry 6(1975), 31-57, 105-129.
- [7] Basarab Nicolescu, *Nous, la particule et le monde*, Transdisciplinarité, Edition du Rocher, Paris 2002.
- [8] F. Radó, *Affine Barbilian Structures*, Journal of Geometry, 14(1980), 75-102.
- [9] W. Seier, *Über Hjelmslev Strukturen*, Abh. Math. Sem. Hamburg 42(1974), I 107-133; II 236-254.
- [10] Florentin Smarandache, *Paradoxist mathematics*, Lecture, Bloomsburg University, Math. Dept., PA, U.S.A., 1985.
- [11] Florentin Smarandache, *Collected Papers*, Vol. II, University of Kishinev, Press Kishinev, p. 5-28, 1997.
- [12] Angela Vasîu, *On a class of Hjelmslev-Barbilian translation structures*, Proceedings of Symposium on Geometry "Babeş-Bolyai" Univ. 1984, 320-323.
- [13] Adrian Vasîu, Angela Vasîu, *J. Bolyai invites us to more wisdom, to our awakening*, Proceedings of Symposium in Geometry, "Babeş-Bolyai" University, Nr. 2, 1993, p. 209-216.
- [14] Adrian Vasîu, Angela Vasîu, *Geometria interioară (The Inner Geometry)*, Editura Albastră, 2001, <http://www.gmi.ro>.

Números Felizes e Sucessões de Smarandache: Digressões com o Maple

Delfim F. M. Torres
delfim@mat.ua.pt

Departamento de Matemática
Universidade de Aveiro
3810-193 Aveiro, Portugal

Resumo

Dando jus à matemática experimental, mostramos como o Maple pode ser usado na investigação matemática de algumas questões actualmente sem resposta na Teoria dos Números. A tese defendida é que os alunos de um curso de Matemática podem facilmente usar o computador como um lugar onde se excita e exercita a imaginação.

1 Introdução

Albert Einstein é conhecido por ter dito que “a imaginação é mais importante que o conhecimento”. Se assim é, porquê esperar pelo mestrado ou doutoramento para começar a enfrentar problemas em aberto? Não é a criatividade prerrogativa dos mais novos? Em [3] mostrei como com muito pouco conhecimento é possível debruçar-mo-nos sobre algumas questões actualmente sem resposta na Teoria de Computação. Aqui, e a propósito do ano 2003 ter sido escolhido pela APM como o ano da *Matemática e Tecnologia*, vou procurar mostrar como o computador e um ambiente moderno de computação algébrica, como seja o Maple, podem ser excelentes auxiliares na abordagem a “quebra-cabeças” que a matemática dos números actualmente nos coloca. A minha escolha do sistema Maple prende-se com o facto de ser este o programa informático actualmente usado na cadeira de *Computadores no Ensino da Matemática*, no Departamento de Matemática da Universidade de Aveiro. Desta maneira os meus alunos serão prova viva de que basta um semestre de “tecnologias na educação matemática”, para nos podermos aventurar por “mares ainda não navegados”. O leitor que queira aprender sobre o Maple poderá começar por consultar o nosso site de *Computadores no Ensino da Matemática*: <http://webct.ua.pt/public/compensmat/index.html>.

2 Números felizes

Seja $n \in \mathbb{N}$ um número natural com representação decimal $n = d_k \dots d_0$, $0 \leq d_i \leq 9$ ($i = 0, \dots, k$), e denotemos por $\sigma(n)$ a soma dos quadrados dos dígitos decimais de n : $\sigma(n) = \sum_{i=0}^k (d_i)^2$. Dizemos que n é um *número feliz* se existir um $r \in \mathbb{N}$ tal que $\underbrace{(\sigma \circ \dots \circ \sigma)}_{r \text{ vezes}}(n) = 1$. Por exemplo, 7 é um número feliz ($r = 5$),

$$\sigma(7) = 49, \sigma(49) = 97, \sigma(97) = 130, \sigma(130) = 10, \sigma(10) = 1;$$

enquanto 2 não:

$$\sigma(2) = 4, \sigma(4) = 16, \sigma(16) = 37, \sigma(37) = 58, \sigma(58) = 89, \\ \sigma(89) = 145, \sigma(145) = 42, \sigma(42) = 20, \sigma(20) = 4 \dots$$

Vamos definir em Maple a função característica Booleana dos números felizes. Começamos por definir a função `digitos` que nos devolve a sequência de dígitos de um dado número n

```
> digitos := n -> seq(iquo(irem(n,10^i),10^(i-1)),i=1..length(n));
> digitos(12345);
```

5, 4, 3, 2, 1

A função σ é agora facilmente construída

```
> sigma := n -> add(i^2,i=digitos(n));
> sigma(24);
```

20

O processo de composição da função σ é obtido usando o operador `@` do Maple:

```
> s := (n,r) -> seq((sigma@@i)(n),i=1..r);
> s(7,5);
```

49, 97, 130, 10, 1

```
> s(2,9);
```

4, 16, 37, 58, 89, 145, 42, 20, 4

Para automatizarmos o processo de decisão se um número é feliz ou não, recorreremos a alguma programação. O seguinte procedimento deve ser claro.

```
> feliz := proc(n)
> local L, v;
> L := {};
> v := sigma(n);
> while (not (member(v,L) or v=1)) do
> L := L union {v};
> v := sigma(v);
> end do;
> if (v = 1) then true else false end if;
> end proc;
```

Podemos agora questionar o sistema Maple acerca da felicidade de um determinado número.

```
> feliz(7);
```

true

```
> feliz(2);
```

false

A lista de todos os números felizes até 100 é dada por

```
> select(feliz,[1..100]);
```

[1, 7, 10, 13, 19, 23, 28, 31, 32, 44, 49, 68, 70, 79, 82, 86, 91, 94, 97, 100]

Concluimos então que existem 20 números felizes de entre os primeiros 100 naturais

```
> nops(select(feliz, [$1..100]));
```

20

Existem 143 números felizes não superiores a 1000; 1442 não superiores a 10000; e 3038 não superiores a 20000:

```
> nops(select(feliz, [$1..1000]));
```

143

```
> nops(select(feliz, [$1..10000]));
```

1442

```
> nops(select(feliz, [$1..20000]));
```

3038

Estas últimas experiências com o Maple permitem-nos formular a seguinte conjectura.

Conjectura 1. Cerca de um sétimo de todos os números são felizes.

Uma questão interessante é estudar números felizes consecutivos. De entre os primeiros 1442 números felizes podemos encontrar 238 pares de números felizes consecutivos (o mais pequeno é o (31, 32));

```
> felizDezMil := select(feliz, [$1..10000]):
> nops(select(i->member(i, felizDezMil) and
               member(i+1, felizDezMil), felizDezMil));
```

238

onze ternos de números felizes consecutivos, o mais pequeno dos quais é o (1880, 1881, 1882);

```
> select(i->member(i, felizDezMil) and
         member(i+1, felizDezMil) and
         member(i+2, felizDezMil), felizDezMil);
```

[1880, 4780, 4870, 7480, 7839, 7840, 8180, 8470, 8739, 8740, 8810]

dois quaternos de números felizes consecutivos, o mais pequeno dos quais é o (7839, 7840, 7841, 7842);

```
> select(i->member(i, felizDezMil) and
         member(i+1, felizDezMil) and
         member(i+2, felizDezMil) and
         member(i+3, felizDezMil), felizDezMil);
```

[7839, 8739]

e nenhuma sequência de cinco números felizes consecutivos.

```
> select(i->member(i, felizDezMil) and
         member(i+1, felizDezMil) and
         member(i+2, felizDezMil) and
         member(i+3, felizDezMil) and
         member(i+4, felizDezMil), felizDezMil);
```



```
> primos := select(isprime,sh(1000)):
> nops([seq(primos[i],i=1..143)]);
```

3

Se fizermos `print(primos)` vemos que os três primos são $s_2 = 17$, $s_5 = 17101319$ e s_{43} (s_{43} é um primo com 108 dígitos decimais).

```
> primos[2], primos[5];
17, 17101319
> length(primos[43]);
```

108

Apenas são conhecidos estes números primos na sucessão de Smarandache dos números felizes. Permanece por esclarecer se eles serão ou não em número finito (*vide* [1]).

Existem 31 números felizes de entre os primeiros 143 termos da sucessão de Smarandache dos números felizes:

```
> shFelizes := select(feliz,sh(1000)):
> nops([seq(shFelizes[i],i=1..143)]);
```

31

Recorrendo ao comando `print(shFelizes)` vemos que esses números são o $s_1, s_{11}, s_{14}, s_{30}, s_{31}, s_{35}, s_{48}, s_{52}, s_{58}, s_{62}, s_{67}, s_{69}, s_{71}, s_{76}, s_{77}, s_{78}, s_{82}, s_{83}, s_{85}, s_{98}, s_{104}, s_{108}, s_{110}, s_{114}, s_{115}, s_{117}, s_{118}, s_{119}, s_{122}, s_{139}$ e s_{140} . A título de curiosidade, s_{140} tem 399 dígitos:

```
> length(shFelizes[140]);
```

399

Muito existe por esclarecer relativamente à existência de números felizes consecutivos na sucessão de Smarandache dos números felizes. Olhando para os resultados anteriores vemos que o par mais pequeno de números felizes consecutivos é o (s_{30}, s_{31}) ; enquanto o terno mais pequeno é o (s_{76}, s_{77}, s_{78}) . Quantos termos consecutivos são possíveis? É capaz de encontrar exemplos, digamos, de seis números felizes consecutivos? Estas e outras questões estão em aberto (*vide* [1]). Ferramentas como o Maple são boas auxiliares neste tipo de investigações. Fico à espera de algumas respostas da sua parte.

Referências

- [1] S. S. Gupta, *Smarandache sequence of happy numbers*, Smarandache Notions Journal, Vol. 13, no. 1-3, 2002 (see online version at <http://www.shyamsundergupta.com/shappy.htm>).
- [2] R. K. Guy, *Unsolved problems in number theory*, Second edition, Springer, New York, 1994.
- [3] D. F. M. Torres, *O Computador Matemático de Post*, Boletim da Sociedade Portuguesa de Matemática, N^o 46, Abril de 2002, pp. 81-94.
- [4] D. W. Wilson, Sequence A055629 (Jun 05 2000) in the On-Line Encyclopedia of Integer Sequences, <http://www.research.att.com/~njas/sequences>

Calculating the Smarandache Numbers

Jon Perry
51 High Street
Belbroughton
West Midlands
DY9 9ST
England

Abstract

The Smarandache Numbers are:

1,2,3,4,5,3,7,4,6,5,11,4,13,7,5,6,17,6,19,5,7,11,23,4,10,13,9,7,29,5,31,8,11,17,7,6,37,
19,13,5,41,7,43,11,6,23,47,6,14,10,17,13,53,9,11,7,19,29,59,5,61,31,7,8,13,11,67,17,
23,7,71, 6,73,37,10,19,11,13,79,6,9,41,83,7, ...

and defined as the smallest integer m such that n divides $m!$ Finding the exact value of $a(n)$ is an open problem, and this paper presents an effective algorithm for determining the value of $a(n)$.

Keywords

Smarandache functions, factorial, prime numbers

Introduction

The process involved is fairly simple, and we need to know the factorisation of n . From this factorisation, it is possible to exactly calculate by which m each prime is satisfied, i.e. the correct number of exponents appears for the first time. The largest of these values gives $a(n)$.

Satisfying p^k

To satisfy p^k , we find the lowest m such that p^k divides $m!$.

For example, if we look at $3^4=81$, then $m=9$ suffices and is also the lowest possible value of m we can achieve.

We can see that $m=9$ suffices, as $9!=1.2.3.4.5.6.7.8.9$, of which 3,6 and 9 are multiples of 3, and 9 happens to be 3^2 . As 3, 6 and 9 are the first multiples of 3, this implies $m=9$ is minimal.

The key to finding m lies in the value of k , and with the distribution of 3's over the integers.

The pattern of divisibility by 3, beginning with 1, is;

0 0 1 0 0 1 0 0 2 0 0 1 0 0 1 0 0 2 0 0 1 0 0 1 0 0 3 0

For the purpose of the Smarandache numbers, we can remove the 0's from this, as we are only concerned with accumulating enough 3's.

(A) 1 1 2 1 1 2 1 1 3 1 1 2 1 1 2 1 1 3 1 1 2 1 1 2 1 1 4 1

The pattern present here can be generalized at a basic level to allow us to calculate the values of the sums whenever a number appears for the first time.

This gives us the sub-sequences 1, 112, 112112113, etc..., and we are interested in the sums of these, i.e.:

(B) 1, 4, 13, 40 ...

This is the partial sums of $1+3+9+27+\dots$, and this is result of evaluating $(3^n-1)/2$.

Now we can deduce the value of m from k , where does k appear in B ? Our k in the example was 4, and this appears as $B(2)$. This means that to reach 3^4 we need 3 terms from A ($=3^{(2-1)}$), and multiplying by 3 gives the answer we require of 9.

But how about 3^{333} ? To calculate m for this, we reduce in by as many possible of the terms of A .

A fuller list of A is:

```
(pari/gp code)
three(n)=(3^n-1)/2
for (n=1,8,print1(three(n),""))
```

1,4,13,40,121,364,1093,3280,

364 is too large, but 121 is Ok. $333-121=212$, and again $212-121=91$.

121 is $A(5)$, so the data collected so far is $[2*5]$

Continuing, $91-2*40=11$, and $11-2*4=3$, and $3=1*3$, thus we have the data $[2*5, 2*4, 2*2, 3*1]$.

To interpret this data, we just re-apply it to the distribution of 3's. $2*5$ means that we need $2*3^4$ consecutive multiples of 3 – by this stage we have satisfied 3^{242} . $2*4$ means that we add a further $2*3^3$ multiples of 3, $2*2$ means that we add a further $2*3^1$ multiples of 3, and finally we add $3*1$ multiples of 3.

The whole sum is therefore $2*81+2*27+2*3+3*1=162+54+6+3=225$, and this gives us the answer directly: $(225*3)! = 675!$ is the smallest factorial that 3^{333} divides.

This can be proven with a small Pari program:

```
? for(i=1,2000,if(i!%3^333==0,print1(i);break))
675
```

Calculating $a(n)$

Then we need to calculate the m value for each prime and exponent, and a(n) is the largest.

This Pari/GP code performs the necessary calculations

```
{
findm(x,y)=local(m,n,x1);
m=0;n=1;x1=x-1;
while (((x^n-1)/x1)<=y,n++);n--;
while (y>0,
while (((x^n-1)/x1)<=y,y-=((x^n-1)/x1);m+=(x^(n-1)));n--);
x*m
}
```

This is the findm() function. n is boosted until larger than necessary, and then trimmed down one so that it must be less than or equal to y. Then y is decreased by the largest possible value of $(x^n-1)/(x-1)$ possible until $y=0$. m is continually incremented throughout this process as appropriate, and the returned value is $x*m$.

```
{
smarandache(n)=local(f,fl,ms);
if (n==1,1,
f=factor(n);fl=length(f[,1]);
ms=vector(fl,i,0);
for (i=1,fl,ms[i]=findm(f[i,1],f[i,2]));
vecmax(ms))
}
```

The smarandache() function returns 1 if n is 1, otherwise it creates the ms vector of lowest possible m values, and returns the largest value.

The program results in this data:

```
?for (i=1,100,print1(smarandache(i)," "))
1,2,3,4,5,3,7,4,6,5,11,4,13,7,5,6,17,6,19,5,7,11,23,4,10,13,9,7,29,5,31,8,11,17,
7,6,37,19,13,5,41,7,43,11,6,23,47,6,14,10,17,13,53,9,11,7,19,29,59,5,61,31,7,8,1
3,11,67,17,23,7,71,6,73,37,10,19,11,13,79,6,9,41,83,7,17,43,29,11,89,6,13,23,31,
47,19,8,97,14,11,10,
```

which give a 100% correlation with the sequence given in the abstract.

At 100Mhz, it takes about 1 minute to generate the sequence to $n=10000$.

Reference:

Neil Sloane, The Encyclopaedia of Integer Sequences, Sequence # A002034,
[http://www.research.att.com/cgi-
bin/access.cgi/as/njas/sequences/eisA.cgi?Anum=A002034](http://www.research.att.com/cgi-bin/access.cgi/as/njas/sequences/eisA.cgi?Anum=A002034)

On Additive Analogues of Certain Arithmetic Functions

József Sándor

Department of Mathematics,
Babeş-Bolyai University, 3400 Cluj-Napoca, Romania

1. The Smarandache, Pseudo-Smarandache, resp. Smarandache-simple functions are defined as ([7], [6])

$$S(n) = \min\{m \in \mathbb{N} : n|m!\}, \quad (1)$$

$$Z(n) = \min \left\{ m \in \mathbb{N} : n \mid \frac{m(m+1)}{2} \right\}, \quad (2)$$

$$S_p(n) = \min\{m \in \mathbb{N} : p^n|m!\} \text{ for fixed primes } p. \quad (3)$$

The duals of S and Z have been studied e.g. in [2], [5], [6]:

$$S_*(n) = \max\{m \in \mathbb{N} : m!|n\}, \quad (4)$$

$$Z_*(n) = \max \left\{ m \in \mathbb{N} : \frac{m(m+1)}{2} | n \right\}. \quad (5)$$

We note here that the dual of the Smarandache simple function can be defined in a similar manner, namely by

$$S_{p^*}(n) = \max\{m \in \mathbb{N} : m!|p^n\} \quad (6)$$

This dual will be studied in a separate paper (in preparation).

2. The additive analogues of the functions S and S_* are real variable functions, and have been defined and studied in paper [3]. (See also our book [6], pp. 171-174). These functions have been recently further extended, by the use of Euler's gamma function, in place of the factorial (see [1]). We note that in what follows, we could define also the additive analogues functions by the use of Euler's gamma function. However, we shall apply the more transparent notation of a factorial of a positive integer.

The additive analogues of S and S_* from (1) and (4) have been introduced in [3] as follows:

$$S(x) = \min\{m \in \mathbb{N} : x \leq m!\}, \quad S : (1, \infty) \rightarrow \mathbb{R}, \quad (7)$$

resp.

$$S_*(x) = \max\{m \in \mathbb{N} : m! \leq x\}, \quad S_* : [1, \infty) \rightarrow \mathbb{R} \quad (8)$$

Besides of properties relating to continuity, differentiability, or Riemann integrability of these functions, we have proved the following results:

Theorem 1.

$$S_*(x) \sim \frac{\log x}{\log \log x} \quad (x \rightarrow \infty) \quad (9)$$

(the same for $S(x)$).

Theorem 2. *The series*

$$\sum_{n=1}^{\infty} \frac{1}{n(S_*(n))^\alpha} \quad (10)$$

is convergent for $\alpha > 1$ and divergent for $\alpha \leq 1$ (the same for $S_*(n)$ replaced by $S(n)$).

3. The additive analogues of Z and Z_* from (2), resp. (4) will be defined as

$$Z(x) = \min \left\{ m \in \mathbb{N} : x \leq \frac{m(m+1)}{2} \right\}, \quad (11)$$

$$Z_*(x) = \max \left\{ m \in \mathbb{N} : \frac{m(m+1)}{2} \leq x \right\} \quad (12)$$

In (11) we will assume $x \in (0, +\infty)$, while in (12) $x \in [1, +\infty)$.

The two additive variants of $S_p(n)$ of (3) will be defined as

$$P(x) = S_p(x) = \min\{m \in \mathbb{N} : p^x \leq m!\}; \quad (13)$$

(where in this case $p > 1$ is an arbitrary fixed real number)

$$P_*(x) = S_{p^*}(x) = \max\{m \in \mathbb{N} : m! \leq p^x\} \quad (14)$$

From the definitions follow at once that

$$Z(x) = k \Leftrightarrow x \in \left(\frac{(k-1)k}{2}, \frac{k(k+1)}{2} \right] \text{ for } k \geq 1 \quad (15)$$

$$Z_*(x) = k \Leftrightarrow x \in \left[\frac{k(k+1)}{2}, \frac{(k+1)(k+2)}{2} \right) \quad (16)$$

For $x \geq 1$ it is immediate that

$$Z_*(x) + 1 \geq Z(x) \geq Z_*(x) \quad (17)$$

Therefore, it is sufficient to study the function $Z_*(x)$.

The following theorems are easy consequences of the given definitions:

Theorem 3.

$$Z_*(x) \sim \frac{1}{2} \sqrt{8x+1} \quad (x \rightarrow \infty) \quad (18)$$

Theorem 4.

$$\sum_{n=1}^{\infty} \frac{1}{(Z_*(n))^\alpha} \text{ is convergent for } \alpha > 2 \quad (19)$$

and divergent for $\alpha \leq 2$. The series $\sum_{n=1}^{\infty} \frac{1}{n(Z_*(n))^\alpha}$ is convergent for all $\alpha > 0$.

Proof. By (16) one can write $\frac{k(k+1)}{2} \leq x < \frac{(k+1)(k+2)}{2}$, so $k^2 + k - 2x \leq 0$ and $k^2 + 3k + 2 - 2x > 0$. Since the solutions of these quadratic equations are $k_{1,2} = \frac{-1 \pm \sqrt{8x+1}}{2}$, resp. $k_{3,4} = \frac{-3 \pm \sqrt{8x+1}}{2}$, and remarking that $\frac{\sqrt{8x+1}-3}{2} \geq$

$1 \Leftrightarrow x \geq 3$, we obtain that the solution of the above system of inequalities is:

$$\begin{cases} k \in \left[1, \frac{\sqrt{1+8x}-1}{2} \right] & \text{if } x \in [1, 3); \\ k \in \left(\frac{\sqrt{1+8x}-3}{2}, \frac{\sqrt{1+8x}-1}{2} \right] & \text{if } x \in [3, +\infty) \end{cases} \quad (20)$$

So, for $x \geq 3$

$$\frac{\sqrt{1+8x}-3}{2} < Z_*(x) \leq \frac{\sqrt{1+8x}-1}{2} \quad (21)$$

implying relation (18).

Theorem 4 now follows by (18) and the known fact that the generalized harmonic series $\sum_{n=1}^{\infty} \frac{1}{n^\theta}$ is convergent only for $\theta > 1$.

The things are slightly more complicated in the case of functions P and P_* . Here it is sufficient to consider P_* , too.

First remark that

$$P_*(x) = m \Leftrightarrow x \in \left[\frac{\log m!}{\log p}, \frac{\log(m+1)!}{\log p} \right). \quad (22)$$

The following asymptotic results have been proved in [3] (Lemma 2) (see also [6], p. 172)

$$\log m! \sim m \log m, \quad \frac{m \log \log m!}{\log m!} \sim 1, \quad \frac{\log \log m!}{\log \log(m+1)!} \sim 1 \quad (m \rightarrow \infty) \quad (23)$$

By (22) one can write

$$\frac{m \log \log m!}{\log m!} - \frac{m}{\log m!} \log \log p \leq \frac{m \log x}{\log m!} \leq \frac{m \log \log(m+1)!}{\log m!} - (\log \log p) \frac{m}{\log m!},$$

giving $\frac{m \log x}{\log m!} \rightarrow 1$ ($m \rightarrow \infty$), and by (23) one gets $\log x \sim \log m$. This means that:

Theorem 5.

$$\log P_*(x) \sim \log x \quad (x \rightarrow \infty) \quad (24)$$

The following theorem is a consequence of (24), and a convergence theorem established in [3]:

Theorem 6. *The series $\sum_{n=1}^{\infty} \frac{1}{n} \left(\frac{\log \log n}{\log P_*(n)} \right)^\alpha$ is convergent for $\alpha > 1$ and divergent for $\alpha \leq 1$.*

Indeed, by (24) it is sufficient to study the series $\sum_{n \geq n_0}^{\infty} \frac{1}{n} \left(\frac{\log \log n}{\log n} \right)^\alpha$ (where $n_0 \in \mathbb{N}$ is a fixed positive integer). This series has been proved to be convergent for $\alpha > 1$ and divergent for $\alpha \leq 1$ (see [6], p. 174).

References

- [1] C. Adiga and Taekyun Kim, *On a generalization of Sándor's function*, Proc. Jangjeon Math. Soc. 5(2002), no. 2, 121-124.
- [2] J. Sándor, *On certain generalizations of the Smarandache function*, Notes Number Th. Discr. Math. 5(1999), no. 2, 41-51.
- [3] J. Sándor, *On an additive analogue of the function S*, Notes Number Th. Discr. Math. 7(2001), no. 3.
- [4] J. Sándor, *On the pseudo-Smarandache function*, Smarandache Notions J. 12(2001), no. 1-2-3, 59-62.
- [5] J. Sándor, *On α dual of the pseudo-Smarandache function*, Smarandache Notions J. 13(2002), no. 1-2-3, 18-23.
- [6] J. Sándor, *Geometric theorems, diophantine equations and arithmetic functions*, American Research Press, Rehoboth, NM, 2002 (see pp. 141-149, 156-158, 161-166, 171-174) [MR 1 906 446 (Review); Zbl. 1004.11001; Zbl. Math. Di 2002e.03960]
- [7] F. Smarandache, *A function in the Number theory*, An. Univ. Timișoara, Ser. Șt. Mat. 28(1980), no. 1, 79-88.

Recursive Prime Numbers

Sabin Tabirca*

Kieran Reynolds*

*Computer Science Department, University College Cork, Ireland

email: [s.tabirca, k.reynolds}@cs.ucc.ie](mailto:{s.tabirca, k.reynolds}@cs.ucc.ie)

Many researchers study prime numbers for the curiosities that they possess rather than the position they occupy at the foundations of Number Theory. This study may be in any numbers of areas from applications to multimedia to searching for special or unusual primes. It is truly awe inspiring to see how much time can be expended on prime numbers without a realistic application.

In this article, a sequence of prime numbers, called Recursive Prime Numbers, is identified before a complete search is undertaken to verify that the sequence is finite by finding all existing prime numbers of the specified form. This could be done with considerable effort by hand, but here a simple computer program has been used to speed the calculations. So now the question must be answered; what are recursive prime numbers. The easiest way to answer that is to say that a prime number is recursively prime if the number is prime can be constructed by adding a digit to an already recursive prime number.

1. Recursive Prime Numbers

The idea of Recursive Prime Numbers arose when asked if it were possible to create infinite sequences of prime numbers by adding digits to the end of an existing prime.

Definition 1. *A number is said to be a recursive prime number if it and all of the initial segments of the decimal expansion are prime. We can recursively define those numbers as follows:*

- a) *2, 3, 5, 7 are recursive prime numbers*
- b) *if $\overline{a_0a_1\dots a_n}$ is a recursive prime number and $\overline{a_0a_1\dots a_n a_{n+1}}$ is a prime number then $\overline{a_0a_1\dots a_n a_{n+1}}$ is a recursive prime number as well.*

Example 1. 23333 is a recursive prime number since 2, 23, 2333 and 23333 are all prime.

Although, with only a little examination it becomes clear that it is very unlikely that such an infinite sequence could be found, still the concept is one that is quite interesting and demanded some attention. It is not a difficult task to systematically find all prime numbers of this form. Let us consider the following sets of prime numbers

$$L^1(a) = \{a\}, \forall a \in \{2,3,5,7\} \quad (1)$$

$$L^{n+1}(a) = \{10 \cdot x + y : x \in L^n(a), y \in \{1,3,7,9\}, 10 \cdot x + y \text{ is prime}\} \forall n \geq 1 \quad (2)$$

$$L(a) = \bigcup_{n \geq 1} L^n(a), \forall a \in \{2,3,5,7\}, \quad (3)$$

where $L^n(a)$ represents the set of the recursive prime numbers which start with the digit a and have n digits.

We used Java computation to generate the set $L(a)$ of all the recursive prime numbers that start from the digit a (see Figure 1). The program chooses to use Java's long type as opposed to the reference type, BigInteger. This choice was made to simplify the code in the expectation that there would be no need for the increased size provided for BigInteger. Similarly, a simple trial division primality test has been used in lieu of a more efficient test since the numbers are expected to remain relatively small in all cases (see Figure 1). There are many references available for those interested in primality testing, [Knuth, ***], [Shallit, 1996], [Romero, 1998].

The code creates two queues queueOld and queueNew for the sets $L^n(a)$ and $L^{n+1}(a)$ respectively. Initially, the queue queueOld contains the digit a . The loop for simulates Equation (2) by generating the elements of queueNew from the elements of queueOld and the set of last digits. An element prime of queueOld is removed from the queue, which is concatenated with the last digits $\{1, 3, 7, 9\}$. If a prime number is obtained, we insert it in the queue queueNew. When all those numbers are composite, we find that queueNew is empty, therefore the computation finishes.

```
public Vector listRekurs(long a){
    LinkedList queueOld = new LinkedList();
    LinkedList queueNew = new LinkedList();
    Vector primes = new Vector();

    queueOld.addLast(new Long(a)); // digit is added to queue
    long [] lastDigit = {1, 3, 7, 9};

    for(int n=1; ! queueOld.isEmpty(); n++) {

        // generate queueNew for the set Ln+1(a)

        while (! queueOld.isEmpty()){
            // get an element prime from queueOld
            long prime = ((Long)queueOld.removeFirst()).longValue();
            primes.addElement(new Long(temp));

            // generate all the recursive prime numbers from prime
            for (int i = 0; i < lastDigit.length(); i++) {
                long primeNext = prime * 10 + lastDigi[i];
                if(this.testPrimality(primeNext))
                    queueNew.addLast(primeNext);
            }
        }

        while (! queueNew.isEmpty()){
            long nr = ((Long)queueNew.removeFirst()).longValue();
            queueOld.addLast(nr);
        }

    }

    return primes;
}
```

```

public Boolean testPrimality(long num){
    if (this.getLong()==2 || this.getLong()==3)return isPrime;
    if (this.getLong()%2==0 || this.getLong()%3==0)return isComposite;

    for (int i=5; i<(long) ath.floor(Math.sqrt(this.getLong())); i+=4)
        {   if (this.getLong() % i == 0) return isComposite;
            i+= 2;
            if (this.getLong() % i == 0) return isComposite;
        }

    return isPrime;
}

```

Figure 1. Java program to list all recursive prime numbers.

The following theorem establishes the correctness of our computation.

Theorem 1. The contents of queueOld before the n -th iteration of the loop for is $L^n(a)$, therefore the contents of the vector primes is $L(a)$.

Proof. Induction is used for this proof.

Since the queue queueOld initially contains only a , we find that the property holds for $n=1$. Suppose that before the n -th iteration the contents of queueOld is $L^n(a)$. In the loop for we generate queueNew as follows:

- for any element prime of queueOld= $L^n(a)$ and for any lastDigit[i]
- if prime*10+lastDigit[i] is prime then add it to queueNew

Therefore, the contents of queueNew will be identical as $L^{n+1}(a)$. At the end of this iteration the elements of queueNew are transferred to queueOld therefore before the iteration $(n+1)$ -th the contents of queueOld is $L^{n+1}(a)$.

◆

The computation relieved that the sets $L^n(a)$ are empty for values $n>8$. Therefore, each digit 2, 3, 5, 7 generates only a finite number of recursive primes. This is detailed in the next section.



Figure 2. Recursively constructed prime numbers with starting digit 2.

2. Series of Recursive Primes

In order to gain a better understanding of recursive prime numbers it is necessary to view the results for each starting digit separately, beginning with 2. With 2 as a starting digit there are only two possible extensions for each number; 3 or 9. This is due to the fact that concatenating a 1 or 7 at any stage causes the number to become divisible by 3. The results can be visualised as a tree as in Figure 2.

Since at any stage there are only two possible digits to add, this case results in a binary tree. It is interesting to note that the right child of each of the nodes 29, 239 and 233 result in long “slender” branches. It is these branches that result in the longest sequences for this case, two of which are eight digits long. In total there are 24 primes in this tree. As it will be seen later this is the joint largest tree in terms of nodes, and shares the same longest sequences with each of the other trees. It is interesting that this case, despite its limitation of potential digits, is not limited in size at all. In fact, this is the only tree that has two sequences of length 8.

Unlike the previous case, when the number begins with 3 there are 4 potential digits to concatenate to the number at some stages. There are still some limitations. For example 3 and 9 result in composite numbers at the first stage but otherwise are options at subsequent step. Meanwhile, at the first concatenation 1 and 7 result in new primes but following that any sequence can only have one more of these numbers before they become divisible by 3. This tree is not a binary tree, but it very nearly is. Only one node, 31, has three children. As can be seen in the following image.

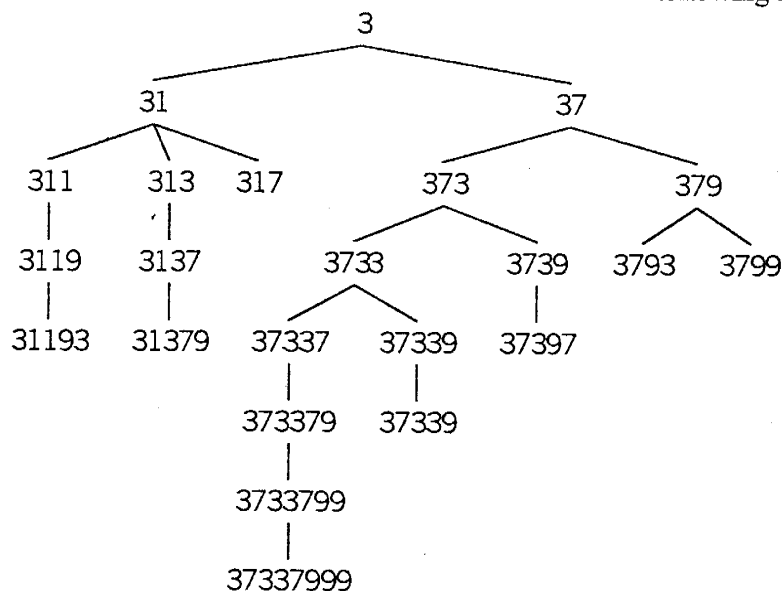

Figure 3. Recursively constructed prime numbers with starting digit 3.

This case results in 23 prime numbers, one less than the previous case and also shares the eight digit longest sequence. One element that is found in this sequence that is absent from the previous example is twin primes. In fact, there are two pairs of primes found in this tree; (311, 313) and (37337, 37339).

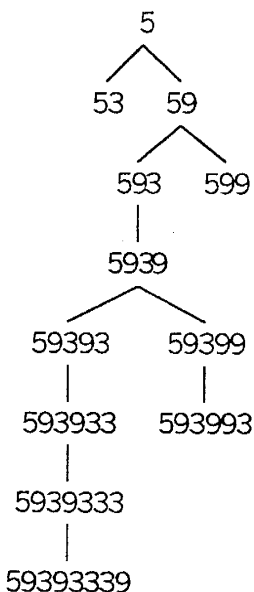

Figure 4. Recursively constructed prime numbers with starting digit 5.

The case with 5 as the first digit produces the most unusual trees. While the other cases result in reasonably broad trees, this case results in a slender tree. Also, the other cases result in 23 or 24 primes, but this case results in just 12 primes. As well as this, it shares the limitation of potential digits with the first case examined, again allowing only 3 and 9 to be concatenated to the number at each stage. Yet surprisingly, the longest sequence found is 8, equal to that of all the previous cases.

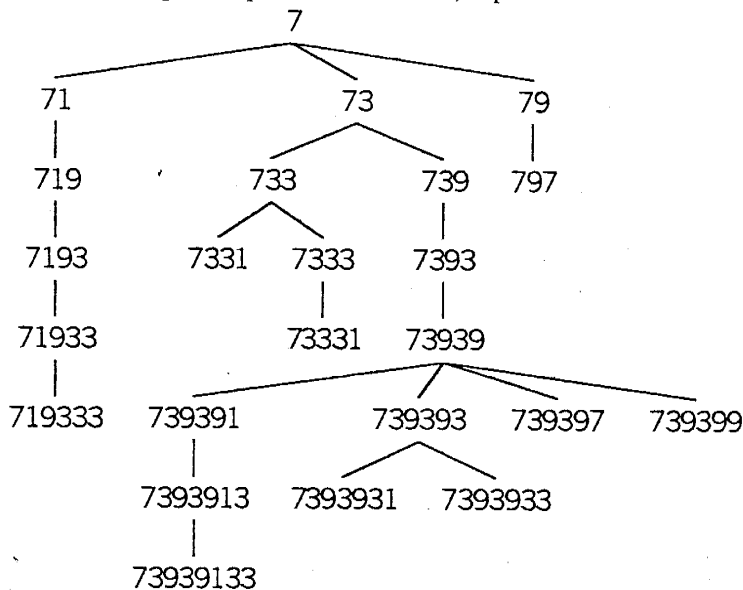

Figure 5. Recursively constructed prime numbers with starting digit 7.

The final case to be examined is the tree rooted at 7. Again there are limitations on the use of 1 and 7 for these numbers. In this case, since the numbers begin with a 7, every sequence can contain just one of either 1 or 7 at any subsequent stage. As with each of the trees seen previously, this also shows some interesting characteristics.

Firstly, it is not a binary tree with two nodes having too many children. The node 7 has three children while interestingly 73939 has four children, one for each possible

digit. This is a unique occurrence in this search. This tree has 24 primes, making it as large as the first example and also has a longest sequence of 8 digits. However, possibly the most interesting feature of this tree is that it contains five pairs of twin primes; (71, 73), (7331, 7333), (739391, 739393), (739397, 739399), and (7393931, 7393933).

Conclusions

This article has proposed a new class of prime numbers called "recursive primes". Using Java computation all the recursive prime numbers have been generated. It has been identified only 83 numbers that are recursive primes. Among them 5 pairs of twin primes have been found.

References.

1. Romero, C. and Kumanduri, R.: Number Theory with Computer Applications, 1998, Prentice Hall, USA.
2. Shallit, J. and Bach, E.: Algorithmic Number Theory: Volume 1 – Efficient Algorithms, 1996, MIT Press, England.

Smarandache Sequence of Happy Cube Numbers

Muneer Jebreel, SS-Math-Hebron, UNRWA
Field Education Officer, Box 19149
Jerusalem, Israel

Abstract : I have studied the Smarandache Happy Cube Numbers and I have got some interesting results and facts . I have discovered some open problems about the Happy Cube and Smarandache Happy Cube Numbers .

Keywords : Fixed Happy Cube Number (FHCN) , Cyclic Happy Cube Number (CHCN), Consecutive fixed happy cube numbers , General Happy Cube Numbers(GHCN), Happy numbers , Fibonacci numbers , Lucas numbers , Pell numbers , Smarandache Fixed Happy Cube Numbers (SFHCN), Reversed Smarandache Fixed Happy Cube Numbers(RSFHCN), Smarandache Cyclic Happy Cube Numbers (SCHCN), Reversed Smarandache Cyclic Happy Cube Numbers(RSCHCN), Smarandache General Smarandache Happy Cube Numbers(SGHCN), , Reversed Smarandache General Smarandache Happy Cube Numbers(RSGHCN)

Definition1 : A positive integer is called *Fixed Happy Cube Numbers* (FHCN) in case, if you are cubing its digits and adding them together one time you got the same number .

For example , $370 = 3^3 + 7^3 + 0^3$, and , $371 = 3^3 + 7^3 + 1^3$, it follows that 370

and 371 are both considered as Fixed Happy Cube Numbers (FHCN).

While it's worth notably that any permutation of the digits of the(FHCN) doesn't end with the same integer e.g. $730 \neq 3^3 + 7^3 + 0^3$. In this case , the integer called unhappy cube .

So the proposed sequence of the FHCN, is $FHCN = \{ 1, 153, 370, 371, 407, \dots \}$.

Open Problems needing answers

1. Is the sequence of the proposed FHCN finite or infinite ?
2. If it is infinite, what is the next number of 407 ?
3. What is the density of FHCN ?
4. Is there any sequence of FHCN following a definite mathematical patterns?
5. How many primes are there in FHCN ?
6. Is there FHCN and *Happy Number* at the same time ?

7. Is there relations between FHCN and the following numbers :*Happy Numbers, Fibonacci Numbers , Lucas Numbers , and Pell Numbers* ?
8. What about other bases or higher powers of FHCN?
9. We have 370 , and 371 consecutive FHCN, are there other consecutive FHCN?

Smarandache Fixed Happy Cube Number (SFHCN)

Definition2 : *Smarandache Fixed Happy Cube Number* (SFHCN) is the number formed from FHCN , as a result :

$$\text{SFHCN} = \{ 1, 1153, 1153370, 1153370371, 1153370371407, \dots \}.$$

Note the following observations :

1. 1153 is a prime number.
2. 1153370 is happy number (Because $1^2 + 1^2 + 5^2 + 3^2 + 3^2 + 7^2 + 0^2 \rightarrow 9^2 + 4^2 \rightarrow 9^2 + 7^2 \rightarrow 1^2 + 3^2 + 0^2 \rightarrow 1^2 + 0^2 \rightarrow 1$.
3. 1153370371407 . if we are squaring the digits and adding them together we get the number 153 i.e. FHCN.

Open Problems needing answers

- 1) How many prime numbers are there in SFHCN ?
- 2) How many SFHCN and *Happy Numbers* are there at the same time ?
- 3) Is there a relationship between SFHCN and FHCN numbers ?
- 4) Are there consecutive SFHCN?

Reversed Smarandache Fixed Happy Cube Number (RSFHCN)

Definition3 : *Reversed Smarandache Fixed Happy Cube Number* (RSFHCN) is the number formed from SFHCN , as a result :

$$\text{RSFHCN} = \{ 1, 1531, 3701531, 3713701531, 4073713701531, \dots \}.$$

Note the following observations :

1. 1531 , and 3713701531 are bothe prime- RSFHCN .
2. 3701531 is happy – RSFHCN .

Open Problems needing answers

- 1) How many prime numbers are there in RSFHCN ?
- 2) How many RSFHCN and *Happy Number* are there at the same time ?

- 3) Is there a relationship between RSFHCN and SFHCN ?
- 4) Are there consecutive RSFHCN?

Definition4 : A positive integer is called *Cyclic Happy Cube Numbers* (CHCN), in case , if you are cubing its digits and adding them together many times you got the same number .

For example , $160 \rightarrow 1^3 + 6^3 + 0^3 \rightarrow 217 \rightarrow 2^3 + 1^3 + 7^3 \rightarrow 352 \rightarrow 3^3 + 5^3 + 2^3 \rightarrow 160$. So 160 is cyclic happy cube numbers .

Consequently the proposed CHCN, is $CHCN = \{ 55, 133, 136, 160, 217, 244, 250, 352, 919, 1459, \dots \}$.

Note that the numbers 919, and 1459 are prime numbers ,and the number 55 is Fibonacci number.

Open Problems needing answers

- 1) Is the sequence of the proposed CHCN finite or infinite ?
- 2) What is the next number of 1459 ? If exist !
- 3) What is the density of CHCN ?
- 4) Are there any sequence of CHCN following a definite mathematical patterns?
- 5) How many primes are there in CHCN ?
- 6) Is there CHCN and *Happy Number* at the same time ?
- 7) Is there a relations between CHCN and the following numbers : *Happy Numbers* , *Fibonacci Numbers* , *Lucas Numbers* , and *Pell Numbers* ?
- 8) What about other bases or higher powers of CHCN?
- 9) Are there CHCN, 2, 3,4,5 ,... etc , consecutive CHCN?
Smarandache Cyclic Happy Cube Number (SCHCN)

Definition5 : *Smarandache Cyclic Happy Cube Number* (SCHCN) is the number formed from CHCN ,
hence $SCHCN = \{ 55, 55133, 55133136, 55133136160, \dots \}$.

Open Problems needing answers

1. How many prime numbers are there in SCHCN ?
2. How many SCHCN and *Happy Number* are there at the same time ?
3. Is there a relation between SCHCN and CHCN ?

4. Are there consecutive SCHCN?
5. What is the density of SCHCN ?
6. Is there any sequence of SCHCN following a definite mathematical patterns?
7. How many prime numbers are there in SCHCN ?
8. Is there SCHCN and *Happy Number* at the same time ?
9. Is there a relation between SCHCN and the following numbers : *Happy Numbers , Fibonacci Numbers , Lucas Numbers , and Pell Numbers* ?
10. What about other bases or higher powers of SCHCN?
11. Are there SCHCN, 2, 3,4,5 ,... etc , consecutive SCHCN?

Reversed Smarandache Cyclic Happy Cube Number (RSCHCN)

Definition6 : *Reversed Smarandache Cyclic Happy Cube Number* (RSCHCN) is the number formed from SCHCN ,
 Consequently, $RSCHCN = \{ 55 , 13355 , 13613355 , 16013613355 , \dots \}$.

Open Problems needing answers

1. How many prime numbers are there in RSCHCN ?
2. How many RSCHCN and *Happy Number* are there at the same time ?
3. Is there a relation between RSCHCN and CHCN ?
4. Are there consecutive RSCHCN?
5. What is the density of RSCHCN ?
6. Is there any sequence of RSCHCN following a definite mathematical patterns?
7. How many prime numbers are there in RSCHCN ?
8. Are there RSCHCN and *Happy Number* at the same time ?
9. Is there a relation between RSCHCN and the following numbers : *Happy Numbers , Fibonacci Numbers , Lucas Numbers , and Pell Numbers* ?
10. What about other bases or higher powers of RSCHCN?
11. Are there RSCHCN, 2, 3,4,5 ,... etc , consecutive RSCHCN?

Definition 7 : If there are union between the set of the (FHCN) and (CHCN) , We will get the *General Happy Cube Numbers* (GHCN), namely ;

$GHCN = \{1, 55, 133, 136, 153, 160, 217, 244, 250, 352, 370, 371, 407, 919, 1459, \dots\}$.

Definition 8 : *Smarandache General Happy Cube Numbers* ,formed from GHCN i.e.

$SGHCN = \{1, 155, 155133, 155133136, 155133136153, \dots\}$.

Definition 9 : *Reversed Smarandache General Happy Cube Numbers* , which formed from SGHCN , i.e.

$RSGHCN = \{1, 551, 133551, 136133551, 160153136133551, \dots\}$.

All the above opened questions need answers .

Curious notes :

- 1) The digit 8 doesn't appear . So is there happy cube number has in its digits the digit 8?, or as I think it is impossible !
- 2) The sum of the digits of any General Happy Cube Number follows the pattern $\{ 1, 10, 7, 10, 9, 7, 10, 10, 7, 10, 10, 11, 9, 19, 19, \dots\}$.

Acknowledgment: The author is grateful for Mr. Akram Jawabreh.

References:

- 1) <http://www.shyamsundergupta.com/>
- 2) <http://www.gallup.unm.edu/~smarandache/eBooks-otherformats.htm>
- 3) <http://www.research.att.com/~njas/sequences/eisonline.html>.

ON THE DIVISOR PRODUCT SEQUENCES

ZHU WEIYI

College of Mathematics, Physics and Information
Science, Zhejiang Normal University
Jinhua, Zhejiang, P.R.China

ABSTRACT. The main purpose of this paper is to study the asymptotic property of the divisor product sequences, and obtain two interesting asymptotic formulas.

1. INTRODUCTION AND RESULTS

A natural number a is called a divisor product of n if it is the product of all positive divisors of n . We write it as $P_d(n)$, it is easily to prove that $P_d(n) = n^{\frac{d(n)}{2}}$, where $d(n)$ is the divisor function. We can also define the proper divisor product of n as the product of all positive divisors of n but n , we denote it by $p_d(n)$, and $p_d(n) = n^{\frac{d(n)}{2}-1}$. It is clear that the $P_d(n)$ sequences is

$$1, 2, 3, 8, 5, 36, 7, 64, 27, 100, 11, 1728, 13, 196, 225, \dots;$$

The $p_d(n)$ sequences is

$$1, 1, 1, 2, 1, 6, 1, 8, 3, 10, 1, 144, 1, 14, 15, 64, 1, 324, 1, 1, 400, 21, \dots.$$

In reference [1], Professor F. Smarandache asked us to study the properties of these two sequences. About these problems, it seems that none had studied them before. In this paper, we use the analytic methods to study the asymptotic properties of these sequences, and obtain two interesting asymptotic formulas. That is, we shall prove the following two Theorems.

Theorem 1. For any real number $x \geq 1$, we have the asymptotic formula

$$\sum_{n \leq x} \frac{1}{P_d(n)} = \ln \ln x + C_1 + O\left(\frac{1}{\ln x}\right).$$

where C_1 is a constant.

Theorem 2. For any real number $x \geq 1$, we have the asymptotic formula

$$\sum_{n \leq x} \frac{1}{p_d(n)} = \pi(x) + (\ln \ln x)^2 + B \ln \ln x + C_2 + O\left(\frac{\ln \ln x}{\ln x}\right).$$

where $\pi(x)$ is the number of all primes $\leq x$, B and C_2 are constants.

Key words and phrases. Divisor products of n ; Proper divisor products of n ; Asymptotic formula..

2. SOME LEMMAS

To complete the proof of the theorems, we need following several lemmas.

Lemma 1. *For any real number $x \geq 2$, there is a constant A such that*

$$\sum_{p \leq x} \frac{1}{p} = \ln \ln x + A + O\left(\frac{1}{\ln x}\right).$$

Proof. See Theorem 4.12 of reference [2].

Lemma 2. *Let $x \geq 2$, then we have*

$$\sum_{p \leq x} \frac{\ln p}{p} = \ln x + C + O\left(\frac{1}{\ln x}\right).$$

where C is constant.

Proof. See reference [4].

Lemma 3. *Let $x \geq 4$, p and q are primes. Then we have the asymptotic formula*

$$\sum_{pq \leq x} \frac{1}{pq} = (\ln \ln x)^2 + A \ln \ln x + C_3 + O\left(\frac{\ln \ln x}{\ln x}\right),$$

where A and C_3 are constants.

Proof. From Lemma 1 and Lemma 2 we have

$$\begin{aligned} \sum_{pq \leq x} \frac{1}{pq} &= 2 \sum_{p \leq \sqrt{x}} \frac{1}{p} \sum_{q \leq \frac{x}{p}} \frac{1}{q} - \left(\sum_{p \leq \sqrt{x}} \frac{1}{p} \right)^2 \\ &= 2 \sum_{p \leq \sqrt{x}} \frac{1}{p} \left(\ln \ln x + \ln \left(1 - \frac{\ln p}{\ln x}\right) + A + O\left(\frac{1}{\ln x}\right) \right) \\ &\quad - \left(\ln \ln x + A - \ln 2 + O\left(\frac{1}{\ln x}\right) \right)^2 \\ &= 2 \sum_{p \leq \sqrt{x}} \frac{1}{p} \left(\ln \ln x - \left(\frac{\ln p}{\ln x} + \frac{1}{2} \left(\frac{\ln p}{\ln x}\right)^2 + \frac{1}{3} \left(\frac{\ln p}{\ln x}\right)^3 + \dots + \frac{1}{n} \left(\frac{\ln p}{\ln x}\right)^n + \dots \right) \right) \\ &\quad + 2A \sum_{p \leq \sqrt{x}} \frac{1}{p} + O\left(\frac{\ln \ln x}{\ln x}\right) - \left(\ln \ln x + A - \ln 2 + O\left(\frac{1}{\ln x}\right) \right)^2 \\ &= (\ln \ln x)^2 + 2A \ln \ln x + C_3 + O\left(\frac{\ln \ln x}{\ln x}\right). \end{aligned}$$

This proves Lemma 3.

3. PROOF OF THE THEOREMS

In this section, we shall complete the proof of the Theorems. First we prove Theorem 2. Note that the definition of $p_d(n)$, we can separate n into four parts according to $d(n) = 2, 3, 4$ or $d(n) \geq 5$.

$$d(n) = \begin{cases} 2, & \text{if } n = p, p_d(n) = 1; \\ 3, & \text{if } n = p^2, p_d(n) = p; \\ 4, & \text{if } n = p_i p_j \text{ or } n = p^3; p_d(n) = p_i p_j \text{ or } p^3; \\ \geq 5, & \text{others, } p_d(n) = n^{\frac{d(n)}{2}-1}. \end{cases}$$

Then by Lemma 1, 2 and 3 we have

$$\begin{aligned} \sum_{n \leq x} \frac{1}{p_d(n)} &= \sum_{p \leq x} 1 + \sum_{p_i p_j \leq x} \frac{1}{p_i p_j} + \sum_{p^2 \leq x} \frac{1}{p} + \sum_{p^3 \leq x} \frac{1}{p^3} + \sum_{n \leq x, d(n) \geq 5} \frac{1}{n^{\frac{d(n)}{2}-1}} \\ &= \pi(x) + (\ln \ln x)^2 + 2A \ln \ln x + C_3 + O\left(\frac{\ln \ln x}{\ln x}\right) + \ln \ln x + A - \\ &\quad \ln 2 + O\left(\frac{1}{\ln x}\right) + C_4 + O\left(\frac{1}{x^{\frac{1}{3}}}\right) + C_5 + O\left(\frac{1}{\sqrt{x}}\right) \\ &= \pi(x) + (\ln \ln x)^2 + B \ln \ln x + C_2 + O\left(\frac{\ln \ln x}{\ln x}\right). \end{aligned}$$

This completes the proof of Theorem 2.

Similarly, we can also prove Theorem 1. Note that the definition of $P_d(n)$, we have

$$\begin{aligned} \sum_{n \leq x} \frac{1}{P_d(n)} &= \sum_{p \leq x} \frac{1}{p} + \sum_{p_i p_j \leq x} \frac{1}{(p_i p_j)^2} + \sum_{p^2 \leq x} \frac{1}{p^3} + \sum_{p^3 \leq x} \frac{1}{p^6} + \sum_{n \leq x, d(n) \geq 5} \frac{1}{n^{\frac{d(n)}{2}}} \\ &= \ln \ln x + C_1 + O\left(\frac{1}{\ln x}\right). \end{aligned}$$

This completes the proof of Theorem 1.

REFERENCES

1. F. Smarndache, *ONLY PROBLEMS, NOT SOLUTION!*, Xiquan Publishing House, Chicago, 1993, pp. 24-25.
2. Tom M. Apostol, *Introduction to Analytic Number Theory*, Springer-Verlag, New York, 1976.
3. Pan Chengdong and Pan Chengbiao, *Elementary Number Theory*, Beijing University Press, Beijing, 1992, pp. 440-447.
4. J.B. Rosser and L. Schoenfeld, *Approximate formulas for some functions of prime numbers*, Illinois J. Math. **6** (1962), 64-94.

ON THE CUBIC RESIDUES NUMBERS AND k -POWER COMPLEMENT NUMBERS

ZHANG TIANPING

Department of Mathematics, Northwest University
Xi'an, Shaanxi, P.R.China

ABSTRACT. The main purpose of this paper is to study the asymptotic property of the the cubic residues and k -power complement numbers (where $k \geq 2$ is a fixed integer), and obtain some interesting asymptotic formulas.

1. INTRODUCTION AND RESULTS

Let a natural number $n = p_1^{\alpha_1} \cdot p_2^{\alpha_2} \cdots p_r^{\alpha_r}$, then $a_3(n) = p_1^{\beta_1} \cdot p_2^{\beta_2} \cdots p_r^{\beta_r}$ is called a cubic-power residues number, where $\beta_i = \min(2, \alpha_i)$, $1 \leq i \leq r$; Also let $k \geq 2$ is a fixed integer, if $b_k(n)$ is the smallest integer that makes $nb_k(n)$ a perfect k -power, we call $b_k(n)$ as a k -power complement number. In problem 64 and 29 of reference [1], Professor F. Smarandache asked us to study the properties of the cubic residues numbers and k -power complement numbers sequences. By them we can define a new number sequences $a_3(n)b_k(n)$. In this paper, we use the analytic method to study the asymptotic properties of this new sequences, and obtain some interesting asymptotic formulas. That is, we shall prove the following four Theorems.

Theorem 1. For any real number $x \geq 1$, we have the asymptotic formula

$$\sum_{n \leq x} a_3(n)b_k(n) = \frac{6x^{k+1}}{(k+1)\pi^2} R(k+1) + O\left(x^{k+\frac{1}{2}+\varepsilon}\right),$$

where ε denotes any fixed positive number, and

$$R(k+1) = \prod_p \left(1 + \frac{p^3 + p}{p^7 + p^6 - p - 1}\right)$$

if $k = 2$ and

$$R(k+1) = \prod_p \left(1 + \sum_{j=2}^k \frac{p^{k-j+3}}{(p+1)p^{(k+1)j}} + \sum_{j=1}^k \frac{p^{k-j+3}}{(p+1)(p^{(k+1)(k+j)} - p^{(k+1)j})}\right)$$

if $k \geq 3$.

Key words and phrases. cubic residues numbers; k -power complement numbers; Asymptotic formula; Arithmetic function.

Theorem 2. Let $\varphi(n)$ is the Euler function. Then for any real number $x \geq 1$, we have the asymptotic formula

$$\sum_{n \leq x} \varphi(a_3(n)b_k(n)) = \frac{6x^{k+1}}{(k+1)\pi^2} R^*(k+1) + O\left(x^{k+\frac{1}{2}+\varepsilon}\right)$$

where

$$R^*(k+1) = \prod_p \left(1 + \frac{p^2+1}{p^6+2p^5+2p^4+2p^3+2p^2+2p+1} - \frac{1}{p^2+p} \right)$$

if $k = 2$, and

$$R^*(k+1) = \prod_p \left(1 - \frac{1}{p^2+p} + \sum_{j=2}^k \frac{p^{k-j+3} - p^{k-j+2}}{(p+1)p^{(k+1)j}} + \sum_{j=1}^k \frac{p^{k-j+3} - p^{k-j+2}}{(p+1)(p^{(k+1)(k+j)} - p^{(k+1)j})} \right)$$

if $k \geq 3$.

Theorem 3. Let $\alpha > 0$, $\sigma_\alpha(n) = \sum_{d|n} d^\alpha$. Then for any real number $x \geq 1$, we have the asymptotic formula

$$\sum_{n \leq x} \sigma_\alpha(a_3(n)b_k(n)) = \frac{6x^{k\alpha+1}}{(k\alpha+1)\pi^2} R(k\alpha+1) + O\left(x^{k\alpha+\frac{1}{2}+\varepsilon}\right),$$

where

$$R(k\alpha+1) = \prod_p \left(1 + \frac{p}{p+1} \left(\frac{p^\alpha+1}{p^{2\alpha+1}} + \frac{(p^{3\alpha}-1)p^{2\alpha+1} + p^{4\alpha}-1}{(p^{3(2\alpha+1)} - p^{2\alpha+1})(p^\alpha-1)} \right) \right)$$

if $k = 2$, and

$$R(k\alpha+1) = \prod_p \left(1 + \frac{p^{k\alpha+1} - p}{(p+1)(p^\alpha-1)p^{k\alpha+1}} + \sum_{j=2}^k \frac{p^{(k-j+3)\alpha+1} - p}{(p+1)(p^\alpha-1)p^{(k\alpha+1)j}} \right. \\ \left. + \sum_{j=1}^k \frac{p^{(k-j+3)\alpha+1} - p}{(p+1)(p^\alpha-1)(p^{(k+j)(k\alpha+1)} - p^{(k\alpha+1)j})} \right)$$

if $k \geq 3$.

Theorem 4. Let $d(n)$ denotes Dirichlet divisor function. Then for any real number $x \geq 1$, we have the asymptotic formula

$$\sum_{n \leq x} d(a_3(n)b_k(n)) = \frac{6x}{\pi^2} R(1) \cdot f(\log x) + O\left(x^{\frac{1}{2}+\varepsilon}\right),$$

where $f(y)$ is a polynomial of y with degree k . and

$$R(1) = \prod_p \left(1 + \frac{p^3}{(p+1)^3} \left(\frac{3p+4}{p^3+p} - \frac{3}{p^2} - \frac{1}{p^3} \right) \right)$$

if $k = 2$, and

$$R(1) = \prod_p \left(1 + \sum_{j=2}^k \frac{\left(k-j+3 - \binom{k+1}{j} \right) p^{k-j+1}}{(p+1)^{k+1}} + \sum_{j=1}^k \frac{k-j+3}{(p+1)^{k+1}(p^{j-1} - p^{j-k-1})} - \frac{1}{(p+1)^{k+1}} \right)$$

if $k \geq 3$.

2. PROOF OF THE THEOREMS

In this section, we shall complete the proof of the Theorems. Let

$$f(s) = \sum_{n=1}^{\infty} \frac{a_3(n)b_k(n)}{n^s}.$$

From the Euler product formula [2] and the definition of $a_3(n)$ and $b_k(n)$ we have

$$\begin{aligned} f(s) &= \prod_p \left(1 + \frac{a_3(p)b_k(p)}{p^s} + \frac{a_3(p^2)b_k(p^2)}{p^{2s}} + \dots \right) \\ &= \prod_p \left(1 + \frac{1}{p^{s-2}} + p^2 \left(\frac{1}{p^{2s}} + \frac{p}{p^{3s}} \right) \left(\frac{1}{1-p^{-2s}} \right) \right) \\ &= \frac{\zeta(s-k)}{\zeta(2(s-k))} \prod_p \left(1 + \frac{p^s + p}{(p^{s-2} + 1)(p^{2s} - 1)} \right) \end{aligned}$$

if $k = 2$, and

$$\begin{aligned} f(s) &= \prod_p \left(1 + \frac{a_3(p)b_k(p)}{p^s} + \frac{a_3(p^2)b_k(p^2)}{p^{2s}} + \dots \right) \\ &= \prod_p \left(1 + \frac{1}{p^{s-k}} + p^2 \sum_{j=2}^k \frac{p^{k-j}}{p^{js}} + \left(\frac{1}{1 - \frac{1}{p^{ks}}} \right) \sum_{j=1}^k \frac{p^{k-j+2}}{p^{(k+j)s}} \right) \\ &= \prod_p \left(1 + \frac{1}{p^{s-k}} \left(1 + \frac{p^{s-k}}{1 + p^{s-k}} \left(\sum_{j=2}^k \frac{p^{k-j+2}}{p^{js}} + \sum_{j=1}^k \frac{p^{k-j+2}}{p^{(k+j)s} - p^{js}} \right) \right) \right) \\ &= \frac{\zeta(s-k)}{\zeta(2(s-k))} \prod_p \left(1 + \sum_{j=2}^k \frac{p^{s-j+2}}{(p^{s-k} + 1)p^{js}} + \sum_{j=1}^k \frac{p^{s-j+2}}{(p^{s-k} + 1)(p^{(k+j)s} - p^{js})} \right) \end{aligned}$$

if $k \geq 3$.

Obviously, we have inequality

$$|a_m(n)b_k(n)| \leq n^2, \quad \left| \sum_{n=1}^{\infty} \frac{a_m(n)b_k(n)}{n^\sigma} \right| < \frac{1}{\sigma - k - 1},$$

where $\sigma > k + 1$ is the real part of s . So by Perron formula [3]

$$\begin{aligned} \sum_{n \leq x} \frac{a_m(n)b_k(n)}{n^{\sigma_0}} &= \frac{1}{2i\pi} \int_{b-iT}^{b+iT} f(s+s_0) \frac{x^s}{s} ds + O\left(\frac{x^b B(b+\sigma_0)}{T}\right) \\ &\quad + O\left(x^{1-\sigma_0} H(2x) \min\left(1, \frac{\log x}{T}\right)\right) + O\left(x^{-\sigma_0} H(N) \min\left(1, \frac{x}{\|x\|}\right)\right), \end{aligned}$$

where N is the nearest integer to x , $\|x\| = |x - N|$. Taking $s_0 = 0$, $b = k + 2$, $T = x^{\frac{3}{2}}$, $H(x) = x^2$, $B(\sigma) = \frac{1}{\sigma - k - 1}$, we have

$$\sum_{n \leq x} a_m(n)b_k(n) = \frac{1}{2i\pi} \int_{k+2-iT}^{k+2+iT} \frac{\zeta(s-k)}{\zeta(2(s-k))} R(s) \frac{x^s}{s} ds + O(x^{k+\frac{1}{2}+\varepsilon}),$$

where

$$R(s) = \begin{cases} \prod_p \left(1 + \frac{p^s + p}{(p^{s-2} + 1)(p^{2s} - 1)} \right) & \text{if } k = 2; \\ \prod_p \left(1 + \sum_{j=2}^k \frac{p^{s-j+2}}{(p^{s-k} + 1)p^{js}} + \sum_{j=1}^k \frac{p^{s-j+2}}{(p^{s-k} + 1)(p^{(k+j)s} - p^{js})} \right) & \text{if } k \geq 3. \end{cases}$$

To estimate the main term

$$\frac{1}{2i\pi} \int_{k+2-iT}^{k+2+iT} \frac{\zeta(s-k)}{\zeta(2(s-k))} R(s) \frac{x^s}{s} ds + O(x^{k+\frac{1}{2}+\epsilon}),$$

we move the integral line from $s = k + 2 \pm iT$ to $s = k + \frac{1}{2} \pm iT$. This time, the function

$$f(s) = \frac{\zeta(s-k)x^s}{\zeta(2(s-k))s} R(s)$$

have a simple pole point at $s = k + 1$ with residue $\frac{x^{k+1}}{(k+1)\zeta(2)} R(k+1)$. So we have

$$\begin{aligned} & \frac{1}{2i\pi} \left(\int_{k+2-iT}^{k+2+iT} + \int_{k+2+iT}^{k+\frac{1}{2}+iT} + \int_{k+\frac{1}{2}+iT}^{k+\frac{1}{2}-iT} + \int_{k+\frac{1}{2}-iT}^{k+2-iT} \right) \frac{\zeta(s-k)x^s}{\zeta(2(s-k))s} R(s) ds \\ &= \frac{x^{k+1}}{(k+1)\zeta(2)} R(k+1). \end{aligned}$$

We can easy get the estimate

$$\begin{aligned} & \left| \frac{1}{2\pi i} \left(\int_{k+2+iT}^{k+\frac{1}{2}+iT} + \int_{k+\frac{1}{2}-iT}^{k+2-iT} \right) \frac{\zeta(s-k)x^s}{\zeta(2(s-k))s} R(s) ds \right| \\ & \ll \int_{k+\frac{1}{2}}^{k+2} \left| \frac{\zeta(\sigma-k+iT)}{\zeta(2(\sigma-k+iT))} R(s) \frac{x^\sigma}{T} \right| d\sigma \ll \frac{x^{k+2}}{T} = x^{k+\frac{1}{2}}; \end{aligned}$$

and

$$\left| \frac{1}{2\pi i} \int_{k+\frac{1}{2}+iT}^{k+\frac{1}{2}-iT} \frac{\zeta(s-k)x^s}{\zeta(2(s-k))s} R(s) ds \right| \ll \int_0^T \left| \frac{\zeta(1/2+it)}{\zeta(1+2it)} \frac{x^{k+\frac{1}{2}}}{t} \right| dt \ll x^{k+\frac{1}{2}+\epsilon}.$$

Note that $\zeta(2) = \frac{\pi^2}{6}$, from the above we have

$$\sum_{n \leq x} a_3(n)b_k(n) = \frac{6x^{k+1}}{(k+1)\pi^2} R(k+1) + O(x^{k+\frac{1}{2}+\epsilon}).$$

This completes the proof of Theorem 1.

Let

$$f_1(s) = \sum_{n=1}^{\infty} \frac{\varphi(a_3(n)b_k(n))}{n^s}, \quad f_2(s) = \sum_{n=1}^{\infty} \frac{\sigma_\alpha(a_3(n)b_k(n))}{n^s}, \quad f_3(s) = \sum_{n=1}^{\infty} \frac{d(a_3(n)b_k(n))}{n^s}.$$

From the Euler product formula [2] and the definition of $\varphi(n)$, $\sigma_\alpha(n)$ and $d(n)$, we also have

$$\begin{aligned}
f_1(s) &= \prod_p \left(1 + \frac{\varphi(a_3(p)b_k(p))}{p^s} + \frac{\varphi(a_3(p^2)b_k(p^2))}{p^{2s}} + \dots \right) \\
&= \prod_p \left(1 + \frac{p^2 - p}{p^s} + \left(\frac{p^2 - p}{p^{2s}} + \frac{p^3 - p^2}{p^{3s}} \right) \left(\frac{1}{1 - p^{-2s}} \right) \right) \\
&= \prod_p \left(1 + \frac{1}{p^{s-2}} - \frac{1}{p^{s-1}} + \frac{(p^2 - p)(p^s + p)}{p^{3s} - p^s} \right) \\
&= \frac{\zeta(s-2)}{\zeta(2(s-2))} \prod_p \left(1 + \frac{p^{s-2}}{p^{s-2} + 1} \left(\frac{(p^2 - p)(p^s + p)}{p^{3s} - p^s} - \frac{1}{p^{s-1}} \right) \right)
\end{aligned}$$

if $k = 2$, and

$$\begin{aligned}
f_1(s) &= \prod_p \left(1 + \frac{1}{p^{s-k}} - \frac{1}{p^{s-k+1}} + \sum_{j=2}^k \frac{p^{k-j+2} - p^{k-j+1}}{p^{js}} + \sum_{j=1}^k \frac{p^{k-j+2} - p^{k-j+1}}{p^{(k+j)s} - p^{js}} \right) \\
&= \frac{\zeta(s-k)}{\zeta(2(s-k))} \prod_p \left(1 - \frac{1}{p^{s-k+1} + p} + \sum_{j=2}^k \frac{p^{s-j+2} - p^{s-j+1}}{(p^{s-k} + 1)p^{js}} + \sum_{j=1}^k \frac{p^{s-j+2} - p^{s-j+1}}{(p^{s-k} + 1)(p^{(k+j)s} - p^{js})} \right)
\end{aligned}$$

if $k \geq 3$.

$$f_2(s) = \frac{\zeta(s-2\alpha)}{\zeta(2(s-2\alpha))} \prod_p \left(1 + \frac{p^{s-2\alpha}}{p^{s-2\alpha} + 1} \left(\frac{p^\alpha + 1}{p^s} + \frac{(p^{3\alpha} - 1)p^s + p^{4\alpha} - 1}{(p^{3s} - p^s)(p^\alpha - 1)} \right) \right)$$

if $k = 2$, and

$$\begin{aligned}
f_2(s) &= \frac{\zeta(s-k\alpha)}{\zeta(2(s-k\alpha))} \prod_p \left(1 + \frac{p^s - p^{s-k\alpha}}{(p^{s-k\alpha} + 1)(p^\alpha - 1)p^s} + \sum_{j=2}^k \frac{p^{(3-j)\alpha+s} - p^{s-k\alpha}}{(p^{s-k\alpha} + 1)(p^\alpha - 1)p^{js}} \right. \\
&\quad \left. + \sum_{j=1}^k \frac{p^{(3-j)\alpha+s} - p^{s-k\alpha}}{(p^{s-k\alpha} + 1)(p^\alpha - 1)(p^{(k+j)s} - p^{js})} \right)
\end{aligned}$$

if $k \geq 3$.

$$f_3(s) = \frac{\zeta^3(s)}{\zeta^3(2s)} \prod_p \left(1 + \frac{p^{3s}}{(p^s + 1)^3} \left(\frac{3p^s + 4}{p^{3s} + p^s} - \frac{3}{p^{2s}} - \frac{1}{p^{3s}} \right) \right)$$

if $k = 2$, and

$$\begin{aligned}
f_3(s) &= \frac{\zeta^{k+1}(s)}{\zeta^{k+1}(2s)} \prod_p \left(1 + \sum_{j=2}^k \frac{\left(k - j + 3 - \binom{k+1}{j} \right) p^{(k-j+1)s}}{(p^s + 1)^{k+1}} \right. \\
&\quad \left. + \sum_{j=1}^k \frac{k - j + 3}{(p^s + 1)^{k+1} (p^{(j-1)s} - p^{(j-k-1)s})} - \frac{1}{(p^s + 1)^{k+1}} \right)
\end{aligned}$$

if $k \geq 3$.

By Perron formula [3] and the method of proving Theorem 1, we can obtain the other results. Generally we can use the same method to study the asymptotic properties of the number sequences $a_m(n)b_k(n)$ (where $m, k \geq 2$ are fixed integers), and obtain some interesting asymptotic formulas.

REFERENCES

1. F. Smarandache, *ONLY PROBLEMS, NOT SOLUTION!*, Xiquan Publishing House, Chicago, 1993, pp. 27.
2. Tom M. Apostol, *Introduction to Analytic Number Theory*, Springer-Verlag, New York, 1976.
3. Pan Chengdong and Pan Chengbiao, *Foundation of Analytic Number Theory*, Science Press, Beijing, 1997, pp. 98.

A CONJECTURE CONCERNING THE SMARANDACHE DUAL FUNCTION

Maohua Le

Department of Mathematics
Zhanjiang Normal College
29 Cunjin Road, Chikan
Zhanjiang, Guangdong
P.R.China

Abstract: In this paper we verify a conjecture concerning the Smarandache dual function.

Key words: Smarandache dual function; factorial; gap of primes

For any positive integers n , let $S^*(n)$ denote the greatest positive integer m such that $n \equiv 0 \pmod{m!}$. Then $S^*(n)$ is called the Smarandache dual function. In [2], Sandos conjectured that

$$S^*((2k-1)!(2k+1)!)=q-1, \quad (1)$$

Where k is a positive integer, q is the first prime following $2k+1$. In this paper we prove the following result.

Theorem. (1) holds for any positive integer k .

Proof. Since q is a prime with $q > 2k+1$, we have

$$(2k-1)!(2k+1)! \not\equiv 0 \pmod{q}. \quad (2)$$

Supported by the National Natural Science Foundation of China (No.10271104), the Guangdong Provincial Natural Science Foundation (No.011781) and the Natural Science Foundation of the Education Department of Guangdong Province (No.0161).

It implies that $S^*((2k-1)!(2k+1)!) \leq q-1$. Further, since q is the least prime with $q > 2k+1$, by Bertrand Postulate (see [1, Theorem 418]), we have

$$q > 2(2k+1). \quad (3)$$

Hence, by (3), any prime divisor p of $q-1$ satisfies

$$p \leq 2k-1. \quad (4)$$

For any positive integer a and any prime p , let $\text{ord}_p a$ denote the order of p in a . It is a well known fact that

$$\text{ord}_p n! = \sum_{r=1}^{\infty} \left[\frac{n}{p^r} \right], \quad (5)$$

where $[x]$ is the Gauss function of x . We now suppose that $S^*((2k-1)!(2k+1)!) < q-1$. Then there exists a prime p such that

$$\text{ord}_p(2k-1)! + \text{ord}_p(2k+1)! < \text{ord}_p(q-1)!. \quad (6)$$

Hence, by (5) and (6), we get

$$\left[\frac{2k-1}{p^r} \right] + \left[\frac{2k+1}{p^r} \right] < \left[\frac{q-1}{p^r} \right] \quad (7)$$

for a suitable positive integer r . From (7), we get

$$\left[\frac{2k-1}{p^r} \right] + \left[\frac{2k+1}{p^r} \right] + 1 \leq \left[\frac{q-1}{p^r} \right], \quad (8)$$

whence we obtain

$$4k < q-1. \quad (8)$$

It follows that $q \geq 4k+2$, a contradiction with (3). Thus, we get $S^*((2k-1)!(2k+1)!) = q-1$. The theorem is proved.

References

- [1] G.H.Hardy and E.M.Wright, An introduction to the theory of numbers, Oxford University Press, Oxford, 1938.
- [2] J. Sandor, On certain generalizations of the Smarandache function, Smarandache Notions J. 11(2000), 2002-212.

A NOTE ON THE 29-TH SMARANDACHE'S PROBLEM*

LIU HONGYAN¹ AND LOU YUANBING²

1 Department of Mathematics, Xi'an University of Technology
Xi'an, Shaanxi, P.R.China

2 Department of Mathematics and Physics, Tibet University
Lasa, Tibet, P.R.China

ABSTRACT. Let n be a positive integer, $a_k(n)$ be the k -th complement number of n . In this paper, we study the mean value properties of the k -th complement number sequences, and give an interesting asymptotic formula.

Classification Number: 11B37 11B39

1. INTRODUCTION

For any positive integer n to find the smallest integer $a_k(n)$ such that $na_k(n)$ is a perfect k -power ($k \geq 2$), we define that $a_k(n)$ is the k -th complement number of n . Let $n = p_1^{\alpha_1} p_2^{\alpha_2} \cdots p_m^{\alpha_m}$, then $a_k(n) = p_1^{\beta_1} p_2^{\beta_2} \cdots p_m^{\beta_m}$, where $\alpha_i + \beta_i \equiv 0 \pmod{k}$ and $\beta_i < k$, $i = 1, 2, \dots, m$. In problem 29 of [1], Professor F.Smarandach asked us to study the properties of the k -th complement number sequences. In this paper, we use the analytic methods to study the mean value properties of this sequences, and give an interesting asymptotic formula. That is, we shall prove the following:

Theorem. For any positive number $x > 1$, we have the asymptotic formula

$$\sum_{n \leq x} \frac{d(a_k(n))}{\phi(a_k(n))} = kx^{\frac{1}{k}} g(k) + O\left(x^{\frac{1}{2k} + \varepsilon}\right),$$

where $g(k) = \prod_p \left[1 + \frac{k}{p^{\frac{1}{k} + k - 2}(p-1)} + \frac{k-1}{p^{\frac{2}{k} + k - 3}(p-1)} + \cdots + \frac{2}{p^{\frac{k-1}{k} + k - 2}(p-1)} \right]$, $d(n)$ is the Dirichlet divisor function, $\phi(n)$ is Euler function, ε is any fixed positive number.

Especially taking $k = 2$, we have

Corollary. For any positive number $x > 1$, we have the asymptotic formula

$$\sum_{n \leq x} \frac{d(a_2(n))}{\phi(a_2(n))} = 2x^{\frac{1}{2}} \prod_p \left(1 + \frac{2}{\sqrt{p}(p-1)} \right) + O\left(x^{\frac{1}{4} + \varepsilon}\right).$$

Key words and phrases. complement number; mean value properties; asymptotic formula.

* This work is supported by the N.S.F. and the P.S.F. of P.R.China.

2. PROOF OF THE THEOREM

In this section, we shall complete the proof of the Theorem. Let

$$f(s) = \sum_{n=1}^{\infty} \frac{d(a_k(n))}{\phi(a_k(n))n^s}.$$

From the Euler product formula [2] and the definition of $a_k(n)$ we have

$$\begin{aligned} f(s) &= \sum_{n=1}^{\infty} \frac{d(a_k(n))}{\phi(a_k(n))n^s} \\ &= \prod_p \left(1 + \frac{d(a_k(p))}{\phi(a_k(p))p^s} + \frac{d(a_k(p^2))}{\phi(a_k(p^2))p^{2s}} + \cdots + \frac{d(a_k(p^k))}{\phi(a_k(p^k))p^{ks}} + \frac{d(a_k(p^{k+1}))}{\phi(a_k(p^{k+1}))p^{(k+1)s}} + \cdots \right) \\ &= \prod_p \left(1 + \frac{d(p^{k-1})}{\phi(p^{k-1})p^s} + \frac{d(p^{k-2})}{\phi(p^{k-2})p^{2s}} + \cdots + \frac{1}{p^{ks}} + \frac{d(p^{k-1})}{\phi(p^{k-1})p^{(k+1)s}} + \cdots \right) \\ &= \prod_p \left[\frac{1}{1 - \frac{1}{p^{ks}}} + \frac{d(p^{k-1})}{\phi(p^{k-1})p^s \left(1 - \frac{1}{p^{ks}}\right)} + \cdots + \frac{d(p)}{\phi(p)p^{(k-1)s} \left(1 - \frac{1}{p^{ks}}\right)} \right] \\ &= \zeta(k s) \prod_p \left[1 + \frac{d(p^{k-1})}{\phi(p^{k-1})p^s} + \frac{d(p^{k-2})}{\phi(p^{k-2})p^{2s}} + \cdots + \frac{d(p)}{\phi(p)p^{(k-1)s}} \right] \\ &= \zeta(k s) \prod_p \left[1 + \frac{k}{p^{k-2}(p-1)p^s} + \frac{k-1}{p^{k-3}(p-1)p^{2s}} + \cdots + \frac{2}{(p-1)p^{(k-1)s}} \right]. \end{aligned}$$

where $\zeta(s)$ is Riemann-zeta function. Taking $b = \frac{1}{k} + \frac{1}{\log x}$, $T = x^{\frac{1}{2k}}$, then by Perron formula [3] we have

$$\begin{aligned} \sum_{n \leq x} \frac{d(a_k(n))}{\phi(a_k(n))} &= \frac{1}{2\pi i} \int_{b-iT}^{b+iT} f(s) \frac{x^s}{s} ds + O\left(\frac{x^b}{T}\right) + O\left(\frac{x^{\frac{1}{k}} \log x}{T}\right) \\ &= \frac{1}{2\pi i} \int_{b-iT}^{b+iT} f(s) \frac{x^s}{s} ds + O\left(x^{\frac{1}{2k} + \varepsilon}\right). \end{aligned}$$

Taking $a = \frac{1}{2k} + \frac{1}{\log x}$, we have

$$\begin{aligned} \frac{1}{2\pi i} \left(\int_{b-iT}^{b+iT} + \int_{b+iT}^{a+iT} + \int_{a+iT}^{a-iT} + \int_{a-iT}^{b-iT} \right) &= \text{Res} \left[f(s) \frac{x^s}{s}, \frac{1}{k} \right] \\ &= kx^{\frac{1}{k}} \prod_p \left[1 + \frac{k}{p^{\frac{1}{k} + k - 2}(p-1)} + \frac{k-1}{p^{\frac{2}{k} + k - 3}(p-1)} + \cdots + \frac{2}{p^{\frac{k-1}{k}}(p-1)} \right]. \end{aligned}$$

Note that the estimate

$$\left| \frac{1}{2\pi i} \int_{a-iT}^{a+iT} f(s) \frac{x^s}{s} \right| \ll x^{\frac{1}{2k} + \varepsilon};$$

$$\left| \frac{1}{2\pi i} \int_{a-iT}^{b-iT} f(s) \frac{x^s}{s} \right| \ll \frac{x^{\frac{1}{k}+\varepsilon}}{T} \ll x^{\frac{1}{2k}+\varepsilon},$$

and

$$\left| \frac{1}{2\pi i} \int_{a+iT}^{b+iT} f(s) \frac{x^s}{s} \right| \ll \frac{x^{\frac{1}{k}+\varepsilon}}{T} \ll x^{\frac{1}{2k}+\varepsilon},$$

we have

$$\begin{aligned} & \sum_{n \leq x} \frac{d(a_k(n))}{\phi(a_k(n))} \\ &= kx^{\frac{1}{k}} \prod_p \left[1 + \frac{k}{p^{\frac{1}{k}+k-2}(p-1)} + \frac{k-1}{p^{\frac{2}{k}+k-3}(p-1)} + \cdots + \frac{2}{p^{\frac{k-1}{k}}(p-1)} \right] + O\left(x^{\frac{1}{2k}+\varepsilon}\right). \end{aligned}$$

This completes the proof of the Theorem.

REFERENCES

1. F. Smarandache, *Only problems, not Solutions*, Xiquan Publ. House, Chicago, 1993, pp. 26.
2. Tom M. Apostol, *Introduction to Analytic Number Theory*, Springer-Verlag, New York, 1976.
3. Pan Chengdong and Pan Chengbiao, *Foundation of Analytic Number Theory*, Science Press, Beijing, 1997, pp. 98.
4. "Smarandache Sequences" at <http://www.gallup.unm.edu/~smarandache/snaqint.txt>.
5. "Smarandache Sequences" at <http://www.gallup.unm.edu/~smarandache/snaqint2.txt>.
6. "Smarandache Sequences" at <http://www.gallup.unm.edu/~smarandache/snaqint3.txt>.

ON THE k -FULL NUMBER SEQUENCES

XU ZHEFENG

Department of Mathematics, Northwest University
Xi'an, Shaanxi, P.R.China

ABSTRACT. The main purpose of this paper is to study the asymptotic property of the k -full numbers (where $k \geq 2$ is a fixed integer), and obtain some interesting asymptotic formulas.

1. INTRODUCTION AND RESULTS

Let $k \geq 2$ is a fixed integer, a natural number n is called a k -power free number if $p^k \nmid n$ for any prime p . If $p \mid n$ implies $p^k \mid n$, we call n as a k -full number. In problem 31 of reference [1], Professor F. Smarandache asked us to study the properties of the k -power free number sequences. It is clear that there are some close relations between k -power free number sequences and k -full number sequences. In this paper, we use the analytic method to study the asymptotic properties of k -full number sequences, and obtain some interesting asymptotic formulas. That is, we shall prove the following six Theorems.

Theorem 1. For any real number $x \geq 1$, we have the asymptotic formula

$$\sum_{\substack{n \in A \\ n \leq x}} n = \frac{6k \cdot x^{1+\frac{1}{k}}}{(k+1)\pi^2} \prod_p \left(1 + \frac{1}{(p+1)(p^{\frac{1}{k}}-1)} \right) + O\left(x^{1+\frac{1}{2k}+\varepsilon}\right),$$

where ε denotes any fixed positive number.

Theorem 2. Let $\varphi(n)$ is the Euler function. Then for any real number $x \geq 1$, we have the asymptotic formula

$$\sum_{\substack{n \in A \\ n \leq x}} \varphi(n) = \frac{6k \cdot x^{1+\frac{1}{k}}}{(k+1)\pi^2} \prod_p \left(1 + \frac{p - p^{\frac{1}{k}}}{p^{2+\frac{1}{k}} - p^2 + p^{1+\frac{1}{k}} - p} \right) + O\left(x^{1+\frac{1}{2k}+\varepsilon}\right).$$

Key words and phrases. k -full number; Asymptotic formula; Arithmetic function. This work is supported by the N.S.F.(10271093) and P.N.S.F of P.R.China.

Theorem 3. Let $\alpha > 0$, $\sigma_\alpha(n) = \sum_{d|n} d^\alpha$. Then for any real number $x \geq 1$, we have the asymptotic formula

$$\sum_{\substack{n \in A \\ n \leq x}} \sigma_\alpha(n) = \frac{6k \cdot x^{\alpha + \frac{1}{k}}}{(k\alpha + 1)\pi^2} \prod_p \left(1 + \frac{p^{\alpha + \frac{1}{k}}(p^{\frac{1}{k}} - 1) \sum_{i=1}^k \left(\frac{1}{p^i}\right)^\alpha + p^{\alpha + \frac{1}{k}} + p^{\frac{1}{k}} - 1}{(p^{\alpha + \frac{1}{k}} - 1)(p+1)(p^{\frac{1}{k}} - 1)} \right) + O\left(x^{\alpha + \frac{1}{2k} + \varepsilon}\right).$$

Theorem 4. Let $d(n)$ denotes Dirichlet divisor function. Then for any real number $x \geq 1$, we have the asymptotic formula

$$\sum_{\substack{n \in A \\ n \leq x}} d(n) = \frac{6k \cdot x^{\frac{1}{k}}}{\pi^2} \prod_p \left(1 + \frac{(2p^{\frac{1}{k}} - 1) \sum_{i=2}^{k+1} \binom{k+1}{i} p^{k+1-i} - k p^{k+\frac{1}{k}}}{(p+1)^{k+1} (p^{\frac{1}{k}} - 1)^2} \right) \cdot f(\log x) + O\left(x^{\frac{1}{2k} + \varepsilon}\right).$$

where $f(y)$ is a polynomial of y with degree k .

Theorem 5. For any real number $x \geq 1$, we have the asymptotic formula

$$\sum_{\substack{n \in A \\ n \leq x}} \sigma_\alpha((m, n)) = \frac{6k \cdot x^{\frac{1}{k}}}{\pi^2} \prod_{p \nmid m} \left(1 + \frac{1}{(p+1)(p^{\frac{1}{k}} - 1)} \right) \prod_{\substack{p^\beta \parallel m \\ \beta \leq k}} \left(1 + \frac{p^{\frac{1}{k}} \sum_{i=0}^{\beta} p^{i\alpha}}{p(p^{\frac{1}{k}} - 1)} \right) \times \prod_{\substack{p^\beta \parallel m \\ \beta > k}} \left(1 + \sum_{i=k}^{\beta-1} p^{-\frac{i}{k}} \sum_{j=0}^i p^{j\alpha} + \frac{p^{\frac{1}{k}} \sum_{i=0}^{\beta} p^{i\alpha}}{p(p^{\frac{1}{k}} - 1)} \right) \prod_{p|m} \left(\frac{p}{p+1} \right) + O\left(x^{\frac{1}{2k} + \varepsilon}\right).$$

where m is any fixed integer, (m, n) denotes greatest common divisor of m and n .

Theorem 6. For any real number $x \geq 1$, we have the asymptotic formula

$$\sum_{\substack{n \in A \\ n \leq x}} \sigma_\alpha((m, n)) = \frac{6k \cdot x^{\frac{1}{k}}}{\pi^2} \prod_{p \nmid m} \left(1 + \frac{1}{(p+1)(p^{\frac{1}{k}} - 1)} \right) \prod_{\substack{p^\beta \parallel m \\ \beta \leq k}} \left(1 + \frac{(p^\beta - p^{\beta-1}) p^{\frac{1}{k}}}{p(p^{\frac{1}{k}} - 1)} \right) \times \prod_{\substack{p^\beta \parallel m \\ \beta > k}} \left(1 + \sum_{i=k}^{\beta-1} p^{-\frac{i}{k}} (p^i - p^{i-1}) + \frac{(p^\beta - p^{\beta-1}) p^{\frac{1}{k}}}{p(p^{\frac{1}{k}} - 1)} \right) \prod_{p|m} \left(\frac{p}{p+1} \right) + O\left(x^{\frac{1}{2k} + \varepsilon}\right).$$

2. PROOF OF THE THEOREMS

In this section, we shall complete the proof of the Theorems. For conveniently we define a new number theory function $a(n)$ as follows:

$$a(n) = \begin{cases} 1, & \text{if } n = 1; \\ n, & \text{if } n \text{ is a } k\text{-full number} \\ 0, & \text{if } n \text{ is not a } k\text{-full number} \end{cases}$$

It is clear that

$$\sum_{\substack{n \in A \\ n \leq x}} n = \sum_{n \leq x} a(n).$$

Let

$$f(s) = \sum_{n=1}^{\infty} \frac{a(n)}{n^s}.$$

From the Euler product formula [2] and the definition of $a(n)$ we have

$$\begin{aligned} f(s) &= \prod_p \left(1 + \frac{a(p^k)}{p^{ks}} + \frac{a(p^{k+1})}{p^{(k+1)s}} + \dots \right) \\ &= \prod_p \left(1 + \frac{1}{p^{k(s-1)}} \frac{1}{1 - \frac{1}{p^{s-1}}} \right) \\ &= \prod_p \left(1 + \frac{1}{p^{k(s-1)}} \right) \prod_p \left(1 + \frac{1}{(p^{k(s-1)} + 1)(p^{s-1} - 1)} \right) \\ &= \frac{\zeta(k(s-1))}{\zeta(2k(s-1))} \prod_p \left(1 + \frac{1}{(p^{k(s-1)} + 1)(p^{s-1} - 1)} \right), \end{aligned}$$

where $\zeta(s)$ is Riemann zeta function. Obviously, we have inequality

$$|a(n)| \leq n, \quad \left| \sum_{n=1}^{\infty} \frac{a(n)}{n^\sigma} \right| < \frac{1}{\sigma - 1 - \frac{1}{k}},$$

where $\sigma > 1 - \frac{1}{k}$ is the real part of s . So by Perron formula [3]

$$\begin{aligned} \sum_{n \leq x} \frac{a(n)}{n^{\sigma_0}} &= \frac{1}{2i\pi} \int_{b-iT}^{b+iT} f(s+s_0) \frac{x^s}{s} ds + O\left(\frac{x^b B(b+\sigma_0)}{T}\right) \\ &\quad + O\left(x^{1-\sigma_0} H(2x) \min\left(1, \frac{\log x}{T}\right)\right) + O\left(x^{-\sigma_0} H(N) \min\left(1, \frac{x}{\|x\|}\right)\right), \end{aligned}$$

where N is the nearest integer to x , $\|x\| = |x - N|$. Taking $s_0 = 0$, $b = 2 + \frac{1}{k}$, $T = x^{1+\frac{1}{2k}}$, $H(x) = x$, $B(\sigma) = \frac{1}{\sigma-1-\frac{1}{k}}$, we have

$$\sum_{n \leq x} a(n) = \frac{1}{2i\pi} \int_{2+\frac{1}{k}-iT}^{2+\frac{1}{k}+iT} \frac{\zeta(k(s-1))}{\zeta(2k(s-1))} R(s) \frac{x^s}{s} ds + O(x^{1+\frac{1}{2k}+\epsilon}),$$

where

$$R(s) = \prod_p \left(1 + \frac{1}{(p^{k(s-1)} + 1)(p^{s-1} - 1)} \right).$$

To estimate the main term

$$\frac{1}{2i\pi} \int_{2+\frac{1}{k}-iT}^{2+\frac{1}{k}+iT} \frac{\zeta(k(s-1))x^s}{\zeta(2k(s-1))s} R(s) ds,$$

we move the integral line from $s = 2 + \frac{1}{k} \pm iT$ to $s = 1 + \frac{1}{2k} \pm iT$. This time, the function

$$f(s) = \frac{\zeta(k(s-1))x^s}{\zeta(2k(s-1))s}R(s)$$

have a simple pole point at $s = 1 + \frac{1}{k}$ with residue $\frac{kx^{1+\frac{1}{k}}}{(k+1)\zeta(2)}R(1 + \frac{1}{k})$. So we have

$$\begin{aligned} & \frac{1}{2i\pi} \left(\int_{2+\frac{1}{k}-iT}^{2+\frac{1}{k}+iT} + \int_{2+\frac{1}{k}+iT}^{1+\frac{1}{2k}+iT} + \int_{1+\frac{1}{2k}+iT}^{1+\frac{1}{2k}-iT} + \int_{1+\frac{1}{2k}-iT}^{2+\frac{1}{k}-iT} \right) \frac{\zeta(k(s-1))x^s}{\zeta(2k(s-1))s}R(s)ds \\ &= \frac{k \cdot x^{1+\frac{1}{k}}}{(k+1)\zeta(2)} \prod_p \left(1 + \frac{1}{(p+1)(p^{\frac{1}{k}}-1)} \right). \end{aligned}$$

We can easy get the estimate

$$\begin{aligned} & \left| \frac{1}{2\pi i} \left(\int_{2+\frac{1}{k}+iT}^{1+\frac{1}{2k}+iT} + \int_{1+\frac{1}{2k}-iT}^{2+\frac{1}{2}-iT} \right) \frac{\zeta(k(s-1))x^s}{\zeta(2k(s-1))s}R(s)ds \right| \\ & \ll \int_{1+\frac{1}{2k}}^{2+\frac{1}{k}} \left| \frac{\zeta(k(\sigma-1+iT))}{\zeta(2k(\sigma-1+iT))}R(s) \frac{x^{2+\frac{1}{k}}}{T} \right| d\sigma \ll \frac{x^{2+\frac{1}{k}}}{T} = x^{1+\frac{1}{2k}} \end{aligned}$$

and

$$\left| \frac{1}{2\pi i} \int_{1+\frac{1}{2k}+iT}^{1+\frac{1}{2k}-iT} \frac{\zeta(k(s-1))x^s}{\zeta(2k(s-2))s}R(s)ds \right| \ll \int_0^T \left| \frac{\zeta(1/2+ikt)}{\zeta(1+2ikt)} \frac{x^{1+\frac{1}{2k}}}{t} \right| dt \ll x^{1+\frac{1}{2k}+\varepsilon}.$$

Note that $\zeta(2) = \frac{\pi^2}{6}$, from the above we have

$$\sum_{\substack{n \in A \\ n \leq x}} n = \frac{6k \cdot x^{1+\frac{1}{k}}}{(k+1)\pi^2} \prod_p \left(1 + \frac{1}{(p+1)(p^{\frac{1}{k}}-1)} \right) + O\left(x^{1+\frac{1}{2k}+\varepsilon}\right).$$

This completes the proof of Theorem 1.

Let

$$\begin{aligned} f_1(s) &= \sum_{\substack{n=1 \\ n \in A}}^{\infty} \frac{\varphi(n)}{n^s}, & f_2(s) &= \sum_{\substack{n=1 \\ n \in A}}^{\infty} \frac{\sigma_{\alpha}(n)}{n^s}, & f_3(s) &= \sum_{\substack{n=1 \\ n \in A}}^{\infty} \frac{d(n)}{n^s}, \\ f_4(s) &= \sum_{\substack{n=1 \\ n \in A}}^{\infty} \frac{\sigma_{\alpha}((m, n))}{n^s}, & f_5(s) &= \sum_{\substack{n=1 \\ n \in A}}^{\infty} \frac{\varphi((m, n))}{n^s}. \end{aligned}$$

From the Euler product formula [2] and the definition of $\varphi(n)$, $\sigma_{\alpha}(n)$ and $d(n)$, we also have

$$\begin{aligned} f_1(s) &= \prod_p \left(1 + \frac{\varphi(p^k)}{p^{ks}} + \frac{\varphi(p^{k+1})}{p^{(k+1)s}} + \dots \right) = \prod_p \left(1 + \frac{\varphi(p^k)}{p^{ks}} \left(\frac{1}{1 - \frac{1}{p^{s-1}}} \right) \right) \\ &= \frac{\zeta(k(s-1))}{\zeta(2k(s-1))} \prod_p \left(1 + \frac{p - p^{s-1}}{(p^{k(s-1)} + 1)(p^s - p)} \right); \end{aligned}$$

$$f_2(s) = \frac{\zeta(k(s-\alpha))}{\zeta(2k(s-\alpha))} \prod_p \left(1 + \frac{(p^{s-\alpha} - 1)p^s \sum_{i=1}^k \left(\frac{1}{p^i}\right)^\alpha + p^s + p^{s-\alpha} - 1}{(p^{k(s-\alpha)} + 1)(p^{s-\alpha} - 1)(p^s - 1)} \right);$$

$$f_3(s) = \frac{\zeta^{k+1}(ks)}{\zeta^{k+1}(2ks)} \prod_p \left(1 + \frac{(2p^s - 1) \sum_{i=2}^{k+1} \binom{k+1}{i} p^{k(k+1-i)s} - kp^{(k^2+1)s}}{(p^{ks} + 1)^{k+1}(p^s - 1)^2} \right);$$

$$\begin{aligned} f_4(s) &= \prod_p \left(1 + \frac{\sigma_\alpha((m, p^k))}{p^{ks}} + \frac{\sigma_\alpha((m, p^{k+1}))}{p^{(k+1)s}} + \dots \right) \\ &= \frac{\zeta(ks)}{\zeta(2ks)} \prod_{p|m} \left(\frac{p^{ks}}{p^{ks} + 1} \right) \prod_{p \nmid m} \left(1 + \frac{1}{(p^{ks} + 1)(p^s - 1)} \right) \\ &\quad \times \prod_{\substack{p^\beta || m \\ \beta \leq k}} \left(1 + \frac{\sigma_\alpha(p^\beta)}{p^{ks}(1 - \frac{1}{p^s})} \right) \prod_{\substack{p^\beta || m \\ \beta > k}} \left(1 + \sum_{i=k}^{\beta-1} \frac{\sigma_\alpha(p^i)}{p^{is}} + \frac{\sigma_\alpha(p^\beta)}{p^{ks}(1 - \frac{1}{p^s})} \right) \end{aligned}$$

and

$$\begin{aligned} f_5(s) &= \frac{\zeta(ks)}{\zeta(2ks)} \prod_{p|m} \left(\frac{p^{ks}}{p^{ks} + 1} \right) \prod_{p \nmid m} \left(1 + \frac{1}{(p^{ks} + 1)(p^s - 1)} \right) \\ &\quad \times \prod_{\substack{p^\beta || m \\ \beta \leq k}} \left(1 + \frac{p^\beta - p^{\beta-1}}{p^{ks}(1 - \frac{1}{p^s})} \right) \prod_{\substack{p^\beta || m \\ \beta > k}} \left(1 + \sum_{i=k}^{\beta-1} \frac{p^i - p^{i-1}}{p^{is}} + \frac{p^\beta - p^{\beta-1}}{p^{ks}(1 - \frac{1}{p^s})} \right). \end{aligned}$$

By Perron formula [3] and the method of proving Theorem 1, we can obtain the other results.

REFERENCES

1. F. Smarndache, *ONLY PROBLEMS, NOT SOLUTION!*, Xiquan Publishing House, Chicago, 1993, pp. 27.
2. Tom M. Apostol, *Introduction to Analytic Number Theory*, Springer-Verlag, New York, 1976.
3. Pan Chengdong and Pan Chengbiao, *Foundation of Analytic Number Theory*, Science Press, Beijing, 1997, pp. 98.

A NOTE ON THE 57-TH SMARANDACHE'S PROBLEM

LIU HONGYAN AND ZHANG WENPENG

1. Department of Mathematics, Northwest University
Xi'an, Shaanxi, P.R.China
2. Department of Mathematics, Xi'an University of Technology
Xi'an, Shaanxi, P.R.China
Email: lhysms@sina.com

ABSTRACT. For any positive integer n , let r_1 be the positive integer such that: the set $\{1, 2, \dots, r_1\}$ can be partitioned into n classes such that no class contains integers x, y, z with $x^y = z$, let r_2 be the positive integer such that: the set $\{1, 2, \dots, r_2\}$ can be partitioned into n classes such that no class contains integers x, y, z with $x + y = z$. In this paper, we use the elementary methods to give two sharp lower bound estimates for r_1 and r_2 .

1. INTRODUCTION

For any positive integer n , let r_1 be a positive integer such that: the set $\{1, 2, \dots, r_1\}$ can be partitioned into n classes such that no class contains integers x, y, z with $x^y = z$. In [1], Schur asks us to find the maximum r_1 , and there is the same question when no integer can be the sum of another integer of its class. About these problems, it appears that no one had studied them yet, at least, we have not seen such a paper before. These problems are interesting because it can help us to study some important partition problem. In this paper, we use the elementary methods to study Schur's problem and give two sharp lower bound estimates for r_1 and r_2 . That is, we shall prove the following:

Theorem 1. *For sufficiently large integer n , let r_1 be a positive integer such that: the set $\{1, 2, \dots, r_1\}$ can be partitioned into n classes such that no class contains integers x, y, z with $x^y = z$. For any integer m with $m \leq n + 1$, we have the estimate*

$$r_1 \geq n^{m+1}.$$

Theorem 2. *For sufficiently large integer n with $n \geq 3$, let r_2 be a positive integer such that: the set $\{1, 2, \dots, r_2\}$ can be partitioned into n classes such that no class contains integers x, y, z with $x + y = z$. We have the estimate*

$$r_2 \geq 2^{n+1}.$$

Key words and phrases. Smarandache's problem; Partition; Lower bound..

* This work is supported by N.S.F.(10271093) and P.N.S.F. of P.R.China

2. PROOF OF THE THEOREMS

In this section, we complete the proof of the Theorems.

First let $r_1 = n^{m+1}$ and partition the set $\{1, 2, \dots, r_1\}$ into n classes as follows:

$$\left\{ \begin{array}{l} \text{Class 1: } 1, \quad n+1, \quad n+2, \quad \dots, \quad n^m. \\ \text{Class 2: } 2, \quad n^m+1, \quad n^m+2, \quad \dots, \quad 2n^m. \\ \text{Class 3: } 3, \quad 2n^m+1, \quad 2n^m+2, \quad \dots, \quad 3n^m. \\ \quad \quad \quad \vdots \\ \text{Class } k: \quad k, \quad (k-1)n^m+1, \quad (k-1)n^m+2, \quad \dots, \quad kn^m. \\ \quad \quad \quad \vdots \\ \text{Class } n: \quad n, \quad (n-1)n^m+1, \quad (n-1)n^m+2, \quad \dots, \quad n^{m+1}. \end{array} \right.$$

It is clear that Class k contains no integers x, y, z with $x^y = z$ for $k = 2, 3, 4, \dots, n$. In fact for any integers $x, y, z \in$ Class k , $k = 2, 3, 4, \dots, n$, we have

$$x^y \geq ((k-1)n^m+1)^k > k(k-1)^{k-1}n^{m(k-1)} \geq kn^m \geq z,$$

or

$$x^y \geq k^{(k-1)n^m+1} > kn^m \geq z.$$

On the other hand, when $n \geq m-1$, we have $(n+2)^{(n+1)} > n^m$ and $(n+1)^{(n+2)} > n^m$. So Class 1 contains no integers x, y, z with $x^y = z$, if $n \geq m-1$.

This completes the proof of the Theorem 1.

Then let $r_2 = 2^{n+1}$ and partition the set $\{1, 2, \dots, r_2\}$ into n classes as follows:

$$\left\{ \begin{array}{l} \text{Class 1: } 1, \quad 2, \quad 2^n+2^{n-1}+\dots+2+1. \\ \text{Class 2: } 2+1, \quad 2^2, \quad 2^2+1, \quad 2^2+2, \quad 2^{n+1}. \\ \text{Class 3: } 2^2+2+1, \quad 2^3, \quad 2^3+1, \quad \dots, \quad 2^3+2^2+2. \\ \text{Class 4: } 2^3+2^2+2+1, \quad 2^4, \quad 2^4+1, \quad \dots, \quad 2^4+2^3+2^2+2. \\ \quad \quad \quad \vdots \\ \text{Class } k: \quad 2^{k-1}+2^{k-2}+\dots+2+1, \quad 2^k, \quad 2^k+1, \quad \dots, \quad 2^k+2^{k-1}+\dots+2^2+2. \\ \quad \quad \quad \vdots \\ \text{Class } n: \quad 2^{n-1}+2^{n-2}+\dots+2+1, \quad 2^n, \quad 2^n+1, \quad \dots, \quad 2^n+2^{n-1}+\dots+2^2+2. \end{array} \right.$$

It is clear that Class k contains no integers x, y, z with $x+y = z$ for $k = 3, 4, \dots, n$.

In fact for any integers $x, y, z \in$ Class k , $k = 3, 4, \dots, n$, we have

$$(2^{k-1}+2^{k-2}+\dots+2+1)+2^k > 2^k+2^{k-1}+\dots+2^2+2.$$

On the other hand, when $n \geq 3$, we have $(2^2+1)+(2^2+2) < 2^{n+1}$ and $1+2 < 2^n+2^{n-1}+\dots+2+1$. So Class 1 and Class 2 contain no integers x, y, z with $x+y = z$, if $n \geq 3$.

This completes the proof of the Theorem 2.

REFERENCES

1. F. Smarandache, *Only problems, not Solutions*, Xiquan Publ. House, Chicago, 1993, pp. 54-55.
2. "Smarandache Sequences" at <http://www.gallup.unm.edu/~smarandache/snaqint.txt>.
3. "Smarandache Sequences" at <http://www.gallup.unm.edu/~smarandache/snaqint2.txt>.

**Diverse Algorithms To Obtain Prime numbers Based
on the Prime Function of Smarandache**

Sebastián Martín Ruiz
Avda. de Regla 43, Chipiona 11550
Spain
E-mail: smruiz@telefonica.net

Abstract: In this article one gives seven formulas, six of the author S. M. Ruiz, and one of Azmy Ariff. One also gives their corresponding algorithms programmed in MATHEMATICA.

In the first four formulas all the divisions are integer divisions.

FORMULA 1: Formula to obtain the nth prime [1], [3]:

$$p(n) = 1 + \sum_{k=1}^{2(\lfloor n \log n \rfloor + 1)} \left[1 - \left[\sum_{j=2}^k \left[1 + \left(2 + 2 \cdot \sum_{s=1}^{\sqrt{j}} ((j-1)/s - j/s) \right) / j \right] \right] / n \right]$$

ALGORITHM 1: (G is the Smarandache Prime Function in all Algorithms)

```
DD[i_]:=Sum[Quotient[i,k]-Quotient[(i-1),k],{k,1,Floor[Sqrt[i]]}]
G[n_]:=Sum[1+Quotient[(2-2*DD[j]),j],{j,2,n}]
P[n_]:=1+Sum[1-Quotient[G[k],n],{k,1,2*(Floor[n*Log[n]]+1)}]
Do[Print[P[n], " ", Prime[n]], {n,1,50}]
```

FORMULA 2: Formula to obtain the next prime [2], [3].

$$nxt(p) = 1 + p + \sum_{k=p+1}^{2p} \prod_{j=p+1}^k \left[- \left(\left(2 + 2 \cdot \sum_{s=1}^{\sqrt{j}} ((j-1)/s - j/s) \right) / j \right) \right]$$

ALGORITHM 2:

```
p=Input["input a positive integer number:"]
DD[i_]:=Sum[Quotient[i,j]-Quotient[(i-1),j], {j,1,Floor[Sqrt[i]]}]
G[i_]:=1-Quotient[(2-2*DD[i]),i]
F[m_]:=Product[G[i],{i,p+1,m}]
S[n_]:=Sum[F[m],{m,n+1,2*n}]
Print["nxt(",p,")=",p+1+S[p]]
```

FORMULA 3: Formula to obtain the next prime in an arithmetic progression $a+dn$ [4]:

$$nxt(a,d)(p) = p + d + d \cdot \sum_{k=1+(p-a)/d}^M \prod_{j=1+(p-a)/d}^k \left[- \left(\left(2 + 2 \sum_{s=1}^{\sqrt{a+jd}} ((a+jd-1)/s - (a+jd)/s) \right) / (a+jd) \right) \right]$$

ALGORITHM 3: Example for the arithmetic progression $5+4n$

```

a=5
5
dd=4
4
M=20
20
p=5
5
DD[i_] := Sum[Quotient[(a+i*dd), j] - Quotient[a+i*dd-1, j],
{j, 1, Sqrt[a+i*dd]}]
G[i_] := -Quotient[(2-2*DD[i]), (a+i*dd)]
F[m_] := Product[G[i], {i, (p-a)/dd+1, m}]
S[n_] := Sum[F[m], {m, (p-a)/dd+1, M}]
While[p < a + (M-1)*dd+1, Print["nxt(", p, ") = ", p+dd+dd*S[p]];
p = p+dd+dd*S[p]]

```

```

nxt(5)=13
nxt(13)=17
nxt(17)=29
nxt(29)=37
nxt(37)=41
nxt(41)=53
nxt(53)=61
nxt(61)=73
nxt(73)=89

```

FORMULA 4: Formula to obtain the next prime in all positive increasing integer sequence $\{a_n\}_{n \geq 1} = \{f(n)\}_{n \geq 1}$.

$$NXT_f(p) = f \left[f^{-1}(p) + 1 + \sum_{k \geq f^{-1}(p)+1} \prod_{j=f^{-1}(p)+1}^k G(f(j)) \right]$$

(G is the same of the previous algorithm 2)

ALGORITHM 4:

Example 1: For $a_n = n^3 + 4$

```
M=40
40
f[n_]:=n^3+4
f 1[p_]:= (p-4)^(1/3)
G[x_]:=Quotient[(2+2*Sum[Quotient[(x-1), s]-Quotient[x, s], {s, 1, Sqrt[x]}]), x]
NXT[p_]:=f 1[p]+1+Sum[Product[G[f[j]],{j, f 1[p]+1, k}], {k, f 1[p]+1,M}]
p=f[1]
5
While[p < f[M], (Print[NXT[p], " ", PrimeQ[NXT[p]]]; p = NXT[p])

31 True
347 True
733 True
6863 True
15629 True
19687 True
```

(It is necessary that $f(M) > \text{NXT}(p)$ so that the result is correct.)

Example 2: For $a_n = n^2 + 1$

```
M=125
125
f[n_]:=n^2+1
f 1[p_]:=Sqrt[p-1]
G[x_]:=Quotient[(2+2*Sum[Quotient[(x-1), s]-Quotient[x, s], {s, 1, Sqrt[x]}]), x]
NXT[p_]:=f 1[p]+1+Sum[Product[G[f[j]],{j, f 1[p]+1, k}], {k, f 1[p]+1,M}]
p=f[1]
2
While[p < f[M], (Print[NXT[p], " ", PrimeQ[NXT[p]]]; p = NXT[p])
5 True
17 True
37 True
101 True
197 True
257 True
401 True
577 True
677 True
1297 True
1601 True
```

FORMULA 5: Algorithm to obtain the prime numbers based on Newton's method applied to the function gamma [3].

(*NEWTON'S METHOD APPLIED TO THE CALCULATION OF PRIME NUMBERS *)

```

ndiez[s_]:=N[s,10]
$Post=ndiez
ndiez
P={}
{}
er=10.^(-5)
0.00001
B[x_,i_,j_]:= (x-1.) / P[[i]]^j
EB[x_,i_,j_]:= Floor[B[x,i,j]+er]
LL[x_,i_]:= Log[P[[i]],x-1.]
EE[x_,i_]:= Floor[LL[x,i]+er]
S[x_,i_]:= Sum[EB[x,i,j],{j,1,EE[x,i]}]
F[x_,n_]:= Gamma[x]-Product[(P[[i]])^S[x,i],{i,1,n-1}]
xx=0.
0.
Do[{xx=xx+25.,
Do[xx=xx-F[xx,i]/(Gamma[xx]*PolyGamma[0.,xx]),
{175}],P=Join[P,{xx}],Print[xx," ",Prime[i]],{i,1,50}]

```

FORMULA 6: Formula to obtain twin primes:

For odd $n > 7$, the pair $(n, n+2)$ of integers are twin primes if and only if

$$\sum_{i \text{ odd}} \left(\left\lfloor \frac{n+2}{i} \right\rfloor - \left\lfloor \frac{n+1}{i} \right\rfloor + \left\lfloor \frac{n}{i} \right\rfloor - \left\lfloor \frac{n-1}{i} \right\rfloor \right) = 2$$

where the summation is over odd values of i through $j = \lfloor \frac{n}{3} \rfloor$.

ALGORITHM 6: Algorithm to check if a given number is part of a couple of twin primes (Ruiz-Aruff):

```

In[1]:= n = 2000081; If[Sum[Floor[(n+2)/i] - Floor[(n+1)/i] +
Floor[n/i] - Floor[(n-1)/i], {i, 1, Floor[n/3]}, 2] == 2, "True", "False"]

```

```

Out[1]= True

```

FORMULA 7: (Azmy Ariff): If $a \geq 0$, $e_0 = 0$ and $\{e_1, e_2, \dots, e_k\}$ is an admissible set of positive integers in the open interval $(0, n-2)$, then $(n, n+e_1, n+e_2, \dots, n+e_k)$ is a sequence of primes if and only if

$$\sum_{i=1}^n i^a \left(\sum_{j=0}^k \left\lfloor \frac{n+e_j}{i} \right\rfloor \right) = 1 + k + n^a + \sum_{i=1}^n i^a \left(\sum_{j=0}^k \left\lfloor \frac{n+e_j-1}{i} \right\rfloor \right)$$

ALGORITHM 7:

The following example is a non-optimum implementation with $a = 3$ to search for prime quadruplets $(n, n+2, n+6, n+8)$ below 10000.

```
In[2]:= a=3; n=10000; e={0, 2, 6, 8};
Do[If[Sum[i^a Floor[(j+e[[k]])/i], {k, Length[e]}, {i,
j}]
== Length[e] + j^a + Sum[i^a Floor[(j+e[[k]] - 1)/i],
{k, Length[e]}, {i, j}], Print[Table[j + e[[k]],
{k, Length[e]}]]], {j, n}]

{5, 7, 11, 13}
{11, 13, 17, 19}
{101, 103, 107, 109}
{191, 193, 197, 199}
{821, 823, 827, 829}
{1481, 1483, 1487, 1489}
{1871, 1873, 1877, 1879}
{2081, 2083, 2087, 2089}
{3251, 3253, 3257, 3259}
{3461, 3463, 3467, 3469}
{5651, 5653, 5657, 5659}
{9431, 9433, 9437, 9439}
```

REFERENCES:

- [1] **SM Ruiz**. The General Term of the Prime Number Sequence and the Smarandache prime function. SMARANDACHE NOTIONS JOURNAL vol 11 n° 1-2-3 Spring 2000 page 59
- [2] **SM Ruiz**. A functional recurrence to obtain the prime numbers using the Smarandache prime function. SMARANDACHE NOTIONS JOURNAL vol 11 n° 1-2-3 Spring 2000 page 56
- [3] **Carlos Rivera**. The Prime Puzzles & Problems Connection. Problem 38 and 39. www.primepuzzles.net
- [4] **SM Ruiz**. Formula to obtain the next prime in an arithmetic progression. <http://www.gallup.unm.edu/~Smarandache/SMRuiz-nextprime.pdf>

ON THE SIMPLE NUMBERS AND THE MEAN VALUE PROPERTIES*

LIU HONGYAN AND ZHANG WENPENG

1. Department of Mathematics, Northwest University
Xi'an, Shaanxi, P.R.China
2. Department of Mathematics, Xi'an University of Technology
Xi'an, Shaanxi, P.R.China
Email: lhysms@sina.com

ABSTRACT. A number n is called simple number if the product of its proper divisors is less than or equal to n . In this paper, we study the mean value properties of the sequence of the simple numbers, and give several interesting asymptotic formulae.

1. INTRODUCTION

A number n is called simple number if the product of its proper divisors is less than or equal to n . For example: 2, 3, 4, 5, 6, 7, 8, 9, 10, 11, 13, 14, 15, 17, 19, 21, \dots . In problem 23 of [1], Professor F.Smarandach asked us to study the properties of the sequence of the simple numbers. Let A is a set of simple numbers, that is, $A = \{2, 3, 4, 5, 6, 7, 8, 9, 10, 11, 13, 14, 15, 17, 19, 21, \dots\}$. In this paper, we use the elementary methods to study the properties of this sequence, and give several interesting asymptotic formulae. That is, we shall prove the following:

Theorem 1. For any positive number $x > 1$, we have the asymptotic formula

$$\sum_{\substack{n \in A \\ n \leq x}} \frac{1}{n} = (\ln \ln x)^2 + B_1 \ln \ln x + B_2 + O\left(\frac{\ln \ln x}{\ln x}\right),$$

where B_1, B_2 are the constants.

Theorem 2. For any positive number $x > 1$, we have the asymptotic formula

$$\sum_{\substack{n \in A \\ n \leq x}} \frac{1}{\phi(n)} = (\ln \ln x)^2 + C_1 \ln \ln x + C_2 + O\left(\frac{\ln \ln x}{\ln x}\right),$$

where C_1, C_2 are the constants, $\phi(n)$ is Euler function.

Key words and phrases. The simple numbers ; Mean value properties; Asymptotic formula.
* This work is supported by the N.S.F. and the P.S.F. of P.R.China.

Theorem 3. For any positive number $x > 1$, we have the asymptotic formula

$$\sum_{\substack{n \in A \\ n \leq x}} \frac{1}{\sigma(n)} = (\ln \ln x)^2 + D_1 \ln \ln x + D_2 + O\left(\frac{\ln \ln x}{\ln x}\right),$$

where D_1, D_2 are the constants, $\sigma(n)$ is divisor function.

2. SOME LEMMAS

To complete the proof of the Theorems, we need the following two Lemmas: First Let n be a positive integer, $p_d(n)$ is the product of all positive divisors of n , that is, $p_d(n) = \prod_{d|n} d$. $q_d(n)$ is the product of all positive divisors of n but n , that

is, $q_d(n) = \prod_{d|n, d < n} d$. Then we have

Lemma 1. Let $n \in A$, then we have $n = p$, or $n = p^2$, or $n = p^3$, or $n = pq$ four cases.

Proof. From the definition of $p_d(n)$ we know that

$$p_d(n) = \prod_{d|n} d = \prod_{d|n} \frac{n}{d}.$$

So from this formula we have

$$(1) \quad p_d^2(n) = \prod_{d|n} d \times \prod_{d|n} \frac{n}{d} = \prod_{d|n} n = n^{d(n)}.$$

where $d(n) = \sum_{d|n} 1$. From (1) we immediately get $p_d(n) = n^{\frac{d(n)}{2}}$ and

$$(2) \quad q_d(n) = \prod_{d|n, d < n} d = \frac{\prod_{d|n} d}{n} = n^{\frac{d(n)}{2} - 1}.$$

By the definition of the simple numbers and (2), we get $n^{\frac{d(n)}{2} - 1} \leq n$. Therefore we have

$$d(n) \leq 4.$$

This inequality holds only for $n = p$, or $n = p^2$, or $n = p^3$, or $n = pq$ four cases. This completes the proof of Lemma 1.

Lemma 2. For any positive number $x > 1$, we have the asymptotic formula

$$\sum_{p \leq \sqrt{x}} \frac{1}{p} \ln \ln \frac{x}{p} = (\ln \ln x)^2 + B_1 \ln \ln x + B_2 + O\left(\frac{\ln \ln x}{\ln x}\right),$$

where B_1, B_2 are the constants.

Proof. It is clear that

$$\begin{aligned}
 \sum_{p \leq \sqrt{x}} \frac{1}{p} \ln \ln \frac{x}{p} &= \sum_{p \leq \sqrt{x}} \frac{1}{p} \ln(\ln x - \ln p) \\
 &= \sum_{p \leq \sqrt{x}} \frac{1}{p} \left(\ln \ln x + \ln \left(1 - \frac{\ln p}{\ln x} \right) \right) \\
 (3) \quad &= \ln \ln x \sum_{p \leq \sqrt{x}} \frac{1}{p} + \sum_{p \leq \sqrt{x}} \frac{1}{p} \ln \left(1 - \frac{\ln p}{\ln x} \right).
 \end{aligned}$$

Applying

$$(4) \quad \sum_{p \leq x} \frac{1}{p} = \ln \ln x + C_1 + O\left(\frac{1}{\ln x}\right).$$

we obtain

$$\begin{aligned}
 \ln \ln x \sum_{p \leq \sqrt{x}} \frac{1}{p} &= \ln \ln x \left(\ln \ln \sqrt{x} + C_1 + O\left(\frac{1}{\ln x}\right) \right) \\
 (5) \quad &= (\ln \ln x)^2 + B_1 \ln \ln x + O\left(\frac{\ln \ln x}{\ln x}\right).
 \end{aligned}$$

If $m > 2$, note that $\pi(x) = \frac{x}{\ln x} + \frac{x}{\ln^2 x} + O\left(\frac{x}{\ln^3 x}\right)$, then we have

$$\begin{aligned}
 \sum_{p \leq \sqrt{x}} \frac{\ln^m p}{p} &= \int_2^{\sqrt{x}} \frac{\ln^m y}{y} d\pi(y) \\
 &= \frac{\ln^m \sqrt{x}}{\sqrt{x}} \pi(\sqrt{x}) + O(1) - \int_2^{\sqrt{x}} \pi(y) \frac{m \ln^{m-1} y - \ln^m y}{y^2} dy \\
 &= \frac{\ln^m \sqrt{x}}{\sqrt{x}} \left(\frac{\sqrt{x}}{\ln \sqrt{x}} + O\left(\frac{\sqrt{x}}{\ln^2 \sqrt{x}}\right) \right) \\
 &\quad - \int_2^{\sqrt{x}} \left(\frac{y}{\ln y} + \frac{y}{\ln^2 y} + O\left(\frac{y}{\ln^3 y}\right) \right) \frac{m \ln^{m-1} y - \ln^m y}{y^2} dy \\
 &= \frac{\ln^{m-1} x}{2^{m-1}} + O\left(\frac{\ln^{m-2} x}{2^{m-2}}\right) \\
 &\quad + \int_2^{\sqrt{x}} \left[\frac{\ln^{m-1} y}{y} - (m-1) \frac{\ln^{m-2} y}{y} + O\left(\frac{\ln^{m-3} y}{y}\right) \right] dy \\
 &= \frac{\ln^{m-1} x}{2^{m-1}} + O\left(\frac{\ln^{m-2} x}{2^{m-2}}\right) + \frac{\ln^m x}{m 2^m} - \frac{\ln^{m-1} x}{2^{m-1}} + O\left(\frac{(1-m) \ln^{m-2} x}{(m-2) 2^{m-2}}\right) \\
 (6) \quad &= \frac{1}{m 2^m} \ln^m x + O\left(\frac{1}{2^{m-2}(2-m)} \ln^{m-2} x\right).
 \end{aligned}$$

From (6) and note that $\sum_{m=1}^{\infty} \frac{1}{m 2^m}$ is convergent, we have

$$- \sum_{p \leq \sqrt{x}} \frac{1}{p} \ln \left(1 - \frac{\ln p}{\ln x} \right)$$

$$\begin{aligned}
&= \sum_{p \leq \sqrt{x}} \frac{1}{p} \left(\frac{\ln p}{\ln x} + \frac{\ln^2 p}{2 \ln^2 x} + \cdots + \frac{\ln^m p}{m \ln^m x} + \cdots \right) \\
&= \frac{1}{\ln x} \sum_{p \leq \sqrt{x}} \frac{\ln p}{p} + \frac{1}{2 \ln^2 x} \sum_{p \leq \sqrt{x}} \frac{\ln^2 p}{p} + \cdots + \frac{1}{m \ln^m x} \sum_{p \leq \sqrt{x}} \frac{\ln^m p}{p} + \cdots \\
&= \frac{1}{\ln x} \left(\frac{1}{2} \ln x + O(1) \right) + \cdots + \frac{1}{m \ln^m x} \left(\frac{1}{m 2^m} \ln^m x + O \left(\frac{\ln^{m-2} x}{2^{m-2}(2-m)} \right) \right) + \cdots \\
(7) \quad &= B_2 + O \left(\frac{1}{\ln x} \right),
\end{aligned}$$

where we have used the asymptotic formula $\sum_{p \leq \sqrt{x}} \frac{\ln p}{p} = \frac{1}{2} \ln x + O(1)$ and the power series expansion $\ln(1-x) = -(x + \frac{x^2}{2} + \cdots + \frac{x^m}{m} + \cdots)$. From (3), (5) and (7) we immediately get

$$\sum_{p \leq \sqrt{x}} \frac{1}{p} \ln \ln \frac{x}{p} = (\ln \ln x)^2 + B_1 \ln \ln x + B_2 + O \left(\frac{\ln \ln x}{\ln x} \right).$$

This proves Lemma 2.

3. PROOF OF THE THEOREMS

In this section, we shall complete the proof of the Theorems. From Lemma 1 we have

$$\begin{aligned}
(8) \quad \sum_{\substack{n \in A \\ n \leq x}} \frac{1}{n} &= \sum_{p \leq x} \frac{1}{p} + \sum_{p^2 \leq x} \frac{1}{p^2} + \sum_{p^3 \leq x} \frac{1}{p^3} + \sum_{\substack{pq \leq x \\ p \neq q}} \frac{1}{pq} \\
&= \sum_{p \leq x} \frac{1}{p} + \sum_{p^3 \leq x} \frac{1}{p^3} + \sum_{pq \leq x} \frac{1}{pq}.
\end{aligned}$$

Applying (4) and Lemma 2 we get

$$\begin{aligned}
(9) \quad \sum_{pq \leq x} \frac{1}{pq} &= 2 \sum_{p \leq \sqrt{x}} \frac{1}{p} \sum_{q \leq x/p} \frac{1}{q} - \left(\sum_{p \leq \sqrt{x}} \frac{1}{p} \right) \left(\sum_{q \leq \sqrt{x}} \frac{1}{q} \right) \\
&= 2 \sum_{p \leq \sqrt{x}} \frac{1}{p} \left(\ln \ln \frac{x}{p} + C_1 + O \left(\frac{1}{\ln x} \right) \right) - \left(\ln \ln \sqrt{x} + C_1 + O \left(\frac{1}{\ln x} \right) \right)^2 \\
&= 2 \sum_{p \leq \sqrt{x}} \frac{1}{p} \ln \ln \frac{x}{p} + 2C_1 \sum_{p \leq \sqrt{x}} \frac{1}{p} + O \left(\frac{1}{\ln x} \sum_{p \leq \sqrt{x}} \frac{1}{p} \right) \\
&\quad - \left((\ln \ln x)^2 + C_2 \ln \ln x + C_3 + O \left(\frac{\ln \ln x}{\ln x} \right) \right) \\
&= (\ln \ln x)^2 + C_4 \ln \ln x + C_5 + O \left(\frac{\ln \ln x}{\ln x} \right).
\end{aligned}$$

Combining (4), (8) and (9) and note that $\sum_{p^3 \leq x} \frac{1}{p^3}$ is convergent, we immediately obtain

$$\sum_{\substack{n \in A \\ n \leq x}} \frac{1}{n} = (\ln \ln x)^2 + B_1 \ln \ln x + B_2 + O\left(\frac{\ln \ln x}{\ln x}\right).$$

This completes the proof of Theorem 1.

Now we complete the proof of Theorem 2 and Theorem 3. From the definitions and the properties of Euler function and divisor function, and applying Lemma 1 we have

$$\sum_{\substack{n \in A \\ n \leq x}} \frac{1}{\phi(n)} = \sum_{p \leq x} \frac{1}{p-1} + \sum_{p^2 \leq x} \frac{1}{p^2-p} + \sum_{p^3 \leq x} \frac{1}{p^3-p^2} + \sum_{\substack{pq \leq x \\ p \neq q}} \frac{1}{(p-1)(q-1)}$$

and

$$\sum_{\substack{n \in A \\ n \leq x}} \frac{1}{\sigma(n)} = \sum_{p \leq x} \frac{1}{p+1} + \sum_{p^2 \leq x} \frac{1}{p^2+p+1} + \sum_{p^3 \leq x} \frac{1}{p^3+p^2+p+1} + \sum_{\substack{pq \leq x \\ p \neq q}} \frac{1}{(p+1)(q+1)}.$$

Note that $\frac{1}{p \pm 1} = \frac{1}{p} \mp \frac{1}{p(p \pm 1)}$ and $\sum_p \frac{1}{p(p \pm 1)}$ is convergent, then using the methods of proving Theorem 1 we can easily deduce that

$$\sum_{\substack{n \in A \\ n \leq x}} \frac{1}{\phi(n)} = (\ln \ln x)^2 + C_1 \ln \ln x + C_2 + O\left(\frac{\ln \ln x}{\ln x}\right)$$

and

$$\sum_{\substack{n \in A \\ n \leq x}} \frac{1}{\sigma(n)} = (\ln \ln x)^2 + D_1 \ln \ln x + D_2 + O\left(\frac{\ln \ln x}{\ln x}\right).$$

This completes the proof of the Theorems.

REFERENCES

1. F. Smarandache, *Only problems, not Solutions*, Xiquan Publ. House, Chicago, 1993, pp. 23.
2. Tom M. Apostol, *Introduction to Analytic Number Theory*, Springer-Verlag, New York, 1976.
3. R. K. Guy, *Unsolved Problems in Number Theory*, Springer-Verlag, New York, Heidelberg, Berlin, 1981.
4. "Smarandache Sequences" at <http://www.gallup.unm.edu/~smarandache/snaqint.txt>.
5. "Smarandache Sequences" at <http://www.gallup.unm.edu/~smarandache/snaqint2.txt>.
6. "Smarandache Sequences" at <http://www.gallup.unm.edu/~smarandache/snaqint3.txt>.

THE DIVISIBILITY OF THE SMARANDACHE COMBINATORIAL SEQUENCE OF DEGREE TWO

Maohua Le
Department of Mathematics
Zhanjiang Normal College
29 Cunjin Road, Chikan
Zhanjiang, Guangdong
P.R.China

Abstract: In this paper we prove that there has only the consecutive terms of the Smarandache combinatorial sequence of degree two are pairwise coprime.

Key words: Smarandache combinatorial sequences; consecutive terms; divisibility

Let r be a positive integer with $r > 1$. Let $SCS(r) = \{a(r, n)\}_{n=1}^{\infty}$ be the Smarandache combinatorial sequence of degree r . Then we have $a(r, n) = n(n=1, 2, \dots, r)$ and $a(r, n)(n > r)$ is the sum of all the products of the previous terms of the sequence taking r terms at a time. In [2], Murthy asked that how many of the consecutive terms of $SCS(r)$ are pairwise coprime.

In this paper we solve this problem for $r=2$. We prove the following result.

Supported by the National Natural Science Foundation of China (No.10271104), the Guangdong Provincial Natural Science Foundation (No.011781) and the Natural Science Foundation of the Education Department of Guangdong Province (No.0161).

Theorem. For any positive integer n , we have $a(2, n+1) \equiv 0 \pmod{a(2, n)}$.

By the above mentioned theorem, we obtain the following corollary immediately.

Corollary. There has only the consecutive terms 1,2 of $SCS(2)$ are pairwise coprime.

Proof of Theorem. Let $b(n) = a(2, n)$ for any n . Then we have $b(1) = 1$ and $b(2) = 2$. It implies that the theorem holds for $n = 1$.

By the define of $SCS(2)$, if $n > 1$, then we have

$$\begin{aligned} b(n) &= b(1)b(2) + \dots + b(n-2)b(n-1) \\ &= \frac{1}{2} \left((b(1) + \dots + b(n-1))^2 - (b^2(1) + \dots + b^2(n-1)) \right) \end{aligned} \quad (1)$$

and

$$\begin{aligned} b(n) &= b(1)b(2) + \dots + b(n-2)b(n-1) \\ &= \frac{1}{2} \left((b(1) + \dots + b(n-1) + b(n))^2 - (b^2(1) + \dots + b^2(n-1) + b^2(n)) \right) \end{aligned} \quad (2)$$

using the basic properties of congruence (see [1, Chapter V]), we get from (1) and (2) that

$$\begin{aligned} b(n+1) &\equiv \frac{1}{2} \left((b(1) + \dots + b(n-1))^2 - (b^2(1) + \dots + b^2(n-1)) \right) \\ &\equiv b(n) \equiv 0 \pmod{b(n)}. \end{aligned}$$

Thus, the theorem is proved.

References

- [1] G.H. Hardy and E.M. Wright, An introduction to the theory of numbers, Oxford University Press, Oxford, 1938.
- [2] A. Murthy, Some new Smarandache sequences, functions and partitions, Smarandache Notions J. 11(2000), 179-183.

THE SMARANDACHE φ -SEQUENCE

Maohua Le

Department of Mathematics

Zhanjiang Normal College

29 Cunjin Road, Chikan

Zhanjiang, Guangdong

P.R.China

Abstract: In this paper we completely determine the Smarandache φ -sequence.

Key words: Smarandache φ -sequence; Euler totient function; diophantine equation

For any positive integer n , let $\varphi(n)$ be the Euler totient function of n . Further, let the set

$$A = \{n | n = k\varphi(n), \text{ where } k \text{ is a positive integer}\}. \quad (1)$$

Then, all elements n of A form the Smarandache φ -sequence (see [2]). In this paper we completely determine this sequence as follows.

Theorem. Let $\{a(x)\}_{x=1}^{\infty}$ be the Smarandache φ -sequence. Then we have

$$a(x) = \begin{cases} 1, & \text{if } x = 1, \\ 2, & \text{if } x = 2, \\ 2^{(x+1)/2}, & \text{if } x > 1 \text{ and } x \text{ is odd,} \\ 2^{x/2-1} \cdot 3, & \text{if } x > 1 \text{ and } x \text{ is even.} \end{cases} \quad (2)$$

Supported by the National Natural Science Foundation of China (No.10271104), the Guangdong Provincial Natural Science Foundation (No.011781) and the Natural Science Foundation of the Education Department of Guangdong Province (No.0161).

Proof. We first consider the elements of A . We see from (1) that these elements are solutions of the equation

$$n=k\varphi(n). \quad (3)$$

Clearly, $(n,k)=(1,1)$ is a positive integer of (3). If $n>1$, let

$$n = p_1^{\alpha_1} p_2^{\alpha_2} \cdots p_s^{\alpha_s} \quad (4)$$

be the factorization of n . By [1, Theorem 62], we have

$$\varphi(n) = p_1^{\alpha_1-1} p_2^{\alpha_2-1} \cdots p_s^{\alpha_s-1} (p_1 - 1)(p_2 - 1) \cdots (p_s - 1). \quad (5)$$

Substitute (4) and (5) into (3), we get

$$p_1 p_2 \cdots p_s = k(p_1 - 1)(p_2 - 1) \cdots (p_s - 1). \quad (6)$$

If n is even, then $p_1=2$ and p_2, \dots, p_s are odd primes. Since p_i-1 ($i=2, \dots, s$) are even integer, we find from (6) that either $s=1$ and $k=2$ or $s=2$, $p_2=3$ and $k=3$. It follows that (3) has positive integer solutions $(n,k)=(2^r, 2)$ and $(2^r \cdot 3, 3)$, where r is a positive integer.

If n is odd, then (6) is impossible, since p_j ($j=1, 2, \dots, s$) are odd primes and p_j-1 ($j=1, 2, \dots, s$) are even integers.

Thus, by the above analysis, we obtain (2) immediately.

References

- [1] G.H.Hardy and E.M.Wright, An introduction to the theory of numbers, Oxford University Press, Oxford, 1938.
- [2] A.Murthy, Some new Smarandache sequences, functions and partitions, Smarandache Notions J. 11(2000), 179-183.

TWO FUNCTIONAL EQUATIONS

Maohua Le

Department of Mathematics

Zhanjiang Normal College

29 Cunjin Road, Chikan

Zhanjiang, Guangdong

P.R.China

Abstract: In this paper we solve two problems concerning the pseudo Smarandache function.

Key words: pseudo Smarandache function, sum of distinct divisors; divisors function

For any positive integer n , let $Z(n)$, $b(n)$ and $d(n)$ denote the pseudo Smarandache function, the sum of distinct divisors and the divisors function of n respectively. In [1], Ashbacher proposed the following two problems.

Problem 1. Is there infinite many positive integers n of the equation

$$Z(n) = \delta(n) \tag{1}$$

with $n \neq 2^r$, where r is a nonnegative integer.

Supported by the National Natural Science Foundation of China (No.10271104), the Guangdong Provincial Natural Science Foundation (No.011781) and the Natural Science Foundation of the Education Department of Guangdong Province (No.0161).

Problem 2. How many positive integer solutions n are there to the equation

$$Z(n) = d(n). \quad (2)$$

In this paper we completely solve these problems as follows.

Theorem 1. The equation (1) has only the positive integer solutions $n=2^r$, where r is a nonnegative integer.

Theorem 2. The equation (2) has only the positive integer solutions $n=1, 3$ and 10 .

Proof of Theorem 1. It is a well known fact that $n=2^r$ is a solution of (1). Let n be a positive integer solution of (1) with $n \neq 2^r$. Then, by [3], we have

$$Z(n) < n. \quad (3)$$

Since $\delta(n) \geq n+1$, (1) is impossible by (3). The theorem is proved.

Proof of Theorem 2. By [1], a computer search up through $n=10000$ yielded (2) only the solutions $n=1, 3$ and 10 . Let n be a positive integer solution with $n > 10000$, and let

$$n = p_1^{\alpha_1} p_2^{\alpha_2} \cdots p_k^{\alpha_k} \quad (4)$$

be the factorization of n . By [2, Theorem 273], we have

$$d(n) = (\alpha_1 + 1)(\alpha_2 + 1) \cdots (\alpha_k + 1). \quad (5)$$

On the other hand, let $t=Z(n)$. Since

$$\frac{1}{2}t(t+1) \equiv 0 \pmod{n}, \quad (6)$$

we have $t(t+1) \geq 2n$. It implies that

$$Z(n) = t \geq \frac{1}{2}(\sqrt{8n+1}) > 1.414\sqrt{n}, \quad (7)$$

since $n > 10000$. For any prime p and any positive integer α , let

$$f(p^\alpha) = \frac{p^{\alpha/2}}{\alpha+1}. \quad (8)$$

Then, by (2),(4),(5),(7) and (8), we get

$$1.414f(p_1^{\alpha_1})f(p_2^{\alpha_2})\cdots f(p_k^{\alpha_k}) < 1. \quad (9)$$

Since

$$f(p^\alpha) \geq \begin{cases} 1, & \text{if } p=2 \text{ and } a>6 \text{ or } p=3 \text{ and } a>1. \\ \frac{\sqrt{5}}{2}, & \text{if } p>3, \end{cases} \quad (10)$$

we find from (4) that (9) is impossible if $n > 10000$. Thus, the theorem is proved.

References

- [1] C. Ashbacher, The pseudo Smarandache function and the classical functions of number theory, Smarandache Notions J. 9(1998), 78-81.
- [2] G. H. Hardy and E. M. Wright, An introduction to the theory of numbers, Oxford University Press, Oxford, 1938.
- [3] H. Ibstedt, On the pseudo Smarandache function and iteration problems, Smarandache Notions J. 12(2001), 36-43.

TWO FORMULAS FOR SMARANDACHE LCM RATIO SEQUENCES

Maohua Le
Department of Mathematics
Zhanjiang Normal College
29 Cunjin Road, Chikan
Zhanjiang, Guangdong
P.R.China

Abstract: In this paper we give two reduction formulas for Smarandache LCM ratio sequences $SLRS(3)$ and $SLRS(4)$.

Key words: Smarandache LCM ratio sequence; reduction formula

For any $t(t > 1)$ positive integers x_1, x_2, \dots, x_t , let (x_1, x_2, \dots, x_t) and $[x_1, x_2, \dots, x_t]$ denote the greatest common divisor and the least common multiple of x_1, x_2, \dots, x_t respectively. Let r be a positive integer with $r > 1$. For any positive integer n , let

$$T(r, n) = \frac{[n, n+1, \dots, n+r-1]}{[1, 2, \dots, r]}. \quad (1)$$

Then the sequence $SLRS(r) = \{T(r, n)\}_{n=1}^{\infty}$ is called the Smarandache LCM ratio sequence of degree r . It is easy to see that

$$T(2, n) = \frac{1}{2}n(n+1)$$

Supported by the National Natural Science Foundation of China (No.10271104), the Guangdong Provincial Natural Science Foundation (No.011781) and the Natural Science Foundation of the Education Department of Guangdong Province (No.0161).

for any positive integer n . In [2], Murthy asked that find reduction formulas for $T(r,n)$. In this paper we solve this open problem for $r=3$ or 4. We prove the following result.

Theorem. For any positive integer n , we have

$$T(3,n) = \begin{cases} \frac{1}{6}n(n+1)(n+2), & \text{if } n \text{ is odd,} \\ \frac{1}{12}n(n+1)(n+2), & \text{if } n \text{ is even} \end{cases} \quad (2)$$

and

$$T(4,n) = \begin{cases} \frac{1}{24}n(n+1)(n+2)(n+3), & \text{if } n \not\equiv 0 \pmod{3}, \\ \frac{1}{72}n(n+1)(n+2)(n+3), & \text{if } n \equiv 0 \pmod{3}. \end{cases} \quad (3)$$

The proof of our theorem depends on the following lemmas.

Lemma 1 ([1, Theorem 1.6.4]). For any positive integers a and b , we have $(a,b)[a,b]=ab$.

Lemma 2 ([1, Theorem 1.6.5]). For any positive integers s and $s < t$, we have

$$(x_1, x_2, \dots, x_t) = ((x_1, \dots, x_s), (x_{s+1}, \dots, x_t))$$

and

$$[x_1, x_2, \dots, x_t] = [[x_1, \dots, x_s], [x_{s+1}, \dots, x_t]].$$

Proof of theorem. By Lemmas 1 and 2, we get

$$[n, n+1, n+2] = [n, [n+1, n+2]] = \left[n, \frac{(n+1)(n+2)}{(n+1, n+2)} \right]. \quad (4)$$

Since $(n+1, n+2)=1$, we get from (4) that

$$[n, n+1, n+2] = [n, (n+1)(n+2)]. \quad (5)$$

Further, since $(n, n+1)=1$, we have

$$(n, (n+1)(n+2)) = (n, n+2) = \begin{cases} 1, & \text{if } n \text{ is odd,} \\ 2, & \text{if } n \text{ is even.} \end{cases} \quad (6)$$

Hence, by Lemma 1, we obtain from (5) and (6) that

$$[n, n+1, n+2] = \left[n, \frac{(n+1)(n+2)}{(n+1, n+2)} \right]$$

$$= \begin{cases} n(n+1)(n+2), & \text{if } n \text{ is odd,} \\ \frac{1}{2} n(n+1)(n+2), & \text{if } n \text{ is even.} \end{cases} \quad (7)$$

Since $[1,2,3]=6$, we get (2) by (7) immediately.

Similarly, we have

$$\begin{aligned} [n, n+1, n+2, n+3] &= [[n, n+1], [n+2, n+3]] \\ &= \left[\frac{n(n+1)}{(n, n+1)}, \frac{(n+2)(n+3)}{(n+2, n+3)} \right] = [n(n+1), (n+2)(n+3)]. \end{aligned} \quad (8)$$

Since $[1,2,3,4]=12$ and

$$(n(n+1), (n+2)(n+3)) = \begin{cases} 2, & \text{if } n \not\equiv 0 \pmod{3}, \\ 6, & \text{if } n \equiv 0 \pmod{3}, \end{cases} \quad (9)$$

we obtain (3) by (8) immediately. The theorem is proved.

References

- [1] G.H.Hardy and E.M.Wright, An introduction to the theory of numbers, Oxford University Press, Oxford, 1938.
- [2] A.Murthy, Some notions on least common multiples, Smarandache Notions J. 12(2001), 307-308.

AN EQUATION CONCERNING THE SMARANDACHE LCM FUNCTION

Maohua Le
Department of Mathematics
Zhanjiang Normal College
29 Cunjin Road, Chikan
Zhanjiang, Guangdong
P.R.China

Abstract: In this paper we completely solve an open problem concerning the Smarandache LCM function.

Key words: Smarandache function; Smarandache LMC function; diophantine equation

For any positive integer n , let $S(n)$ be the Smarandache function. For any positive integer k , let $L(k)$ be the least common multiple of $1, 2, \dots, k$. Further, let $SL(n)$ denote the least positive integer k such that $L(k) \equiv 0 \pmod{n}$. Then $SL(n)$ is called the Smarandache LCM function. In [2], Murthy showed that if n is a prime, the $SL(n) = S(n) = n$. Simultaneously, he proposed the following problem.

$$SL(n) = S(n), S(n) \neq n? \quad (1)$$

Supported by the National Natural Science Foundation of China (No.10271104), the Guangdong Provincial Natural Science Foundation (No.011781) and the Natural Science Foundation of the Education Department of Guangdong Province (No.0161).

In this paper we completely solve the above mentioned problem as follows:

Theorem. Every positive integer n satisfying (1) can be expressed as

$$n=12 \quad \text{or} \quad n = p_1^{\alpha_1} p_2^{\alpha_2} \cdots p_r^{\alpha_r} p, \quad (2)$$

where p_1, p_2, \dots, p_r, p are distinct primes and $\alpha_1, \alpha_2, \dots, \alpha_r$ are positive integers satisfying $p > p_i^{\alpha_i}$ ($i=1, 2, \dots, r$).

The above theorem means that (1) has infinitely many positive integer solutions n . The proof of our theorem depends on the following lemmas.

Lemma 1 ([1]). Let

$$n = p_1^{\alpha_1} p_2^{\alpha_2} \cdots p_t^{\alpha_t} \quad (3)$$

be the factorization of n . Then we have

$$S(n) = \max\left(S(p_1^{\alpha_1}), S(p_2^{\alpha_2}), \dots, S(p_t^{\alpha_t})\right).$$

Lemma 2 ([1]). If p^α is a power of prime, then $S(p^\alpha) \equiv 0 \pmod{p}$.

Lemma 3 ([1]). If p^α is a power of prime such that $\alpha > 1$ and $p^\alpha \neq 4$, then $S(p^\alpha) < p^\alpha$.

Lemma 4 ([2]). If (3) is the factorization of n , then $SL(n) = \max(p_1^{\alpha_1}, p_2^{\alpha_2}, \dots, p_t^{\alpha_t})$.

Proof of Theorem. Let n be a positive integer solution of (1). Further, let (3) be the factorization of n , and let

$$p^\alpha = \max(p_1^{\alpha_1}, p_2^{\alpha_2}, \dots, p_t^{\alpha_t}). \quad (4)$$

By Lemmas 1 and 4, we get from (1), (3) and (4) that

$$p^\alpha = SL(n) = S(n) = S(p_j^{\alpha_j}), \quad 1 \leq j \leq t. \quad (5)$$

By Lemma 2, we have $S(p_j^{\alpha_j}) \equiv 0 \pmod{p_j}$. Hence, by (5), we get $p = p_j$ and

$$p^\alpha = S(p^\alpha). \quad (6)$$

If $p^\alpha = 4$, then from (4) we get $n=4$ or 12 .

Since $S(4)=S(12)=4$ and $S(n) \neq n$, we obtain $n=12$.

If $\alpha = 1$, then from (4) we get $j=t$. Since $S(n) \neq n$, we see from (3)

that $t > 1$. Let $r = t - 1$. Then, by (3), we obtain (2). Thus, the theorem is proved.

References

- [1] I. Balacenoiu and V. Seleacu, History of the Smarandache function, Smarandache Notions J. 10(1999), 1992-201.
- [2] A. Murthy, Some notions on least common multiples, Smarandache Notions J. 12(2001), 307-309.

ON THE 45-TH SMARANDACHE'S PROBLEM*

GAO JING AND LIU HUANING

Department of Mathematics, Northwest University
Xi'an, Shaanxi, P.R.China

ABSTRACT. For any positive integer n , let $k(n)$ be the smallest integer such that $nk(n)$ is a factorial number. In this paper, we study the hybrid mean value of $k(n)$ and the Mangoldt function, and give a sharp asymptotic formula.

1. INTRODUCTION AND RESULTS

For any positive integer n , let $k(n)$ be the smallest integer such that $nk(n)$ is a factorial number. For example, $k(1) = 1$, $k(2) = 1$, $k(3) = 2$, $k(4) = 6$, $k(5) = 24$, $k(6) = 1$, $k(7) = 720$, \dots . Professor F. Smarandache [1] asks us to study the sequence. About this problem, we know very little. The problem is interesting because it can help us to calculate the Smarandache function.

For any prime number p and positive integer n , let $S_p(n)$ be the smallest integer such that $S_p(n)!$ is divisible by p^n . Professor F. Smarandache [1] also asks us to study this sequence. It seems that $k(n)$ relates to $S_p(n)$. In fact, let $n = p^\alpha$, then we have $k(p^\alpha) = S_p(\alpha)!/p^\alpha$. Let $n = p_1^{\alpha_1} p_2^{\alpha_2} \cdots p_r^{\alpha_r}$, where p_1, p_2, \dots, p_r are distinct prime numbers. It is not hard to show that

$$k(p_1^{\alpha_1} p_2^{\alpha_2} \cdots p_r^{\alpha_r}) = \text{Max}\{S_{p_i}(\alpha_i)!/i \mid i = 1, 2, \dots, r\} / (p_1^{\alpha_1} p_2^{\alpha_2} \cdots p_r^{\alpha_r}).$$

In this paper, we study the hybrid mean value of $k(n)$ and the Mangoldt function, and give a sharp asymptotic formula. That is, we shall prove the following theorems.

Theorem 1. *If $x \geq 2$, we have*

$$\sum_{n < x} \Lambda_1(n) \log k(n) = \frac{1}{2} x^2 \log x + O(x^2),$$

where

$$\Lambda_1(n) = \begin{cases} \log p, & \text{if } n \text{ is a prime } p; \\ 0, & \text{otherwise.} \end{cases}$$

Key words and phrases. Factorial quotients; Hybrid mean; Asymptotic formula; Smarandache.

*This work is supported by the N.S.F.(10271093) and P.N.S.F of P.R.China.

Theorem 2. *If $x \geq 2$, we have*

$$\sum_{n < x} \Lambda(n) \log k(n) = \frac{1}{2}x^2 \log x + O(x^2),$$

where $\Lambda(n)$ is the Mangoldt function.

It is an unsolved problem whether there exists an asymptotic formula for $\sum_{n < x} \log k(n)$.

We conjecture that

$$\sum_{n < x} \log k(n) = \frac{1}{2}x^2 + O\left(\frac{x^2}{\log x}\right).$$

2. SOME LEMMAS

To complete the proofs of the theorems, we need the following lemmas.

Lemma 1. *If $x \geq 2$ we have*

$$\log[x]! = x \log x - x + O(\log x),$$

where $[y]$ denotes the largest integer not exceeding y .

Proof. This is Theorem 3.15 of [2].

Lemma 2. *For any prime number p and positive integer n , let $S_p(n)$ be the smallest integer such that $S_p(n)!$ is divisible by p^n . Then we have*

$$n(p-1) \leq S_p(n) \leq np.$$

Proof. It is obvious that $S_p(n) \leq np$.

On the other hand, by Theorem 3.14 of [2] we have

$$S_p(n)! = \prod_{p_1 \leq S_p(n)} p_1^{\alpha(p_1)}, \quad \alpha(p_1) = \sum_{m=1}^{\infty} \left[\frac{S_p(n)}{p_1^m} \right],$$

where $\prod_{p_1 \leq x}$ denotes the product over prime numbers not exceeding x . Note that $p^n \mid S_p(n)!$, we get

$$n < \alpha(p) = \sum_{m=1}^{\infty} \left[\frac{S_p(n)}{p^m} \right] < \sum_{m=1}^{\infty} \frac{S_p(n)}{p^m} = \frac{S_p(n)}{p-1}.$$

This proves Lemma 2.

3. PROOFS OF THE THEOREMS

In this section, we complete the proofs of the theorems. From Lemma 1 and the definition of $k(n)$ we have

$$\begin{aligned} \sum_{n \leq x} \Lambda_1(n) \log k(n) &= \sum_{p \leq x} \log p \log(p-1)! \\ &= \sum_{p < x} \log p [(p-1) \log(p-1) - (p-1) + O(\log(p-1))] = \sum_{p < x} [p \log^2 p + O(p \log p)]. \end{aligned}$$

Let

$$a(n) = \begin{cases} 1, & \text{if } n \text{ is prime;} \\ 0, & \text{otherwise,} \end{cases}$$

then

$$\sum_{n \leq x} a(n) = \pi(x) = \frac{x}{\log x} + O\left(\frac{x}{\log^2 x}\right).$$

By Abel's identity we have

$$\begin{aligned} \sum_{p < x} p \log^2 p &= \sum_{n < x} a(n) n \log^2 n = \pi(x) \cdot x \log^2 x - \int_2^x \pi(t) (\log^2 t + 2 \log t) dt \\ &= x^2 \log x + O(x^2) - \int_2^x (t \log t + O(t)) dt \end{aligned}$$

We can easily get

$$\int_2^x t \log t dt = \frac{1}{2} x^2 \log x + O(x^2),$$

Therefore

$$\sum_{p \leq x} p \log^2 p = \frac{1}{2} x^2 \log x + O(x^2).$$

Similarly we can get,

$$\sum_{p < x} p \log p \ll x^2.$$

So we have

$$\sum_{n < x} \Lambda_1(n) \log k(n) = \frac{1}{2} x^2 \log x + O(x^2).$$

This proves Theorem 1.

From Lemma 1, Lemma 2 and the definition of $k(n)$ we have

$$\begin{aligned} \sum_{n \leq x} \Lambda(n) \log k(n) &= \sum_{p^\alpha < x} \log p \log(S_p(\alpha)!/p^\alpha) \\ &= \sum_{p^\alpha < x} \log p [S_p(\alpha) \log S_p(\alpha) - S_p(\alpha) + O(\log S_p(\alpha)) - \alpha \log p] \\ &= \sum_{p^\alpha < x} [\alpha p \log^2 p + O(\alpha p \log p \log \alpha)] = \sum_{\alpha < \log_2 x} \sum_{p \leq x^{1/\alpha}} [\alpha p \log^2 p + O(\alpha p \log p \log \alpha)]. \end{aligned}$$

Note that

$$\begin{aligned} \sum_{\alpha < \log_2 x} \sum_{p < x^{1/\alpha}} \alpha p \log^2 p - \sum_{p \leq x} p \log^2 p &= \sum_{2 < \alpha < \log_2 x} \sum_{p < x^{1/\alpha}} \alpha p \log^2 p \\ &\ll \sum_{2 \leq \alpha \leq \log_2 x} \alpha x^{2/\alpha} \log^2 x^{1/\alpha} \ll x \log^4 x \end{aligned}$$

and

$$\begin{aligned} \sum_{\alpha \leq \log_2 x} \sum_{p \leq x^{1/\alpha}} \alpha p \log p \log \alpha &= \sum_{2 < \alpha \leq \log_2 x} \sum_{p \leq x^{1/\alpha}} \alpha p \log p \log \alpha \\ &\ll \sum_{2 < \alpha < \log_2 x} \alpha \log \alpha x^{2/\alpha} \log x^{1/\alpha} \ll x \log^3 x \log \log x, \end{aligned}$$

so we have

$$\sum_{n \leq x} \Lambda(n) \log k(n) = \frac{1}{2} x^2 \log x + O(x^2).$$

This completes the proof of Theorem 2.

ACKNOWLEDGMENTS

The authors express their gratitude to their supervisor Professor Zhang Wenpeng for his very helpful and detailed instructions.

REFERENCES

1. F. Smarandache, *Only problems, not solutions*, Xiquan Publ. House, Chicago, 1993.
2. Tom M. Apostol, *Introduction to Analytic Number Theory*, Springer-Verlag, New York, 1976.

ON THE MEAN VALUE OF SMARANDACHE DOUBLE FACTORIAL FUNCTION*

GAO JING AND LIU HUANING

Department of Mathematics, Northwest University
Xi'an, Shaanxi, P.R.China

ABSTRACT. For any positive integer n , the Smarandache double factorial function $d_f(n)$ is defined to be the smallest integer such that $d_f(n)!!$ is a multiple of n . In this paper, we study the hybrid mean value of the Smarandache double factorial function and the Mangoldt function, and give a sharp asymptotic formula.

1. INTRODUCTION AND RESULTS

For any positive integer n , the Smarandache double factorial function $d_f(n)$ is defined to be the smallest integer such that $d_f(n)!!$ is a factorial number. For example, $d_f(1) = 1$, $d_f(2) = 2$, $d_f(3) = 3$, $d_f(4) = 4$, $d_f(5) = 5$, $d_f(6) = 6$, $d_f(7) = 7$, $d_f(8) = 4$, \dots . Professor F. Smarandache [1] asks us to study the sequence. About this problem, we know very little. There are many papers on the Smarandache double factorial function. For example, some arithmetic properties of this sequence are studied by C.Dumitrescu, V. Seleacu [2] and Felice Russo [3], [4]. The problem is interesting because it can help us to calculate the Smarandache function.

In this paper, we study the hybrid mean value of the Smarandache double factorial function and the Mangoldt function, and give a sharp asymptotic formula. That is, we shall prove the following theorems.

Theorem 1. *If $x \geq 2$, then for any positive integer k we have*

$$\sum_{n < x} \Lambda_1(n) d_f(n) = x^2 \left(\frac{1}{2} + \sum_{m=1}^{k-1} \frac{a_m}{\log^m x} \right) + O \left(\frac{x^2}{\log^k x} \right),$$

where

$$\Lambda_1(n) = \begin{cases} \log p, & \text{if } n \text{ is a prime } p; \\ 0, & \text{otherwise,} \end{cases}$$

and $a_m (m = 1, 2, \dots, k-1)$ are computable constants.

Key words and phrases. Double factorial numbers; Hybrid mean value; Asymptotic formula.

*This work is supported by the N.S.F.(10271093) and P.N.S.F of P.R.China.

Theorem 2. *If $x \geq 2$, then for any positive integer k we have*

$$\sum_{n \leq x} \Lambda(n) d_f(n) = x^2 \left(\frac{1}{2} + \sum_{m=1}^{k-1} \frac{a_m}{\log^m x} \right) + O\left(\frac{x^2}{\log^k x}\right),$$

where $\Lambda(n)$ is the Mangoldt function.

2. SOME LEMMAS

To complete the proofs of the theorems, we need the following lemma.

Lemma 1. *For any positive integer α , if $p \geq (2\alpha - 1)$ we have*

$$d_f(p^\alpha) = (2\alpha - 1)p.$$

Proof. This is Theorem 5 of [4].

3. PROOFS OF THE THEOREMS

In this section, we complete the proofs of the theorems. Let

$$a(n) = \begin{cases} 1, & \text{if } n \text{ is prime;} \\ 0, & \text{otherwise,} \end{cases}$$

then for any positive integer k we have

$$\sum_{n \leq x} a(n) = \pi(x) = \frac{x}{\log x} \left(1 + \sum_{m=1}^{k-1} \frac{m!}{\log^m x} \right) + O\left(\frac{x}{\log^{k+1} x}\right).$$

By Abel's identity we have

$$\begin{aligned} \sum_{n \leq x} \Lambda_1 d_f(n) &= \sum_{p \leq x} p \log p = \sum_{n \leq x} a(n) n \log n = \pi(x) \cdot x \log x - \int_2^x \pi(t) (\log t + 1) dt \\ &= x^2 \left(1 + \sum_{m=1}^{k-1} \frac{m!}{\log^m x} \right) + O\left(\frac{x^2}{\log^k x}\right) \\ &= \int_2^x \left(t + \frac{t}{\log t} + t \sum_{m=1}^{k-1} \frac{m!}{\log^m t} + \frac{t}{\log t} \sum_{m=1}^{k-1} \frac{m!}{\log^m t} + O\left(\frac{t(\log t + 1)}{\log^{k+1} t}\right) \right) dt \\ &= x^2 \left(\frac{1}{2} + \sum_{m=1}^{k-1} \frac{a_m}{\log^m x} \right) + O\left(\frac{x^2}{\log^k x}\right), \end{aligned}$$

where $a_m (m = 1, 2, \dots, k-1)$ are computable constants. Therefore

$$\sum_{p < x} p \log p = x^2 \left(\frac{1}{2} + \sum_{m=1}^{k-1} \frac{a_m}{\log^m x} \right) + O\left(\frac{x^2}{\log^k x}\right).$$

So we have

$$\sum_{n < x} \Lambda_1(n) d_f(n) = x^2 \left(\frac{1}{2} + \sum_{m=1}^{k-1} \frac{a_m}{\log^m x} \right) + O\left(\frac{x^2}{\log^k x}\right).$$

This proves Theorem 1.

It is obvious that $d_f(p^\alpha) \leq (2\alpha - 1)p$. From Lemma 1 we have

$$\sum_{n < x} \Lambda(n) d_f(n) = \sum_{p^\alpha < x} \log p [(2\alpha - 1)p] + \sum_{\substack{p^\alpha < x \\ p < (2\alpha - 1)}} \log p [d_f(p^\alpha) - (2\alpha - 1)p].$$

Note that

$$\begin{aligned} & \sum_{p^\alpha < x} (2\alpha - 1)p \log p - \sum_{p^\alpha < x} p \log p = \sum_{\alpha \leq \frac{\log x}{\log p}} \sum_{p \leq x^{1/\alpha}} p \log p (2\alpha - 1) - \sum_{p^\alpha \leq x} p \log p \\ & = \sum_{2 < \alpha \leq \frac{\log x}{\log p}} \sum_{p \leq x^{1/\alpha}} p \log p (2\alpha - 1) \ll \sum_{2 < \alpha \leq \frac{\log x}{\log p}} \alpha x^{2/\alpha} \log x^{1/\alpha} \ll x \log^3 x \end{aligned}$$

and

$$\begin{aligned} & \sum_{\substack{p^\alpha < x \\ p < (2\alpha - 1)}} \log p [d_f(p^\alpha) - (2\alpha - 1)p] \ll \sum_{\alpha < \frac{\log x}{\log 2}} \sum_{p < (2\alpha - 1)} \alpha p \log p \\ & \ll \sum_{\alpha < \frac{\log x}{\log 2}} (2\alpha - 1)^2 \alpha \log(2\alpha - 1) \ll \log^3 x, \end{aligned}$$

so we have

$$\sum_{n < x} \Lambda(n) d_f(n) = x^2 \left(\frac{1}{2} + \sum_{m=1}^{k-1} \frac{a_m}{\log^m x} \right) + O\left(\frac{x^2}{\log^k x}\right).$$

This completes the proof of Theorem 2.

ACKNOWLEDGMENTS

The authors express their gratitude to their supervisor Professor Zhang Wenpeng for his very helpful and detailed instructions.

REFERENCES

1. F. Smarandache, *Only problems, not solutions*, Xiquan Publ. House, Chicago, 1993.
2. C. Dumitrescu and V. Seleacu, *Some notions and questions in Number Theory*, Erhus Univ. Press, Glendale, 1994.
3. Felice Russo, *A set of new Smarandache functions, sequences and conjectures in number theory*, American Research Press, 2000.
4. Felice Russo, *Five properties of the Smarandache Double Factorial Function*, Smarandache Notions Journal 13 (2002), 183-185.

The Density of Generalized Smarandache Palindromes

Charles Ashbacher
Charles Ashbacher Technologies
Hiawatha, IA 52233 USA

Lori Neiryck
Mount Mercy College
1330 Elmhurst Drive
Cedar Rapids, IA 52402 USA

An integer is said to be a palindrome if it reads the same forwards and backwards. For example, 12321 is a palindromic number. It is easy to prove that the density of the palindromes is zero in the set of positive integers.

A *Generalized Smarandache Palindrome* (GSP) is any integer of the form

$$a_1 a_2 a_3 \dots a_n a_n \dots a_3 a_2 a_1 \quad \text{or} \quad a_1 a_2 a_3 \dots a_{n-1} a_n a_{n-1} \dots a_3 a_2 a_1$$

where all $a_1, a_2, a_3, \dots, a_n$ are integers having one or more digits [1], [2]. For example,

10101010 and 101010

are GSPs because they can be split into the forms

$$(10)(10)(10)(10) \quad \text{and} \quad (10)(10)(10)$$

and the segments are pairwise identical across the middle of the number.

As a point of clarification, we remove the possibility of the trivial case of enclosing the entire number

$$12345 \quad \text{written as} \quad (12345)$$

which would make every number a GSP. This possibility is eliminated by requiring that each number be split into at least two segments if it is not a regular palindrome.

Also, the number 100610

is considered to be a GSP, as the splitting

$$(10)(06)(10)$$

leads to an interior string that is a separate segment, which is a palindrome by default.

Obviously, since each regular palindrome is also a GSP and there are GSPs that are not regular palindromes, there are more GSPs than there are regular palindromes. Therefore, the density of GSPs is greater than or equal to zero and we consider the following question.

What is the density of GSPs in the positive integers?

The first step in the process is very easy to prove.

Theorem: The density of GSPs in the positive integers is greater than 0.1.

Proof: Consider a positive integer having an arbitrary number of digits.

$$a_n a_{n-1} \dots a_2 a_1 a_0$$

and all numbers of the form

$$(k) a_{n-1} \dots a_1 (k)$$

are GSPs, and there are nine different choices for k . For each of these choices, one tenth of the values of the trailing digit would match it. Therefore, the density of GSPs is at least one tenth.

The simple proof of the previous theorem illustrates the basic idea that if the initial and terminal segments of the number are equal, then the number is a generalized palindrome and the values of the interior digits are irrelevant. This leads us to our general theorem.

Theorem: The density of GSPs in the positive integers is approximately 0.11.

Proof: Consider a positive integer having an arbitrary number of digits.

$$a_n a_{n-1} \dots a_2 a_1 a_0$$

If the first and last digits are equal and nonzero, then the number is a generalized palindrome. As was demonstrated in the previous theorem, the likelihood of this is 0.10.

If $a_n = a_1$ and $a_{n-1} = a_0$, then the number is a GSP. Since the GSPs where $a_n = a_0$ have already been counted in the previous step, the conditions are

$$a_n = a_1 \text{ and } a_{n-1} = a_0 \text{ and } a_n \neq a_0$$

The situation is equivalent to choosing a nonzero digit for a_n , and decimal digits for a_{n-1} and a_0 that satisfy these conditions. This probability of this is easy to compute and is 0.009.

If $a_n = a_2$, $a_{n-1} = a_1$ and $a_{n-2} = a_0$, then the number is a GSP. To determine the probability here, we need to choose six digits, where a_n is nonzero and the digits do not also satisfy the conditions of the two previous cases. This is also easily computed, and the value is 0.0009.

The case where $a_n = a_3$, $a_{n-1} = a_2$, $a_{n-2} = a_1$ and $a_{n-3} = a_0$ is the next one, and the probability of satisfying this case after failing in the three previous cases is 0.0000891.

The sum of these probabilities is $0.10 + 0.009 + 0.0009 + 0.0000891$, which is 0.1099891.

This process could be continued for initial and terminal segments longer and longer, but the probabilities would not be enough to make the sum 0.11.

References

1. G. Gregory, Generalized Smarandache Palindromes,
<http://www.gallup.unm.edu/~smarandache/GSP.htm>.
2. F. Smarandache, Generalized Palindromes, Arizona State University Special Collections,
Tempe.

ON THE CUBE FREE NUMBER SEQUENCES

ZHU WEIYI

College of Mathematics, Physics and Information
Science, Zhejiang Normal University
Jinhua, Zhejiang, P.R.China

ABSTRACT. The main purpose of this paper is to study the asymptotic property of the cube free numbers, and obtain some interesting asymptotic formulas.

1. INTRODUCTION AND RESULTS

A natural number a is called a cube free number if it can not be divided by any b^3 , where $b \geq 2$ is an integer. One can obtain all cube free numbers by the following method: From the set of natural numbers (except 0 and 1)

-take off all multiples of 2^3 (i.e. 8, 16, 24, 32, 40, ...).

-take off all multiples of 3^3 .

-take off all multiples of 5^3 .

...and so on (take off all multiples of all cube primes).

Now the cube free number sequences is 2, 3, 4, 5, 6, 7, 9, 10, 11, 12, 13, 14, 15, 17, In reference [1], Professor F. Smarandache asked us to study the properties of the cube free number sequences. About this problem, it seems that none had studied it before. In this paper, we use the analytic method to study the asymptotic properties of this sequences, and obtain some interesting asymptotic formulas. That is, we shall prove the following three Theorems.

Theorem 1. *Let A denotes the set of all cube free numbers. Then we have the asymptotic formula*

$$\sum_{\substack{a \in A \\ a \leq x}} a = \frac{x^2}{2\zeta(3)} + O\left(x^{\frac{3}{2}+\varepsilon}\right),$$

where ε denotes any fixed positive number, $\zeta(s)$ is the Riemann zeta-function.

Theorem 2. *Let A denotes the set of all cube free numbers, $\varphi(n)$ is the Euler function. Then we have the asymptotic formula*

$$\sum_{\substack{a \in A \\ a \leq x}} \varphi(a) = \frac{x^2}{2\zeta(3)} \prod_p \left(1 - \frac{p+1}{p^3+p^2+1}\right) + O\left(x^{\frac{3}{2}+\varepsilon}\right).$$

Key words and phrases. Cube free numbers; Asymptotic formula; Function of number theory.

Theorem 3. Let A denotes the set of all cube free numbers, $d(n)$ is the Dirichlet divisor function. Then we have the asymptotic formula

$$\sum_{\substack{a \in A \\ a \leq x}} d(a) = \frac{36x}{\pi^4} \prod_p \frac{p^2 + 2p + 3}{(1+p)^2} \left(\ln x + (2\gamma - 1) - \frac{24\zeta'(2)}{\pi^2} - 4 \sum_p \frac{p \ln p}{(p^2 + 2p + 3)(1+p)} \right) + O(x^{\frac{1}{2} + \epsilon}),$$

where $\zeta'(2) = -\sum_{n=2}^{\infty} \frac{\ln n}{n^2}$, \sum_p denotes the summation over all primes.

2. PROOF OF THE THEOREMS

In this section, we shall complete the proof of the Theorems. For conveniently we define a new number theory function $a(n)$ as follows:

$$a(n) = \begin{cases} 0, & \text{if } n = 1; \\ n, & \text{if } k^3 \nmid n, n > 1, k \geq 2 \\ 0, & \text{if } k^3 \mid n, n > 1, k \geq 2 \end{cases}$$

It is clear that

$$\sum_{\substack{a \in A \\ a \leq x}} a = \sum_{n \leq x} a(n).$$

Let

$$f(s) = 1 + \sum_{n=1}^{\infty} \frac{a(n)}{n^s}.$$

From the Euler product formula [2] and the definition of $a(n)$ we have

$$f(s) = \prod_p \left(1 + \frac{a(p)}{p^s} + \frac{a(p^2)}{p^{2s}} \right) = \prod_p \left(1 + \frac{1}{p^{s-1}} + \frac{1}{p^{2(s-1)}} \right) = \frac{\zeta(s-1)}{\zeta(3(s-1))}.$$

By Perron formula [3] we have

$$\sum_{n \leq x} \frac{a(n)}{n^{s_0}} = \frac{1}{2i\pi} \int_{b-iT}^{b+iT} f(s+s_0) \frac{x^s}{s} ds + O\left(\frac{x^b B(b+\sigma_0)}{T}\right) + O\left(x^{1-\sigma_0} H(2x) \min\left(1, \frac{\log x}{T}\right)\right) + O\left(x^{-\sigma_0} H(N) \min\left(1, \frac{x}{\|x\|}\right)\right).$$

Taking $s_0 = 0$, $b = 3$, $T = x^{\frac{3}{2}}$, $H(x) = x$, $B(\sigma) = \frac{1}{\sigma-2}$, in the above formula, then we have

$$\sum_{n \leq x} a(n) = \frac{1}{2i\pi} \int_{3-iT}^{3+iT} \frac{\zeta(s-1)}{\zeta(3(s-1))} \frac{x^s}{s} ds + O(x^{\frac{3}{2} + \epsilon}).$$

To estimate the main term

$$\frac{1}{2i\pi} \int_{3-iT}^{3+iT} \frac{\zeta(s-1)x^s}{\zeta(3(s-1))s} ds,$$

we move the integral line from $s = 3 + it$ to $s = \frac{3}{2} + it$. This time, the function

$$f(s) = \frac{\zeta(s-1)x^s}{\zeta(3(s-1))s}$$

have a simple pole point at $s = 2$, so we have

$$\frac{1}{2i\pi} \left(\int_{3-iT}^{3+iT} + \int_{3+iT}^{\frac{3}{2}+iT} + \int_{\frac{3}{2}+iT}^{\frac{3}{2}-iT} + \int_{\frac{3}{2}-iT}^{3-iT} \frac{\zeta(s-1)x^s}{\zeta(3(s-1))s} ds \right) = \frac{x^2}{2\zeta(3)}.$$

We can easy get the estimate

$$\left| \frac{1}{2i\pi} \int_{\frac{3}{2}-iT}^{\frac{3}{2}+iT} \frac{\zeta(s-1)x^s}{\zeta(3(s-1))s} ds \right| \ll x^{\frac{3}{2}+\varepsilon};$$

$$\left| \frac{1}{2i\pi} \int_{\frac{3}{2}-iT}^{3+iT} \frac{\zeta(s-1)x^s}{\zeta(3(s-1))s} ds \right| \ll \frac{x^{3+\varepsilon}}{T}$$

and

$$\left| \frac{1}{2i\pi} \int_{\frac{3}{2}+iT}^{3+iT} \frac{\zeta(s-1)x^s}{\zeta(3(s-1))s} ds \right| \ll \frac{x^{3+\varepsilon}}{T}.$$

Taking $T = x^{\frac{3}{2}}$, we have

$$\sum_{\substack{a \in A \\ a \leq x}} a = \sum_{n \leq x} a(n) = \frac{x^2}{2\zeta(3)} + O\left(x^{\frac{3}{2}+\varepsilon}\right).$$

This completes the proof of Theorem 1.

$$\text{Let } f_1(s) = 1 + \sum_{n=1}^{\infty} \frac{\varphi(a(n))}{n^s} \quad \text{and} \quad f_2(s) = 1 + \sum_{n=1}^{\infty} \frac{d(a(n))}{n^s}.$$

From the Euler product formula [2] and the definition of $a(n)$, we also have

$$\begin{aligned} f_1(s) &= \prod_p \left(1 + \frac{\varphi(a(p))}{p^s} + \frac{\varphi(a(p^2))}{p^{2s}} \right) = \prod_p \left(1 + \frac{p-1}{p^s} + \frac{p^2-p}{p^{2s}} \right) \\ &= \prod_p \left(1 + \frac{1}{p^{s-1}} + \frac{1}{p^{2(s-1)}} - \frac{1}{p^s} - \frac{1}{p^{2s-1}} \right) \\ &= \frac{\zeta(s-1)}{\zeta(3(s-1))} \prod_p \left(1 - \frac{p^{s-1} + 1}{p^{2s-1} + p^s + p} \right); \end{aligned}$$

$$\begin{aligned}
f_2(s) &= \prod_p \left(1 + \frac{d(a(p))}{p^s} + \frac{d(a(p^2))}{p^{2s}} \right) = \prod_p \left(1 + \frac{2}{p^s} + \frac{3}{p^{2s}} \right) \\
&= \prod_p \left(\left(1 + \frac{1}{p^s} \right)^2 + \frac{2}{p^{2s}} \right) = \prod_p \left(1 + \frac{1}{p^s} \right)^2 \left(1 + \frac{\frac{2}{p^{2s}}}{\left(1 + \frac{1}{p^s} \right)^2} \right) \\
&= \frac{\zeta^2(s)}{\zeta^2(2s)} \prod_p \left(1 + \frac{2}{(p^s + 1)^2} \right).
\end{aligned}$$

By Perron formula [3] and the method of proving Theorem 1 we can easy obtain

$$\sum_{\substack{a \in A \\ a \leq x}} \varphi(a) = \frac{x^2}{2\zeta(3)} \prod_p \left(1 - \frac{p+1}{p^3 + p^2 + p} \right) + O\left(x^{\frac{3}{2}+\varepsilon}\right);$$

$$\begin{aligned}
\sum_{\substack{a \in A \\ a \leq x}} d(a) &= \prod_p \frac{p^2 + 2p + 3}{(1+p)^2} \times \\
&\frac{x}{\zeta^2(2)} \left(\ln x + (2\gamma - 1) - 4 \frac{\zeta'(2)}{\zeta(2)} - 4 \sum_p \frac{p \ln p}{(p^2 + 2p + 3)(1+p)} \right) + O\left(x^{\frac{1}{2}+\varepsilon}\right).
\end{aligned}$$

This proves the Theorem 2 and Theorem 3.

REFERENCES

1. F. Smarndache, *ONLY PROBLEMS, NOT SOLUTION!*, Xiquan Publishing House, Chicago, 1993, pp. 27.
2. Tom M. Apostol, *Introduction to Analytic Number Theory*, Springer-Verlag, New York, 1976.
3. Pan Chengdong and Pan Chengbiao, *Foundation of Analytic Number Theory*, Science Press, Beijing, 1997, pp. 98.

ON THE 49-TH SMARANDACHE'S PROBLEM*

GAO JING

Department of Mathematics, Northwest University
Xi'an, Shaanxi, P.R.China

ABSTRACT. For any prime number p and positive integer n , let $S_p(n)$ be the smallest integer such that $S_p(n)!$ is divisible by p^n . In this paper, we study the mean value of the Dirichlet series with coefficients $S_p(n)$. We also show that $S_p(n)$ closely relates to Riemann Zeta function, and give a few asymptotic formulae involving $S_p(n)$ and other arithmetic functions.

1. INTRODUCTION AND RESULTS

For any prime number p and positive integer n , let $S_p(n)$ be the smallest integer such that $S_p(n)!$ is divisible by p^n . For example, $S_3(1) = 3$, $S_3(2) = 6$, $S_3(3) = 9$, $S_3(4) = 9$, $S_3(5) = 12$, $S_3(6) = 15$, $S_3(7) = 18$, \dots . It is obvious that $p \mid S_p(n)$ and $S_p(n) \leq np$. Professor F. Smarandache [1] asks us to study the sequence. About this problem, we know very little. The problem is interesting because it can help us to calculate the Smarandache function.

It seems that $S_p(n)$ closely relates to Riemann Zeta function. In fact, for real $s > 1$, we consider the Dirichlet series with coefficients $S_p(n)$. The series $\sum S_p(n)n^{-s}$ converges absolutely as $s > 2$ since $S_p(n) \leq np$. In this paper, we study the mean value of the Dirichlet series with coefficients $S_p(n)$, and give a few asymptotic formulae involving $S_p(n)$ and other arithmetic functions.

Theorem 1. *For any given s , we have*

$$\sum_{n=1}^{\infty} \frac{S_p(n)}{n^s} = (p-1)\zeta(s-1) + R_1(s, p), \quad s > 2;$$
$$\sum_{n=1}^{\infty} \frac{\phi(n)S_p(n)}{n^s} = \frac{(p-1)\zeta(s-2)}{\zeta(s-1)} + R_2(s, p), \quad s > 3,$$

where

$$R_1(s, p) \leq \frac{p-1}{\log 2} \sum_{n=1}^{\infty} \frac{\log n + \log p}{n^s}, \quad R_2(s, p) \leq \frac{p-1}{\log 2} \sum_{n=1}^{\infty} \frac{\phi(n)(\log n + \log p)}{n^s}.$$

From our theorem we know that $S_p(n)$ closely relates to Riemann Zeta function. Using our formulae we can calculate the mean value of $S_p(n)$.

Key words and phrases. Primitive numbers; Dirichlet series; Mean value; Asymptotic formula.

*The author expresses his gratitude to Professor Zhang Wenpeng for his very helpful and detailed instructions. This work is supported by the N.S.F.(10271093) and P.N.S.F of P.R.China.

2. SOME LEMMAS

To complete the proof of the theorem, we need the following lemma.

Lemma 1. *For any prime number p and positive integer n , let $S_p(n)$ be the smallest integer such that $S_p(n)!$ is divisible by p^n . Then we have*

$$n(p-1) \leq S_p(n) \leq \left(n + \frac{\log(np)}{\log 2} \right) (p-1).$$

Proof. By Theorem 3.14 of [2] we have

$$S_p(n)! = \prod_{p_1 \leq S_p(n)} p_1^{\alpha(p_1)}, \quad \alpha(p_1) = \sum_{m=1}^{\infty} \left[\frac{S_p(n)}{p_1^m} \right],$$

where $\prod_{p_1 \leq x}$ denotes the product over prime numbers not exceeding x . Note that $p^n \mid S_p(n)!$, we get

$$n \leq \alpha(p) = \sum_{m=1}^{\infty} \left[\frac{S_p(n)}{p^m} \right] \leq \sum_{m=1}^{\infty} \frac{S_p(n)}{p^m} = \frac{S_p(n)}{p-1}.$$

On the other hand, $p^{n+1} \nmid (S_p(n)-1)!$ since $p \mid S_p(n)$. Therefore

$$n-1 \geq \sum_{m=1}^{\infty} \left[\frac{S_p(n)-1}{p^m} \right] \geq \sum_{m=1}^{\infty} \frac{S_p(n)-1}{p^m} - \sum_{\substack{m=1 \\ p^m \leq S_p(n)-1}}^{\infty} 1 \geq \frac{S_p(n)-1}{p-1} - \frac{\log(np)}{\log 2}.$$

So we have

$$S_p(n) \leq \left(n-1 + \frac{\log(np)}{\log 2} \right) (p-1) + 1 \leq \left(n + \frac{\log(np)}{\log 2} \right) (p-1).$$

This proves Lemma 1.

3. PROOF OF THE THEOREM

In this section, we complete the proof of Theorem 1. From Lemma 1 we have

$$S_p(n) = n(p-1) + O((p-1)(\log n + \log p)).$$

From Theorem 3.2 of [2] we immediately get

$$\sum_{n=1}^{\infty} \frac{S_p(n)}{n^s} = (p-1)\zeta(s-1) + R_1(s, p), \quad s > 2,$$

where

$$R_1(s, p) \leq \frac{p-1}{\log 2} \sum_{n=1}^{\infty} \frac{\log n + \log p}{n^s}.$$

Similarly we can deduce other formula.

This completes the proof of Theorem 1.

REFERENCES

1. F. Smarandache, *Only problems, not solutions*, Xiquan Publ. House, Chicago, 1993.
2. Tom M. Apostol, *Introduction to Analytic Number Theory*, Springer-Verlag, New York, 1976.

PAPER MODELS OF SURFACES WITH CURVATURE
CREATIVE VISUALIZATION LABS
BALTIMORE JOINT MATHEMATICS MEETINGS

HOWARD ISERI

DEPARTMENT OF MATHEMATICS AND COMPUTER INFORMATION SCIENCE

MANSFIELD UNIVERSITY

MANSFIELD, PA 16933

ABSTRACT. A model of a cone can be constructed from a piece of paper by removing a wedge and taping the edges together. The paper models discussed here expand on this idea (one or more wedges are added and/or removed). These models are flat everywhere, except at the "cone points," so the geodesics are locally straight lines in a natural sense. Non-Euclidean "effects" are easily quantifiable using basic geometry, the Gauss-Bonnet theorem is a naturally intuitive concept, and the connection between hyperbolic and elliptic geometry and curvature is clearly seen.

1. OBJECTIVES AND NOTES

The notion that a geometric space can be manipulated is an idea that I would like to instill in students. A number of behaviors of lines/geodesics can be found by constructing a variety of surfaces. I believe that this can be of value, as it is in topology where metric spaces with marginally intuitive properties are readily available. All of the models described in the labs are essentially 2-manifolds, so the notion that there are many accessible manifolds will hopefully be carried by the student into a study of differential geometry or topology.

The local geometry of these paper models corresponds directly to the geometry of smoothly curved surfaces, so they can be used as an introduction to a study of Riemannian geometry. Geodesics on these surfaces are easy to find, since they are straight lines when the paper is flattened, and a protractor can measure the *angle defect*, which is essentially equivalent to a measure of total curvature. Since the Gauss curvature is an infinitesimal version of the angle defect, the definition of Gauss curvature can be motivated in terms of these models. Furthermore, there is a polyhedral version of the Gauss-Bonnet theorem that is easy to see, and this can be used to make sense of the smooth version.

These labs come from a series of projects I gave to three students doing an independent study course in geometry. The three worked together on these projects with very little help from me, and while these students were stronger than average, I think the labs are appropriate for outside-of-class assignments that are independent of the main course of study. I would assign one lab a week in the month prior to starting non-Euclidean geometry.

2. INTRODUCTION

The geometry of a sphere is fundamentally different from that of the plane. The essence of this difference is captured in the Gauss curvature, where the sphere has constant positive curvature and the plane has zero curvature everywhere. This difference in curvature and geometry manifests itself in the inability to build paper models of the sphere out of flat pieces of paper. A cylinder, on the other hand, is easily constructed from paper, and correspondingly has the same (Gauss) curvature and local geometry as the plane. In fact, the geodesics on the cylinder correspond to straight lines

on the paper when flat, and a cylindrical paper model quickly leads to the realization that the cylindrical geodesics are helices (degenerate and non-degenerate).

A cone can also be constructed from paper. The geodesics, while not as easily described as for the cylinder, can be seen the same way. One characteristic that the cone and sphere share is that no region containing the vertex can be flattened (without tearing the paper). The cone and sphere also share a notion of positive curvature and an elliptic geometry.

The cone formed by removing a wedge measuring θ radians is defined to have an *angle defect* equal to θ . I prefer the term *impulse curvature*, since the angle defect corresponds to a Gauss curvature singularity at the cone point with a finite integral. In fact, if you were to smoothly round off the vertex of the cone and integrate the Gauss curvature, you would get a total curvature of precisely θ . As a result, the Gauss-Bonnet theorem extends nicely to angle defects. Actually, the Gauss-Bonnet theorem on a cone is obvious once you know what to look for, and perhaps we should say that the Gauss-Bonnet theorem is an extension of a polyhedral version due to Descartes. All of this applies equally well to hyperbolic geometry, since adding a wedge introduces a negative angle defect and a negative total curvature.

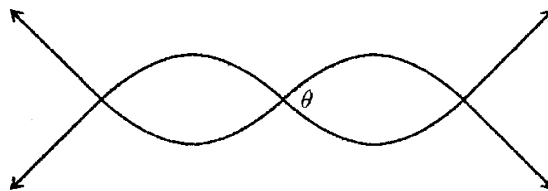

FIGURE 1. A pair of geodesics with three points of intersection

3. A SAMPLE PROBLEM FROM LAB 2

One of the problems in Lab 2 asks the students to construct a surface that has a pair of geodesics with three points of intersection. If the geodesics are to be configured as in Figure 1, they will form two regions bounded by 2-gons. The Gauss-Bonnet theorem requires that the total curvature in each region must equal the angle sum of its bounding 2-gon. If we want the angle at the middle intersection point to be θ radians, therefore, then we need to introduce total curvature greater than θ inside each region. In terms of cone points, we need to introduce two cone points by removing wedges that measure more than θ radians.

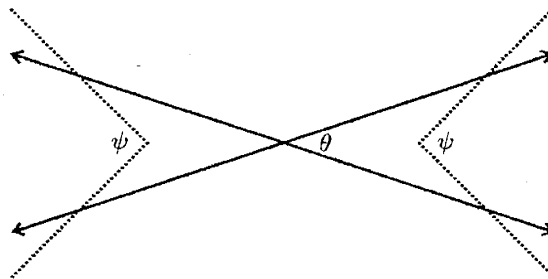

FIGURE 2. We can remove wedges measuring more than θ radians.

We can construct the surface as follows. Start with two lines intersecting at a single point as in Figure 2. We can make the pair of lines intersect twice more by removing two wedges, and clearly

ψ must be greater than θ (without using the Gauss-Bonnet theorem at all). The result is two cone points each with total curvature ψ .

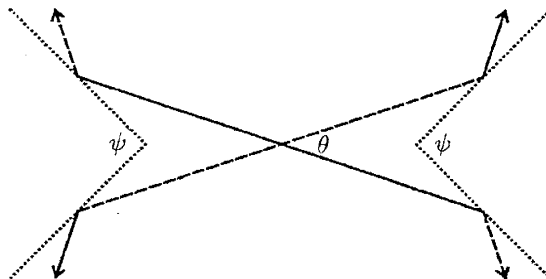

FIGURE 3. The continuations of the geodesics on the surface will look like this.



FIGURE 4. The paper model corresponding to Figure 3 looks like this.

The particular values for θ and ψ can vary greatly, but $\theta = 45^\circ$ and $\psi = 90^\circ$ is convenient to draw, and a paper model can be constructed from the diagram in Figure 3. I have drawn one geodesic solid and one broken to distinguish them. Note that the continuations of each geodesic must intersect the cut at the same angle, so it's easy to do with a ruler and protractor, if you choose convenient angles. The resulting paper model is shown in Figure 4.

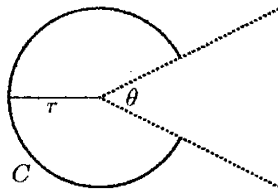

FIGURE 5. The angle defect corresponds to total curvature.

4. GAUSS-BONNET THEOREM

I do not address the Gauss-Bonnet theorem in any of the labs, but after the students have completed the last lab, I would look at the cone point version of the Gauss-Bonnet theorem. From here, the definition for Gauss curvature on a smooth surface should make sense intuitively.

The basic idea can be seen using circles and spheres. Consider a circle of radius r centered at the cone point of a cone with angle defect θ , as in Figure 5. In the plane, this circle will have curvature $\kappa = \frac{1}{r}$. Since the local geometry on the cone is Euclidean away from the cone point, the *geodesic* curvature for this circle as a curve on the cone must be the same. That is, $\kappa_g = \frac{1}{r}$. What is different about this circle and a circle in the plane with the same radius, is that the circle on the cone has a smaller circumference. In fact, the difference must be θr .

We can now compute the total geodesic curvature.

$$(1) \quad \int_C \kappa_g ds = \frac{1}{r} \int_C ds = \frac{1}{r} (2\pi r - \theta r) = 2\pi - \theta.$$

Since curvature measures the rate of rotation of the tangent vector, it should make sense to students that the total rotation for a simple closed curve in the plane must always be 2π . Since any small deformation of the circle essentially takes place in the plane, it should also make sense that the total rotation for a simple closed curve around the cone point will always be 2π minus the angle defect. In any case, the formulation of the Gauss-Bonnet theorem should seem natural.

Comparing Equation (1) to the Gauss-Bonnet theorem,

$$(2) \quad \int_C \kappa_g ds = 2\pi - \int_R K dA,$$

it's obvious that the angle defect corresponds with the total curvature $\int K dA$. In fact, I think it makes perfect sense to motivate the definition of the Gauss curvature K in terms of this formula. I might start out by doing the following.

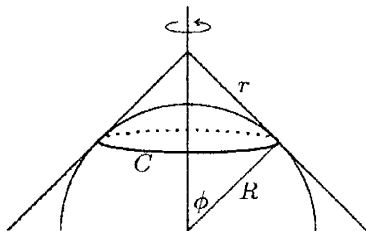

FIGURE 6. The circle of tangency will have the same geodesic curvature on both surfaces.

Consider a sphere tangent to a cone, as shown in Figure 6. The geodesic curvature for the circle of tangency will be the same on both surfaces. Therefore, the total curvature for the regions contained by the circle on both surfaces should be the same. We can then require that the Gauss curvature be an infinitesimal version of the total curvature and that it be constant on the sphere. That is,

$$(3) \quad \theta = \int_D K dA = K \int_D dA = K R^2 \theta,$$

and

$$(4) \quad K = \frac{1}{R^2}.$$

I think the actual computation is a bit tricky, but there may be a simpler way. In any case, the area integral is

$$(5) \quad \int_D dA = \int_0^{2\pi} \int_0^\phi R^2 \sin p \, dp dt = R^2(1 - \cos \phi)2\pi,$$

where the parameters p and t are the ϕ and θ from spherical coordinates. To express this expression in terms of θ , note that the circumference of the circle C is $2\pi r = \theta r$ on the cone. If the radius of this circle in space is ρ , then this circumference is also $2\pi\rho$. Since $R \sin \phi = \rho$, we have that

$$(6) \quad 2\pi r = \theta r = 2\pi R \sin \phi,$$

and

$$(7) \quad \theta = 2\pi(1 + \frac{R}{r} \sin \phi).$$

Now, $\tan \phi = \frac{r}{R}$, so

$$(8) \quad \theta = 2\pi(1 + \frac{\cos \phi}{\sin \phi} \sin \phi) = 2\pi(1 + \cos \phi).$$

Equations (5) and (8) establish equation (3).

5. FURTHER READING

Total curvature was studied at least as far back as Descartes, where he used the term *inclination of the solid angle* in his investigations of convex polyhedra. It seems that the term *angle defect* is now standard. As mentioned, Descartes also had a formula that is a Gauss-Bonnet theorem for convex polyhedra. I've found some historical bits about this in [1], but I'm not sure if Gauss knew about Descartes' work when he was studying the curvature of surfaces. I intend to check this out eventually, but I get the sense that the geometry of cone points is too obvious to mention for working geometers, so this may have been the case for Gauss as well.

I first became aware of Descartes' work with angle defects from an article by H. Gottlieb called "All the way with Gauss-Bonnet" in the *Math Monthly* [2], and an article on the AMS website called "Descartes's lost theorem" [4]. The first article is an excellent second introduction to curvature.

My general interest started through my involvement with the Smarandache Geometry Club (Yahoo). The members of this club were interested in geometric spaces that satisfied Euclidean axioms in some instances and violated them in others. This would be somewhat normal in a Riemannian manifold, and I remembered reading about something Jeff Weeks called *hyperbolic paper* in *The Shape of Space* ([6]). This hyperbolic paper was constructed by taping equilateral triangles together so that there were seven triangles around each vertex. The result is a paper model with a bunch of cone points with angle defect equal to $\frac{\pi}{3}$. Building on this idea, I was able to build a lot of models that exhibited properties that the members of the club were looking for, and I eventually wrote a little book on the subject called *Smarandache Manifolds* ([3]). I think one of the difficulties in motivating proofs in Euclidean geometry is that students have a hard time imagining how any of the theorems could not be true. It's hard to justify a confusing proof for a statement that is obviously true. This book has lots of counter-examples. I have copies to give away, so let me know, if you want one.

I think cone points come up in the study of orbifolds, but they seem to fit most naturally in an area called computational geometry. I know almost nothing about either of these subjects, but [5] is a nice, accessible article by two leading computational geometers.

REFERENCES

- (1) P.J. Federico, *Descartes on Polyhedra*, Springer Verlag, New York, 1982.
- (2) H. Gottlieb, *All the way with Gauss-Bonnet and the sociology of mathematics*, *The American Mathematical Monthly* 103 (6), 457-469, 1996.
- (3) H. Iseri, *Smarandache Manifolds*, American Research Press, Rehoboth, NM, USA, 2002. (available at www.Gallup.unm.edu/~smarandache/Iseri-book.PDF)
- (4) T. Phillips, *Descartes's Lost Theorem*, www.ams.org/new-in-math/cover/descartes1.html.
- (5) K. Polthier and M. Schmies, *Straightest geodesics on polyhedral surfaces*, *Mathematical Visualizations*, 1998.
- (6) J. Weeks, *The Shape of Space*, Marcel Dekkar, Inc., New York, 1985.

DIE SMARANDACHE'sche KLASSE VON PARADOXIEN

Herausgegeben von Charles T. Le
Übersetzung: Bernd Hutschenreuther
Rietzstrasse 41
01139 Dresden, Germany
E-mail: Bernd.Hutschenreuther@sz-online.de

<A> sei ein Attribut, und <Nicht-A> seine Negation. Dann gilt:

Paradox 1. ALLES IST <A>, <Nicht-A> AUCH.

Beispiele:

E11: Alles ist möglich, das Unmögliche auch.

E12: Alle sind anwesend, die Abwesenden auch.

E13: Alles ist endlich, das Unendliche auch.

Paradox 2. ALLES IST <Nicht-A>, <A> AUCH.

Beispiele:

E21: Alles ist unmöglich, das Mögliche auch.

E22: Alle sind abwesend, die Anwesenden auch.

E23: Alles ist unendlich, das Endliche auch.

Paradox 3. NICHTS IST <A>, NICHT MAL <A>.

Beispiele:

E31: Nichts ist perfekt, nicht mal das Perfekte.

E32: Nichts ist absolut, nicht mal das Absolute.

E33: Nichts ist endlich, nicht mal das Endliche.

Bemerkung: Die drei Arten der Paradoxe sind äquivalent. Man nennt sie: die Smarandache'sche Klasse von Paradoxen.

Allgemeiner gilt:

Paradox: ALLE (Verb) <A>, <Nicht-A> AUCH

(<Die verallgemeinerte Smarandache'sche Klasse von Paradoxien>

Wenn wir <A> durch ein Attribut ersetzen, finden wir ein Paradox.

Analysieren wir das erste Beispiel: (E11):

<Alles ist möglich, das Unmögliche auch.>

Wenn dieser Satz wahr ist, erhalten wir <das Unmögliche ist auch möglich>, was ein Widerspruch ist;

deshalb ist der Satz falsch (in der Objektsprache).

Aber der Satz kann wahr sein, weil <Alles ist möglich> <das Unmögliche ist möglich> einschließt, d.h.

<es ist möglich, unmögliche Dinge zu haben>,

was korrekt ist (in der Metasprache).

Natürlich gibt es von dieser Art auch erfolglose Paradoxe, aber die vorgeschlagene Methode führt noch zu schönen anderen.

Betrachte das folgende Wortspiel, das an Einstein erinnert:

Alles ist relativ, die (Theory der) Relativity auch!

Weiterhin:

1. Der kürzeste Weg zwischen zwei Punkten ist das Mäander! (*)
 2. Das Unerklärbare ist, natürlich, durch das Wort: "unerklärbar" erklärt!
- (*) Anmerkung des Übersetzers: Bekannt ist auch das Sprichwort: Der kürzeste Weg zwischen zwei Punkten ist der Umweg.

Literatur (Diese Liste habe ich in der vorliegenden Fassung nicht übersetzt.)

- [1] Ashbacher, Charles, "'The Most Paradoxist Mathematician of the World', by Charles T. Le", review in *Journal of Recreational Mathematics*, USA, Vol. 28(2), 130, 1996-7.
- [2] Begay, Anthony, "The Smarandache Semantic Paradox", *Humanistic Mathematics Network Journal*, Harvey Mudd College, Claremont, CA, USA, Issue #17, 48, May 1998.
- [3] Le, Charles T., "The Smarandache Class of Paradoxes", *Bulletin of the Transylvania University of Brasov*, Vol. 1 (36), New Series, Series B, 7-8, 1994.
- [4] Le, Charles T., "The Smarandache Class of Paradoxes", *Bulletin of Pure and Applied Sciences*, Delhi, India, Vol. 14 E (No. 2), 109-110, 1995.
- [5] Le, Charles T., "The Most Paradoxist Mathematician of the World: Florentin Smarandache", *Bulletin of Pure and Applied Sciences*, Delhi, India, Vol. 15E (Maths & Statistics), No. 1, 81-100, January-June 1996.
- [6] Le, Charles T., "The Smarandache Class of Paradoxes", *Journal of Indian Academy of Mathematics*, Indore, Vol. 18, No. 1, 53-55, 1996.
- [7] Le, Charles T., "The Smarandache Class of Paradoxes / (mathematical poem)", Henry C. Bunner / *An Anthology in Memoriam*, Bristol Banner Books, Bristol, IN, USA, 94, 1996.
- [8] Mitroiescu, I., "The Smarandache Class of Paradoxes Applied in Computer Sciences", *Abstracts of Papers Presented to the American Mathematical Society*, New Jersey, USA, Vol. 16, No. 3, 651, Issue 101, 1995.
- [9] Mudge, Michael R., "A Paradoxist Mathematician: His Function, Paradoxist Geometry, and Class of Paradoxes", *Smarandache Notions Journal*, Vail, AZ, USA, Vol. 7, No. 1-2-3, 127-129, 1996.
- [10] Popescu, Marian, "A Model of the Smarandache Paradoxist Geometry", *Abstracts of Papers Presented to the American Mathematical Society*, New Providence, RI, USA, Vol. 17, No. 1, Issue 103, 96T-99-15, 265, 1996.
- [11] Popescu, Titu, "Estetica paradoxismului", Editura Tempus, Bucarest, 26, 27-28, 1995.
- [12] Rotaru, Ion, "Din nou despre Florentin Smarandache", *Vatra*, Tg. Mures, Romania, Nr. 2 (299), 93-94, 1996.
- [13] Seagull, Larry, "Clasa de Paradoxuri Semantice Smarandache" (translation), *Abracadabra*, Salinas, CA, USA, Anul 2, Nr. 20, 2, June 1994.
- [14] Smarandache, Florentin, "Mathematical Fancies & Paradoxes", *The Eugene Strens Memorial on Intuitive and Recreational Mathematics and its History*, University of Calgary, Alberta, Canada, 27 July - 2 August, 1986.
- [15] Tilton, Homer B., "Smarandache's Paradoxes", *Math Power*, Tucson, AZ, USA, Vol. 2, No. 9, 1-2, September 1996.
- [16] Weisstein, Eric W., "Smarandache Paradox", *CRC Concise Encyclopedia of Mathematics*, CRC Press, Boca Raton, FL, 1661, 1998.
- [17] Zitarelli, David E., "Mudge, Michael R. / A Paradoxist Mathematician: His Function, Paradoxist Geometry, and Class of Paradoxes", *Historia Mathematica*, PA, USA, Vol. 24, No. 1, #24.1.119, 114, February 1997.

CONVERGENCE OF THE SMARANDACHE GENERAL CONTINUED FRACTION

BOUAZZA EL WAHBI

DÉPARTEMENT DE MATHÉMATIQUES ET INFORMATIQUE

FACULTÉ DES SCIENCES

B.P.2121 TÉTOUAN

MOROCCO.

ABSTRACT. We give a positive answer to the Smarandache General Continued Fraction convergence (see [2]).

The Smarandache General Continued Fraction associated with the Smarandache reverse sequence 1, 21, 321, 4321, 54321, ..., 121110987654321, ..., is given by

$$(1) \quad 1 + \frac{1}{12 + \frac{21}{123 + \frac{321}{1234 + \frac{4321}{12345 + \dots}}}}$$

(See for more details [2]).

Define the sequences $\{a_n\}_{n \geq 0}$ and $\{b_n\}_{n \geq 0}$ by :

$$a_0 = 1, a_1 = 12, a_2 = 123, \dots$$

$$b_0 = 1, b_1 = 21, b_2 = 321, \dots$$

We verify easily that

$$(2) \quad a_{n+1} = 10a_n + (n+1) \text{ and } b_{n+1} = 10b_n + \frac{10^{(n+1)} - 1}{9}, \text{ for any } n \geq 0.$$

With notations of [1], the continued fraction (1) can be written as follows:

$$a_0 + \frac{b_0|}{|a_1|} + \frac{b_1|}{|a_2|} + \frac{b_2|}{|a_3|} + \dots + \frac{b_{n-1}|}{|a_n|} + \dots$$

Let $\frac{A_k}{B_k}$ be the result of the k^{th} reduce of continued fraction:

$$(3) \quad a_0 + \frac{b_0|}{|a_1|} + \frac{b_1|}{|a_2|} + \frac{b_2|}{|a_3|} + \dots + \frac{b_{k-1}|}{|a_k|}.$$

Thus we define two sequences $\{A_n\}_{n \geq 0}$ and $\{B_n\}_{n \geq 0}$ of real numbers. Using the elementary algebraic theory of continued fraction given by Euler (see [1]) we have the following,

Lemma 0.1. *The sequences $\{A_n\}_{n \geq 0}$ and $\{B_n\}_{n \geq 0}$ satisfy the following statements:*

$$A_n = a_n A_{n-1} + b_n A_{n-2}, \text{ for } n \geq 2, A_{-1} = 0 \text{ and } A_0 = a_1.$$

$$B_n = a_n B_{n-1} + b_n B_{n-2}, \text{ for } n \geq 2, B_{-1} = 0 \text{ and } B_0 = 1.$$

In consequence, we have:

$$A_n B_{n-1} - A_{n-1} B_n = (-1)^{(n-1)} b_0 b_1 \dots b_{n-1}, \text{ for any } n \geq 1$$

And if $B_n \neq 0$, for any $n \geq 0$, we have,

$$\frac{A_n}{B_n} - \frac{A_{n-1}}{B_{n-1}} = (-1)^{(n-1)} \frac{b_1 b_2 \dots b_{n-1}}{B_{n-1} B_n}, \text{ for any } n \geq 1$$

An easy computation gives,

$$\frac{A_n}{B_n} = a_0 + \sum_{k=1}^n (-1)^{(k-1)} \frac{b_0 b_1 \dots b_{k-1}}{B_{k+1} B_k}$$

Hence, we have the following result

Lemma 0.2. *The Smarandache General Continued Fraction (1) is convergent if and only if the alternate series $\sum_{k=1}^n (-1)^{(k-1)} \frac{b_0 b_1 \dots b_{k-1}}{B_{k-1} B_k}$ is also convergent.*

Let $\{u_n\}_{n \geq 0}$ be the sequence of positive real numbers defined by

$$u_n := \frac{b_0 b_1 \dots b_{n-1}}{B_{n-1} B_n} \text{ for } n \geq 1$$

We have,

$$\begin{aligned} u_{n+1} - u_n &= \frac{b_0 b_1 \dots b_n}{B_n B_{n+1}} - \frac{b_0 b_1 \dots b_{n-1}}{B_{n-1} B_n} \\ &= \frac{b_0 b_1 \dots b_{n-1}}{B_n} \left[\frac{b_n}{B_{n+1}} - \frac{1}{B_{n-1}} \right] \\ &= \frac{b_0 b_1 \dots b_{n-1}}{B_{n-1}} \left[\frac{b_n B_{n-1} - B_{n+1}}{B_{n-1} B_{n+1}} \right] \end{aligned}$$

And using the lemma 0.1 , we get

$$u_{n+1} - u_n = \frac{b_0 b_1 \dots b_{n-1}}{B_{n-1} B_n} \left[\frac{b_n - b_{n+1} (B_{n-1} - a_{n+1} B_n)}{B_{n-1} B_{n+1}} \right]$$

And by (2) we have

$$b_n - b_{n+1} = -9b_n - \frac{10^{(n+1)}}{9} \leq 0$$

Because the B_n 's are positive, we deduce that the sequence $\{u_n\}_{n \geq 0}$ is decreasing. On the other hand, we have, $B_n B_{n-1} = [a_n B_{n-1} + b_n B_{n-2}] B_{n-1} \geq b_2 b_3 \dots b_n B_1 B_0$, which implies that

$$u_n \leq \frac{b_0 b_1 \dots b_{n-1}}{b_2 b_3 \dots b_n B_1 B_0} = \frac{b_1}{b_n B_1} = \frac{1}{b_n}$$

The last inequality assert that $\lim_{n \rightarrow +\infty} u_n = 0$. Finally, we have the result

Theorem 0.1. *The Smarandache General Continued Fraction (1) is convergent.*

REFERENCES

- [1] J.Dieudonne, *Fraction continues et polynomes orthogonaux dans l'oeuvre de E.N.Laguerre*, Proceeding of the Laguerre symposium held at Bar-le-Duc, October 15-18, (1984).
- [2] Castillo, Jose, *Smarandache Continued Fractions*, Bulletin of Pure and applied Sciences, Delhi, India, Vol.17E, N1, 149-151, 1988.

The first 10th Smarandache Symmetric Numbers

Muneer Jebreel

SS-Math-Hebron / UNRWA / Field Education Officer /
Box 19149 / Jerusalem / Israel

Abstract: In this article , we present some important observations of the first 10th Smarandache Symmetric Numbers (exclude the second number i.e. 11) , and the relationship of squaring .

In [1] ,the first 10th Smarandache Symmetric Numbers (excluding number 11) , namely ;

1 , 121, 12321, 1234321, 123454321, 12345654321 ,
1234567654321 , 123456787654321 , 12345678987654321 . (1)

Consider (1) , then convert this numbers to the following triangle:

1
121
12321
1234321
123454321
12345654321
1234567654321
123456787654321
12345678987654321

The following observation may interest readers of Smarandache

Notions Journal ;

- 1) The area (in the number of all digits in the above triangle) of this triangle equal 9^2 , which is a square .
- 2) The terminal digits follow the pattern 1,1,1 , ... , 1, which is a square .
- 3)
- 4) The initial digits follow the pattern 1,1,1 , ... , 1 , which is a square .
- 5) The sum of the digits of any number equal perfect square ,

Example ; 121 $\xrightarrow{1+2+1=4}$
 12345678987654321 $\xrightarrow{81}$

Hence , the sum of digits follow the pattern $1^2, 2^2, 3^2, \dots, 9^2$.

6) The number of digits follow the pattern 1,3,5,7,...,17 ,and the sum is , which is a square , namely 81.

7) If we take any column in the triangle then cubing the digits then sum them , we get square for example , take column 5 , then we have 12345 , cubing this digits and sum ; $1^3+2^3+3^3+4^3+5^3=15^2$ So, cubing the digits in columns and sum them, follow the pattern $1^2, 3^2, 6^2, 10^2, 15^2, 21^2, 28^2, 36^2, 45^2$.

8) Any number in the triangle is a perfect square and there is no prime , hence the number follow the pattern : $1^2, 11^2, 111^2, 1111^2, 11111^2, 111111^2, 1111111^2, 11111111^2, 111111111^2$.

9) The bias of triangle looks like $9!$, and $8!$ So if we multiply the bias by its component we get square($9! \times 8! = \text{square}$) .

Know convert the triangle to the following matrix , namely :

1	1	1	1	1	1	1	1	1
1	2	2	2	2	2	2	2	2
1	2	3	3	3	3	3	3	3
1	2	3	4	4	4	4	4	4
1	2	3	4	5	5	5	5	5
1	2	3	4	5	6	6	6	6
1	2	3	4	5	6	7	7	7
1	2	3	4	5	6	7	8	8
1	2	3	4	5	6	7	8	9

Notes :

- 1) The matrix is a square one (9x9).
- 2) The matrix is symmetric a round the diagonal.
- 3) The detrimant equal 1 , which is a square .
- 4) We can get this matrix by the following two matrices ;

where the rows or column represent the pattern
 1,11,111,1111,...,11111111

$$\begin{pmatrix}
 1 & 0 & 0 & 0 & 0 & 0 & 0 & 0 & 0 \\
 1 & 1 & 0 & 0 & 0 & 0 & 0 & 0 & 0 \\
 1 & 1 & 1 & 0 & 0 & 0 & 0 & 0 & 0 \\
 1 & 1 & 1 & 1 & 0 & 0 & 0 & 0 & 0 \\
 1 & 1 & 1 & 1 & 1 & 0 & 0 & 0 & 0 \\
 1 & 1 & 1 & 1 & 1 & 1 & 0 & 0 & 0 \\
 1 & 1 & 1 & 1 & 1 & 1 & 1 & 0 & 0 \\
 1 & 1 & 1 & 1 & 1 & 1 & 1 & 1 & 0 \\
 1 & 1 & 1 & 1 & 1 & 1 & 1 & 1 & 1
 \end{pmatrix}
 \begin{pmatrix}
 1 & 1 & 1 & 1 & 1 & 1 & 1 & 1 & 1 \\
 0 & 1 & 1 & 1 & 1 & 1 & 1 & 1 & 1 \\
 0 & 0 & 1 & 1 & 1 & 1 & 1 & 1 & 1 \\
 0 & 0 & 0 & 1 & 1 & 1 & 1 & 1 & 1 \\
 0 & 0 & 0 & 0 & 1 & 1 & 1 & 1 & 1 \\
 0 & 0 & 0 & 0 & 0 & 1 & 1 & 1 & 1 \\
 0 & 0 & 0 & 0 & 0 & 0 & 1 & 1 & 1 \\
 0 & 0 & 0 & 0 & 0 & 0 & 0 & 1 & 1 \\
 0 & 0 & 0 & 0 & 0 & 0 & 0 & 0 & 1
 \end{pmatrix}$$

Reference:

[1] Ashbacher. Charles . Pluckings Form the Tree of Smarandache
 Sequences and Functions- chapter 1: <http://www.Ashbacher.com/>

On the 57-th Smarandache's problem *

Liu Huaning and Zhang Wenpeng
Department of Mathematics, Northwest University
Xi'an, Shaanxi, P.R.China

Abstract

For any positive integer n , let r be the positive integer such that: the set $\{1, 2, \dots, r\}$ can be partitioned into n classes such that no class contains integers x, y, z with $xy = z$. In this paper, we use the elementary methods to give a sharp lower bound estimate for r .

§1. Introduction

For any positive integer n , let r be a positive integer such that: the set $\{1, 2, \dots, r\}$ can be partitioned into n classes such that no class contains integers x, y, z with $xy = z$. In [1], Schur asks us to find the maximum r . About this problem, it appears that no one had studied it yet, at least, we have not seen such a paper before. The problem is interesting because it can help us to study some important partition problem. In this paper, we use the elementary methods to study Schur's problem and give a sharp lower bound estimate for r . That is, we shall prove the following:

Theorem *For sufficiently large integer n , let r be a positive integer such that: the set $\{1, 2, \dots, r\}$ can be partitioned into n classes such that no class contains integers x, y, z with $xy = z$. For any number $\varepsilon > 0$, We have*

$$r \geq n^{2(1-\varepsilon)(n-1)}.$$

Whether the upper bound of r is $n^{2(n-1)}$, or there exists another sharper lower bound estimate for r , is an interesting problem.

keywords: Smarandache's problem; Partition; Lower bound.

*This work is supported by the N.S.F.(10271093) and the P.S.F. of P.R.China.

§2. Proof of the Theorem

In this section, we complete the proof of the Theorem.

Let $r = \lfloor n^{2(1-\varepsilon)(n-1)} \rfloor$ and partition the set $\{1, 2, \dots, \lfloor n^{2(1-\varepsilon)(n-1)} \rfloor\}$ into n classes as follows:

$$\begin{aligned}
 \text{Class 1: } & 1, \quad \lfloor n^{(1-\varepsilon)(n-1)} \rfloor, \quad \lfloor n^{(1-\varepsilon)(n-1)} + 1 \rfloor, \quad \dots, \quad \lfloor n^{2(1-\varepsilon)(n-1)} \rfloor. \\
 \text{Class 2: } & 2, \quad n+1, \quad n+2, \quad \dots, \quad \left\lfloor \frac{(n^{(1-\varepsilon)(n-1)} - 1)}{n(n-1)\cdots 3} \right\rfloor. \\
 \text{Class 3: } & 3, \quad \left\lfloor \frac{(n^{(1-\varepsilon)(n-1)} - 1)}{n(n-1)\cdots 3} \right\rfloor + 1, \quad \left\lfloor \frac{(n^{(1-\varepsilon)(n-1)} - 1)}{n(n-1)\cdots 3} \right\rfloor + 2, \quad \dots, \quad \left\lfloor \frac{(n^{(1-\varepsilon)(n-1)} - 1)}{n(n-1)\cdots 4} \right\rfloor. \\
 & \vdots \\
 \text{Class } k: & k, \quad \left\lfloor \frac{(n^{(1-\varepsilon)(n-1)} - 1)}{n(n-1)\cdots k} \right\rfloor + 1, \quad \left\lfloor \frac{(n^{(1-\varepsilon)(n-1)} - 1)}{n(n-1)\cdots k} \right\rfloor + 2, \quad \dots, \quad \left\lfloor \frac{(n^{(1-\varepsilon)(n-1)} - 1)}{n(n-1)\cdots (k+1)} \right\rfloor. \\
 & \vdots \\
 \text{Class } n: & n, \quad \left\lfloor \frac{(n^{(1-\varepsilon)(n-1)} - 1)}{n} \right\rfloor + 1, \quad \left\lfloor \frac{(n^{(1-\varepsilon)(n-1)} - 1)}{n} \right\rfloor + 2, \quad \dots, \quad \lfloor n^{(1-\varepsilon)(n-1)} - 1 \rfloor.
 \end{aligned}$$

where $\lfloor y \rfloor$ denotes the integer part of y .

It is obvious that Class k contains no integers x, y, z with $xy = z$ for $k = 1, 3, 4, \dots, n$. In fact for any integers $x, y, z \in$ Class k , $k = 3, 4, \dots, n$, we have

$$xy \geq k \times \left(\left\lfloor \frac{(n^{(1-\varepsilon)(n-1)} - 1)}{n(n-1)\cdots k} \right\rfloor + 1 \right) > \left\lfloor \frac{(n^{(1-\varepsilon)(n-1)} - 1)}{n(n-1)\cdots (k+1)} \right\rfloor \geq z.$$

On the other hand, $\left\lfloor \frac{(n^{(1-\varepsilon)(n-1)} - 1)}{n(n-1)\cdots 3} \right\rfloor$ tends to zero when $n \rightarrow \infty$, so for sufficiently large integer n , Class 2 has only one integer 2.

This completes the proof of the Theorem.

References

- [1] F. Smarandache, Only problems, not Solutions, Xiquan Publ. House, Chicago, 1993, 48.
- [2] "Smarandache Sequences" at <http://www.gallup.unm.edu/~smarandache/snaqint.txt>.
- [3] "Smarandache Sequences" at <http://www.gallup.unm.edu/~smarandache/snaqint2.txt>.
- [4] "Smarandache Sequences" at <http://www.gallup.unm.edu/~smarandache/snaqint3.txt>.

SOME PROBLEMS CONCERNING THE SMARANDACHE SQUARE COMPLEMENTARY FUNCTION (I)

Maohua Le
Department of Mathematics
Zhanjiang Normal College
29 Cunjin Road, Chikan
Zhanjiang, Guangdong
P.R.China

Abstract: For any positive integer n , let $SSC(n)$ denote the Smarandache square complementary function of n . In this paper we prove that the difference $|SSC(n+1) - SSC(n)|$ is unbounded.

Key words: Smarandache square complementary function; difference; Pell equation

For any positive integer n , let $SSC(n)$ denote the least positive integer m such that mn is a perfect square. Then $SSC(n)$ is called the Smarandache square complementary function (see [1]). In [3], Russo asked if the difference

$$|SSC(n+1) - SSC(n)| \quad (1)$$

Supported by the National Natural Science Foundation of China (No.10271104), the Guangdong Provincial Natural Science Foundation (No.011781) and the Natural Science Foundation of the Education Department of Guangdong Province (No.0161).

is bounded or unbounded? In this paper we solve this problem as follows.

Theorem. The difference is unbounded.

Proof. Let d be a positive integer with square free. By [2, Theorem 10.9.1], there exist two positive integers x and y such that

$$x^2 - dy^2 = 1. \quad (2)$$

Let $n = dy^2$. Then from (2) we get $n+1 = x^2$. By the define of the Smarandache square complementary function, we have

$$SSC(n) = d, SSC(n+1) = 1. \quad (3)$$

Therefore, by (3), we get

$$|SSC(n+1) - SSC(n)| = d - 1. \quad (4)$$

Since there exist infinitely many positive integers d with square free, we see from (4) that the difference (1) is unbounded. Thus, the theorem is proved.

References

- [1] C.Dumitrescu and V. Seleacu, Some notions and questions in number theory, Xiquan Pub. House, Phoenix-Chicago, 1994.
- [2] L.-K. Hua, Introduction to number theory, Springer Verlag, Berlin, 1982.
- [3] F.Russo, An introduction to the Smarandache square complementary function, Smarandache Notions J. 13 (2002), 160-173.

SOME RESULTS CONCERNING THE SMARANDACHE DECONSTRUCTIVE SEQUENCE

Jason Earls
513 N. 3rd Street
Blackwell, OK 74631 USA
Email: jcearls@kskc.net

ABSTRACT

In this note some new primes which were found in the Smarandache Deconstructive Sequence (SDS(n)) are reported, unusual sequences involving SDS(n) are given, along with a list of factorizations for SDS(n). All computations were done with PARI/GP [3], except where noted.

I INTRODUCTION

The Smarandache Deconstructive Sequence, SDS(n) (A007923) [4] is:

1, 23, 456, 7891, 23456, 789123, 4567891, 23456789, 123456789, ...

in which the lengths of the terms increase by 1, and the digits sequentially repeat 1-9. Smarandache first defined this sequence in [5].

II PRIMES IN SDS(n)

In [1] Ashbacher listed eight primes that arise in the Smarandache Deconstructive Sequence:

23, 4567891, 23456789, 1234567891, 23456789123456789,
23456789123456789123, 4567891234567891234567891,
1234567891234567891234567891

The author has found five more.

The values of n for which SDS(n) is prime are:

2, 7, 8, 10, 17, 20, 25, 28, 31, 38, 61, 62, 355,

with no more terms being found for $n \leq 500$.

For example, $SDS(28) = 1234567891234567891234567891$ which is the last prime in Ashbacher's list.

The largest prime the author found, $SDS(355) =$

789123456789123456789123456789123456789123456789123456\

789123456789123456789123456789123456789123456\
 789123456789123456789123456789123456789123456\
 789123456789123456789123456789123456789123456\
 789123456789123456789123456789123456789123456\
 789123456789123456789123456789123456789123456\
 789123456789123456789123456789123456789123456\
 789123456789123456789123456789123456789123456\
 7891234567891234567891234567891234567891

has been proven prime with Primo [2].

III SOME UNUSUAL SEQUENCES INVOLVING SDS(n)

If we sum the squares of the individual digits of SDS(n) we get the following sequence:

(a) 1, 13, 77, 195, 90, 208, 272, 284, 285, 286, 298, 362, 480, 375, 493, 557,

For example, $1^2 = 1$; $2^2 + 3^2 = 13$; $4^2 + 5^2 + 6^2 = 77$;
 $7^2 + 8^2 + 9^2 + 1^2 = 195$, etc.

Are there any squares in sequence (a) above?

Yes. For the following values of n the sum of the squares of the digits of SDS(n) is a square:

1, 100, 280, 346, 568, 721, 1021, 1153, 1657, 2548, 2565,
 2584, 3673, 4537, 4801, 5545, 6004, 6826, 7156,

Is this sequence infinite?

Another question one might ask concerning sequence (a) is, will any primes occur?

For the following values of n the sum of the squares of the digits of SDS(n) is prime:

2, 16, 17, 19, 21, 33, 38, 39, 52, 53, 56, 57, 69, 70, 73, 74,
 75, 88, 91, 93, 105, 106, 110, 125, 128, 141, 142, 145, 147,
 177, 181, 196, 197, 199, 213, 214, 217, 219, 231, 235, 237,
 254, 268, 272, 273, 285, 290, 303, 304, 305, 309, 322, 323, ...

We conjecture that this sequence is infinite.

If we sum the individual digits of SDS(n) after raising the digit to its own power we get the following sequence:

(b) 1, 31, 50037, 405021249, 50068, 405021280, 405071286, 405071316, ...

For example, $1^1 = 1$; $2^2 + 3^3 = 31$; $4^4 + 5^5 + 6^6 = 50037$, etc.

After searching for primes in sequence (b), these values of n such that the sum of the digits of SDS(n) when raised to their own power is prime were found:

2, 21, 32, 33, 69, 92, 93, 94, 107, 123, 140, 163, 164, 248, 269,

272, 291, 307, 326, 345, 364, 377, 392, 393, 433, 434, 448, 453,
454, 485, 487, 502, 519, 538, 573, 580, 626, 627, 685, 718, 755,
757, 809, 865, 866, 878, 917, 955, 973, 986, 988, 1024, 1028, 1048,

We conjecture that this sequence is infinite.

IV FACTORS OF SDS(n)

In closing, we provide a list of factors for the first fifty values of SDS(n).

SDS1:
0
SDS2:
23
SDS3:
2³.3.19
SDS4:
13.607
SDS5:
2⁵.733
SDS6:
3.17.15473
SDS7:
4567891
SDS8:
23456789
SDS9:
3².3607.3803
SDS10:
1234567891
SDS11:
59.397572697
SDS12:
2⁷.3.23.467.110749
SDS13:
37.353.604183031
SDS14:
2⁷.13.23.47.13040359
SDS15:
3.19.13844271171739
SDS16:
739.1231.4621.1086619
SDS17:
23456789123456789
SDS18:
3².7.11.13.19.3607.3803.52579
SDS19:
31.241.1019.162166841159
SDS20:
23456789123456789123
SDS21:
2⁷.3.19.83.67247.11217082711
SDS22:
13.1171.5009.103488876927413
SDS23:

2^7.37139.4934332239074993
SDS24:
3.29.53.19447.5949239.1479230321
SDS25:
4567891234567891234567891
SDS26:
31.120817.6262948234815488507
SDS27:
3^3.757.3607.3803.440334654777631
SDS28:
1234567891234567891234567891
SDS29:
20393.16338731.70399426574704481
SDS30:
2^7.3.43.27664069976791976953536163
SDS31:
7891234567891234567891234567891
SDS32:
2^7.13.67.439.166657.2875758147251799619
SDS33:
3.19.43.191.1685653375348716426865246703
SDS34:
3671.14074661.88408378782858625690561
SDS35:
11083.590819.9973889.119776913.2998604101
SDS36:
3^2.7.11.13.19.101.3607.3803.9901.52579.999999000001
SDS37:
5077076293.243165124963105984043672887
SDS38:
23456789123456789123456789123456789123
SDS39:
2^7.3.19.62608158368529211000108158368529211
SDS40:
13.1794115880987.3016274343701.112170916993561
SDS41:
2^7.3547.19141.1822695439.1480875933915409449259
SDS42:
3.36677.77890601.6953106199727.13242377845224779
SDS43:
17.268699484386346543209875954974581837327523
SDS44:
17.911.98981.9659394263.240869841259.6576837459611
SDS45:
3^2.31.41.271.3607.3803.238681.2906161.4185502830133110721
SDS46:
47.15667.62788723633.26702358442667031058467275423
SDS47:
857.27370815779996253352925074823170115663310139
SDS48:
2^7.3.157089311.7572475819198513188475662796700757119
SDS49:
17.593.138599.31074683.1398187430503.129989759693807375161
SDS50:
2^7.13^2.461.66173.3920187843941.9067410177727179700576871

REFERENCES

- [1] C. Ashbacher, "Some Problems Concerning The Smarandache Deconstructive Sequence",
<http://www.gallup.unm.edu/~smarandache/smardec.htm>
- [2] M. Martin, PRIMO Homepage, <http://www.znz.freesurf.fr/#downloads>
- [3] G. Niklasch, PARI/GP Homepage, <http://www.parigp-home.de/>
- [4] N. J. A. Sloane, On-line Encyclopedia of Integer Sequences,
<http://www.research.att.com/~njas/sequences>
- [5] F. Smarandache, Only Problems, Not Solutions, Xiquan Publishing House, Phoenix, Arizona, 1993.

AN ASYMPTOTIC FORMULA INVOLVING SQUARE COMPLEMENT NUMBERS

LOU YUANBING

Department of Mathematics and Physics, Tibet University
Lhasa, Tibet, P.R.China

ABSTRACT. The main purpose of this paper is to study the mean value properties of the square complement number sequence $\{S(n)\}$, and give an interesting asymptotic formula involving $S(n)$.

1. INTRODUCTION AND RESULTS

For each positive integer n , we call $S(n)$ as a square complement number of n , if $S(n)$ is the smallest positive integer such that $nS(n)$ is a perfect square. In reference [1], Professor F.Smarandache asked us to study the properties of the sequence $\{S(n)\}$. About this problem, we know very little at present. The main purpose of this paper is to study the asymptotic property of this sequence, and obtain an interesting asymptotic formula involving square complement numbers. That is, we shall prove the following result:

Theorem. *Let real number $x \geq 3$, $S(n)$ denotes the square complement number of n . Then we have the asymptotic formula*

$$\sum_{n \leq x} d(S(n)) = c_1 x \ln x + c_2 x + O(x^{\frac{1}{2}+\epsilon}),$$

where $d(n)$ is the divisor function, $\epsilon > 0$ be any fixed real number, c_1 and c_2 are defined as following:

$$c_1 = \frac{6}{\pi^2} \prod_p \left(1 - \frac{1}{(p+1)^2}\right),$$

$$c_2 = \frac{6}{\pi^2} \prod_p \left(1 - \frac{1}{(p+1)^2}\right) \left(\sum_p \frac{2(2p+1) \ln p}{(p-1)(p+1)(p+2)} + 2\gamma - 1\right),$$

the product and summation over all prime p , γ is the Euler's constant.

Key words and phrases. Square complement numbers; Sequence; Asymptotic formula.

2. PROOF OF THE THEOREM

In this section, we shall complete the proof of the Theorem. First we need the following:

Lemma. *Let real number $y \geq 3$, then we have the asymptotic formula*

$$\sum_{n \leq y} d(n) |\mu(n)| = c'_1 y \ln y + c'_2 y + O(y^{\frac{1}{2} + \epsilon}),$$

where $\mu(n)$ is the Möbius function, c'_1 and c'_2 are defined as following:

$$c'_1 = \frac{36}{\pi^4} \prod_p \left(1 - \frac{1}{(p+1)^2} \right),$$

$$c'_2 = \frac{36}{\pi^4} \prod_p \left(1 - \frac{1}{(p+1)^2} \right) \left(\sum_p \frac{2 \ln p}{(p+1)(p+2)} + \sum_p \frac{4 \ln p}{p^2 - 1} + 2\gamma - 1 \right)$$

Proof. Let $T = \sqrt{y}$, $A(s) = \prod_p \left(1 - \frac{1}{(p^s + 1)^2} \right)$. Then from the Perron formula (See Theorem 2 of reference [2]), we can obtain

$$\sum_{n \leq y} d(n) |\mu(n)| = \frac{1}{2\pi i} \int_{1+\epsilon-iT}^{1+\epsilon+iT} \frac{\zeta^2(s)}{\zeta^2(2s)} A(s) \frac{y^s}{s} ds + O(y^{\frac{1}{2} + \epsilon}),$$

where $\mu(n)$ is the Möbius function, $\epsilon > 0$ be any real number.

Moving the integration line to $\text{Re}(s) = \frac{1}{2} + \epsilon$, here $s = 1$ is a second order pole of $\frac{\zeta^2(s)}{\zeta^2(2s)} A(s) \frac{y^s}{s}$, and the residue of this function at $s = 1$ is

$$\text{Res}_{s=1} \left(\frac{\zeta^2(s)}{\zeta^2(2s)} A(s) \frac{y^s}{s} \right) = c'_1 y \ln y + c'_2 y.$$

where c'_1 and c'_2 are defined as following:

$$c'_1 = \frac{36}{\pi^4} \prod_p \left(1 - \frac{1}{(p+1)^2} \right),$$

$$c'_2 = \frac{36}{\pi^4} \prod_p \left(1 - \frac{1}{(p+1)^2} \right) \left(\sum_p \frac{2 \ln p}{(p+1)(p+2)} + \sum_p \frac{4 \ln p}{p^2 - 1} + 2\gamma - 1 \right).$$

Hence,

$$\sum_{n \leq y} d(n) |\mu(n)| = c'_1 y \ln y + c'_2 y + O(y^{\frac{1}{2} + \epsilon})$$

This proves the Lemma.

Now, we shall complete the proof of the Theorem. From the above Lemma we have

$$\begin{aligned}
 \sum_{n \leq x} d(S(n)) &= \sum_{ak^2 \leq x} d(S(ak^2)) \\
 &= \sum_{ak^2 \leq x} d(a)|\mu(a)| \\
 &= \sum_{k \leq \sqrt{x}} \sum_{a \leq \frac{x}{k^2}} d(a)|\mu(a)| \\
 &= \sum_{k \leq \sqrt{x}} \left(c'_1 \frac{x}{k^2} \ln \frac{x}{k^2} + c'_2 \frac{x}{k^2} + O\left(\frac{x^{\frac{1}{2}+\epsilon}}{k^{1+2\epsilon}}\right) \right) \\
 (1) \qquad &= c'_1 \zeta(2)x \ln x + (c'_2 \zeta(2) + 2c'_1 \zeta'(2))x + O\left(x^{\frac{1}{2}+\epsilon}\right).
 \end{aligned}$$

Let

$$(2) \qquad c_1 = c'_1 \zeta(2) = \frac{6}{\pi^2} \prod_p \left(1 - \frac{1}{(p+1)^2}\right),$$

and

$$\begin{aligned}
 c_2 &= c'_2 \zeta(2) + 2c'_1 \zeta'(2) = c'_2 \zeta(2) - 2c'_1 \zeta(2) \sum_p \frac{\ln p}{p^2 - 1} \\
 (3) \qquad &= \frac{6}{\pi^2} \prod_p \left(1 - \frac{1}{(p+1)^2}\right) \left(\sum_p \frac{2(2p+1) \ln p}{(p-1)(p+1)(p+2)} + 2\gamma - 1\right).
 \end{aligned}$$

Combining (1), (2) and (3), we immediately deduce the asymptotic formula

$$\sum_{n \leq x} d(S(n)) = c_1 x \ln x + c_2 x + O(x^{\frac{1}{2}+\epsilon}),$$

This completes the proof of the Theorem.

3. ACKNOWLEDGEMENTS

The author expresses his gratitude to Professor Zhang Wenpeng for his careful instruction.

REFERENCES

1. F. Smarandache, *Only problems, not solutions*, Xiquan Publishing House, New York, 1993.
2. Pan Chengdong and Pan Chengbiao, *Elements of the analytic number theory*, Science Press, Beijing, 1991.
3. Apostol, Tom M., *Introduction to Analytic Number Theory*, Springer-Verlag, New York, 1976.

On a problem concerning the Smarandache Left-Righth sequences

Felice Russo

Via A. Infante 7

67051 Avezzano (Aq) Italy

felice.russo@katamail.com

Abstract

In this paper a problem posed in [1] and concerning the number of primes in the Smarandache Left-Right Natural number sequence (SLRNN) and in the Smarandache Left-Right prime (SLRP) sequence is analysed.

Introduction

In [1] the author defined the SLRNN and SLRP sequences in the following way:

SLRNN - Starting with 1 append alternatively on the left and on the right the next natural numbers:

1, 21, 213, 4213, 42135, 642135, 6421357, 86421357, 864213579, 86421357910,

SLRP - Starting with the first prime 2 append alternatively on the left and on the right the next primes:

2, 32, 325, 7325, 732511, 13732511, 1373251117, 191373251117, 19137325111723,

In the section dedicated to those two sequences the following open question is reported:

How many terms are prime numbers?

Moreover by defining as additive primes those prime numbers which sum of digits is prime too, this second question is also reported:

How many terms are additive prime?

Results

In the table 3 and 4 the first 40 terms for the SLRP and SLRNN sequences respectively are reported.

By looking at the tables 5 and 6 regarding the prime factors of the first 25 terms of both the sequences, we can see clearly that for the SLRNN sequence a clear pattern emerges. In fact all the terms $a(n)$ with $n=3\cdot k+2$ and $n=3\cdot k+3$ (where $k=0,1,2,3,\dots$) are divisible by 3 while those with $n=10\cdot k+5$ and $n=10\cdot k+6$ are divisible by 5.

On the contrary for the SLRP sequence any pattern is visible.

According to those considerations and thanks to an Ubasic code the first 575 and 717 terms of the SLRP and SLRNN sequence respectively have been tested for primality.

The last term tested for both the sequences has 2103 and 2043 digits respectively.

Here a summary table for both the sequences.

Start/end prime	# digits	Prime
2	1	2
19/17	12	191373251117
37/31	20	37291913732511172331
139/149	76	1391311131071018979716153433729191373251117233141475967738397103109127137149
311/307	163	311293281271263251239229223199193181173.....161197211227233241257269277283307

Table 1. Prime in the SLRP sequence

Start/end numb.	# digits	Prime
120/121	255	120118116114112110108106104102100.....101103105107109111113115117119121

Table 2. Primes in the SLRNN sequence

According to those results the percentage of the primes inside the two sequences is 0.87% and 0.14% for the SLRP and SLRNN respectively.

Actually the percentage is so low that this seems to point out that the number of primes is finite.

Open question: Is the number of primes in the SLRP and SLRNN finite?

Let's now check if those primes are also additive. For the primes of the sequence SLRP we have that 4 out of 5 are additive being the sum of digits equal to 2, 41, 71 and 631. The only prime that is not additive is that starting with 139 and ending with 149 which sum of digits is 296 that is composite. About the SLRNN sequence the only prime found is not additive because the sum of the digits is equal to 1027 that is a composite number.

According to those results the following two conjectures can be posed:

Conjecture 1: The number of additive primes inside the sequence SLRP is finite

Conjecture 2: The number of additive primes inside the sequence SLRNN is null.

1	2
2	32
3	325
4	7325
5	732511
6	13732511
7	1373251117
8	191373251117
9	19137325111723
10	2919137325111723
11	291913732511172331
12	37291913732511172331
13	3729191373251117233141
14	433729191373251117233141
15	43372919137325111723314147
16	5343372919137325111723314147
17	534337291913732511172331414759
18	61534337291913732511172331414759
19	6153433729191373251117233141475967
20	716153433729191373251117233141475967
21	71615343372919137325111723314147596773
22	7971615343372919137325111723314147596773
23	797161534337291913732511172331414759677383
24	89797161534337291913732511172331414759677383
25	8979716153433729191373251117233141475967738397
26	1018979716153433729191373251117233141475967738397
27	1018979716153433729191373251117233141475967738397103
28	1071018979716153433729191373251117233141475967738397103
29	1071018979716153433729191373251117233141475967738397103109
30	1131071018979716153433729191373251117233141475967738397103109
31	1131071018979716153433729191373251117233141475967738397103109127
32	1311131071018979716153433729191373251117233141475967738397103109127
33	1311131071018979716153433729191373251117233141475967738397103109127137
34	1391311131071018979716153433729191373251117233141475967738397103109127137
35	1391311131071018979716153433729191373251117233141475967738397103109127137149
36	1511391311131071018979716153433729191373251117233141475967738397103109127137149
37	1511391311131071018979716153433729191373251117233141475967738397103109127137149157
38	1631511391311131071018979716153433729191373251117233141475967738397103109127137149157
39	1631511391311131071018979716153433729191373251117233141475967738397103109127137149157167
40	1731631511391311131071018979716153433729191373251117233141475967738397103109127137149157167

Table 3. First 40 terms of sequence SLRP

1	1
2	21
3	213
4	4213
5	42135
6	642135
7	6421357
8	86421357
9	864213579
10	10864213579
11	1086421357911
12	121086421357911
13	12108642135791113
14	1412108642135791113
15	141210864213579111315
16	16141210864213579111315
17	1614121086421357911131517
18	181614121086421357911131517
19	18161412108642135791113151719
20	2018161412108642135791113151719
21	201816141210864213579111315171921
22	22201816141210864213579111315171921
23	2220181614121086421357911131517192123
24	242220181614121086421357911131517192123
25	24222018161412108642135791113151719212325
26	2624222018161412108642135791113151719212325
27	262422201816141210864213579111315171921232527
28	28262422201816141210864213579111315171921232527
29	2826242220181614121086421357911131517192123252729
30	302826242220181614121086421357911131517192123252729
31	30282624222018161412108642135791113151719212325272931
32	3230282624222018161412108642135791113151719212325272931
33	323028262422201816141210864213579111315171921232527293133
34	34323028262422201816141210864213579111315171921232527293133
35	3432302826242220181614121086421357911131517192123252729313335
36	363432302826242220181614121086421357911131517192123252729313335
37	36343230282624222018161412108642135791113151719212325272931333537
38	3836343230282624222018161412108642135791113151719212325272931333537
39	383634323028262422201816141210864213579111315171921232527293133353739
40	40383634323028262422201816141210864213579111315171921232527293133353739

Table 4. First 40 terms of sequence SLRNN

1	Prime
2	2x2x2x2x2
3	5x5x13
4	5x5x293
5	13x29x29x67
6	13x1056347
7	7x7x28025533
8	Prime
9	7x13x 210300275953
10	3x 973045775037241
11	7x6763xC
12	Prime
13	11x38393xC
14	7xC
15	137xC
16	3x11x157x2179xC
17	4519xC
18	3x239x593x144725040140349010212526739
19	11x5197xC
20	3x3x3x83x89xC
21	43x53x113xC
22	???
23	127x3343x42841xC
24	3x3x3x7x7x7xC
25	19xC

Table 5. Prime factors for the sequence SLRP (here C indicates a composite number)

1	1
2	3x7
3	3x71
4	11x383
5	3x5x53x53
6	3x5x13x37x89
7	79x81283
8	3x3x3x11x43x67x101
9	3x3x96023731
10	17x41x113x271x509
11	3x19x37x53x419x23197
12	3x10477x12433x309857
13	11x29x179x2683x79037111
14	3x107xC
15	3x5x7x13x103451182574050631
16	5xC
17	3x3x3x3x3x3xC
18	3x3xC
19	17x1068318359331890340653714807
20	3x 672720470702880711930371050573
21	3xC
22	281x54601xC
23	3x13x35381xC
24	3x35153x2296818494525086397759867921481497
25	5x5x17x37x127x593xC

Table 6. Prime factors for the sequence SLRNN (here C indicates a composite number)

References

- [1] Felice Russo, A set of New Smarandache functions, sequences and conjectures, American Research press, 2000, pag. 68-69

Some Properties of The Happy Numbers and the Smarandache H-Sequence

Charles Ashbacher
Charles Ashbacher Technologies
Box 294
Hiawatha, IA 52233

Abstract:

The happy numbers are those where the iterated sums of the squares of the digits terminates at 1. A Smarandache Concatenate Sequence is a set of numbers formed by the repeated concatenation of the elements of another set of numbers. In this paper, we examine some of the properties of the happy numbers as well as a concatenation sequence constructed from the happy numbers.

Introduction:

Definition: Given any positive integer n , the repeated iteration of the sum of the squares of the decimal digits either terminates at 1 or enters the cycle

$$4 \rightarrow 16 \rightarrow 37 \rightarrow 58 \rightarrow 89 \rightarrow 145 \rightarrow 42 \rightarrow 20 \rightarrow 4.$$

If the iteration terminates at 1, the number is said to be Happy[1].

For example, 13 is Happy, as

$$1 + 9 = 10 = 1 + 0 = 1,$$

the Happy numbers less than or equal to 100 are { 1, 7, 10, 13, 19, 23, 28, 31, 32, 44, 49, 68, 70, 79, 82, 86, 91, 94, 97, 100 }. If a number is Happy, then the number formed by appending an arbitrary number of zeros to the right is also Happy. Therefore, the set of Happy numbers is infinite.

Happy numbers turn out to be rather common, and Guy[1] notes that about 1/7 of the positive integers appear to be Happy.

To examine this in more detail, a computer program was created to determine and count the number of Happy numbers up through an upper limit. The counts and percentages for upper limits of one million through ten million were computed and are summarized in table 1.

Table 1

Percentage of Happy Numbers

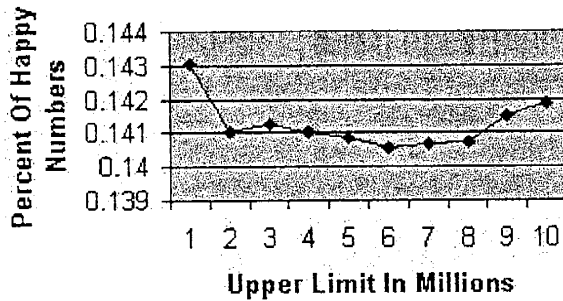

From this figure, it is clear that the percentage of Happy numbers is near $1/7 = 0.142$, but shows a small amount of variation.

In his paper, Gupta[2] describes the Smarandache H-Sequence[2], constructed by repeatedly appending Happy numbers on the right side. For example, the first five elements of the sequence are

- SH(1) = 1
- SH(2) = 17
- SH(3) = 1710
- SH(4) = 171013
- SH(5) = 17101319.

Gupta also defines the Reversed Smarandache H-Sequence, which is constructed by appending the happy numbers to the left side. For example, the first five elements of the sequence are

- RSH(1) = 1
- RSH(2) = 71
- RSH(3) = 1071
- RSH(4) = 131071
- RSH(5) = 19131071.

Primes in the SH and RSH sequences.

Gupta conducts a search for primes in both the SH and RSH sequences. Three primes were found in the first 1000 terms of the SH sequence and they are SH(2), SH(5) and SH(43). Eight primes were found in the first 1000 terms of the RSH sequence and they are RSH(2), RSH(4), RSH(5), RSH(6), RSH(10), RSH(31), RSH(255) and RSH(368). This is hardly surprising, as happy numbers can end with any of the decimal digits, six of which { 0, 2, 4, 5, 6, 8 } immediately eliminate the SH sequence element as a possible prime. However, with the trailing digit always being 1 for elements in the RSH sequence, there is no immediate elimination of the number as a possible prime. Assuming that all digits are equally likely to be the trailing digit of a happy number, then with six out of ten immediately eliminating the possibility of it being prime, the ratio of three to eight seems quite reasonable.

The trailing digits of the set of Happy numbers.

Which brings us to a related question.

Are the trailing digits of the set of Happy numbers equally dispersed among the ten decimal digits?

At first glance, the answer to this question would appear to be false. Since zeros can be appended to any

Happy number to generate another Happy number, it would appear that the percentage of trailing zeros in Happy numbers would be greater than the average of 0.1.

A program was written in the language Java to test this question. The long data type in Java occupies eight bytes of memory and can store positive integers up to 9223372036854775807. Therefore, it is used in the computation of the Happy numbers. As the Happy numbers are generated, the trailing digit is extracted and the count of the number of times each digit appears is stored. These numbers are then displayed when the program terminates. The program was run several times, computing all Happy numbers less than n , where n was incremented in steps of one million. For each run, the percentage of the Happy numbers less than the upper bound that have a trailing zero was computed. The results for runs with upper limits from 1 million through 10 million are summarized in figure 2.

Figure 2

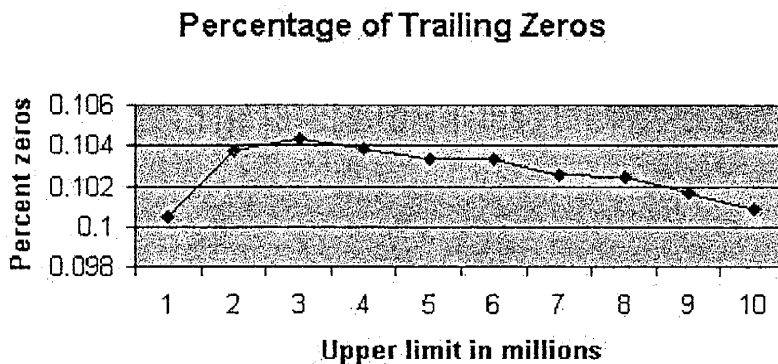

Note that the percentage of Happy numbers that end in zero is greater than 0.10, but the graph exhibits a decreasing rate as the upper limit increases.

This leads to the unsolved question.

Is the percentage of Happy numbers that end with a zero greater than 0.10?

The evidence here suggests that it is in fact near 0.10.

Similar questions can be asked concerning the percentages of Happy numbers that terminate with each of the remaining nine digits. Figure 3 is a chart of the percentage of Happy numbers that end in a one as the upper limit steps from one through ten million.

Figure 3

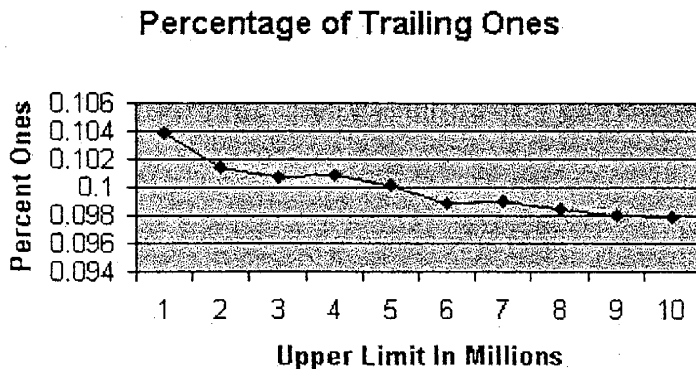

Figure 4 is a chart of the percentage of Happy numbers that end in a two as the upper limit step from one million through ten million.

Figure 4

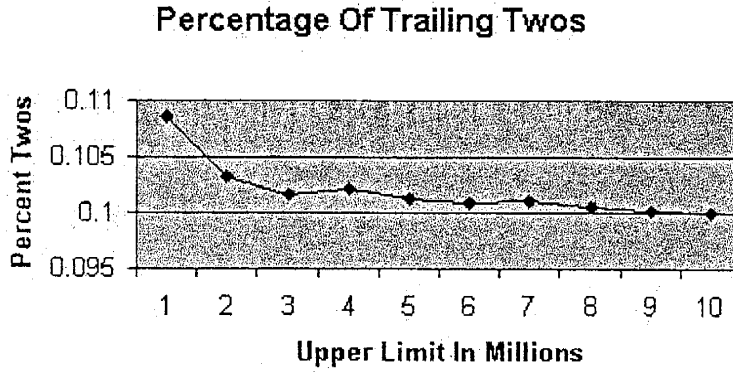

Figure 5 is a chart of the percentage of Happy numbers that in a three as the upper limits step from one million through ten million.

Figure 5

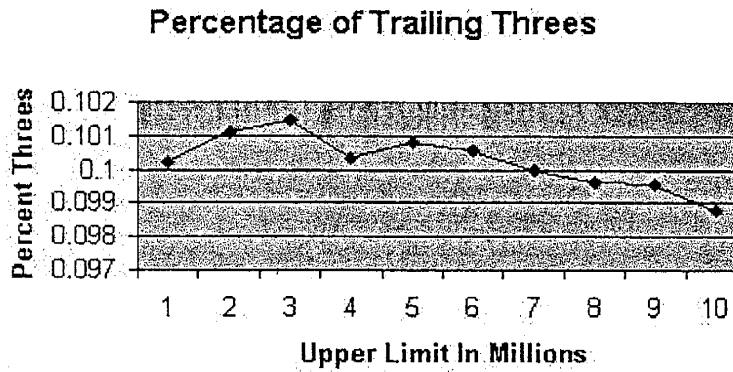

Figure 6 is a chart of the percentage of Happy numbers that end in a four as the upper limits step from one million through ten million.

Figure 6

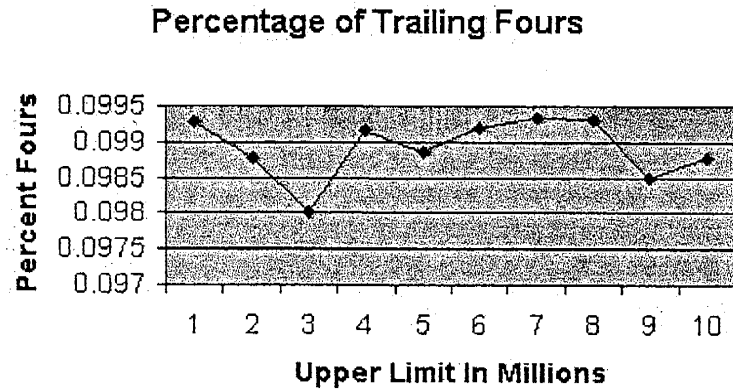

Figure 7 is a chart of the percentage of Happy numbers that end in a five as the upper limits step from one million through ten million.

Figure 7

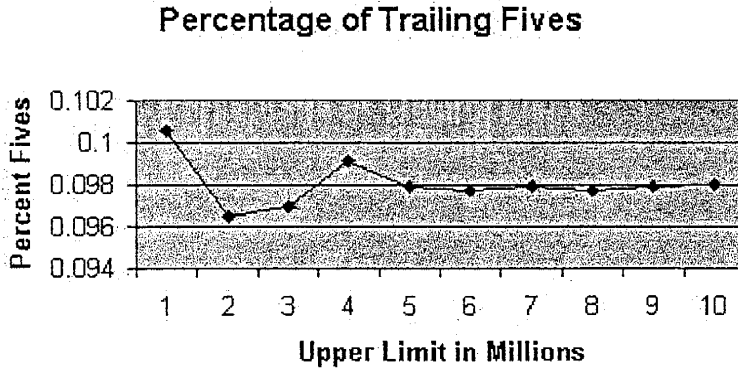

Figure 8 is a chart of the percentage of Happy numbers that end in a six as the upper limits step from one million through ten million.

Figure 8

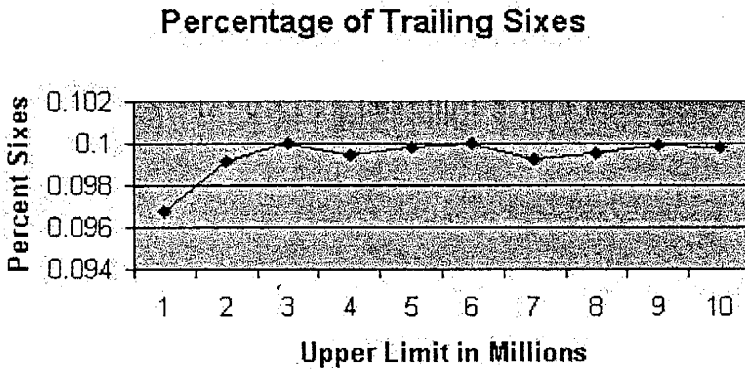

Figure 9 is a chart of the percentage of Happy numbers that end in a seven as the upper limits step from one million through ten million.

Figure 9

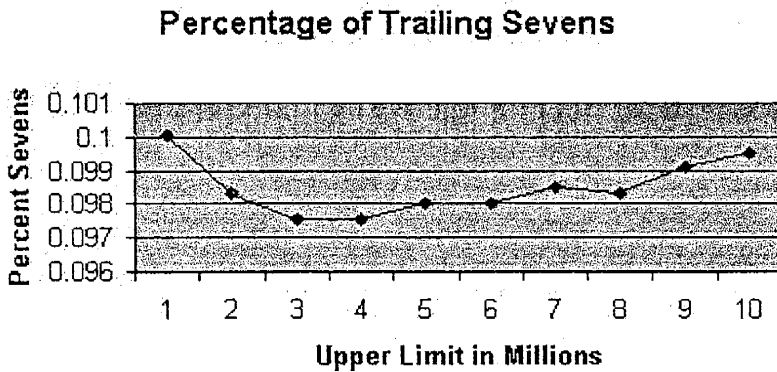

Figure 10 is a chart of the percentage of Happy numbers that end in an eight as the upper limits step from one million through ten million.

Figure 10

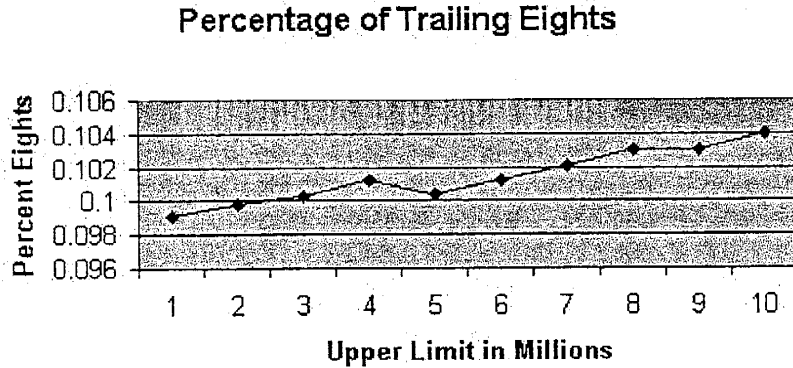
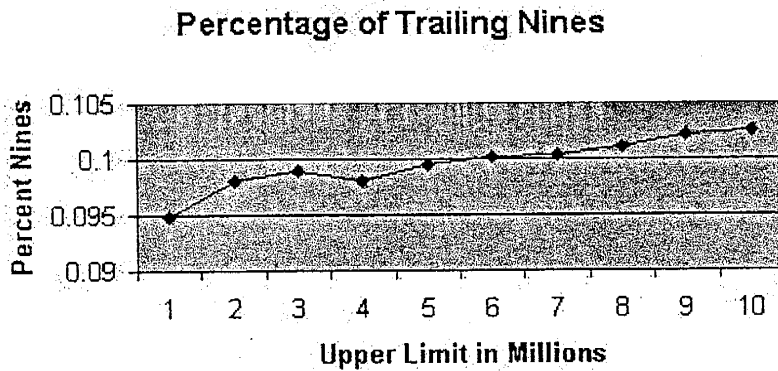

Figure 11 is a chart of the percentage of Happy numbers that end in a nine as the upper limits step from one million through ten million.

Figure 11



From these figures, it is clear that the percentages of the trailing digits of Happy numbers are generally evenly distributed for the ranges examined.

The Smarandache H-Sequence One-Seventh Conjecture

Gupta also makes the following conjecture in his paper about numbers in the Smarandache H-sequence.

Conjecture:

About one-seventh of the numbers in the Smarandache H-sequence belong to the initial H-sequence.

A computer program that uses the BigInteger class in Java was written to test this conjecture. The BigInteger class allows for the manipulation of very large integers whose only limit is the amount of machine memory. The program was run for all Happy numbers up through 15,000 and these numbers were used to construct the corresponding SH numbers. Percentages of the elements in the SH sequence that are also in the H-sequence were computed for each 1000 SH numbers and the results are summarized in figure 12.

Figure 12

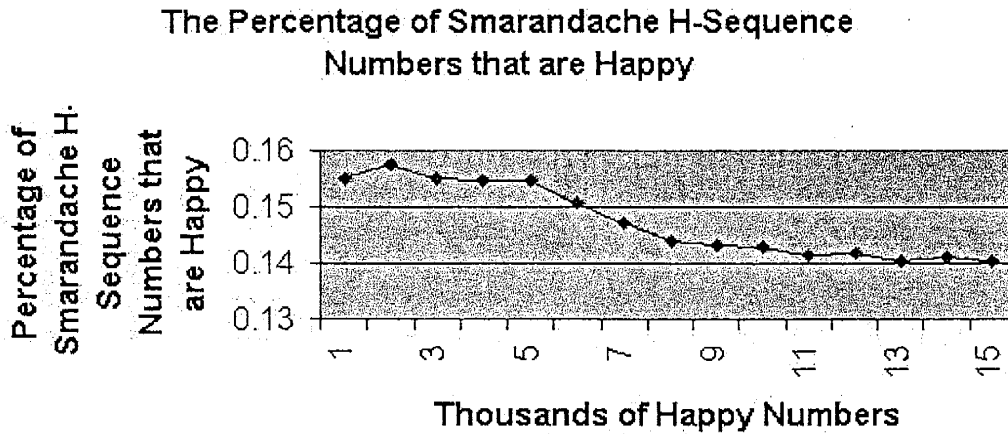

As you can see, the percentage of Smarandache H-sequence numbers that are also Happy appears to asymptotically approach 0.14. This is slightly less than the one-seventh value stated by Gupta.

Contrasting figure 12 with figure 1, it is clear that the percentage of Smarandache H-sequence numbers that are also Happy has less variation and appears to be smaller than the percentage of numbers that are Happy.

Question:

Is the percentage of Smarandache H-sequence numbers that are Happy less than the percentage of integers that are Happy?

Consecutive SH Numbers

Gupta also mentions consecutive SH numbers that are also Happy and finds the smallest such pair: SH(30) and SH(31). He moves on to find examples where three, four and five consecutive SH numbers are also Happy. He closes that section with the question:

Can you find examples of six and seven consecutive SH numbers?

The program previously mentioned that computed the percentages of H-sequence numbers that are also happy also searched for examples of six or seven consecutive Happy numbers and found no such sequences for the values of SH(10000) through SH(15000).

References:

- [1] Guy, R. K., **Unsolved Problems in Number Theory**, E34, Springer-Verlag, 2nd Ed., 1994.
- [2] Gupta, S. S. "Smarandache Sequence of Happy Numbers", online article at <http://www.gallup.unm.edu/~smarandache/Gupta.htm>.

SOME SMARANDACHE-TYPE SEQUENCES AND PROBLEMS CONCERNING ABUNDANT AND DEFICIENT NUMBERS

Jason Earls
513 N. 3rd Street
Blackwell, OK 74631 USA

Abstract: We define some new sequences involving Smarandache operations on the sets of deficient and abundant numbers. We give conjectures and ask questions about these sequences somewhat similar to certain problems posed in Smarandache's book *Only Problems, Not Solutions!* [7].

1. INTRODUCTION

A number n is called abundant if $\sigma(n) > 2n$ (A005101), perfect if $\sigma(n) = 2n$ (A000396), and deficient if $\sigma(n) < 2n$ (A005100), where $\sigma(n)$ denotes the sum of all positive divisors of n (A000203) [6]. Concerning perfect numbers, it is not known when they were first studied, however, the first mathematical result about them occurs in Euclid's *Elements* written around 300 BC. More relevant to this paper is the text *Introductio Arithmetica*, written by Nicomachus around 100 AD, in which Nicomachus first classified all numbers based on the concept of perfect numbers, thus giving us the definitions (listed above) of abundant and deficient numbers, with which this paper deals [4].

Concerning abundant numbers, two of the more interesting facts about them is that in 1964 T. R. Parkin and L. J. Lander showed that all numbers greater than 20161 can be expressed as the sum of two abundant numbers [2]; and around 1000 AD, Abu Mansur ibn Tahir Al-Baghadadi found the first smallest odd abundant number: 945 [5].

Perfect numbers have attracted more interest through the years than abundant and deficient numbers, no doubt due to the fact that they are intimately connected with Mersenne primes. But despite all of the extensive study of perfect numbers, there are still crucial unsolved problems. For example: Are there infinitely many perfect numbers? Does an odd perfect number exist? No one knows. But no matter how much more attractive the perfect numbers may seem when compared with the abundant and deficient numbers, in this paper we leave the perfect ones alone and devote our energy only to the abundants and deficient numbers.

What we offer in this paper are some Smarandache-type sequences and problems with the questions asked being very much in the spirit of Florentin Smarandache's wonderful book *Only Problems, Not Solutions!* [7]. Also it should be mentioned that in constructing

and exploring the problems below we made extensive use of the software package PARI/GP [3]; and that all of the conjectures made were based on a small amount of analysis and a lot of empirical evidence via a personal computer. And now we close this introduction with a quote from Sir Winston Churchill (1874-1965):

“I had a feeling once about Mathematics - that I saw it all. Depth beyond depth was revealed to me - the Byss and Abyss. I saw - as one might see the transit of Venus or even the Lord Mayor's Show - a quantity passing through infinity and changing its sign from plus to minus. I saw exactly why it happened and why the tergiversation was inevitable, but it was after dinner and I let it go” [1].

2. SEQUENCES AND PROBLEMS

- (1) Smarandache Consecutive Abundant sequence (SCA); concatenate the first n abundant numbers.

12, 1218, 121820, 12182024, 1218202430, 121820243036, 12182024303640, 1218202430364042, 121820243036404248, 12182024303640424854,...

Will there always be at least one prime factor of any SCA number that has never before appeared as a prime factor in any earlier SCA number? That is, if $SCA = p_1^{a_1} p_2^{a_2} \dots p_n^{a_n}$, is there always a p_i in any SCA number distinct from all previous SCA numbers? We conjecture: yes.

- (2) Smarandache Consecutive Deficient sequence (SCD); concatenate the first n deficient numbers.

1, 12, 123, 1234, 12345, 123457, 1234578, 12345789, 1234578910, 123457891011, 12345789101113, 1234578910111314, 123457891011131415,...

How many primes are among these numbers? Will there always be at least one prime factor of any SCD number > 1 that has never before appeared as a prime factor in any earlier SCD number? We conjecture: yes.

- (3) Smarandache Abundant-Deficient consecutive sequence; a_d where a is the nth abundant number and d is the nth deficient number, with " _ " representing concatenation.

121, 182, 203, 244, 305, 367, 408, 429, 4810, 5411, 5613, 6014, 6615, 7016, 7217, 7819, 8021, 8422, 8823, 9025, 9626, 10027, 10229, 10431, 10832, 11233, 11434, 12035, 12637, 13238,...

How many primes are there among these numbers? How many squares?

- (4) Smarandache Odd Abundant-Deficient consecutive sequence; oa_od where oa is the n th odd abundant number and od is the n th odd deficient number, with " _ " representing concatenation.

9451,15753,22055,28357,34659,409511,472513,535515,577517,
598519,643521,661523,682525,724527,742529,787531,808533,...

We conjecture that there are an infinite amount of primes among these numbers.
How many of these numbers are triangular?

- (5) Deficient numbers such that the sum of their individual digits after being raised to their own power, become abundant numbers.*

15,26,33,39,50,51,57,62,68,69,75,79,82,86,93,97,99,
118,127,141,147,165,167,172,178,181,187,207,217,235,
239,242,244,248,253,257,259,271,275,277,284,293,295,...

E.g. 147 is a deficient number and $1^1 + 4^4 + 7^7 = 823800$ is an abundant number.

Are there infinitely many consecutive terms in this sequence? We conjecture: yes.
Are there infinitely many k -tuples for these numbers?

*We remark here that with modern software freely available on the Internet, such as PARI/GP [3], it is easy to find large values of this sequence when searching a small neighborhood. For example, it took only a few seconds to find:
12345678901234567890123456793, which is a number with the property stated above.

- (6) Abundant numbers such that the sum of their individual digits after being raised to their own power, is also an abundant number.

24,42,66,96,104,108,114,140,156,174,176,180,222,224,228,
270,282,288,336,352,354,392,396,400,444,448,464,516,532,
534,560,572,576,594,644,650,666,702,704,708,714,720,740,...

E.g. 24 is an abundant number and $2^2 + 4^4 = 260$ is also abundant.

Are there infinitely many consecutive numbers in this sequence?
What is the asymptotic estimate for the number of integers less than 10^m that have the property stated above?

- (7) Abundant numbers such that the sum of the factorials of their individual digits is an abundant number.

36,48,54,56,66,78,84,88,96,336,348,354,364,366,368,378,
384,396,438,444,448,456,464,468,474,476,486,498,534,544,
546,558,564,576,588,594,636,644,648,654,666,678,...

E.g. 36 is an abundant number and $3!+6!=726$ is abundant.

Are there an infinite amount of odd numbers in this sequence? We conjecture: yes.
Are there an infinite amount of consecutive terms in this sequence? We conjecture:
yes.

- (8) Abundant-Smarandache numbers; n such that $S(n)$ is an abundant number, where $S(n)$ is the classic Smarandache function (A002034) [6].

243,486,512,625,972,1024,1215,1250,1536,1701,1875,1944,...

What is the 1000th term of this sequence?
Investigate this sequence.

- (9) Abundant-Pseudo Smarandache numbers; n such that $Z(n)$ is an abundant number, where $Z(n)$ is the Pseudo-Smarandache function (A011772) [6].

13,19,25,26,31,37,39,41,42,43,49,50,56,57,61,67,70,71,
73,74,75,76,78,79,81,82,84,89,93,97,98,100,101,103,108,
109,111,113,114,121,122,127,129,133,135,139,146,147,...

Investigate these numbers.

- (10) Smarandache Abundant-Partial-Digital Subsequence; the sequence of abundant numbers which can be partitioned so that each element of the partition is an abundant number. E.g. 361260 is an abundant number and it can be partitioned into 36_12_60 with 36, 12 and 60 all being abundant.

Find this sequence.

- (11) Abundant numbers A such that when the smallest prime factor of A is added to the largest prime factor of A , it is also an abundant number.

5355,8415,8925,11655,13218,16065,16695,16998,19635,20778,
21105,23205,24558,25245,26436,26775,28338,29835,30555,
31815,33996,34965,37485,39654,40938,41556,42075,42735,...

E.g. the smallest prime factor of 5355 is 3 and the largest is 17; $17+3=20$, an abundant number.

What are some properties of these numbers?

What are the first ten abundant numbers A , such that $A \equiv 7 \pmod{10}$?

- (12) Abundant numbers A such that the sum of the composites between the smallest and largest prime factors of A is also an abundant number.

114,228,304,342,380,438,456,474,532,570,608,684,760,798,822,834,836,
876,894,906,912,948,1026,1064,1140,1182,1194,1216,1254,1314,1330,1368,
1398,1422,1460,1482,1520,1542,1580,1596,1644,1668,1672,1710,1752,1788,...

E.g. the smallest prime factor of 114 is 2 and the largest is 19. The sum of the composites between 2 and 19 is: $4+6+8+9+10+12+14+15+16+18 = 112$, an abundant number.

What are some properties of these numbers? Are there any consecutive numbers in this sequence?

- (13) Smarandache Nobly Abundant numbers; n such that $\tau(n)$ and $\sigma(n)$ are both abundant numbers, where $\tau(n)$ is the number of divisors of n and $\sigma(n)$ is the sum of the divisors of n .

60,84,90,96,108,126,132,140,150,156,160,180,198,204,220,224,228,234,240,252,
260, 276,294,300,306,308,315,336,340,342,348,350,352,360,364,372,380,396,414,
416,420,432,444,460,476,480,486,490,492,495,500,504,516,522,525,528,532,...

E.g. the number of divisors of 60 is 12 and the sum of the divisors of 60 is 312, both abundant numbers.

What are some properties of these numbers?

- (14) Smarandache Nobly Deficient numbers; n such that $\tau(n)$ and $\sigma(n)$ are both deficient numbers, where $\tau(n)$ is the number of divisors of n and $\sigma(n)$ is the sum of the divisors of n .

1,2,3,4,7,8,9,13,16,21,25,31,36,37,43,48,49,61,64,67,73,81,93,97,100,109,

111,112,121,127,128,144,151,157,162,163,169,181,183,192,193,196,208,211,
217,219,225,229,241,256,277,283,289,313,324,331,337,361,373,381,397,400,...

Investigate this sequence.

- (15) Smarandache Consecutive Abundant Digital Sum Deficient numbers; consecutive abundant numbers such that their digital sums are deficient numbers.

5984,5985
7424,7425
11024,11025
26144,26145
27404,27405
39375,39376
43064,43065
49664,49665
56924,56925
58695,58696
...

E.g. 5984 and 5985 are consecutive abundant numbers and their digital sums $5+9+8+4 = 26$ and $5+9+8+5 = 27$, are both deficient numbers.

Is this sequence infinite? We conjecture: yes.

- (16) Smarandache Powerfully Abundant numbers. Let the abundance of n be denoted $\omega(n) = \sigma(n) - 2n$, where $\sigma(n)$ is the sum of all positive divisors of n ; then the sequence is the least number m such that the abundance of m is equal to -10^n .

11,101,5090,40028,182525,2000006,

Is this sequence infinite?* What is the 100th term?

*If n is given, then it seems likely that there is some integer $r \geq 1$ such that $p = 2^r + 10^n - 1$ is prime. If it is, then $\omega(2^{r-1} * p) = -10^n$ [8].

- (17) Let the deficiency of n be denoted $\alpha(n) = 2n - \sigma(n)$. Below is the sequence of n such that $\alpha(n) = \tau(n)$, where $\tau(n)$ is the number of divisors of n .

1,3,14,52,130,184,656,8648,12008,34688, 2118656,...

Is this sequence infinite? Investigate this sequence.

- (18) Let the deficiency of n be denoted $\alpha(n) = 2n - \sigma(n)$. Below is the sequence of n such that $\alpha(n)$ is a perfect square* and sets a new record for such squares.

1,5,17,37,101,197,257,401,577,677,1297,1601,2597,2917,3137,4357,5477,
7057,8101,8837,12101,13457,14401,15377,15877,16901,17957,21317,22501,
24337,25601,28901,30977,32401,33857,41617,42437,44101,50177,52901,55697,...

E.g. $\alpha(37)=36$ a square which sets a new record for squares. $\alpha(101)=100$ a square which sets a new record for squares.

2597 is the only non-prime value >1 in the sequence above. What is the next non-prime value? Investigate this sequence.

*Kravitz conjectured that no numbers exist whose abundance is an odd square [9].

- (19) Least deficient number of n consecutive deficient numbers such that all are abundant numbers when they are reversed.

21,218,445,2930,4873,...

E.g. 218 is deficient and 812 is abundant, 219 is deficient and 912 is abundant; hence 218 is the least number in a chain of 2. 445 is deficient and 544 is abundant, 446 is deficient and 644 is abundant, 447 is deficient and 744 is abundant; hence 445 is the least number in a chain of 3.

Is this sequence infinite? Investigate this sequence.

- (20) Let $\xi(n)$ be a function that sums the deficient numbers between the smallest and largest prime factors of n .

1,2,3,2,5,5,7,2,3,14,11,5,13,21,12,2,17,5,19,14,19,59,23,5,
5,7,2,3,21,29,14,31,2,57,134,12,5,37,153,70,14,41,21,43,59,
12,219,47,5,7,14,132,72,53,5,50,21,151,326,59,14,61,357,...

E.g. $\xi(n)=59$ because the smallest and largest prime factors of 22 are 2 and 11; the sum of deficient numbers between 2 and 11 is $2+3+4+5+7+8+9+10+11 = 59$. Investigate this function.

REFERENCES:

- [1] H. Eves, *Return to Mathematical Circles*, Boston: Prindle, Weber and Schmidt, 1988.
- [2] C. Stanley Ogilvy and John T. Anderson, *Excursions in Number Theory*, Oxford University Press, 1966, pp. 23-24.
- [3] G. Niklasch, PARI/GP Homepage, <http://www.parigp-home.de/>
- [4] John J. O'Connor, and Edmund F. Robertson, "Perfect Numbers," http://www-gap.dcs.st-and.ac.uk/~history/HistTopics/Perfect_numbers.html
- [5] John J. O'Connor, and Edmund F. Robertson, "Abu Mansur ibn Tahir Al-Baghdadi," <http://www-groups.dcs.st-andrews.ac.uk/~history/Mathematicians/Al-Baghdadi.html>
- [6] N. J. A. Sloane, On-line Encyclopedia of Integer Sequences, <http://www.research.att.com/~njas/sequences>
- [7] F. Smarandache, "Only Problems, not Solutions!", Xiquan Publ., Phoenix-Chicago, 1993
- [8] D. Hickerson, personal communication, Oct. 8, 2002.
- [9] Guy, R. K. *Unsolved Problems in Number Theory*, 2nd ed. New York: Springer-Verlag, pp. 45-46, 1994.

ON SMARANDACHE REPUNIT N NUMBERS

Jason Earls
513 N. 3rd Street
Blackwell, OK 74631 USA

Abstract: We define three new sets of numbers somewhat similar to Repunit numbers [1] and the Smarandache Unary numbers[2], which we call Smarandache Repunit N (SRN) numbers. We report primes, properties, conjectures and open questions concerning SRN numbers. Some subsidiary sequences are given along the way.

Reason's last step is the recognition that there are an infinite number of things which are beyond it. – Blaise Pascal, Pensees. 1670.

1. Introduction

In 1966 A. H. Beiler coined the term "repunit" for numbers consisting of N copies of the digit 1. The term repunit comes from the words "repeated" and "unit". Beiler also gave the first table of known factors of repunits [1]. These numbers have the form

$$R_n = 10^n - 1/9$$

It is still an unsolved problem as to whether there are infinitely many primes in R_n , and much computer time has been expended looking for repunit primes as well as factors. For example, In 1986 Williams and Dubner proved R_{1031} to be prime [7]. In 1999 the search was extended by Dubner who found the probable prime R_{49801} [8], and L. Baxter later discovered the probable prime R_{86453} [6]. Concerning factors of repunits, Andy Steward currently maintains a project to collate all known data on factorizations of generalized repunits [9], which have the form

$$GR_n^b = b^n - 1/b - 1.$$

In this paper we consider three new classes of numbers based on repunits, and similar to Smarandache Unary numbers (Smarandache Unary numbers are formed by repeating the digit 1 p_n times, where p_n is the n -th prime), which we call Smarandache Repunit N numbers. Now for some definitions.

Definition: Smarandache Repunit Ending N numbers (SRE) (A075842) [4] are defined as R_n_N where R_n is the nth Repunit number with N concatenated to the end; or n 1's followed by n. These have the form

$$\text{SRE} = (10^n - 1) / 9 * 10^L + n, \text{ where } L \text{ is the number of decimal digits of } n.$$

11, 112, 1113, 11114, 111115, 1111116, 11111117, 111111118,
1111111119, 11111111110, 111111111111, 1111111111112,
11111111111113, ...

Definition: Smarandache Repunit Beginning N numbers (SRB) (A075858) [4] are defined as N_R_n where R_n is the nth Repunit number with N concatenated to the beginning, or n followed by n 1's. These have the form

$$\text{SRB} = n * 10^n + (10^n - 1) / 9.$$

11, 211, 3111, 41111, 511111, 6111111, 71111111, 811111111,
9111111111, 101111111111, 1111111111111, 12111111111111,
131111111111111, ...

Definition: Smarandache Beginning and Ending N numbers (SRBE) (A075859) [4] are defined as $N_R_n_N$, where N is concatenated to the beginning and end of the n-th repunit number. These have the form

$$\text{SRBE} = n * 10^{(n+L)} + 10^L * R + n, \text{ where } R \text{ is the } n\text{-th repunit and } L \text{ is the number of decimal digits of } n.$$

111, 2112, 31113, 411114, 5111115, 61111116, 711111117,
8111111118, 91111111119, 1011111111110, 11111111111111,
121111111111112, ...

In this paper we consider the problem of determining which values in all three classes of Smarandache Repunit N numbers are prime, give some other properties of these numbers, make conjectures, and offer some open questions.

2. Prime Smarandache Repunit N Numbers

2.1 The known values of n such that $SRE(n)$ is prime (A070746) [4] are:

1, 7, 709, 2203, 4841,

Using PARI/GP [3] and the primality proving program Primo [5], $SRE(709)$ was found and certified prime by the author. The probable prime $SRE(2203)$ was also found by the author and Rick L. Shepherd found the probable prime $SRE(4841)$. Regarding the author's computer search, it consisted mainly of brute force with a couple of simple modular arguments to weed out the numbers which were obviously not prime.

Conjecture: There are infinitely many SRE primes.

2.2 The known values of n such that $SRB(n)$ is prime (A068817) [4] are:

1, 2, 5, 7, 10, 16, 20, 65, 91, 119, 169, 290, 428, 610, 905, 1051,
3488, 4526, 6445,

Using Chris Nash's primality proving program Prime Form [10], the probable primes $SRB(4526)$ and $SRB(6445)$ were found by the author. We are unaware of how many of the values in the above list have actually been certified prime. Regarding the author's computer search, it consisted mainly of brute force.

Conjecture: There are infinitely many SRB primes.

2.3 Concerning SRBE primes, there are none.

Proof: Obviously the digital sum of every SRBE number is a multiple of three; this follows from their definition. And since it is a well known fact that if the digital sum of a number is divisible by three, then the number is as well. Hence, there are no SRBE primes.

3. Other Properties of Smarandache Repunit N Numbers and Related Questions

3.1 SRE Numbers.

Concerning squares in SRE numbers, none were found up to SRE(10000). Heuristically, it seems highly unlikely that there will ever be a square SRE number. A program was written in PARI/GP [3] to search for the least square with n consecutive 1's and none out of the eight squares found came close to exhibiting the required digit pattern of SRE numbers.

Conjecture: There are no square SRE numbers.

Open question: Are there any SRE cubes or higher powers?

Some values n such that SRE is divisible by the sum of its digits are:
2, 6, 44, 51, 165, 692, 1286, and 4884.

Open question: Are there infinitely many SRE numbers with the above property?

Some values n such that the sum and product of the digits of SRE numbers (and SRB numbers) are both prime are:

13, 71, 1112, 1115, 1171, 1711, 5111,

Open question: Are there infinitely many SRE numbers with the above property?

3.2 SRB Numbers

Concerning squares in SRB numbers, there are none, and the proof is simple.

Proof: All squares greater than 9 must terminate in one of the following two digit endings:

00, 01, 04, 09, 16, 21, 24, 25, 29, 36, 41,
44, 49, 56, 61, 64, 69, 76, 81, 84, 89, 96.

Obviously no SRB number will be a square, since by definition all SRB's terminate with the digits '11'.

Open question: Are there any SRB cubes or higher powers?

Some values n such that SRB is divisible by the sum of its digits are:

33, 659, 2037, 5021.

Open question: Are there infinitely many SRB numbers with the above property?

3.3 SRBE Numbers

Concerning square SRBE numbers, none were found up to SRBE(10000). It seems unlikely that there will be any SRBE squares, but the proof seems difficult. The same empirical evidence given above for the nonexistence of square SRB numbers applies to square SRBE numbers as well.

Conjecture: There are no square SRBE numbers.

Open question: Are there any SRBE cubes or higher powers?

Digression: Notice that if we divide the SRBE number 31113 by the Product of its digits we get $31113/9 = 3457$, a prime.

Open question: Are there infinitely many SRBE numbers with the above property?

References

- [1] Beiler, A. H. "11111...111." Ch. 11 in Recreations in the Theory of Numbers: The Queen of Mathematics Entertains. New York: Dover, 1966.
- [2] M. Le, K. Wu, The Primes in the Smarandache Unary Sequence, Smarandache Notions Journal, Vol. 9, No. 1-2. 1998, 98-99.
- [3] G. Niklasch, PARI/GP Homepage, <http://www.parigp-home.de/>
- [4] N. J. A. Sloane, On-line Encyclopedia of Integer Sequences, <http://www.research.att.com/~njas/sequences>
- [5] M. Martin, PRIMO Homepage, <http://www.znz.freesurf.fr/#downloads>
- [6] Baxter, L. "R86453 Is a New Probable Prime Repunit." nmbrrthy@listserv.nodak.edu posting, 26 Oct 2000.
- [7] Williams, H. C. and Dubner, H. "The Primality of R1031." Math. Comput. 47, 703-711, 1986.
- [8] Harvey Dubner, New probable prime repunit R(49081), posting to NumberTheory List (NMBRTHRY@LISTSERV.NODAK.EDU) Sep 09, 1999.
- [9] Andy Steward, Generalized Repunits, <http://www.users.globalnet.co.uk/~aads/index.html>
- [10] Chris Nash, "Prime Form" OpenPFGW project, <http://www.primeform.net/openpfgw/index.html>

Some Simple Advantages Of Reasoning In Intuitionistic Neutrosophic Logic

Charles Ashbacher
Charles Ashbacher Technologies
Hiawatha, IA 52233 USA

Abstract: The traditional form of reasoning in logic and automated reasoning is severely limited in that it cannot be used to represent many circumstances. In this paper, we demonstrate two simple examples of the superiority of intuitionistic neutrosophic logic in representing the data of the real world.

The Definition of Intuitionistic Neutrosophic Logic

Intuitionistic neutrosophic logic is an extension of fuzzy logic, where the elements are assigned a four-tuple (t, i, f, u) representation of their truth value. t is the value of truth, i the value of indeterminacy, f the value of false and u is the degree to which the circumstances are unknown. The sum of the four terms is 1.0 and all are greater than or equal to zero, which maintains consistency with the classical and fuzzy logics. The logical connectives of and (\wedge), or (\vee) and not (\neg) can be defined in several ways, but here we will use the definitions used by Ashbacher to define INL2[1].

Definition 1:

$$\neg(t_1, i_1, f_1, u_1) = (f_1, i_1, t_1, u_1)$$

$$(t_1, i_1, f_1, u_1) \wedge (t_2, i_2, f_2, u_2) = (t = \min\{t_1, t_2\}, i = 1 - t - f - u, f = \max\{f_1, f_2\}, \\ u = \min\{u_1, u_2\})$$

$$(t_1, i_1, f_1, u_1) \vee (t_2, i_2, f_2, u_2) = (t = \max\{t_1, t_2\}, i = 1 - t - f - u, f = \min\{f_1, f_2\}, u = \min\{u_1, u_2\})$$

It is easy to verify that the elements of INL2 are closed with respect to these definitions of the basic logical connectives. Furthermore, many of the algebraic properties such as the associative and commutative laws also hold for these definitions.

An Example of Clauses In Automated Reasoning

In automated reasoning, facts are defined by stating instances of a predicate. For example, in Wos[2], the clause

FEMALE(Kim)

is used to represent that Kim is a female. A set of clauses is then developed which stores the knowledge of all persons who are female. Clauses such as

MALE(John)

are used to represent that John is a male. A query to the database of facts will have a form similar to

FEMALE(Kim)?

which is asking the question, "Is Kim female?" In standard reasoning, the response would be a yes or a true if the database of facts contains a clause of the form

FEMALE(Kim)

or there is a line of reasoning that leads to the conclusion that Kim is female.

In the case where there is no such fact or line of reasoning, the response would be no or false. Therefore, a negative response could be a no that was inferred from the data or a case where Kim does not appear in the database of females. The difference between these two conditions is substantial and the INL2 allows for them to be distinguished. If any form of knowledge can be inferred about the query, the value returned would be computed from the values. In the case where there is no information about the clause, the value returned by the query would be (0,0,0,1), which could be interpreted as unknown or unsupported by the facts. This value can then be considered the default for all items not in the database.

Using Intuitionistic Neutrosophic Logic In The Representation of Gender

In his book, Wos[2] uses the fact

\neg MALE(Kim)

to infer that Kim is female. Such rigid, two gender representations are in fact inaccurate. According to the Intersex Society of North America (<http://www.isna.org>) approximately 1 in 2000 children are born with a condition of "ambiguous" external genitalia. The condition ranges in a continuous manner from slight differences from the standard structure to a complete, functioning set of male and female reproductive systems.

Intersex conditions cannot be represented by the classical reasoning, for example if a person has the functioning sex organs of both gender, then to say either FEMALE(x) or MALE(x) is true is to arbitrarily assign a gender. Fuzzy systems are also of little value, for if MALE(x) and FEMALE(x) are both assigned values of 0.50, then the data supports the notion that the person is half male and half female. This is just as inaccurate, as the person is simultaneously of both sexes rather than made up of parts of both.

These ambiguities are easy to describe using intuitionistic neutrosophic logic. By assigning a nonzero value to the indeterminate value, it is then possible to represent the full spectrum of possible genders. For example, a value of (0, 1, 0, 0) assigned to FEMALE(Jane) could mean that Jane has complete sets of both sex organs.

References

1. C. Ashbacher, **Introduction to Neutrosophic Logic**, American Research Press, 2002. <http://www.gallup.unm.edu/~smarandache/IntrodNeutLogic.pdf>.
2. L. Wos, **Auomated Reasoning: 33 Basic Research Problems**, Prentice-Hall, 1988.

SMARANDACHE ITERATIONS OF THE FIRST KIND ON
FUNCTIONS INVOLVING DIVISORS AND PRIME FACTORS

Jason Earls
513 N. 3rd Street
Blackwell, OK 74631 USA
Email: jcearls@kskc.net

ABSTRACT

In this paper we consider Smarandache Iterations of the First Kind [2] upon four new functions which deal with divisors and prime factors of positive integers, make conjectures and give some open problems.

I INTRODUCTION

Consider Smarandache Iterations of the First Kind where a function, $f(n) \leq n$ for all n , is iterated until it reaches a constant value. For example, let $d(n)$ be the number of positive divisors of n and 2 the constant value to be reached. For $n=8$ we would have:

$$d(d(d(8))) = d(d(4)) = d(3) = 2.$$

Thus $SI1_d(8) = 3$, because it takes 3 iterations to reach the constant value 2.

Or, another way to represent this is:

8 → 4 → 3 → 2; and say 8 takes three "steps" to reach 2 when iterating the function $d(n)$.

In this paper we will drop the $SI1$ notation, use the "step" terminology, and also investigate some functions where $f(n)$ is not $\leq n$ for all n .

II INVESTIGATIONS AND OPEN PROBLEMS

(A) Let $f(n)$ be a function giving the absolute value of the largest prime factor subtracted from the largest proper divisor of a positive integer n :

$$f(n) = \text{abs}(\text{lpd}(n) - \text{Lpf}(n)).$$

(Here we take the absolute value to avoid getting negative values.) For example, when $n=13$, the largest proper divisor is 1 and the largest prime factor is 13, which would be:

$$1 - 13 = -12 \text{ and } |-12| = 12, \text{ so } f(13) = 12.$$

If we iterate the function $f(n)$, how many iterations will it take for a given integer n to reach 0? E.g. iterating $f(13)$ gives:

13 -> 12 -> 3 -> 2 -> 1 -> 0; 5 steps to reach 0.

Iterating $f(412)$ gives:

412 -> 103 -> 102 -> 34 -> 0; 4 steps to reach 0.

Here is the sequence of the number of steps it takes $f(n)$ to reach zero upon iteration for $n=1$ to 100 (A075660) [1]:

1,2,3,1,2,1,2,3,1,1,2,4,5,1,1,2,3,2,3,3,1,1,2,2,1,
1,2,3,4,2,3,2,1,1,1,2,3,1,1,2,3,2,3,3,2,1,2,2,1,4,
1,6,7,3,1,2,1,1,2,2,3,1,2,3,1,2,3,4,1,4,5,2,3,1,4,
4,1,2,3,2,3,1,2,2,1,1,1,2,3,3,1,3,1,1,1,3,4,3,2,3,

Now a natural question to ask is: what is the smallest number requiring k steps to reach 0 when iterating $f(n)$? Using the programming package PARI/GP [3] a program was written to construct the following table of these numbers for $k \leq 19$ (A074347) [1]:

Number of steps	Smallest number
1	1
2	2
3	3
4	12
5	13
6	52
7	53
8	131
9	271
10	811
11	1601
12	2711
13	8111
14	13997
15	34589
16	74551
17	147773
18	310567
19	621227

Note that 1, 12, and 52 are the only non-prime values in the "smallest number" sequence above. Of course it is easy to see why there is an abundance of primes here. $f(p)=p-1$ for any prime p since the largest prime factor of p is p and the largest proper divisor of p is always 1. Because $f(p)$ will always equal $p-1$ it will take more steps for $f(p)$ to reduce to zero upon iteration.

Open problems: What is the next non-prime number in this sequence, if one exists? What is the 20th term of this sequence?

We conjecture that the above sequence: smallest number requiring k steps to reach zero when iterating the function $f(n)=\text{abs}(\text{lpd}(n)-\text{Lpf}(n))$, is finite. Or stated another way, there is a number K such that no number requires greater than K steps when iterating $f(n)$ to reach zero.

(B) Next we will perform the same operation but instead of using

the largest proper divisor, we will define a function $g(n)$ with $Lpf(n)$ and the largest common difference between consecutive divisors when they are ordered by size, or: $g(n)=Lcdd(n)-Lpf(n)$.
 E.g. for $n=9$, the divisors of 9 are [1, 3, 9] with the largest difference between consecutive divisors being $9-3=6$. And the largest prime factor being 3 and $6-3=3$, so $g(9)=3$. When iterating this function it becomes apparent that every number will eventually reach 0 or -1, so we can ask for a sequence of the number of steps it takes any n to reach 0 or -1 when iterating $g(n)$. Here are the first one hundred values (A075661) [1]:

1,1,1,1,1,1,1,2,2,1,1,2,1,1,2,2,1,2,1,2,2,1,1,3,3,
 1,3,2,1,2,1,2,2,1,3,3,1,1,2,3,1,2,1,2,4,1,1,3,4,3,
 2,2,1,4,3,3,2,1,1,4,1,1,4,3,3,2,1,2,2,3,1,3,1,1,5,
 2,4,2,1,4,3,1,1,4,3,1,2,3,1,4,4,2,2,1,3,5,1,3,4,5,

Again, we ask the question: what is the smallest number requiring k steps for the iterated function $g(n)$ to reach 0 or -1? Below is a table of these numbers for $k \leq 26$ (A074348) [1]:

Number of steps	Smallest number
1	1
2	8
3	24
4	45
5	75
6	160
7	273
8	429
9	741
10	1001
11	1183
12	1547
13	2645
14	3553
15	4301
16	5423
17	10880
18	23465
19	33371
20	39109
21	49075
22	74011
23	98933
24	104371
25	107911
26	163489

Obviously none of the terms in the above sequence will be prime since the largest common difference between any prime p is $p-1$ and the largest prime factor of a prime is p , and $(p-1)-p = -1$, therefore all primes will take one step only to reach -1. Also, the author noticed no pattern when looking at the factorizations of the "smallest number" sequence above.

Open problem: What is the value for $k=27$? We conjecture that

this sequence is finite (although not necessarily at $k=26$).

(C) Now we will add a new concept to our iterative work, the concept of reversing the elements of n in the functions we have been exploring. This may seem unnatural, but let's get a little adventurous, shall we?

Consider the function we worked with in section A, except now we will reverse $lpd(n)$ and $Lpf(n)$:

$$h(n) = \text{abs}(\text{reverse}(lpd(n)) - \text{reverse}(Lpf(n)))$$

that is, we are taking the absolute value of the reversal of the largest proper divisor of n minus the reversal of the largest prime factor of n . This is an erratic function, and notice that since $h(n)$ is not $\leq n$ for all n :

n	1	2	3	4	5	6	7	8	9	10	11	12	13	14	15	16	17	18	19	20
h(n)	0	1	2	0	4	0	6	2	0	0	10	3	30	0	0	6	70	6	90	4

It deviates slightly from the definition of Smarandache Iterations of the First Kind.

Here is the sequence of the number of steps it takes $h(n)$ to reach zero for $n=1$ to 100:

1,2,3,1,2,1,2,3,1,1,2,4,3,1,1,2,3,2,3,2,1,1,6,3,1,
 1,2,2,2,2,5,3,1,1,1,3,5,1,1,4,4,3,2,3,2,1,5,2,1,6,
 1,6,2,2,1,7,1,1,2,3,2,1,3,2,1,2,7,3,1,2,3,4,4,1,6,
 4,1,2,4,2,2,1,6,4,1,1,1,2,4,2,1,4,1,1,1,3,3,2,2,1,

Again, the question is asked, what is the smallest number requiring k steps for the iterated function $h(n)$ to reach 0? Below is a table of these numbers for $k \leq 12$.

Number of steps	Smallest number
1	1
2	2
3	3
4	12
5	31
6	23
7	56
8	102
9	193
10	257
11	570
12	1129

The interesting thing to notice in the above table is that due to the reversal of $lpd(n)$ and $Lpf(n)$, the "smallest number" sequence above is not monotonically increasing, i.e. 31 is the smallest number which takes 5 steps to reach 0, while 23 is the smallest number which takes 6 steps to reach zero. Also, note that there are seven primes and five non-primes in the above sequence. So one class is not predominating this sequence as in the others, at least for the first twelve values.

Open problem: What is the value requiring 13 steps?

We conjecture that this sequence is finite (although not necessarily at $k=12$).

(D) Now we will use the function in section B, except we will reverse its divisor/factor elements. That is, we will use:

$$i(n) = \text{abs}(\text{reverse}(\text{Lcdd}(n)) - \text{reverse}(\text{Lpf}(n)))$$

and observe what happens when it is iterated. First notice that $i(n)$ is not $\leq n$ for all n :

n	1	2	3	4	5	6	7	8	9	10	11	12	13	14	15	16	17	18	19	20	21	22
i(n)	1	1	1	0	1	0	1	2	3	0	10	3	10	0	4	6	10	6	10	4	34	0

Number of steps it takes $i(n)$ to reach one or zero for $n=1$ to 100:

0,1,1,1,1,1,1,2,2,1,2,2,2,1,2,2,2,2,2,2,2,1,2,3,2,
 1,3,2,2,2,2,3,3,1,2,3,2,1,3,2,2,2,2,3,2,1,2,4,3,3,
 3,3,2,5,4,2,3,1,2,2,2,1,3,3,2,2,2,3,4,2,2,3,2,1,1,
 3,5,2,2,1,3,1,2,3,3,1,2,4,2,4,3,4,3,1,4,4,2,3,5,1,

Table for $k \leq 19$ of smallest number requiring k steps for the iterated function $i(n)$ to reach one or zero:

Number of steps	Smallest number
1	2
2	8
3	24
4	48
5	54
6	176
7	215
8	161
9	287
10	650
11	512
12	609
13	432
14	455
15	749
16	774
17	2650
18	2945
19	2997

Again this sequence is not monotonically increasing. There are no primes except 2 in the "smallest number" sequence above since for any prime p , $i(p)$ will always give a power of 10; this follows from the definition of our function. To see this, let's take the prime 569 as an example. $\text{Lcdd}(569) = 568$ and $\text{Lpf}(569) = 569$. When we reverse and subtract we get $965 - 865 = 100$. So, for any prime p , $i(p) = 10^{l(p)-1}$, where $l(x)$ is the number of digits of x . And for all $p > 7$, $i(p)$ will take 2 steps to reach 0. We conjecture that this sequence is finite (although not necessarily at $k=19$).

We have introduced four new functions having to do with prime factors and divisors of integers, made four conjectures regarding the finiteness of sequences involving Smarandache Iterations of the First Kind upon these functions, as well as giving some open problems. Our motivation for using prime factors and divisors in the functions is that other iterations have been explored with operations of multiplication [4] and addition of digits, along with some of the more common number theoretic functions [5], and thus we thought it would be interesting to investigate the underlying structure of integers through some unusual functions involving divisibility concepts when performing Smarandache Iterations of the First Kind.

On a computer related note, we realize that an interpreted algebra package such as PARI/GP, which the author used when preparing this paper, is not the best way to investigate the open problems given. A better way would be to write much faster programs in C or a similar programming language.

In closing, we suggest one more idea that we have not yet explored. The author thinks it would be very interesting to iterate the function $j(n) = \text{Lpf}(n) - \text{Ndc}(n)$, where $\text{Lpf}(n)$ is the largest prime factor of n and $\text{Ndc}(n)$ is the number of distinct differences between consecutive divisors of n , when ordered by size (A060682) [1]. Let us know your results regarding iteration of this function!

REFERENCES

- [1] N. J. A. Sloane, On-line Encyclopedia of Integer Sequences, <http://www.research.att.com/~njas/sequences>
- [2] Ibstedt, H., "Smarandache Iterations of First and Second Kinds", <Abstracts of Papers Presented to the American Mathematical Society>, Vol. 17, No. 4, Issue 106, 1996, p. 680.
- [3] G. Niklasch, PARI/GP Homepage, <http://www.parigp-home.de/>
- [4] N. J. A. Sloane, The persistence of a number, J. Recreational Math., 6 (1973), 97-98.
- [5] Ibstedt, H., "Surfing on the Ocean of Numbers - A Few Smarandache Notions and Similar Topics", Erhus University Press, Vail, 1997; pp. 52-58.

THE SMARANDACHE SUM OF COMPOSITES BETWEEN FACTORS FUNCTION

Jason Earls
513 N. 3rd Street
Blackwell, OK 74631 USA
Email: jcearls@kskc.net

ABSTRACT

In this paper some basic properties of the Smarandache Sum of Composites Between Factors function are given, investigations are reported, conjectures are made, and open problems are given. As far as the author knows, this function is new and has never been investigated previously.

KEYWORDS:

Composites, Consecutive values, Even numbers, Factors, Factorials, Functions, Odd numbers, Palindromes, Primes, Reverse, Smarandache function, Squares, Square-free, Sum of composites, Triangular.

I INTRODUCTION

The Smarandache Sum of Composites Between Factors function $SCBF(n)$ is defined as: The sum of composite numbers between the smallest prime factor of n and the largest prime factor of n (A074037) [1]. Example: $SCBF(14) = 10$ since $2 \cdot 7 = 14$ and the sum of the composites between 2 and 7 is: $4 + 6 = 10$.

The first 50 values of SCBF(n) are:

n	SCBF(n)	n	SCBF(n)
1	0	26	49
2	0	27	0
3	0	28	10
4	0	29	0
5	0	30	4
6	0	31	0
7	0	32	0
8	0	33	37
9	0	34	94
10	4	35	6
11	0	36	0
12	0	37	0
13	0	38	112
14	10	39	49
15	4	40	4
16	0	41	0
17	0	42	10
18	0	43	0
19	0	44	37
20	4	45	4
21	10	46	175
22	37	47	0
23	0	48	0
24	0	49	0
25	0	50	4

II SOME PROPERTIES OF SCBF(n):

(A) $SCBF(p) = 0$, for any prime p , or p^k , and integers of the form $2^i \cdot 3^j$, where i, j , and k are positive integers.

This follows from the definition.

(B) If i and j are positive integers then $SCBF(2^i \cdot 5^j) = 4$, $SCBF(2^i \cdot 7^j) = 10$, etc. More generally, to allow other prime factors between the smallest and largest, if i and k are positive integers and j is a nonnegative integer, then $SCBF(2^i \cdot 3^j \cdot 5^k) = 4$, etc. This follows from the definition.

(C) $SCBF(n)$ is not a multiplicative function.
 E.g. $\gcd(14, 15) = 1$. $SCBF(14 \cdot 15) = 10$ and $SCBF(14) \cdot SCBF(15) = 40$.

III INVESTIGATIONS AND OPEN PROBLEMS

Using PARI/GP [2], a software package for computer-aided number theory, the author has explored and compared $SCBF(n)$ with some of the more common number theoretic functions as well as some of the more obscure functions in the hope of finding interesting results.

(A) There are solutions to $SCBF(n) = n$, although they are very rare. Dean Hickerson [3] found one such solution, not necessarily the smallest, which is: $SCBF(245220126046) = 245220126046$. His method was to search for a prime p for which the sum S of the composites from 2 to p is a multiple of $2p$. His reasoning was that since $S < p^2/2$, S can't have any prime factors larger than p (or less than 2), so S satisfies $SCBF(n) = n$. According to [3] the probability that S is divisible by $2p$ is $1/(2p)$; since the sum of the reciprocals of the primes diverges slowly to infinity, there are probably infinitely many solutions of this type, although they will be very rare.

Is 245220126046 the smallest even solution to $SCBF(n) = n$? What is the smallest odd solution?

(B) When $SCBF(n)$ is compared with some of the more common number theoretic functions, it is relatively easy to find solutions (although the following two sequences were not thoroughly analyzed). E.g. some solutions to $\text{bigomega}(n) = SCBF(n)$, where $\text{bigomega}(n)$ is the number of prime factors of n , (with repetition) are:

40,60,90,100,135,150,225,250,375,3584,5376,8064,

and solutions to $SCBF(n) = d(n)$, where $d(n)$ is the number of divisors of n are:

10,15,112,175,245,567,4802,7203,

(C) Solutions n such that $SCBF(n) = S(n)$ where $S(n)$ is the Smarandache function (A002034) [1], [4] are:

350,525,700,1050,1400,1575,1792,2100,2800 (A074055) [1]

Note that all of these numbers are of the forms: $2^i \cdot 3^j \cdot 5^k \cdot 7^l$, $2^i \cdot 5^j \cdot 7^k$, $3^i \cdot 5^j \cdot 7^k$, or $2^i \cdot 7^k$, with $S(x)$ and $SCBF(x)$ being 10. What is the first term in the sequence not having the aforementioned forms? Are there an infinite number of solutions to the above functional equation?

(D) Some solutions n such that $SCBF(n)$ is prime (A074054) [1] are:

a) 22,33,44,66,88,99,106,110,132,134,154,155,159,165,176,178

With the primes being:

b) 37,37,37,37,37,37,1049,37,37,1709,37,331,1049,37,37,3041,

Note that in sequence D.a. above, there are consecutive values listed. Are there an infinite number of consecutive values? Are there an infinite number of triple consecutive values such that $SCBF(n)$ is a prime? For example:

$SCBF(889) = 6397$; $SCBF(890) = 3041$; $SCBF(891) = 37$.

Due to the abundance of solutions found from a computer search for sequence D.a, we are confident enough to conjecture that there are an

infinite number of consecutive and triple consecutive solutions.

Concerning sequence D.b above, what is the first palindromic prime value? The author has found none for $n \leq 10000$. Yet due to the erratic nature of the primes arising in the above list, we are confident enough to conjecture that there will be at least one palindromic prime solution in sequence D.b. What is the first prime in sequence D.b consisting of fifty digits?

(E) From a purely recreational viewpoint, it is often interesting to work with some of the more base 10 dependent functions to find surprising results. The rest of this paper deals with some of these base 10 dependent functions.

Let $SFD(n)$ be the sum of factorials of the digits of n (A061602)
[1]. Are there an infinite number of solutions to $SCBF(n) = SFD(n)$?
The author has found only three solutions:

120,200,1000.

Example: $120 = 2^3 \cdot 3 \cdot 5$ and 4 is the only composite between 2 and 5;
 $1!+2!+0! = 4$.

(F) Let $SDS(n)$ be the sum of squares of digits of n (A003132)
[1]. Are there an infinite number of solutions n to $SCBF(n) = SDS(n)$?
The author has found the following solutions:

20,200,2000,2754,5681,15028,19152,20000,25704,27945,31824,

Example: $2000 = 2^4 \cdot 5^3$ and 4 is the only composite between 2 and 5;
 $2^2+0^2+0^2+0^2 = 4$.

(E) Let $R(n)$ be the reversal of n . Are there an infinite number of solutions to $SCBF(n) = R(n)$?

IV CONCLUSION

The $SCBF(n)$ function has been compared with various other number theoretic functions and fruitful avenues of research are still very much open. Different bases could be explored as well as making

comparisons with other functions not mentioned here. The SCBF(n) function also suggests that other functions can be defined by summing different classes of numbers which lie between the smallest prime factor and the largest prime factor of any integer. For example, SSBF(n) could be the sum of the square free numbers between the smallest and largest prime factors of n. STBF(n) could be the sum of the triangular numbers between the smallest and largest prime factors of n. SPBF(n) could be the sum of the palindromes between the smallest and largest prime factors of n. The odd and even numbers could be summed between the smallest and largest prime factors of n as well. All of these functions should be investigated!

Thanks to Dean Hickerson for helpful comments concerning the SCBF(n) function.

REFERENCES:

- [1] N. J. A. Sloane, On-line Encyclopedia of Integer Sequences, <http://www.research.att.com/~njas/sequences>
- [2] G. Niklasch, PARI/GP Homepage, <http://www.parigp-home.de/>
- [3] Dean Hickerson, personal communication via email, Sep. 23, 2002.
- [4] F. Smarandache, A Function in the Number Theory, Analele Univ. Timisoara, Fascicle 1, Vol. XVIII, 1980, pp. 79-88; Smarandache Function J. 1 (1990), no. 1, 3-17.
- [5] Eric W. Weisstein, Smarandache Function, <http://mathworld.wolfram.com/SmarandacheFunction.html>

ON THE MEAN VALUE OF m -TH POWER FREE NUMBERS*

YAO WEILI

College of Mathematics and Computer Science, Yanan University
Yanan, Shaanxi, P.R.China

ABSTRACT. A positive integer n is called m -th power free number if it can not be divided by m -th power of each prime. The main purpose of this paper is to give a k -th power mean value formula for the m -th power free numbers.

1. INTRODUCTION

A positive integer n is called m -th power free number if it is not multiples of $2^m, 3^m, 5^m, 7^m \dots p^m$ and so on. That is, it can not be divided by m -th power of each prime. Generally, one obtains all m -th power free numbers if he takes off all multiples of m -power primes from the set of natural numbers (except 0 and 1). Let $a(n, m)$ denotes the m -power free sequence. In problem 31 of [1], Professor F.Smarandach asked us to study the properties of this sequence. In this paper, we use the elementary methods to study the mean value properties of this sequence, and give its k -th power mean value formula. That is, we shall prove the following main conclusion:

Theorem. For any positive integer $x > 1$ and $n > 0$, we have the asymptotic formula

$$\sum_{n \leq x} a^k(n, m) = \begin{cases} \frac{x^{k+1}}{k+1} \frac{1}{\zeta(m)} + O(x^{k+\frac{1}{m}}) & \text{if } k \geq 0; \\ \frac{x^{k+1}}{k+1} \frac{1}{\zeta(m)} + \frac{\zeta(-k)}{\zeta(-mk)} + O(x^{k+\frac{1}{m}}) & \text{if } k < 0 \text{ but } k \neq -1; \\ \frac{\log x}{\zeta(m)} - m \frac{\zeta'(m)}{\zeta^2(m)} + O(x^{1-m}) & \text{if } k = -1. \end{cases}$$

where $\zeta(m)$ is the Riemman-zeta function.

If $m = 3$, then the sequence become the cube free number, from our theorem we may deduce the following:

Corollary. For any positive integer $x > 1$ and $n > 0$, we have the formula

$$\sum_{n \leq x} a^k(n, 3) = \begin{cases} \frac{x^{k+1}}{k+1} \frac{1}{\zeta(3)} + O(x^{k+\frac{1}{3}}) & \text{if } k \geq 0; \\ \frac{x^{k+1}}{k+1} \frac{1}{\zeta(3)} + \frac{\zeta(-k)}{\zeta(-3k)} + O(x^{k+\frac{1}{3}}) & \text{if } k < 0 \text{ but } k \neq -1; \\ \frac{\log x}{\zeta(3)} - 3 \frac{\zeta'(3)}{\zeta^2(3)} + O(x^{-2}) & \text{if } k = -1. \end{cases}$$

Key words and phrases. M -th power free numbers; Mean value property; Asymptotic formula.

* This work is supported by the N.S.F. and the P.S.F. of P.R.China.

2. PROOF OF THE THEOREM

In this section, we shall use elementary methods and the Euler summation formula to complete the proof of the theorem. First for any positive integer $x > 1$ and $n > 0$, if $k \geq 0$, we have the asymptotic formula

$$\begin{aligned}
 \sum_{n \leq x} a^k(n, m) &= \sum_{n \leq x} n^k \sum_{d^m | n} \mu(d) = \sum_{d \leq x^{1/m}} d^{mk} \mu(d) \sum_{n \leq x/d^m} n^k \\
 &= \sum_{d \leq x^{1/m}} d^{mk} \mu(d) \left(\frac{\left(\frac{x}{d^m}\right)^{k+1}}{k+1} + O\left(\frac{x^k}{d^{mk}}\right) \right) \\
 &= \frac{x^{k+1}}{k+1} \sum_{d \leq x^{1/m}} \frac{\mu(d)}{d^m} + O(x^{k+1/m}) \\
 &= \frac{x^{k+1}}{k+1} \frac{1}{\zeta(m)} + O(x^{k+1/m})
 \end{aligned}$$

Furthermore, if $k < 0$ but $k \neq -1$, we have

$$\begin{aligned}
 \sum_{n \leq x} a^k(n, m) &= \sum_{d \leq x^{1/m}} d^{mk} \mu(d) \sum_{n \leq x/d^m} \frac{1}{n^{-k}} \\
 &= \sum_{d \leq x^{1/m}} d^{mk} \mu(d) \left(\frac{\left(\frac{x}{d^m}\right)^{k+1}}{k+1} + \zeta(-k) + O\left(\frac{x^k}{d^{mk}}\right) \right) \\
 &= \sum_{d \leq x^{1/m}} \frac{x^{1+k}}{1+k} \frac{\mu(d)}{d^m} + \sum_{d \leq x^{1/m}} \zeta(-k) d^{mk} \mu(d) + O(x^{k+1/m}) \\
 &= \frac{x^{1+k}}{1+k} \frac{1}{\zeta(m)} + \frac{\zeta(-k)}{\zeta(-mk)} + O(x^{k+1/m})
 \end{aligned}$$

Note that

$$F(m) = \sum_{n=1}^{\infty} \frac{\mu(n)}{n^m} = \frac{1}{\zeta(m)}$$

we have

$$F'(m) = - \sum_{n=1}^{\infty} \frac{\mu(n) \log n}{n^m} = - \frac{\zeta'(m)}{\zeta^2(m)}$$

From this formula, we can immediately get

$$\sum_{n=1}^{\infty} \frac{\mu(n) \log n}{n^m} = \frac{\zeta'(m)}{\zeta^2(m)}$$

If $k = -1$, we have

$$\begin{aligned}
 \sum_{n \leq x} \frac{1}{a(n, m)} &= \sum_{d \leq x^{1/m}} d^{-m} \mu(d) \sum_{n \leq x/d^m} \frac{1}{n} \\
 &= \sum_{d \leq x^{1/m}} \frac{\mu(d)}{d^m} \log \frac{x}{d^m} \\
 &= \sum_{d \leq x^{1/m}} \frac{\mu(d)}{d^m} (\log x - m \log d) \\
 &= \frac{\log x}{\zeta(m)} - m \sum_{n=1}^{\infty} \frac{\mu(d) \log d}{d^m} + O(x^{1-m}) \\
 &= \frac{\log x}{\zeta(m)} - m \frac{\zeta'(m)}{\zeta^2(m)} + O(x^{1-m})
 \end{aligned}$$

This completes the proof of the Theorem.

REFERENCES

1. F. Smarandache, *Only problems, not Solutions*, Xiquan Publ. House, Chicago, 1993, pp. 27.
2. Tom M. Apostol, *Introduction to Analytic Number Theory*, Springer-Verlag, New York, 1976.
3. R. K. Guy, *Unsolved Problems in Number Theory*, Springer-Verlag, New York, Heidelberg, Berlin, 1981.
4. "Smarandache Sequences" at <http://www.gallup.unm.edu/~smarandache/snaqint.txt>.
5. "Smarandache Sequences" at <http://www.gallup.unm.edu/~smarandache/snaqint2.txt>.
6. "Smarandache Sequences" at <http://www.gallup.unm.edu/~smarandache/snaqint3.txt>.

A NOTE ON THE SMARANDACHE DIVISORS OF DIVISORS SEQUENCE
AND TWO SIMILAR SEQUENCES

Jason Earls
513 N. 3rd Street
Blackwell, OK 74631 USA

In [1] Murthy defined the Smarandache Divisors of Divisors sequence as $T_1 = 3$, and $T_{n-1} = d(T_n)$, the number of divisors of T_n , where T_n is smallest such number:

3, 4, 6, 12, 72, 559872, $2^{2186} * 3^{255}, \dots$

For example, 12 is the smallest number having 6 divisors.

Also in [1] Murthy conjectured that after incrementing the above sequence by 1:

4, 5, 7, 13, 73, 559873, ...

it will contain all primes from the second term onward.

The purpose of this short note is to show that Murthy's Divisors of Divisors sequence contained errors from the 5th term onward, and based on this fact we give two counterexamples to Murthy's conjecture.

A program was written in PARI/GP [2] to compute the Smarandache Divisors of Divisors sequence and the terms 3,4,6,12,60,5040, were given. The value 72 was listed in the original sequence and while 72 does have 12 divisors, 60 is the least such number and therefore should be the 5th term. Seeing that our computed sequence differed from Murthy's sequence, we looked these 6 terms up at OEIS [3] and the correct version of the Smarandache Divisors of Divisors sequence was found (A009287) [3]--

3, 4, 6, 12, 60, 5040, 293318625600,
6700591682045851683714764389274211129/
33837297640990904154667968000000000000

which when incremented by 1 becomes--

4, 5, 7, 13, 61, 5041, 293318625601,
6700591682045851683714764389274211129/
33837297640990904154667968000000000001

Concerning Murthy's conjecture, that all of the terms in the incremented sequence will be prime from the second term onward, notice that $5041 = 71^2$; and the factors of

6700591682045851683714764389274211129/
33837297640990904154667968000000000001

are:

127 * 25624431359 *
205899454650832422686209906658432939349460496699031746583235457

which are both counterexamples to the conjecture.

Open question: What is the next term of the Smarandache Divisors of Divisors sequence?

TWO NEW SMARANDACHE SEQUENCES

1. Let $sopfr(n)$ denote the sum of primes dividing n (with repetition) (A001414) [3].

n	1	2	3	4	5	6	7	8	9	10	11	12	13	14	15	16	17	18	19	20
$sopfr(n)$	0	2	3	4	5	5	7	6	6	7	11	7	13	9	8	8	17	8	19	9

Let $s(1)=2$, $s(n+1) =$ least k with sum of prime factors (with repetition) $= s(n)+1$ (A075721) [3]:

2, 3, 4, 5, 8, 14, 26, 92, 356, 1412, 5636, 185559, 556671,

Example: 92 is a term because it's the smallest number such that its sum of prime factors is equal to the previous term + 1;
 $92 = 2^2 \cdot 23$ and $2+2+23 = 26+1$.

Conjecture: This sequence is infinite.

2. Let $t(1)=2$, $t(n+1)=$ least k with sum of squares of digits $= t(n)$.

2, 11, 113, 78, 257, 18888,

For example, 113 is a term because the sum of its digits after being squared is equal to 11, the previous term;
 $11 = 1^2 + 1^2 + 3^2$.

Problem: What is the next term of this sequence?

REFERENCES

- [1] A. Murthy, "Smarandache Function of a Function and Other Sequences, Smarandache Notions Journal, <http://www.gallup.unm.edu/~smarandache/amarnath/smarfofs.htm>
- [2] G. Niklasch, PARI/GP Homepage, <http://www.parigp-home.de/>
- [3] N. J. A. Sloane, On-line Encyclopedia of Integer Sequences, <http://www.research.att.com/~njas/sequences>

Formula to Obtain the Next Prime Number in Any Increasing Sequence of Positive Integer Numbers

Sebastián Martín Ruiz
 Avda. de Regla 43, Chipiona 11550 Spain
smaranda@teleline.es
www.telefonica.net/c/smruiz

Abstract:

In this article I give a generalization of the previous formulas [1],[2],[3] to obtain the following prime number, valid for any increasing sequence of positive integer numbers in the one that we know the algebraic expression of its nth term.

THEOREM: Let $\{a_n\}_{n \geq 1}$ an increasing sequence of positive integers of which we know the algebraic expression of its nth term; that is to say:

It exists $f : N \rightarrow N$ such that $f(n) = a_n$

As f it is increasing also:

It exists $f^{-1} : N \rightarrow R$ inverse function of f

Let $p \in \{a_n\}_{n \geq 1}$ a term of the sequence, (It doesn't have to be prime)

Let us consider the expression obtained by me [1],[2],[3],[4] of the Smarandache prime function:

$$G(k) = \left\lfloor \frac{2 - \left(\sum_{s=1}^k \left\lfloor \frac{k}{s} \right\rfloor - \left\lfloor \frac{k-1}{s} \right\rfloor \right)}{k} \right\rfloor = \begin{cases} 1 & \text{if } k \text{ is composite} \\ 0 & \text{if } k \text{ is prime} \end{cases}$$

$\lfloor x \rfloor$ = is the greatest integer less than or equal to x .

And their improved expression [3]:

$$G(k) = \left\lfloor \left(2 + 2 \sum_{s=1}^{\sqrt{k}} \left(\frac{k-1}{s} - \frac{k}{s} \right) \right) / k \right\rfloor$$

where all the divisions of this last expression are integer divisions.

Then the next prime number in the sequence is:

$$NXT_f(p) = f \left[f^{-1}(p) + 1 + \sum_{k \geq f^{-1}(p)+1} \prod_{j=f^{-1}(p)+1}^k G(f(j)) \right]$$

REMARKS:

- 1: It is necessary that $p \in \{a_n\}$ so that $f^{-1}(p)$ it is an integer number.
- 2: Although the sum in the expression NXT_f is not enclosed, we can calculate the sum until a given M, to obtain a computable algorithm that then will see (Examples). The only inconvenience is , that when making this truncation, the last value obtained in the algorithm is not correct in general , but all the other values are correct. (Examples).
- 3: With the improved expression of G(k) the calculation is much quicker.
- 4: The function is increasing in strict sense. i.e.:

$$j < k \Rightarrow a_j < a_k \text{ and } a_j \neq a_k$$

Many sequences of integers numbers are increasing in strict sense.

- 5: The algorithm that is obtained is of polynomial complexity if f is of polynomial complexity (Examples).

PROOF:

Let $p \in \{a_n\}_{n \geq 1} = \{f(n)\}_{n \geq 1}$ as we already said, It doesn't have to be prime. $p = f(j_0)$ with $j_0 \geq 1$.

$$NXT_f(p) = f \left[j_0 + 1 + \sum_{k \geq j_0+1} \prod_{j=j_0+1}^k G(f(j)) \right]$$

$$\sum_{k \geq j_0+1} \prod_{j=j_0+1}^k G(f(j)) = \sum_{k=j_0+1}^{j_1-1} \prod_{j=j_0+1}^k G(f(j)) + \sum_{k \geq j_1} \prod_{j=j_0+1}^k G(f(j)) = (**)$$

Where $f(j_1) = q$ is the next prime number to $f(j_0) = p$ in the sequence $\{f(n)\}_{n \geq 1}$.

$j_0 + 1 \leq j \leq j_1 - 1$ and $f(n)$ increasing, it implies that

$$p < f(j) < q \quad j : j_0 + 1 \leq j \leq j_1 - 1.$$

Therefore $f(j)$ is composite for all $j : j_0 + 1 \leq j \leq j_1 - 1$, for which:

$$G(f(j)) = 1 \quad j : j_0 + 1 \leq j \leq j_1 - 1.$$

On the other hand $G(f(j_1)) = 0 = G(q)$ since q is prime.

Returning to the previous expression has that:

$$(**) = j_1 - 1 - (j_0 + 1) + 1 + \sum_{k \geq j_1} 0 = j_1 - j_0 - 1$$

Lastly we have that:

$$NXT_f(p) = f(j_0 + 1 + j_1 - j_0 - 1) = f(j_1) = q \text{ and the theorem is already proved.}$$

EXAMPLES: I give three examples of the algorithm in MATHEMATICA language.:

Example 1:

```

M = 40
40
f[n_] := n^2 + 3
fl[p_] := Sqrt[p - 3]
G[x_] := -Quotient[(2 +
    2*Sum[Quotient[(x - 1), s] - Quotient[x, s], {s, 1, Sqrt[x]}]), x]
NXT[p_] :=
    fl[fl[p] + 1 + Sum[Product[G[f[j]], {j, fl[p] + 1, k}], {k, fl[p] + 1, M}]]
p = fl[1]
4
While[p < fl[M], (Print[NXT[p], " ", PrimeQ[NXT[p]]]; p = NXT[p])]
7    True
19   True
67   True
103  True
199  True
487  True
787  True
1447 True
1684 False

```

It is observed that the last value is not correct due to the truncation.

Example 2:

```

M = 40
40
f[n_] := n^3 + 4
fl[p_] := (p - 4)^(1/3)
G[x_] := -Quotient[(2 +
    2*Sum[Quotient[(x - 1), s] - Quotient[x, s], {s, 1, Sqrt[x]}]), x]
NXT[p_] :=
    fl[fl[p] + 1 + Sum[Product[G[f[j]], {j, fl[p] + 1, k}], {k, fl[p] + 1, M}]]
p = fl[1]
5
While[p < fl[M], (Print[NXT[p], " ", PrimeQ[NXT[p]]]; p = NXT[p])]
31   True
347  True
733  True
6863 True
15629 True
19687 True
68925 False

```

It happens the same thing with the last value.

Example 3:

```
M = 125
125
f[n_] := n^2 + 1
f1[p_] := Sqrt[p - 1]
G[x_] := -Quotient[(2 +
  2*Sum[Quotient[(x - 1), s] - Quotient[x, s], {s, 1, Sqrt[x]}]), x]
NXT[p_] :=
  f[f1[p] + 1 + Sum[Product[G[f[j]], {j, f1[p] + 1, k}], {k, f1[p] + 1, M}]]
p = f[1]
2
While[p < f[M], (Print[NXT[p], " ", PrimeQ[NXT[p]]]; p = NXT[p])]
5      True
17     True
37     True
101    True
197    True
257    True
401    True
577    True
677    True
1297   True
1601   True
2917   True
3137   True
4357   True
5477   True
7057   True
8101   True
8837   True
12101  True
13457  True
14401  True
15377  True
15877  True
```

Except at most the last one, all the values obtained by the algorithm are correct.

REFERENCES:

- [1] Sebastián Martín Ruiz, *A functional recurrence to obtain the prime numbers using the Smarandache prime function*. Smarandache Notions Journal Vol.11 page 56 (2000)
- [2] Sebastián Martín Ruiz, *Formula to obtain the next prime in an arithmetic progression*. <http://www.gallup.unm.edu/~Smarandache/SMRuiz-nextprime.pdf>
- [3] Carlos Rivera The prime Puzzles & Problems Connection. Problem 38.
www.primepuzzles.net
- [4] E. Burton. *Smarandache Prime and Coprime functions*.
www.gallup.unm.edu/~smarandache/primfnc.txt

Smarandache Non-Associative (SNA-) rings

*W.B. Vasantha Kandasamy
Department of Mathematics
Indian Institute of Technology
Chennai-600036*

In this paper we introduce the concept of Smarandache non-associative rings, which we shortly denote as SNA-rings as derived from the general definition of a Smarandache Structure (i.e., a set A embedded with a weak structure W such that a proper subset B in A is embedded with a stronger structure S). Till date the concept of SNA-rings are not studied or introduced in the Smarandache algebraic literature. The only non-associative structures found in Smarandache algebraic notions so far are Smarandache groupoids and Smarandache loops introduced in 2001 and 2002. But they are algebraic structures with only a single binary operation defined on them that is non-associative. But SNA-rings are non-associative structures on which are defined two binary operations one associative and other being non-associative and addition distributes over multiplication both from the right and left. Further to understand the concept of SNA-rings one should be well versed with the concept of group rings, semigroup rings, loop rings and groupoid rings. The notion of groupoid rings is new and has been introduced in this paper. This concept of groupoid rings can alone provide examples of SNA-rings without unit since all other rings happens to be either associative or non-associative rings with unit. We define SNA subrings, SNA ideals, SNA Moufang rings, SNA Bol rings, SNA commutative rings, SNA non-commutative rings and SNA alternative rings. Examples are given of each of these structures and some open problems are suggested at the end.

Keywords: Non-associative ring, groupoid ring, group ring, loop ring, semigroup ring, SNA-rings SNA subrings, SNA ideals, SNA Moufang rings, SNA Bol rings, SNA commutative rings, SNA non-commutative rings and SNA alternative rings.

This paper has 5 sections. In the first section we just recall briefly the definition of non-associative rings and groupoid rings. In section 2 we define SNA-rings and give examples. Section 3 is devoted to the study of the two substructures of the SNA-rings and obtaining some interesting results about them. The study of rings satisfying identities happens to be a very important concept in the case of non-associative structures. So in this section we introduce several identities on SNA-rings and study them. The final section is devoted to some research problems, which alone can attract students and researchers towards the subject.

1. Preliminaries

This section is completely devoted to recollection of some definitions and results so as to make this paper self-contained.

Definition : A ring $(R, +, \circ)$ is said to be a non-associative ring if $(R, +)$ is an additive abelian group, (R, \circ) is a non-associative semigroup (that is the binary operation \circ on R is non-associative) such that the distributive laws

$a \circ (b + c) = a \circ b + a \circ c$ and $(a + b) \circ c = a \circ c + b \circ c$ for all $a, b, c \in R$ are satisfied.

Definition : Let R be a commutative ring with one. G any group (S any semigroup with unit) RG (RS the semigroup ring of the semigroup S over the ring R) the group ring of

the group G over the ring R consists of finite formal sums of the form $\sum_{i=1}^n \alpha_i g_i$ ($n < \infty$)

that is i runs over a finite number where $\alpha_i \in R$ and $g_i \in G$ ($g_i \in S$) satisfying the following conditions

- i. $\sum_{i=1}^n \alpha_i m_i = \sum_{i=1}^n \beta_i m_i \Leftrightarrow \alpha_i = \beta_i$ for $i = 1, 2, \dots, n$.
- ii. $\sum_{i=1}^n \alpha_i m_i + \sum_{i=1}^n \beta_i m_i \Leftrightarrow \sum_{i=1}^n (\alpha_i + \beta_i) m_i$
- iii. $\left(\sum_{i=1}^n \alpha_i m_i \right) \left(\sum_{i=1}^n \beta_i m_i \right) = \sum \gamma_k m_k$, $m_k = m_i m_j$ where $\gamma_k = \sum \alpha_i \beta_j$
- iv. $r_i m_i = m_i r_i$ for all $r_i \in R$ and $m_i \in G$ ($m_i \in S$).
- v. $r \sum_{i=1}^n r_i m_i = \sum_{i=1}^n (r r_i) m_i$ for all $r \in R$ and $\sum r_i m_i \in RG$. RG is an associative ring with $0 \in R$ acts as its additive identity. Since $I \in R$ we have $G = I \cdot G \subseteq RG$ and $R \cdot e = R \subseteq RG$ where e is the identity element of G .

For more about group rings and semigroup rings please refer [4, 7, 10]. If we replace the group G in the above definition by a loop L we get RL the loop ring which will satisfy all the 5 conditions (i) to (v) given in definition. But RL will only be a non-associative ring as $I \in R$ and $e \in L$ we have $R \subseteq RL$ and $L \subseteq RL$. Any loop ring RL is an example of a non-associative ring with unit. For more about loop rings please refer [1, 3, 6, 8, 9] and about loops and groupoids refer [1, 2]. Now we define groupoid rings. Groupoid rings though not found in any literature to the best of our knowledge can be defined for any commutative ring R with identity 1. For G any groupoid the groupoid ring RG is the groupoid G over the ring R consists of all finite formal sums of the form $\sum_i r_i g_i$ (i running over finite integer) $r_i \in R$ and $g_i \in G$ satisfying the conditions i to v given in the definition of group rings. But a groupoid ring is a non-associative ring as G is non-associative. Clearly $IG \subset RG$ but $R \not\subset RG$ in general for the groupoid G may or

may not contain the identity element in it. Thus only when the groupoid G has the identity element 1 we say the groupoid ring RG to be a non-associative ring with unit. Here we give examples of a non-associative ring without unit.

Example 1.1: Let Z be the ring of integers and L be a loop given by the following table:

*	1	a_1	a_2	a_3	a_4	a_5
1	1	a_1	a_2	a_3	a_4	a_5
a_1	a_1	1	a_3	a_5	a_2	a_4
a_2	a_2	a_5	1	a_4	a_1	a_3
a_3	a_3	a_4	a_1	1	a_5	a_2
a_4	a_4	a_3	a_5	a_2	1	a_1
a_5	a_5	a_2	a_4	a_1	a_3	e

Clearly the loop ring ZL is a non-associative ring with unit.

Example 1.2: Let Z be the ring of integers and $(G, *)$ be the groupoid given by the following table:

*	a_0	a_1	a_2	a_3	a_4
a_0	a_0	a_2	a_4	a_1	a_3
a_1	a_1	a_3	a_0	a_2	a_4
a_2	a_2	a_4	a_1	a_3	a_0
a_3	a_3	a_0	a_2	a_4	a_1
a_4	a_4	a_1	a_3	a_0	a_2

Clearly $(G, *)$ is a groupoid and $(G, *)$ has no identity element. The groupoid ring ZG is a non-associative ring without unit element.

For more about groupoids, loops, loop ring, group ring, semigroup rings, please refer [1-10].

Result: All loop rings RL of a loop L over the ring R are non-associative rings with unit. The smallest non-associative ring without unit is of order 8 given by the following example.

Example 1.3: Let $Z_2 = \{0, 1\}$ be the prime field of characteristic 2. $(G, *)$ be a groupoid of order 3 given by the following table:

*	g_1	g_2	g_3
g_1	g_1	g_2	g_4
g_2	g_4	g_1	g_2
g_3	g_2	g_4	g_1

Z_2G is the groupoid ring having only 8 elements given by $\{0, g_1, g_2, g_3, g_1 + g_2, g_2 + g_3, g_1 + g_3, g_1 + g_2 + g_3\}$. Clearly, Z_2G is a non-associative ring without unit. This is the smallest non-associative ring without unit known to us.

2. SNA-rings with Examples

Here we introduce the notion of SNA-rings and illustrate them with examples.

Definition 2.1: Let S be a non-associative ring. S is said to be a SNA-ring if S contains a proper subset P such that P is an associative ring under the operations of S .

Example 2.1: Let Z be the ring of integers and L be the loop given by the following table. ZL the loop ring of the loop L over the ring Z is a SNA-ring.

*	e	a ₁	a ₂	a ₃	a ₄	a ₅	a ₆	a ₇
e	e	a ₁	a ₂	a ₃	a ₄	a ₅	a ₆	a ₇
a ₁	a ₁	e	a ₅	a ₂	a ₆	a ₃	a ₇	a ₄
a ₂	a ₂	a ₅	e	a ₆	a ₃	a ₇	a ₄	a ₁
a ₃	a ₃	a ₂	a ₆	e	a ₇	a ₄	a ₁	a ₅
a ₄	a ₄	a ₆	a ₃	a ₇	e	a ₁	a ₅	a ₂
a ₅	a ₅	a ₃	a ₇	a ₄	a ₁	e	a ₂	a ₆
a ₆	a ₆	a ₇	a ₄	a ₁	a ₅	a ₂	e	a ₃
a ₇	a ₇	a ₄	a ₁	a ₅	a ₂	a ₆	a ₃	e

For $Z, e = Z \subseteq ZL$. Z is a proper subset of ZL , which is an associative ring. Further if $H_i = \langle e, a_i \rangle$ is the cyclic group generated by a_i ; for $i = 1, 2, 3, \dots, 7$. Clearly $ZH_i \subseteq ZL$ is the group ring of the group H_i over Z which is a proper subset of ZL . So ZL is a SNA-ring leading as to enunciate the following interesting theorem.

Theorem 2.2: Let L be a loop and R any ring. The loop ring RL is always a SNA-ring.

Proof: Clearly by the very definition of the loop ring RL we have $RI \subseteq RL$ so the ring R serves a non-empty proper subset, which is an associative ring. Hence the claim.

Example 2.2: Let R be the reals, $(G, *)$ be the groupoid given by the following table:

*	0	1	2	3
0	0	3	2	1
1	2	1	0	3
2	0	3	2	1
3	2	1	0	3

RG is a non-associative ring which is a SNA-ring as $R \langle 2 \rangle$ is an associative ring which is a proper subset of RG as this SNA-ring has no unit element. Thus it is a Smarandache non-associative ring without unit. When we take $0 \in G$ we assume $r0 \neq 0$ for all non-zero $r \in R$ and $0g = 0$ for all $g \in G$.

Example 2.3: Let Z be the ring of integers. $(G, *)$ be a groupoid given by the following table:

*	0	1	2	3	4	5
0	0	4	2	0	4	2
1	2	0	4	2	0	4
2	4	2	0	4	2	0
3	0	4	2	0	4	2
4	2	0	4	2	0	4
5	4	2	0	4	2	0

Consider the groupoid ring ZG , this has no identity but ZG is a non-associative ring, which has a proper subset ZH , where $H = \{0, 3\}$ is a semigroup so ZH is an associative ring. Thus ZG is a SNA-ring.

Example 2.4: Let Q be the field of rationals. $(G, *)$ be the groupoid with unit element e given by the following table:

*	e	0	1	2	3	4
e	e	0	1	2	3	4
0	0	e	1	2	3	4
1	1	2	e	4	0	1
2	2	4	0	e	2	3
3	3	1	2	3	e	0
4	4	3	4	0	1	e

Clearly the groupoid ring QG is a SNA-ring $Q \cdot e = Q \subseteq QG$ where Q is the associative ring. Further QG is a SNA-ring with unit. Now in view of these examples we obtain the following results.

Theorem 2.3: Let R be any ring and G a groupoid with identity. Then the groupoid ring RG is a SNA-ring.

Proof: Obvious from the fact that identity element exists in G so $R \cdot I = R \subseteq RG$ so R serves as the associative ring to make RG a SNA ring with unit.

Theorem 2.4: Let R be a ring if G is a Smarandache groupoid then the groupoid ring RG is a SNA-ring.

Proof: Clearly the groupoid ring RG is a non-associative ring. Given G is a Smarandache groupoid; so by definition of Smarandache groupoid G contains non-empty subset P of G such that P is a semigroup. RP is a semigroup ring of the semigroup P over the ring R , so that RP is an associative ring, which is a proper subset of RG . Thus RG is a SNA-ring.

3. Substructures of SNA-rings

In this section we introduce the two substructures viz. SNA subrings and SNA ideals.

Definition 3.1: Let R be a non-associative ring. A non-empty subset S of R is said to be a SNA subring of R if S contains a proper subset P such that P is an associative ring under the operations of R .

Now we have got two nice results about these SNA subrings, which are enunciated as theorem.

Theorem 3.2: Let R be a non-associative ring; if R has a SNA subring then R is a SNA subring.

Proof: Given R is a non-associative ring such that R contains a proper subset S which is a SNA subring that is S contains a proper subset P which is an associative ring. Now $P \subset S$ and $S \subset R$ so $P \subset R$ that is R has a proper subset P that is an associative ring. Hence R is a SNA-ring.

To prove the next theorem we consider the following example.

Example 3.1: Let Z be the ring of integers $(G, *)$ be the groupoid given in example 2.3. Clearly the groupoid ring ZG is a non-associative ring. Now consider the subset $P = \{0, 2, 4\}$ P is a sub groupoid of G so ZP is also a groupoid ring, which is non-associative and ZP is a subring of ZG . Clearly ZP is not an associative subring. So in view of theorem 3.2 we can say if R is a SNA-ring and has a subring which is not a SNA subring of R .

This leads us to the following theorem.

Theorem 3.3: Let R be a SNA-ring. Every subring of R need not in general be a SNA subring of R .

Proof: From example 3.1 we see that ZH where H is generated by $\{0, 2, 4\}$ is a subring of R as it has no proper subset, which is a non-associative ring. So ZH is a subring, which is not a SNA subring of R .

Now we proceed on to define SNA ideal.

Definition 3.4: Let R be any non-associative ring. A proper subset I of R is said to be a SNA right/left ideal of R if

1. I is a SNA subring of R ; say $J \subset I$, J is a proper subset of I which is an associative subring under the operations of R .
2. For all $i \in I$ and $j \in J$ we have either ij or ji is in J

If I is simultaneously both a SNA right ideal and SNA left ideal then we say I is a SNA ideal of R .

Example 3.2. Let Z be the ring of integers $(G, *)$ be a groupoid of order 8 given by the following table:

*	0	1	2	3	4	5	6	7
0	0	6	4	2	0	6	4	2
1	3	1	7	5	3	1	7	5
2	6	4	2	0	6	4	2	0
3	1	7	5	3	1	7	5	3
4	4	2	0	6	4	2	0	6
5	7	5	3	1	7	5	3	1
6	2	0	6	4	2	0	6	4
7	5	3	1	7	5	3	1	7

Clearly ZG is a SNA-ring as $H = \{2\}$ is a semigroup. The semigroup ring ZH is a non-empty proper subset, which is an associative ring. Clearly $I = Z\langle 0, 2, 4, 6 \rangle$ is a SNA ideal of ZG . It is easily verified that $I = Z\langle 0, 2, 4, 6 \rangle$ is not an ideal of ZG . Similarly we see $I_1 = Z\langle 1, 3, 5, 7 \rangle$ is also a SNA ideal of ZG , which is not an ideal of ZG . Consequent of this example and the definition of SNA ideals we have following two theorems.

Theorem 3.5. Let R be any non-associative ring. If R has a SNA ideal then R is a SNA-ring.

Proof: Obvious from the fact that if R has a SNA ideal say I then we have proper subset $J \subset I$ such that J is a SNA subring of R . So by theorem 3.3 R is a SNA-ring.

Theorem 3.6: Let R be any non-associative ring. I be a SNA ideal of R . Then I in general need not be an ideal of R .

Proof: By an example. Consider the non-associative ring given in example 3.2. Clearly $Z\langle 0, 2, 4, 6 \rangle$ is a SNA ideal of ZG but $Z\langle 0, 2, 4, 6 \rangle$ is not an ideal of ZG as $3[Z\langle 0, 2, 4, 6 \rangle] = Z\langle 1, 3, 5, 7 \rangle$. Clearly $Z\langle 0, 2, 4, 6 \rangle \neq Z\langle 1, 3, 5, 7 \rangle$ in fact they are disjoint sets. Hence the claim.

Example 3.3: Let Z be the ring of integers. $(G, *)$ be as given in example 2.3. Clearly $Z\langle 0, 2, 4 \rangle$ is an ideal of ZG but $Z\langle 0, 2, 4 \rangle$ is not a SNA ideal of ZG as $Z\langle 0, 2, 4 \rangle$ has no proper subset P such that P is an associative subring of $Z\langle 0, 2, 4 \rangle$. Hence the claim.

4. SNA-rings satisfying certain identities

In this section we define SNA-rings satisfying certain classical identities like Bol, Moufang etc. and obtain some interesting results relating to the loop rings of the loop and groupoid rings of the groupoid. We give examples of them to make it explicit.

Definition 4.1: Let R be a non-associative ring we say R is a SNA Moufang ring if R contains a subring S where S is a SNA subring and for all x, y, z in S we have $(x * y) * (z * x) = (x * (y * z)) * x$, that is the Moufang identity to be true in S .

Examples 4.1. Let Z be the ring of integers and let $(L, .)$ be the loop given by the following example:

0	e	g ₁	g ₂	g ₃	g ₄	g ₅
e	e	g ₁	g ₂	g ₃	g ₄	g ₅
g ₁	g ₁	e	g ₃	g ₅	g ₂	g ₄
g ₂	g ₂	g ₅	e	g ₄	g ₁	g ₃
g ₃	g ₃	g ₄	g ₁	e	g ₅	g ₂
g ₄	g ₄	g ₃	g ₅	g ₂	e	g ₁
g ₅	g ₅	g ₂	g ₄	g ₁	g ₃	e

Clearly L is not a Moufang loop. Consider the loop ring ZL . ZL is a non-associative which is a SNA-ring. Clearly L is not a Moufang loop. But ZL is a SNA-Moufang ring as $Z\langle e, g_1 \rangle$ is a proper subset of ZL such that $Z \subseteq Z\langle e, g_1 \rangle$ is an associative subring of $Z\langle e, g_1 \rangle$. Now it is easily verified $Z\langle e, g_1 \rangle$ satisfies the Moufang identity for every $x, y, z \in Z\langle e, g_1 \rangle$.

Example 4.2: Let Z be the ring of integers $(G, *)$ be the groupoid given by the following table:

*	0	1	2	3	4	5
0	0	4	2	0	4	2
1	3	1	5	3	1	5
2	0	4	2	0	4	2
3	3	1	5	3	1	5
4	0	4	2	0	4	2
5	3	1	5	3	1	5

ZG is the groupoid ring of G over Z . Clearly, every subring of ZG satisfies Moufang identity as every element of ZG satisfies Moufang identity, in fact ZG is a non-associative ring, which satisfies Moufang identity so ZG is a SNA-ring. Here it has

become important to say that one needs to define such rings as these rings have not been found any place in literature.

Definition 4.2. A non-associative ring R is said to be a Moufang ring if the Moufang identity, $(x * y) * (z * x) = (x * (y * z)) * x$ is satisfied for all $x, y, z \in R$.

In view of this we have the following interesting result.

Theorem 4.3: If R is a Moufang ring and if R is a SNA-ring Then R is a SNA Moufang ring.

Proof: By the very definition used in this paper.

Definition 4.4: Let R be a non-associative ring R is said to a Bol ring if R satisfies the Bol identity $((x * y) * z) * y = x * ((y * z) * y)$ for all x, y, z in R .

Trivially all associative rings satisfy Bol identity hence we take only non-associative rings.

Definition 4.5: Let R be a non-associative ring. R is said to be a SNA Bol ring if R contains a subring $S \subset R$ such that S is a SNA subring of R and we have the Bol identity $((x * y) * z) * y = x * ((y * z) * y)$ to be true for all x, y, z in S .

In view of this we have the following theorem.

Theorem 4.6: Let R be a non-associative ring, which is a Bol ring .If R , is also a SNA-ring then R is a SNA Bol ring.

Proof: Clear from the very definitions given in this paper.

Example 4.3: Let Z be the ring of integers, L be the loop given by the following table:

*	e	1	2	3	4	5	6	7
e	e	1	2	3	4	5	6	7
1	1	e	5	2	6	3	7	4
2	2	5	e	6	3	7	4	1
3	3	2	6	e	7	4	1	3
4	4	6	3	7	e	1	5	2
5	5	3	7	4	1	e	2	6
6	6	7	4	1	5	2	e	3
7	7	4	1	5	2	6	3	e

Clearly this loop is not a Bol loop so the loop ring ZL is not a Bol ring. But this loop ring ZL is a SNA Bol ring as $Z \subseteq Z(e, 5) \subset ZL$ is a SNA Bol ring.

In view of this we have the following theorem.

Theorem 4.7: If R is a non-associative ring which is a SNA Bol ring R need not in general be a Bol ring.

Proof: Using the very definition and the example 4.3 we get the result.

Definition 4.8: Let R be any non-associative ring, R is said to be a right alternative ring if $(xy)y = x(yy)$ for all $x, y \in R$. Similarly R is said to be left alternative ring if $(xx)y = x(xy)$ for all $x, y \in R$. Finally we say R is an alternative ring if it is simultaneously both right alternative and left alternative.

Example 4.4: Let Z be the ring of integers and L be a loop given by the following table:

*	e	g ₁	g ₂	g ₃	g ₄	g ₅
e	e	g ₁	g ₂	g ₃	g ₄	g ₅
g ₁	g ₁	e	g ₃	g ₅	g ₂	g ₄
g ₂	g ₂	g ₅	e	g ₄	g ₁	g ₃
g ₃	g ₃	g ₄	g ₁	e	g ₅	g ₂
g ₄	g ₄	g ₃	g ₅	g ₂	e	g ₁
g ₅	g ₅	g ₂	g ₄	g ₁	g ₃	e

The loop ring ZL is a right alternative ring as the loop L itself a right alternative loop.

Example 4.5: Let Z be the ring of integers and L be a loop given by the following table:

*	e	1	2	3	4	5
e	e	1	2	3	4	5
1	1	e	5	4	3	2
2	2	3	e	1	5	4
3	3	5	4	e	2	1
4	4	2	1	5	e	3
5	5	4	3	2	1	e

Consider the loop ring ZL , it is easily verified that ZL is a left alternative ring as the loop L is left alternative. In view of this we have the following results, which will be stated after defining the concept of SNA alternative rings.

Definition 4.9: Let R be a ring, R is said to be SNA right alternative ring if R has a subring S such that S is a SNA subring of R and S is a right alternative ring that is $(xy)y = x(yy)$ is true for all $x, y \in S$. Similarly we define SNA left alternative ring. If R is simultaneously both SNA right alternative ring and SNA left alternative then we say R is a SNA alternative ring.

Example 4.6: Let Z be the ring of integers. $(G, *)$ be the groupoid given by the following table:

*	0	1	2	3	4	5
0	0	3	0	3	0	3
1	4	1	4	1	4	1
2	2	5	2	5	2	5
3	3	0	3	0	3	0
4	4	1	4	1	4	1
5	2	5	2	5	2	5

The groupoid ring ZG is a SNA-ring. Further, we have ZG to be an alternative ring as well as a SNA alternative ring.

Definition 4.10: Let R be non-associative ring. R is said to be a SNA commutative ring if R has a subring S such that a proper subset P of S is a commutative associative ring with respect to the operations of R .

Note: Even if R is non-commutative, still R can be a SNA commutative ring. Further we see trivially all commutative non-associative rings R will be SNA commutative rings. We say R is a SNA non-commutative ring if R has no SNA commutative subring.

Example 4.7: Let Z be the ring of integers and L be a loop given by the following table:

*	e	1	2	3	4	5
e	e	1	2	3	4	5
1	1	e	3	5	2	4
2	2	5	e	4	1	3
3	3	4	1	e	5	2
4	4	3	5	2	e	1
5	5	2	4	1	3	e

The loop ring ZL is a non-associative ring. Clearly ZL is also a SNA commutative ring. As $Z \subset Z(e, 3) \subset ZL$. $Z(e, 3)$ is a SNA subring of ZL , which has a proper subset Z , Z is an associative commutative subring of ZL . Thus we ZL is non commutative but ZL is a SNA commutative ring.

Example 4.8: Let Z be the ring of integers $(G, *)$ be a groupoid given by the following table:

*	0	1	2	3	4	5
0	0	5	4	3	2	1
1	2	1	0	5	4	3
2	4	3	2	1	0	5
3	0	5	4	3	2	1
4	2	1	0	5	4	3
5	4	3	2	1	0	5

Consider the groupoid ring ZG . Clearly ZG is non-associative non-commutative ring. But ZG is a SNA commutative ring as $Z\langle 3 \rangle \subseteq Z\langle 0, 3 \rangle \subset ZG$. Clearly ZG is non-commutative but ZG is SNA commutative ring. Hence the claim.

5. Problems:

This section is completely devoted to some open problems some may be easy and some of them may be difficult.

Problem 1: Find the smallest non-associative ring. (By smallest we mean the number of elements in them that is order is the least that is we cannot find any other non-associative ring of lesser order than that).

Problem 2: Is the smallest non-associative ring a SNA-ring?

Problem 3: Find SNA-ring of least order.

Problem 4: Can on Z_n be defined two binary operations so that Z_n is non-associative ($n < \infty$)?

Problem 5: Find the smallest SNA-ring, which is a SNA Bol ring.

Problem 6: Does their exist SNA-rings other than the ones got from

1. loop rings,
2. groupoid rings

Problem 7: Find a SNA-ring R in which every ideal of R is a SNA ideal of R .

Problem 8: Find conditions on the ring R so that every subring of R is a SNA subring of R .

Problem 9: Characterize the SNA-rings R which has ideals but none of them are SNA ideals of R .

Problem 10: Characterize those ring R in a SNA-ring which has subrings but none of the subrings in R are SNA subrings of R .

References

- [1] R. H. Bruck, Contributions to the theory of loops, Trans. Amer. Math. Soc., Vol. 60, 245 – 354, (1946).

- [2] R. H. Bruck, A survey of binary systems, Springer Verlag, (1958).
- [3] O. Chein and E. Goodaire, Loops whose loop rings are alternative, Communications in Algebra, Vol. 18(3), 659 – 668, (1990).
- [4] D.S.Passman, The algebraic structure of group rings, Wiley-Interscience, (1977).
- [5] W. B. Vasantha Kandasamy, On ordered groupoids and groupoid rings, J. of Maths. and Comp. Sci., Vol. 9, 145-147, (1996).
- [6] W. B. Vasantha Kandasamy, Loop algebras of Moufang loops, Math. Forum, Vol.XI, 21-25, (1997).
- [7] W. B. Vasantha Kandasamy, Semigroup rings which are Chinese rings, J. of Math. Research & Exposition, Vol.13, 375 – 376, (1993).
- [8] W. B. Vasantha Kandasamy, On loops rings which are Marot loop rings, Ultra Scientist Phys. Sci., 126 – 128, (1996).
- [9] W. B. Vasantha Kandasamy, On a new class of Jordan loops and their loop rings, J. Bihar Math. Soc. 71 – 75, (1999).
- [10]. W. B. Vasantha Kandasamy, On semigroup rings which satisfy $(xy)^n = x.y$, J. of Bihar Math. Soc. , Vol. 14, 47 – 50, (1995).
- [11]. W. B. Vasantha Kandasamy, Smarandache loops, www.gallup.unm.edu/~smarandache/Loops.pdf
- [12]. W. B. Vasantha Kandasamy, Smarandache groupoids, www.gallup.unm.edu/~smarandache/Groupoids.pdf

SMARANDACHE PSEUDO- IDEALS

W. B. Vasantha Kandasamy
Department of Mathematics
Indian Institute of Technology, Madras
Chennai - 600 036, India.
E- mail : vasantak@md3.vsnl.net.in

Abstract

In this paper we define Smarandache pseudo- ideals of a Smarandache ring. We prove every ideal is a Smarandache pseudo-ideal in a Smarandache ring but every Smarandache pseudo-ideal in general is not an ideal. Further we show that every polynomial ring over a field and group rings FG of the group G over any field are Smarandache rings. We pose some interesting problems about them.

Keywords:

Smarandache pseudo-right ideal, Smarandache pseudo-left ideal, Smarandache pseudo-ideal.

Definition [1]: A Smarandache ring is defined to be a ring A such that a proper subset of A is a field (with respect to the same induced operation). Any proper subset we understand a set included in A , different from the empty set, from the unit element if any, and from A .

For more about Smarandache Ring and other algebraic concepts used in this paper please refer [1], [2], [3] and [4].

Definition 1 Let $(A, +, \bullet)$ be a Smarandache ring. B be a proper subset of A ($B \subset A$) which is a field. A nonempty subset S of A is said to be a Smarandache pseudo-right ideal of A related to B if

1. $(S, +)$ is an additive abelian group.
2. For $b \in B$ and $s \in S$, $s \bullet b \in S$.

On similar lines we define Smarandache pseudo-left ideal related to B . S is said to be a Smarandache pseudo-ideal (S -pseudo-ideal) related to B if S is both a Smarandache pseudo-right ideal and Smarandache pseudo-left ideal related to B .

Note: It is important and interesting to note that the phrase "related to B " is important for if the field B is changed to B' the same S may not in general be S -pseudo-ideal related to B' also. Thus the S -pseudo-ideals are different from usual ideal defined on a ring. Further we define S -pseudo-ideal only when the ring itself is a Smarandache ring. Otherwise we don't define them to be S -pseudo-ideal. Throughout this paper unless notified $F[x]$ or $R[x]$ will be polynomial of all degrees, $n \rightarrow \infty$.

Theorem 2 Let F be a field. $F[x]$ be a polynomial ring in the variable x . $F[x]$ is a Smarandache ring.

Proof: Clearly $F \subset F[x]$ is a field which is a proper subset of $F[x]$, so $F[x]$ is a Smarandache ring.

If F is a commutative ring then we have the following:

Theorem 3 Let $R[x]$ be a polynomial ring. R be a commutative ring. $R[x]$ is a Smarandache ring if and only if R is a Smarandache Ring.

Proof: If R is a Smarandache ring clearly there exists a proper subset S of R which is a field. So $R[x]$ is a Smarandache ring.

Conversely if $R[x]$ is a Smarandache ring we have $S \subset R$ such that S is a field. So R must be a Smarandache ring. Since $R[x] = \left\{ \sum_{i=0}^{\infty} r_i x^i \mid r_i \in R \right\}$. $R[x]$ cannot contain any polynomial which has inverse. Hence the claim.

Example 1: Let $Q[x]$ be the polynomial ring over the rationals. Clearly $Q[x]$ is a Smarandache ring. Consider $S = \langle n(x^2 + 1)/n \in Q \rangle$ is generated under '+'. Clearly $QS \subseteq S$ and $SQ \subseteq S$. So S is a S -pseudo-ideal of $Q[x]$ related to Q .

Theorem 4 Let R be any Smarandache ring. Any ideal of R is a S -pseudo-ideal of R related to some subfield of R but in general every S -pseudo-ideal of R need not be an ideal of R .

Proof: Given R is a Smarandache ring. So $\phi \neq B$, $B \subset R$ is a field. Now I is an ideal of R . So $IR \subseteq I$ and $RI \subseteq I$. Since $B \subset R$ we have $BI \subseteq I$ and $IB \subseteq I$. Hence I is a S -pseudo-ideal related to B .

To prove the converse, consider the Smarandache ring given in Example 1. S is a S -pseudo-ideal but S is not an ideal of $Q[x]$ as xS is not contained in S . Hence the claim.

Example 2: Let \mathfrak{R} be the field of reals. $\mathfrak{R}[x]$ be the polynomial ring. Clearly $\mathfrak{R}[x]$ is a Smarandache ring. Now $Q \subset \mathfrak{R}[x]$ and $\mathfrak{R} \subset \mathfrak{R}[x]$ are fields contained in $\mathfrak{R}[x]$. Consider $S = \langle n(x^2 + 1)/n \in Q \rangle$ generated additively as a group. Now S is a S -pseudo-ideal relative to Q but S is not a S -pseudo-ideal related to \mathfrak{R} . Thus this leads us to the following result.

Theorem 5 Let R be a Smarandache ring. Suppose A and B are two subfields of R . S be a S -pseudo-ideal related to A . S need not in general be a S -pseudo-ideal related to B .

Proof: The example 2 is an illustration of the above theorem.

Based on these properties we propose the following problems:

Problem 1 Find conditions on the Smarandache ring so that a S-pseudo-ideal which are not ideals of the ring related with every field is a S-pseudo-ideal irrelevant of the field under consideration.

Problem 2 Find conditions on the Smarandache ring so that every S-pseudo-ideal is an ideal.

Example 3 $Z_{12} = \{0, 1, 2, 3, \dots, 11\}$ be the ring. Clearly Z_{12} is a Smarandache ring for $A = \{0, 4, 8\}$ is a field in Z_{12} with $4^2 = 4 \pmod{12}$ acting as the multiplicative identity. Now $S = \{0, 6\}$ is a S-pseudo-ideal related to A . But S is also an ideal of Z_{12} . Every ideal of Z_{12} is also a S-pseudo-ideal of Z_{12} related to A .

Problem 3 Find conditions on n for Z_n (n not a prime) to have all S-pseudo-ideals to be ideals.

Example 4 Let $M_{2 \times 2}$ be the set of all 2×2 matrices with entries from the prime field $Z_2 = \{0, 1\}$.

$$M_{2 \times 2} = \left\{ \begin{array}{l} \left(\begin{array}{cc} 0 & 0 \\ 0 & 0 \end{array} \right), \left(\begin{array}{cc} 0 & 1 \\ 0 & 0 \end{array} \right), \left(\begin{array}{cc} 1 & 0 \\ 0 & 0 \end{array} \right), \left(\begin{array}{cc} 0 & 0 \\ 1 & 0 \end{array} \right), \left(\begin{array}{cc} 0 & 0 \\ 0 & 1 \end{array} \right), \left(\begin{array}{cc} 1 & 1 \\ 0 & 0 \end{array} \right), \left(\begin{array}{cc} 0 & 0 \\ 1 & 1 \end{array} \right), \left(\begin{array}{cc} 1 & 0 \\ 1 & 0 \end{array} \right) \\ \left(\begin{array}{cc} 0 & 1 \\ 0 & 1 \end{array} \right), \left(\begin{array}{cc} 1 & 0 \\ 1 & 0 \end{array} \right), \left(\begin{array}{cc} 0 & 1 \\ 1 & 0 \end{array} \right), \left(\begin{array}{cc} 1 & 1 \\ 0 & 1 \end{array} \right), \left(\begin{array}{cc} 1 & 0 \\ 1 & 1 \end{array} \right), \left(\begin{array}{cc} 0 & 1 \\ 1 & 1 \end{array} \right) \text{ and } \left(\begin{array}{cc} 1 & 1 \\ 1 & 1 \end{array} \right) \end{array} \right\} \text{ be the ring of}$$

matrices under usual matrix addition and multiplication modulo 2.

Now $M_{2 \times 2}$ is a Smarandache ring for $A = \left\{ \left(\begin{array}{cc} 0 & 0 \\ 0 & 0 \end{array} \right), \left(\begin{array}{cc} 1 & 0 \\ 0 & 0 \end{array} \right) \right\}$ is a field of $M_{2 \times 2}$. Let $S =$

$\left\{ \left(\begin{array}{cc} 0 & 0 \\ 0 & 0 \end{array} \right), \left(\begin{array}{cc} 1 & 1 \\ 0 & 0 \end{array} \right) \right\}$, S is a Smarandache pseudo-left ideal related to A but S is not a

Smarandache pseudo-right ideal related to A for $\left(\begin{array}{cc} 1 & 1 \\ 0 & 0 \end{array} \right) \times \left(\begin{array}{cc} 1 & 0 \\ 0 & 0 \end{array} \right) = \left(\begin{array}{cc} 1 & 0 \\ 0 & 0 \end{array} \right)$ as $\left(\begin{array}{cc} 1 & 0 \\ 0 & 0 \end{array} \right) \notin$

S . Now $B = \left\{ \left(\begin{array}{cc} 0 & 0 \\ 0 & 0 \end{array} \right), \left(\begin{array}{cc} 0 & 0 \\ 0 & 1 \end{array} \right) \right\}$ is also a field. $S = \left\{ \left(\begin{array}{cc} 0 & 0 \\ 0 & 0 \end{array} \right), \left(\begin{array}{cc} 1 & 1 \\ 0 & 0 \end{array} \right) \right\}$ is a left ideal related

to B but not a right ideal related to B . $C = \left\{ \left(\begin{array}{cc} 0 & 0 \\ 0 & 0 \end{array} \right), \left(\begin{array}{cc} 0 & 0 \\ 1 & 1 \end{array} \right) \right\}$ is a field. Clearly S is not a

Smarandache pseudo-left ideal with respect to C . But S is a Smarandache pseudo-right ideal with respect to C .

Thus from the above example we derive the following observation.

Observation: A set S can be a Smarandache pseudo-left ideal relative to more than one field. For $S = \left\{ \begin{pmatrix} 0 & 0 \\ 0 & 0 \end{pmatrix}, \begin{pmatrix} 1 & 1 \\ 0 & 0 \end{pmatrix} \right\}$ is a Smarandache pseudo-left ideal related to both A and B . The same set S is not a Smarandache pseudo-left ideal with respect to the related field $C = \left\{ \begin{pmatrix} 0 & 0 \\ 0 & 0 \end{pmatrix}, \begin{pmatrix} 0 & 0 \\ 1 & 1 \end{pmatrix} \right\}$ but S is a Smarandache pseudo-right ideal related to C .

Thus the same set S can be Smarandache pseudo left or right ideal depending on the related field. Clearly S is a S-pseudo-ideal related to the field $D = \left\{ \begin{pmatrix} 0 & 0 \\ 0 & 0 \end{pmatrix}, \begin{pmatrix} 1 & 0 \\ 0 & 1 \end{pmatrix} \right\}$.

Definition 6 Let R be a Smarandache ring. I be a S-pseudo-ideal related to A , $A \subset R$ (A a field). I is said to be a Smarandache minimal pseudo-ideal of R if I_1 is another S-pseudo-ideal related to A and $(0) \subseteq I_1 \subseteq I$ implies $I_1 = I$ or $I_1 = (0)$.

Note: The minimality of the ideal may vary in general for different related fields.

Definition 7 Let R be a Smarandache ring. M is said to be a Smarandache maximal pseudo-ideal related to a subfield A , $A \subset R$ if M_1 is another S-pseudo-ideal related to A and if $M \subseteq M_1$ then $M = M_1$.

Definition 8 Let R be a Smarandache ring. A S-pseudo-ideal I related to a field A , $A \subset R$ is said to be a Smarandache cyclic pseudo-ideal related to a field A , if I can be generated by a single element.

Definition 9 Let R be a Smarandache ring. A S-pseudo-ideal I related to a field A , $A \subset R$ is said to be a Smarandache prime pseudo-ideal related to A if $x \cdot y \in I$ implies $x \in I$ or $y \in I$.

Example 5: Let $Z_2 = (0, 1)$ be the prime field of characteristic 2. $Z_2[x]$ be the polynomial ring of all polynomials of degree less than or equal to 3, that is $Z_2[x] = \{0, 1, x, x^2, x^3, 1+x, 1+x^2, 1+x^3, x+x^2, x+x^3, x^2+x^3, 1+x+x^3, 1+x+x^2, 1+x^2+x^3, x+x^2+x^3, 1+x+x^2+x^3\}$. Clearly $Z_2[x]$ is a Smarandache ring as it contains the field Z_2 .

$S = \{0, (1+x), (1+x^3), (x+x^3)\}$ is a S-pseudo-ideal related to Z_2 and not related to $Z_2[x]$.

Example 6: Let $Z_2 = (0,1)$ be the prime field of characteristic 2. $S_3 = \{1, p_1, p_2, p_3, p_4, p_5\}$ be the symmetric group of degree 3. Here $1 = \begin{pmatrix} 1 & 2 & 3 \\ 1 & 2 & 3 \end{pmatrix}$, $p_1 = \begin{pmatrix} 1 & 2 & 3 \\ 1 & 3 & 2 \end{pmatrix}$, $p_2 = \begin{pmatrix} 1 & 2 & 3 \\ 3 & 2 & 1 \end{pmatrix}$, $p_3 = \begin{pmatrix} 1 & 2 & 3 \\ 2 & 1 & 3 \end{pmatrix}$, $p_4 = \begin{pmatrix} 1 & 2 & 3 \\ 2 & 3 & 1 \end{pmatrix}$ and $p_5 = \begin{pmatrix} 1 & 2 & 3 \\ 3 & 1 & 2 \end{pmatrix}$. Z_2S_3 be the group ring of the group S_3 over Z_2 . Z_2S_3 is a Smarandache ring. $Z_2S_3 = \{1, p_1, p_2, p_3, p_4, p_5, 1+p_1, 1+p_2, \dots, p_1+p_2+p_3+p_4+p_5, 1+p_1+p_2+p_3+p_4+p_5\}$. Now $A = \{0, p_4+p_5\}$ is a

field $A \subset Z_2S_3$. Let $S = \{0, 1 + p_1 + p_2 + p_3 + p_4 + p_5\}$ be the subset of Z_2S_3 . S is a S -pseudo-ideal related to A . S is also a S -pseudo-ideal related to Z_2 .

Theorem 10 Let F be a field and G be any group. The group ring FG is a Smarandache ring.

Proof: F is a field and G any group FG the group ring is a Smarandache ring for $F \subset FG$ is a field of the ring FG . Hence the claim.

Theorem 11 Let $Z_2 = \{0,1\}$ be the prime field of characteristic 2. G be a group of finite order say n . Then Z_2G has S -pseudo-ideals, which are ideals of Z_2G .

Proof: Take $Z_2 = \{0, 1\}$ as a field of Z_2G . Let $G = \{g_1, g_2, \dots, g_{n-1}, 1\}$ be the set of all elements of G . Now $S = \{0, (1+g_1 + g_2 + \dots + g_{n-1})\}$ is a S -pseudo-ideal related to Z_2 and S is also an ideal of Z_2G . Hence the claim.

Problem 4 Find conditions on the group G and the ring R so that the group ring RG is a Smarandache ring?

References

- [1] Padilla, Raul. *Smarandache Algebraic Structures*, Bulletin of Pure and Applied Sciences, Delhi, Vol. 17 E., No. 1, 119-121, (1998)
<http://www.gallup.unm.edu/~smarandache/ALG-S-TXT.TXT>
- [2] W.B.Vasantha Kandasamy, *Obedient Ideals in a Finite Ring*, J. Inst. Math. & Comp. Sci., Vol. 8, 217 - 219, (1995).
- [3] W.B.Vasantha Kandasamy, *On ideally strong group rings*, The Mathematics Education, Vol. XXX, 71 - 72, (1996)
- [4] W.B.Vasantha Kandasamy, *On Generalized Semi-ideals of a Group Ring*, The Journal of Qufu Normal University., Vol. 18, No. 4, (1992).

Impulse Gauss Curvatures
2002 SSHE-MA Conference

Howard Iseri
Mansfield University
Department of Mathematics and Computer Information Science
Mansfield PA 16933

Abstract: In Riemannian (differential) geometry, the differences between Euclidean geometry, elliptic geometry, and hyperbolic geometry are understood in terms of curvature. I think Gauss and Riemann captured the essence of geometry in their studies of surfaces and manifolds, and their point of view is spectacularly illuminating. Unfortunately, curvature is highly non-trivial to work with. I will talk about a more accessible version of curvature that dates back to Descartes.

Curvature

The Gauss curvature K is a generalization to surfaces of the curvature κ for curves that is covered in calculus. The curvature for the graph of a function f is closely related to the concavity, and since f'' is the derivative of the slope of the tangent line, the concavity tells us how fast the slope is changing. In other words, it is a measure of how much the curve is curving. The concavity, however, tells us the rate of curvature relative to distances along the x -axis. Therefore, the relationship between concavity and the shape of the curve is distorted. This distortion is eliminated in the curvature by considering the rate at which the unit tangent vector changes direction relative to distances along the curve. Of course, with curvature comes the usually messy arclength parameter ds .

Somewhat surprising is the fact that curvature has a nice geometric interpretation. The curvature of a circle of radius r is $\kappa = 1/r$, and if the curvature at some point of a curve is κ , then a circle of radius $r = 1/\kappa$ will be the best fit circle at that point. For example, at the point $(0,0)$ on the graph of $f(x) = x^2$, the curvature is $\kappa = 2$, which is the same as the curvature for a circle of radius $r = 1/2$ (see Figure 1).

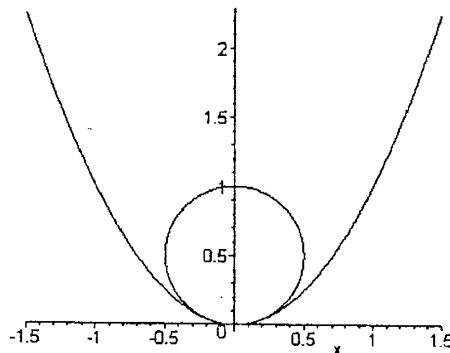

Figure 1. The curvature at $(0,0)$ is $\kappa = 2$ for both the circle and the parabola.

The Gauss curvature at a point on a surface (in \mathbb{R}^3) is the product of the maximum and minimum curvatures relative to a vector normal to the surface. Here, curvature "towards" the normal vector is positive, and curvature "away" is negative. For example, at the point $(0,0,0)$ on the surface $f(x,y) = x^2 - y^2$, there are both positive and negative curvatures relative to the normal vector $K = [0,0,1]$ (see Figure 2). Above the x -axis, we have a parabola with curvature $\kappa_{\max} = +2$ at $(0,0,0)$, and below the y -axis, we have a parabola with curvature κ_{\min}

= -2 at (0,0,0). The Gauss curvature at (0,0,0) is $K = (+2)(-2) = -4$. This surface would have a (non-homogeneous) hyperbolic geometry because of its negative curvature.

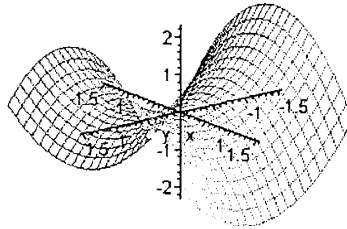

Figure 2. Saddle-shaped surfaces have negative Gauss curvature.

On the other hand, at the point (0,0,0) on the surface $f(x,y) = x^2 + y^2$, the curvatures are $\kappa_{\min} = \kappa_{\max} = +2$ in all directions. Therefore, the Gauss curvature is $K = (+2)(+2) = +4$ (see Figure 3). This surface would have a (non-homogeneous) elliptic geometry because of its positive curvature. Note that if the normal vector points downward, then $K = (-2)(-2) = +4$, so the choice of normal vector does not affect the value of K .

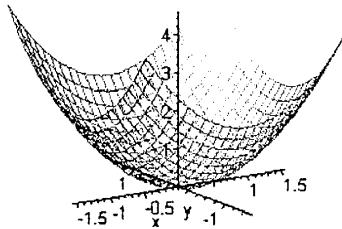

Figure 3. Bowl-shaped surfaces have positive Gauss curvature.

Elliptic and hyperbolic geometry

The Euclidean, hyperbolic, and elliptic plane geometries obtained from variations of Hilbert's axioms (see [4] and [3]) would correspond to surfaces (Riemannian 2-manifolds) with constant Gauss curvature. The xy -plane has constant Gauss curvature $K = 0$. The unit sphere has constant Gauss curvature $K = +1$ (see Figure 4), and a model for the elliptic geometry axioms in Appendix A of [3] can be obtained by identifying antipodal points on the unit sphere. This is sometimes called the projective plane.

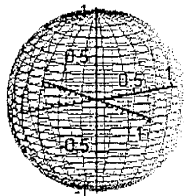

Figure 4. The sphere has constant positive Gauss curvature.

Surfaces with constant negative Gauss curvature are more difficult to construct. The pseudosphere is a surface with constant Gauss curvature $K = -1$ (see Figure 5, which is a graph of the parametric equations $x = \cos u \sin v$, $y = \sin u \sin v$, $z = \ln \tan (v/2) + \cos v$).

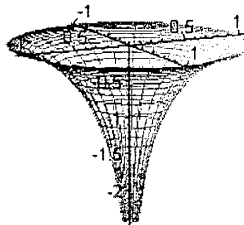

Figure 5. The pseudosphere, has constant negative Gauss curvature.

The pseudosphere has the same local geometry as the hyperbolic plane, but the global geometry is very different (e.g., the pseudosphere has tiny circles with no centers). The hyperbolic plane is generally visualized through a projection like the Poincaré disk (see Figure 6).

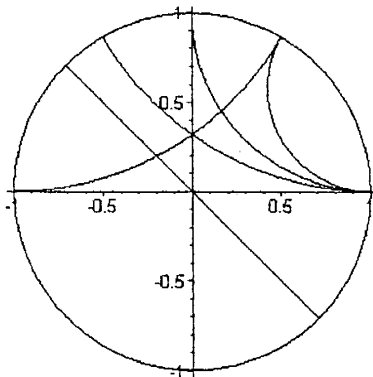

Figure 6. The Poincaré disk is a projection of the hyperbolic plane.

Geometric formulas in the different geometries

One characteristic difference between the three geometries is reflected in the angle sum of a triangle. In Euclidean geometry, the angle sum is 180° . It is smaller than this in hyperbolic geometry and larger in elliptic geometry. In particular for a triangle with area A and angles α , β , and γ , on the unit sphere

$$(1) \quad \alpha + \beta + \gamma = \pi + A,$$

and in the hyperbolic plane

$$(2) \quad \alpha + \beta + \gamma = \pi - A.$$

Similarly, the formula for the circumference of a circle with radius R differs among the geometries. On a surface with $K = -1$,

$$(3) \quad C_h = 2\pi \sinh(R),$$

and with $K = +1$

$$(4) \quad C_e = 2\pi \sin(R).$$

We can see the relationships in the graphs of Figure 7. In the Euclidean plane, the circumference of a circle is directly proportional to the radius. The circumference grows more quickly in the hyperbolic plane, and on the sphere, the circumference grows more slowly, and in fact, decreases for radii greater than $\pi/2$. We can interpret this as saying that the hyperbolic plane spreads out more quickly than the Euclidean plane, and the sphere spreads out more slowly. I think this interpretation is as important as the saddle/bowl characterization of curvature.

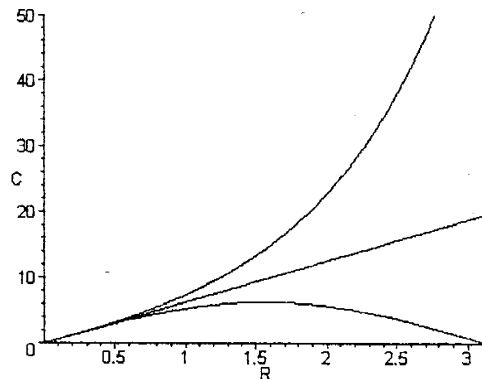

Figure 7. The circumferences of circles of radius R .

Comparisons through projections

The projection of the hyperbolic plane onto the Poincaré disk is such that the deformation of distances is symmetric about the origin. In particular, if a point is a distance r from the origin in the Poincaré disk, then its distance from the origin in the hyperbolic plane R is a function of r . The derivative of R , therefore, describes the relationship between distances in the Poincaré disk and distances in the hyperbolic plane. In particular, the circumference of a circle with radius r centered at the origin will be $2\pi r$ in the Poincaré disk and $2\pi r \{dR/dr\} = 2\pi \sinh(R)$ in the hyperbolic plane. This function R must therefore satisfy the separable differential equation

$$(5) \quad r \, dR/dr = \sinh(R),$$

and modulo a constant multiple, we must have

$$(6) \quad R = 2 \tanh^{-1} r = \ln((1+r)/(1-r))$$

or

$$(7) \quad r = \tanh(R/2).$$

It seems, therefore, that the Poincaré disk is the only Euclidean model that has a rotationally symmetric metric.

Since the circumference formula for a circle in elliptic geometry is similar to the formula in hyperbolic geometry, we can look for a rotationally symmetric metric for elliptic geometry. On a surface with constant curvature $K = +1$, the circumference of a circle of radius R is $C_e = 2\pi \sin(R)$. The differential equation resembles equation (5),

$$(8) \quad r \, dR/dr = \sin(R),$$

and so

$$(9) \quad R = 2 \tan^{-1} r$$

or

$$(10) \quad r = \tan(R/2).$$

This corresponds essentially to stereographic projection, so we see that stereographic projection and projection onto the Poincaré disk are comparable objects. In fact, stereographic projection restricted to the projective plane maps onto the unit disk (see Figure 8). Note that under this projection, antipodal points on the boundary of the unit disk are identified, so the lines shown are actually closed curves.

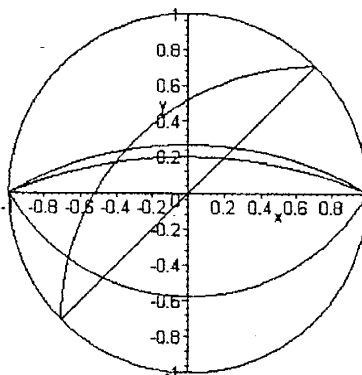

Figure 8. The image of the projective plane under stereographic projection.

Under these two projections, we can see the characteristic incidence properties of hyperbolic and elliptic geometry. The metric properties are represented

accurately, as well, but not in a linear fashion. Therefore, it is difficult to separate metric properties of the non-Euclidean geometries from the properties of the projection.

Impulse curvatures

Probably the most important aspect of non-Euclidean geometry that is not obvious from the projections is that lines are straight in both hyperbolic and elliptic geometry. One advantage of studying "lines" (geodesics) on curved surfaces is that the geodesic curvature is zero, and it is the space that curves rather than the lines. The big drawback, of course, is that the only curved surface that we can reasonably get our hands on is the sphere, and a Lénárt Sphere [7] costs \$70.

I would like to propose another source of examples. Instead of working with curved surfaces, consider surfaces with all of its curvature concentrated at isolated points. This allows us to construct models out of paper, since the curvature will be zero almost everywhere. The lines (geodesics) on these surfaces are also very naturally straight. The simplest example would be a cone. Here the geometry is mostly Euclidean, but also elliptic. The basic idea here actually predates Gaussian curvature, and is due to Descartes (see [2]). It also matches amazingly well with the big Gaussian curvature formula from the Gauss-Bonnet theorem. The standard terminology in this context uses terms like angle defect. I prefer the term **impulse curvature**).

Impulse functions

Impulse functions are used in applications where a phenomena acts over a very short period of time (see [1]). In such instances, it is more convenient, and probably more accurate, to assume that this action is instantaneous. The corresponding impulse function must have properties that the usual real-valued function does not. For example, an impulse function δ would have constants t_0 and k such that $\delta(t) = 0$ if $t \neq t_0$, and $\delta(t) = \infty$ if $t = t_0$, and the integral of δ is k over any interval containing t_0 .

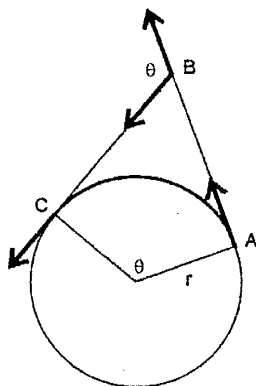

Figure 9. Impulse curvature for a curve.

Impulse curvature for curves

We will start by defining impulse curvature for curves. Consider Figure 9. The circle in Figure 9 has radius r , so its curvature is $\kappa = 1/r$. Since the curvature is the rate at which the tangent vector changes direction, if we integrate the curvature from point A to point B, we get the total change in direction for the tangent vector. Since the curvature is constant, this integral is simply the length of the arc times the curvature, and

$$\text{total curvature} = r \theta \frac{1}{r} = \theta.$$

Therefore, from A to C the tangent vector has turned to the left θ radians.

The polygonal curve ABC is straight everywhere except at B . Since the segment AB is tangent to the circle at A and the segment BC is tangent to the circle at C , the initial and terminal tangent vectors are the same as for the arc AC . The total change in direction along the path ABC , therefore, must be θ . Clearly, all of this change occurs at the point B , where the curvature is, in some sense, infinite. If there is a curvature function for the path ABC , then it must be an impulse function. The curvature is zero everywhere except at B , where the curvature is infinite, and the integral of this curvature function is θ . We will say that the path ABC has **impulse curvature** θ at B .

An application of this concept (a.k.a. angle defect) concerns angle sums of polygons, which are different depending on the number of sides. The angle sum of a triangle in the plane is π radians. For a quadrilateral, it is 2π , and for a pentagon, it is $3\pi/2$. It is easily shown that the total impulse curvature for any polygon in the plane is 2π . Here, integrating curvature around a polygon is equivalent to summing the impulse curvatures at the vertices.

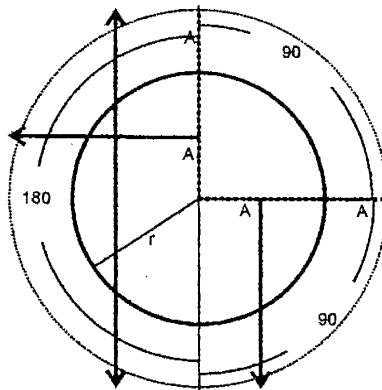

Figure 10. We can make a cone by removing a wedge.

Impulse Gauss curvature

The surface of a cone has zero Gauss curvature everywhere except at the vertex, where the curvature is, in some sense, infinite. The Gauss curvature function K for a cone must therefore be a 2-dimensional impulse function. All that needs to be determined is the value of the integral around the vertex. We can get a pretty good idea of what it should be from an example. In Figure 10, we have the ingredients for a cone. The cone is formed by removing the 90° wedge in the upper right and identifying the two rays bounding the wedge. The fact that the Gauss curvature is zero everywhere (except at the vertex) corresponds to the fact that this cone is constructed out of a flat piece of paper.

We can compute what the impulse Gauss curvature needs to be from the Gauss-Bonnet theorem. For a simple closed curve C bounding a simply connected region D on a smooth surface, the Gauss-Bonnet theorem states that the Gauss curvature K of the surface and the geodesic curvature κ (curvature within the surface) of the curve are related by the formula

$$(11) \quad \int_D K dA = 2\pi - \int_C \kappa ds.$$

The circle of radius r in Figure 10 has geodesic curvature $\kappa = 1/r$. Its circumference is $2\pi r$, and on the cone, after removing a quarter of it, the circumference is $3\pi r/4$. Therefore,

$$(12) \quad \int_D K dA = 2\pi - 3\pi r/4 \cdot 1/r = \pi/2 \text{ radians} = 90^\circ.$$

We will say that the **impulse Gauss curvature** at the vertex of this cone is $\pi/2$ radians or 90° . The derivative formulas for the trig functions assume radian measure, but other than that, there is no essential difficulty in switching back and forth between degrees and radians. The Gauss-Bonnet theorem is simpler in radians, of course, but it seems to be more convenient to work in degrees otherwise.

It should be clear that there is nothing special about 90° . So if we remove a θ -wedge, then the impulse Gauss curvature should be θ . This all indicates several important insights into the concept of Gauss curvature. One is that the natural units for Gauss curvature should be units of angle measure, although the definition suggests radians squared. Another is that a positive Gauss curvature can be thought of in terms of a sector of space missing (relative to Euclidean geometry). Of course on a smooth surface, the sectors are infinitesimal, and they are not all removed from a single point.

Also in Figure 10 are several lines. On the cone, these become two geodesics. Note that they are both locally straight, and they exhibit elliptic behavior. Here we see that having "less space" around the vertex has a fundamental effect on the relationship between lines.

Lines near an elliptic cone point

Forming a cone by removing a wedge leaves a vertex with positive impulse Gauss curvature. We will call the vertex an **elliptic cone point**. The behavior of lines near an elliptic cone point will exhibit behavior associated with lines in an elliptic geometry.

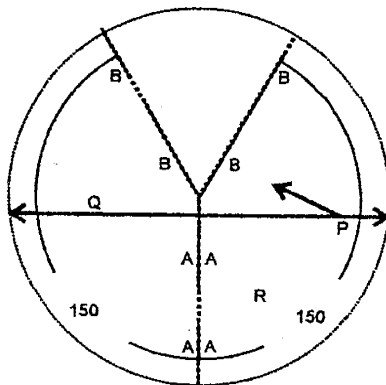

Figure 11. A cone with impulse Gauss curvature 60° .

In Figure 11, we have a cone with a 60° wedge removed, so the vertex will have positive impulse Gauss curvature $+60^\circ = +\pi/3$ radians. Cutting along the heavy dotted lines will allow us to draw the geodesics easily. Since this surface is flat everywhere (except at the cone point), geodesics are straight in the

Euclidean sense. We can draw them with a ruler. To extend a geodesic across a cut, line up the edges and draw the geodesic straight across with a ruler.

At the point P in Figure 11 is the start of a geodesic. With a ruler, continue it across the cut marked B and extend it as far as possible. This geodesic should intersect the other geodesic drawn near the letter Q . This forms a 2-gon PQ .

With a protractor, measure the impulse curvatures at P and Q . These should be around 145° and 155° . Since the 2-gon PQ encloses the elliptic vertex with impulse Gauss curvature 60° , we can check the Gauss-Bonnet theorem.

On the curve, the curvature is zero everywhere except for the two impulse curvatures. Therefore, integrating around the 2-gon is equivalent to summing the impulse curvatures, $\int_{PQ} \kappa ds = 145^\circ + 155^\circ$. Similarly, if D is the disk bounded by the 2-gon PQ , then $\int_D K dA = 60^\circ$. We have then, $60^\circ = 360^\circ - (145^\circ + 155^\circ)$.

Draw segments QR and PR . Note that there are two triangles PQR , since there are two segments QR . Note also that these two triangles are not congruent, but they satisfy the SAS criterion. Furthermore, since one of the triangles contains the elliptic cone point and the other does not, their angle sums and total impulse curvatures are different.

Lines around a hyperbolic cone point

Adding a wedge creates a "cone" with a kind of saddle shape. The result is an impulse Gauss curvature that is negative, and we will call the vertex a hyperbolic cone point. The behavior of lines near a hyperbolic cone point is similar to that of lines in a hyperbolic geometry.

In Figures 12 and 13, we have the ingredients for a cone with impulse Gauss curvature -60° .

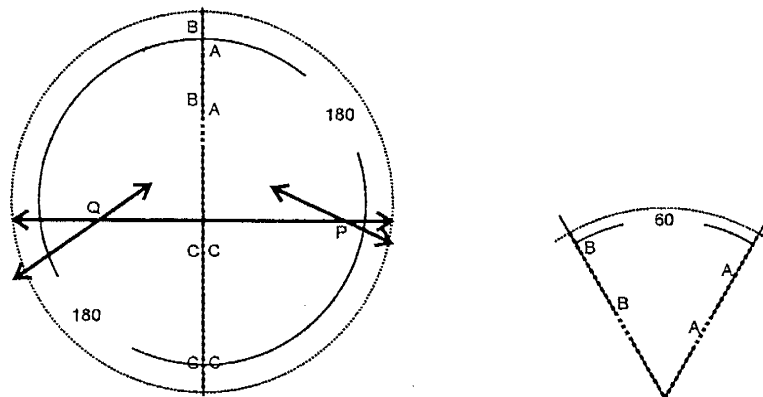

Figures 12 and 13. Adding a 60° wedge creates a cone point with impulse Gauss curvature -60° .

Cut along the heavy dotted lines and continue the geodesics indicated at P and Q . These should be parallel (i.e., they do not intersect).

Check the Gauss-Bonnet theorem by considering a quadrilateral that contains the hyperbolic cone point.

An example with multiple cone points

There are hardly any restrictions on constructing surfaces with multiple cone points (I don't think you can construct one with total Gauss curvature greater than 2π), and I think it would be helpful for students to be able construct counter-examples to theorems in Euclidean geometry.

My interest in flat surfaces with cone points began with a search for examples of Smarandache geometries. My book [5], which can be downloaded for free, contains some explorations in this context similar to the ones presented here. One example that I thought was interesting had something that I called a **hyperbolic point**.

A Smarandache Geometry is a geometry which has at least one smarandachely denied axiom (1969).

An axiom is said smarandachely denied if the axiom behaves in at least two different ways within the same space (i.e., validated and invalided, or only invalidated but in multiple ways).

Thus, as a particular case, Euclidean, Lobachevsky-Bolyai-Gauss, and Riemannian geometries may be united altogether, in the same space, by some Smarandache geometries. These last geometries can be partially Euclidean and partially Non-Euclidean.

One of the first things proved in hyperbolic geometry is that through a point P not on a line l , there are infinitely many lines parallel to l . Hilbert's hyperbolic axiom requires only two (see [4]), but it is easily shown that all of the lines between these two parallels are also parallel. Smarandache wondered if there were any manifolds where there were only finitely many parallels (see [9]). My example has exactly two, but uses cone points. A variation of this example follows. I was later able to extend this to smooth surfaces (see [6]).

Since the cone points are parts of the space, we need to define how a geodesic passes through one. We use the **straightest geodesic** concept of [8], which says that the geodesic should make two equal angles at the cone point. For example, around a cone point with impulse curvature -60° , there is an "extra" 60° for a total of 420° . A geodesic passing through this cone point would make two 210° (straight) angles.

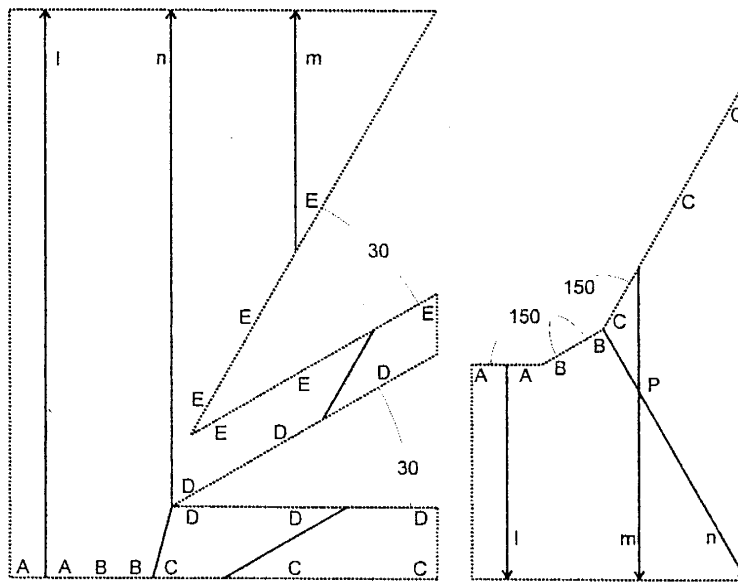

Figures 14 and 15. The lines m and n are the only lines through P that are parallel to l .

In Figures 14 and 15, the endpoints of the segment marked B are hyperbolic cone points with impulse Gauss curvature -30° , and the endpoints of the rays marked D and E are elliptic cone points with impulse Gauss curvature $+30^\circ$. The line n passes through one hyperbolic cone point making two 195° angles and one elliptic cone point making two 165° angles. This line n should look straight after the edges have been identified.

Also after the edges have been identified, it should be clear that both lines m and n are parallel to l . It is also true that every other line through P will intersect l . Draw in a couple before taping up the surface to verify this.

After identifying the edges, note that the lines l and m and the boundaries of the diagram form a quadrilateral with four right angles. Is it a rectangle? Is it a parallelogram?

References

1. W.E. Boyce and R.C. DiPrima, Elementary Differential Equations and Boundary Value Problems, John Wiley and Sons, New York, 1992.
2. H. Gottlieb, All the way with Gauss-Bonnet and the sociology of mathematics, The American Mathematical Monthly 103 (6), 457-469, 1996.
3. M.J. Greenberg, Euclidean and Non-Euclidean Geometries, W.H. Freeman and Company, New York, 1974.
4. D. Hilbert, Foundations of Geometry, Open Court, La Salle, IL, 1971.
5. H. Iseri, Smarandache Manifolds, American Research Press, Rehoboth, NM, USA, 2002. (available at www.gallup.unm.edu/~smarandache/Iseri-book.pdf)
6. H. Iseri, A finitely hyperbolic point on a smooth manifold (dvi-preprints available).
7. Lénárt Sphere, Key Curriculum Press, www.keypress.com
8. K. Polthier and M. Schmies, Straightest geodesics on polyhedral surfaces, Mathematical Visualizations, 1998.
9. F. Smarandache, Paradoxist Mathematics, Collected Papers (Vol. II, 5-28), University of Kishinev Press, 1997.

SMARANDACHE-GALOIS FIELDS

W. B. Vasantha Kandasamy
Department of Mathematics
Indian Institute of Technology, Madras
Chennai - 600 036, India.
E-mail: vasantak@md3.vsnl.net.in

Abstract: *In this paper we study the notion of Smarandache-Galois fields and homomorphism and the Smarandache quotient ring. Galois fields are nothing but fields having only a finite number of elements. We also propose some interesting problems.*

Keywords: *Smarandache ring, Smarandache-Galois field, Smarandache field homomorphism, Smarandache quotient ring*

Definition [2]: *The Smarandache ring is defined to be a ring A such that a proper subset of A is a field (with respect with the same induced operations). By proper set we understand a set included in A, different from the empty set, from the unit element if any, and from A.*

Definition 1: *A finite ring S (i.e. a ring having finite number of elements) is said to be a Smarandache-Galois field if S contains a proper subset A, $A \subset S$ such that A is a field under the operations of S.*

Clearly we know every finite field is of characteristic p and has p^n elements, $0 < n < \infty$.

Example 1: Let $Z_{10} = \{0, 1, 2, 3, 4, 5, \dots, 9\}$ be the ring of integers modulo 10. Z_{10} is a Smarandache-Galois field. For the set $A = \{0, 5\}$ is a field for $5^2 = 5$ acts as a unit and is isomorphic with Z_2 .

Example 2: Let $Z_8 = \{0, 1, 2, \dots, 7\}$ be the ring of integers modulo 8. Z_8 is not a Smarandache-Galois field, for Z_8 has no proper subset A which is a field.

Thus we have the following interesting theorem.

Theorem 2: Z_{p^n} is not a Smarandache field for any prime p and for any n.

Proof: Z_{p^n} is the ring of integers modulo p^n . Clearly Z_{p^n} is not a field for $p^r \cdot p^s = 0 \pmod{p^n}$ when $r + s = n$. Now any $q \in Z_{p^n}$ if not a multiple of p will

generate Z_p^n under the operations addition and multiplication. If q is a multiple of p (even a power of p) then it will create zero divisors. So Z_p^n cannot have a proper subset that is a field.

Theorem 3: Let Z_m be the ring of integers modulo m . $m = p_1 \dots p_t$, $t > 1$, where all p_i are distinct primes. Then Z_m is a Smarandache-Galois field.

Proof: Let Z_m be the ring of integers modulo m . Let $m = p_1 \dots p_t$, for every prime p_i under addition and multiplication will generate a finite field. So Z_m is a Smarandache-Galois field.

Example 3: Let $Z_6 = \{0, 1, 2, \dots, 5\}$. Clearly $\{0, 2, 4\}$ is a field with $4^2 = 4 \pmod{6}$ acting as the multiplicative identity. So $\{0, 2, 4\}$ is a field. Similarly $\{0, 3\}$ is a field. Hence Z_6 is a Smarandache-Galois field.

Example 4: Let $Z_{105} = \{0, 1, 2, \dots, 104\}$ be the ring of integers modulo 105. Clearly $A = \{0, 7, 14, 21, 28, \dots, 98\}$ is a field with 15 elements. So Z_{105} is a Smarandache-Galois field.

Example 5: Let $Z_{24} = \{0, 1, 2, \dots, 23\}$ be the ring of integers modulo 24. $\{0, 8, 16\}$ is a field with 16 as unit since $16^2 = 16$ and $\{0, 8, 16\}$ isomorphic with Z_3 . So Z_{24} is a Smarandache-Galois field.

Note that $24 = 2^3 \cdot 3$ and not of the form described in Theorem 3.

Example 6: $Z_{12} = \{0, 1, 2, \dots, 11\}$. $A = \{0, 4, 8\}$ is a field with $4^2 = 4 \pmod{12}$ as unit. So Z_{12} is a Smarandache-Galois field.

Theorem 4: Let Z_m be the ring of integers with $m = p_1^{\alpha_1} p_2$. Let $A = \{p_1^{\alpha_1}, 2p_1^{\alpha_1}, \dots, (p_2 - 1)p_1^{\alpha_1}, 0\}$. Then A is a field of order p_2 with $p_1^{\alpha_1}$ as multiplicative unit of A .

Proof: Let Z_m and A be as given in the theorem. Clearly A is additively and multiplicatively closed with 0 as additive identity and $p_1^{\alpha_1}$ as multiplicative identity.

We now pose the following problems:

Problem 1: Z_m is the ring of integers modulo m . If $m = p_1^{\alpha_1} \dots p_t^{\alpha_t}$ with one of $\alpha_i = 1$, $1 \leq i \leq t$. Does it imply Z_m has a subset having p_i elements which forms a field?

Problem 2: If Z_m is as in Problem 1, can Z_m contain any other subset other than the one mentioned in there to be a field?
Further we propose the following problem.

Problem 3: Let Z_m be the ring of integers modulo m that is a Smarandache-Galois field. Let $A \subset Z_m$ be a subfield of Z_m . Then prove $|A|/m$ and $|A|$ is a prime and not a power of prime.

A natural question now would be: Can we have Smarandache-Galois fields of order p^n where p is a prime? When we say *order of the Smarandache-Galois field* we mean only the number of elements in the Smarandache Galois field. That is like in Example 3 the order of the Smarandache-Galois field is 6. The answer to this question is yes.

Example 7: Let $Z_p[x]$ be the polynomial ring in the variable x over the field Z_p (p a prime). Let $p(x) = p_0 + p_1x + \dots + p_nx^n$ be a reducible polynomial of degree n over Z_p . Let I be the ideal generated by $p(x)$ that is $I = \langle p(x) \rangle$.

Now $\frac{Z_p[x]}{I = \langle p(x) \rangle} = R$ is a ring.

Clearly R has a proper subset A of order p which is a field. So there exists Smarandache-Galois field of order p^n for any prime p and any positive integer n .

Example 8: Let $Z_3[x]$ be the polynomial ring with coefficients from the field Z_3 . Consider $x^4 + x^2 + 1 \in Z_3[x]$ is reducible. Let I be the ideal generated by $x^4 + x^2 + 1$. Clearly $R = \frac{Z_3[x]}{I} = \{I, I + 1, I + 2, I + x, I + 2x, I + x + 1, I + x + 2, I + 2x + 1, I + 2x + 2, I + x^2, I + x^3, \dots, I + 2x + 2 + 2x^2 + 2x^3\}$ having 81 elements. Now $\{I, I + 1, I + 2\} \subseteq R$ is a field. So R is a Smarandache-Galois field of order 3^4 .

Theorem 5: A finite ring is a Smarandache ring if and only if it is a Smarandache-Galois field.

Proof: Let R be a finite ring that is a Smarandache ring then, by the very definition, R has a proper subset which is a field. Thus R is a Smarandache-Galois field.

Conversely, if R is a Smarandache-Galois field then R has a proper subset which is a field. Hence R is a Smarandache ring.

This theorem is somewhat analogous to the classical theorem "Every finite integral domain is a field" for "Every finite Smarandache ring is a Smarandache-Galois field".

Definition 6: Let R and S be two Smarandache-Galois fields. ϕ , a map from R to S , is a *Smarandache-Galois field homomorphism* if ϕ is a ring homomorphism from R to S .

Definition 7: Let R and S be Smarandache Galois fields. We say ϕ from R to S is a *Smarandache-Galois field isomorphism* if ϕ is a ring isomorphism from R to S .

Definition 9: Let Z_m be a Smarandache field. $A \subset Z_m$ be a subfield of Z_m . Let $r \in A$ such that $r \neq 0$, $r^2 = r \pmod{m}$ acts as the multiplicative identity of A . Define $\frac{Z_m}{\{A\}} = \{0, 1, 2, \dots, r-1\}$. We call $\frac{Z_m}{\{A\}}$ the *Smarandache quotient ring* and the operation on $\frac{Z_m}{\{A\}} = \{0, 1, \dots, r-1\}$ is usual addition and multiplication modulo r .

Theorem 9: Let Z_m be a Smarandache-Galois field. $A \subset Z_m$ be a subfield of Z_m . $\frac{Z_m}{\{A\}}$ the Smarandache quotient ring need not in general be a Smarandache ring or equivalently a Smarandache-Galois field.

Proof: By an example. Take $Z_{24} = \{0, 1, 2, \dots, 23\}$ be the ring of integers modulo 24. Let $A = \{0, 8, 16\}$; $16^2 = 16 \pmod{24}$ acts as multiplicative identity for A . $\frac{Z_{24}}{\{A\}} = \{0, 1, 2, \dots, 15\}$. Clearly $\frac{Z_{24}}{\{A\}}$ is not a Smarandache ring or a Smarandache-Galois field.

Thus, motivated by this we propose the following:

Problem 4: Find conditions on m for Z_m to have its Smarandache quotient ring to be a Smarandache ring or Smarandache-Galois field.

Example 10: $Z_{12} = \{0, 1, \dots, 11\}$ is the ring of integers modulo 12. $A = \{0, 4, 8\}$ is a field with $4^2 = 4 \pmod{12}$ as multiplicative identity. $\frac{Z_{12}}{\{0,4,8\}} = \{0, 1, 2, 3\} \pmod{4}$ is not a Smarandache-Galois field or a Smarandache ring.

Example 11: $Z_{21} = \{0, 1, 2, \dots, 20\}$ is the ring of integers modulo 21. $A = \{0, 7, 14\}$ is a subfield. $\frac{Z_{21}}{\{A\}} = \{0, 1, 2, \dots, 6\} \pmod{7}$ is not a Smarandache-Galois field. Let $B = \{0, 3, 6, 9, 12, 15, 18\} \subseteq Z_{21}$. Clearly B is a field with $15^2 = 15 \pmod{21}$

as a multiplicative unit. Now, $\frac{\mathbb{Z}_{21}}{\{0,3,6,9,12,15,18\}} = \{0,1,2,\dots,14\}$ is a Smarandache-Galois field.

Thus we have the following interesting:

Problem 5: Let \mathbb{Z}_m be the Smarandache ring. Let A be a subset which is a field. When does an A exist such that $\frac{\mathbb{Z}_m}{A}$ is a Smarandache-Galois field?

References:

- [1] I. N. Herstein, *Topics in Algebra*, New York, Blaisdell, 1964.
- [2] Padilla, Raul. *Smarandache Algebraic Structures*, Bulletin of Pure and Applied Sciences, Delhi, Vol. 17 E., No. 1, 119-121, 1998;
<http://www.gallup.unm.edu/~smarandache/ALG-S-TXT.TXT>.

SMARANDACHE NEAR-RINGS AND THEIR GENERALIZATIONS

W. B. Vasantha Kandasamy
Department of Mathematics
Indian Institute of Technology, Madras
Chennai - 600 036, India.
E- mail: vasantak@md3.vsnl.net.in

Abstract: In this paper we study the Smarandache semi-near-ring and near-ring, homomorphism, also the Anti-Smarandache semi-near-ring. We obtain some interesting results about them, give many examples, and pose some problems. We also define Smarandache semi-near-ring homomorphism.

Keywords: Near-ring, Semi-near-ring, Smarandache semi-near-ring, Smarandache near-ring, Anti-Smarandache semi-near-ring, Smarandache semi-near-ring homomorphism,

Definition [1 Pilz]: An algebraic system $(N, +, \bullet)$ is called a *near-ring* (or a *right near-ring*) if it satisfies the following three conditions:

- (i) $(N, +)$ is a group (not necessarily abelian).
- (ii) (N, \bullet) is a semigroup.
- (iii) $(n_1 + n_2) \bullet n_3 = n_1 \bullet n_3 + n_2 \bullet n_3$ (right distributive law) for all $n_1, n_2, n_3 \in N$.

Definition [1 Pilz]: An algebraic system $(S, +, \bullet)$ is called a *semi-near-ring* (or *right semi-near-ring*) if it satisfies the following three conditions:

- (i) $(S, +)$ is a semigroup (not necessarily abelian).
- (ii) (S, \bullet) is a semigroup.
- (iii) $(n_1 + n_2) \bullet n_3 = n_1 \bullet n_3 + n_2 \bullet n_3$ for all $n_1, n_2, n_3 \in S$ (right distributive law).

Clearly, every near-ring is a semi-near-ring and not conversely. For more about semi-near-rings please refer [1], [4], [5], [6], [7], [8] and [9].

Definition 1: A non-empty set N is said to be a *Smarandache semi-near-ring* if $(N, +, \bullet)$ is a semi-near-ring having a proper subset A ($A \subset N$) such that A under the same binary operations of N is a near-ring, that is $(A, +, \bullet)$ is a near-ring.

Example 1: Let $Z_{18} = \{0, 1, 2, 3, \dots, 17\}$ integers modulo 18 under multiplication. Define two binary operations \times and \bullet on Z_{18} as follows: \times is the usual multiplication so that (Z_{18}, \times) is a semigroup;

$a \bullet b = a$ for all $a, b \in Z_{18}$.

Clearly (Z_{18}, \bullet) is a semigroup under \bullet . $(Z_{18}, \times, \bullet)$ is a semi-near-ring. $(Z_{18}, \times, \bullet)$ is a Smarandache semi-near-ring, for take $A = \{1, 3, 5, 7, 11, 13, 17\}$. (A, \times, \bullet) is a near ring. Hence the claim.

Theorem 2: Not all semi-near-rings are in general Smarandache semi-near-rings.

Proof: By an example.

Let $Z^+ = \{\text{set of positive integers}\}$. Z^+ under $+$ is a semigroup. Define \bullet a binary operation on Z^+ as $a \bullet b = a$ for all $a, b \in Z^+$. Clearly Z^+ under \bullet is a semigroup. Now $(Z^+, +, \bullet)$ is a semi-near-ring which is not a Smarandache semi-near-ring.

Now we give an example of.

Example 2 (of an infinite Smarandache semi-near-ring):

Let $M_{n \times n} = \{(a_{ij}) / a_{ij} \in Z\}$. Define matrix multiplication as an operation on $M_{n \times n}$. $(M_{n \times n}, \times)$ is a semigroup. Define ' \bullet ' on $M_{n \times n}$ as $A \bullet B = A$ for all $A, B \in M_{n \times n}$. Clearly $(M_{n \times n}, \times, \bullet)$ is a Smarandache semi-near-ring, for take the set of all $n \times n$ matrices A such that $|A| \neq 0$. Denote the collection by $A_{n \times n}$. $A_{n \times n} \subset M_{n \times n}$. Clearly $(A_{n \times n}, \times, \bullet)$ is a near-ring.

Example 3:

Let $Z_{24} = \{0, 1, 2, \dots, 23\}$ be the set of integers modulo 24. Define usual multiplication \times on Z_{24} . (Z_{24}, \times) is a semigroup. Define ' \bullet ' on Z_{24} as $a \bullet b = a$ for all $a, b \in Z_{24}$. Clearly Z_{24} is a semi-near-ring. Now Z_{24} is also a Smarandache semi-near-ring. For take $A = \{1, 5, 7, 11, 13, 17, 19, 23\}$. (A, \times, \bullet) is a near-ring. So, Z_{24} is a Smarandache semi-near-ring.

Motivated by the examples 3 and 4 we propose the following open problem.

Problem 1: Let $Z_n = \{0, 1, 2, \dots, n-1\}$ set of integers. $n = p_1^{\alpha_1} \dots p_t^{\alpha_t}$, where p_1, p_2, \dots, p_t are distinct primes, $t > 1$. Define two binary operations ' \times ' and ' \bullet ' on Z_n . \times is the usual multiplication. Define ' \bullet ' on Z_n as $a \bullet b = a$ for all $a, b \in Z_n$. Let $A = \{1, q_1, \dots, q_r\}$ where q_1, \dots, q_r are all odd primes different from p_1, \dots, p_t and $q_1, \dots, q_r \in Z_n$.

Prove A is a group under \times . Solution to this problem will give the following:

Result: $Z_n = \{0, 1, 2, \dots, n-1\}$ is a Smarandache semi-near-ring under \times and \bullet defined as in Examples 1 and 3. Thus we get a class of Smarandache semi-near-rings for every positive composite integer. Now when $t = 1$ different cases arise.

Example 4: $Z_4 = \{0, 1, 2, 3\}$ is a Smarandache semi-near-ring as (Z_4, \times, \bullet) is a semi-near-ring and $(A = \{1, 3\}, \times, \bullet)$ is a near-ring.

Example 5: $Z_9 = \{0, 1, 2, 3, 4, \dots, 8\}$. Now (Z_9, \times, \bullet) is a semi-near-ring. $(A = \{1, 8\}, \times, \bullet)$ is a near-ring so Z_9 is a Smarandache near-ring. Clearly 8 is not a prime number.

Example 6: Let $Z_{25} = \{0, 1, 2, 3, \dots, 24\}$. Now $(Z_{25}, \times, \bullet)$ is a semi-near-ring. $(A = \{1, 24\}, \times, \bullet)$ is a near-ring. Thus Z_{25} is a Smarandache semi-near-ring.

Theorem 3: Let $(Z_{p^2}, \times, \bullet)$ be a semi-near-ring. Clearly $(Z_{p^2}, \times, \bullet)$ is a Smarandache semi-near-ring.

Proof: Let $(A = \{1, p^2-1\}, \times, \bullet)$ is a near-ring. Hence $(Z_{p^2}, \times, \bullet)$ is a Smarandache semi-near-ring.

Hence we assume $t > 1$, for non primes one can contribute to near -ring under (\times, \bullet) .

Corollary: Let $(Z_{p^n}, \times, \bullet)$ be a semi-near-ring. $(Z_{p^n}, \times, \bullet)$ is a Smarandache near-ring.

Proof: Take $A = \{1, p^n-1\}$ is a near-ring. Hence $(Z_{p^n}, \times, \bullet)$ is a Smarandache semi-near-ring.

Thus we have a natural class of finite Smarandache semi-near-rings.

Definition 4 (in the classical way):

N is said to be a *Smarandache near-ring* if $(N, +, \bullet)$ is a near-ring and has a proper subset A such that $(A, +, \bullet)$ is a near-field.

Now many near-rings contain subsets that are semi-near-rings, so we are forced to check:

Definition 5: N is said to be an *Anti-Smarandache semi-near-ring* if N is a near-ring and has a proper subset A of N such that A is a semi-near-ring under the same operations of N .

Example 7: Let Z be the set of integers under usual $+$ and multiplication ' \bullet ' by $a \bullet b = a$ for all $a, b \in Z$. $(Z, +, \bullet)$ is a near-ring. Take $A = Z^+$ now $(Z^+, +, \bullet)$ is a semi-near-ring. So Z is an Anti-Smarandache semi-near-ring.

Example 8: Let $M_{n \times n} = \{(a_{ij}) / a_{ij} \in Z\}$. Define $+$ on $M_{n \times n}$ as the usual addition

of matrices and define \bullet on $M_{n \times n}$ by $A \bullet B = A$ for all $A, B \in M_{n \times n}$. $(M_{n \times n}, +, \bullet)$ is a near-ring. Take $A_{n \times n} = \{(a_{ij}) / a_{ij} \in \mathbb{Z}^+\}$. Now $(A, +, \bullet)$ is a semi-near-ring. Thus $M_{n \times n}$ is an Anti-Smarandache semi-near-ring.

We propose the following:

Problem 2: Does there exist an infinite near-ring constructed using reals or integers, which is not an Anti-Smarandache semi-near-ring?

Example 9: $\mathbb{Z}[x]$ is the polynomial ring over the ring of integers. Define $+$ on $\mathbb{Z}[x]$ as the usual addition of polynomials. Define an operation \bullet on $\mathbb{Z}[x]$ as $p(x) \bullet q(x) = p(x)$ for all $p(x), q(x) \in \mathbb{Z}[x]$. Clearly $(\mathbb{Z}[x], +, \bullet)$ is an Anti-Smarandache semi-near-ring, for $(\mathbb{Z}^+[x], +, \bullet)$ is a semi-near-ring.

Now it is still more interesting to find a solution to the following question (or Problem 2 worded in a negative way):

Problem 3: Find a finite Anti-Smarandache semi-near-ring.

Definition 6: Let N and N_1 be two Smarandache semi-near-rings. A mapping $h: N \rightarrow N_1$ is a *Smarandache semi-near-ring homomorphism* if h is a homomorphism.

Similarly one defines the Anti-Smarandache semi-near-ring homomorphism:

Definition 7: Let N and N_1 be two Anti-Smarandache semi-near-rings. Then $h: N \rightarrow N_1$ is an *Anti-Smarandache semi-near-ring homomorphism* if h is a homomorphism.

References:

- [1] G. Pilz, Near-rings, North - Holland Publ. and Co. (1977).
- [2] J. Castillo, *The Smarandache Semigroup*, International Conference on Combinatorial Methods in Mathematics, II Meeting of the project 'Algebra, Geometria e Combinatoria', Faculdade de Ciencias da Universidade do Porto, Portugal, 9-11 July 1998.
- [3] R. Padilla, *Smarandache Algebraic Structures*, Bulletin of Pure and Applied Sciences, Delhi, Vol. 17 E., No. 1, 119-121, (1998)
<http://www.gallup.unm.edu/~smarandache/ALG-S-TXT.TXT>
- [4] W. B. Vasantha Kandasamy, Idempotents in group semi-near-ring, IPB Bulletin Sci., 13-17, (1991).
- [5] W. B. Vasantha Kandasamy, Zero divisors in group semi-near-rings, Riazi J. Karachi Math. Assoc., Vol. 14, 25-28, (1992).
- [6] W. B. Vasantha Kandasamy, Zero divisors in semi-loop near-rings, Zeszyty Nauk. Poli Rzesz., (79-84, 1994).

- [7] W. B. Vasantha Kandasamy, The units of semigroup semi-near-rings, *Opuscula Math.*, Vol. 15, 113 -114, (1995).
- [8] W. B. Vasantha Kandasamy, Complex Polynomial near-rings, *Analele Stiin. Ale Univ.*, Vol. IV, 29 - 31, (1995).
- [9] W. B. Vasantha Kandasamy, Idempotents and semi-idempotents in near-rings, *J. of Sichuan Univ.* Vol. 33, 330 - 332, (1996).

SMARANDACHE SEMI-AUTOMATON AND AUTOMATON

W. B. Vasantha Kandasamy
Department of Mathematics
Indian Institute of Technology, Madras
Chennai - 600 036, India
E- mail: vasantak@md3.vsnl.net.in

Abstract: In this paper we study the Smarandache Semi-Automaton and Automaton using Smarandache free groupoids.

Keywords: Smarandache free groupoid, Smarandache Semi-Automaton, Smarandache Automaton, Smarandache Automaton homomorphism

Definition 1: Let S be a non-empty set. Then $\langle S \rangle$ denotes the free groupoid generated by the set S as a basis.

We assume the free semigroup generated by S is also contained in the free groupoid generated by S .

Remark: Even $a(bc) \neq (ab)c$ for $a, b, c \in S$. So unlike a free semigroup where the operation is associative in case of free groupoid we do not assume the associativity while placing them in the juxtaposition.

Definition [W.B.Vasantha Kandasamy]: A groupoid G is said to be a Smarandache groupoid, if G contains a non-empty proper subset S such that S is a semigroup under the operations of the groupoid G .

Theorem 2: Every free groupoid is a Smarandache free groupoid.

Proof: By the very definition of the free groupoid we have the above theorem to be true.

Definition [R. Lidl, G. Pilz]: A Semi-Automaton is a triple $\mathfrak{A} = (Z, A, \delta)$ consisting of two non-empty sets Z and A and a function $\delta: Z \times A \rightarrow Z$, Z is called the set of states, A the input alphabet, and δ the next state function of \mathfrak{A} .

Definition [R. Lidl, G. Pilz]: An Automaton is a quintuple $A = (Z, A, B, \delta, \lambda)$, where (Z, A, δ) is a semi automaton, B is a non-empty set called the output alphabet and $\lambda: Z \times A \rightarrow B$ is the output function.

Now it is important and interesting to note that Z , A , and B are only non-empty sets. They have no algebraic operation defined on them. The automaton and semi-automaton defined in this manner do not help to perform sequential operations. Thus, it is reasonable to consider the set of all finite sequences of elements of A including the empty sequence Λ . In other words, in our study of automaton we extend the input set A to the free monoid \bar{A} and similarly for B . We also extend δ and λ from $Z \times A$ to $Z \times \bar{A}$ by defining $z \in Z$ and $a_1, \dots, a_n \in \bar{A}$ by

$$\begin{aligned} \bar{\delta}(z, \Lambda) &= z \\ \bar{\delta}(z, a_1) &= \delta(z, a_1) \\ \bar{\delta}(z, a_1 a_2) &= \delta(\bar{\delta}(z, a_1), a_2) \\ &\vdots \\ \bar{\delta}(z, a_1 a_2 \dots a_n) &= \delta(\bar{\delta}(z, a_1 a_2 \dots a_{n-1}), a_n) \end{aligned}$$

and

$$\lambda: Z \times A \rightarrow B \text{ by } \bar{\lambda}: Z \times \bar{A} \rightarrow \bar{B}$$

by

$$\begin{aligned} \bar{\lambda}(z, \Lambda) &= \Lambda \\ \bar{\lambda}(z, a_1) &= \lambda(z, a_1) \\ \bar{\lambda}(z, a_1 a_2) &= \lambda(z, a_1) \lambda(\delta(z, a_1), a_2) \\ &\vdots \\ \bar{\lambda}(z, a_1 a_2 \dots a_n) &= \lambda(z, a_1) \bar{\lambda}(\delta(z, a_1), a_2 \dots a_n) \end{aligned}$$

The semi-automaton $\varpi = (Z, A, \delta)$ and automaton $A = (Z, A, B, \delta, \lambda)$ are thus generalized to the new semi-automaton $\varpi = (Z, \bar{A}, \bar{\delta})$ and new automaton $A = (Z, \bar{A}, \bar{B}, \bar{\delta}, \bar{\lambda})$.

Definition 3: $\varpi_s = (Z, \bar{A}_s, \bar{\delta}_s)$ is said to be a *Smarandache semi-automaton* if $\bar{A} = \langle A \rangle$ is the free groupoid generated by A , with Λ the unit element adjoined with it. Thus the Smarandache semi-automaton contains $\varpi = (Z, \bar{A}, \bar{\delta})$ as a new semi-automaton which is a proper sub-structure of ϖ_s .

Or equivalently, we define a Smarandache semi-automaton as one which has a new semi-automaton as a sub-structure.

The advantages of the Smarandache semi-automaton is: if the triple $\varpi = (Z, A, \delta)$ is a semi-automaton with Z , the set of states, and $\delta: Z \times A \rightarrow Z$ is the

next state function, and when we generate the Smarandache free groupoid by A and adjoin with it the empty alphabet Λ then we are sure that \bar{A} has all free semigroups. Thus each free semigroup will give a new semi-automaton. Thus by choosing a suitable A we can get several new semi-automatons using a single Smarandache semi-automaton.

Definition 4: $\bar{A}_s = (Z, \bar{A}_s, \bar{B}_s, \bar{\delta}_s, \bar{\lambda}_s)$ is defined to be a Smarandache automaton if $\bar{A} = (Z, \bar{A}, \bar{B}, \bar{\delta}, \bar{\lambda})$ is the new automaton, and \bar{A}_s and \bar{B}_s the Smarandache free groupoids so that $\bar{A} = (Z, \bar{A}, \bar{B}, \bar{\delta}, \bar{\lambda})$, the new automaton got from A and \bar{A}_s , is strictly contained in \bar{A}_s .

Thus Smarandache Automaton enables us to adjoin some more elements that are present in A and freely generated by A , as a free groupoid; that will be the case when the compositions may not be associative. Secondly, by using Smarandache Automaton we can couple several automatons as:

$$\begin{aligned} Z &= Z_1 \cup Z_2 \cup \dots \cup Z_n \\ A &= A_1 \cup A_2 \cup \dots \cup A_n \\ B &= B_1 \cup B_2 \cup \dots \cup B_n \\ \lambda &= \lambda_1 \cup \lambda_2 \cup \dots \cup \lambda_n \\ \delta &= \delta_1 \cup \delta_2 \cup \dots \cup \delta_n \end{aligned}$$

where the union of $\lambda_i \cup \lambda_j$ and $\delta_i \cup \delta_j$ denote only extension maps as ' \cup ' has no meaning in the composition of maps, where $A_i = (Z_i, A_i, B_i, \delta_i, \lambda_i)$ for $i = 1, 2, 3, \dots, n$ and $\bar{A} = \bar{A}_1 \cup \bar{A}_2 \cup \dots \cup \bar{A}_n$. Now $\bar{A}_s = (\bar{Z}_s, \bar{A}_s, \bar{B}_s, \bar{\lambda}_s, \bar{\delta}_s)$ is the Smarandache Automaton. A machine equipped with this Smarandache Automaton can use any new automaton as per need.

Definition 5: $\bar{A}'_s = (Z_1, \bar{A}_s, \bar{B}_s, \bar{\delta}'_s, \bar{\lambda}'_s)$ is called *Smarandache sub-automaton* of $\bar{A}_s = (Z_2, \bar{A}_s, \bar{B}_s, \bar{\delta}_s, \bar{\lambda}_s)$ denoted by $\bar{A}'_s \leq \bar{A}_s$ if $Z_1 \subseteq Z_2$ and $\bar{\delta}'_s$ and $\bar{\lambda}'_s$ are the restriction of $\bar{\delta}_s$ and $\bar{\lambda}_s$ respectively on $Z_1 \times \bar{A}_s$ and \bar{A}'_s has a proper subset $\bar{H} \subset \bar{A}'_s$ such that \bar{H} is a new automaton.

Definition 6: Let \bar{A}_1 and \bar{A}_2 be any two Smarandache Automatons where $\bar{A}_1 = (Z_1, \bar{A}_1, \bar{B}_1, \bar{\delta}_1, \bar{\lambda}_1)$ and $\bar{A}_2 = (Z_2, \bar{A}_2, \bar{B}_2, \bar{\delta}_2, \bar{\lambda}_2)$. A map $\phi: \bar{A}_1$ to \bar{A}_2 is a *Smarandache Automaton homomorphism* if ϕ is an automaton homomorphism from \bar{A}_1 and \bar{A}_2 .

And ϕ is called a *monomorphism (epimorphism or isomorphism)* if ϕ is an automaton isomorphism from $\overline{A_1}$ and $\overline{A_2}$.

Definition 7: Let $\overline{A_1}$ and $\overline{A_2}$ be two Smarandache automaton, where $\overline{A_1} = (Z_1, \overline{A_1}, \overline{B_1}, \overline{\delta_1}, \overline{\lambda_1})$ and $\overline{A_2} = (Z_2, \overline{A_2}, \overline{B_2}, \overline{\delta_2}, \overline{\lambda_2})$. The *Smarandache Automaton direct product* of $\overline{A_1}$ and $\overline{A_2}$ denoted by $\overline{A_1} \times \overline{A_2}$ is defined as the direct product of the automaton $A_1 = (Z_1, A_1, B_1, \delta_1, \lambda_1)$ and $A_2 = (Z_2, A_2, B_2, \delta_2, \lambda_2)$ with $A_1 \times A_2 = (Z_1 \times Z_2, A_1 \times A_2, B_1 \times B_2, \delta, \lambda)$ with $\delta((z_1, z_2), (a_1, a_2)) = (\delta_1(z_1, a_1), \delta_2(z_2, a_2))$, $\lambda((z_1, z_2), (a_1, a_2)) = (\lambda_1(z_1, a_1), \lambda_2(z_2, a_2))$ for all $(z_1, z_2) \in Z_1 \times Z_2$ and $(a_1, a_2) \in A_1 \times A_2$.

Remark: Here in $\overline{A_1} \times \overline{A_2}$ we do not take the free groupoid to be generated by $A_1 \times A_2$ but only free groupoid generated by $\overline{A_1} \times \overline{A_2}$. Thus the Smarandache Automaton direct product exists wherever an automaton direct product exists. We have made this in order to make the *Smarandache parallel composition* and *Smarandache series composition* of automaton extendable in a simple way.

Definition 8: A *Smarandache groupoid* G_1 divides a *Smarandache groupoid* G_2 if the the groupoid G_1 divides the groupoid G_2 , that is: if G_1 is a homomorphic image of a sub-groupoid of G_2 . In symbols: $G_1 | G_2$. In the relation: divides is denoted by '|'.

Definition 9: Let $\overline{A_1} = (Z_1, \overline{A}, \overline{B}, \overline{\delta_1}, \overline{\lambda_1})$ and $\overline{A_2} = (Z_2, \overline{A}, \overline{B}, \overline{\delta_2}, \overline{\lambda_2})$ be two Smarandache Automaton. We say the *Smarandache Automaton* $\overline{A_1}$ divides the *Smarandache automaton* $\overline{A_2}$ if $\overline{A_1} = (Z_1, \overline{A}, \overline{B}, \overline{\delta_1}, \overline{\lambda_1})$ divides $\overline{A_2} = (Z_2, \overline{A}, \overline{B}, \overline{\delta_2}, \overline{\lambda_2})$, i.e. if $\overline{A_1}$ is the homomorphic image of a sub-automaton of $\overline{A_2}$. Notationally $\overline{A_1} | \overline{A_2}$.

Definition 10: Two *Smarandache Automaton* $\overline{A_1}$ and $\overline{A_2}$ are said to be *equivalent* if they divide each other. In symbols $\overline{A_1} \sim \overline{A_2}$.

Theorem 11:

1. On any set of Smarandache Automata the relation 'divides' that is '|' is reflexive and transitive and '~' is an equivalence relation.
2. Isomorphic Smarandache Automaton are equivalent (but not conversely).

Proof: By the very definition of 'divides' (or '|') and the equivalence of two Smarandache Automaton the result follows.

References:

- [1] R. Padilla, *Smarandache Algebraic Structures*, Bulletin of Pure and Applied Sciences, Delhi, Vol. 17 E., No. 1, 119-121, (1998); <http://www.gallup.unm.edu/~smarandache/ALG-S-TXT.TXT>
- [2] R. Lidl and G. Pilz, *Applied Abstract Algebra*, Springer Verlag, (1984).
- [3] W. B. Vasantha Kandasamy, *Smarandache Groupoids*, American Research Press, (To appear).

Smarandache Zero Divisors

*W.B.Vasantha Kandasamy
Department of Mathematics
Indian Institute of Technology, Madras
Chennai- 600036*

ABSTRACT

In this paper, we study the notion of Smarandache zero divisor in semigroups and rings. We illustrate them with examples and prove some interesting results about them.

Keywords: Zero divisor, Smarandache zero divisor

Throughout this paper, S denotes a semigroup and R a ring. They need not in general be Smarandache semigroups or Smarandache rings respectively. Smarandache zero divisors are defined for any general ring and semigroup.

Definition 1 Let S be any semigroup with zero under multiplication (or any ring R). We say that a non-zero element $a \in S$ (or R) is a Smarandache zero divisor if there exists a non-zero element b in S (or in R) such that $a.b = 0$ and there exist $x, y \in S \setminus \{a, b, 0\}$ (or $x, y \in R \setminus \{a, b, 0\}$), $x \neq y$, with

1. $ax = 0$ or $xa = 0$
2. $by = 0$ or $yb = 0$ and
3. $xy \neq 0$ or $yx \neq 0$

Remark If S is a commutative semigroup then we will have $ax = 0$ and $xa = 0$, $yb = 0$ and $by = 0$; so what we need is at least one of xa or ax is zero 'or' not in the mutually exclusive sense.

Example 1 Let $Z_{12} = \{0,1,2,\dots,11\}$ be the semigroup under multiplication. Clearly, Z_{12} is a commutative semigroup with zero. We have $6 \in Z_{12}$ is a zero divisor as $6.8 \equiv 0(\text{mod } 12)$. Now 6 is a Smarandache zero divisor as $6.2 \equiv 0(\text{mod } 12)$, $8.3 \equiv 0(\text{mod } 12)$ and $2.3 \not\equiv 0(\text{mod } 12)$. Thus 6 is a Smarandache zero divisor. It is interesting to note that for $3 \in Z_{12}$, $3.4 \equiv 0(\text{mod } 12)$ is a zero divisor, but $3,4$ is not a Smarandache zero divisor for there does not exist a $x,y \in Z_{12} \setminus \{0\}$ $x \neq y$ such that $3.x \equiv 0(\text{mod } 12)$ and $4.y \equiv 0(\text{mod } 12)$ with $xy \not\equiv 0(\text{mod } 12)$.

This example leads us to the following theorem.

Theorem 2 Let S be a semigroup under multiplication with zero. Every Smarandache zero divisor is a zero divisor, but not reciprocally in general.

Proof: Given S is a multiplicative semigroup with zero. By the very definition of a Smarandache zero divisor in S we see it is a zero divisor in S . But if x is a zero divisor in S , it need not in general be a Smarandache zero divisor of S . We prove this by an example. Consider the semigroup Z_{12} given in example 1. Clearly 3 is a zero divisor in Z_{12} as $3 \cdot 4 \equiv 0(12)$ but 3 is not a Smarandache zero divisor of 12.

Example 2 Let $S_{2 \times 2} = \left\{ \begin{pmatrix} a & b \\ c & d \end{pmatrix} / a, b, c, d \in Z_2 = \{0,1\} \right\}$ be the set of all 2×2 matrices

with entries from the ring of integers modulo 2. $S_{2 \times 2}$ is a semigroup under matrix multiplication modulo two. Now $\begin{bmatrix} 1 & 0 \\ 0 & 0 \end{bmatrix}$ in $S_{2 \times 2}$ is a zero divisor as $\begin{bmatrix} 0 & 0 \\ 0 & 1 \end{bmatrix} \in S_{2 \times 2}$ is such

that $\begin{bmatrix} 1 & 0 \\ 0 & 0 \end{bmatrix} \begin{bmatrix} 0 & 0 \\ 0 & 1 \end{bmatrix} = \begin{bmatrix} 0 & 0 \\ 0 & 0 \end{bmatrix}$. For $\begin{bmatrix} 1 & 0 \\ 0 & 0 \end{bmatrix} \begin{bmatrix} 0 & 0 \\ 0 & 1 \end{bmatrix} = \begin{bmatrix} 0 & 0 \\ 0 & 0 \end{bmatrix}$ and $\begin{bmatrix} 0 & 0 \\ 0 & 1 \end{bmatrix} \begin{bmatrix} 1 & 0 \\ 0 & 0 \end{bmatrix} = \begin{bmatrix} 0 & 0 \\ 0 & 0 \end{bmatrix}$.

Now take $x = \begin{bmatrix} 0 & 1 \\ 0 & 0 \end{bmatrix}$ and $y = \begin{bmatrix} 0 & 0 \\ 1 & 0 \end{bmatrix}$ in $S_{2 \times 2}$. We have $\begin{bmatrix} 0 & 1 \\ 0 & 0 \end{bmatrix} \begin{bmatrix} 1 & 0 \\ 0 & 0 \end{bmatrix} = \begin{bmatrix} 0 & 0 \\ 0 & 0 \end{bmatrix}$ but

$\begin{bmatrix} 1 & 0 \\ 0 & 0 \end{bmatrix} \begin{bmatrix} 0 & 1 \\ 0 & 0 \end{bmatrix} = \begin{bmatrix} 0 & 1 \\ 0 & 0 \end{bmatrix} \neq \begin{bmatrix} 0 & 0 \\ 0 & 0 \end{bmatrix}$, $\begin{bmatrix} 0 & 0 \\ 1 & 0 \end{bmatrix} \begin{bmatrix} 0 & 0 \\ 0 & 0 \end{bmatrix} = \begin{bmatrix} 0 & 0 \\ 0 & 0 \end{bmatrix}$ but $\begin{bmatrix} 0 & 0 \\ 0 & 1 \end{bmatrix} \begin{bmatrix} 0 & 0 \\ 1 & 0 \end{bmatrix} = \begin{bmatrix} 0 & 0 \\ 1 & 0 \end{bmatrix}$

$\neq \begin{bmatrix} 0 & 0 \\ 0 & 0 \end{bmatrix}$. Finally, $\begin{bmatrix} 0 & 1 \\ 0 & 0 \end{bmatrix} \begin{bmatrix} 0 & 0 \\ 1 & 0 \end{bmatrix} = \begin{bmatrix} 1 & 0 \\ 0 & 0 \end{bmatrix} \neq \begin{bmatrix} 0 & 0 \\ 0 & 0 \end{bmatrix}$, $\begin{bmatrix} 0 & 0 \\ 1 & 0 \end{bmatrix} \begin{bmatrix} 0 & 1 \\ 0 & 0 \end{bmatrix} = \begin{bmatrix} 0 & 0 \\ 0 & 1 \end{bmatrix} \neq \begin{bmatrix} 0 & 0 \\ 0 & 0 \end{bmatrix}$.

Hence $\begin{bmatrix} 0 & 1 \\ 0 & 0 \end{bmatrix}$ is a Smarandache zero divisor of the semigroup $S_{2 \times 2}$.

Example 3 Let $R_{3 \times 3} = \left\{ (a_{ij}) \text{ such that } a_{ij} \in Z_4 = \{0,1,2,3\} \right\}$ be the collection of all 3×3 matrices with entries from Z_4 . Now $R_{3 \times 3}$ is a ring under matrix addition and multiplication modulo four. We have

$$\begin{pmatrix} 1 & 0 & 0 \\ 0 & 0 & 0 \\ 0 & 0 & 2 \end{pmatrix} \in R_{3 \times 3} \text{ is a Smarandache zero divisor in } R_{3 \times 3}.$$

For

$$\begin{pmatrix} 1 & 0 & 0 \\ 0 & 0 & 0 \\ 0 & 0 & 2 \end{pmatrix} \begin{pmatrix} 0 & 0 & 0 \\ 0 & 1 & 0 \\ 0 & 2 & 2 \end{pmatrix} = \begin{pmatrix} 0 & 0 & 0 \\ 0 & 0 & 0 \\ 0 & 0 & 0 \end{pmatrix} \text{ and } \begin{pmatrix} 0 & 0 & 0 \\ 0 & 3 & 2 \\ 0 & 0 & 2 \end{pmatrix}, \begin{pmatrix} 0 & 0 & 0 \\ 0 & 0 & 0 \\ 0 & 2 & 2 \end{pmatrix} \in R_{3 \times 3} \text{ such that}$$

$$\begin{pmatrix} 1 & 0 & 0 \\ 0 & 0 & 0 \\ 0 & 0 & 2 \end{pmatrix} \begin{pmatrix} 0 & 0 & 0 \\ 0 & 3 & 2 \\ 0 & 0 & 2 \end{pmatrix} = \begin{pmatrix} 0 & 0 & 0 \\ 0 & 0 & 0 \\ 0 & 0 & 0 \end{pmatrix}$$

$$\begin{pmatrix} 0 & 0 & 0 \\ 0 & 3 & 2 \\ 0 & 0 & 2 \end{pmatrix} \begin{pmatrix} 1 & 0 & 0 \\ 0 & 0 & 0 \\ 0 & 0 & 2 \end{pmatrix} = \begin{pmatrix} 0 & 0 & 0 \\ 0 & 0 & 0 \\ 0 & 0 & 0 \end{pmatrix}$$

$$\begin{pmatrix} 0 & 0 & 0 \\ 0 & 1 & 0 \\ 0 & 2 & 2 \end{pmatrix} \begin{pmatrix} 0 & 0 & 0 \\ 0 & 0 & 0 \\ 0 & 2 & 2 \end{pmatrix} = \begin{pmatrix} 0 & 0 & 0 \\ 0 & 0 & 0 \\ 0 & 0 & 0 \end{pmatrix}$$

$$\begin{pmatrix} 0 & 0 & 0 \\ 0 & 0 & 0 \\ 0 & 2 & 2 \end{pmatrix} \begin{pmatrix} 0 & 0 & 0 \\ 0 & 1 & 0 \\ 0 & 2 & 2 \end{pmatrix} = \begin{pmatrix} 0 & 0 & 0 \\ 0 & 0 & 0 \\ 0 & 2 & 0 \end{pmatrix} \neq \begin{pmatrix} 0 & 0 & 0 \\ 0 & 0 & 0 \\ 0 & 0 & 0 \end{pmatrix}$$

$$\begin{pmatrix} 0 & 0 & 0 \\ 0 & 3 & 2 \\ 0 & 0 & 2 \end{pmatrix} \begin{pmatrix} 0 & 0 & 0 \\ 0 & 0 & 0 \\ 0 & 2 & 2 \end{pmatrix} = \begin{pmatrix} 0 & 0 & 0 \\ 0 & 0 & 0 \\ 0 & 0 & 0 \end{pmatrix}$$

$$\begin{pmatrix} 0 & 0 & 0 \\ 0 & 0 & 0 \\ 0 & 2 & 2 \end{pmatrix} \begin{pmatrix} 0 & 0 & 0 \\ 0 & 3 & 2 \\ 0 & 0 & 2 \end{pmatrix} = \begin{pmatrix} 0 & 0 & 0 \\ 0 & 0 & 0 \\ 0 & 2 & 0 \end{pmatrix} \neq \begin{pmatrix} 0 & 0 & 0 \\ 0 & 0 & 0 \\ 0 & 0 & 0 \end{pmatrix}$$

So $\begin{pmatrix} 1 & 0 & 0 \\ 0 & 0 & 0 \\ 0 & 0 & 2 \end{pmatrix}$ is Smarandache zero-divisor in $R_{3 \times 3}$.

Example 4: Let $Z_{20} = \{0, 1, 2, \dots, 19\}$ be the ring of integers modulo 20. Clearly 10 is a Smarandache zero divisor. For $10 \cdot 16 \equiv 0 \pmod{20}$ and there exists $5, 6 \in Z_{20} \setminus \{0\}$ with

$$5 \times 16 \equiv 0 \pmod{20}$$

$$6 \times 10 \equiv 0 \pmod{20}$$

$$6 \times 5 \equiv 10 \pmod{20}.$$

Theorem 3 Let R be a ring; a Smarandache zero divisor is a zero divisor, but not reciprocally in general.

Proof: By the very definition, we have every Smarandache zero divisor is a zero divisor. We have the following example to show that every zero divisor is not a Smarandache zero divisor. Let $Z_{10} = \{0,1,2,\dots,9\}$ be the ring of integers modulo 10.

Clearly 2 in Z_{10} is a zero divisor as $2 \cdot 5 \equiv 0 \pmod{10}$ which can never be a Smarandache zero divisor in Z_{10} . Hence the claim.

Theorem 4 Let R be a non-commutative ring. Suppose $x \in R \setminus \{0\}$ be a Smarandache zero divisor; with $xy = yx = 0$ and $a, b \in R \setminus \{0, x, y\}$ satisfying the following conditions:

1. $ax = 0$ and $xa \neq 0$,
2. $yb = 0$ and $by \neq 0$ and
3. $ab = 0$ and $ba \neq 0$.

Then we have $(xa + by)^2 = 0$.

Proof: Given $x \in R \setminus \{0\}$ is a Smarandache zero divisor such that $xy = 0 = yx$. We have $a, b \in R \setminus \{0, x, y\}$ such that $ax = 0$ and $xa \neq 0$, $yb = 0$ and $by \neq 0$ with $ab = 0$ and $ba \neq 0$. Consider $(xa + by)^2 = xaby + byxa + xaxa + byby$ using $ab = 0$, $yx = 0$, $ax = 0$ and $yb = 0$ we get $(xa + by)^2 = 0$.

Theorem 5 Let R be a ring having Smarandache zero divisor satisfying conditions of Theorem 5, then R has a nilpotent element of order 2.

Proof: By Theorem 5 the result is true.

We propose the following problems.

Problem 1: Characterize rings R in which every zero divisor is a Smarandache zero divisor.

Problem 2: Find conditions or properties about rings so that it has Smarandache zero divisors.

Problem 3: Does there exist rings in which no zero divisor is a Smarandache zero divisor?

Problem 4: Find group rings RG which has Smarandache zero divisors?

Problem 5: Let G be a group having elements of finite order and F any field. Does the elements of finite order in G give way to Smarandache zero divisors?

REFERENCES

- [1] Raul Padilla, Smarandache Algebraic Structures, Bulletin of Pure and Applied

Sciences, Delhi, Vol 17E, No 1, 119-121, (1998).

- [2] Florentin Smarandache, Special Algebraic Structures, in Collected Papers, Vol. III, Oradea, 2000.
- [3] W.B.Vasantha Kandasamy, On zero divisors in reduced group rings over ordered groups, Proc. of the Japan Academy Vol. 60, Ser A No 9, 353-359, (1984).
- [4] W.B.Vasantha Kandasamy, Zero Square Group Rings, Bull. of Cal. Math. Soc. 80, 105-106, (1988).
- [5] W.B.Vasantha Kandasamy, Zero divisors in Group Semi Near Ring, Riazi Journal Karachi Math. Assoc., Vol. 14, 25-28, (1992).
- [6] W.B.Vasantha Kandasamy, On a new type of group rings and its zero divisors, Ultra Scientist Phyl. Sciences, Vol. 6, 136-137, (1994).
- [7] W.B.Vasantha Kandasamy, Zero divisors in Semi-loop near rings, Matematyka, NR 127, 79-89, (1994).

SOME PROBLEMS CONCERNING THE SMARANDACHE SQUARE COMPLEMENTARY FUNCTION (II)

Maohua Le
Department of Mathematics
Zhanjiang Normal College
29 Cunjin Road, Chikan
Zhanjiang, Guangdong
P.R.China

Abstract: In this paper we solve three diophantine equations concerning the Smarandache square complementary function.

Key words: Smarandache square complementary function; diophantine equations

For any positive integer n , let $SSC(n)$ denote the Smarandache square complementary function of n (see [1]). In [2], Russo proposed three problems concerning the equations

$$SSC(n) = SSC(n+1) \cdot SSC(n+2), \quad (1)$$

$$SSC(n) \cdot SSC(n+1) = SSC(n+2), \quad (2)$$

and

$$SSC(n) \cdot SSC(n+1) = SSC(n+2)SSC(n+3), \quad (3)$$

In this paper we completely solve these problems as follows.

Supported by the National Natural Science Foundation of China (No.10271104), the Guangdong Provincial Natural Science Foundation (No.011781) and the Natural Science Foundation of the Education Department of Guangdong Province (No.0161).

Theorem. The equations (1), (2) and (3) have no positive integer solutions n .

Proof. Let n be a positive integer solution of (1). Then from (1) we get

$$SSC(n) \equiv 0 \pmod{SSC(n+1)}. \quad (4)$$

By [2, Theorem 6], we have

$$n \equiv 0 \pmod{SSC(n)}, \quad n+1 \equiv 0 \pmod{SSC(n+1)}. \quad (5)$$

Since $\gcd(n, n+1)=1$, we get from (5) that

$$\gcd(SSC(n), SSC(n+1))=1. \quad (6)$$

Hence, by (4) and (6), we obtain $SSC(n+1)=1$. It implies that $n+1=m^2$, where m is a positive integer.

If m is even, then n is odd and $\gcd(n, n+2)=1$. It follows that

$$\gcd(SSC(n), SSC(n+2))=1. \quad (7)$$

Since $SSC(n+1)=1$, we get from (1) that

$$SSC(n)=SSC(n+2). \quad (8)$$

The combination of (7) and (8) that $SSC(n)=SSC(n+2)=1$. It implies that $n=l^2$, where l is a positive integer. But, since $n+1=m^2$, it is impossible.

If n is odd, then $\gcd(n, n+2)=2$. Since $SSC(n+1)=1$, then (8) holds and $SSC(n)=SSC(n+2)=2$. It implies that

$$n=2x^2, \quad n+2=2y^2, \quad (9)$$

where x, y are positive integers. But, by (9), we obtain $y^2 = x^2 + 1$, a contradiction. Thus, the equation (1) has no positive integer solution n .

By the same argument, we can prove that (2) and (3) have no positive integer solutions n . The theorem is proved.

References

- [1] C.Dumitrescu and V. Seleacu, Some notions and questions in number theory, Xiquan Pub. House, Phoenix-Chicago, 1994.
- [2] F.Russo, An introduction to the Smarandache square complementary function, Smarandache Notions J. 13(2002), 160-173.

SOME PROBLEMS CONCERNING THE SMARANDACHE SQUARE COMPLEMENTARY FUNCTION (III)

Maohua Le
Department of Mathematics
Zhanjiang Normal College
29 Cunjin Road, Chikan
Zhanjiang, Guangdong
P.R.China

Abstract: In this paper we discuss a diophantine equations concerning the Smarandache square complementary function.

Key words: Smarandache square complementary function; diophantine equations

For any positive integer n , let $SSC(n)$ denote the Smarandache square complementary function of n (see [1]). In [2], Russo asked that if the equation

$$SSC(mn) = m^k SSC(n), \quad (1)$$

has positive integer solutions (m, n, k) . In this paper we prove the following result.

Theorem. The positive integer solutions (m, n, k) of (1) satisfy $k=1$. Moreover, (1) has infinitely many positive integer solutions $(m, n, k) = (a, b, 1)$ with $k=1$, where a, b are coprime positive integer with square free.

Supported by the National Natural Science Foundation of China (No.10271104), the Guangdong Provincial Natural Science Foundation (No.011781) and the Natural Science Foundation of the Education Department of Guangdong Province (No.0161).

Proof. Let (m, n, k) be a positive integer solution of (1). Further, let $d = \gcd(m, n)$. Then we have

$$m = da, \quad n = db, \quad (2)$$

where a, b are coprime positive integers. Substitute (2) into (1), we get

$$\begin{aligned} SSC(mn) &= SSC(d^2 ab) = SSC(ab) = SSC(a)SSC(b) \\ &= (da)^k SSC(db), \end{aligned} \quad (3)$$

since $\gcd(a, b) = 1$. By (3), we have

$$SSC(a)SSC(b) \equiv 0 \pmod{a^k}. \quad (4)$$

It is a well known fact that

$$a \equiv 0 \pmod{SSC(a)}, \quad b \equiv 0 \pmod{SSC(b)}. \quad (5)$$

Since $\gcd(a, b) = 1$, we see from (4) and (5) that

$$SSC(a) \equiv 0 \pmod{a^k}. \quad (6)$$

Further, since $SSC(a) \leq a$, we find from (6) that $k = 1$. It implies that the solutions (m, n, k) of (1) satisfy $k = 1$.

On the other hand, if a and b are coprime positive integers with square free, then we have

$$SSC(ab) = SSC(a)SSC(b) = aSSC(b). \quad (7)$$

It implies that $(m, n, k) = (a, b, 1)$ is a positive integer solution of (1).

Thus, the theorem is proved.

References

- [1] C. Dumitrescu and V. Seleacu, Some notions and questions in number theory, Xiquan Pub. House, Phoenix-Chicago, 1994.
- [2] F. Russo, An introduction to the Smarandache square complementary function, Smarandache Notions J. 13(2002), 160-173.

SOME PROBLEMS CONCERNING THE SMARANDACHE SQUARE COMPLEMENTARY FUNCTION (IV)

Maohua Le

Department of Mathematics

Zhanjiang Normal College

29 Cunjin Road, Chikan

Zhanjiang, Guangdong

P.R.China

Abstract: In this paper we determine all solutions of an exponential diophantine equations concerning the Smarandache square complementary function.

Key words: Smarandache square complementary function; exponential diophantine equations

For any positive integer n , let $SSC(n)$ denote the Smarandache square complementary function of n (see [1]). In [3], Russo asked that solve the equation

$$SSC(n)^r + SSC(n)^{r-1} + \cdots + SSC(n) = n, \quad r > 1. \quad (1)$$

In this paper we completely solve this problem as follows.

Theorem. All positive integer solutions (n, r) of (1) are given by the following two cases.

Supported by the National Natural Science Foundation of China (No.10271104), the Guangdong Provincial Natural Science Foundation (No.011781) and the Natural Science Foundation of the Education Department of Guangdong Province (No.0161).

(i) $(n, r)=(363, 5)$.

(ii) $(n, r)=(ab^2, 2)$, where a and b are coprime positive integers satisfying $a > 1, b > 1, a = b^2 - 1$ and a is square free.

The proof of our theorem needs the following lemma.

Lemma ([2]). The equation

$$\frac{x^r - 1}{x - 1} = y^2, \quad x > 1, \quad y > 1, \quad r > 2 \quad (2)$$

has only the positive integer solution $(x, y, r)=(3, 11, 5)$.

Proof of Theorem. Let (n, r) be a positive integer solution of (1).

Let $x = SSC(n)$. Then from (1) we get

$$x(x^{r-1} + \dots + x + 1) = n, \quad r > 1. \quad (3)$$

Since $r > 1$ we see from (3) that $n > 1$.

It is a well known fact that n can be expressed as

$$n = p_1^{\alpha_1} \dots p_s^{\alpha_s} q_1^{\beta_1} \dots q_t^{\beta_t}, \quad (4)$$

where p_1, \dots, p_s and q_1, \dots, q_t are distinct primes, $\alpha_1, \dots, \alpha_s$ are odd positive integers and β_1, \dots, β_t are even positive integers. We see from (4) that

$$x = SSC(n) = p_1 \dots p_s. \quad (5)$$

Since $\gcd(x, x^{r-1} + \dots + x + 1) = 1$, we get from (3), (4) and (5) that $\alpha_1 = \dots = \alpha_s = 1$ and

$$\frac{x^r - 1}{x - 1} = x^{r-1} + \dots + x + 1 = q_1^{\beta_1} \dots q_t^{\beta_t}. \quad (6)$$

Since β_1, \dots, β_t are even, let $b^2 = q_1^{\beta_1} \dots q_t^{\beta_t}$. Then b is a positive integer satisfying

$$\frac{x^r - 1}{x - 1} = b^2. \quad (7)$$

By Lemma, if $r > 2$, then from (7) we get $(x, b, r) = (3, 11, 5)$. It implies that $(n, r) = (363, 5)$ by (4) and (15).

If $r = 2$, then we have

$$x + 1 = b^2. \quad (8)$$

Let $a = x$. By (4), (5) and (7), we obtain the case (ii) immediately. Thus, the theorem is proved.

References

- [1] C. Dumitrescu and V. Seleacu, Some notions and questions in number theory, Xiquan Pub. House, Phoenix-Chicago, 1994.
- [2] W. Ljunggren, Noen setninger om ubestemte likninger av formen $(x^n - 1)/(x - 1) = y^q$, Norsk. Mat. Tidsskr. 25(1943), 17-20.
- [3] F. Russo, An introduction to the Smarandache square complementary function, Smarandache Notions J. 13(2002), 160-173.

SOME PROBLEMS CONCERNING THE SMARANDACHE SQUARE COMPLEMENTARY FUNCTION (V)

Maohua Le

Department of Mathematics

Zhanjiang Normal College

29 Cunjin Road, Chikan

Zhanjiang, Guangdong

P.R.China

Abstract: In this paper we discuss the convergence for two series concerning the Smarandache square complementary function.

Key words: Smarandache square complementary function; series; convergence

For any positive integer n , let $SSC(n)$ denote the Smarandache square complementary function of n (see [1]). Let

$$S_1 = \sum_{n=1}^{\infty} \frac{1}{SSC(n)^a}, \quad (1)$$

$$S_2 = \sum_{n=1}^{\infty} (-1)^n \frac{1}{SSC(n)}, \quad (2)$$

where a is a positive number. In [2], Russo proposed two problems concerning the convergence of the series (1) and (2). In this paper we prove the following two results.

Supported by the National Natural Science Foundation of China (No.10271104), the Guangdong Provincial Natural Science Foundation (No.011781) and the Natural Science Foundation of the Education Department of Guangdong Province (No.0161).

Theorem 1. If $a \leq 1$, then S_1 is divergence.

Theorem 2. The series S_2 is divergence.

Proof of Theorem 1. Let $\zeta(z)$ denote the Riemann ζ -function. Then we have

$$\zeta(z) = \sum_{n=1}^{\infty} \frac{1}{n^z}, \quad (3)$$

if z is a positive number. It is a well known fact that $SSC(n) \leq n$ for any n . Hence, by (1) and (3), we get

$$S_1 \geq \zeta(a). \quad (4)$$

Notice that $\zeta(a)$ is divergence if $a \leq 1$. Thus, we see from (4) that S_1 is divergence if $a \leq 1$. The theorem is proved.

Proof of Theorem 2. Let

$$S = \sum_{m=0}^{\infty} \frac{1}{SSC(2m+1)}. \quad (5)$$

We see from (2) that

$$S_2 = \sum_{n=1}^{\infty} (-1)^n \frac{1}{SSC(n)} = \sum_{k=0}^{\infty} \sum_{m=0}^{\infty} (-1)^{2^k(2m+1)} \frac{1}{SSC(2^k(2m+1))}. \quad (6)$$

Since

$$SSC(2^k(2m+1)) = \begin{cases} SSC(2m+1), & \text{if } k \text{ is even,} \\ 2SSC(2m+1), & \text{if } k \text{ is odd,} \end{cases} \quad (7)$$

we get from (5), (6) and (7) that

$$S_2 = -S + \frac{1}{2}S + S + \frac{1}{2}S + S + \dots \quad (8)$$

It implies that S_2 is divergence. The theorem is proved.

References

- [1] C.Dumitrescu and V. Seleacu, Some notions and questions in number theory, Xiquan Pub. House, Phoenix-Chicago, 1994.
- [2] F.Russo, An introduction to the Smarandache square complementary function, Smarandache Notions J. 13(2002), 160-173.

THE SMARANDACHE COMBINATORIAL SEQUENCES

Maohua Le

Department of Mathematics

Zhanjiang Normal College

29 Cunjin Road, Chikan

Zhanjiang, Guangdong

P.R.China

Abstract: Let r be a positive integer with $r > 1$, and let $SCS(r)$ denote the Smarandache combinatorial sequence of degree r . In this paper we prove that there has only the consecutive terms $1, 2, \dots, r$ of $SCS(r)$ are pairwise coprime.

Key words: Smarandache combinatorial sequences; consecutive terms; divisibility

Let r be a positive integer with $r > 1$. Let $SCS(r) = \{a(r, n)\}_{n=1}^{\infty}$ denote the Smarandache combinatorial sequence of degree r . Then we have

$$a(r, n) = n, n = 1, 2, \dots, r \quad (1)$$

Supported by the National Natural Science Foundation of China (No.10271104), the Guangdong Provincial Natural Science Foundation (No.011781) and the Natural Science Foundation of the Education Department of Guangdong Province (No.0161).

and $a(r,n)(n>r)$ is the sum of all the products of the previous terms of the sequence taking r terms at a time. In [2], Murthy asked that how many of the consecutive terms of $SCS(r)$ are pairwise coprime. In this respect, Le [1] proved that $SCS(2)$ has only the consecutive terms 1,2 are pairwise coprime. In this paper we completely solve this problem as follows.

Theorem. For any positive integer r with $r>1$, $SCS(r)$ has only the consecutive terms $1,2,\dots,r$ are pairwise coprime.

Proof. By the define of $SCS(r)$, if $n\geq r$, then we have

$$a(r,n) = \sum a(r,n_1)a(r,n_2)\cdots a(r,n_r), \quad (2)$$

where (n_1,n_2,\dots,n_r) through over all integers such that $1\leq n_1<n_2<\dots<n_r\leq n$. Hence, by (2), we get the recurrence

$$a(r,n+1) = a(r,n)a(r-1,n-1) + a(r,n). \quad (3)$$

Therefore, we find from (3) that if $n\geq r$, then

$$a(r,n+1) \equiv 0 \pmod{a(r,n)}. \quad (4)$$

It implies that $SCS(r)$ has no consecutive terms after $a(r,r)$ are pairwise coprime. Thus, by(1), the theorem is proved.

References

- [1] M. -H. Le, The divisibility of the Smarandache combinatorial sequence of degree two, to appear.
- [2] A. Murthy, Some new Smarandache sequences, functions and partitions, Smarandache Notions J. 11(2000), 179-183.

A CONJECTURE CONCERNING INDEXES OF BEAUTY

Maohua Le
Department of Mathematics
Zhanjiang Normal College
Zhanjiang, Guangdong
P. R. CHINA

Abstract. In this paper we prove that 64 is not an index of beauty.

Key words: divisor, index of beauty,

For any positive integer n , let $d(n)$ be the number of distinct divisors of n . It is a well known fact that if

$$(1) \quad n = p_1^{a_1} p_2^{a_2} \cdots p_k^{a_k}$$

is the factorization of n , then we have

$$(2) \quad d(n) = (a_1 + 1)(a_2 + 1) \cdots (a_k + 1)$$

(see[1]). For a fixed positive integer m , if there exist a positive integer n such that

$$(3) \quad m = \frac{n}{d(n)},$$

then m is called an index of beauty. Recently, Murthy [2] proposed the following conjecture:

Conjecture Every positive integer is an index of beauty.

In this paper we give a counter-example for the above-mentioned conjecture. We prove the following result:

Theorem 64 is not an index of beauty.

Proof We now suppose that 64 is an index of beauty. Then there exist a positive integer n such that

$$(4) \quad n = 64d(n).$$

We see from (4) that n is even. Hence, n has the factorization

$$(5) \quad n = 2^{a_0} p_1^{a_1} \cdots p_r^{a_r},$$

where p_1, \dots, p_r are odd primes with $p_1 < \cdots < p_r$, a_0 is a positive integer with $a_0 \geq 6$, a_1, \dots, a_r are positive integers. Let

$$(6) \quad b = a_0 - 6.$$

By (4), (5) and (6), we get

$$(7) \quad 2^b p_1^{a_1} \cdots p_r^{a_r} = (b+7)(a_1+1)\cdots(a_r+1).$$

Since p_1, \dots, p_r are odd primes, we have

$$(8) \quad p_i^{a_i} \geq \frac{2}{3}(a_i+1), i=1, \dots, r.$$

From (7) and (8), we get

$$(9) \quad b+7 \geq 2^b \left(\frac{3}{2}\right)^r \geq 2^{b-1}3.$$

It implies that $b \leq 2$.

If $b=2$, then from (7) we get $r=1$ and

$$(10) \quad 4p_1^{a_1} = 9(a_1+1),$$

whence we get $p_1=3$, $a_1 \geq 2$ and

$$(11) \quad 4 \cdot 3^{a_1-2} = a_1 + 1.$$

Since $4 \cdot 3^{a_1-2} > 4(1 + (a_1 - 2)\log 3) > 4(a_1 - 1) > a_1 + 1$, (11) is impossible.

If $b=1$, then from (7) we get

$$(12) \quad p_1^{a_1} \cdots p_r^{a_r} = 4(a_1 + 1) \cdots (a_r + 1).$$

Since p_1, \dots, p_r are odd primes, (12) is impossible.

If $b=0$, then from (7) we get

$$(13) \quad p_1^{a_1} \cdots p_r^{a_r} = 7(a_1 + 1) \cdots (a_r + 1).$$

We see from (13) that a_1+1, \dots, a_r+1 are odd. It implies that a_1, \dots, a_r are even. So we have $a_i \geq 2$ ($i=1, \dots, r$) and

$$(14) \quad p_i^{a_i} \geq 3(a_i + 1), i = 1, \dots, r.$$

By (13) and (14), we get $r=1$. Further, by (13), we obtain $p_1=7$ and

$$(15) \quad 7^{a_1-1} = a_1 + 1.$$

However, since $a_1 \geq 2$, (15) is impossible. Thus, 64 is not an index of beauty. The theorem is proved.

References

- [1] G. H. Hardy and E. M. Wright, An introduction to the theory of numbers, Oxford Univ. Press, Oxford, 1937.
- [2] A. Murthy, Some more conjectures on primes and divisors, Smarandache Notions J. 12(2001), 311-312.

THE SMARANDACHE-RIEMANN ZETA SEQUENCE

Maohua Le
Department of Mathematics
Zhanjiang Normal College
Zhanjiang, Guangdong
P. R. CHINA

Abstract. In this paper we prove that the Smarandach-Riemann sequence is not a sequence of integers. Moreover, no two integer terms of this sequence are relatively prime.

Key words: Riemann zeta function, Smarandache-Riemann zeta sequence

For any complex number s , let

$$(1) \quad \zeta(s) = \sum_{k=1}^{\infty} k^{-s}$$

be the Riemann zeta function. For any positive integer n , let T_n be a number such that

$$(2) \quad \zeta(2n) = \frac{\pi^{2n}}{T_n},$$

where π is ratio of the circumference of a circle to its diameter. Then the sequence $T = \{T_n\}_{n=1}^{\infty}$ is called the Smarandache-Riemann zeta sequence. In [2], Murthy believed that T is a sequence of integers. Simultaneous, he proposed the following conjecture:

Conjecture No two terms of T are relatively prime.

In this paper we prove the following results.

Theorem 1 If $\text{ord}(2, (2n)!) < 2n-2$, where $\text{ord}(2, (2n)!)$ is the order of prime 2 in $(2n)!$, then T_n is not an integer.

Theorem 2 No two integer terms of T are relatively prime.

Since $\text{ord}(2, 14!) = 11 < 12 = 2 \cdot 7 - 2$, by Theorem 1, we find that T is not a sequence of integers. However, by Theorem 2, the above-mentioned conjecture holds for all integer terms of T .

Proof of Theorem 1 It is a well known fact that

$$(3) \quad \zeta(2n) = (-1)^{n-1} \frac{2^{2n-1} \pi^{2n}}{(2n)!} B_n, n \geq 1,$$

where B_n is a Bernoulli number (see [1]). Notice that

$$(4) \quad B_n = (-1)^n \frac{a_n}{b_n}, n \geq 1,$$

where a_n and b_n are coprime positive integers satisfying

$$(5) \quad 2 \parallel b_n, 3 \mid b_n, n \geq 1.$$

By (2), (3) and (4), we get

$$(6) \quad T_n = \frac{(2n)! b_n}{2^{2n-1} a_n}, n \geq 1.$$

Since $\text{gcd}(a_n, b_n) = 1$ and b_n is even, we see that a_n is odd. Therefore, by (5) and (6), if $\text{ord}(2, (2n)!) + 1 < 2n - 1$, then T_n is not an integer. The theorem is proved.

Proof of Theorem 2 Let T_m and T_n be two integer terms of T with $m \neq n$. By (6), we get

$$(7) \quad T_m = \frac{(2m)! b_m}{2^{2m-1} a_m}.$$

Since $\text{gcd}(2, 3) = \text{gcd}(a_m, b_m) = \text{gcd}(a_n, b_n) = 1$, $3 \mid b_m$ and $3 \mid b_n$ by (5), we get from (6) and (7) that $3 \mid T_n$ and $3 \mid T_m$ respectively. It implies that $\text{gcd}(T_m, T_n) \geq 3 > 1$. The theorem is proved.

References

- [1] G. H. Hardy and E. M. Wright, An introduction to the theory of numbers, Oxford Univ. Press, Oxford, 1937.
- [2] A. Murthy, Some more conjectures on primes and divisors, Smarandache Notions J. 12(2001), 311-312.

On Third Power Mean Values Computation of Digital Sum Function in Base n

Li Hailong

Department of Mathematics, Weinan Teacher's College

Weinan Shaanxi, P.R.China

Abstract: let $m = a_1 n^{k_1} + a_2 n^{k_2} + \dots + a_s n^{k_s}$, where $1 \leq a_i < n, i = 1, 2, \dots, s, k_1 > k_2 > \dots > k_s \geq 0, a(m, n) = a_1 + a_2 + \dots + a_s$, for $A_k(N, n) = \sum_{m < N} a^k(m, n) (k = 1, 2, 3)$. An exact calculating formula for $A_k(N, n) (k = 1, 2, 3)$ is given.

Key word: base n function of digital sum mean value

§1 Introduction and Main Results

In problem 21 of [1], Professor F.Smarandache asked us to study the properties of the sequences of digital sum. In paper [2] and [3] we give exact calculating formulas for $A_1(N, n)$ and $A_2(N, n)$. In this paper, we give an exact calculating formula for $A_3(N, n)$. For convenience, let

$$\varphi_k(n) = \sum_{i=1}^{n-1} i^k, \quad \varphi_1(n) = \frac{n(n-1)}{2}, \quad \varphi_2(n) = \frac{n(n-1)(2n-1)}{6}.$$

First we have the following.

Definition. Assume $n (n \geq 2)$ be a fixed positive integer, for any positive integer m in base n , let $m = a_1 n^{k_1} + a_2 n^{k_2} + \dots + a_s n^{k_s}$, where $k_1 > k_2 > \dots > k_s \geq 0, 1 \leq a_i < n, i = 1, 2, \dots, s$. Then

$$a(m, n) = a_1 + a_2 + \dots + a_s \text{ and for any positive integer } r, A_r(N, n) = \sum_{m < N} a^r(m, n).$$

Theorem 1. Let $N = a_1 n^{k_1} + a_2 n^{k_2} + \dots + a_s n^{k_s}$, where $k_1 > k_2 > \dots > k_s \geq 0; 1 \leq a_i < n;$

$i = 1, 2, \dots, s$, Then

$$A_3(N, n)$$

$$= \sum_{i=1}^s (k_i a_i \varphi_1^2(n) ((2n-1) + \frac{1}{2}(n-1)(k_i-3)k_i) + 3\varphi_2(n)(2a_i \varphi_1(n) \varphi_1(k_i) + n k_i \varphi_1(a_i)) + 3n \varphi_1(n)$$

$$((n-1) \varphi_1(a_i) \varphi_1(k_i) + k_i \varphi_2(a_i)) + n^2 \varphi_1^2(a_i) + 3n (\sum_{j=1}^{i-1} a_j) (k_i a_i \varphi_2(n) + n \varphi_2(a_i) + (n-1) a_i$$

$$\varphi_1(n) \varphi_1(k_i) + 2k_i \varphi_1(a_i) \varphi_1(n)) + \frac{3}{2} n^2 a_i (\sum_{j=1}^{i-1} a_j)^2 ((n-1) k_i + (a_i - 1)) + n^2 a_i (\sum_{j=1}^{i-1} a_j)^3 n^{k_i-2}.$$

This work is supported by the N.S.F. and P.N.S.F. of P.R.China

Corollary 1. Let $N = 2^{k_1} + 2^{k_2} + \dots + 2^{k_s}$, where $k_1 > k_2 > \dots > k_s \geq 0$, then

$$A_3(N, 2) = \sum_{i=1}^s (k_i^3 + 3(2i-1)k_i^2 + 6(i-1)(2i-1)k_i + 8(i-1)^3) 2^{k_i-3}.$$

Corollary 2. Let $N = a_1 10^{k_1} + a_2 10^{k_2} + \dots + a_s 10^{k_s}$, where $1 \leq a_i < 10$, $i = 1, 2, \dots, s$;

$k_1 > k_2 > \dots > k_s \geq 0$, then

$$A_3(N, 10) =$$

$$25 \sum_{i=1}^s (40\varphi_1^2(a_i) + 3645k_i(k_i - 3) + 180k_i a_i(a_i^2 + 8a_i + 14) + 15390k_i^2 a_i - 2430(k_i + a_i - 1) +$$

$$30(\sum_{j=1}^{i-1} a_j)(36\varphi_1(a_i) + 4\varphi_2(a_i) + 3k_i a_i(27k_i + 11)) + 60a_i(\sum_{j=1}^{i-1} a_j)^2(9k_i + a_i - 1) + 40(\sum_{j=1}^{i-1} a_j)^3) 10^{k_i-3}$$

§2 Proof of the theorem

In this section, we complete the proof of the theorem. First we have six simple lemmas.

Let n, a are positive integers, k is an integer, we have five lemmas.

Lemma 1^[2]. $A_1(n^k, n) = \frac{n-1}{2} kn^k$. (1)

Lemma 2^[2]. $A_1(an^k, n) = \frac{a}{2}((n-1)k + (a-1))n^k$. (2)

Lemma 3^[3]. $A_2(n^k, n) = (k\varphi_2(n) + (n-1)\varphi_1(n)\varphi_1(k))n^{k-1}$. (3)

Lemma 4^[3].

$$A_2(an^k, n) = (ka\varphi_2(n) + n\varphi_2(a) + (n-1)\varphi_1(n)\varphi_1(k) + 2k\varphi_1(n)\varphi_1(a))n^{k-1}$$
 (4)

Lemma 5.

$$A_3(n^k, n) = (k\varphi_1^2(n)((2n-1) + \frac{1}{2}(n-1)(k-3)k) + 6\varphi_1(n)\varphi_2(n)\varphi_1(k))n^{k-2}$$
 (5)

Proof. We only prove the identity (5)

If $k = 1$, then

$$\text{The left of the equation} = A_3(n, n) = a^3(1, n) + (2-1, n) + \dots + a^3(n-1, n)$$

$$= 1^3 + 2^3 + \dots + (n-1)^3$$

$$= \varphi_1^2(n).$$

$$\text{The right of the equation} = n\varphi_1^2(n) \cdot n^{-1} = \varphi_1^2(n).$$

So the left and right of the equation (5) equals, the proposition is correct.

Assume $k = p$, lemma (5) is correct. That is,

$$A_3(n^p, n) = \left(p\varphi_1^2(n)((2n-1) + \frac{1}{2}(n-1)(p-3)p) + 6\varphi_1(n)\varphi_2(n)\varphi_1(p) \right) n^{p-2}.$$

$$\begin{aligned} \text{Then } A_3(n^{p+1}, n) &= \sum_{m < n^{p+1}} a^3(m, n) \\ &= \sum_{m < n^p} a^3(m, n) + \sum_{n^p \leq m < 2n^p} a^3(m, n) + \cdots + \sum_{(n-1)n^p \leq m < n^{p+1}} a^3(m, n) \\ &= \sum_{m < n^p} a^3(m, n) + \sum_{0 \leq m < n^p} (a(m, n) + 1)^3 + \cdots + \sum_{0 \leq m < n^p} (a(m, n) + (n-1))^3 \\ &= n \sum_{m < n^p} a^3(m, n) + 3 \sum_{m < n^p} a^2(m, n) \left(\sum_{i=1}^{n-1} i \right) + 3 \sum_{m < n^p} a(m, n) \left(\sum_{i=1}^{n-1} i^2 \right) + \left(\sum_{i=1}^{n-1} i^3 \right) n^p \\ &= nA_3(n^p, n) + 3\varphi(n)A_2(n^p, n) + 3\varphi_2(n)A_1(n^p, n) + \varphi_1^2(n)n^p. \end{aligned}$$

Combining inductive assume, (1) and (2), we immediately get

$$\begin{aligned} A_3(n^{p+1}, n) &= \left(p\varphi_1^2(n)((2n-1) + \frac{1}{2}(n-1)(p-3)p) + 6\varphi_1(n)\varphi_2(n)\varphi_1(p) \right) n^{p-1} + 3\varphi_1(n)(p\varphi_2(n) \\ &\quad + \varphi_1(n)\varphi_1(p)(n-1))n^{p-1} + \frac{3}{2}(n-1)p\varphi_2(n)n^p + \varphi_1^2(n)n^p \\ &= \left((p+1)\varphi_1^2(n)((2n-1) + \frac{1}{2}(n-1)(p-2)(p+1)) + 6\varphi_1(n)\varphi_2(n)\varphi_1(p+1) \right) n^{p-2}. \end{aligned}$$

So lemma 5 is also correct for $k = p+1$.

Lemma 6.

$$\begin{aligned} A_3(an^k, n) &= \left(ka\varphi_1^2(n)((2n-1) + \frac{1}{2}(n-1)(k-3)k) + 3\varphi_2(n)(2a\varphi_1(n)\varphi_1(k) + kn\varphi_1(a)) \right. \\ &\quad \left. + 3n\varphi_1(n)((n-1)\varphi_1(a)\varphi_1(k) + k\varphi_2(a)) + n^2\varphi_1^2(a) \right) n^{k-2} \end{aligned} \quad (6)$$

$$\begin{aligned} \text{proof. } A_3(an^k, n) &= \sum_{m < an^k} a^3(m, n) \\ &= \sum_{m < n^k} a^3(m, n) + \sum_{n^k \leq m < 2n^k} a^3(m, n) + \cdots + \sum_{(a-1)n^k \leq m < an^k} a^3(m, n) \\ &= \sum_{m < n^k} a^3(m, n) + \sum_{0 \leq m < n^k} (a(m, n) + 1)^3 + \cdots + \sum_{0 \leq m < n^k} (a(m, n) + (a-1))^3 \\ &= a \sum_{m < n^k} a^3(m, n) + 3 \sum_{m < n^k} a^2(m, n) \left(\sum_{i=1}^{a-1} i \right) + 3 \sum_{m < n^k} a(m, n) \left(\sum_{i=1}^{a-1} i^2 \right) + \left(\sum_{i=1}^{a-1} i^3 \right) n^k \\ &= aA_3(n^k, n) + 3\varphi(a)A_2(n^k, n) + 3\varphi_2(a)A_1(n^k, n) + \varphi_1^2(a)n^k \end{aligned}$$

Combining (1), (3) and (5), we get

$$\begin{aligned} A_3(an^k, n) &= \left(ka\varphi_1^2(n)((2n-1) + \frac{1}{2}(n-1)(k-3)k) + 3\varphi_2(n)(2a\varphi_1(n)\varphi_1(k) + kn\varphi_1(a)) \right. \\ &\quad \left. + 3n\varphi_1(n)((n-1)\varphi_1(a)\varphi_1(k) + k\varphi_2(a)) + n^2\varphi_1^2(a) \right) n^{k-2}. \end{aligned}$$

This proves lemma 6.

Now we use the above six lemmas to complete the proof of the theorem,

$$\begin{aligned}
 A_3(N, n) &= \sum_{m < N} a^3(m, n) \\
 &= \sum_{m < a_1 n^{k_1}} a^3(m, n) + \sum_{a_1 n^{k_1} \leq m < a_1 n^{k_1} + a_2 n^{k_2}} a^3(m, n) + \cdots + \sum_{N - a_s n^{k_s} \leq m < N} a^3(m, n) \\
 &= \sum_{m < a_1 n^{k_1}} a^3(m, n) + \sum_{0 \leq m < a_2 n^{k_2}} (a(m, n) + a_1)^3 + \cdots + \sum_{0 \leq m < a_s n^{k_s}} (a(m, n) + \sum_{i=1}^{s-1} a_i)^3 \\
 &= \sum_{i=1}^s A_3(a_i n^{k_i}) + 3 \sum_{i=1}^s \left(\sum_{j=1}^{i-1} a_j \right) A_2(a_i n^{k_i}) + 3 \sum_{i=1}^s \left(\sum_{j=1}^{i-1} a_j \right)^2 A_1(a_i n^{k_i}) + \sum_{i=1}^s \left(\sum_{j=1}^{i-1} a_j \right)^3 a_i n^{k_i}
 \end{aligned}$$

From (2), (4) and (6), we have

$$\begin{aligned}
 &A_3(N, n) \\
 &= \sum_{i=1}^s \left(k_i a_i \varphi_1^2(n) \left((2n-1) + \frac{1}{2}(n-1)(k_i - 3)k_i \right) + 3\varphi_2(n) \left(2a_i \varphi_1(n) \varphi_1(k_i) + n k_i \varphi_1(a_i) \right) + 3n \varphi_1(n) \right. \\
 &\quad \left. \left((n-1) \varphi_1(a_i) \varphi_1(k_i) + k_i \varphi_2(a_i) \right) + n^2 \varphi_1^2(a_i) + 3n \left(\sum_{j=1}^{i-1} a_j \right) \left(k_i a_i \varphi_2(n) + n \varphi_2(a_i) + (n-1) a_i \right. \right. \\
 &\quad \left. \left. \varphi_1(n) \varphi_1(k_i) + 2k_i \varphi_1(a_i) \varphi_1(n) \right) + \frac{3}{2} n^2 a_i \left(\sum_{j=1}^{i-1} a_j \right)^2 \left((n-1)k_i + (a_i - 1) \right) + n^2 a_i \left(\sum_{j=1}^{i-1} a_j \right)^3 \right) n^{k_i - 2}
 \end{aligned}$$

This completes the proof of the Theorem.

REFERENCES

- [1] Florentin Smarandache, Only Problems, not solutions! Chicago, Xiquan Publishing house, 1993, PP. 22.
- [2] LI Hai-long and YANG Qian-li, On base n and related counting function[J]. Pure and applied mathematics 2002, 3, Vol. 18, No. 1, PP. 13-15.
- [3] YANG Qian-li and LI Hai-long, The mean value of the function of nonzero digital sum. Journal of Northwest university (Natural science edition), 2002, 7, Vol. 32, No. 4.

A lucky derivative

Henry Bottomley

5 Leydon Close, London SE16 5PF, U.K.

se16@btinternet.com <http://www.se16.btinternet.co.uk/hgb/>

Question:

What is the value of the derivative of $f(x) = e^x$ when $x = e$?

Lucky answer:

We know that the derivative of $g(x) = x^n$ is $g'(x) = n \cdot x^{n-1}$,

and when $x = n$ this is $g'(n) = n \cdot n^{n-1} = n^n$,

so the derivative of $f(x) = e^x$ when $e = x$ is $f'(e) = x \cdot e^{x-1} = x^x = e^e = 15.15426\dots$

As a check, note that $f(e) = e^e = f'(e)$ and $g(n) = n^n = g'(n)$.

Comments

This is in the tradition of other lucky mathematics. For example, when simplifying the fraction $16/64$, canceling the 6s in the numerator and denominator leaves the correct result of $1/4$.

In the smarandacheian lucky answer to the derivative, the only incorrect part is the word "so". The derivative of $f(x) = e^x$ with respect to x is $f'(x) = e^x$, not $x \cdot e^{x-1}$ (unless $x = e$ in which case these are equal).

Conversely, $x \cdot e^{x-1}$ has the indefinite integral $(x-1) \cdot e^{x-1} + C$ rather than $e^x + C$.

The derivative of $h(x) = c^x$ is $h'(x) = \log_e(c) \cdot c^x$ for a positive constant c , and so when $x = c$ it is $h'(c) = \log_e(c) \cdot c^c$, not c^c (unless $c = e$ in which case these are equal).

This lucky (i.e. wrong) derivative method can produce the correct answer to the more general question:

"What is the value of the derivative of $h(x) = c^x$ when $x = c \cdot \log_e(c)$?"

(if c is a positive integer then x is close to the c^{th} prime number):

$$h'(c \cdot \log_e(c)) = c \cdot \log_e(c) \cdot c^{c \cdot \log_e(c) - 1} = \log_e(c) \cdot c^{c \cdot \log_e(c)}.$$

References:

Ashbacher, Charles, "Smarandache Lucky Math", in *Smarandache Notions Journal*, Vol. 9, p. 143, Summer 1998.

<http://www.gallup.unm.edu/~smarandache/SNBook9.pdf>

Smarandache, Florentin, "The Lucky Mathematics!", in *Collected Papers*, Vol. II, p. 200, University of Kishinev Press, Kishinev, 1997.

<http://www.gallup.unm.edu/~smarandache/CP2.pdf>

A Classification of s-Lines in a Closed s-Manifold

Howard Iseri
Dept. of Mathematics and Computer Information Science
Mansfield University
Mansfield, PA 16933
hiseri@mnsfld.edu

Abstract: In *Smarandache Manifolds* [1], it is shown that the s-sphere has both closed and open s-lines. It is shown here that this is true for any closed s-manifold. This would make each closed s-manifold a Smarandache geometry relative to the axiom requiring each line to be extendable to infinity, since each closed s-line would have finite length. Furthermore, it is shown that whether a particular s-line is closed or not is determined locally, and it is determined precisely which s-lines are closed and which are open.

Introduction

Recall that an s-manifold is the union of equilateral triangular disks that are identified edge to edge. Furthermore, each vertex is shared by exactly five, six, or seven distinct triangles, and each edge is shared by exactly two distinct triangles. The s-lines are defined to be curves that are as straight as possible. In particular, they are straight in a very natural sense within each triangle and across the edges. Across vertices, s-lines make two equal angles (see [1]). In general, a manifold is closed if it is compact and has no boundary, like the surface of a sphere or torus. Here, the term *closed* is used in the same way that it is used in *simple closed curve*. Since each edge is identified in an s-manifold, there is no boundary. Therefore, an s-manifold being closed is equivalent to its consisting of a finite number of triangles.

In [1], the concept of a locally linear projection was used to investigate the behavior of s-lines in the s-sphere. We will expand on that investigation here.

Locally Linear Projections

The plane can be tiled by equilateral triangles. The tiling we will use is the one that has the segment from $(0,0)$ to $(1,0)$ as one of the edges, and we will focus initially on the triangle that lies above this segment. A locally linear projection of an s-line l from an s-manifold is constructed as follows. Choose a segment from l that spans one of the triangles. We identify this triangle with the one that lies above the segment from $(0,0)$ to $(1,0)$ so that exactly one point of l lies on this segment. This can be done in several ways. We then extend this segment in one direction, exactly as it extends in the s-manifold. At a vertex, we will maintain the angle that lies to the right of the projection.

In this tiling, all points in the plane can be expressed as a linear combination of the vectors $[1,0]$ and $[1/2, \sqrt{3}/2]$. The vertices of the triangles correspond to those linear

combinations with integer coefficients. The linear combination $a[1,0] + b[1/2, \sqrt{3}/2]$ has rectangular coordinates $(a+b/2, \sqrt{3}b/2)$. In rectangular coordinates, the point (x,y) corresponds to $(x-y/\sqrt{3})[1,0] + (y/\sqrt{3})[1/2, \sqrt{3}/2]$. It follows that a line from the origin to any vertex will have slope $m = \sqrt{3}b/(2a+b)$ with a and b integers. If a line from the origin has slope $m = \sqrt{3}y/x$ with x and y integers (i.e., m is a rational multiple of $\sqrt{3}$), then it will pass through the vertex $(x-y)[1,0] + y[1/2, \sqrt{3}/2]$. In other words, a line will pass through the origin and another vertex, if, and only if, it is a rational multiple of $\sqrt{3}$. Clearly, this can be extended to the following.

Lemma 1. *A line passing through a vertex will pass through another vertex, if, and only if, its slope is a rational multiple of $\sqrt{3}$.*

The locally linear projection of an s -line will change directions only at certain vertices. It is reasonable to talk about the slope m of the projection and the angle θ it makes with the positive x -axis, even though it may change from segment to segment. The relation between these is $m = \tan \theta$. When an s -line passes through an elliptic vertex (one with five triangles around it), the slope of its projection is reduced by 30° . When it passes through a hyperbolic vertex (one with seven triangles around it), the slope of its projection is increased by 30° . Since $\tan(\theta+30^\circ) = \sqrt{3}(\tan \theta/\sqrt{3} + 1/3)/(1 - \tan \theta/\sqrt{3})$ and $\tan(\theta-30^\circ) = \sqrt{3}(\tan \theta/\sqrt{3} - 1/3)/(1 + \tan \theta/\sqrt{3})$, it is clear that $\tan(\theta+30^\circ)$ and $\tan(\theta-30^\circ)$ will be rational multiples of $\sqrt{3}$ whenever $\tan \theta$ is. This gives us the following.

Lemma 2. *The angle of a locally linear projection of an s -line is constant modulo 30° , and its slope will always be a rational multiple of $\sqrt{3}$, or it will always be an irrational multiple of $\sqrt{3}$.*

Classification of Closed and Open s -Lines

Given some closed s -manifold, it would seem that whether a particular s -line is closed or not would depend on the global structure of the s -manifold. We will show, however, that we can determine this by looking at a segment of the s -line in any of the triangles of the s -manifold.

Let l be an s -line. We look at a segment of it that spans some triangle, and consider a locally linear projection λ based on this segment. The slope of the initial segment in the triangle above the segment from $(0,0)$ to $(1,0)$ has a slope m . We will show the following.

Theorem. *The s -line l is closed if m is a rational multiple of $\sqrt{3}$, and l is open if m is an irrational multiple of $\sqrt{3}$.*

In the case that m is a rational multiple of $\sqrt{3}$, we know that the slope of λ may change, but the slope will always be a rational multiple of $\sqrt{3}$. Lemmas 1 and 2 show that if λ passes through one vertex, then it must pass through infinitely many. If this is

the case, and since the angle is constant modulo 30° , there must be infinitely many of these vertices where λ enters these vertices at precisely the same angle. Each of these corresponds to l entering a vertex on the s -manifold at a particular angle with one of the edges. Since this can only happen a finite number of ways, l must enter a particular vertex on the s -manifold an infinite number of times in exactly the same way. This can only happen if l is closed.

If λ does not pass through a vertex (and so l does not either), then λ is a straight line in the plane. Its initial point has coordinates $(c,0)$ with $0 < c < 1$ and slope $m = y\sqrt{3}/x$ where both x and y are integers. For each positive integer z , λ passes through the point $[c,0] + z(x-y)[1,0] + zy[1/2, \sqrt{3}/2]$. This is a point, which is a distance c from the left endpoint of the horizontal edge from some triangle in the tiling. This corresponds to l intersecting some edge in the s -manifold in a particular way, and this can only happen a finite number of different ways. It follows that l intersects a particular edge exactly the same way an infinite number of times, and this can only happen if l is closed.

On the other hand, if l is closed, and l passes through a vertex, then any projection must pass through infinitely many vertices. This can only happen if m is a rational multiple of $\sqrt{3}$. If l passes through no vertex, then its projection λ is a straight line. Since l is closed, it intersects edges in only finitely many different ways. Therefore, λ must intersect two horizontal edges in exactly the same way. In particular, for some $0 < c < 1$, the intersections must be $[c,0] + a[1,0] + b[1/2, \sqrt{3}/2]$ and $[c,0] + A[1,0] + B[1/2, \sqrt{3}/2]$. The slope is, therefore, $m = \sqrt{3}(B-b)/(2(A-a)+(B-b))$ a rational multiple of $\sqrt{3}$.

Conclusion

The axiom, each line is extendable to infinity, is S-denied in every closed s -manifold. We can say that this axiom is S-denied densely, since we can look at all of the s -lines at each point, and all the angles that correspond to closed s -lines are (topologically) dense in the interval $[0^\circ, 360^\circ]$, as are the angles that correspond to open s -lines. In other words, within any angle emanating from a point P , no matter how small, there are closed and open s -lines in the interior of the angle.

The arguments presented here hold in any s -manifold, except for the parts depending on there being a finite number of triangles. In particular, if a projection of an s -line has a slope that is a rational multiple of $\sqrt{3}$, then it will intersect edges and vertices in only a limited number of ways. Its local structure, therefore, is in some sense periodic.

References

1. Iseri, H., *Smarandache Manifolds*, American Research Press, 2002.

A BASIC CHARACTERISTIC OF TWIN PRIMES AND ITS GENERALIZATION

Sebastián Martín Ruiz
Avda de Regla, 43
Chipiona 11550, Spain
Smaranda@teleline.es

Azmy Ariff
P O Box 444, Jalan Sultan
Petaling Jaya 46750, Malaysia
azmyariff@tm.net.my

ABSTRACT. *The sum of powers of positive divisors of an integer, expressed in terms of the floor function, provides the basis for another characterization of twin primes in particular, and of prime k -tuples generally. This elementary characterization is deployed in a software test for prime k -tuples using Mathematica®.*

Keywords: *Prime k -tuples, twin primes, primality test, number and sum of divisors, floor function.*

2000 Mathematics Subject Classification: *Primary 11A51; Secondary 11A25, 11B04.*

Introduction

Prime numbers [6] are integers > 1 divisible only by unity and itself. Thus, 2, 3, 5, 7, 11, 13, 17, 19, 23, 29, 31, 37, 41, ... are the first few primes. And, twin primes [12] are those pairs of primes, like (5, 7) or (13001, 13003), differing by 2.

There are exactly 27 412 679 such twins up to ten billion compared to 455 052 511 individual primes below the same limit. The largest known twin primes are $665\,551\,035 \cdot 2^{80025} \pm 1$, each of 24 099 digits, discovered by *David Underbakke* and *Yves Gallot* [3] on November 28, 2000.

What condition is necessary for a number pair to be twin primes? In 1949, *P A Clement* [4] characterized twin primes by proving that for $n \geq 2$, the pair $(n, n+2)$ of integers are twin primes if and only if $4[(n-1)!+1]+n \equiv 0 \pmod{n(n+2)}$. Unfortunately, this test has no practical application due to the high cost of computing the factorial function.

By comparison, the following alternative characterization, found by *Ruiz* in 2000 and reported by *Eric W Weisstein* [17] on the Internet, is computationally friendlier.

Theorem 1 For $a \geq 0$, the pair $(n, n+2)$ of integers are twin primes if and only if

$$\sum_{i=1}^n i^a \left(\left\lfloor \frac{n+2}{i} \right\rfloor + \left\lfloor \frac{n}{i} \right\rfloor \right) = 2 + n^a + \sum_{i=1}^n i^a \left(\left\lfloor \frac{n+1}{i} \right\rfloor + \left\lfloor \frac{n-1}{i} \right\rfloor \right)$$

where $\lfloor x \rfloor$ is the floor function [8] [9] denoting the greatest integer not exceeding x .

This article provides a proof of the above result, its generalization to other prime k -tuples, and the Mathematica® [16] [18] code for implementing the k -tuple primality test.

Preliminaries

This article is dependent on the following simple fact published in the following article of The Smarandache Notion Journal: [14] and seldom explicitly mentioned in standard texts on number theory. Known exceptions are those by *Trygve Nagell* [11] and *David M Burton* [2].

Lemma 1 For $n > 0$, $\left\lfloor \frac{n}{i} \right\rfloor - \left\lfloor \frac{n-1}{i} \right\rfloor = 1$ or 0 according as i divides n or not.

Proof We recall the division algorithm [15] which states that for any integers n and i , with i positive, there are unique integers q (*quotient*) and r (*remainder*) such that $n = qi+r$, where $i > r \geq 0$.

By the division algorithm, if $i | n$ then $r = 0$ giving $\left\lfloor \frac{n}{i} \right\rfloor = q$, $\left\lfloor \frac{n-1}{i} \right\rfloor = q-1$.

Otherwise, $i > r > 0$ giving $\left\lfloor \frac{n}{i} \right\rfloor = \left\lfloor \frac{n-1}{i} \right\rfloor = q$. ■

We now consider the two arithmetic functions [10] $\tau(n)$ and $\sigma_a(n)$ which are intimately related to the above property. The divisor function $\tau(n)$, the number of positive divisors of n , is expressed as $\sum_{d|n} 1$, while the sum $\sigma_a(n)$ of the a^{th} powers of the positive divisors of n can be written as $\sum_{d|n} d^a$. Thus, $\tau(n) = \sigma_0(n)$ and Lemma 1 implies the relationships:

$$\tau(n) = \sum_{i=1}^n \left(\left\lfloor \frac{n}{i} \right\rfloor - \left\lfloor \frac{n-1}{i} \right\rfloor \right) \quad (1)$$

$$\sigma_a(n) = \sum_{i=1}^n i^a \left(\left\lfloor \frac{n}{i} \right\rfloor - \left\lfloor \frac{n-1}{i} \right\rfloor \right) \quad (2)$$

In what follows, the arithmetic functions $\tau(n)$ and $\sigma_a(n)$ shall be defined only for positive values of their arguments. And, 1 is neither prime nor composite.

Defining *proper* divisors of n as those excluding 1 and n , we derive a more efficient version of relation (1) with minimal change.

Lemma 2 For $n > 1$, $\tau(n) = 2 + \sum_{i=2}^j \left(\left\lfloor \frac{n}{i} \right\rfloor - \left\lfloor \frac{n-1}{i} \right\rfloor \right)$ where j is the highest proper divisor of n , the summation being 0 if j is nonexistent.

Proof Clearly, none of $j+1, j+2, \dots, n-1$ are divisors of n and the constant 2 accounts for the cases $i = 1$ and $i = n$ which are not proper divisors of n . ■

In general, it is sufficient to assume that j is $\left\lfloor \frac{n}{2} \right\rfloor$ or $\left\lfloor \frac{n}{3} \right\rfloor$ according as n is even or odd. In particular, it may be possible to choose the parity of i for specific cases of n . Applying such resources on Theorem 1, we readily obtain the example:

Corollary 1 For odd $n > 7$, the pair $(n, n+2)$ of integers are twin primes if and only if

$$\sum_{i \text{ odd}}^j \left(\left\lfloor \frac{n+2}{i} \right\rfloor - \left\lfloor \frac{n+1}{i} \right\rfloor + \left\lfloor \frac{n}{i} \right\rfloor - \left\lfloor \frac{n-1}{i} \right\rfloor \right) = 2$$

where the summation is over odd values of i through $j = \left\lfloor \frac{n}{3} \right\rfloor$.

We next establish two lemmas, including an extended expression for $\sigma_a(n+e)$, which will become useful in proving Theorem 1 and its generalization.

Lemma 3 If $a \geq 0$ and $(n+2) > e > 0$, then

$$\sigma_a(n+e) = \sum_{i=1}^n i^a \left(\left\lfloor \frac{n+e}{i} \right\rfloor - \left\lfloor \frac{n+e-1}{i} \right\rfloor \right) + (n+e)^a$$

Proof

Clearly $(n+2) > e > 0 \rightarrow 2 > \frac{n+e}{n+1} \geq 1 \rightarrow \left\lfloor \frac{n+e}{n+j} \right\rfloor = 1$ for $1 \leq j \leq e$

so that $\sum_{i=n+1}^{n+e} i^a \left(\left\lfloor \frac{n+e}{i} \right\rfloor - \left\lfloor \frac{n+e-1}{i} \right\rfloor \right) = \sum_{i=n+1}^{n+e} i^a - \sum_{i=n+1}^{n+e-1} i^a = (n+e)^a$.

$$\begin{aligned} \text{Thus } \sigma_a(n+e) &= \sum_{i=1}^{n+e} i^a \left(\left\lfloor \frac{n+e}{i} \right\rfloor - \left\lfloor \frac{n+e-1}{i} \right\rfloor \right) \text{ by (2)} \\ &= \sum_{i=1}^n i^a \left(\left\lfloor \frac{n+e}{i} \right\rfloor - \left\lfloor \frac{n+e-1}{i} \right\rfloor \right) + (n+e)^a \quad \blacksquare \end{aligned}$$

Lemma 4

For a set $\{l, m_1, m_2, \dots, m_k\}$ of positive integers,

$$\sum_{i=1}^k \sigma_a(m_i) = k + \sum_{i=1}^k m_i^a$$

if and only if m_1, m_2, \dots, m_k are all primes.

Proof

The condition in the lemma is evidently sufficient. To prove equivalence, we note that

$$\sigma_a(m_i) \geq 1 + m_i^a$$

by counting only the non-proper divisors of m_i and therefore

$$\sum \sigma_a(m_i) \geq \sum 1 + \sum m_i^a \quad (3)$$

over equal summation limits.

Without loss of generality, suppose now that $\sigma_a(m_1) > 1 + m_1^a$,

that is $k + \sum_{i=1}^k m_i^a - \sum_{i=2}^k \sigma_a(m_i) > 1 + m_1^a$

or $\sum_{i=2}^k \sigma_a(m_i) < (k-1) + \sum_{i=2}^k m_i^a$

which contradicts (3), and therefore $\sigma_a(m_1) = 1 + m_1^a$.

Hence m_1 is prime. Similarly, the hypothesis $\sigma_a(m_i) > 1 + m_i^a$ yields a contradiction for each other i and the result follows. \blacksquare

3 Proof of Theorem 1

If the pair $(n, n+2)$ of integers are twin primes, then by definition,

$$\sigma_a(n) + \sigma_a(n+2) = 2 + n^a + (n+2)^a \quad (4)$$

From (2) and Lemma 3, we also have

$$\sigma_a(n) + \sigma_a(n+2) = \sum_{i=1}^n i^a \left(\left\lfloor \frac{n+2}{i} \right\rfloor - \left\lfloor \frac{n+1}{i} \right\rfloor + \left\lfloor \frac{n}{i} \right\rfloor - \left\lfloor \frac{n-1}{i} \right\rfloor \right) + (n+2)^a$$

$$\text{Hence } \sum_{i=1}^n i^a \left(\left\lfloor \frac{n+2}{i} \right\rfloor + \left\lfloor \frac{n}{i} \right\rfloor \right) = 2 + n^a + \sum_{i=1}^n i^a \left(\left\lfloor \frac{n+1}{i} \right\rfloor + \left\lfloor \frac{n-1}{i} \right\rfloor \right) \quad (5)$$

Conversely, if (5) holds, then (4) is implied and Lemma 4 completes the proof. \blacksquare

A generalization

A set $\{e_1, e_2, \dots, e_k\}$ of positive integers is said to be *admissible* if $n, n+e_1, n+e_2, \dots, n+e_k$ is not excluded by divisibility considerations as a possible sequence of primes. Thus, $\{2, 6\}$ and $\{4, 6\}$ are admissible sets. But $\{2, 4\}$ is not, as $(n, n+2, n+4)$ is never a prime triplet when $n > 3$. *Hans Riesel* [13] discusses a method of determining admissible sets.

Theorem 2 If $a \geq 0, e_0 = 0$ and $\{e_1, e_2, \dots, e_k\}$ is an admissible set of positive integers in the open interval $(0, n-2)$, then $(n, n+e_1, n+e_2, \dots, n+e_k)$ is a sequence of primes if and only if

$$\sum_{i=1}^n i^a \left(\sum_{j=0}^k \left\lfloor \frac{n+e_j}{i} \right\rfloor \right) = 1 + k + n^a + \sum_{i=1}^n i^a \left(\sum_{j=0}^k \left\lfloor \frac{n+e_j-1}{i} \right\rfloor \right)$$

Proof If $(n+e_0, n+e_1, n+e_2, \dots, n+e_k)$ is a prime $(k+1)$ -tuple, then by definition

$$\sum_{j=0}^k \sigma_a(n+e_j) = 1 + k + \sum_{j=0}^k (n+e_j)^a \quad (6)$$

From (2) and Lemma 3, we also have

$$\sum_{j=0}^k \sigma_a(n+e_j) = \sum_{i=1}^n i^a \left(\sum_{j=0}^k \left(\left\lfloor \frac{n+e_j}{i} \right\rfloor - \left\lfloor \frac{n+e_j-1}{i} \right\rfloor \right) \right) + \sum_{j=1}^k (n+e_j)^a \quad (7)$$

Equating (6) and (7) and simplifying, we obtain

$$\sum_{i=1}^n i^a \left(\sum_{j=0}^k \left(\left\lfloor \frac{n+e_j}{i} \right\rfloor - \left\lfloor \frac{n+e_j-1}{i} \right\rfloor \right) \right) = 1 + k + n^a \quad (8)$$

Conversely, if (8) holds, then (6) is implied and Lemma 4 completes the proof. ■

A variation

Theorem 2, as it stands, requires $n > \max\{e_1, e_2, \dots, e_k\} - 2$ through its dependence on the open interval $(0, n+2)$. However, that restriction may be removed by avoiding Lemma 3 in the proof of the theorem.

Proof By Lemma 1, if $(n+e_j)$ is prime, then

$$\sum_{j=0}^k \left(\left\lfloor \frac{n+e_j}{i} \right\rfloor - \left\lfloor \frac{n+e_j-1}{i} \right\rfloor \right) = \begin{cases} 1+k & \text{if } i=1 \\ 1 & \text{if } i=n \\ 0 & \text{otherwise} \end{cases}$$

Therefore, if $(n+e_0, n+e_1, n+e_2, \dots, n+e_k)$ are all primes, then

$$\sum_{i=1}^n i^a \sum_{j=0}^k \left(\left\lfloor \frac{n+e_j}{i} \right\rfloor - \left\lfloor \frac{n+e_j-1}{i} \right\rfloor \right) = 1 + k + n^a \quad (9)$$

as all other terms, involving non-divisors, vanish.

However, if any one of $(n+e_0, n+e_1, n+e_2, \dots, n+e_k)$ is composite, then by Lemma 1, (9) becomes

$$\sum_{i=1}^n i^a \sum_{j=0}^k \left(\left\lfloor \frac{n+e_j}{i} \right\rfloor - \left\lfloor \frac{n+e_j-1}{i} \right\rfloor \right) > 1+k+n^a$$

due to a proper divisor of the composite element. Thus, equality is only possible for prime $(k+1)$ -tuples. ■

Software codes

The more common methods of preparing a list of twin primes do not rely upon any test for such pairs. Instead, some sieve [5] [7] [13] method is employed to sift out all primes below a required limit and a simple search then extracts the twins.

On the other hand, given a pair $(n, n+2)$ of integers, Corollary 1 represents a possible test to simultaneously determine if they are twin primes without using a list of primes. It may not be the fastest available twin-primality test but its implementation is fairly straightforward as shown by the interactive Mathematica® dialogue:

```
In[1]:= n=2000081; If[Sum[Floor[(n+2)/i]-Floor[(n+1)/i]
+Floor[n/i]-Floor[(n-1)/i],{i,1,Floor[n/3]},2]
==2, "True", "False"]
```

```
Out[1]= True
```

Note that the *Floor* $[x/y]$ function may be replaced by its equivalent *Quotient* $[x, y]$ which is somewhat faster [1].

The following example is a non-optimum implementation of Theorem 2 with $a = 3$ to search for prime quadruplets $(n, n+2, n+6, n+8)$ below 10000.

```
In[2]:= a=3; n=10000; e={0, 2, 6, 8};
Do[If[Sum[i^a Floor[(j+e[[k]])/i], {k, Length[e]}, {i, j}]
==Length[e]+j^a+Sum[i^a Floor[(j+e[[k]]-1)/i],
{k, Length[e]}, {i, j}], Print[Table[j+e[[k]],
{k, Length[e]}]], {j, n}]
```

```
{5, 7, 11, 13}
{11, 13, 17, 19}
{101, 103, 107, 109}
{191, 193, 197, 199}
{821, 823, 827, 829}
{1481, 1483, 1487, 1489}
{1871, 1873, 1877, 1879}
{2081, 2083, 2087, 2089}
{3251, 3253, 3257, 3259}
{3461, 3463, 3467, 3469}
{5651, 5653, 5657, 5659}
{9431, 9433, 9437, 9439}
```

References

- 1 **David Bressoud & Stan Wagon.** *A Course in Computational Number Theory.* Key College Publishing, Emeryville, 2000.
- 2 **David M Burton.** *Elementary Number Theory, Fourth Edition.* McGraw-Hill, New York, 1998.
- 3 **Chris K Caldwell.** *The Top Twenty: Twin Primes.*
<http://www.utm.edu/research/primes/lists/top20/twin.html>
- 4 **P A Clement.** Congruences for sets of primes. *American Mathematical Monthly*, 56:23-25, 1949.
- 5 **Peter Giblin.** *Primes and Programming: An Introduction to Number Theory with Computing.* Cambridge University Press, Cambridge, 1993.
- 6 **Godfrey H Hardy & Edward M Wright.** *An Introduction to the Theory of Numbers, Fifth Edition.* Clarendon Press, Oxford, 1979.
- 7 **Mark Herkommer.** *Number Theory: A Programmer's Guide.* McGraw-Hill, New York, 1999.
- 8 **Kenneth E Iverson.** *A Programming Language.* John Wiley, New York, 1962.
- 9 **Donald E Knuth.** *The Art of Computer Programming II: Seminumerical Algorithms, Third Edition.* Addison Wesley, Reading, Massachusetts, 1998.
- 10 **Calvin T Long.** *Elementary Introduction to Number Theory, Third Edition.* Waveland Press, Prospect Heights, Illinois, 1995.
- 11 **Trygve Nagell.** *Introduction to Number Theory, Second Edition.* Chelsea Publishing, New York, 1981.
- 12 **Paulo Ribenboim.** *The New Book of Prime Number Records, Third Edition.* Springer-Verlag, New York, 1995.
- 13 **Hans Riesel.** *Prime Numbers and Computer Methods for Factorization, Second Edition.* Birkhäuser, Boston, 1994.
- 14 **Sebastián M Ruiz.** A functional recurrence to obtain the prime numbers using the Smarandache prime function. *Smarandache Notions Journal*, 11:56-58, 2000.
- 15 **James J Tattersall.** *Elementary Number Theory in Nine Chapters.* Cambridge University Press, Cambridge, 1999.
- 16 **Stan Wagon.** *Mathematica® in Action, Second Edition.* Springer/TELOS, New York, 2000.
- 17 **Eric W Weisstein.** *Twin Primes.* <http://mathworld.wolfram.com/TwinPrimes.html>
- 18 **Stephen Wolfram.** *The Mathematica® Book: A System for Doing Mathematics by Computer, Fourth Edition.* Cambridge University Press, Cambridge, 1999.

Formula to obtain the next prime in an arithmetic progression

Sebastián Martín Ruiz
Avda. de Regla 43
Chipiona 11550, Spain

Abstract: In this article, a formula is given to obtain the next prime in an arithmetic progression.

Theorem: We consider the arithmetic progression $a + di \quad i \geq 0$ of positive integers with $GCD(a, d) = 1$ and considering that the final term is $a + dM$ is to say $0 \leq i \leq M$. Let p a term in the arithmetic progression (it doesn't have to be prime). Then the next prime in the arithmetic progression is:

$$nxt(a, d)(p) = p + d + d \cdot \sum_{k=1+(p-a)/d}^M \prod_{j=1+(p-a)/d}^k \left[- \left[\frac{2 - \sum_{s=1}^{a+jd} (\lfloor (a+jd)/s \rfloor - \lfloor (a+jd-1)/s \rfloor)}{a+jd} \right] \right]$$

and the improved formula:

$$nxt(a, d)(p) = p + d + d \cdot \sum_{k=1+(p-a)/d}^M \prod_{j=1+(p-a)/d}^k \left[- \left(\left(2 + 2 \sum_{s=1}^{\sqrt{a+jd}} ((a+jd-1)/s - (a+jd)/s) \right) / (a+jd) \right) \right]$$

Where $\lfloor x \rfloor$ is the floor function. And where x / y is the integer division in the improved formula.

Proof:

By a past article [1] we have that the next prime function is:

$$nxt(p) = p + 1 + \sum_{k=p+1}^{2p} \prod_{i=p+1}^k \left[- \left[\frac{2 - \sum_{s=1}^i \left(\left\lfloor \frac{i}{s} \right\rfloor - \left\lfloor \frac{i-1}{s} \right\rfloor \right)}{i} \right] \right]$$

Where the expression of the product is the Smarandache Prime Function:

$$G(i) = \begin{cases} 1 & \text{if } i \text{ is composite} \\ 0 & \text{if } i \text{ is prime} \end{cases}$$

We consider that $a + j_0 d$ is the next prime of a number p in an arithmetic progression $a + jd$. We have that $G(a + j_0 d) = 0$.

And for all j such that $p < a + jd < a + j_0 d$ we have that $G(a + jd) = 1$.

It is deduced that:

$$\prod_{j=1+(p-a)/d}^k G(a + jd) = \prod_{j=1+(p-a)/d}^{j_0-1} G(a + jd) \cdot \prod_{j \geq j_0}^k G(a + jd) = \begin{cases} 0 & k > j_0 - 1 \\ 1 & k \leq j_0 - 1 \end{cases}$$

since the first product has the value of 1, and the second product is zero since it has the factor $G(a + j_0 d) = 0$.

As a result in the formula $nxt(a, d)$ the non zero terms are summed until $j_0 - 1$ and has the value of 1.

$$nxt(a, d)(p) = p + d + d \cdot \sum_{k=1+(p-a)/d}^{j_0-1} 1 = p + d + d \cdot (j_0 - 1 + 1 - 1 - (p - a) / d) =$$

$$= p + d + j_0 d - d - p + a = a + j_0 d$$

And the result is proven.

The improved formula [2] is obtained by considering that the sum, in the Smarandache prime function, until the integer part of the square root and multiplied by 2 the result. Also the floor function is changed $\lfloor x \rfloor$ for the integer division operator x/y that it faster for the computation.

Let us see an example made in MATHEMATICA:

```

a=5
5
dd=4
4
M=20
20
p=5
5
DD[i_]:=Sum[Quotient[(a+i*dd),j]-Quotient[a+i*dd-1,j],
{j,1,Sqrt[a+i*dd]}]
G[i_]:=-Quotient[(2-2*DD[i]),(a+i*dd)]
F[m_]:=Product[G[i],{i,(p-a)/dd+1,m}]
S[n_]:=Sum[F[m],{m,(p-a)/dd+1,M}]
While[p<a+(M-1)*dd+1,Print["nxt(",p,")=",p+dd+dd*S[p]];
p=p+dd+dd*S[p]]
nxt(5)=13
nxt(13)=17
nxt(17)=29
nxt(29)=37
nxt(37)=41

```

$\text{nxt}(41) = 53$

$\text{nxt}(53) = 61$

$\text{nxt}(61) = 73$

$\text{nxt}(73) = 89$

The question is that if these formulas can be applied to prove the Dirichlet's Theorem [3] for arithmetic progressions.

That is to say: does any arithmetic progression $a + jd$ such that $\text{GCD}(a, d) = 1$ have infinite primes?

REFERENCES:

- [1] **S M Ruiz**. A functional recurrence to obtain the prime numbers using the Smarandache prime function. Smarandache Notions J., Vol. 11, No. 1-2-3, Spring 2000, p. 56.
<http://personal.telefonica.terra.es/web/smruiz/>
- [2] **Carlos Rivera**. The Prime Puzzles & Problems Connection. Problem 38.
www.primepuzzles.net
- [3] **Thomas Koshy**. Elementary Number Theory with applications. Page 178.

SMARANDACHE SEQUENCE OF TRIANGULAR NUMBERS

Shyam Sunder Gupta

Chief Engineer(C), S.E. Railway, Kolkata, India

Email: guptass@rediffmail.com

Web address: www.shyamsundergupta.com

Abstract:

In this article, we present the results of investigation of Smarandache Concatenate Sequence formed from the sequence of Triangular Numbers and report some primes and other results found from the sequence

Key words:

Triangular numbers, T-sequence, Smarandache T-sequence, Reversed Smarandache T-sequence, Prime.

1. Introduction:

Triangular numbers are formed by adding up the series $1+2+3+4+5+6+7+\dots$. The general formula for nth triangular number is given by $n(n+1)/2$. So, the sequence of triangular numbers starts [1]

1,3,6,10,15,21,28,36,45,55,66,78,91,105,120,136,153,171,190,.....

Let us denote the sequence of Triangular numbers as T-sequence. So, the sequence of Triangular numbers,

$T = \{ 1,3,6,10,15,21,28,36,45,55,66,78,91,105,120,136,153,171,190,\dots \}$.

2. Smarandache Sequence:

Let $S_1, S_2, S_3, \dots, S_n, \dots$ be an infinite integer sequence (termed as S-sequence), then the Smarandache sequence [2] or Smarandache Concatenated sequence [3] or Smarandache S-sequence is given by

$S_1, \overline{S_1S_2}, \overline{S_1S_2S_3}, \dots, \overline{S_1S_2S_3 \dots S_n}, \dots$

Also Smarandache Back Concatenated sequence or Reversed Smarandache S-sequence is

$S_1, \overline{S_2S_1}, \overline{S_3S_2S_1}, \dots, \overline{S_n \dots S_3S_2S_1}, \dots$

3. Smarandache T-Sequence:

Smarandache sequence of Triangular numbers or Smarandache T-sequence is the sequence formed from concatenation of numbers in T-sequence (Note that T-sequence is the sequence of Triangular numbers). So, Smarandache T-sequence is

1, 13, 136, 13610, 1361015, 136101521, 13610152128, 1361015212836,

Let us denote the n^{th} term of the Smarandache T-sequence by $ST(n)$. So,

$$ST(1)=1$$

$$ST(2)=13$$

$$ST(3)=136$$

$$ST(4)=13610 \text{ and so on.}$$

3.1 Observations on Smarandache T-sequence:

We have investigated Smarandache T-sequence for the following two problems.

- (i) How many terms of Smarandache T-sequence are primes?
- (ii) How many terms of Smarandache T-sequence belongs to the initial T-sequence?

In search of answer to these problems, we find that

- (a) There are only 2 primes in the first 1000 terms of Smarandache T-sequence. These are $ST(2) = 13$ and $ST(6) = 1361011521$. It may be noted that $ST(1000)$ consists of 5354 digits.
- (b) Other than the trivial 1, there is only one Triangular number i.e. $ST(3)=136$, in first 1000 terms of Smarandache T-sequence and hence belongs to the initial T-sequence.

Open Problem:

- (i) Can you find more primes in Smarandache T-sequence and are there infinitely many such primes?
- (ii) Can you find more triangular numbers in Smarandache T-sequence and are there infinitely many such triangular numbers?

4.0 Reversed Smarandache T-Sequence:

It is defined as the sequence formed from the concatenation of triangular numbers (T-sequence) written backward i.e. in reverse order. So, Reversed Smarandache T-sequence is

1, 31, 631, 10631, 1510631, 211510631, 28211510631,

Let us denote the n^{th} term of the Reversed Smarandache T-sequence by $RST(n)$. So,

$$RST(1)=1$$

$$RST(2)=31$$

$$RSH(3)=631$$

$$RSH(4)=10631 \text{ and so on.}$$

4.1 Observations on Reversed Smarandache T-sequence:

(a) As against only 2 prime in Smarandache T-sequence, we found 6 primes in first 1000 terms of Reversed Smarandache T-sequence. These primes are:

$$\text{RSH}(2) = 31$$

$$\text{RSH}(3) = 631$$

$$\text{RSH}(4) = 10631$$

$$\text{RSH}(10) = 55453628211510631$$

$$\text{RSH}(12) = 786655453628211510631$$

$$\text{RSH}(14) = 10591786655453628211510631$$

(b) Other than the trivial 1, no Triangular number has been found in first 1000 terms of Reversed Smarandache T-sequence.

Open Problem:

- (i) Can you find more primes in Reversed Smarandache T-sequence and are there infinitely many such primes?
- (ii) Can you find triangular numbers in Reversed Smarandache T-sequence and are there infinitely many such triangular numbers?

REFERENCES

[1]. Sloane, N.J.A., Sequence A000217 (Triangular Numbers) in "The on line version of the Encyclopedia of Integer Sequences"

<http://www.research.att.com/~njas/sequences/>.

[2]. Weisstein, Eric W, "Triangular Number", "Consecutive Number Sequences" and "Smarandache Sequences", CRC Concise Encyclopedia of Mathematics, CRC Press, 1999.

[3]. Marimutha, H., "Smarandache Concatenate Type sequences", Bull. Pure Appl. Sci. 16E, 225-226, 1997.

Truth and Absolute Truth in Neutrosophic Logic

Feng Liu

Dept. of Economic Information, School of Information (Xinxi Xueyuan),

Xi'an University of Finance and Economics (Xi'an Caijing Xueyuan)

44 Cuihua Nan Road (Cuihua Nanlu 44 Hao), Xi'an, Shaanxi Province, 710061, P. R. China

liufeng49@sina.com

Abstract: *As a philosophical analysis of some fatal paradoxes, the paper distinguishes the conceptual difference between representation of truth and source of truth, and leads to the conclusion that in order to acquire the genuine source of truth, independently of specific representations possibly belonging to different worlds, one is necessary to ignore all the ideas, logics, conceptions, philosophies and representable knowledge even himself belonging to those misleading worlds, returning to his infant nature, as a preliminary step for his cultivation of unconstrained wisdom. It also carries out some coordinative crucial issues as natural-doctrine, minded-unwitting, logic-infancy, conception-deconception, determinacy-indeterminacy. The paper tries to verify the role of neutrosophy and neutrosophic logic in religious issues and open a gateway toward the oriental classics, excavating the lost treasure.*

Keywords: Neutrosophy, Dao, de-conception, logic, infancy, sensation.

1. Introduction

Although men is constantly achieving in science, but based on a quantum mechanics scientist's dream, we might have moved no further (In his dream he saw the speedy moving bicycle (he lived in that period) advanced no further. But when he stepped into this world in his dream, he felt he was moving fast by bicycle).

Human being is normally educated in a confusing way – we have created such a “science” even without any knowledge of existence and non-existence: “Everyone can not see himself a second ago, everyone can not see himself for the time being and everyone can not see himself a second future. Everyone could not know what the existence of self is. Everyone is also difficult to say the non-existence of self”, and therefore taken those images as true or real, and furthermore created such truths belonging to this bewildering world.

Different educations yield different understanding toward truth. I don't stand for the magnificence of a theory, since such truth and false inter-yeild each other, and hardly can one reach the proper perception: neither left nor right, so a great philosopher also commits mistakes in spite of his profound piece. The key lies in the subjectivity toward a truth, thus comes the saying that truth varies, or truth be adapted to modern ages.

Let's examine some sophisticated issues to see whether correct:

- We don't intend to create something as judgment, for any judgment is prone to yield selfishness: like, dislike, etc. Truth is written to conduct our behavior, therefore it does not lie in any sophisticated model, but in our conduct, as we often contradict our own aphorisms in behavior. Thus the issue turns to the understanding of our nature, which is not expressed or represented in any fixed form, or truth cannot be absolutely fixed in form too.

The point is:

1. Although the absolutely natural mental state is free of logic and only with the most (absolutely) right genuine instinct, but it is shown as normal, as if he had his private opinion in appearance, even though he has nothing of his own in essence (But my current knowledge is too far from the point).

2. If one really gets rid of all ideas and minds, he is then no more than a stone – Truth is alive not dead.

3. One needs to abandon all his previous ideas only to adapt to the greatest education, not to abandon his brain.

4. In order to acquire the genuine source of truth, independently of specific representations possibly belonging to different worlds, one is necessary to compromise, neglect even to get rid of all the ideas, logics, conceptions, philosophies and knowledge *but only belonging to those misleading worlds*, returning to his infant nature, as a preliminary step for his cultivation of unconstrained wisdom.

- To my previous assertion that “name is merely our mental creation. It is rather a belief than an objective being, and varies among different people.”[5], an explanation can be: In practice we have to assume that for incomplete knowledge system as in ordinary human, one can regard truth existing in relativity to individual's practical situation. Truth exists in variant form corresponding to the variant form of individual error. The absolute truth, even there exists, is not perfectly shown in any particular form (it has no form), and therefore inexpressible with symbols. So in this sense it is absolutely absurd to sedulously look for absolute truth in theoretical

manner; and only in this sense the most complete logic system is by no means complete, or, complete is incomplete.

The point is: If there were no particular forms to carry out an education that can correct our mistakes and misunderstandings, there would have been no education one can accept. In this way what one looks for is a proper form of education rather than the voidness.

- (The above paper) “In fact, this belief of ‘it is’ is always critical (Buddhism). In Buddhist saying, all such beliefs are created by ourselves.”

The point is:

1. To our ordinary minds we normally employ our illuding consciousness, but to those who understand the essence, it is not at all critical.

2. Buddhism doesn’t tell us to negate everything, nor is it nihilism. It tells us to completely abandon our subjectivity and really understand everything. Although there are great prejudices in every ordinary man, this is not to say there doesn’t exist absolute rightness. Nor is the world a nihility where there is nothing but our imaginations. The world appears differently to the different mental realms of individuals.

3. Although I am a Buddhist, but only a beginner, like a primary school student, and naturally full of mistakes and misunderstandings. But important: a tiny difference can lead us to the hell (“one word’s difference from the sutra is equal to the devil’s saying”). So I have no qualification to speak any truth illustrated in Buddhism.

- “There is no absolute fact.”[6]

The point is: absolute truth doesn’t non-exist, but perceived with wisdom eyes.

- (The same paper) “There is fact, but merely beliefs created by ourselves.”

The point is: we cannot deny the existence of the genuine and ultimate reality – we cannot assert that there is nothing objective in the world but our subjectivity.

- (The same paper) “When we see wind blowing a pennant we will naturally believe we are right (that it is the wind or the pennant that moves) in our consciousness, however it is subjective (actually it is our minds that move). In other words, *what we call the objective world can never absolutely be objective at all.*”

The point is that it is anti-Buddhism. Buddhism exhibits absolutely that all living creatures can definitely reach the absolute objectiveness through the proper education.

- (The same paper) “Whenever we believe we are objective, this belief however is subjective too.”

This is absolutely wrong for a wise mind.

- (The same paper) “In fact, all these things are merely our mental creations (called illusions in Buddhism) that in turn cheat our consciousness: *There is neither pennant nor wind, but our mental creations.*”

The point is that I am unqualified to explain. It may be our imperfect consciousness (vikalpa, as I imagine as separative (splitting) mind) that takes them as wind move and the pennant move, but we cannot say that wind and pennant are merely mental creations instead of objective being.

- (The same paper) “The world is made up of our subjective beliefs that in turn cheat our consciousness. This is in fact a cumulative cause-effect phenomenon.”

The point is: We can say that we are constantly cheating our selves with our constant subjective illusions we are creating in every fraction of second, but we cannot say that the world is made up of subjectivity – a kind of nihilism rather than Buddhism.

- (In a lot of papers, but mostly in [7]) “Everyone can extricate himself out of this maze of illusion (in some sources it is miswritten as “...is illusion”), said Sakyamuni and all the Buddhas, Bodhisattvas around the universe, their number is as many as that of the sands in the Ganges.”

The maze means our subjectivity. We learn Buddhism just to conquer subjectivity and really objectively understand the world. It is shown in Buddhism Sutras that everyone can achieve it, but the maze not mentioned, so it is implied.

- (The same paper) “Fact: a Belief rather than Truth.”

The same nihilism error as above. Knowledge exists in the contradiction between known and unknown for us – those known is a tiny drop and those unknown is an ocean. In this sense, facts or truth relative to our ordinary conception can hardly reveal the reality, but it doesn’t mean there is no reality.

- (The same paper) “There is no truth and false actually: there is because the outcome has to meet someone’s desire - they are

merely the attributes of a tradeoff. One false deed can be true in another perspective, e.g., eating much is good, because of the excellent taste and nourishment, but it is also bad when he gets weighted. Neutrosophy shows that a true proposition to one referential system can be false to another.”

The point is: although the same truth can be illustrated in contradictory languages relative to the specifics of individual minds, we cannot say there is no self-enlightenment – This is arrant subjectivism and arrant anti-Buddhism. For example, ignorance of cause-effect doesn't mean the non-existence of cause-effect. Cause-effect universally appears in every action even every mental move (idea). Ignorance of natural Dao (natural way, natural law) doesn't mean the non-existence of such Dao.

● (The same paper) “Whenever we hold the belief ‘it is ...’, we are loosing our creativity. Whenever we hold that ‘it is not ...’, we are also loosing our creativity. Our genuine intelligence requires that we completely free our mind —neither stick to any extremity nor to ‘no sticking to any assumption or belief’.”...“As we mentioned previously, whenever there is truth, there is also false that is born from/by truth—this abstraction (distinction) is fatal to our creativity”...“Because everything believed existing, true or false, is nothing more than our mental creation, there is no need to pursuit these illusions, as illustrated in the Heart Sutra...”

The point is:

1. Creativity is an easy metaphor for our inner “wisdom”, “nature of instinct”, but far from explicit, since the inner wisdom germinates from a tiny seed, naturally grows up in wind and storm – not at all something created.
2. There is only a tiny step between the genuine truth and fabrication. Truth pertains to a natural way, but when anything private added in, it deteriorates.
3. Mental creation comes from our private mind, but we cannot deny our wise beliefs – the right belief is the light in the darkness, not at all our mental creation, although normally mixed with our mental creations.
4. It is absurd for a kid to comprehend the mind of a PhD. It is far more to explain the Heart Sutra with our knowledge. More we explain, more absurd we are. Therefore it has been far too absurd for me to explain Buddhism. I am far, far, far away from qualified.

In general, it is not that we should abandon mind, but should abandon our private mind to adapt to the universal mind. As to the universal mind, let's see:

2. Morality and Doctrine

Is oriental culture a kind of science? There lies a crucial difference in that western science seeks the exterior solutions outside out heart. However, our ancient sages illustrated that human is an integral part of the universe, and all the phenomena never skip out of our heart. And very fortunately, many wise men did succeed in cultivating their heart to testify the profound truth. So our eastern classics focus on our inner cultivation.

The question arises from Dr. Smarandache's reflection to Liaofan's Four Lessons: “Neutrosophy is a tool to measure the truth of an idea, not necessarily a philosophy in itself. Liaofan's learning lessons are full of a kind of popular aphorisms”. Then I tried to refer to http://www.amtb.org.sg/2/2_10/2_10_1/2_10_1.htm, a link in the Dallas Buddhist Association (<http://www.amtb-dba.org/English/index.html>), to find an explanation, but unfortunately in Chinese. Here I try my reluctant interpretation (I am not at all qualified to translate Buddhism and hardly possible to explain. Please contact the corresponding Taiwan or Singapore website, where there are plenty of English versions of texts and videos of Buddhism, to request the standard translation).

What is Dao (Tao)? It is the natural principle all over the universe, the natural order, the essentiality of nature. The great universe has its order and rule, where the education of ancient-sages roots. Education stems from here, and human being has to obey the natural principle – it is Dao. In our Chinese notion of the integral of human and nature, heaven, earth and human are an integral whole. Human should understand the heart of heaven. What is the heart of heaven? The natural law, natural rule. For human, it is the human relationship, of husband-wife, brothers and sisters, monarch-subjects, friends, etc. *It is the natural rule, not regulations or systems, nor schools or doctrines.* Man conforming to it is said to practice Daoism. There is practice, there is gain bodily and heartily, called virtue or moral which is the partial standard of daily conduct. However, this partial standard should accord to the universal Dao and natural law. This is where the education of ancient sages roots.

Chinese emphasized education from prenatal influence. A pregnant mother should be upright in heart, correct in appearance, for every intention, pleasure, anger, sorrow or joy, influences the fetus. Chinese understood this principle, and therefore their babies were very well gifted, developed in the ten month's pregnancy. Parents had the responsibility for their children..... As I often mentioned, disaster falls nowadays, and still severe in the future, why? I have only one answer: “suffer from disobeying the olds (the Buddha, Laozi, Confucius, etc.)” It is the power of culture that makes China survive for thousands of years, and the marrow of culture lies in education..... The rulers were supported by people, for they didn't administrate with their own imperial edicts, but with the sage's education of Confucianism, Buddhism and Daoism. So the society maintained peace, enjoying the wise period of prosperity, all attributed to the ancient education, so they benefited from the olds' teachings. Since the Republic of China, very unfortunately, Chinese lost their national self-confidence, and have therefore fallen into such a tragic situation: so overwhelmingly worship and keep

the blind faith in the foreign countries, as to overthrow our own culture. Yes, but is there any better substitute to benefit people? If no, troubles arise [2].

3. Minded and Unwitting:

The neutrality in neutrosophics seems similar to “Madhyma-pratipada” and “Mean” in Chinese culture, which might mean proper (no mental move, no self consciousness added, as if no self exists, I believe): neither left nor right, but neutrosophy is conveying different meanings at present. For example, if A stands for white and Anti-A black, then Neut-A should mean gray, however either black or white can add to our subjectivity and should not be adhered to (as we are blind to the ultimate truth, it can be more wrong to imagine the being and non-being), otherwise we are unconsciously moving into this dimensional world that inhibits our access to the “infinite dimensional” world.

If the quantum world reveals the more general objectivity, it is very possibly that an expert in classical physics less apt at quantum physics, due to his default education. Same to human conflict, with each insisting on his own sphere of truth due to his default education or his private manner of perception, even incomplete or misleading. A possible conciliation lies in compromising – diminishing his minded way, to reach the understanding of another sphere:

(The idea of) A diminishes toward no-sticking-to-A

(The idea of) B diminishes toward no-sticking-to-B

Since a fact reflected from the mirror of A implies the private background (referential point) of A and the creation (including the negative, distorted) of A, both need to be compromised to see a mutual base.

Provided that A implies a more general way that covers B, should A ignore his idea? Sure, since the relatively more complete idea is misinterpreted in the language, background or referential system of B. As I mentioned in earlier paper [5], the best language should be no (no-sticking-to) language.

If everyone could ignore the idea of himself, there would be no misunderstanding in the world. Therefore, the best idea would be No (self) Idea or none self-idea (I don't mean a stone, a nihility, but a natural way). However, man would be too clever to believe it.

So the conciliation to current crises lies in education: if we find our education contrary to the nature, not only should we compromise, but also diminish and abandon it (e.g., the “n-dimensional” manner) to adapt to an universal (“infinite dimensional”) manner – to loose is to gain, no loss, no gain: One needs to abandon his old to adapt to the new, abandon his private mind to reach the universal one, abandon the illusion to acquire the true, abandon the capricious to acquire the eternal.

It is also dangerous if we persist in the leaves but blind to the trunk or root. For example, science is developed to change destiny, but what on earth is destiny? Liaofan's Four Lessons [10] shows the principle and practice to change destiny. But no understanding is beyond practice – we can never reach the correct understanding by any means of judgment or measurement based on our “scientific” referential manner, as I mentioned that science would reflect the same world in which few is able to command fate.

I eventually find that it would be the fault of logic itself – whenever there is logic, there is incompleteness – logic is a relatively dead representation of our live sensation:

4. Logic and Infancy

The question arises from the English learning for Chinese on which I find that the students spend a huge amount of time in reciting vocabulary but acquire far less. See a talk with friends:

“Why can it be wrong?”

“Because what they have learned is not English – they are merely symbols, an illusion.”

“Why?”

“Do they reflect the symbols in English or in Chinese logic? As a matter of fact they first reflect the symbols in Chinese, and then carry out the logic inference in Chinese way! Are they learning English or Chinese?”

“What's the point?”

“The point is, what they have learned are merely such pointers that point to English – symbols are supposititious, one cannot infer anything without experience, so I call their effort in vain.”

“Then what is the true manner?”

“The sensation of English. All your activities, reading, listening, oral and writing, all serve this motif. Chinese students failed just in this – they pay too much attention to grammar rules and Chinese logic in interpretation, as if they are always interpreting the English literals in Chinese logic, however, it is just such logic that inhibits the sensation.”

“Do you mean my logic inhibits my language aptitude?”

“As you know, the best language learner is infant baby – the success lies just in the ignorance of logic. Logic can be a kind of dead sensation: when one infers in logic, does he exploit his sensation any more?”

“Do you mean we should feel English instead of inferring?”

“No, just the opposite: no sticking to feelings, ideas (that are in fact no more than distraction), even ignoring yourself (e.g., the

role of a student busy for exams), can you concentrate on the author's role, even unconscious of acquiring of English, like a baby learning in playing. Learning is equivalent to playing a role that needs great concentration. Sensation is shapeless, like 'creativity'. We can never shape them."

"But it is a too far away goal."

"Sure, you'd employ all the means to understand the context, but soon when you have done, try to abandon such means to build up your English sensation. When one is able to walk, does he still carry the crutches along with him?"

"But how can I read English without referring to its Chinese meaning?"

"Can you read without referring, as if they had no meaning? Whenever you mind what they mean, you are using your Chinese logic again. Comprehension would lie in the ignorance of comprehension – or otherwise how can you forget yourself in the role of the author?"

"Then how do you find some famous language teachings of English like those of Li Yang and Zhong Daolong?"

"Li Yang's Crazy English negates the sensation theory, but his manner happens to enhance the sensation by inhibiting logical reasoning. He leads the students to perform all his hand gestures while reciting English just, in my personal opinion, to get rid of all the mental distraction from their learning habit. Professor Zhong Daolong's reverse (as contrary to the impatience for success of students) learning manner conducts student's coordination of all their possible senses: see English, listen to English, write in English, speak English, etc., simultaneously, with special emphasis on dictation rather than on reading with merely eyes, just to serve the same motif – to abandon their imagination, to get rid of mental distraction, for in this manner no one has time to apply logic any more."

"You mean to retrieve our own ability of an infant baby?"

"A famous Taiwan educationist Professor Wang Caigui made a through investigation, and asserts that the crucial or deciding learning period of a whole life span is from 0 to 3rd year, including antenatal education. Children are naturally gifted with the innate aptitude in everything: whatever seed you plant, all absorbed in like foam rubber. However their innate aptitude diminishes with the age grows, disturbed or distracted by worries or vexations, or even withers beyond the age of 13, so a great figure should accept earlier education of the giants."

"Can one retrieve that after the age of 13?"

"Sure, as long as he is resolved to conquer the distraction."

"How?"

"First, don't apply logic (pertaining to our misleading education, since we have been educated in a wrong way), since logic itself brings you distraction. Never mind what you acquire, toward unintentionality. Second, recite (or silently) the greatest pieces as long as you have time, such as Confucius's, Laozi's, or very simply just "Amitabha", to constantly replace distraction."

"Does Amitabha have any meaning?"

"The innate aptitude of Children lies just in this: they never guess the meaning. Whenever you guess or infer the meaning, you are seeking distraction unwittingly."

"Does it work?"

"It is not my personal invention, but from our lost Chinese classics. A patient of diabetes was suffering from insomnia, and failed in all her effort of counting numbers: 1, 2, 3, 4, 5, 6, 7, 8, 9, 10... After my wife changed her mind to recite Amitabha, she immediately had a perfect sleep. The point is, never add more distraction or any doubt. The power lies just in you confidence and concentration."

"Why did she fail by counting numbers?"

"I am afraid the numbers help nothing (there are such cases when one builds up his internal power of concentration with numbers, but I prefer the external power. With this help, in fact, one can eventually cultivate his correct internal power), but Amitabha (there are infinite means in Buddhism, not necessary this one) signifies the greatest power of the universe which she resonates with."

"Then, you believe our mind acts as a receiver tuner?"

"Exactly. A child can resonate with any signal he perceives, such as sentimental wound or evils, entirely absorbed like foam rubber, and performs it as soon as he grows up. On the contrary, the Classics Recital Program for Children initiated by Prof. Wang signifies a great education manner. Classics bring you the source of human wisdom. To recite these classics is an important path to develop potential, to learn language, to enhance cultivation, and to open the gates of wisdom for children. On account of our own Chinese culture, I would prefer Daodejing of Laozi, Buddhist scriptures, The Great Learning, the Doctrine of the Mean, etc. Children should not be asked to understand the meaning of the books, but should be led to recite all the books line by line, and paragraph by paragraph."

"Do you believe logic is a minor, subordinate or trifle aspect of intelligence?"

"A head of School of Information Engineering and Automation of the Xi'an University of Technology alluded to the emphasis on logical thinking in engineering. I answered, if the logics come from the celebrity, how can one escape or surpass the constraints of the celebrity?"

Logic is relative to the world one belongs to, e.g., the ant's world, the bird's world, each has its own characteristic of logic. Is our world the perfect one?"

"No."

“Are we willing to be confined to the logic of the imperfect world? If one believes in the after life, then his present realm of mind determines his future life.”

“But nearly all the students take the word list (Chinese logic in word interpretation) or grammatical structure (structural logic) highly important.”

“If the average rate of passing the exam is 10 percent, you have the same probability.”

“I would not. But logic is really important.”

“Logic merely acts as a language of sensation, not at all the essence of wisdom, and could be the dead representation of our live sensation. People need it to express their sensations, to communicate. It is in fact a scientific language, not wisdom. Great mathematicians are often philosophers, but however, mathematicians often find faults in their basic axiom systems, and many mathematicians assert that it is sensation that conducts logic deduction.”

So my conclusion is: Logic always has limitation but sensation does not; Logic is relative and sensation is not confined as long as one is resolved to cultivate; Logic is relatively dead but sensation is alive. But to cultivate sensation one needs to escape all the distraction (for the sticking manner) from logics, knowledge, even the concept of sensation, returning to the infant nature – seemingly ignorant of everything, but however, great wisdom often lies in the fool: “Where ignorance is bless, it is folly to be wise.”

Now that logic can never be complete, one can infer that conception itself yields incompleteness as long as it employs logical means, i.e., conception yields anti-conception. Let’s now discuss:

5. Conception and De-conception:

In education, especially in English as a second language for Chinese, when students meet a new concept or word, phrase, they are normally eager to immediately get directly to its interpretations (in Chinese, or in mathematics and science, from existing concepts), however, since each school or thought is limited to a specific background or referential frame, and it is usually hardly possible for one to turn to such multi-points of focus. Then, I am considering “defocusing” to maintain refocusing: forget all the distractions and get to the right route.

Like things in the world, science and technology also exist in alternation of fashions, e.g., quantum world can be completely different from classical physics. This makes people meditate: how can a well educated scholar change his point of view? Unless their minds turned to the infancy - unknown.

In English learning for Chinese, those always interpreting it in Chinese never catch the essence of English, for they would always understand English in Chinese logic, background, or points of view, never switch to the heterogeneous referential point of view. So one has to abandon his native language to command a foreign language. This is another case of the infancy effect – as we know infant language aptitude lies in its ignorance of thinking, reasoning, or idea, logic – no knowledge, no rules.

Thus arises the challenge to the change of mind: to learn but never to assume known – the way of *humility*:

Being the entrance of the world,
You embrace harmony
And become as a newborn

Chapter 28 of Daodejing [8]

See also Chapter 4 of Liaofan’s Four Lessons - The Fourth Lesson: Benefits of the Virtue of Humility [10].

Like things in the world, whenever there is birth, there is also death from this distinction:

When beauty is abstracted
Then ugliness has been implied;
When good is abstracted
Then evil has been implied.

So alive and dead are abstracted from nature,
Difficult and easy abstracted from progress,
Long and short abstracted from contrast,
High and low abstracted from depth,
Song and speech abstracted from melody,
After and before abstracted from sequence.

Chapter 2 of Daodejing [8]

Same to a concept, i.e., concept is always accompanied by anti-concept as in the taiji figure, whenever there exists such a distinction. Then one should argue about the role of concept: both positive and negative roles integrated in one entity. Is there a proper way of conception that can effectively inhibit the negative role, or the death of concept? Sure, just to keep it indistinct, as in its original, unspecified, indeterminate or *infant* state – keep it primitive, immature, as if unborn, even we need it for communication to

different spheres of mind. So it is wise to vacate our mind (free our mind) to maintain “creativity” (an improper metaphor for a wisdom seed) alive (on going), as in an infant way. In fact, creativity lies in the ignorance of creativity as against the confined or constrained (e.g., to a spot oriented world - A science fiction film has compare our globe to a tiny spot in the universe) way. Otherwise, a philosophy can be believed true when it serves our motif, and false when it doesn't. In this manner, the world would be led into a self-centered society as our self-centered ideology expands, bringing all the people into the real nihility – no gleam of truth can be seen anymore in this blind world. What time, however, will human being sacrifice our own motif to adapt to the motif of the universe?

To command science, one has to abandon (ignore) science. To acquire genius, one has to abandon (ignore) genius. To acquire himself, one has to forget or loose himself. But important: abandoning everything only to get to the right education, the route of absolute truth – we are not defocusing actually but changing our focus to the universal mind.

6. Truth and Absolute Truth

The discussion originates from Dr. Florentin Smarandache in our common book Neutrosophic Dialogues: “What I argue about is that we are not sure if we know ALL POSSIBLE WORDS.”

I have to argue that is the “truth” true or the truth points to a true world of understanding, namely the source of truth?

Truth in the former sense is capricious (wuchang in Chinese, or anitya, anityatā in Sanskrit). This makes people feel that there might be no absolute truth.

What I understand the absolute truth is the universal mind, the harmony with the universe. All branches of truth must serve this motif, or in vain if deviate from it. This might be the reason why people feel in vain to seek truth, because it is assumed to serve private purpose rather than the harmony of human being or that of the universe.

It may not be the fault of the truth, but the reflection from a self-centered mental world. This might be the reason why we never get to a universal truth, since we never correct our sins (see Chapter 2 of Liaofan's Four Lessons – The Second Lesson: Ways to Reform [10]).

A pointer to the truth is different from the truth. Any form of symbols serves only as such pointers. For example, when one draws an elephant on the blackboard, it is no more than a figure. When one points to the moon, should we regard his finger as the moon? So we say, truth is also false, since we adhere to such symbols, blind still.

The absolute truth, as the harmony with the universe, would appear as the absolutely natural behavior than a school of philosophy – when one is completely melt into the universe, there would be no distinction in his mind between himself and the nature, and every intention reveals the kindness of the nature, nothing evil at all. So he would not distinguish anything unnatural – never stand in the illuded perspective. Of course he may never be aware that there is a philosophy or truth in his mind.

Does it then mean there is nothing to follow, as there is nothing we can hold in hand? No, since every good education is teaching us the correct way rather than the correct symbols – to correct our mistakes (see Chapter 1 of Liaofan's Four Lessons – The Third Lesson: Ways to Cultivate Goodness [10]).

Does it mean there is no truth? If to the god (I mean a being who is identical to the truth), he would answer no – no philosophy needed, for he understands everything by intuition, or, the over-truth is no more than false, sine the manner would sentence a live truth to death (by dead truth I mean the fixed mind inflexible to literal or other forms of changes). But to our ordinary man with countless mistakes, truth exists in the implication of our faults: misbehaviors or misunderstandings - misbehavior or misunderstanding definitely leads to unlucky effect or even misfortune, so truth comes (see Chapter 1 of Liaofan's Four Lessons – The First Lesson: Learning to Create Destiny [10]).

Truth has no absolute language to represent, I am afraid. It is represented, according to the language of us (how can one fix the live truth into some dead symbols reflected differently by different realms of mind). It is neither proper for us (in our blind world) to measure – is it possible to measure a more general teaching (scientifically, the “infinite dimensional” manner) with any clumsy, unapt measurement (e.g., infinite dimensional manner)? In his measuring, he is accumulating doubts to his genuine consciousness (he is unconsciously reflecting the symbols with his illuded consciousness). So a good way would be more efficiently shown through conduct, behavior, etc., to correct our mistakes and misleading opinions (see Chapter 2 of Liaofan's Four Lessons – The Second Lesson: Ways to Reform [10]).

Is there the absolute truth in science? Personally, if it serves the well being of people, there is. But if serves the greediness, there also is – to teach us to abandon science, since, as the symbol of the nature, Dao in my belief is of the nature of humility, sacrificing itself to nonentity and thus spreading all over the universe - as large (or in scientific term, as many dimensions) as the infinity. Therefore, to reach the universal perspective of the absolute truth, one has to sacrifice any ideology of habitual referential model. Refer to Chapter 4 of Liaofan's Four Lessons - The Fourth Lesson: Benefits of the Virtue of Humility [10] for more.

So here I conclude that: The absolute truth is only seen by heart when one abandons all the possible knowledge, philosophies belonging to the different possible worlds that bewilder him. This should be a necessary means for one to get rid of all the distractions from these realms, and cultivate himself in practice to the true light of unification.

Aware of the relativity of the forms of the absolute truth, one may argue about the similarity between absolute truth and nihility. Definitely no. In the Chinese room experiment [9], the Englishman will manipulate symbols in Chinese, and he will give a correct answer in Chinese, but is not conscious of what he did. Nihility implies a dead consciousness. However, not only is a genuine consciousness alive, it also reflects the genuine truth.

Just as Lu You (of Song dynasty) wrote (my personal interpretation, as I failed to download an English piece):

The road seems ending in the hills and streams, I doubt,

But I see the dense willow trees and bright flowers of another village.

Don't worry about yourself, only by forgetting yourself can you follow the light, or you never understand the truth due to your endless doubt.

7. Dual Trends of Neutrosophy

What creates the world?

1. The Tao that can be trodden is not the enduring and unchanging Tao. The name that can be named is not the enduring and unchanging name.

2. (Conceived of as) having no name, it is the originator of heaven and earth; (conceived of as) having a name, it is the mother of all things.

3. Always *without desire* we must be found, If its deep mystery we would sound; But if desire always within us be, Its outer fringe is all that we shall see [4].

The Way that can be experienced is not true;
The world that can be constructed is not true.
The Way manifests all that happens and may happen;
The world represents all that exists and may exist.

To experience without intention is to sense the world;
To experience with intention is to anticipate the world.
These two experiences are indistinguishable;
Their construction differs but their effect is the same.

Beyond the gate of experience flows the Way,
Which is ever greater and more subtle than the world [8].

Men normally care too much about the fragmental details of the universe to maintain the hidden integral. In fact, every mind is gifted with the gene of the universal mind: the integral of our ultimate inner nature which is identical with that of the universe. This is what I call yang in I-Ching (the originator) - it is formless, shameless, timeless ... the completely opposite world from our believed consciousness. So I call it the prior natal aspect, or wuji in the Taiji figure, or possibly Dao in Daoism.

We illustrate this character of no-desire (actually it is no mental move, through which to achieve the greatest desire) as wuji:

But if there is desire, we can break the unification (denoted by wuji state) into taiji (moving mind):

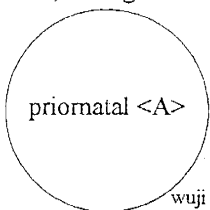

- In this way, we see the integrity of the universe.
- Or in Chinese saying, the unification of man and heaven.

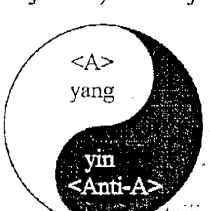

When beauty is abstracted
Then ugliness has been implied;
When good is abstracted
Then evil has been implied [8]

So it is that existence and non-existence give birth the one to (the idea of) the other ...[4]

And with the desire growing:

But still, there remain both propensities: the integral way and the splitting way:

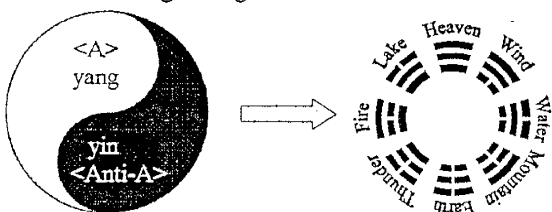

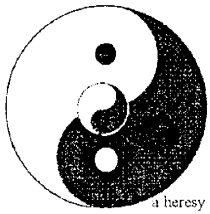

It is crucial that we would rather create more symbols theoretical than follow a natural way.

How can one then reach the truth? First, understand the universal heart that lies in non self desire. Second, abandon our splitting manner (mental creations). The undo principle (to undo our mental change):

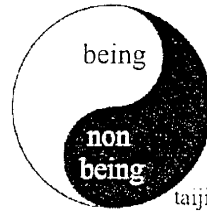

- If someone points to the moon, can we reach the moon by holding fast his fingers?
- If someone points to the truth, can we reach the truth by holding fast his theories?
- Because in this way we are merely holding fast such pointers that point to reality, not reaching anything of reality. What we have reached are merely such road signs.



the
splitting way
→
returns to
an infant way

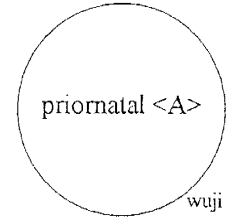

Then does wuji imply anything nihility or absolute voidness, absolute empty? Definitely no. Let's see:

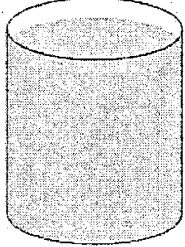
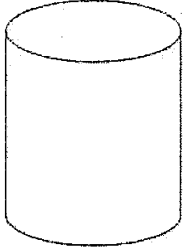
How much can your mind contain?		
for a full cup: 	for an empty cup: 	For the no cup:
No more, because it is fully occupied.	One cup.	It can contain the universe, because it is not confined to any form, shape or boundary.

As illustrated in Chapter 28 of Daodejing [8]:

- Using the male (having no name, it is the originator, or father; having a name, it is the mother, so we cannot partial to either of them in case of breaking the yin-yang unification - my personal annotation, as follows), being female,
- Being the entrance of the world (wuji),
- You embrace harmony (Dao)
- And become as a newborn (returning to the originality, the genuine nature).

So the only way is to abandon all our usual way pertaining to our current misleading world, as the preliminary step toward the true world. Since truth and false in conventional sense are out of the splitting way: (conventional) logic way, so we should also abandon such logic way to reach the completely natural way, returning to our natural integrity.

How would we then regard neutrosophy?

As either a new concept of more complete truth or a novel class of logic, it follows the birth, growth, prosperity, wither, death cycle as in every science. Does one prefer a pointer or the ultimate true world?

If neutrosophy pertains to an instant state of art, no need to adhere to it, due to the constant update.

If to the soul of science, it is no logger external any more. So the way also lies in our inner cultivation.

But as the western understanding of the Chinese Middle Way (Doctrine of Mean), it needs to be further developed, for "When mind is either being or non-being, it falls into the trap of affirmation. When mind is neither being nor non-being, it falls into the trap of negation." Either affirmation, or negation, then, is a trap from which one must free oneself in order to reach suunyataa (the ultimate reality)." [3]

Doctrine of Mean may refer to our mind move: neither left (affirmation, as being) nor right (negation, as non being). So it may mean to abandon our mind move (wishful desire) rather than to blend or merge our mind moves (wishful desires). The distinction between current neutrosophic logic and Chinese Middle Way may be:

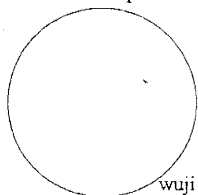

No mental move;
Free of ideas that implies every idea;
Dao that implies everything.

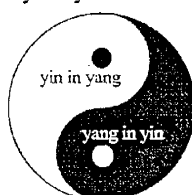

Combining being and non-being in the way of I-Ching (Book of Changes);

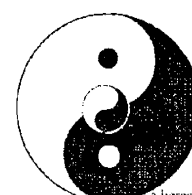

Or mentally creating some new being as truth to pursue, in a heresy way.

Dr. Smarandache has once argued that I stand only on the religious background. As a matter of fact, if one finds such scientific

way fundamentally critical and the religious way more general, he would then reversely regard religious way scientific and so called “scientific way” religious.

8. Determinacy and Indeterminacy

Does the genuine mind reflect the determinacy? Exactly, it reflects the truth, and in such a world there is no kidding, no confusion, no upside-down, no wishful thought, no illusion, even no sickness, no death, no unsatisfaction, no evil, and no unintelligent.

Is it too fantastic? Just because a universal mind adds nothing personal or private to his mind, he doesn't “reason” in logic, but with intuition – nothing minded (although with the greatest will), and therefore being the universal mind. As discussed previously, whenever there exists a more or less private mind, there is a private way or partial way, and anything against this private will or private way should certainly regarded as indeterminate, hence the notion “we live in relativism, approximation, continuously changing worlds”- we measure everything in a partial, private, more or less self-oriented, even illuding referential manner. We are blind to the cause-effect ourselves, as if we drive a plane without any knowledge of the landscape, navigation, even our current position, our destination – we are using the absolutely wrong measurement to indicate longitude, latitude ... but we are unaware of.

Is that the reason why we have indeterminacy in neutrosophy? Yes. It should be a gateway to a more realistic specification of the contradiction between subjectivity and objectivity. Because we know our limitations, we'd better behave in humility, as someone said, we are sin at birth.

Does humility mean anything in science? People normally over-emphasize the pro science so as to neglect the con. Not only has neutrosophy summarized both, it also implies the humility in science – the indeterminacy, indicating both the incomplete and the illusionary aspects of scientific manner.

Does neutrosophy implies anything religious? Certainly. “When mind is either being or non-being, it falls into the trap of affirmation. When mind is neither being nor non-being, it falls into the trap of negation.” Either affirmation, or negation, then, is a trap from which one must free oneself in order to reach *suunyataa* (the ultimate reality) [3].

The pro aspect: Neutrosophy implies that both affirmation and negation are inadequate to illustrate the objectivity, so adds the indeterminacy serving as the neutrality in between – neither affirmation nor negation, as guidance to the reality.

The con aspect: Neutrosophy fails to reach a depth realization of neutrality, thus conveying a different meaning from The Doctrine of Means of Confucianism. Because, from *Daodejing* (my personal understanding), affirmation and negation are counterparts: They yield each other - One affirms something while negates something (even the same thing) simultaneously. So one would fail to reach the “Middle Way” without compromising both affirmation and negation, i.e., ignoring the measurement.

As the conclusion: Neutrosophy should be in integral with pro, con and neither, with the “neither” implying the ignorance of both. Thus in this way, Neutrosophy implies the ignorance of neutrosophy. Or *integrated in one word: humility*. However, as one can point to the moon but fail to reach, one needs to follow an education called “religion” in practice to realize (acquire) the virtue of humility.

9. Final Remarks

As implied in neutrosophy, whenever there is a perspective point, there is self, reflected in the private referential manner, and thus the incompleteness, and more than partiality: illusions from this self-centered view. A truth is so called absolute, because it is based on no selfness, absolutely no, and in such a world people do see the truth instead of illusions. In fact, “self” reflects rather illusions than objectivity – a blind man see himself (in conventional sense) as self, but a wise man would see himself differently, e.g., as something external to him, a tool he employs. Therefore, a preliminary step toward the universal understanding is to abandon the self oriented desire, otherwise no gleam of truth can be seen.

Truth is not a kind of judgment or measurement that we can impose T,I,F values with our contaminated eyes, but the light with which we see our blindness and ignorance.

Truth suggests more a correct way of life than a useless set of arcane symbols, therefore it is not represented as sciences, but the Way, the Dao or the wisdom, imbedded in (intrinsic to) every spirit and is sure to be seen as long as one can abandon his private measurements.

A fatal barrier toward our genuine understanding is the modern contamination: the modern culture, with which Chinese are diligently following the dust. To open his eyes, one needs to keep away (even in seclusion) from his previous education: culture, public media, network and even the polluted world, for a tiny pill of poison can spoil a pool of pure water men daily drink. The danger is far less pernicious from material food than spiritual food.

A polluted mind would never be aware of the current danger. A lady from countryside once blamed for the contamination of water in Xi'an (in which we are living) which we regarded pure. A human flesh-eater normally enjoy the taste of the dishes, while a university yang lady who just became a Buddhist (following the teaching), nauseated at the flesh she used to have at the student's canteen. My wife in pregnancy also nauseated at the flesh she used to like and then changed her manner forever. Same to a contaminated mind – one could suddenly be aware of something valuable in a specific environment, like Li Na (surname and given name in Chinese), a famous singer who lately became a Buddhist nun in America.

There is the birth, growth, prosperity, wither and death of logic, but no birth and death of truth. It is the source, a universe, permanently alive. To discover the underlying truth in neutrosophy, one needs to abandon any logic adherent to it and see directly the source, through out its countless birth and death cycles.

A pattern is true only when completed, implemented, testified and proved in practice, not in superstitious manner. This is the significant difference between truth and logic.

Absolute truth is independent of our beliefs and measurements – it objectively exists through out the universe and is universally true in every world, although represented in varying forms to different mental spheres and different phases of individuals. But, it is also seen as relative in its capricious representations – It is not the fact that the truth varies, but our minds swing, and therefore see the treatment in dynamic styles. See a poem by a famous Buddhist poet Su Shi in Song Dynasty

A great mountain by vertical and horizontal view,
Far, near, high, low, and each not same.
I can't see the true face of Lushan,
Because I am just in there.

and Daodejing Chp.7:

“Heaven is long-enduring and earth continues long. The reason why heaven and earth are able to endure and continue thus long is because they do not live of, or for, themselves. This is how they are able to continue and endure.

Therefore the sage puts his own person last, and yet it is found in the foremost place; he treats his person as if it were foreign to him, and yet that person is preserved. Is it not because he has no personal and private ends, that therefore such ends are realised?”[4]

“Nature is complete because it does not serve itself.

The sage places himself after and finds himself before, ignores his desire and finds himself content.”[8]

So the universal truth lies in the abandon of self-desires (As a beginner, I am unqualified to speak anything of Buddhism. For those who have interest, please find sources in http://www.drba.org/CTTB/cttb_e.htm, the City of Ten Thousand Buddhas (CTTB, USA) for English, and another site <http://www.physics.utah.edu/~junyu/larong/index.html> for Chinese, and may also find faults in my assertions).

10. A Heuristic Dream

It was at the dawn of April 30, 2003, in the dream, I was asking a repairing booth to have my bicycle repaired ... in the end when it was all done, I suddenly found my bicycle disappeared. I looked around and wonder: “I didn’t leave a half step away, why?” I was terribly uneasy until half awake and realized that my real bicycle is OK. In the mainland China the majority rely on bicycle that equals to cars in the United States. It is in fact a basic means of living. Accordingly I immediately realized that it is a heuristic dream.

I remember a film about the Sixth Patriarch, Master Huineng, in which he was invited by the Empress Wu (Wu Zetian of Tang dynasty, the only woman emperor in Chinese history) to the capital (now Xi’an) to teach Buddhism, but he declined, thus made the empress angry. Just in a while she became aware: “No dharma (method) is dharma (method)” - dharma may be the most natural, not something we create or seek external to our nature - my personal guess (actually one should never guess, but I am afraid readers would distort the original sense), see Heart Sutra [1]:

When Bodhisattva Avalokiteshvara was practicing the profound Prajna Paramita, he illuminated the Five Skandhas and saw that they are all empty, and he crossed beyond all suffering and difficulty.

Shariputra, form does not differ from emptiness; emptiness does not differ from form. Form itself is emptiness; emptiness itself is form. So too are feeling, cognition, formation, and consciousness.

Shariputra, all Dharmas are empty of characteristics. They are not produced, not destroyed, not defiled, not pure; and they neither increase nor diminish. Therefore, in emptiness there is no form, feeling, cognition, formation, or consciousness; no eyes, ears, nose, tongue, body, or mind; no sights, sounds, smells, tastes, objects of touch, or Dharmas; no field of the eyes up to and including no field of mind consciousness; and no ignorance or ending of ignorance, up to and including no old age and death or ending of old age and death. There is no suffering, no accumulating, no extinction, and no Way, and no understanding and no attaining.

Because nothing is attained, the Bodhisattva through reliance on Prajna Paramita is unimpeded in his mind. Because there is no impediment, he is not afraid, and he leaves distorted dream-thinking far behind. Ultimately Nirvana! All Buddhas of the three periods of time attain Anuttara-samyak-sambodhi through reliance on Prajna Paramita. Therefore know that Prajna Paramita is a Great Spiritual Mantra, a Great Bright Mantra, a Supreme Mantra, an Unequaled Mantra. It can remove all suffering; it is genuine and not false. That is why the Mantra of Prajna Paramita was spoken. Recite it like this:

Gaté Gaté Paragaté Parasamgaté
Bodhi Svaha!

(It is strongly suggested that one never seek the meaning of the Chinese Classics when he reads, in the way of Chinese Classics

Recital Project of Prof. Wang mentioned in section 4, or what I call here the infant way - Whenever he does seek, he is seeking distraction unwittingly. Plant rather than reap, or he will definitely distort the essence.)

As we know people nowadays are putting all their hearts and soles in the search of science – the supreme method believed by all, just like the bicycle relied on in the dream. However science is merely a dream, a language of the current illuded world (as stated in section 4, ants live in their own world and have their own characteristic of language, so do birds and humans), and can suddenly disappear when we wake up. Even awake, one would find it terribly uneasy with this changed style of manner and would rather prefer the old custom – it is still harder to adapt to a new life.

What is self? Something we daily rely on? Oh, just the bicycle in the dream – we are repairing it every minute and numerous people are diligently finding and achieving it through out their lives, but we will eventually find no such self (in the conventional sense) exists: it is rather a dream than the real self.

Our reflection of the world can be more or less an emersion, a projection, or a developed image of our mind move, including T,I,F in neutrosophy, I hazily figure, although I am still in the maze. But, as implied in all the Buddhist scriptures, EVERYONE CAN EXTRICATE HIMSELF OUT OF THE MAZE OF ILLUSION – countless people have already succeeded in their cultivation, like Sakyamuni and all the Buddhas, Bodhisattvas around the universe, their number is as many as that of the sands in countless Ganges. But preliminarily, stop our mental creativity and imagination, honestly and sincerely follow the greatest teachings. Dr. Smarandache once blamed at one of our ICM2002 participant's hotel, dorm 18 of Tsinghua University, for the “strange Chinese custom” that it is strictly impolite or insulting to “touch” (in his word) young ladies (e.g., wrap his arm about her shoulders). I would have told him to find strict regulations in Confucianism and all the ancient heritages if he were really interested in Chinese culture instead of blaming. Without such social regulations, or without strict commandments, neither civilization would have been built up, nor would any dharma have been actually seen, from any greatest teaching (any greatest culture will definitely in this way deteriorate into the devil's saying). So it is more suggested to popularize Confucianism in our current society (in which the most valuable thing is being lost and the real civilization is dying, impacted by the western modernization), as a preliminary step toward further educations (Confucianism and Daoism served exactly as the basis in Chinese history for the introduction of Mahayana. So it was an absolutely wise deed to popularize these Classics as the basic education).

References:

- [1] Buddhist Text Translation Society: *The Heart of Prajna Paramita Sutra*, 1997, http://www.drba.org/heart_sutra_e.htm
- [2] Chin-Kung, *Reestablishing Morality and Educating the Youngsters – An Interview*, 2002, http://www.amtb.org.sg/2/2_10/2_10_1/2_10_1.htm.
- [3] Chung-yuan Chang: *Ch'an Buddhism: Logical and Illogical*, <http://ccbs.ntu.edu.tw/FULLTEXT/JR-PHIL/ew27057.htm>.
- [4] James Legge: *Tao Te Ching*, Internet Encyclopedia of Philosophy, 1996, <http://www.utm.edu/research/iep/text/tao/tao.htm>.
- [5] Feng Liu: Name, *Denominable and Undenominable*, ——*On Neither <A> Nor <Anti-A>*, Proceedings of the First International Conference on Neutrosophy, Neutrosophic Logic, Set, and Probability, University of New Mexico, USA, 2002, pp.107-113, <http://www.gallup.unm.edu/~smarandache/FirstNeutConf.htm>, <http://xxx.lanl.gov/ftp/math/papers/0306/0306384.pdf>.
- [6] Feng Liu: *Paradoxes Review* ——*On Neither <A> Nor <Anti-A>*, Smarandache Notions (book series, Vol. 13), edited by Jack Allen, Feng Liu, Dragos Constantinescu, American Research Press 2002, pp.200-203
- [7] Feng Liu, Florentin Smarandache: *Logic: a Misleading Concept — A Contradiction Study toward Agent 's Logic Ontology*, Proceedings of the First International Conference on Neutrosophy, Neutrosophic Logic, Set, and Probability, University of New Mexico, USA, 2002, pp.88-100, <http://www.gallup.unm.edu/~smarandache/NeutrosophicProceedings.pdf>, Libertas Mathematica, University of Texas at Arlington, 2002; Los Alamos National Laboratory archives (New Mexico,USA), <http://xxx.lanl.gov/ftp/math/papers/0211/0211465.pdf>, *Dialectics and the Dao, On Both, <A> and <Non-A> in Neutrosophy and Chinese Philosophy* (title changed), Seeking Wisdom journal, Gallup, NM, USA, No. 1, pp. 56-66, Spring 2003..
- [8] Peter A. Merel: *TaoDeChing - Lao Tze*, GNL's Not Lao Version 2.07, 1995, <http://www.chinapage.com/gnl.html>.
- [9] J. R. Searle: *Minds, brains and programs*, Behavioral and Brain Sciences, 1980, 3, pp.417-457.
- [10] Liao-Fan Yuan (ancient): *Liaofan's Four Lessons*, <http://www.amtb.org.tw/e-bud/liaofan.HTM>, <http://www.amtb-dba.org/English/Text/ChangingDestiny/index.html>, <http://www.amtb-dba.org/English/Text/LiaoFan/index.html>.

Toward Excitation and Inhibition in Neutrosophic Logic

- A multiagent model based on ying-yang philosophy

Feng Liu

Dept. of Economic Information, School of Information (Xinxi Xueyuan),
Xi'an University of Finance and Economics (Xi'an Caijing Xueyuan)
44 Cuihua Nan Road (Cuihua Nanlu 44 Hao),
Xi'an, Shaanxi Province, 710061, P. R. China
liufeng49@sina.com

Abstract: *Logic should have been defined as the unity of contradiction between logic director and logic implementation. Chinese Daoism asserts that everything is defined in the unity of opposites, namely yin and yang, accordingly yang conducts change and yin brings it up (I-Ching, also known as Book of Changes). In this way logic is redefined in an indeterminate style to facilitate "both A and Anti-A" etc. in neutrosophics of logic. The unity of opposites is also described as neutrality in neutrosophy. An intermediate multi-referential model of excitation and inhibition is developed to derive a multiagent architecture of logic, based on Chinese yin-yang philosophy. This methodology of excitation/inhibition suggests a rhymed way of logic, leading to a dynamic methodology of weight strategy that links logic with neural network approach. It also confirms the crucial role of indeterminacy in logic as a fatal criticism to classical mathematics and current basis of science.*

Keywords: Neutrosophy, contradiction, logic implementation, priornatal aspect, five elements, dynamic weight strategy.

2000 Mathematics Subject Classification: 03B42, 03B60, 03A05, 03H05

1. Background

What fatal defect do we find in the conventional definition of logic? Although logic plays an important role in science and technology, some fatal flaws negate its validity and applicability:

Lack of insight in the essence of logic that should lie in the contradiction between conceptualization and implementation. Even logics of the highest validity can contradict their applicability, as illustrated in the logic "I'll visit him if it doesn't rain and he is in" [1].

The lack of identity between opposites. Do truthness and falseness always antagonize each other? No, there is neutrality or agreement between them, which combines them into a unity, as illustrated in neutrosophy.

Assuming that for incomplete knowledge system as in ordinary human, there is no absolute truthness and falseness in reality (as shown in neutrosophy), therefore even the most complete logic system is by no means complete, or, the most complete is the most incomplete.

Example 1: The sun turns around the earth.

<A>

The sun turns around
the earth.

<Anti-A>

The earth turns around
the sun.

Δ

balancing point:

This is a relative concept.

Example 2: I'll visit him if it doesn't rain and he is in.

<A>

It doesn't rain
and he is in.

<Anti-A>

When I become confident
of it, it is too late to go.

Δ

balancing point:

I should try my luck or make an engagement.

In which aspect do we differ in the definition?

Logic in essence is rather a dynamic balancing act than the static truth-false concepts.

This behavior can be represented in neutrosophy as "both <A> and <Anti-A>" promising a unification in the balancing.

Values in percentage are inefficient to characterize the unification in the tradeoff.

Logic in its social aspect is an integration of distributed actions (conceptualization and implementation), rather than rules or fuzzy rules only. Logic is derived when people neutralize opinions among countless versions of implementations and applications, in contrast to the absolute accuracy and completeness in conventional mathematization – how can we measure unintentionality with intentionality? For this reason, I will write in the non-mathematical pattern, as against the "mathematical" pattern, for what is called mathematical is no longer mathematical at all in the views of neutrosophy and Chinese classic philosophies: things will develop in the opposite direction when they become extreme, or "wujibifan" in Chinese.

The logic "both A and anti-A" can be invalid in conventional logics, but valid in an excitation/inhibition rhythm, at least they imply each other and live in one family.

2. Definition of Neutrosophic Logic – A Novel Version

Is logic a fixed concept or an endless evolution? Let's explore the evolution of logic:

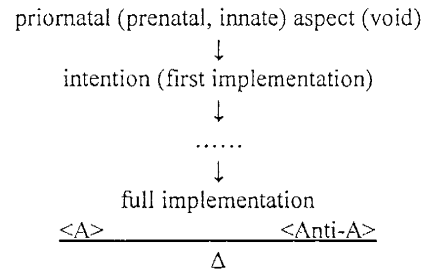
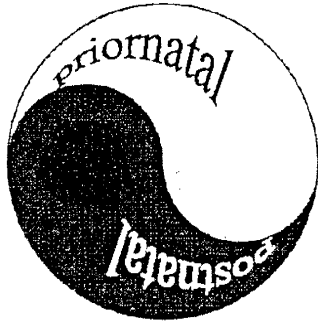

If we regard $\langle A \rangle$ as the positive attitude and $\langle \text{Anti-A} \rangle$ the negative attitude toward a desire, an intention, inspiration, assumption, etc., $\langle A \rangle$ and $\langle \text{Anti-A} \rangle$ have in this way become logic operators, take “I can speak English” for example:

As positive operator $\langle A \rangle$, it doesn't mean he speaks good English at the moment, but the confidence in his success. In this way he acts in the positive manner.

As negative operator $\langle \text{Anti-A} \rangle$, it doesn't mean he speaks ugly English at the moment, but the lack of confidence in his success. In this way he acts in the negative manner.

In reality logic comes as the balancing between these two actions, as summarized below:

Unity of opposites: both $\langle A \rangle$ and $\langle \text{Anti-A} \rangle$

The hidden integral: every mind is gifted with the gene of the universal mind: the integral of our ultimate inner nature which is identical with that of the universe. This is what I call yang in I-Ching (the originator) - it is formless, shameless, timeless ... the completely opposite world from our believed consciousness. So I call it the prior natal aspect, or wuji in the Taiji figure, or possibly Dao in Daoism.

Postnatal aspect: what we see, acquired knowledge, set of rules, etc. regarded as a specific implementation of some source in a specific situation

Priornatal aspect: what is hidden or lies under the phenomena as the origin of logic. $\langle A \rangle$ and $\langle \text{Anti-A} \rangle$ should be derived from the same source, namely priornatal aspect (can be void in representation, but nothing nihility)

Yinyang perspective: the balancing is based on both priornatal and postnatal aspects. This unity is called a contradiction.

Practical description: intention(priornatal, implemented, indeterminacy), where those implemented have been represented as truth or false, and those not implemented have been attributed to indeterminacy.

Key issue: there remains a gap between these two aspects, and the same source can be carried out in different ways

Simplified description (definition): the unity of contradiction between logic director and its implementation

Why do we need to describe the prior-natal aspect of logic? The ambiguity of logic definition lies in the indistinction between conception and implementation. A concept without substantial implementation is usually abstract or even arcane, because it can never be understood by human (e.g., the primitive intention can be haphazard, underlying or void, i.e. non intention, such as “why was I born?”), therefore it is always void of significance. The implementation, however, can seldom match with exact accuracy with the presumption in concept (as shown in [2] and [3], Logic is always subjective, always partial), there must be inconsistency or even contradiction between them, therefore, we need to examine the relation (we call contradiction) between them to carry out the definition:

Logic is defined as the unity of contradiction between logic director and logic implementation.

The contradiction refers to the unification of divided opposites.

In differential perspective we find such descriptions as truth and false.

In integral perspectives we find: truth in false, false in truth, percentages in truth values, neutrality, indeterminacy, etc, leading to the evolution of logic in such a cycles as “birth – growth – prosperity – wither - death”, in its limitation to the unification with non-logic; the unifying way in its ultimate limit resembles the voidness or emptiness we have called, but of essential difference with those we have imagined.

Should logic be defined on the differential basis or the integral basis of these opposites? Chinese Daoism asserts that everything is defined in the unity of opposites namely yin and yang, where yang conducts change and yin brings it up, so here I assume that yang directs change and yin implements it (a sample model: excitation and inhibition in unity). The unity is also described as neutrality in neutrosophy, but my personal inspiration from Daoism indicates more:

Since ordinary human is very limit in his enlightenment on the nature, i.e., his knowledge appears as incomplete in both time and space domains (space incompleteness means his partiality, and time incompleteness refers to his lack of insight to

the cause-effect, leading to the lack of insight to essence and nature), I should define a priornatal aspect of knowledge (referring to the innate aspect) as contrast to the acquired aspect, because all the acquired one is in fact born, grown and develop from the innate aspect, as if a sophisticated human figure is developed from a single gene. I have to assume this, even if it can be void in form. The priornatal aspect corresponds to yang.

In practice however, the absolute priornatal aspect is intangible, therefore I exploit a relative concept that an implementation (e.g., a complete set of rules) is derived from a relatively “priornatal” intention, which can either be regarded as the absolute priornatal aspect or an intermediate implementation. So I apply (Priornatal, Implemented, Indeterminacy) as its status.

This status representation has suggested a novel strategy toward association, e.g., when the three components are represented as operators, or in sets and in recursive manner.

To simplify this discussion, I simply use the contradiction between director (as priornatal aspect) and implementation to illustrate the essence of logic, which reveals the fact that any set of rules is a specific implementation of a priornatal seed under/in specific circumstance, condition or situation.

Is there any significance in such a contradictory way of definition? Let’s see what this definition reveals:

Logic refers to practical or even endless actions rather than dead rules.

There are always a director and an implementer in every action of logic. The former provides new directions (e.g., assumption, idea, assertion) to the action and the later carries it out (provides substantial support, verification, proof or negation).

There is always contradiction (unity of opposites) between them, with the contradiction sometimes appearing identity and sometimes antagonistic.

It is this contradiction that defines the validity of logic: truthness, falseness and indeterminacy.

The contradiction shows much more than values do: it is very likely to signify the trend of further development, and illustrate the status in both quantity and quality.

Neural networking and logic are in fact homogeneous.

So far one may blame for the similarity to conventional logic – an automata that automatically fetches instruction and interprets it, then carries it out automatically. It is true in appearance, but different in the essence that consistency is only achieved through the tradeoff between inconsistencies – to find the identity, or unity of them. We can alternatively regard the contradiction as a rhythmmed change (like a single pendulum with varying amplitude), in positive-negative endless revolutions. Unlike mechanical changes, there is an identity, unity or neutrality underlying in the endless generations of the evolution. This is the point our eastern culture defers from that of the west. Why don’t we regard the opposites as one unity?

As the ultimate limit, when the amplitude of the above pendulum converges to naught, i.e., no longer any distinction between truth and false, logic seems dying out but our intentions, although without reasoning, is getting closer and closer to the reality (one needs to understand the entire ancient Chinese culture to understand this philosophy).

3. The Excitation/Inhibition Loop

How much have men explored the priornatal aspect of the world? I-Ching (Book of Changes) shows that the everything in the world is made up of two opposite and complementary aspects or attributes (not necessarily priornatal and postnatal, for convenience we take them as hyper-matter, because we normal people are always inhibiting our perceptions with opposite excitements – we emphasize to much on the shaped or developed matter forms than the prior-shaped origin): yin and yang, which in combination produces the five basic hyper-elements (five-phase): wood, fire, earth, metal and water, with each giving rise to another and inhibiting another as well. The significance of this hyper-matter system has long been proved in Chinese history and by Chinese medicine.

Can we initiate the priornatal aspect of a system in this way? Inspired by the trigrams below, I primitively define the mapping (since I am strictly limited in my insight, here I just launch the argument – leave the rest, e.g., to the next generation):

Wood character: to resonate to something as source information, and to perceive it, expand its influence.

Fire character: to generalize perceptions into conceptual pattern as guideline.

Earth character: to substantialize, nurture and bring up the above conceptual pattern in a particular situation.

Metal character: to formalize, to fix into model, to finalize the design.

Water character: to be skillful, artful, toward accumulative flexibility, so as to reach an instinct, in which all concept or logic is hidden or implied.

The excitation loop illustrated in I-Ching is:

Wood–yields→*Fire*–yields→*Earth*–yields→*Metal*–yields →*Water*–yields→*Wood*

The inhibition loop:

Wood–inhibits→*Earth*–inhibits→*Water*–inhibits →*Fire*–inhibits→*Metal*–inhibits→*Wood*

Can we implement the above intention? The above loops are better illustrated with my inspiration from the Later Trigrams of King Wen, I map the trigrams to:

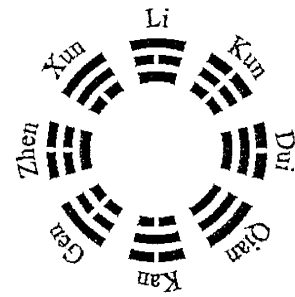

Zhen Agent (of character wood): the impression of a seed breaking through its outer shell and germinating, but with logic, I believe, the peaceful mind being stirred by an impulse (like the quiet water being stirred by a falling stone), to resonate to something as source information. As in automata where an instruction is given that issues a process except that this is a kind of stimuli that excites/inhibits another agent. In fact human mind is such an open receiver: it is constantly stirred. Resonance to a good source can plant or promote the growth of a healthy seed rooted in our mind, and that to a pernicious source can spoil or destroy our intelligence. Although a pernicious seed looks favorable at the moment, it promotes our illusions and corrupts our mind through chronic, and eventually through sudden effect. Normally a man is resonating to varying sources in a spectrum, and the center of it depends on his underlying will.

Xun Agent (wood): to spread (broadcast) the influence of the above resonance to different senses (or referential frames), heterogeneous and even opposite, contradictory, for them to feel, percept (interpret):

$$d(interp.) = \sum_{i=1}^{\infty} \frac{\partial(interp.)}{\partial(rf_i)} d(rf_i)$$

where *Interp.* denotes the interpretation, *rf_i* the reference frame *i* and *Imp.* the impulse. The action resembles compiler except on the multiagent based contradiction compatible multi-referential background. A resolved man can manually inhibits the pernicious spread of unhealthy influence, and thus kill the virus seeds rooted in his mind. In this way he can change his destiny with this persisting reform. So is a society – it can definitely step into chaos, disorder and trouble if enhances the free spread of all kinds of media as in networks. If so, not only should we see the retrogression of mankind, but the pernicious disaster as well. To a common man, his ideology depends heavily on the sources he resonates to, and the public ideology resonates exactly to the media, not the real truth. In this way the society is killed by the media rather than nuclear weapons, so is mankind.

Li Agent (fire): to assemble the above interpretations into an integral pattern, as a concept, a hypothesis, proposal or myth serving as a guideline:

$$guideline = \int d(interp.) = \sum_{i=1}^{\infty} \int \frac{\partial(interp.)}{\partial(rf_i)} d(rf_i)$$

The action resembles convention concept tree except that it functions as a concept (or logic) director, conductor or guide, of even inconsistent components, in an indeterminate manner, like an adviser that helps figure out the general situation, plan, etc. which need to be developed and implemented in the future or future generations. A good pattern is not necessarily recognized by all, due to the diverse seeds active in different people, and different referential manners. Whenever one chooses a good pattern, it is only through practice to build up his confidence and trust, not merely imaginations. So a pattern is true only when testified and proved in practice, not in superstitious manner. Still, only in practice, can one complete and implement the pattern. This is the significance of a truth.

Kun Agent (Earth): to substantialize, nurture and bring up the above pattern based on current situation (condition, environment, constraint, etc). It implies the balance with reality (as defined in [3], logic in essence is a kind of balance), i.e., a tradeoff between motivation and reality. It is usually in this action that a balancing point can be found, and the above beliefs (I have assumed that human is incomplete in his knowledge, in this case truth is only relative, or combined with subjective beliefs) is verified, modified (through feedbacks to earlier actions), and proved for validity. The action resembles conventional logical proof except that it works in the indeterminate mode. The action seems to be an obedient verification (obedient implementation). Even a true pattern serves only as a guideline, not the implemental instructions. Among the heterogeneous minds, there does not exist an exact protocol of regulation, nor an absolute fare law. Laws vary among situations, and lawyers seldom apply them as doctrines. For example, there are different understandings toward human right issues. To a superman species should share the same respect as human's, but to a mean, others, other groups (as rivals) or other nations (as in the third world) would be less respected in heart as himself/itself. So the same guideline can be applied in either unselfish way or in self-centered manner, thus the same truth can remain treasure to some, and pernicious and evil to others, like a seed prospering in some area or situation, and withering and dying in others.

Dui Agent (metal): to fix into model, to formalize the implementation. The action resembles conventional knowledge representation except in the form of agent based active network with all the weight patterns of excitation and inhibition featuring the balances in all the contradictions. The validity of a good pattern is void without implemental instructions, and universal truth is arcane without substantial facts or materials supporting it. A college graduate without experience is nothing more than a bookworm. A real model cannot exist without practical experience. A good philosophy doesn't mean anything

without specific implementations. This is the significance of a real model. However, since every specific model grows up in a specific environment, it is normally absurd to directly copy existing models than to re-cultivate one's own realistic models.

Qian Agent (metal): to take the principal role by fighting against the old. This is a necessary step in metabolism, and through this action the developed model above is finalized. The action resembles knowledge update, but it needs time in a dynamic neural network to resist the old and build up a new belief (in a new weight pattern). A model can be temporarily or locally successful, but still hard to change the whole mind and the universal belief, because of the old propensity and inertia, such a great impetus as to kill the novelty. A man can be inspired at some spot, and carry out a model in a favorable situation, but the heaven would not always keep sunny and mild, there are storms and heavy winds ahead. To stand against the unfavorable circumstances especially the dreadful environments, one needs to persist in his reform to get rid of the resistance in his mind, and so to a universal extension. Everyone can play an instant role of the god but only sages have the perfect play in his daily life, whether in favorable or harsh situations.

Kan Agent (water): to be skillful, artful, into accumulative flexibility, as to reach an instinct in which all concept, logic, after a long conception process, turn onto something hidden or implied. Logic in conventional sense is born as a sort of rule or concept until it is digested into a kind of instinct, which gives rise to the flexibility in application, or in the end, it is used unconsciously – without realizing its existence. The previous concepts become hidden in deeper memory. The consequence of activating the model in endless repetition (bringing about the short cut in thresholds, and the expansion of this micro-society of activated neurons) has led to an extremity of expertise. On the other hand, adherence to rules or concepts can eventually trap one into partiality [3], loosing the integrity, therefore, “we should have a rest in Kan”. Any method reveals its theoretical and academic characteristics in application, until one day theory and practice melt into one, a unity, and melt into practical environments so that the original fixture blurs, liquidized (loosing its rigid shape), sublimated and distilled into an underlying philosophy, even shapeless. In this way the original fixture diminishes and vanishes in shape. But to those adherent to its outer shape, they would be inadvertently trapped in subjectivity – the reverse effect at the extremity.

Gen Agent (earth): the end of logic. Since everything is done unconsciously with great flexibility, even without the consciousness or concept of doing or not doing something, i.e., no distinction between action and inaction, unaware of following rules any more, therefore, the original issue becomes naturally obsolete and transformed into a form seemingly void, we can regard it as gene, but actually far more than it, like something seemingly nothing, as no action, or not-doing, even he is actually doing, or in action in other eyes. In this way the concept of action dies. At the highest stage, our mental creativity stops, because we don't need to add anything redundant to our instinct. At this level our minds stop at rest, as if we no longer care how to walk for which we struggled at infant age. But there are adverse circumstances when we add additional desires that trouble our minds. However, science in its evolution would follow the same style, and one day when we see through our illusionary desires, we will readily stop our imaginations. This evolution (contrary to that of Darwin) goes on and on in the limitless birth and death revolution, until one day we really see through all: what constantly born and die are merely in our minds, the universe remains exactly the same – past, present and future originally unified, no need to split it up (with so called creativity).

Can we see excitation or inhibition in this system? The excitation cycle goes clockwise in the figure. How water triggers wood in the next cycle? There are new problems in the in new generation of development, as old problems are “settled” (balanced). Let's now see the inhibition diametrically:

Dui inhibits Zhen: A built-up model can definitely inhibit our creativity, or unintentional exploration, because of the restriction with the known model, or loose of curiosity. The resonance to a fixed feature can definitely inhibits us to other or even hidden features, especially the heterogeneous and contradictory ones. As illustrated in [2], unintentionality contributes greatly to human creativity.

Qian inhibits Xun: having taken the principal role, the developed knowledge would inhibit the growth and expansion of previous unfavorable referential sources.

Kan inhibits Li: since the expertise is hidden in the instinct, is there any need to explore the concept or the philosophy? No one may ask why he is human instead of a duck, because there seems no problem at this stage – he is using his instinct, while the conception is at rest.

Other inhibitions (to my knowledge so far, I cannot specify the diagrams):

Wood inhibits Earth: in order to develop new ideas, one has to contradict with previous knowledge substantially, i.e., curiosity inhibits obedience. For example, when one responds to a new source as new concept, he would keep critical to the old; When one refresh his mind in religious way, to keep the new and faint resonance on and on, he has to fight against his previous sins, i.e., stop obedient to his old propensity.

Fire inhibits Metal: as we know in philosophy (especially neutrosophy and Chinese class philosophies), the most general or integral pattern of knowledge (as many people described as the absolute truth) is usually intangible: too abstract, too arcane and abstruse, unable to be represented or fixed in a definite form, or, completeness (complete in both positive and

negative perspectives, as in neutrosophy: both A and non-A, both A and anti-A) inhibits accuracy (the exact representation). *Conventional mathematics is inhibiting itself.*

Earth inhibits Water: Earth as the implementer is characterized with obedience, opposing flexibility (in reality yin does not constitute a body or entity without yang, but we are talking about yin aspect).

Are logic and neural approaches contradictory and inconsistent? This methodology of excitation/inhibition suggests a rhymed resolution to the integral of opposing logics (see [3]), leading to a dynamic weight strategy to be neutralized with that from neural network approach. And in this novel definition of logic, the two distinct and disjunct approaches come into one family, and we can predict their real unification theoretically.

4. Neutrosophic Analysis

This hyper-system seems in Chinese manner, is it related with neutrosophy? Logic has never found out where true and false values are born. In fact, they are born from each other – each from human distinction of the other, and more we care them, more we adhere to a logic, and thus spoiling our prior intention (a live one rather than a dead one), therefore logic itself undergoes an endless evolution, leading to non-logic.

Therefore, logic is merely an instant image of reasoning: the first attempt comes out of indeterminacy (e.g., to be engaged in a study), then the theoretical approach, which when fully developed, is fixed into such a logical model as concept, model or science. The science, however, will face its final stop when people all adhere to it, and yields uncertainty when men all take it as absolute certainty (e.g., Newton's classical physics), due to the incompleteness, or absolute incompleteness of any fixed model.

First let's assume the three aspects of referential systems in knowledge base: truthness, falseness and indeterminate, which lead to: valid information, false information and neutral (balanced) information, as the result of Xun action. Then in Li action there is confusion in the integral operation: how to combine positive, negative and indeterminate attributes, and in what form is the result? I am afraid it is also in the three T,I,F aspects:

T: a positive conception

F: a negative conception

I: indeterminate conception, including both currently balanced conception and incompleteness in the conception.

i.e., an integration of T,I,F, three in one, where the pure T or F being a special instance (extremity) already solved by conventional means. This is as far as pure conception goes – to plant a seed of concept that is subject to dynamic change. Since we cannot foresee the result in implemented detail, we have to wait until the seed becomes mature, and this is the significance of Kun action: to bring up the seed.

Even when mature, there are still three aspects of the grown up model:

The positive aspect,

The negative aspect,

The indeterminate aspect in both senses: balanced and incomplete.

Is it a valid model? Sure, since great deal of experience is gathered through Kun step. As we know every system has its advantage, weakness and indeterminacy, like every single mathematics. The point is to make the best use of it, i.e., to know how to apply the knowledge to a specific situation – to substantialize it. In fact, one can never find an absolutely complete model in our real world.

The developed knowledge may go through extremities: too positives (seldom contradictory, as in the classical logic), then we should take a rest, because of the “wujibifan” effect (reverse effect) indicated in Kan Action, to avoid being trapped in partiality.

Now every agent works in contradictions of excitation and inhibition, positive and negative... in dynamic balance. When does it stop? Never, since human is an open system. But to the extremity, when man no longer adds anything to his concept that has diminished into such an infinitesimal (ignorance and knowledge in unity, because one can see through the concept), there would be neither beginning nor stop, because in this case, positive and negative are united, asexual or neutral (or void, because of 1 as being against 0 as non-being).

There are similar approaches from neurology-I-Ching background, see [4] which summarized some of the related dialectical models and approaches including logics similar to Neutrosophy. But I cannot assure its conformity with the Chinese Classics (seemingly a combined philosophy). My work is complete independent from any other approach.

5. Concluding Remarks

Although men is constantly achieving in science, but from some quantum mechanics scientist's saying, we might have moved no further (In his dream he saw the speedy moving bicycle advanced no further. But when he stepped into this world in his dream, he felt he was moving fast).

Can one explain many of the unexplainable concepts in neutrosophy, with this methodology presented above? Sure, a problem of the implemented and the unimplemented, but the former is relative to some background or axiom – a supposition or a belief, and thus every logic in this way exists in a default background. This limitation (delicately pre-designed axiom)

must be abandoned before one can explore anything further.

Logic is in constant evolution, from birth, growth to prosperity, wither and death, but there must lie something underneath this change. So we pay more attention to the seed of logic while we regard logic only as an instant image.

One can plant either positive or negative seed, due to his confusion with the situation, i.e., a seed illustrated in the agent model may yield either good (although unfavorable at the point) or bad (even favorable at the point) fruit.

If one studies the amplitude of this oscillation between true and false, it undergoes a periodical wave from infinitesimal to maximal and then back to infinitesimal, reflecting both subjectivity and dynamic environment.

If the above amplitude keeps zero, i.e., no longer any distinction between truth and false, one may reach a practical mind: a natural mind, in unity with the objectivity, but note the multi-fold implication:

1. A casual or instant balance of the opposites can be temporarily reached but soon broken down when one still has his private desires. A casual or instant unification of the opposites can be temporarily reached but prone to be disturbed if he has not reached the complete natural way.
2. An idiot can be blind to any truth and false, but he can never reach this unification as long as he suffers.
3. A stone heart (deprived of consciousness, e.g., an absolutely void consciousness) does not live in the unification, but just the opposite: permanent apart of yin-yang.
4. It is the most sophisticated and difficult thing in the world to understand this point (so I am unqualified to mention). People would sacrifice all their own to follow a correct education. For short let's see a metaphor (I add the latter two items):

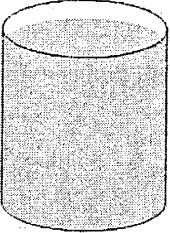
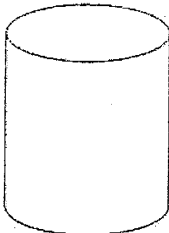
How much can your mind contain?		
for a full cup: 	for an empty cup: 	For the no cup:
No more, because it is fully occupied.	One cup.	It can contain the universe, because it is not confined to any form, shape or boundary.

Fuzzy logic is not at all a matter of percentage of beliefs between truthness and falseness as widely applied in conventional mathematics, but a dynamic balance between $\langle A \rangle$ and $\langle \text{Non-}A \rangle$, or $\langle A \rangle$ and $\langle \text{Anti-}A \rangle$, with the balancing point and incompleteness found in $\langle \text{Neut-}A \rangle$.

Since it is not clear enough to represent this balance in percentages, we need to exploit dynamic weight methodology in neural approach – allocating weights to each of $\langle A \rangle$, $\langle \text{Non-}A \rangle$, $\langle \text{Neut-}A \rangle$, etc.

Intentionality and unintentionality [2] coexist when both action and non-action are excited (in deferential point of view, they are alternately fired). It may be hard to believe that opposites can co-exist, but it can be implemented in reality.

Both $\langle A \rangle$ and $\langle \text{Anti-}A \rangle$ co-exist also in the way that they are alternately excited/inhibited, or one of them is implemented in such a balance that partially supports both.

$\langle A \rangle$ yields $\langle \text{Anti-}A \rangle$ when $\langle A \rangle$ is implemented into a contradiction that negates $\langle A \rangle$.

$\langle A \rangle$ yields $\langle \text{Neut-}A \rangle$ when $\langle A \rangle$ has been implemented into a balance between $\langle A \rangle$ and $\langle \text{anti-}A \rangle$.

Absolute accuracy inhibits comprehension, and conception inhibits accuracy – conventional mathematics is self contradictory. Hence the need to develop indeterminate mathematical patterns like neutrosophy.

Things shown in diversity in different perspectives come out of the same root, but the difference of different selves and different manners of reflection. To explore information fusion, one needs to cultivate the deeper backgrounds or hidden layers, and eventually, to the common basis shared by all. In fact, we all stem out of the same root (the deepest layer commonly owned by all), so do men and nature.

Why do our logics yield contradictions? Because we are so superficial as to take instant images real, see another paper unpublished: *Truth and Absolute Truth in Neutrosophic Logic*. But EVERYONE CAN EXTRICATE HIMSELF OUT OF THE MAZE OF ILLUSION as long as he is resolved to reform – ignoring or abandoning his previous ideology of this bewildering world and persistent in the greatest teachings.

References

- [1] Feng Liu: *Dynamic Modeling of Multidimensional Logic in Multiagent Environment*, 2001 International Conferences on Info-tech and Info-net Proceedings, IEEE Press, People's Post & Telecommunications Publishing House China, 2001, pp. 241-245.
- [2] Feng Liu: Smarandache F., *Intentionally and Unintentionally: On Both, A and Non-A, in Neutrosophy*, Proceedings of the First International Conference on Neutrosophy, Neutrosophic Logic, Set, and Probability, University of New Mexico, USA, 2002, <http://xxx.lanl.gov/ftp/math/papers/0201/0201009.pdf>, also in Octagon, Brasov, Romania, Vol. 10, No. 1, pp.

194-203.

- [3] Feng Liu, Florentin Smarandache: *Logic: a Misleading Concept — A Contradiction Study toward Agent 's Logic Ontology*, Proceedings of the First International Conference on Neutrosophy, Neutrosophic Logic, Set, and Probability, University of New Mexico, USA, 2002, pp.88-100, <http://www.gallup.unm.edu/~smarandache/NeutrosophicProceedings.pdf>; Libertas Mathematica, University of Texas at Arlington, 2002; Los Alamos National Laboratory archives (New Mexico, USA), <http://xxx.lanl.gov/ftp/math/papers/0211/0211465.pdf>; *Dialectics and the Dao, On Both, <A> and <Non-A> in Neutrosophy and Chinese Philosophy* (title changed), Seeking Wisdom journal, Gallup, NM, USA, No. 1, pp. 56-66, Spring 2003..
- [4] Chris J. Lofting: *Integration, Differentiation, & Meaning (IDM): The Properties and Methods of Personal and Social Identification* (e-book), 2003, <http://pages.prodigy.net/lofting/idm001.html>.
- [5] Florentin Smarandache: *A Unifying Field in Logics: Neutrosophic Logic – Neutrosophy, Neutrosophic Set, Neutrosophic Probability (second edition)*, American Research Press, 1999, 2000, <http://www.gallup.unm.edu/~smarandache/eBook-neutrosophics2.pdf>.

Processes of consciousness

Flavian Vasile
Academy of Economic Science
Faculty of Cybernetics
Computer Science Department
Bucharest, 6 Piata Romana, Romania.

Abstract – *This paper presents consciousness as the sum of describable processes, without limiting it only to verbal understanding. Consciousness is presented as a buffer space of the unconscious, accessed by any mental decision-taking processes. Consciousness is composed of sequential outputs of non-conscious processes that form, as frames in a picture, the impression of our ego continuity. The functional consequences on real-life information fusion problems are then further discussed.*

Keywords: Consciousness, conscious, unconscious, decision-taking process, information fusion, ego, alter ego, model of reality, objective.

2000 Mathematics Subject Classification: 68T01 Artificial Intelligence - General.

Motto: Consciousness is just a wondering flashlight in the dark hall of the inexhaustible factory that is the unconscious.

1 Introduction

Information fusion is not a problem easy to tackle. Coming as a natural objective from various high-demanding fields of activity, information fusion is an inovative approach on turning the immense flow of information into precious knowledge. The age of content-independent tools is reaching its peek: from the first statistical methods to the more modern data mining and text mining tools using machine learning techniques, researchers tried to automatically classify data in relevant and non-relevant disregarding the particularities of information. The future tools of information fusion need to artificially understand language (NLP) and, furthermore, consciousness, because information, as a resource, is present in a human-only accessible form. In my previous article “Premises for a multimedia Memory” [12], I’ve defined consciousness as the sum of processes we are aware of and that, accordingly, can be described at a latter time. Now it is time to analyze the consequences of this definition and see how well it does describe the actual human mind. The first encountered problem using this definition was the unknown origin of conscious queries on non-conscious processes, queries that were presumptively the communication channel between the conscious and the non-conscious mind.

I then realized that we are aware of what we ask ourselves and that we can reproduce verbally any philosophical question that troubles our mind, but we cannot explain the process of arriving at this question. The logical thread of sentences is not continuous. The easiest explanation could be the shift of our attention focus. Still, this only happens when mind is disturbed by exterior factors. But in the process of deep thinking or meditation, the process is not discontinued by any of those factors: instead, we are making leaps of consciousness, gestalts that inner-change our focus. At least that is what appears to our conscious minds. So, if we keep the definition of consciousness as the sum of describable processes, then consciousness reduces to a simple interface between two non-conscious processes:

Two questions arose from this diagram:

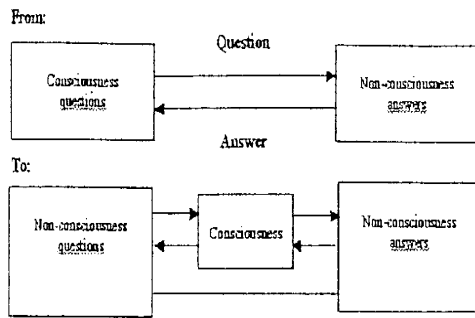

Figure 1: Consciousness is just a transit space between two non-conscious processes

1. If all questions are made and resolved inside non-consciousness why the need of consciousness?
2. If consciousness is just awareness of the outcome of our non-conscious processes where is our free will?

What we need to discover is the process that inputs the information of the transit space of consciousness and has will as the outcome. If the outcome of the process is a choice then a decision was made inside of it.

The diagram changes again according to figure 2:

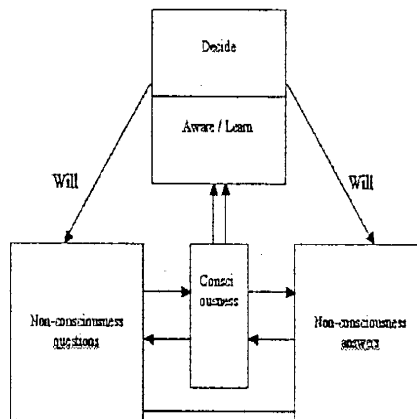

Figure 2: Consciousness is just superficially continuous

Consciousness is in fact it is composed by sequential outcomes of various processes needed in decision-making. The logic of all processes obeys the laws of neutrosophy ¹ [10].

In fact, the entire triangle of non-conscious processes forms the human impression of consciousness. We call conscious a process whose outcomes are often stored in our short-term memory and that can be the object of a decision-taking process.

¹Neutrosophic logic (or *Smarandache logic*). A generalization of fuzzy logic based on Neutrosophy [9]. A proposition is t true, i indeterminate, and f false, where t , i , and f are real values from the ranges T , I , F , with no restriction on T , I , F , or the sum $n = t + i + f$

The dialog between non-conscious processes is registered in the “memory stack” and accessed by the decision-making process. Like in a no-ending genetic algorithm, various solutions of the problem are generated, saved in the stack and then the best of them is chosen. This representation is internal and anthropological plausible².

To prove it, we are going to get a little bit metaphysical. If we change the labels of the diagram we will have this representational juxtaposed-analogy (see figure 3).

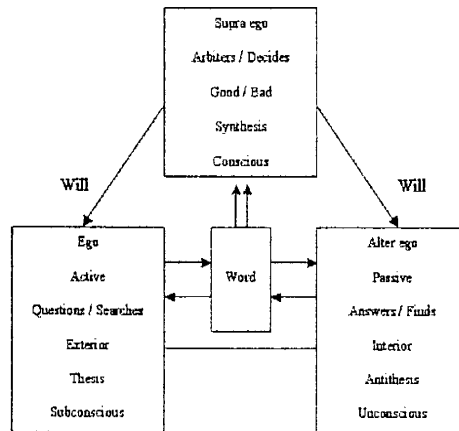

Figure 3: The common unconscious assumptions made on mind’s structure sustain the 3-stage diagram [4, 5, 6].

To exploit the new discovered framework of consciousness, we need to define a set of specialized terms.

2 Definitions

Model (mental model): A particular view on information.

Key elements of a model:

- assumptions/activation
- patterns/memorized
- instances/classification
- rules/integration
- dimensions/proprietary
- queries/action
- scenarios/solving scenarios.

1. **Assumptions** = express the ‘genealogy’ of the model (set produced at the time of the making of the model); [function] places the model in the hierarchy of models/set also used in verbal processing;
2. **Activation pattern** = the prototype created and updated by the memorized instances; [function] activates the model;
3. **Memorized instances** = instances interpreted and memorized according to the given model; [function] the backbone of the model / they offer the prototype of the modeled reality and also the fuzzy limits of the model;

²These arguments can be further used as according to “Outline of a General Methodology for Consciousness Research” [1]: “empirically study our conception of consciousness ... can lead to progress on consciousness itself ”

4. **Classification rules** = updated with the results of the latest classified instances; [function] rules for interpreting the new information / rules for predicting future behavior;
5. **Integration dimensions**³ = the points of view from which the information is processed and integrated; [function] multidimensional access to memories;(value-scale)
6. **Proprietary query templates** (see query) = created in the interaction with other models; [function] cross-hierarchical processing;
7. **Action scenarios** [3] = an assembly of actions from the pool of known possible actions, valued by its chance of success and utility; [function] the processing power of the model (generating and optimizing scenarios could be solved through genetic algorithms, especially genetic programming);
8. **Solving scenario** = a particular form of action scenario, where the actions are all replaced with proprietary queries on other models; [function] the interaction scheme of the model;
9. **Synthesis mechanism** = a non-conscious version of genetic programming; [function] creates a single version of incoming partial solutions, the explicit form of information-fusion;

The above-mentioned key elements are grouped together in the following manner:

1. [4, 9, 10, 12] The **objective model of reality** = what is commonly thought as objective knowledge: awareness of space, time, cause and effect, etc. Also called the *general predictive model of reality*, because it internally represents the expected behavior of the environment in a non-interventionist scenario.
2. [1, 3, 6, 8] The **interactive model of reality** = the subjective knowledge of possible actions exercisable by the actor on the given reality. This model is context-dependent because actions are seen as possible depending on the value-scale used at that particular time.
3. [5] The **value scale** used at the reference moment.

The interactive model of reality and the value scale compose various **attitudinal models** that expresses the subjective view on the world and that is more susceptible to be prone to change.

Main reality model - The winning model at a given time. It is used as a reference plane in the model hierarchy.

Operational models (action models, solving models) - particular models that establish the interpretation and the set of possible actions for a limited part of reality.

Model hierarchy - has the main reality model as the reference plane, but can shift the analysis to any other models' point of view. 'This entire hierarchy, comprising all the models is in fact a **representational multi-space**, according to Dr. Florentin Smarandache definition (from 'Transdisciplinarity, a neutrosophic method')[8]:

Let S_1 and S_2 be two distinct structures, induced by the group of laws L , which verify the axiom groups A_1 and A_2 respectively, such that A_1 is strictly included in A_2 . One says that the set M , endowed with the properties:

- a) *M has an S_1 -structure,*
- b) *There is a proper subset P (different from the empty set \emptyset , from the unitary element with respect to S_2 , and from M) of the initial set M which has an S_2 -structure,*
- c) *M doesn't have an S_2 -structure, is called an S_1 -structure with respect to S_2 -structure.*

³Integration dimensions are given by the four value scales= Moral scale (evil-good), Aesthetic scale (beautiful - ghastly), Axiological scale (true/false), Pragmatic scale (useful - inutile).

Let S_1, S_2, \dots, S_k be distinct space-structures. We define the *Multi-Space (or k-Structured Space)* as a set M such that for each structure $S_i, 1 \leq i \leq k$, there is a proper (different from the empty set, from the unitary element with respect to S_i , and from M) subset M_i of it which has that structure. The M_1, M_2, \dots, M_k proper subsets are different two by two.

Query – a request that contains information shaped to fit the activation pattern. Returns the set of applicable models;

Objective – describes a commensurable state (that can represent the fulfillment of multiple desires);

Will – represents the impulse of an objective (or its entropy);

Objective function – the *complex structure that generates new objectives; the functional ego*.

The Decisional, Questioning and Answering modules – represent the key elements of the proposed framework (see fig. 2). They are treated as modules because although they represent processing stages, they are not strictly sequential and they can all run in the same time.

3 Solving an objective. Information fusion using module dynamics.

Module 1 (the questioning module) receives the objective transmitted by the mean of will and searches for a set of questions that answer the problem according to the main reality model. More generally, it shapes the queries' data to fit the solving modules' activation patterns. The nature of the objective set in the decisional module (or stage) determines:

- the nature of the attitudinal model;
- the effective time frame of solving;
- the vegetative functions to be engaged (and their biological counterparts);
- recall of past experience and solving strategies.

On the basis of the attitudinal model, **module 1** establishes the *solving strategy*⁴ (as a set of queries/questions). Usually the solving strategy is not complete. If a decision must be made on the next step of the strategy, this itself becomes an objective and a solving strategy is searched. There could be multiple levels of embedded solving strategies, but the nature of the last of them is always verbal. The question that arises is: *What is the next step?* At this level formal processing comes into play and the problem is solved using abstract representations⁵. A solving strategy is produced dynamically by module 1 in dialog with module 2 (the solving module).

Module 2 (the answering module) receives the question (pattern) and searches for eligible models to describe it. If none of the models fully answers the question, further processing is needed. The set of models must be restricted and another decision takes place. After that, further questions are made, according to the elected model.

If no alternative models are detected in the unfolding hierarchy no other decision process is started so the intermediate dialog is not saved into consciousness. The attention focus remains on the last consciously chosen model. The subsequent queries are all non-conscious:

Objective O – Question L_1
 To Answer L_1 Question L_2 according to M_1
 To Answer L_2 Question L_3 according to M_2
 ...
 To Answer $L[n]$ do $M[n]$

⁴An evolved form of action scenarios.

⁵The abstract form of symbols entices the ability to double-references (referring references), to talk about a previous discussion, for example.

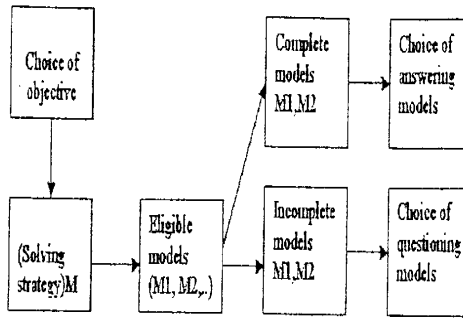

Figure 4: The decision module can be recurrently called inside the other modules.

Module 3 (the decision module) - The decision module is unique for all the models. It is called anytime when a high-uncertainty choice must be made. It *receives* the **non-conscious outcome** and *decides*:

- a) in the case of a unique model M_1 , if M_1 is suitable for solving the given problem. If not:
 - The question is rephrased (the data is reshaped – calls module 1)
 - Another model is searched (calls module 2)
- b) in the case of multiple competing models (M_1, M_2, M_3, \dots) which subset provides a better action scenario.

The resulting scenario is a synthesis⁶ of actions chosen on the estimated probability of various interpretative models (M_1, M_2, M_3, \dots) and on the estimated probability of future behavior according to each model. This mix aims to reduce the overall risk and to maximize the profit.

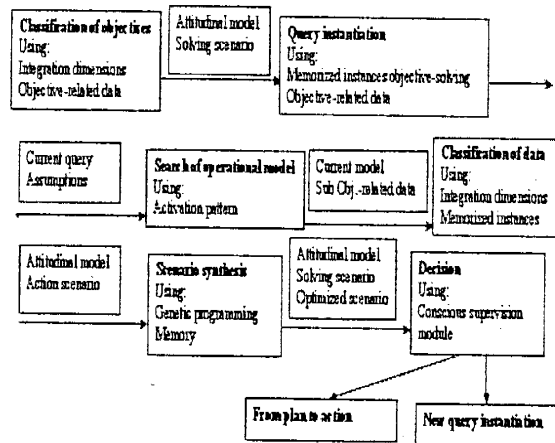

Figure 5: Simplified processing diagram for the 1-query, 1-model case

⁶To make the synthesis possible, all the actions must be translated in a set of functions that increase/decrease proximity to the objective. The functions will be optimized using genetic programming [7]

4 Model construction

Constructing a model always implies a search. There is no coincidence we are using expressions like *searching for a model* or *finding a model*. The search for a new model starts with the new acquired data and the results of failed classifications according to the models normally used. First a set of rules is searched to map the input and the observed output.

The simplest set of rules will be the rules of memorization itself: instance-based. **But mind recognizes them as describing the same reality**, so they must be coherent as a whole. To solve that, mind emits a number of generalization rules that fit most of the data⁷. If the rules contradict the meta-model but still have strong local generalization capacities, the model is considered incoherent with its surroundings and it is isolated as an operational neutral-model (waiting to be coupled with or overthrow the main theory).

If the *generalization* rules do fit with the main reality model, it begins the search for a particular set of rules to explain the contradictions (exceptions) with the main theory. Normally, there is not enough information to single out only one set. So, we will have a set of *probable rule-sets*⁸ for the new data.

Inside this set the search is done according to various **dialog strategies**:

- the ego and the alter ego show the pros and the cons of a rule-set using the same main model (inner-coherence);
- the ego and the alter ego are playing the accepted model of reality (meta-model) and the modified model of reality (if the contradiction would be a main rule).(thesis, antithesis, synthesis)(anti-model);
- the ego and the alter ego emulate the main model and one of the operational models partly contradicting the main model (neutral-models) (a new model could represent a link between them or an argument for one of the models). However, a new model is not easily accepted as an alternative to the old meta-model, because it lacks the data to sustain a complex set of generalization rules. Normally, a new model of reality appears after a series of powerful mental experiences (revelations).

Example:

Main model: *Everybody likes me.*

New data: *Dana doesn't seem to like me.*

Rule sets:

Model (hypothesis)1:	Model (hypothesis) 2:
<i>Dana doesn't like me.</i>	<i>Dana likes me.</i>
	<i>Dana hides this very well.</i>

Dialog strategy no. 1:

Model 1: *Dana doesn't like me.*

Ego Pros: *She showed me that.*

Alter-ego Cons: *Actual contact with Dana/Past positive experience.*

Model 2: *Dana likes me. Dana hides this very well.*

Ego Pros: *Actual contact with Dana / Past positive experience.*

Alter-ego Cons: *She showed me that. She said it to other persons.*

Because of the difference of the pros and cons nature, model 1 wins as the result of direct experience.

⁷The generalization rules are part of the assumptions and help to locate the model referring to the main model of reality. The generalization rules are in fact the activation pattern of the model. The particular rules further model the data inside the model and represent its innovation degree

⁸Most of the rules are already located in various operational models. The origin of the selected rules is saved as the assumptions of the model.

Dialog strategy no. 2:

Model 1: *Dana doesn't like me.*

Ego-meta-model (thesis): *Everybody likes me.*

Alter ego-anti-model (anti-thesis): *Nobody likes me. They all pretend. Dana is the exception.*

Both of the models are too strict. A synthesis is needed: *Some of them like me, some of them pretend and some of them don't like me and don't pretend (Dana).*

Model 2: *Dana likes me. Dana hides this very well.*

Ego meta-model: *Everybody likes me.*

Alter-ego anti-model: *Everybody likes me. They all show it. Dana is the exception.*

Both of the models are too strict. A synthesis is needed: *All of them like me and some of them show it (because some of them don't show it = Dana).*

The meta-synthesis:

Some of them like me and show it (< PP), some of them like me and don't show it (PD), some of them don't like me and pretend (< PP) and some of them don't like me and don't pretend (PD).

As we can see the sum of the probabilities (PP =past probability, PD =direct probability) is more than 1.

Dialog strategy no. 3:

Model 1: *Dana doesn't like me.* Ego meta-model (main): *Everybody likes me.* Alter-ego neutral-model (underground): *There is no real love between people. Only mutual interest.*

'Dana doesn't like me' can be a relative pro for the non-model. However, it is the nature of the contradiction that is decisive. For example: 'Dana is green.' could be a pro for the non-model: There are people from outer space.

This brings into the discussion the implicit assumptions of the main theory. The origin of these assumptions is hierarchical inside of a class of models. Classes can be unified only when they have the same assumptions from a starting point.

Ego and alter ego

Inside the brain, time, or should I say past, has no meaning. Decomposing parallel processing in two models of ego and alter ego is just a mean to superficially understand it. Because of memory there is no difference between space and time: comparing two models M and $M + 1$ that occurred sequentially in time is done in spatial processing⁹.

The uneasiness of understanding mind's functioning is due to the fact of time-independent information (relevant existent information doesn't have to be really located; it just 'pops' into consciousness: something appears in consciousness when a conceptual model is properly activated). So various models coexist in non-conscious.

Inner speech

Sequential awareness of parallel processing gave birth to inner speech – an emulation of communication between two parallel processes. Consciousness validates the results of non-conscious using various frames: For example, from the time-frame perspective: the short-term actions must not contradict with the long-term strategy.

⁹ M produced $M + 1$, but M is not replaced by $M + 1$: they run in parallel and can be compared.

Along the process of solving the objective the nature of the operational tasks can change and determine a shift in the attitudinal model. If the attitudinal model changes, the conscious switch between two models is needed because there is no reference point for the fitness functions of the models.

5 Conclusion and further development

The design of the present processing framework is in fact the first stage of a fully developed autonomous learning agent, capable of independent information-fusion processing. The present paper is the third in a series [11, 12] that aims to establish the theoretical principles of its functioning. Further theoretical discussions are needed in the following areas: drawing a parallel with the various stages of consciousness [2], tailoring a viable objective-function, establishing information-fusion capacities (synthesis) capacities using genetic programming, taking working decisions under the long-short term contradictions pressure. The articles to follow will analyze each of these subjects.

References

- [1] Antony M.V., *Outline of a General Methodology for Consciousness Research*, Anthropology and Philosophy 3 (2), pp. 43-56, 1999.
- [2] Eliade M., *Mythes, Rêves et Mystères*, Edition Gallimard, Paris, 1957.
- [3] Frese M., Sabini, J., *Goal directed behaviour: The concept of Action in Psychology*, London: Lawrence Erlbaum Associates, 1985.
- [4] Freud S., *The Ego and the Id*, (The Standard Edition of the Complete Psychological Works of Sigmund Freud), W.W. Norton & Company, September 1990.
- [5] Hegel G.W.F., *Phenomenology of spirit*, Oxford University Press, 1979.
- [6] Jung C.G., *The Archetypes and The Collective Unconscious*, (Collected Works of C.G. Jung Vol.9 Part 1), Princeton Univ. Press, 2nd edition, 1981.
- [7] Michalewicz Z., *Genetic Algorithms + Data Structures = Evolution Programs*, Springer Verlag; 3rd Revision edition, 1996.
- [8] Smarandache F., *Mixed Non-Euclidean Geometries*, 1969.
- [9] Smarandache F., *Neutrosophy / Neutrosophic probability, set, and logic*, American Research Press, Rehoboth, 1998.
- [10] Smarandache F., *A Unifying Field in Logics: Neutrosophic Logic. Neutrosophy, Neutrosophic Set, Probability, and Statistics*, (Second Edition), American Research Press, Rehoboth, 2000.
- [11] Vasile F. C. , *The building of an artificial memory, the first step towards the artificial intelligence*, Journal of Economic Informatics, 2002.
- [12] Vasile F. C. ; *Premises for a multimedia memory*, Proceedings of the International Conference on Economic Informatics, Bucharest , Romania, 2003.

A Note on Neutrosophy and Buddhism

Prof. Dr. Huang, Cheng-Gui
Tianjin City, Nankaiqu, Weijinlu 154 hao
Shibeili 4 hao 2 men 204, 300073
People's Republic of China
E-mail: amritahcg@263.net

I claim that Neutrosophy, by Professor Florentin Smarandache, is a deep thought in human culture. That gives advantage to break the mechanical understanding of human culture. For example, according to the mechanical theory: existence and non-existence could not be simultaneously. Actually existence and non-existence are simultaneously. Everyone knows that human life is like a way in the empty space of a bird flying. Everyone can not see himself a second ago, everyone can not see himself for the time being and everyone can not see himself a second future. Everyone could not know what is the existence of self. Everyone is also difficult to say the non-existence of self. So the existence and non-existence of self are simultaneously. And the existence and nonexistence of everything are simultaneously, where, the law of excluded middle does not apply. These basic facts express the depth of Smarandache's Neutrosophy. He has a lot of friends in ancient and in nowadays, in the West and in the East.

We know the famous poetry of Buddha's in his "Diamond Sutra":

Doing Dream

All active beings are like dreams,
Illusions, water bubbles, shadows,
Dew-drops, or lightning's.
Should make view in a way like this.

The life of every one is like a dream, or every one is birth and death in a dream. The existence of the world is like an illusion, or the world is produced and vanished like an illusion.

Every one could not distinguish what is a dream and what is his real life. Every one could not know it is a dream when he is being in a dream.

About this issue, Madhyamapratipad (The Mean), two thousand years ago, Nagarjuna, a scholar from ancient India, wrote two books, one was titled "Madhyamika-satra", and another was titled "Madhyamika Karika" (Treatise of the Middle Way). One thousand and five hundred years ago, Jizang, a Chinese scholar, wrote a book titled "Commentary on Madhyamikasatra". Five hundred years ago, Zongkaba, a scholar from Tibet, wrote a book titled "Extensive Interpretation of Madyamika-satra".

From these books we should know the depth of the Neutrosophy.

Reverse Engineer the Universe!

Homer B. Tilton
Pima Community College, EC
Tucson, Arizona USA

Part I. A novel view of the theorization process with examples

Always open with a brief humorous story, they told us in speech class; so here goes. There was this local TV news item:

The commentator relayed a story of how a small airplane crashed after the pilot lost control. It seems the pilot was doing "aerobic exercises" instead of paying attention to flying. I visualized the pilot stretched out on the deck doing push-ups. Then I realized the commentator had probably meant to say the pilot was doing *aerobic exercises*--that is, aerial acrobatics; loops and rolls and such!

The physical theorist (not "physical therapist") when theorizing about such things as the effect of gravity on moons, planets, and small airplanes is really attempting to reverse engineer that aspect or corner of the physical Universe. "Reverse engineer" is a verb currently in use by software engineers to refer to the attempt to fathom and list the source code for a computer program. However, the term can be traced back at least to 1960 in connection with hardware when it meant an attempt to fathom and reconstruct the circuitry inside a potted electronic module.

What does it all mean?

----- When looked at as a reverse-engineering task, perhaps some of the mystique is taken out of the process of forming a physical theory. And looking at it this way, one might think of *That Great Self-Made Engineer/Inventor In The Sky* as having designed and constructed (created) the physical Universe by whatever process. Along with others Newton tried to fathom the design; cosmologists, the construction; Darwin, the life-shaping processes. The Church reacted by essentially saying God did not need Darwin's help.

When putting the finishing touches on a scientific theory, one may claim to have fathomed a corner of either:

Category A - The Universe; or

Category B - A somewhat equivalent universe, but not the actual one.

Ptolemy in the second century of the Christian era placed the Earth at the center of the universe and no doubt believed that to be a Cat'A solution. The Pope certainly liked it. But later, Copernicus (1473-1543) became convinced that Ptolemy had found only a Cat'B solution; Galileo (1564-1642) and Newton (1642-1727) agreed, but popes did not come around until the late 20th century when that one (John Paul II, as I recall) finally "pardoned" Galileo for having voiced views the Church did not like.

Today it is generally agreed that the Ptolemaic universe is a Category B solution, a solution having only transient value. It may be that Cat'B solutions, in general, are necessary first steps in theorization; indeed,

reverse engineering of complex devices and systems--whether manmade or natural--is perhaps never 100% successful.

Tom Young and his neuronc color sensor

----- At age 28 Thomas Young announced before the *Royal Society of London* the basis for a neural system to sense color--that was his *trichromatic theory*. He may have intended that his idea fit Cat'A; however, not all agreed. Helmholtz, as translated:

...such a work would hardly be worth the labor until the science itself was in a much maturer state than it is at present.

Helmholtz wrote that in 1866. It was not directed overtly at Young whose idea he was well aware of, but at a "history of physiological optics" which nevertheless connects firmly to color-vision theorization. So even then, indications were that Young's idea really belongs in Cat'B. Helmholtz wrote other critical things including: "To conceive this theory objectively...would not be correct." The reference was obliquely but clearly to Young's idea. Then the Royal Society renamed Young's idea to the *Young-Helmholtz Trichromatic theory*, after which Helmholtz' energies were directed at attempts to prove Young's idea. But even his final attempt, his "line element" theory, was not able to do that.

Young stated his 1801 idea like this:

[Since] it is almost impossible to conceive each sensitive point on the retina to contain an infinite number of [resonant] particles...it becomes necessary to suppose the number limited, for instance, to the three principal colors...

The "it is almost impossible" introduction might today be characterized as a "straw man" using a terribly pejorative term from 1896. At any rate we know today that it is not the only way to proceed, and Young's final supposition is not at all necessary.[1] But by that pronouncement from a highly respected scientist and its support by the highly prestigious Royal Society, Young's resonance-based principal-color paradigm became locked-in for 200 years and still counting as this is being written.

Since that time all recognized attempts to devise a detailed theory of color vision have been based on that paradigm, assuming three or four principal or "primary" colors. All have met with incomplete success in exercises reminiscent of attempts to use epicycles to fine-tune Ptolemy's theory (over a 1300-year period)! Newton historian Westfall: "Long established views are not easily surrendered."

The connection to petrified knowledge

----- A term credited to Florentin Smarandache, "petrified knowledge" applies to the planetary theory of Ptolemy and to the trichromatic theory of Young. By thusly projecting those two theories through the same lens, I am assured of never being invited to speak before the Royal Society! (No loss, since that possibility never existed.)

But, dear reader, both Ptolemy and Young were geniuses in their respective times; and it is not my purpose to trash Young any more than it was the purpose of 15th- and 16th-century theorists to trash Ptolemy; Young did a fine job in view of the inadequacy of the times; his trichromatic theory even defines the color television cameras of today.[2] Only one robot camera that I am aware of ever did it differently.[3] Whatever the future may bring,

Young's other work will no doubt continue to stand as testimony to his genius; but if we did not question our most sacrosanct theories we would be doing a disservice to science.

All who call themselves "scientist" must continually be on the lookout for gems of petrified knowledge. If you can legitimately question the basis for a long-held view perhaps it has outlived its usefulness and the time has come for a renewed effort to reverse engineer that corner of the Universe. But tread carefully; novel claims must be firmly supported. You need more than simply a desire to see it be so.

Part II. Young Albert Einstein and his electromagnetic time machine

After the turn of the 20th century, relativity and Einstein became hot-button items in the popular press. It is said that when he was very young Einstein wondered what it would be like to ride on a beam of light. That early wonder may have colored his philosophy throughout his life.

The way it was in 1905

----- Relativity as presented by Einstein at age 26 had an exciting Alice-In-Wonderland quality. Not only did he build on ideas of Minkowski, Lorentz, and others with his special theory,[4] he also energized them by concluding that the speed of light, c , is a universal speed limit and suggesting that the ancient human desire to travel in time might truly be realized if one went fast enough. A contemporary, Jules Henri Poincaré, independently developed the same mathematical theory but did not take the same conclusions from it.

Poincaré and Einstein agreed that perceived lengths would shrink towards zero and masses increase towards infinity as the body moves faster and faster approaching c . But one man concluded from that that the speed of light is ultimate while the other did not spin it that way! How could the same set of mathematical, theoretical results lead to two very different conclusions? Here is one possible scenario and explanation:

1. Einstein may have been of the what-you-see-is-what-you-get school wherein if you see a fast-moving arrow shrink and become more massive, then the arrow must certainly have undergone those changes. And if you see a clock run slower when it is in motion, then that means time, itself, has *slowed* as a result of the motion.[5] That could well lead a student of that school to believe that $v > c$ cannot happen and/or that one can travel through time.

2. Poincaré may have been of the appearances-can-be-deceiving school wherein if you see a fast-moving arrow shrink or become more massive or a moving clock run slow, one can conclude only that there is such an appearance. Ergo, there is little incentive and no need to postulate either a speed limit or time travel.

Physicists F.K.Richtmyer & E.H.Kennard (1947): "Perhaps...we have [in the relativistic effects] a sort of *kinematical perspective*, analogous in a way to the ordinary experience that an object appears to change in size as it recedes into the distance." And, I might add, if we were to observe relativistic effects on a daily basis, we might come to think of them in just that way.

At any rate, Einstein's view that the speed of an object is limited to the

value c can be legitimately questioned without endangering the mathematical integrity of relativity.[6] My friend Florentin Smarandache appears to have rejected outright Einstein's view concerning a universal speed limit, but on grounds which I do not fully understand. His views on time travel are unknown to me.

Time for a change

----- It seems increasingly clear that *time* is only a made-up parameter, with *change* being the real item involved. While it makes sense to ask whether a change can be reversed (some can, most cannot), it is quite meaningless to ask whether time can be reversed. This all comes under the heading, "Getting Real."

Hermann Bondi: "Time must never be thought of as pre-existing in any sense; it is a *manufactured* quantity."

John Wheeler: "Should we be prepared to see some day a new structure for the foundations of physics that does away with time? ... Yes, because 'time' is in trouble."

Doc Emmett Brown: "The future is not written. It is whatever you make it."

We may spend our energies entertaining one another with stories of time travel such as Steven Spielberg's "Back to the future," (that 3-part movie should be seen by every freshman science student) but it is hoped we would also explore actual new frontiers by seeking out the truth and not become addicted to fantasy. To paraphrase a well-known saying, "Truth is more exciting than fiction."

With the relativistic effects no longer considered real, the light barrier vanishes like a phantom. So does time travel. It was fun while it lasted and we may mourn its passing; but that would be a mourning wasted for there are jobs to be done leading to much more exciting times. (Let's have fewer mornings wasted.) Einstein may forever ride his lightbeam, but that does not mean the rest of us are similarly constrained.

[Note to Editor: Please note and preserve the two different spellings, "mourning" and "morning"; important to the pun.]

The following text highlights the old don't-confuse-me-with-facts-my-mind-is-made-up syndrome. It originally appeared in *LIGHT WORK*, Feb'95, p.3, copyright Homer B.Tilton.

Why not an infinite force?

----- It is often said that the mass of an object tends to become infinitely large as its speed tends towards the speed of light. Certainly that position is backed up by the behavior of subatomic particles inside particle accelerators or "atom smashers." That is a fact of measurement, predicted by the special theory of relativity. That fact is then given as a basis for proving that the speed of light cannot be exceeded under any circumstances; for you would need an infinitely large force to accelerate through the speed of light, and everyone knows that an infinite force is impossible to generate.

End of discussion? Well, not quite. Consider the following scenario from a *gedanken* technical conference:

The discussion has just reached the point, "everyone knows that an infinite force is impossible..." when, just as the audience members prepare to leave, a young upstart, Norman Nerdnick, speaks up from the rear of the conference hall.

Norman: 'Scuse me!...If you can have an infinite mass, why can't I have an infinite force?

Conference speaker: How do you propose to obtain your infinite force?

Norman: The same way you got your infinite mass; by relativistic means.

Conference speaker: Specifically? (Feigning interest...)

Norman: Consider an accelerating rocketship. It derives its thrust from material shot out of the exhaust nozzle. Now, as the rocketship goes faster and faster approaching the speed of light, its mass increases towards infinity as you pointed out; but the rocket fuel also has its mass increase towards infinity, so the thrust produced would tend towards infinity would it not? Thus we go zipping right through the light barrier like it's not there!

Member of audience: Can we discuss this later? Many of us have another session to attend.

Everybody leaves...

References and notes

[1] See Homer B.Tilton, "A history of color vision and the modern Helmholtzian brightness-hue-saturation model," the journal *Atti Della Fondazione Giorgio Ronchi* (Italy), ISSN 0391-2051; in press, scheduled to appear in Vol.LVI, 2001, No.3.

[2] On the synthesis end by way of contrast, three-color displays--whether television or computer displays--have nothing to do with Young's theory but only reflect Newton's findings relative to color mixture. Four-color computer displays which include a yellow phosphor can produce more different colors and more-saturated colors than can the standard RGB three-color display.

[3] Homer B.Tilton, "Color sensing device based on a novel principle," *Optical Engineering*, July/August 1979, pp.429-431, ISSN 0036-1860

[4] The theory is "special" in that it deals only with inertial systems. Einstein's original treatment of the famous "Twins Paradox" was made before the general theory was developed. The astronaut twin's motion is not inertial; and the popularized, published results obtained using the special theory cannot be trusted because it is a problem fitting the general theory. Those results concluded that the still-young astronaut twin upon returning home after a long-distance journey at or near the speed of light, c , found his stay-at-home twin long dead of old age.

[5] *Slowed relative to what?* is a question not generally addressed. The appearance of a second kind of time is required; is it Einstein's "proper time"? Unclear.

[6] *Speed relative to what?* is again a question ordinarily ignored. The speed of a photon at c may be a universal constant needing no reference; but a rocketship is not a photon. It may be that Einstein confused going at lightspeed with being a lightbeam, which could explain much concerning his conclusions.

HG Wells Telecom

¡PREGÚNTALE AL CIENTÍFICO!

Sociedad Española de Exobiología
Apartado de correos 5115
46009 Valencia (España)
se2x@ono.com

¿Es posible mandar información al pasado? Mi nivel en Física es...

- Guillermo, 35 años, Lima

Gracias por tu aclaración sobre tu nivel de conocimientos de Física; dada la naturaleza de tu pregunta, es evidente que podemos contestártela mucho mejor si la podemos adaptar a tu nivel y, como es tu caso, "saltándonos" la explicación de algunos conceptos que serían bastante complicados de exponer a alguien que careciera de estos conocimientos. Vamos allá.

En 1972, el matemático Florentin Smarandache afirmó que no existía un límite de velocidad absoluto en la naturaleza, basándose en la paradoja EPR-Bell (Einstein, Podolsky, Rosen, Bell). Aunque esta paradoja parece haberse resuelto recientemente, existen muchas otras indicaciones que nos hacen pensar que la hipótesis de Smarandache es correcta, basándonos en la mecánica cuántica y en algunas de las teorías de unificación. Si esta hipótesis resultara ser cierta bajo cualquier circunstancia, habría que modificar algunos conceptos de la Física moderna para que "ajustaran" a la misma; y significaría, en todo caso, una revolución en las comunicaciones.

Parece que fue Sommerfeld quien constató por primera vez la posible existencia de partículas más veloces que la luz, a las que Feinberg llamó *taquiones*. Los taquiones tienen masa imaginaria (en el sentido de que es una masa prohibida por la relatividad), y de hecho nunca han sido detectados experimentalmente. De todos modos, la relatividad no prohíbe directamente la existencia de partículas sin masa, como el fotón; lo que de ella se deduce es que si estas partículas sin masa devinieran superlumínicas, viajarían en el tiempo hacia atrás. Y por tanto, los físicos asumieron que los fenómenos superlumínicos no existían en el universo, pues de lo contrario habría que explicar la paradoja causal, aquello de "si viajo al pasado y mato a mi abuelo antes de que conciba a mi padre, entonces no puedo nacer para viajar al pasado y matarle, por tanto naceré y viajaré al pasado y le mataré, por tanto no naceré y no podré hacerlo, y así *ad infinitum*).

Sin embargo, la mecánica cuántica sugiere que la comunicación superlumínica existe. De hecho, algunas hipótesis hablan de que la existencia de fenómenos superlumínicos en la naturaleza no sólo es posible, sino necesaria (véanse por ejemplo los trabajos de Gao Shan), y de hecho ahí seguimos teniendo, explicada o no, la paradoja EPR-Bell. A partir de esto, Smarandache sugirió de nuevo en 1993 que no existía un límite de velocidad absoluto en el universo tal y como postulara Einstein.

La teoría Rodrigues-Maiorino.

Estudiando las soluciones a las ecuaciones de Maxwell y Dirac-Weyl, los brasileños Waldyr Rodrigues Jr y José Maiorino propusieron una teoría unificada para la construcción de velocidades arbitrarias en la naturaleza (o sea, cualquier cosa entre cero e infinito). De esta manera, la hipótesis Smarandache ascendería a teoría, y la llamamos "Teoría SRM" (Smarandache-Rodrigues-Maiorino). Mediante la SRM, el principio de la relatividad especial sufre una ruptura, aunque los constructos relativistas de la mecánica cuántica -como la ecuación de Dirac-, no. Así mismo, la SRM propone que una combinación de espejos adecuadamente ubicados puede acelerar una onda

electromagnética a velocidades mayores que las de la luz. Esta suposición sería posteriormente confirmada por Saari y Reivelt (1997), quienes produjeron una onda superlumínica (llamada "onda X") mediante una luz de xenón interceptada por una serie de lentes y orificios.

La Teoría SRM es una solución matemáticamente pura de la ecuación de onda cuántica relativista, indica que no hay límite de velocidad en el Universo, y es por tanto la teoría más fuerte en estos momentos para la construcción de velocidades arbitrarias.

Experimentos superlumínicos.

Muchos experimentos, realizados en los llamados "modos evanescentes", han obtenido ya como resultado la propagación hiperlumínica. El primer "resultado evanescente" de esta clase lo obtuvo Nimtz en 1992, quien produjo una señal a $4'34c$ (c = velocidad de la luz en el vacío). Poco después, se dio el lujo de emitir la 40ª sinfonía de Mozart por FM, a $4'7c$. Pronto esta barrera fue superada, hasta los $8c$.

En el caso del experimento de Nimtz, no había quedado claro si se producía violación de la paradoja causal. Pero en el año 2000, Wang, Kuzmich y Dogariu publicaron en Nature que, durante un experimento de dispersión anómala realizado en la Universidad de Princeton, Princeton lograron emitir un pulso de luz (compuesto de fotones taquiónicos, masa cero) a la friolera de 310 veces c . En este experimento, para el que utilizaron dos rayos láser en frecuencias ligeramente distintas pasando a través de un gas frío de cesio, se pudo observar perfectamente cómo el haz de luz salía del proyector 62 nanosegundos antes de que entrara.

No obstante, Wang y sus colegas no creen que estos experimentos sirvan para transmitir información al pasado, porque están basados en efectos de interferencia sobre la velocidad de grupo. Pero en el mismo número de la revista, Jon Marangos explicaba que en el caso de pulsos de luz constituidos por un número reducido de fotones, se puede argumentar que la velocidad de grupo es la misma que la de cada fotón individual. Si esto lo aplicamos a cada fotón, estaríamos hablando de transmisión cuántica de información hacia el pasado.

En otro orden de cosas, la Teoría de la Relatividad General postula que la velocidad de la gravedad es c , debido a la restricción impuesta por la Teoría Especial. Sin embargo, Van Flandern publicó algunos resultados de sus observaciones astrofísicas que indicaban que la gravedad podría ser superlumínica, aunque Ibison, Puthoff y Little los explicaron con una teoría que no necesitaba de estos fenómenos superlumínicos. Por otra parte, la NASA ha observado que algunas galaxias podrían estar rotando con sus extremos a velocidades mayores que la de la luz, y aún no se ha encontrado ninguna manera de explicar estas observaciones desde un punto de vista sublumínico. Desde el punto de vista empírico estamos, pues, en una "situación de empate" aún por determinar.

La máquina Kitano.

En febrero de 2003, M. Kitano, T. Nakanishi y K. Sugiyama de la Universidad de Kyoto (el "Kitano Lab") sugirieron la construcción de un circuito electrónico sencillo capaz de aprovechar este efecto de "propagación negativa" transmitiendo efectivamente información al pasado. También plantearon la posibilidad de situar varios de estos circuitos en cascada para multiplicar el efecto, aunque advirtiendo que al hacer esto el ruido se dispararía exponencialmente. Que nosotros sepamos, este dispositivo no se ha construido todavía.

Taquiones.

Algunos modelos de la teoría de las supercuerdas (nuestro candidato principal a la Teoría Unificada) incluyen la existencia de los taquiones. Algunos físicos modifican esta teoría de tal modo que los taquiones desaparecen; otros, como Freedman, defienden que estas modificaciones son incorrectas y los taquiones son necesarios. La teoría de las supercuerdas es probablemente la más apropiada para estudiar los taquiones, dado que no obliga a trabajar con masas imaginarias de los

mismos. Algunos otros autores afirman que los taquiones se han detectado -aunque de una manera bastante retorcida- en los efectos atmosféricos de los rayos cósmicos.

Por tanto, y como conclusión, la respuesta más razonable a tu pregunta es "puede que si", aunque todavía no tenemos la absoluta seguridad y nadie ha producido en la práctica un mecanismo capaz de desempeñar tal función.

<http://webs.ono.com/se2x>

© 2003 Sociedad Española de Exobiología

(Todos los derechos reservados. Se permite la reproducción citando la fuente. 29/06/2003)

Estación Central Tiempo
¡PREGÚNTALE AL CIENTÍFICO!

Sociedad Española de Exobiología
Apartado de correos 5115
46009 Valencia (España)
se2x@ono.com

¿Es o será posible viajar en el tiempo?

- Vanessa, 18 años, Madrid

No sólo es posible, sino que lo estamos haciendo todo el rato. :-) Como imaginamos que te refieres a si es o será posible "saltar" al pasado o al futuro, vamos con ello:

Para empezar, sería conveniente definir qué es el tiempo. Todo el mundo parece saberlo pero, si les pides una definición, la gente no sabe muy bien qué contestar. Piénsalo, intenta expresar con palabras qué es el tiempo. Cuesta, ¿verdad?

Es que el tiempo no es una entidad material, sino una dimensión. Es, de hecho, la "cuarta dimensión" cósmica, definida como tal -entre otros lugares- en la Teoría Especial de la Relatividad de Einstein: largo, ancho, alto y tiempo (x, y, z, t). Las tres primeras permiten definir la posición de un objeto en un lugar determinado, la cuarta en qué momento se encuentra ahí. Y, lógicamente, surge la pregunta de nuevo: si se puede correr adelante y atrás por las otras tres dimensiones, ¿no se podrá también por la cuarta?

El tiempo es una dimensión un tanto especial. Para empezar, en apariencia sólo se puede avanzar por él en un sentido: hacia adelante, como hacemos todos los días. Con un matiz: de los propios trabajos de Einstein se deduce que también se puede recorrer hacia delante aceleradamente: es decir, es posible hacer un "viaje de ida" en el tiempo. Cuando un objeto se mueve a una cierta velocidad, la dimensión tiempo en que está inmerso se contrae. O en otras palabras: contra más rápidamente viajas por las dimensiones espaciales (largo, ancho, alto), más se contrae tu dimensión temporal. Como resultado, para ti el tiempo pasa más despacio que para el resto del Universo. El efecto práctico es que estarías realizando un "viaje de ida" espaciotemporal. Contra más te acercas al límite de velocidad máximo para los cuerpos con masa (que es la velocidad de la luz en el vacío, 299.792'458 kilómetros por segundo), más se contrae "tu" tiempo.

A velocidades próximas a las de la luz, un segundo "tuyo" serían miles o millones de años "de los demás". Este efecto se observa, por ejemplo, en los relojes de los satélites, que como vuelan a gran velocidad (decenas de miles de km/h) comienzan a notarlo levemente y hay que "ponerlos en hora" de cuando en cuando desde la Tierra, usando relojes atómicos. En resumen, puedes conseguir tu "billete de ida" por la dimensión tiempo sólo con correr mucho. Dejo a tu criterio el imaginar qué clases de motores y combustibles harían falta para lograr este efecto de manera eficaz, y si se te ocurre alguna buena idea díselo enseguida a la NASA, que tiene una beca instantánea de un millón de dólares para quien proponga algo viable en este sentido.

Pero, ¿y el billete de vuelta? ¡Ah, amiga! Aquí se complica la cosa. Siguiendo las ecuaciones de Einstein y sus coleguitas, para invertir el sentido del reloj tan sólo tendrías que... viajar más rápido que la luz. Hay un problema, claro: para los objetos con masa, la velocidad de la luz en el vacío -que los físicos llaman 'c'- es una barrera tan infranqueable como un universo de acero. Precisamente de los propios trabajos einstenianos se deduce que conforme te vas acercando a c, hace falta cada vez más energía para acelerar más, y esta energía que aportas se va convirtiendo no en velocidad, sino mayormente en masa. Cuando te faltase muy poquito para llegar a c -al coste de galaxias enteras de energía-, la mayor parte de la misma se gastaría engordando tu masa, y sólo añadiría un poquito más de velocidad. En el instante en que tocaras c, habrías consumido toda la energía del Universo y tu masa sería infinita. Como hipótesis del fin del mundo, esta dieta de engorde no está mal, pero pese a la gamberrada de cargarte todo el Universo -¿te parecerá bonito?- no habrías logrado superar la velocidad de la luz en el vacío. De momento, pues, parece que en la Estación Central Tiempo sólo venden billetes de ida.

Sin embargo, en un rincón de la estación, como suele ocurrir en las estaciones, hay una cabina telefónica. Es una cabina un poco extraña, y tiene un cartel encima en el que pone "llamadas desde destino". Resulta que, aunque ningún objeto con masa puede superar c, algunos objetos sin masa -como los fotones- si pueden hacerlo, al menos en determinadas circunstancias. A estas partículas hiperlumínicas de masa cero las llamamos *taquiones* (del griego tachyos, velocidad). Sólo existen a velocidades superiores a la de la luz -se ha llegado a teorizar que pueden viajar a velocidad infinita- y conforme se desplazan por las dimensiones espaciales, la

dimensión tiempo en la que existen no sólo se contrae, sino que retrocede: los taquiones viajan hacia atrás en el tiempo, llegan antes de partir. No es muy difícil imaginar que "marcando" estos taquiones en el punto de partida (por ejemplo: si lo hago rotar a la derecha es un cero, y si lo hago rotar a la izquierda es un uno), se puede transmitir información digital a base de unos y ceros, como voz, datos o vídeo, a un receptor ubicado en el pasado (tu teléfono móvil, por ejemplo, es un transmisor de información digital -tu voz- en el presente).

Este extraordinario efecto que se deriva de la Física Cuántica fue hipotetizado en 1972 por un señor que se llama Smarandache (por eso se llama Hipótesis Smarandache, a veces somos poco imaginativos), y está relacionado con la llamada velocidad de grupo (sería largo de explicar). El primero en observarlo en la práctica fue otro señor que se llama Sommerfeld. Desde entonces se han hecho muchos experimentos prácticos que confirman la teoría, al menos en parte. En 1992, Nimitz se permitió el lujo de transmitir la 40ª Sinfonía de Mozart por radio FM (microondas, masa cero), a 47 veces la velocidad de la luz. En 2000, Lijun J. Wang y su equipo de la universidad de Princeton lograron emitir un pulso de luz (compuesto de fotones, masa cero) a la friolera de 310 veces *c*. En este último caso, para el que utilizaron dos rayos láser en frecuencias ligeramente distintas, se pudo observar perfectamente cómo el haz de luz salía del proyector 62 milmillonésimas de segundo antes de que entrara. No está claro hasta qué punto todo esto servirá para remitir una verdadera señal al pasado puesto que está relacionado con fenómenos de interferencia dentro del propio pulso de luz; pero nos da motivos para pensar que aunque en la Estación Central Tiempo sólo se vendan billetes de ida, podría existir, en efecto, un teléfono mediante el que se puede hablar con el futuro, y quienes hayan llegado allí, con el pasado.

Como podrás suponer fácilmente, algunas personas que entienden mucho de todo esto (y también algún que otro chalado) están empezando a pensar en si los cuerpos con masa se podrían trucar de alguna manera para "colarlos" más allá de la velocidad de la luz... pero esto, si es que es posible, no sabemos todavía cómo hacerlo (De hecho, no tenemos ni idea).

Dejo a tu imaginación el evaluar qué efectos podría tener esto sobre las paradojas de la causalidad (ya sabes, lo de viajar al pasado y matar a tu abuelo, o al menos transmitir la orden de que lo maten, de forma que tu no puedas nacer para dar esa orden, por tanto naces y la das, luego no puedes y no la das, etc...). Los filósofos y científicos de altos vuelos tampoco se han puesto todavía de acuerdo al respecto, o sea que tu opinión será tan buena como la de cualquier otro.

(La comunicación temporal se trata con más detalle y complejidad en nuestro otro artículo [H.G. Wells Telecom](#))

<http://webs.ono.com/se2x>

© 2003 Sociedad Española de Exobiología

(Todos los derechos reservados. Se permite la reproducción citando la fuente. 9/12/2003)

The Schrödinger Cat Thought Experiment Land (The SCTE Land)

J. Harri T. Tiainen
 Healing Earth
 PO Box 5066, Chatswood,
 West NSW 1515, Australia
 E-mail: harri@healingearth.com.au

Abstract: Following a short review of ten well-known objections to Schrödinger Cat Thought Experiment, fourteen new objections are presented that show the central thought experiment of quantum mechanics violates the second law of thermodynamics. These objections are shown to be equivalent to Smarandache Sorites Paradox that is how $\langle A \rangle$ and $\langle \text{Non-A} \rangle$ are connected.

Keywords: Schrödinger Cat Thought Experiment, Second law of thermodynamics, Smarandache Sorites Paradox

The Schrödinger Cat Thought Experiment Land (The SCTE Land)

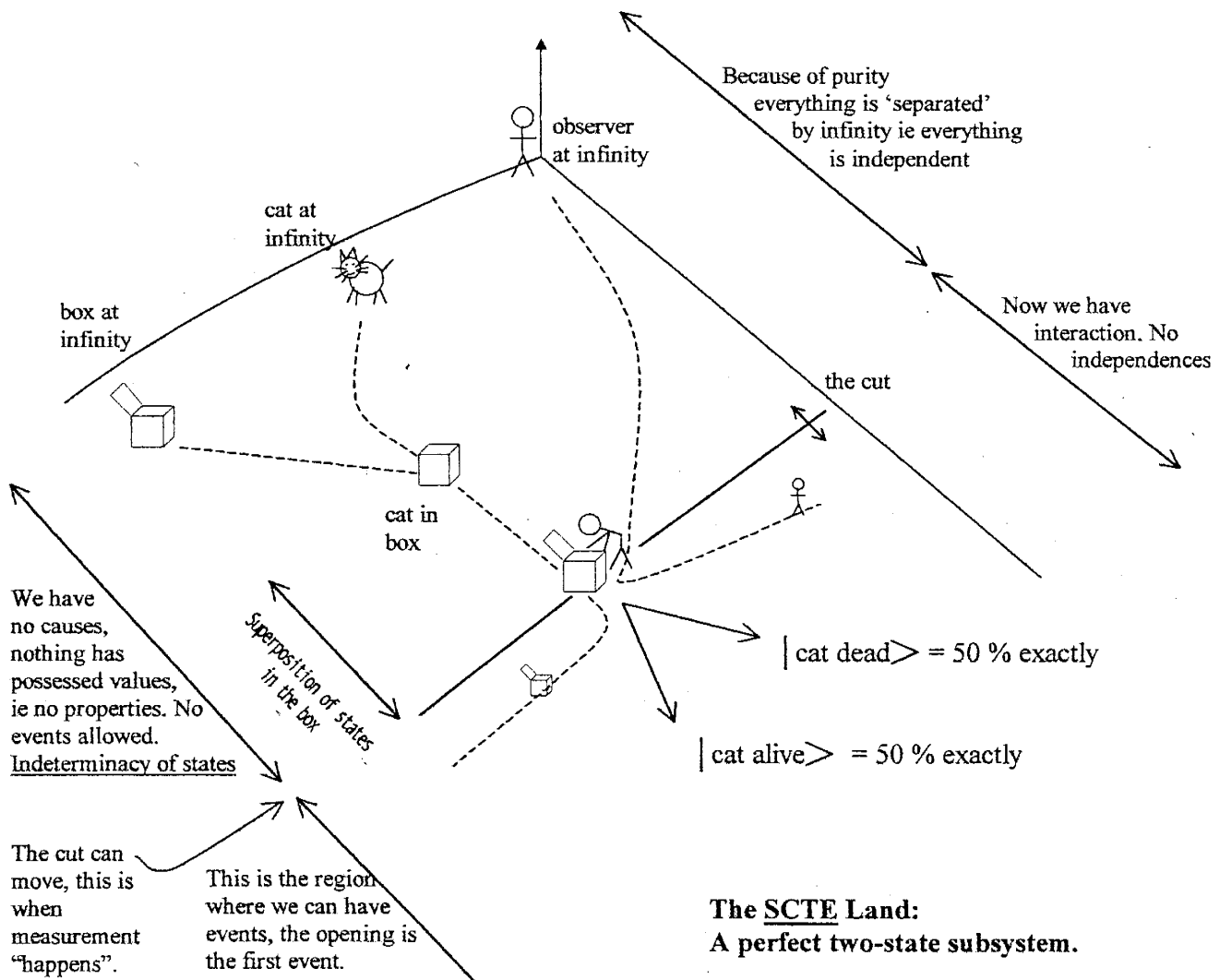

General on principle objections to the cat in the box thought experiment about absolute measurement. These are well known objections.

1. The wavefunction of the cat Ψ_{cat} and the Ψ_{obs} of the observer must be pure, no interaction is allowed between them until the opening. This is only physically achievable when infinitely far away from each other. So how do they meet?
2. Before the opening no quantum states occupied so no properties. Nothing is (literally) in this region because prior to the event, no states. So where do (the) properties come from? Or can/do states exist without properties?
3. It's one (sort of) event; we disallow any other event tainting the thought experiment. So how does anything else happen?
4. It's the only event, we have isolated "one" quantum system this isn't possible, quantum mechanics is (w)holistic, no such independent subsystem allowed. The SCTE cannot have parts, no (moving) parts. So how does the SCTE proceed?
5. It's the first event, before this no events, ie superposition, causes are not allowed, so the SCTE is the first event. What is there, to cause the first event, all we have is after the first. The SCTE is uncaused. So what causes the SCTE?
6. How do we trap the cat perfectly, only an infinitely deep (potential) well can achieve this? The cat cannot penetrate such a barrier. So how does the cat get out of the box?
7. If the cat is perfectly trapped, it must be in an infinite deep potential well. How does the observer quantum tunnel to the cat, ie open such a box? So, it's impossible for the observer to open the box. So how does the observer open it?
8. To construct the box we need material that is barrier-proof; perfectly rigid, such material isn't possible. So, how do we (physically) construct the box of the SCTE?
9. Splits the world into two realms. We have indeterminacy (ie superposition) of states that in turn passes to a world of indeterminism where things (only) might happen, only probabilities. Uncertainty rules. So how can we be sure of anything? Even if anything did/does happen?
10. One observer only. Wigner's Friend Paradox resolved by one (absolute) observer. But supposedly there are many equal (ie ontological/epistemological) observers! So, one observer can only do the SCTE. So how do we get many equal observers to perform the SCTE?

Objections to Schrödinger's Cat Thought Experiment

Thermodynamic Objections

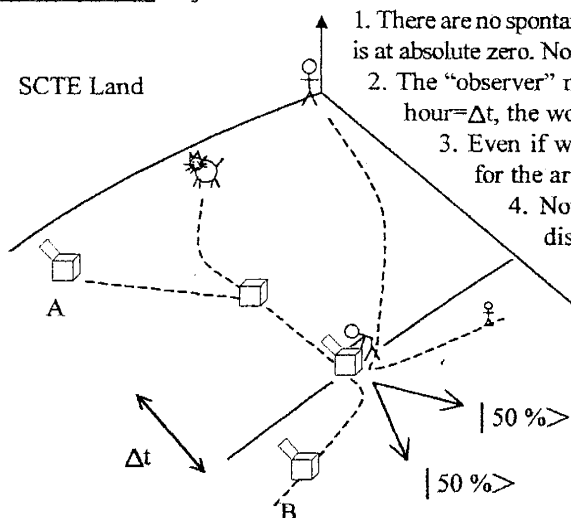

1. There are no spontaneous accessible microstates. The Schrödinger's Cat Thought Experiment SCTE land is at absolute zero. No work can be introduced to open a perfect two-state box system, recall purity of states.
2. The "observer" must have maximum available macrostates to open a perfectly rigid box. For one hour= Δt , the world outside the box has no definable entropy at all.
3. Even if we could open the box, it is at zero entropy with no definable temporal direction for the arrow of time, since no definable irreversible processes.
4. Notice how the box itself, goes through a Poincaré cycle of entropy return. The distribution of parts for the box at point A to point B is the return of all entropy from all the time before the box closed to all the time after it was opened. That is for one hour; the box; its contents; and the cat cycles (=superpositions) through all Wingers' friends, ie all observers and the total outside universe, as one whole.
5. The cat itself must have minimum available microstates and none spontaneously available. There is no environment available at all to the cat before the box closes the first time because the cat isn't in a bound state with the "observer" until the box opens the second time, you see time, cannot work twice. (There is no "negative" entropy to pay for a perfectly rigid box, to have time working in both directions at once. Where does this work, the second time come from?)

6. The cat and the box A until it captures the cat, form their own private time system, these hidden variables to the "observer", are never revealed. The "observer" before the box opens the second time, must be independent strictly, even by times' workings because the SCTE land is a perfect two-state system. There are no mixed states between the box and the observer before the 50%50% event. Recall, perfect preparation of states.
7. The 2nd law of thermodynamics thermal states is represented as a stationary principle of a complex deterministic equation. Schrödinger's equation is this deterministic equation, it is a stationary state, entropy cannot both be a max and a min at the same time, it needs to be a max the second time, and a min the first time, time worked, if you understand the confusions. The spontaneous accessible microstates of the Schrödinger cat energy operators, are obtained by "perturbations" of the stationary complex plane states, these represent the ensemble of the cat as an explanation for probability itself that is entropy recurrent time is accessible spontaneous, to the cat.
8. We have for one hour,
 - i) a spontaneous accessible Poincaré cycle, hidden to the observer
 - ii) time working forward and backward at once, max and min at once
 - iii) a frozen temporally directionless land, that is an event perfectly frozen
9. We have made the wavefunction, the carrier of ultimate information; it is entropy itself. We have made the "measurement" of the SCTE so perfect; it is in really absolutely perfect land. What is entropy itself in normal qm it must be the wave function, the entity that all information of the system resides, and how does this thing-in-itself transfer itself to temporal agents? Entropy the temporal process explains each and every counting event within time, & Ψ explains everything in time and of time by a timeless mathematical transformation $\mathbb{C} \rightarrow \mathbb{R}$ for temporal part distributions.
10. Instead of one hour let Δt equal Poincaré Cycle time, we can by inspection see that between Box A + Box B > Poincaré time, strictly

cycle time of the cat and the box against and the independent cycle time of the “observer” during point A and the first closing of the box? We have assumed perfect states without environment. Perfect states barren of real-valued eigenvalues only reside in the Complex plane itself. The initial conditions are that the cat and the box are states with complex eigenvalues, where the observer must be real valued.

11. Instead of one hour let Δt equal zero cycle time, we can see by inspection that this must be a two-state system that has zero entropy for its parts distribution. That is by looking at the role of thermodynamics in the SCTE Land we are lead to the conclusion that the event is a very very special case it is the zero entropy state. From which we have temporal max-ing and min-ing of the wavefunction of the projected atemporal state that of eigenvalue i . Gold’s universe comes to mind the universe begins and ends at the common zero entropy state: - that of a perfect two-state system. In the normal qm interpretation the system has complex and real values that are in a mixed states we have imbued the box with complexity and reality and naturality (=numbers complex, real and natural) by virtue that we humans = Winger’s friends can do a perfect two-state experiment. Complex Real and Natural valued operators are in mixed states in the normal qm interpretation of the SCTE.

12. The Box at Point A to the cut has a normalization constant of zero exactly; from the cut to point B the Box has a normalization constant of one exactly. Yes exactly zero chance of a temporal event before the 2nd opening of the box. The Box has two normalization constants that of zero and one at different ‘times’ throughout all paths of all histories of the cat, or the box. We have made time itself work twice if the SCTE is a “measurement” that humans can achieve in reality. We are barred by the 3rd Law of thermodynamics from reaching a region of (quantum) event space that is at zero absolute temperature and we are excluded by qm itself from regions where states only have complex eigenvalues. Also by the figure above the 2nd Law is identified formally as the mechanism of the 2nd opening of the box if the box is identified with irreversible events that is events that are not reversible within the Poincaré cycle time of all observers everywhere.

13. That is by point 12 empty boxes must superposition that is the fundamental postulate of qm is undermined. It is impossible by normal qm to interpret a normalization constant of zero. The ‘meeting’ of the cat and the box have exactly zero chance of being a temporal event done by temporal observers bound by the laws of thermodynamics as it applies to us humans and not what ‘happened’ at time=zero exactly. We have a perfect two state-system that of quantum states being complex or real-valued, being in a superposition state or a deterministic state of the Schrödinger equation, in a \mathbb{R} temporal environment projected from, the \mathbb{C} atemporal plane, with \mathbb{N} temporal discrete objects.

14. What event do we have a name for that acts like this it is the state that has zero entropy it is the state that all temporal states (real valued states) are both a max and min that is it acts as the \mathbb{C} quantum mechanically stationary state for all real-valued states. It is the limit point for all events temporal, and it is the creation of temporal processing itself for natural numbered eigenstates. The only consistent interpretation for all these objections is that the timeless explanation for the STCE Land is the big bang/crunch eigenvalue system. $\mathbb{C} \rightarrow \mathbb{R}$

What these objections mean:

Penrose calls thermodynamics a useful physics theory, and quantum mechanics superb but the cat in the box experiment directly contradicts the 2nd law of thermodynamics, which will rule, the 2nd law of a useful theory or the central thought experiment of what a “measurement” is, the SCTE experiment is a perfect two-state quantum system, its just that it’s too perfect, think of it this way it is in perfect land, it is at “infinity” to real-life cats and real-life people it is at “zero entropy land”. Real-life boxes leak; there are no perfectly rigid boxes, only at “infinity” in some sense. Recall at absolute zero, we still have zero point motion due to the uncertainty relationship itself but a land at zero entropy stills even this last residue of temporality. We’ve made it too perfect, no human can do the “first” or “last” of a perfect two-state system. The SCTE land is the “measurement” of measurements, it is what measurements after the box opens the second time limit to, it is the limit point of B, and the box closing the 1st time is the limit point for the box A. How does a zero entropy “observer”, interact with real-life observers barred by the 3rd law – a system cannot be cooled to absolute zero in a finite number steps? The land is truly beyond the reach of man or anything in time and of time, that is temporal operators bound by real-life laws of physics.

Objections to the “measurement”, what the objections are directed at is not quantum mechanics itself, but what we made the thought experiment attempt to do, this “measurement” is at zero entropy, the arrow of time is undefinable, and there is only one wavefunction $|50\% \rangle + |50\% \rangle$ superpositioning in its own absolute time frame of the Complex plane. The SCTE is a valid qm “event”, but its in perfect land, the “measurement” can only be achieved, by the wavefunction itself, acting in its role as absolute carrier of information, recall in qm real eigenvalues are obtained by “atemporal” projections from the Complex plane. The wavefunction is entropy itself, the wavefunction contains all true information, and the SCTE is a perfect two-state system, where the wavefunction is a complex stationary state. What is the “measurement”, that changes the total wavefunction of the complex plane, into a real-eigenvalued world of temporal directedness, the “measurement” is the creation of time itself. The bang of time is a perfect two-state system, of things in time and things out of time. Things out of time are the complex plane and its operators, things in time are the real plane and it operators. The “observer” of this “measurement” is the two-state operation of the complex plane that gives i as the only eigenvalue.

Eddington expresses it best (as quoted in The World within the World by John Barrow Chapter 3 Unseen worlds, §13 Thermodynamics)

“The law that entropy increases – the Second Law of thermodynamics – holds, I think, the supreme position among the laws of Nature. If somebody points out to you that your pet theory of the universe is in disagreement with Maxwell’s equation – then so much the worse for Maxwell’s equations. If it is found to be contradicted by observation – well, these experimentalists do bungle things sometimes. But if your theory is found to be against the Second Law of thermodynamics I can give you no hope; there is nothing for it but to collapse in deepest humiliation.”

We have made the box impervious to times assault.

So which will rule the 2nd Law of a useful theory ...it's not even a contest and everybody knows it. Paradigms Lost... "It's not even wrong." Wolfgang Pauli

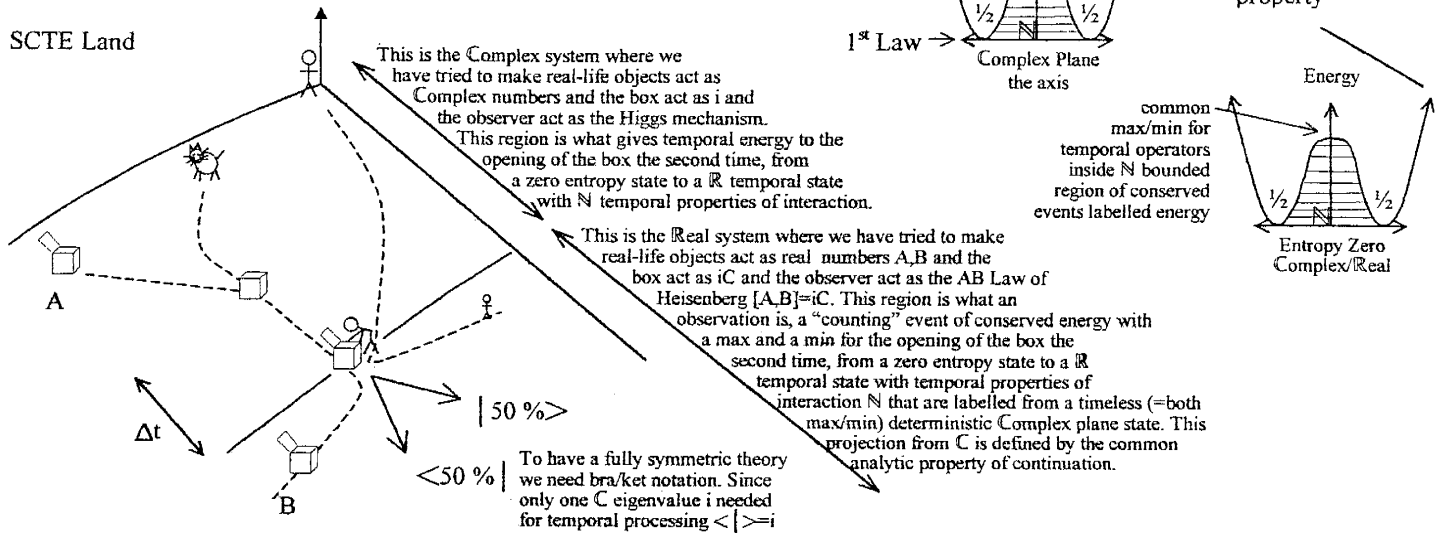

That is the task of this generation is to save the Schrödinger Cat Thought Experiment SCTE Land from observational contradiction with the 2nd Law of Thermodynamics. For I am truly sorry for these objections this paper has been hard to write, because of the shame of it.

CONCLUSION

There are four paradoxes known as the Quantum Smarandache Paradoxes; the first paradox is:

Smarandache Sorites Paradox:

Our visible world is composed of a totality of invisible particles.

- a) An invisible particle does not form a visible object, nor do two invisible particles, three invisible particles, etc. However, at some point, the collection of invisible particles becomes large enough to form a visible object, but there is apparently no definite point where this occurs.
- b) A similar paradox is developed in an opposite direction. It is always possible to remove a particle from an object in such a way that what is left is still a visible object. However, repeating and repeating this process, at some point, the visible object is decomposed so that the left part becomes invisible, but there is no definite point where this occurs.

Generally, between $\langle A \rangle$ and $\langle \text{Non-}A \rangle$ there is no clear distinction, no exact frontier. Where does $\langle A \rangle$ really end and $\langle \text{Non-}A \rangle$ begin?

How the SCTE land resolves the above paradox is:

Our visible world is made possible by invisible particles (literally the complex state that has eigenvalue i)

The imaginary component of a general complex number is called i , it is the invisible particle (number) that all visible "measurable" properties of objects are timelessly obtained via a quantum (Schrodinger) equation. The imaginary i is the entity that all measurements rely on, yet cannot be measured by definition since only real number eigenvalued states are observable. Recall the 'Heisenberg' law $[A, B] = iC$ shows how quantum variables are connected mathematically. The SCTE land shows that the region before the cut behaves as the Complex number system where we have tried to make real-life objects act literally as Complex numbers and the box the imaginary i since we have perfect preparation of the two states. If in the SCTE we insist that the cat cannot escape the box (i.e. perfect containment) for Δt we are forced by the 14 thermodynamic objections above to conclude that the invisible (non-measurable) i leads to all visible objects (measurements). The frontier between $\langle A \rangle = \text{measurement}$ and $\langle \text{Non-}A \rangle = \text{Non-measurement}$ is represented exactly by the cut where we have tired to make time work twice (objection 8ii). The quantum cut is literally the frontier between $\langle A \rangle$ and $\langle \text{Non-}A \rangle$ mathematically it is the timeless transformation that changes pure complex numbers into pure real numbers denoted $\mathbb{C} \rightarrow \mathbb{R}$. Loosely speaking **Smarandache Sorites Paradox** (associated with Eubulides of Miletus (fourth century B.C.)) is the linguistic equivalent of the 'Heisenberg' law, how invisible particles create a visible world.

“When we make an observation we measure some dynamical variable. It is obvious physically that the result of such a measurement must always be a real number, so we should expect that any dynamical variable that we can measure must be a real dynamical variable. One might think one could measure a complex dynamical variable by measuring separately its real and pure imaginary parts. But this would involve two measurements or two observations, which would be all right in classical mechanics, but would not do in quantum mechanics, where two observations in general interfere with one another—it is not in general permissible to consider that two observations can be made exactly simultaneously, and if they are made in quick succession the first will usually disturb the state to the system and introduce an indeterminacy that will affect the second. We therefore have to restrict the dynamical variables that we can measure to be real, ...”

We cannot make time work twice (equivalent to Dirac’s measuring separately a complex number’s real and pure imaginary parts) clearly $\langle A \rangle$ and $\langle \text{Non-}A \rangle$ are separated by quantum interference (that is the cut is literally this interference). This affect is dramatically demonstrated in the SCTE land where this interference literally is drawn and is identified as the timeless transformation $\mathbb{C} \rightarrow \mathbb{R}$ or $\langle \text{Non-}A \rangle \rightarrow \langle A \rangle$.

CONTENTS

MATHEMATICS:

<i>PAULO D. F. GOUVEIA, DELFOM F. M. TORRES, Smarandache Sequences: Explorations and Discoveries with a Computer Algebra System</i>	<i>5</i>
<i>HENRY IBSTEDT, Palindrome Studies (Part I: the Palindrome Concept and Its Applications to Prime Numbers)</i>	<i>23</i>
<i>A. S. MUKTIBODH, V. M. WAGH, Chains of Smarandache Semifields</i>	<i>36</i>
<i>CHARLES ASHBACHER, On Numbers That Are Pseudo-Smarandache and Smarandache Perfect</i>	<i>40</i>
<i>A. W. VYAWAHARE, K. M. PUROHIT, Near Pseudo-Smarandache Function</i>	<i>42</i>
<i>ZHANG TIANPING, On the k-Power Free Number Sequence</i>	<i>62</i>
<i>ZHU WEIYI, On the k-Power Complement and k-Power Free Number Sequence</i>	<i>66</i>
<i>HE XIAOLIN, GUO JINBAO, On the 80-th Problem of F. Smarandache (I)</i>	<i>70</i>
<i>HE XIAOLIN, GUO JINBAO, On the 80-th Problem of F. Smarandache (II)</i>	<i>74</i>
<i>MUNEER JEBREEL KARAMA, Smarandache Concatenated Magic Squares</i>	<i>80</i>
<i>ZHENG JIANFENG, Proof of Functional Smarandache Iterations</i>	<i>84</i>
<i>ZHENG JIANFENG, On the Inferior and Superior k-th Power Part of a Positive Integer and Divisor Function</i>	<i>88</i>
<i>A. A. MAJUMDAR, H. GUNARTO, On Some Recurrence Type Smarandache sequences ...</i>	<i>92</i>
<i>ADRIAN VASIU, ANGELA VASIU, The Fulfilled Euclidean Plane</i>	<i>113</i>
<i>DELFIN F. M. TORRES, Números Felizes e Sucessões de Smarandache Digressões com o Maple</i>	<i>119</i>
<i>JOHN PERRY, Calculating the Smarandache Numbers</i>	<i>124</i>
<i>JÓZSEF SÁNDOR, On Additive Analogues of Certain Arithmetic Functions</i>	<i>128</i>
<i>SABIN TABIRCA, KIERAN REYNOLDS, Recursive Prime Numbers</i>	<i>133</i>
<i>MUNEER JEBREEL, Smarandache Sequence of Happy Cube Numbers</i>	<i>139</i>
<i>ZHU WEIYI, On the Divisor Product Sequence</i>	<i>144</i>
<i>ZHANG TIANPING, On the Cubic Residues Numbers and k-Power Complement Numbers</i>	<i>147</i>
<i>MAOHUA LE, A Conjecture Concerning the Smarandache Dual Function</i>	<i>153</i>
<i>LIU HONGYAN, LOU YUANBING, A Note on the 29-th Smarandache's Problem</i>	<i>156</i>
<i>XU ZHEFENG, On the k-Full Number Sequence</i>	<i>159</i>
<i>LIU HONGYAN, ZHANG WENPENG, A Note on the 57-th Smarandache's Problem</i>	<i>164</i>
<i>SEBASTIAN MARTIN RUIZ, Diverse Algorithms to Obtain Prime Numbers Based on the Prime Function of Smarandache</i>	<i>166</i>

<i>LIU HONGYAN, ZHANG WENPENG, On the Simple Numbers and the Mean Value Properties</i>	171
<i>MOHUA LE, The Divisibility of the Smarandache Combinatorial Sequence of Degree Two</i>	176
<i>MAOHUA LE, The Smarandache φ-Sequence</i>	178
<i>MAOHUA LE, Two Functional Equations</i>	180
<i>MAOHUA LE, Two Formulas for Smarandache LCM Ratio Sequences</i>	183
<i>MAOHUA LE, An Equation Concerning the Smarandache LCM Functions</i>	186
<i>GAO JING, LIU HUANING, On the 45-th Smarandache's Problem</i>	189
<i>GAO JING, LIU HUANING, On the Mean Value of Smarandache Double Factorial Function</i>	193
<i>CHARLES ASHBACHER, LORI NEIRYNCK, The Density of Generalized Smarandache Palindromes</i>	196
<i>ZHU WEIYI, On the Cube Free Number Sequence</i>	199
<i>GAO JING, On the 49-th Smarandache's Problem</i>	203
<i>HOWARD ISERI, Paper Models of Surfaces with Curvature Creative Visualization Labs</i> ..	205
<i>CHARLES T. LE, BERND HUTSCHENREUTHER, Die Smarandache'sche Klasse von Paradoxien</i>	211
<i>BOUAZZA EL WAHBI, Convergence of the Smarandache General Continued Fraction</i> ...	213
<i>MUNEER JEBREEL, The first 10-th Smarandache Symmetric Numbers</i>	215
<i>LIU HUANING, ZHANG WENPENG, On the 57-th Smarandache's Problem</i>	218
<i>MAOHUA LE, Some Problems Concerning the Smarandache Square Complementary Function (I)</i>	220
<i>JASON EARLS, Some Results Concerning the Smarandache Deconstructive Sequence</i>	222
<i>LOU YUANBING, An Asymptotic Formula Involving Square Complement Numbers</i>	227
<i>FELICE RUSSO, On A Problem Concerning the Smarandache Left-Right Sequences</i>	230
<i>CHARLES ASHBACHER, Some Properties of the Happy Numbers and the Smarandache H-Sequence</i>	236
<i>JASON EARLS, Some Smarandache-Type Sequences and Problems Concerning Abundant and Deficient Numbers</i>	243
<i>JASON EARLS, On Smarandache Repunit n Numbers</i>	251
<i>CHARLES ASHBACHER, Some Simple Advantages of Reasoning in Intuitionistic Neutrosophic Logic</i>	257
<i>JASON EARLS, Smarandache Iterations of the First Kind on Functions Involving Divisors and Prime Numbers</i>	259
<i>JASON EARLS, The Smarandache Sum of Composites between Factors Function</i>	265
<i>YAO WEILI, On the Mean Value of m-th Power Free Numbers</i>	271

<i>JASON EARLS, A Note on the Smarandache Divisors of Divisors Sequence and Two similar Sequences</i>	274
<i>SEBASTIAN MARTIN RUIZ, Formula to Obtain the Next Prime Number in Any Increasing Sequence of Positive Integer Numbers</i>	276
<i>W. B. VASANTHA KANDASAMY, Smarandache Non-Associative (SNA-) Rings</i>	281
<i>W. B. VASANTHA KANDASAMY, Smarandache Pseudo-Ideals</i>	294
<i>HOWARD ISERI, Impulse Gauss Curvature</i>	299
<i>W. B. VASANTHA KANDASAMY, Smarandache-Galois Fields</i>	310
<i>W. B. VASANTHA KANDASAMY, Smarandache Near-Rings and Their Generalizations</i> ..	315
<i>W. B. VASANTHA KANDASAMY, Smarandache Semi-Automaton and Automaton</i>	320
<i>W. B. VASANTHA KANDASAMY, Smarandache Zero Divisors</i>	325
<i>MAOHUA LE, Some Problems Concerning the Smarandache Square Complementary Function (II)</i>	330
<i>MAOHUA LE, Some Problems Concerning the Smarandache Square Complementary Function (III)</i>	333
<i>MAOHUA LE, Some Problems Concerning the Smarandache Square Complementary Function (IV)</i>	335
<i>MAOHUA LE, Some Problems Concerning the Smarandache Square Complementary Function (V)</i>	338
<i>MAOHUA LE, The Smarandache Combinatorial Sequences</i>	341
<i>MAOHUA LE, A Conjecture Concerning Indexes of Beauty</i>	343
<i>MAOHUA LE, The Smarandache-Riemann Zeta Sequence</i>	346
<i>LI HAILONG, On Third Power Mean Values Computation of Digital Sum Function in Base n</i>	348
<i>HENRY BOTTOMLEY, A Lucky Derivative</i>	352
<i>HOWARD ISERI, A Classification of S-Lines in a Closed S-Manifold</i>	354
<i>SEBASTIAN MARTIN RUIZ, AZMY ARIFF, A Basic Characteristic of Twin Primes and Its Generalization</i>	357
<i>SEBASTIAN MARTIN RUIZ, Formula to Obtain the Next Prime in an Arithmetic Progression</i>	363
<i>SHYAM SUNDER GUPTA, Smarandache Sequence of Triangular Numbers</i>	366

PHYLOSOPHY

<i>FENG LIU, Truth and Absolute Truth in Neutrosophic Logic</i>	369
<i>FENG LIU, Toward Excitation and Inhibition in Neutrosophic Logic</i>	381
<i>FLAVIAN VASILE, Processes of Consciousness</i>	389
<i>CHENG-GUI HUANG, A Note on Neutrosophy and Buddhism</i>	398

PHYSICS:

HOMER B. TILTON, *Reverse Engineer the Universe!*399
SOCIEDAD ESPAÑOLA DE EXOBIOLOGIA, *HG Wells Telecom (Pregúntale al Científico)*
.....404
SOCIEDAD ESPAÑOLA DE EXOBIOLOGIA, *Estación Central Tiempo (Pregúntale al*
***Científico)*407**
J. HARRI T. TIAINEN, *The Schrödinger Cat Thought Experiment Land (The SCTE Land)*
.....409

Papers concerning any of the Smarandache type functions, sequences, numbers, algorithms, inferior/superior f-parts, magic squares, palindromes, functional iterations, semantic paradoxes, Non-Euclidean geometries, manifolds, conjectures, open problems, algebraic structures, neutrosophy, neutrosophic logic/set/probability, hypothesis that there is no speed barrier in the universe, quantum paradoxes, etc. have been selected for this volume.

Contributors are from Australia, China, England, Germany, India, Ireland, Israel, Italy, Japan, Malaysia, Morocco, Portugal, Romania, Spain, USA. Most of the papers are in English, a few of them are in Spanish, Portuguese, or German.

The Editors

\$79.95