

Tune in to Digital Convergence

# DVB - SCENE

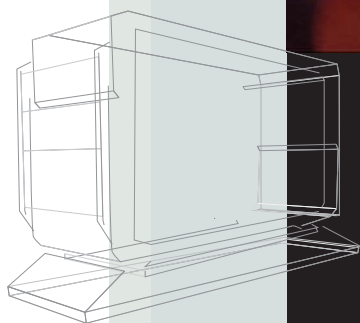

09

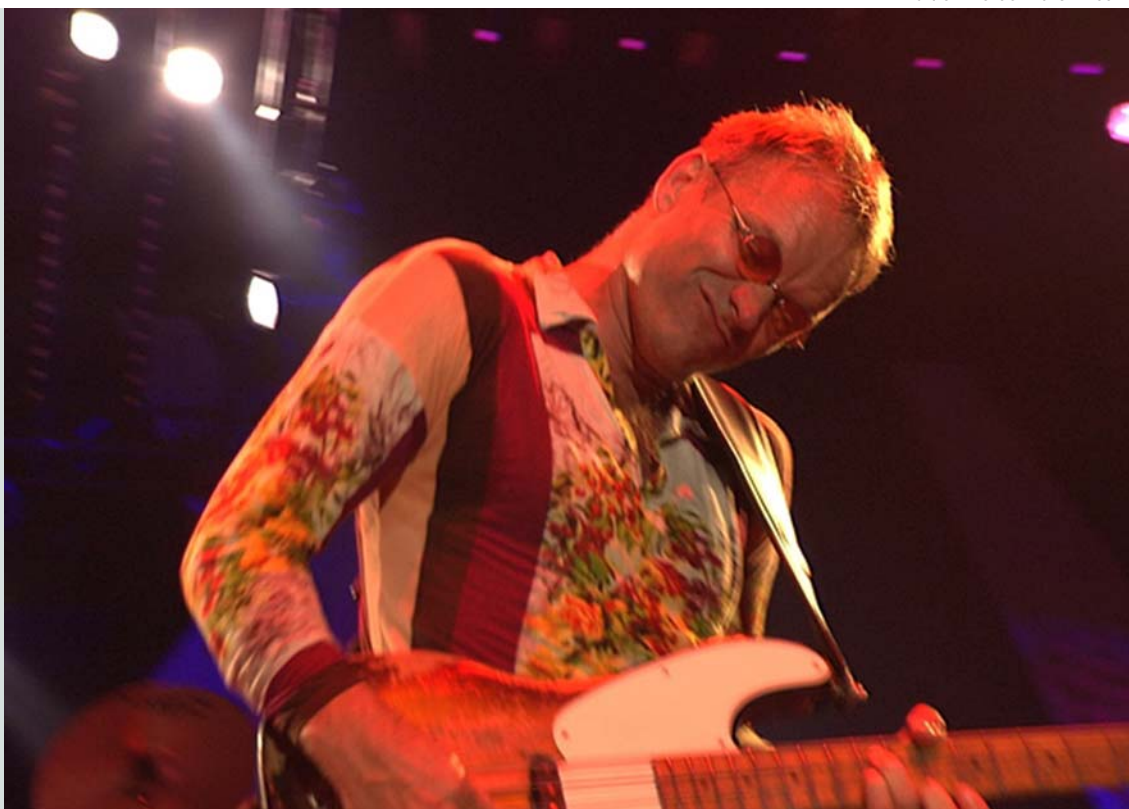

## riding the **HD** wave



# DVB®

The Standard for the Digital World

### This issue's highlights

- > MHP - OCAP - ACAP
- > High Definition TV
- > Birth of a standard - DVB-H
- > MHP in Italy
- > Market Watch

# i-CAN™



ADVANCED DIGITAL BROADCAST



## i-CAN Set Top Boxes: the Global Benchmark for Interactive TV.

- i-CAN MHP: Number One in European deployments.
- i-CAN OCAP: The new big buzz in North America.
- i-CAN Flexibility: Terrestrial, Cable, Satellite and IPTV, dual medium (IP/DVB-T), DVR, iDTV
- i-CAN by Advanced Digital Broadcast: design excellence with proven performance in millions of TV homes around the world.

# DELIVERING MILESTONE SPECIFICATIONS

## A word from the DVB Project Office

2004 is an exciting year already for DVB. During the course of the year, a number of key new specifications will be published, trialed, and perhaps even put into service.

DVB-S2 is the key satellite specification already introduced in DVB-SCENE. Published this year, and already the subject of much commercial interest, it promises to be a worthy successor for DVB-S – which continues to provide the excellent service and affordable receivers to millions of satellite TV viewers worldwide.

Coupled with the latest generation of video and audio codecs, DVB-S2 promises to give a fillip to those wishing to launch new services requiring more sophisticated domestic receiving equipment. HDTV is just such an application. HDTV displays are becoming more and more prevalent in consumers' homes and the broadcast community needs to target these displays if it is to compete with DVD and the new generation HD-DVD.

But Euro1080 are not waiting for DVB-S2 or the availability of the new codecs to launch a HDTV satellite service in Europe. It promises to be an interesting test of the European consumers' willingness to adopt HDTV – a technology more significant in its consequences for the broadcasting industry than in the consumer interest it is generating so far.

There is one potential blot on this rosy landscape – the dreaded IPR. At each

of the DVB's Technical Module meetings, the gathered experts are asked if they see any non-technical barriers to a particular technology being studied in DVB. Consistently over the last year, Technical Module representatives have flagged IPR associated with the implementation of MPEG-4 Part 10/AVC as being a very significant unknown factor which could adversely influence the popularity of this powerful new codec. The DVB has consistently sought clarity from those organisations holding essential IPR in these technologies with a view to making informed decisions. Such clarity has been sadly lacking.

As an industry initiative, DVB is a body formed of organisations who are both potential licensors and licensees of technology. Thus, we must respect the right of organisations to exercise their intellectual property rights on the one hand, while producing specifications which are commercially viable on the other. IPR plays an important part in this latter consideration, and thus DVB worked hard on a balanced IPR policy. DVB is the basis for most successful digital television systems around the world, and maintaining a reasonable IPR policy is essential to safeguarding the future of these systems.

Another interesting development on the DVB front is DVB-H. A series of measures designed to facilitate access to IP based DVB services on handheld devices. Comprising DVB-T's physical layer with a number of service layer



Peter MacAvock, Executive Director

enhancements aimed at improving battery life and reception in the difficult handheld environment, the DVB-H specifications have just been published. As the year goes on, we will cover this important technology in more detail, with reports on the extensive trials being put together.

There is no doubt in DVB circles that DVB-H is a significant development. Never designed to replace DVB-T, it will compliment existing digital terrestrial services, offering operators the possibility to extend their reach to the mobile handset market.

MHP continues to grow from strength to strength as well. With the recent publication of ACAP as a candidate ATSC standard in the US, the conversion of the world's API systems to MHP is completed. Such harmonisation between world standardisation bodies is rare, and hopefully a taste of future cooperation. DVB's main task is to ensure that MHP remains at the forefront of developments in the iTV market, and that any developments are disseminated amongst other standards bodies using MHP as the basis for their middleware.

**The views expressed in this newsletter are those of the individual DVB members or guests and are not necessarily the views of the DVB Project Office or Steering Board.**

Published by the DVB Project Office,  
c/o European Broadcasting Union,  
17a Ancienne Route,  
CH-1218 Grand Saconnex, Switzerland.  
www.dvb.org & www.mhp.org  
Printed by Lithmark Limited.  
Design by GyroGroup.  
Editors: William Daly, Harold Bergin  
Editorial and Advertising enquiries to: WHD PR  
Email: news@whdpr.com  
Telephone: +44 (0)20 7799 3100

All rights reserved. No part of this publication may be reproduced without prior consent of the publisher. All content correct at time of printing. (c) DVB-SCENE 2003. DVB and MHP are registered trademarks of the DVB Project. Certain other product names, brand names and company names may be trademarks or designations of their respective owners.

**Cover:** Euro1080 was launched on 1st January 2004 and is the first channel to broadcast exclusively in high definition throughout Europe. The service offers high-quality content: sports, music, films and cultural events are being broadcast by satellite with best quality surround sound, in HDTV format.

## NEW MEMBERS

- Cox Communications • Belgacom •
- Electronics Co. Ltd • Esmertec AG •
- Shenzhen Coship • Teamcast •
- Telecommunications Institute-University of Aveiro •
- Wishnet Inc. •

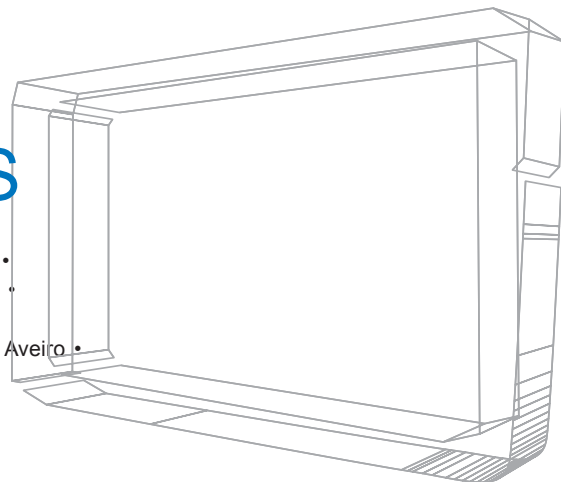



# THE MHP FAMILY TREE

Jon Piesing, Philips Digital Systems Laboratories, Redhill, UK

One of the goals of the MHP specification was to specify receivers well enough that a consumer can buy a receiver and move it between different MHP markets and not have to buy a new receiver for each. This means MHP is not just an 'API' specification; it specifies the interface between the receiver and the network to which it's connected. To achieve this goal, MHP builds on the vast set of previous DVB specifications including those for service information, subtitles, the common interface (conditional access) and data broadcasting.

A consequence of the close relationship between MHP and the previous DVB specifications is that MHP cannot be used in markets where these previous specifications are not used. For example, the US has its own specifications for system information and cable in particular uses proprietary formats for service information. The CableCARD is the US equivalent of DVB's common interface. Closed captions in the US are similar to DVB subtitles but the use case is not quite the same. The specifications defined in ARIB for the Japanese market are different again. There are also other market related differences, e.g. the impact of the difference between 50Hz video vs 60Hz video.

In the US, the original version of OCAP defined its own subset of MHP to remove and replace inappropriate previous DVB specifications. This causes a problem with the DVB project's IPR rules – patent holders are only required to license IPR for 'equipment fully complying with' the DVB specifications. In order to solve this problem, DVB created the 'Globally Executable MHP' (GEM) specification closely aligned to the OCAP subset of MHP. GEM defines a mandatory core of features which are required to be supported on all specifications which build on it (called 'GEM terminal specifications'). It also defines a set of functions where either the MHP original must be used or a replacement must be provided. For example, OCAP and ACAP use the MHP version of the DSMCC object carousel, ARIB use their own data broadcast specification instead.

One important feature of MHP which can be re-used to some extent in GEM terminal specifications is the conformance tests. While some of the MHP conformance tests are specific to previous DVB specifications, (e.g. those relating to access to DVB service information), most of the remainder can be reused with some work. For example, many of the MHP conformance tests are packaged in a form suitable to be used with a small broadcast system for MHP receivers without special testing interfaces. While the test may not need to be changed for a non-MHP specification, the packaging will almost certainly need changing. The industry still has to find a viable model for sharing the costs of creating and reviewing test suites like these between those who use them and those who benefit from them. As a result, GEM terminal specifications do not automatically have the right to reuse the MHP conformance tests since those tests remain the property of their creators and not the DVB project.

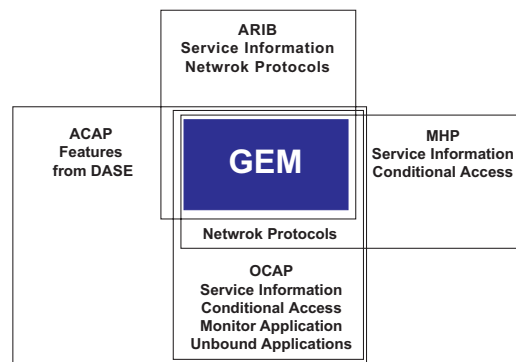

**Jon Piesing is a Senior Technical Consultant at Philips Digital Systems Laboratories, Redhill, UK. He chairs the DVB Technical Module group TAM (Technical Aspects of the MHP). In Philips, he runs the project which between 1999 and 2001 produced the widely used 'Trimedia' prototype MHP receiver.**

DVB-SCENE : 04

## GEARING UP FOR OCAP

**DVB members demonstrate end-to-end options for the US industry.**

The OpenCable project being run by the US cable industry through CableLabs includes two critical technologies derived from work done in the DVB group. The first is the CableCARD device which allows the separation of conditional access functions from a cable receiver distributed through retail channels. This critical enabling technology was first specified in the DVB as the 'Common Interface' for conditional access and has evolved

considerably within the OpenCable project to make the system now being tested for market introduction.

The second key technology is OCAP which is interactive TV technology based on DVB MHP and conformant with the GEM specification. The OCAP specification differs from MHP in a few key areas, in particular with regard to the use of signalling and content data, and in having provision for the cable data channel that runs Out of Band to carry conditional access and service data to a cable receiver continuously, whatever service the receiver is tuned to.

Because of the strong commonality between the MHP and OCAP systems,

applications written for MHP can readily be adapted for OCAP use. Of course applications have also to work in the right screen layout and be adapted to the slightly different environment, but teams of developers working in MHP are now getting together to show how end-to-end solutions can work for OCAP. The DVB booth at NAB will host a group of companies that are collaborating together to provide an end-to-end demonstration of OCAP applications delivery and display.

The demonstration will show at least two major sources of applications being delivered in an OCAP stream to set-tops using Osmosys middleware. The key applications will be Franenhofer's JAME, fed with Superteletext data from Sysmedia's Magneta authoring system and a range of applications run through

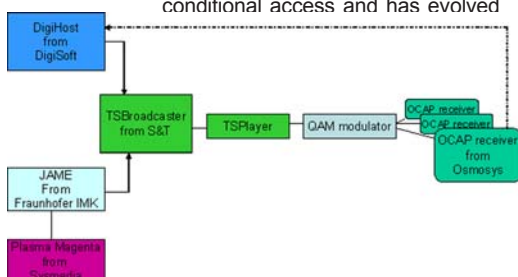



**Craig Smithpeters, iTV Systems Engineer, Cox Communications**

ACAP takes the GEM and OCAP collaboration one step further to bring North American cable system operators and broadcasters together on one platform. Furthermore, the North American satellite operators are also interested in ACAP as a means of establishing a ubiquitous iTV platform.

On a roadmap to being a GEM compliant specification, ACAP is based on the same Java API set and application model found in MHP. ACAP has some differences from MHP, as allowed by GEM's concept of functional equivalents, such as a slightly modified version of the same DSMCC Object Carousel used by MHP, a mandatory return channel, and support for unbound applications from OCAP.

ACAP also adds optional support for a modified subset of the DASE Declarative Application Environment, which is based on HTML and ECMAScript, and is known as ACAP-X. Recent indications suggest that ACAP-X may be harmonised in the future with DVB-HTML and ARIB's BML.

# WHAT IS ACAP?

ACAP has many advantages from being based on rapidly maturing standards such as GEM, MHP, and OCAP. The IPR protections of the nascent GEM and OCAP patent pool are important to potential ACAP implementers and cable system operators. In addition, the value of the current MHP conformance tests can not be underestimated in terms of their technical value and potential impact on ACAP's time to market. This is especially important given ACAP's current lack of a conformance testing regime.

ACAP's history is rather interesting. The ACAP concept started in a series of emails between CableLabs' Dr. Dick Green, ATSC's Mark Richer, and DVB's Dr. Ulrich Reimers concerning the possibility of harmonising OCAP and DASE. The email exchange was very quickly followed up by a meeting of OCAP and DASE experts in June 2002 in Chicago. A framework agreement was reached in the weeks that followed and it provided a roadmap for the technical work that followed over the next 15 months. During that time, a dedicated core group of participants from CableLabs, ATSC, and the DVB held ten separate multi-day meetings. All three organisations contributed significantly to the specification, which was at that time known as 'DCAP'.

In September 2003, the DCAP group had stabilised the specification and was ready to submit it to CableLabs and to the ATSC's Technology Group on Distribution (T3) for consideration. Prior to that meeting, DCAP was renamed to ACAP for aesthetic reasons. At its meeting in September 2003, T3 approved ACAP as an ATSC Candidate Standard (CS/101) and voted to form a new specialist group (T3/S2) to continue the development of ACAP. T3 also submitted ACAP (CS/101) to the SCTE's Cable Applications Platform (CAP) committee for consideration as a possible SCTE standard.

A frequent question from implementers is: How does ACAP impact my current MHP/OCAP plans? The simplest answer is that the impact should be minimal because any compliant ACAP implementation will very likely evolve from compliant OCAP 1.0 and MHP 1.0.x implementations. ACAP is another success story for the DVB's Globally Executable MHP (GEM).

**Craig Smithpeters is part of the iTV Technology group at Cox that developing and deploying advanced services such as OCAP. He is currently the chair of the ATSC's T3/S2 ACAP subcommittee.**

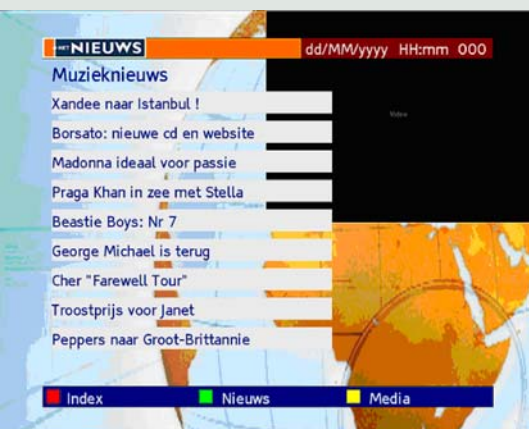

TSBROADCASTER can build carousels of applications and data through integration with a wide range of data sources and can be managed via a browser interface to its inbuilt Webserver, or via a set of Java APIs that allow systems like DigiHost and JAME to drive application loading, data update and the delivery of stream events. The data update facility is particularly powerful, since it can include custom programs to transform incoming data to a format required for broadcast. Data can be delivered via file system update, via http, or through direct extraction from a database.

TSBROADCASTER produces a whole OCAP transport stream, and can also provide the specialised signalling for delivery over the out of band channel in the OpenCable system. It is easily

integrated into both a normal digital head-end, and into the wide variety of data and application sources that are expected to evolve over the coming rollout. The system can also provide interconnection with application signing tools that enable OCAP security.

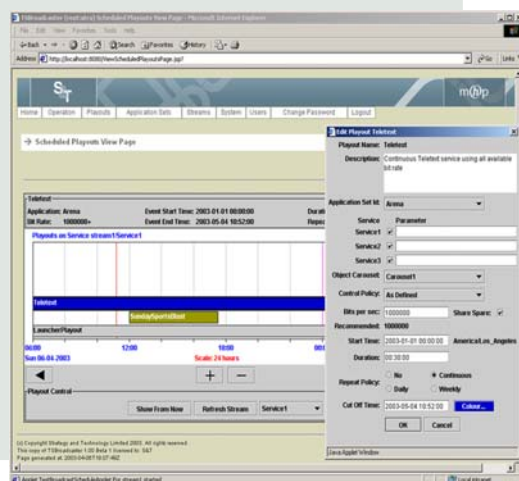

DigiSoft's DigiHost system. Both of these complex systems provide data to the OCAP object carousel provided by Strategy & Technology; this is then played out through a cable modulator into the receivers.



# RIDING THE HD WAVE

**Rob de Vogel, Euro 1080**

Less than a year ago at the announcement of our station Euro1080, initiated by Alfacam, the Belgian market leader in HDTV production, we stated: "We believe that the time has come to start the roll-out of digital high definition television in Europe. For the future, we see a diversification in quality levels for television, with low to medium quality for news and 'on demand content' and high quality delivery for premium entertainment. HDTV is going to be that high quality delivery platform."

From the start, we saw sport, music, special events, stage shows and films as the content that will profit most from a quality delivery platform. From the start we intended not only to target the consumers at home, but also deliver content to cinemas equipped with electronic projection equipment, and use displays at points-of-sale, small theatres, sports bars and other small venues as points-of-promotion.

So there was no lack of good plans and intentions. Addressing the other players that complete the chain however, was initially a sobering experience. Particularly for the European consumer electronic manufacturers still remembering the HDMAC debacle who were interested on an intellectual level, but not wanting to commit to realisation. There was a common understanding that 'no one will deliver HD set-top boxes for Europe'. The major

European broadcasters shared the same opinion.

There were, however, supportive players in other parts of the chain. NHK provided us with content, public support for the concept and behind-the-scenes promotion and at IBC'03 with a live HD feed from the Antarctic, a pretty unique present. Also from very early on, SES ASTRA, a strong promoter of HD, has provided us with technical support, transmission time for demos and tests, playout and uplink capacity and we are now on satellite 24/7 on ASTRA 1H. Without their contributions we would not be on air now.

Despite the initially gloomy predictions of the European consumer electronics manufacturers when we met with STB manufacturers a few of them believed in the channel and started developing HD STBs. Honour to whom deserves honour. During IBC'2003, Zinwell of Taiwan hand carried the first box to our stand, we pointed a consumer dish to ASTRA 1H and had our beautiful content before our eyes within a few minutes. Without prior integration testing we had completed a chain with Belgian produced HD content, a Norwegian encoder, a Dutch mux in a Luxembourg uplink site, an unidentified consumer satellite dish, a Taiwanese STB and a Japanese plasma screen, and it all worked – first time. It certainly showed that the DVB standards setting worked!



One of our first decisions, of course, had been to choose a technology standard for Euro1080. DVB-HD was an obvious first consideration, but we also looked into H.261 (or whatever is the permutation of its identity) and Windows Media 9. For very practical reasons we selected DVB-HD as it is now. Availability of real-time HD production and transmission



equipment is not a detail when you start a station, and we selected 1080i. We realise that at some point in time we will see an upgrade in production and transmission standards – one should not overlook the subtlety that our station is called Euro1080 and not Euro1080i.

We think that the recent past has shown that faith in HD for Europe is growing fast. There is no choice of course, as Europe simply can not remain an HD island - the HD wave is coming, also for Europe. And it is irreversible.

**Before joining Alfacam Rob de Vogel was a general manager of Philips Broadcast and a vice-president of Thomson Grass Valley.**



# HDTV IN EUROPE: THE NEXT STEP IN TV EVOLUTION

A new era for television broadcasting has begun with the launch of Europe's first high definition television channel. Belgian HD specialist Alfacam joined forces with SES ASTRA to start its HDTV service Euro1080 on 1 January 2004, transmitting an attractive supply of



HDTV content to audiences across Europe via ASTRA's prime orbital position of 19.2° East.

The channel, Euro1080, is broadcasting exclusively in high definition and provides the European TV and entertainment industry with a showcase for the spectacular advantages of HDTV. Transmission via ASTRA satellite enables a wide and cost effective distribution of the material to ensure this pioneering service reaches a very large audience. Satellite is an ideal medium for HDTV broadcast because it can easily cater for the extra bandwidth requirements of the enhanced service. No doubt, the benefits of HDTV – sharper, cleaner images with more subtle colours plus best quality surround sound – have to be seen and heard to be believed. By bringing this new viewing experience to the European public, ASTRA and Euro1080 are convinced they will boost HDTV awareness and thus open up the market to a range of new exciting business opportunities for broadcasters.

A considerable catalogue of HDTV content has been built up over the last few years and Euro1080 will be showing a blend of high quality programming of music, sport, cultural events and documentaries. Some of the channel's content will be top entertainment from countries such as the US, Korea, Australia and Japan

where HDTV already enjoys a growing popularity.

Euro1080 comprises two distinct channels: The Main Channel is free-to-view (no subscription required but a one off administration fee) and broadcasts 24/7. From midnight to noon a HD demo loop is shown and from noon to midnight the channel offers three blocks of four hours of original programming. Every day a new four hour block is introduced. The prime target audience for this channel is broadcasters and retailers who have up to now been unable to show potential customers the benefits of HDTV. Euro1080 also expects that HDTV awareness will be increasing as soon as its programming is picked up for viewing in public venues such as bars, conference centres and airports. A second channel, The Event Channel, broadcasts live or recorded

**“In order to better enjoy the benefits of a flat panel display, viewers are asking for DVD like viewing experiences when watching broadcast TV”**

special features to 'event cinemas', which are equipped with electronic projection. Featured events can be live music, such as rock concerts or opera, or popular sporting events such as major football matches or the Olympic Games. Venues for 10,000 people or more can be used and Euro1080 boasts that the high quality of the sound and vision is as good as being present at the live event.

The launch of Euro1080 follows a series of successful trials. Alfacam and ASTRA cooperated in June last year to transmit HDTV coverage of the Denmark vs. Norway European Championship football match to a number of e-cinemas in Copenhagen and Bergen and later the two companies ran public demonstrations at IBC 2003 in Amsterdam. The level of industry and public interest resulting from these demonstrations assured ASTRA and Euro1080 that the time was right to bring HDTV further into the mainstream.

Increased interest in HDTV can be partly attributed to the growing popularity of home cinemas and flat panel displays. Analysts expect the price of flat panel TVs (LCD and plasma) to come down significantly

over the next few years. “In order to better enjoy the benefits of a flat panel display, viewers are asking for DVD like viewing experiences when watching broadcast TV,” said Ferdinand Kayser, President and CEO of SES ASTRA. He described the company's cooperation with Alfacam as a “first foray into a new exciting TV viewing experience that is poised to be the next TV evolution”. His message was echoed by Gabriel Fehervari, General Manager of Alfacam and CEO of Euro1080 who added that satellite was an ideal means of broadcasting HDTV.

Euro1080 is broadcast from Alfacam's Media Center in Lint, Belgium. The company undertook extensive research and development before opting for a 1080i format (1920 pixels x 1080 lines at 50Hz interlaced format). The signal may be received by ASTRA DTH

viewers via a 60 cm antenna and a HDTV compatible set-top box. Several well known set-top box manufacturers have announced that they will introduce a compatible set-top box in the coming months.

Now that Europe's first HDTV broadcasts are on air, the time has come to get ready for the HDTV revolution.

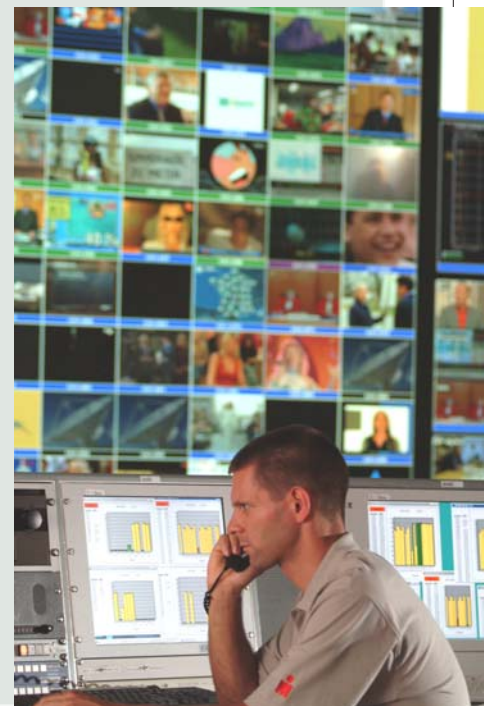



# BIRTH OF A STANDARD

**Dr.-Ing. Manfred Kühn, Head of Broadcast Networks and Services, T-Systems International GmbH Media & Broadcast**



The European DVB-T standard (EN 300 744) is a worldwide accepted system. The range of its application is from HDTV up to mobile reception. Mobile reception is a particular key feature because DVB-T is also used as a distribution system for new mobile multimedia services. To optimise DVB-T for such new applications two items had to be modified.

Interoperability to mobile phone systems is necessary for interactive services. This leads to IP based data services. Therefore, DVB-H is defined as a system where the information is transmitted as IP datagrams.

'Time Slicing' was the great idea to reduce power consumption for the small handheld terminals. This means that IP datagrams are transmitted like data bursts in small time slots. The front end of the receiver has to switch on only for this time interval when the data burst of selected service is on air. Within this short period of time a high data rate is received and can be stored in a buffer. This buffer can either store the downloaded applications or playout live streams continuously where the outgoing data rate depends on the application. The achievable power saving depends on the relation of the on/off time. If there are

approximately ten or more bursted services in a DVB-H stream the rate of power saving for the front end could be around 90%.

In January 2004, Jukka Hendriksson, the chairman of the DVB-H group, was able to present the results to the Technical Module.

## PILOTS STEER THE COURSE TO MOBILE PHONE TV

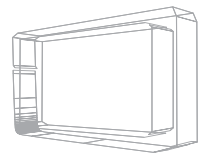

**Pekka Talmola, Senior R&D Group Manager, Nokia Ventures Organisation**



The DVB is in the final stages of establishing the new DVB-H standard, which is designed to bring broadcast services to users of hand held devices like mobile phones. To achieve this scenario in two to five years, the industry must finalise additional required standards as well as create the networks, the mobile handsets and the compelling content that will come together to make mobile phone TV a reality.

Technical trials and pilot projects are two important elements in this process. They are aimed at speeding up the verification process for the standards and at testing the technical

feasibility of various network equipment and terminals. More importantly, because of these pilots and trials, valuable experience is gained regarding how the end users are adopting the new services and how they are consuming them. The pilots also play a role in the ongoing spectrum planning process by demonstrating the importance of hand held reception for the Regional Radio Conference (RRC-04/06).

For some time, Nokia has been very active in supporting and creating DVB-H based IP Datacasting (IPDC) pilots in various countries. To demonstrate that fact, Nokia was the first to show a DVB-H receiver in a mobile phone, the Nokia SU-6 Streamer in the Nokia 7700 media device. This will be used in pilot projects to showcase the future of digital broadcasting in mobile devices but will not be a commercial product. Nokia has also made available the first IP Encapsulators supporting time slicing which is a key element in DVB-H.

Finnish broadcast, content and mobile communications companies, including Nokia, have come together to implement a pilot that will test a commercial broadcast service for mobile devices. The aim of the pilot is to gain information about real end user acceptance for mobile broadcasting services. 500 end users will be recruited from within the Helsinki metropolitan area to gather statistically meaningful results.

The pilot will also support ongoing standardisation work and further clarify the regulative and spectrum issues for the planned fourth digital television multiplex in Finland. It will also act as a validation of a functional end-to-end solution for the mobile broadcasting services platform. The fourth Finnish digital broadcast network will be reserved for mobile datacasting, based on the DVB-H standard.

The pilot's business scenario will see mobile phone operators TeliSonera Finland and Radiolinja providing access to the protected TV like services to the end users. Broadcast content providers MTV3, Nelonen and YLE will produce the available content. Digita, the Finnish broadcast network operator, will operate the IPDC service system and network. Nokia will provide the IPDC specific equipment, such as the terminals. A





All functionalities of this 'Transmission System for Handheld Terminals' (DVB-H) are described in a new normative document. This also contains all the references to other documents extended or modified for this purpose.

Most of DVB-H features are in relation to the transport layers. That's why DVB-DATA (EN 301 192) has been extended by the definition of time slicing and its use in the MPE section. The optional error correction MPE-FEC is also described there. Further extended definitions which describe specific elements for the terrestrial transmission have been described in DVB-SI (EN 300 468).

It was good luck that the DVB-T standard (EN 300 744) could be kept as the physical layer for DVB-H with only a slight modification concerning the use of TPS-Bits for signalling. Further elements like 4K-Mode, in depth interleavers for 2K

and 4K as well as 5 MHz bandwidth are optional. All these have been described in an annex to EN 300 744. A further modification was drafted for the DVB-SFN (TS 101 191)

The new features of the DVB-T annex might be used for dedicated DVB-H networks. But, it is also possible to adopt the backward compatible features to DVB-T networks as used currently. Because of this, it is also possible to share the transmission capacity for both TV broadcasts and IP based data services for the handheld terminals.

The further work of the DVB-H group is related to the validation of the DVB-H specification. Laboratory tests and field trials are planned to take place around Europe. Pilot projects are underway in Finland, Germany and Spain.

Also TSI Media & Broadcast has started there own activities. There is a pilot project for DVB-H in preparation in

Berlin. Coverage aspects, QoS and usability aspects will be investigated under real service conditions.

## DVB<sup>®</sup> H HANDHELD

**Dr.-Ing. Manfred Kühn studied RF and information technology in Berlin and Dresden. He was involved in the DVB-T standardisation and system validation as a project manager in several European projects. As a head of Broadcast Networks and Services he is responsible for the technical development of terrestrial broadcast platforms and services within T-Systems International. He is a member of the DVB Technical Module.**

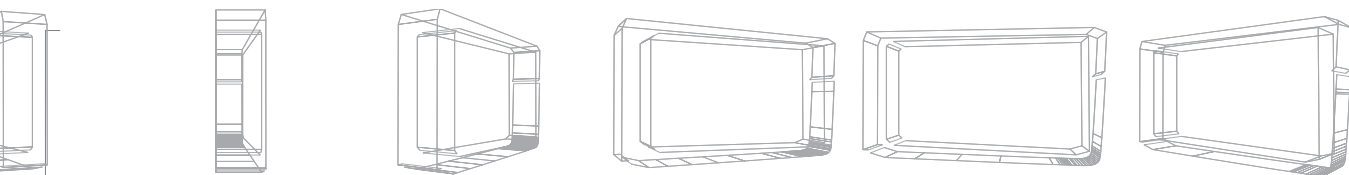

new single frequency network supporting hand held reception indoors will be built for the pilot area.

The Finnish commercial DVB-H pilot is an outgrowth of a previous IPDC technical trial network built in Helsinki by RTT, a Finnish research firm that focuses on radio and television technology. The RTT Test Network was created prior to the start of DVB-H and employed IP over DVB-T technology and was not intended directly for hand held reception. However, it has been a useful tool in the development of DVB-H. During the DVB-H meeting held in Helsinki in December 2003, the network was used to transmit a live time sliced DVB-T (DVB-H) signal, which was received on site by the Nokia Streamer attached to the Nokia 7700. This was likely the first case of an over the air DVB-H transmission received with DVB-H terminals.

The Broadcast Mobile Convergence (bmco) project has been established in Berlin by Nokia, Philips, Vodafone Pilotentwicklung and Universal Studios Networks Germany. The target of the project is to explore the new market and opportunities created by the convergence of the broadcast and mobile worlds. Berlin is an excellent place for a pilot project as it is the first city in Germany to convert fully to digital terrestrial television broadcasts using DVB-T and therefore provides the technological base for the project. There it will be possible to test how sharing of the same multiplex with traditional MPEG-2 TV services and DVB-H services works in practice. The first tests looking into how DVB-H streams survive multiplexers in the DVB-T network and how DVB-H affects the DVB-T transmissions have been performed successfully by bmco and T-Systems, the broadcast network operator in Berlin. Initial compatibility tests between DVB-H and the existing DVB-T receivers on the market have also gone well. In the bmco project, Nokia will focus on the one way broadcast of TV like content to non-commercial mobile phones designed for the pilot.

Pilots will play an extremely important role in the introduction of DVB-H to the market. Plans are for further pilots to begin in Europe in 2004. Once the pilot

phase is complete, it is expected that countries that have adopted DVB-H will see the introduction of commercial services complementing the emerging technology available within two to five years.

**Pekka Talmola is a Senior R&D Group Manager in Nokia Ventures Organisation. Mr. Talmola joined Nokia in 1985 and has been working with TV and digital TV systems. Since 1996 he has concentrated on mobile DVB-T technology and is currently working with several standards activities like DVB-H, DVB-UMTS, EICTA, CEPT and ITU.**



# CONTRACTS

Advanced Digital Broadcast (ADB), supplier of digital TV set-top boxes and software solutions for interactive television, has announced that it has signed an agreement with Auna in Spain to provide an additional 100,000 cable digital set-top boxes during 2004 and 2005.

Since November 2002, when ADB and Auna signed their initial supply agreement, ADB has delivered over 140,000 cable set-top boxes to Auna.

ADB will maintain deliveries to Auna of the current digital cable set-top box, the ABQ-1H4G. Later this year, ADB plans to introduce a new compact set-top box enhancing all the current features and based on ST Microelectronics' 5100 chip set.

ADB and Auna have also agreed that a significant percentage of the set-top boxes supplied by the manufacturer to the cable operator will be built in Italtel's factory in As Pontes (La Coruña, Spain).



**ADB STB for Auna**

## Thales Coral iTV Broadcasting Server



Danish Broadcast Corporation, the national public broadcaster in Denmark, has selected Thales' end-to-end open interface interactive television service platform to broadcast interactive TV using MHP. Thales will also provide the equipment's installation and training.

The company was also selected by Elettronica Industriale as one of the relevant equipment suppliers for the implementation and deployment of DVB-T services in

Italy. Elettronica Industriale, a subsidiary of Mediaset, manages the distribution of the signal for Canale 5, Italia 1 and Retequattro terrestrial networks.

The solution provided by Thales includes: Amber Stream Processors and Remultiplexer to manage digital stream contents for all regional head-ends; Jade EPG Server and Coral iTV Broadcasting Server for trial purposes to handle DVB signalling and interactivity; and Amethyst Smart Switchers for system security.

Coral simultaneously manages OCAP, MHP, OpenTV, MediaHighway or Simulcrypt interactive applications. Thales feels OCAP provides a unique opportunity to work with interactive television in an open environment, and want to be ready for iTV launching in the US, where the increasing interest for OCAP products is a promising trend.

DVB-SCENE : 10



Gilat Satellite Networks has announced that it has signed an agreement with the Mexican telecommunications company, Telecomunicaciones de Mexico, for its Telecomm Telegrafos service. The agreement calls for the deployment of a SkyStar 360E hub and up to 2,000 remote sites.

The SkyStar 360E platform offers a flexible, two-way, satellite based solution enabling interactive broadband IP and multicasting applications. With DVB standards and extensive IP capabilities, the SkyStar 360E supports virtually any data and IP multicast application.

## Gilat Skystar 360E platform

Viaccess is providing control and rights management with its VOD solution to secure the content distribution for the recently launched digital TV services for the multichannel provider TPS on the France Telecom ADSL network. Just as the Viaccess conditional access system safeguards digital linear programme and pay-per-view services, Viaccess-VOD protects on-demand services for delivery on cable and DSL networks.

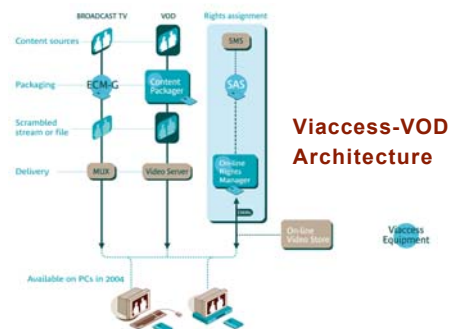

# SET FOR ITALY

Italy is setting an example for other countries on how to develop the digital TV market. This is emphasised by the country's provisional parliamentary approval of full switchover to digital by 2007. Following success in the UK, Italy's usage of STBs is built on a free-to-air environment, representing the interest of the majority of households. Italy is strongly focusing on the key aspects

for creating success. It started by laying the foundation through a single and common digital TV standard, namely MHP. This has given both broadcasters and CE manufacturers clarity. Clarity in terms of building a kind of guarantee with respect to the investments needed to be made in order to create the necessary content and hardware. And this creates certainty for the consumer that it will

happen. The government is further encouraging consumers to switch to digital by providing a financial subsidy per household that enables them to switch to digital & interactive services (MHP). Paul Geurten, Senior Business Manager, Digital Video Set-Top Boxes, Retail, at Philips Consumer Electronics, says: "We are confident that, in the course of 2004, Italy will be the fastest growing digital TV market in Europe."



# MHP IN ITALY

**Erik Lambert**

On February 3rd, in the magnificent surroundings of the Villa Medici, the assembled journalists could for the first time watch the 23 digital terrestrial channels already available in Rome. As the minister of communication salutes the birth of DGTVi, the association of DTTV network operators, one cannot help feel that this marks the beginning of the digital switchover.

The first commercial use of DVB-T in Italy was initiated by the pay-TV operator Tele+ in the small city of Sant'Agata de' Goti, near Naples, where 150 subscribers were converted from analogue terrestrial to digital terrestrial in July 1999.

Interactive television is seen as a major opportunity to introduce e-services into the home, particularly into the homes of the computer shy. After all, television has nearly 100% penetration, more than fixed line telephony which is under 90%.

As was recently explained by the coordinator of the digital project of Mediaset, with its three networks, the broadcaster generates 33 billion viewer hours of audience every year. If each digital viewer hour were able to provide only 1 eurocent of extra revenue, this could represent for the company over 300 million euros in additional income. These numbers justify substantial investment over time in the new technology and especially in interactive applications and services.



RAI, as a public service broadcaster not only has the development of digital in its service contract, but is also keen to develop its 'savoir-faire' in a technology for which it has done so much and to enhance the presence of public broadcasting in the digital arena, continuing the movement initiated through its digital satellite channels and the provision of content for broadband networks.

The third national Italian broadcaster, TV International, is a subsidiary of the Telecom Italia group. With its two targeted networks (La7 and MTV Italy) it has a much smaller share of audience than Mediaset or RAI. However, not only would it be difficult for TV International to remain outside this major shift in the Italian broadcasting landscape, but also the new opportunities offered by the separation of content and network activities in the digital world have not escaped Telecom Italia: its core business is to be a network operator.

For all players, interactivity plays a major role. The selection of an interactive system, a common API, becomes of crucial importance. The choice is not necessarily easy. Interactivity with the use of a return channel is fundamental for governmental services and the business model envisioned by Mediaset.

There are several good and tried solutions on the market, but they are proprietary. Choosing one over the other could be misinterpreted. DVB-MHP becomes the obvious candidate. It offers all the necessary features and has the advantage of being a fully open standard, which is important for the public service broadcaster.

Tests and experiments of digital transmissions, interactive services and set-top boxes were carried out. These experimentations were initiated in 2003 and were supported through specific state grants for the set top boxes.

RAI, through its research centre in Turin, the CRIT, had already developed several applications in MHP. Mediaset started as early as mid 2002 to prepare and test a large number of applications linked to its main programmes. A large scale test on 2,000 families was initiated at Varese in October 2003. And Telecom Italia, at the end of 2003 started deploying interactive terminals among 4,000 families, with the objective of also testing new return channels, such as GPRS and ADSL. At the same time as the experimentations were being planned, the broadcasters were busy putting together their national digital networks.

At the Villa Medici, maybe not all present realised the quantity of work that had been done in the last months. Only two MHP applications were on air that day, but in the coming weeks tens will be deployed, building on what has been learned in the experiments.

In a few weeks, sitting back in their chair, viewers will be able through



their remote to interact with their favourite programmes, select the songs of the Sanremo Festival, ask questions on football during the Processo di Biscardi, choose the winner of the Grande Fratello, or order a certificate from their doctor. Italy will then firmly be on the way to analogue switch off.



**Erik Lambert is an advisor to Telecom Italia SpA for their digital terrestrial television project. He has been active in the DVB since its beginning, and presently chairs the Ad Hoc Group on Rules and Procedures.**



# TRUSTING THE INSTINCT

Thomas Owens, Brunel University London & Christoph Dosch, IRT Munich

INSTINCT is a European project in line with the objectives of the newly established DVB-CBMS (Convergence of Broadcast and Mobile Services) activities. The project is committed to specifying a platform for the commercial provision of convergent services in mobility with a special focus on the DVB-T, DVB-H and DVB-MHP standards in conjunction with the concept of wireless communications networks (notably GPRS and UMTS) combined with terrestrial DVB broadcast networks. INSTINCT aims to a carrier grade fully specified and open final platform for the delivery of convergent services in collaborating wireless communications and terrestrial broadcast networks.

INSTINCT is planned in three phases. Phase 1 is the development phase for the platform. Phase 2 will apply that technology, possibly in the context of medium scale field trials and Phase 3 will involve real large scale field trials and involve more operators and local communities.

The first two-year phase of INSTINCT started on 1 January 2004 with 9.6 million euros of funding by the European Commission in the Framework Programme 6. Over the six years of the project it is anticipated that over 50,000,000 euros will be invested in the development of the open platform and the provision of convergent services on the platform.

INSTINCT targets the following groups of mobile users: young urban customers, corporate users, and the general public on the move, walking in a mall or sitting at lunch, in cars and public transport or transiting through any public areas, in which context the INSTINCT concept may allow additional login into public WLANs.

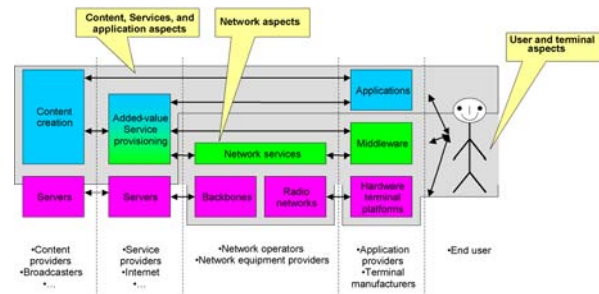

INSTINCT reference system model

For the end user, the INSTINCT concept will provide cheap and easy to use services on a handheld terminal. Mobile Information Device Profile (MIDP) is a Java API that provides the core application functionality required by mobile applications. INSTINCT will trial the use of this API — how it can be used and interact with MHP to develop application software for converged DVB broadcast and UMTS telecommunication services. And, more specifically how thin client devices such as smart phones can use this API to receive a subset of a full set of a DVB service.

INSTINCT is a consortium of twenty-four partners, including fourteen industrial partners, six universities and four research institutions. Brunel University is the coordinator of the project. The INSTINCT consortium includes five Brazilian partners. The Brazilian involvement in INSTINCT enables Brazil to enter a phase of active cooperation and transfer of knowledge in view of a growing awareness of DVB technologies in Brazil and develop general and specific partnerships for the next generation of technologies and standards.

The window of opportunity for services combining terrestrial DVB and cellular is from now to maybe 2010. It is the view of the consortium that the INSTINCT system could be developed and potentially operational by, say, end of 2005 enabling interactive services on terrestrial DVB and cellular telecom networks.

INSTINCT builds on a number of strategic EC Framework Programme 5 projects, notably, CISMUNDUS, CONFLUENT, Multimedia Car Platform, SAMBITS and SAVANT.

For a full list of partners and further information contact Dr. T. J. Owens. Email: thomas.owens@brunel.ac.uk.

# CHOOSING MHP FOR CABLE

Belgium's Telenet is a key player in the 'Vlaanderen Interactief' project in Flanders, playing a pivotal role in a partnership comprised of Interkabel, Telenet, VMMA, VRT and VT4. Working in harmony with the Flemish e-government project 'Vlaanderen Interactief', Telenet is destined to deliver the first cable TV based network in Europe using DVB-MHP. An extensive trial project has been underway since November 2003.

Sony has provided a comprehensive platform for delivery of interactive digital television services to Telenet. The Sony system provides for all aspects of the interactive digital television service including content authoring, scheduling, service management and playout. The solution at Telenet has been realised following close technical cooperation between Sony and Tandberg Television.

"Interactivity is crucial to the success of our digital TV service" said Jan Vorstermans, Senior Vice President Network & Customer Operations at Telenet. "Our decision in favour of MHP reflects the company's commitment towards open standards."

Commenting for Sony, Allan Arthurs, General Manager: DataCast said

"While we have considerable experience in this field to draw on, the system at Telenet has been without doubt the most demanding to date. Telenet is the first to implement a system of providing precise synchronisation between the interactive digital television service and the associated audio/video programme."

"We demanded a highly automated approach, one that would be capable of delivering a variety of highly compelling interactive applications which would differentiate our service" said Peter Van de Poel, Manager DTV Services Engineering at Telenet. "Sony was chosen based on their commitment in terms of MHP and the success of our earlier technical trial" he added.

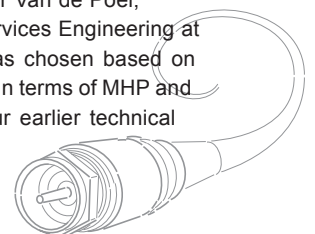





# SPOTLIGHT

**Harris Broadcast Europe's MD David Crawford tells DVB-SCENE about the increasing volume of activity the company is experiencing worldwide for DVB-T implementation.**

**What is happening for Harris in the worldwide DVB-T market and how is the company responding?**

Stimulated by the success of the Freeview digital TV platform in the UK and the renewed market confidence in the technology sector, DVB-T markets worldwide have taken a sharp rise in activity and intensity. Harris is at the forefront of this activity and has extended its DVB-T portfolio to include high quality encoders and SFN adapters, transmission equipment covering a broad range of requirements and global network management systems.

**What was most significant development in the last year?**

During the last year Harris has seen a significant rise in the number of

orders for DVB-T transmitters and has been involved in some extensive special developments and tests. For example: Harris has supplied 24 'Spot' Digital TV repeater transmitters plus four Atlas DTV 660's to Føroya Tele (Faroese Telecom) for the Faroe Islands.

**Do you think the growth of DVB is dependent on technical or purely commercial grounds?**

A big advantage of DVB is that it stimulates and leads the market on both technical and commercial grounds. The sophistication and stability of the standards and the worldwide development of compatible equipment for all the delivery platforms gives DVB this advantage. These facts give leading developers like Harris the confidence to invest in extensive R&D to solve the technical challenges and to produce reliable products based on these standards.

**Is the pay satellite market now saturated commercially, do viewers now want free to air choice?**

The pay-TV satellite platform is a commercially successful service that nears saturation in some regions, but appears still to hold its position in the market against free-to-air. However, as terrestrial analogue TV channels

become available in the future for datacasting and additional digital TV services, the existing satellite services will suffer stronger competition. Future free-to-air packages offered by terrestrial broadcasting consortia will contain some exciting new applications, including interactivity and local content via cooperation with mobile telecomms networks (like 3rd generation UMTS). Harris is looking forward to being a leading equipment developer in this new area.

Harris now offers a broad range of DVB-T transmission equipment, including the SPOT-T, a compact, low cost, low power DVB-T transmitter, which meets the operators' requirements in terms of DVB-T coverage improvement. It integrates advanced features such as bit rate adaptation, PCR re-stamping, NIT update, SFN operation with its internal GPS receiver, and control through the MIP channel. Also, on offer is the head-end adapter Synchrony with 2K and 8K non-hierarchical and hierarchical modes, a user selectable channel bandwidth 6Mhz, 7Mhz and 8Mhz and internal and integrated GPS receiver. The purpose of Synchrony is to prepare the MPEG transport stream at the output of the DVB-T multiplexer to be transmitted by DVB-T transmitters in single frequency network conditions.

## ACCESS FOR ALL

Digital Switchover: Developing infrastructures for broadband access (ATHENA) is a recently signed thirty month research contract between the European Commission and a European consortium of twelve partners. The project will develop a broadband infrastructure using regenerative DVB-T stream technology that interconnects distribution nodes and enables broadband access to multi-services (i.e. interactive multimedia services, Internet, email, digital TV programmes). The realisation of such a broadband access neutral infrastructure that can be commonly exploited by broadcasters, telecom operators and service providers, will enable all citizens to actively participate in the Information Society (active users/citizens, potential/implicit content providers).

This active participation of the critical mass of potential content/application providers (stemming from traditional users) in the market, is the key to generate revenue, gear up rich activity in the market chain and spearhead progress in both the broadcasting and telecommunication sectors, as well as attracting new consumers.

ATHENA will look into the digital switchover to address the issue of broadband access for all to alleviate the digital divide. It will pave the way for key European researchers to propose cost effective broadband infrastructure in cities and rural areas based on DVB T technology and take advantage of the eminent transition towards digital broadcasting in UHF.

The consortium partners of ATHENA are: NCSR Demokritos Project Coordinator (Greece), Space Engineering (Italy), Thales Broadcast and Multimedia (France), Rhode & Schwarz (Germany), Centre for

Technological Research of Crete (Greece), Telscom (Switzerland), Rundfunk Berlin-Brandenburg (Germany), T-Systems Nova (Germany), University Politehnica Bucharest (Romania), PRISM-CNRS (France), Temagon (Greece), and University of Bournemouth (U.K). More information can be obtained through the project website: [www.ist-athena.org](http://www.ist-athena.org).

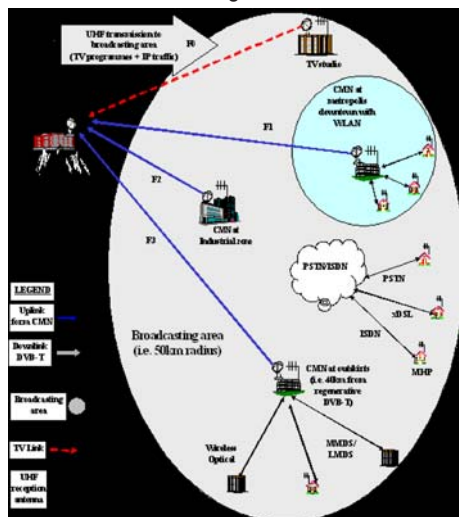

# MARKET WATCH

**EchoStar** has launched a new product line of fixed satellite receivers. The new receivers offer: a multilingual user interface; 14 day EPG; 7 timers; DISEqC 1.2 - GOTO X; 4,400 digital channels, 80 satellites, and 1,500 transponders; multiple favorite channel lists and channel sorting feature; multiple search modes; S/PDIF digital audio output (Dolby digital compatible); and software update via Internet/Satellite capability.

The company believes the key success factors of this new receiver line are the attractive look and the friendly user interface. Also, the receivers feature preprogrammed channel lists which are appreciated by the end user.

## EchoStar DSB 1220 FTA



**Snell & Wilcox** is introducing seventeen new DVB compliant products to its IQ Modular line including converters, synchronizers, distribution amplifiers, routers and audio modules — all capable of operating in either standard definition or high definition resolutions. The company will also introduce HDTV converters and audio processing modules for the SD environment.

Also new from the company is Utility Ingest, a turnkey system that offers broadcast and post production professionals the latest advances in compression and metadata technologies. Utility Ingest's extensive feature includes advanced video/audio compression for improved picture quality and bandwidth management, and interoperability with storage/asset management systems through the exchange of MXF, AAF and XML files.

## Snell & Wilcox IQ Modular Line



## Pixelmetrix DVScope

New from **Pixelmetrix** the DVScope, is a HD/SD SDI waveform and vector generation, display and analysis tool that boasts a unique error log/profile capability for automatic verification. Supporting all SD and HD serial digital video formats, DVScope provides all the functions of an advanced SDI test and monitoring system.

Also new is the DVScope Quality Auditor, combining testing, measurement, monitoring and reporting of both SDI baseband parameters and picture quality into a single product.

DVStor is another new product line from Pixelmetrix for MPEG-TS (Transport Stream) recording and playback. The 1 Terabyte capacity allows customers to keep almost three days of MPEG-TS data at a 50 Mbps data rate.

The new DVShift provides real time, user controllable delay of MPEG transport streams. Ideal for programme turnaround and delayed rebroadcast between national or international time zones.

## Tandberg nCompass Monitoring

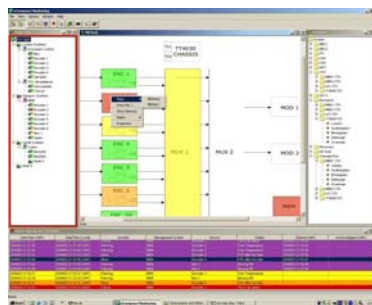

**Tandberg Television** has launched nCompass 3.0, its most advanced network monitoring system developed exclusively for the broadcast and video distribution market. The principal new feature of nCompass 3.0 is that it monitors the health of individual units by monitoring the health of the actual MPEG services across the entire video network. nCompass is an integrated cross platform system that features both control and monitoring and enables broadcasters and operators to manage content delivery networks.

**Loewe's** new mid price Nemos product line is characterised by its attractive product design offering a 16:9 widescreen to the classic 4:3 format with flat screens that have 100-Hz technology for flicker and distortion free images. The Nemos 32 television is now available in Germany with a fully integrated DVB-T receiver.



## Loewe Nemos 32

**ProTelevision** has released a DVB-H firmware update for its popular PT5780 DVB-T modulator. The company has addressed the issue of power conservation in the mobile handset by utilising a time division multiplexing scheme so that the receiver will receive data in bursts. This enables the handset to shut down the receiver in between bursts thereby minimising power consumption and preserving battery life.

**Thomson** has released its first digital terrestrial HDTV receiver, the DTI 1500 HD for the Australian market. This new receiver enables consumers to receive all the latest free channels benefiting from vastly improved high definition picture and sound quality. It can be connected to all types of displays from existing ones to new flat HDTVs. The receiver features automatic tuning and channel set up for easy access to digital HDTV, an EPG for on-screen display of programme information and multiple video display and format compatibility. The receiver is sold through Thomson's Australian distributor.

## Thomson HDTV Receiver







**SCM's DVB-T Receiver**

**Scopus** is introducing its new DVB compliant CODICO E-1800 high definition encoder. The encoder provides multi-format 1080i, 720p, and 480p support, with 4:2:2/4:2:0 encoding up to 45 Mbps.

Also new is CODICO E-9000 UniversalEncoderT - next generation encoding platform. The UniversalEncoder resolves the need for an encoding platform for each broadcast format by serving as a universal platform for MPEG-4, Windows Media 9 (WM9), SD, and HD encoding formats. The UniversalEncoder provides broadcasters with a migration path from MPEG-2 to new compression algorithms such as the standard and high definition MPEG-4 Part 10 (H.264) and WM9 formats.

A new edition of its Integrated Receiver Decoder (IRD) product line with the CODICO IRD-2900 is also being launched. The IRD-2900 will decode up to two video programmes in the transport stream.

SCM Microsystems' new mobile terrestrial receiver enables full mobile reception of digital multimedia content and services based on the DVB transmission protocol. Using SCM's receiver, end users will be in a position to watch digital free-to-air television on their laptops and other portable devices, as well as access digital services like travel information, local news or streamed video enabled by third party service providers – anywhere, at any time.

**Tektronix AD953A MPEG Test System**



**Tektronix** brings portability and increased performance to its MPEG-2 test systems with a high performance processor that greatly increases analysis speeds. The new Tektronix AD953A MPEG Test System includes an integrated high-resolution display, making it easy and convenient to move the test system from lab to lab or offsite for commissioning tests. The AD953A provides play and record capability as well as both real and deferred time MPEG analysis and multiplexing capability to enable easy creation of new transport streams. Options include carousel analysis and generation for testing interactive TV systems.

Tektronix has also introduced the WVR600 Waveform Rasteriser family aimed at broadcast confidence monitoring and production applications. Supporting mixed analogue and digital, video and audio environments and fitted with alarm and logging capabilities, the WVR600 is employs new FlexVu technology.

**Tektronix WVR600 Waveform Rasteriser**



**TechniSat SkyStar 2 TV digital PCI card**



The **TechniSat SkyStar 2** digital TV PCI card with PVR function is optimally configured for the reception of data streams via satellite, utilising the DVB broadcast standard. It also allows for high speed Internet access. The software supplied also enables the reception of DTV and radio programmes directly into the PC.

The company has also launched a portable LCD monitor with an

**TechniSat DigiPal LCD**



integrated DVB-T Receiver. The small and portable 6.8" TFT-LCD monitor is equipped with an integrated DVB-T receiver including antenna. Thanks to its heavy duty accumulator the DigiPal LCD operates independently from a mains connection and can be used anywhere. It can even be connected via a special adapter cable with a 12 Volt socket in a car, truck or boat. Dimensions: 212w x 167h x 69 mm.

The new **Rohde & Schwarz MHP ObjectStreamer** allows service providers to implement MHP applications for all DVB systems, simply and cost effectively without extensions to the programme multiplexer. Furthermore, the product can be conveniently integrated into the running system without affecting TV transmission.

The company has also introduced a software system update for the R&S SSUCarousel which provides a standardised solution for uploading software to DVB set-top boxes.

Also from Rohde & Schwarz is the new TV transposer/gap filler R&S XV7002 for efficient operation of digital TV transmitter networks. TV signals from the master transmitter can be rebroadcast directly so that small gaps in the network can be filled easily and without any effort.

**Rohde &Schwartz XV7002**



No matter how fast you want to roll out your DVB-T systems or what kind of network you use for transmission, Scientific-Atlanta products and services can make the process smooth and easy. We know DVB-T. Our powerful encoding products, advanced SI-processing products and ingenious transrating technology squeeze more performance out of your available bandwidth and reduces the cost per service. You can even control your network from a central location. Bottom line: You save money, improve efficiency, meet objectives and distribute your content exactly as you see fit.



*Continuum DVP™ D9030  
MPEG-2 Encoder featuring  
PreSightPlus™ encoding  
technology*



*TRANSIS™ RateCompressor  
with high-performance  
IntelliRate™ algorithms*



*ROSA™ element manager to  
manage the full transmitter site*

## Call Today

**Europe/Middle East/Africa  
Region Headquarters**

Kortrijk, Belgium  
+32.56.445.445

# “One Cannot Cross a Chasm in Small Steps.”



But with Scientific-Atlanta, you can cross  
the technology chasm in any way you wish.

[www.saeurope.com](http://www.saeurope.com)