

UPLIFT DESK®



PRICE BOOK + SPECIFICATION GUIDE

Spring 2021

A Healthier, Happier Work Environment Starts Here

At UPLIFT Desk, we understand that your office needs are as individual as each user. Let us create an ergonomic solution for your team. From private offices to open floor plans, we'll be with you every step of the process. As your partner, we offer free delivery, design planning services, a 30-day trial, and a 15-year warranty on standing desks, as well as financing options. For a full breakdown of warranties for all the products featured in this guide, visit the [warranty page](#) on our website.

The process begins with a phone call or email to our team, and it's followed by an in-person visit. Our team will work with you to craft a plan that solves the pain points you're experiencing with your current office. If an in-person meeting isn't possible, we'll request a CAD file to get a better understanding of your space.

Once a design has been agreed upon, we'll begin with pricing and financing options, then set an installation date. We can turn around projects from conception to installation in as little as 14 days. After your new office is complete, we'll follow up to ensure everything is perfect.

Give us a call; we're looking forward to working with you.



Save Money and Time

We cut out the middleman and pass the savings on to you. All orders ship free.



Empower Your Workforce

Improve employee retention with a happier, healthier, and more productive workplace.



Plan for Growth

Flexible, scalable solutions designed to evolve with the ever-changing needs of your business.



A LETTER FROM THE CEO

Dear Friend,

Welcome to UPLIFT Desk, a global leader in standing desks and ergonomics. Our mission at UPLIFT Desk is simple; we're here to provide the best selection of beautiful, functional, sustainable, and affordable standing desks and ergonomic furniture to enable you to work better and live healthier.

The adverse health effects from a sedentary lifestyle are well documented. Our bodies were built to move, and standing intermittently throughout your workday at a properly height-adjusted desk can lead to better overall health and increased productivity. We're thrilled that UPLIFT desks are helping hundreds of thousands of people worldwide improve their lives. Our desks have assisted Google, Boeing, Apple, JP Morgan Chase, AT&T, and Microsoft (to name a few) in creating a healthier work environment for their employees.

At UPLIFT Desk, we have a tireless commitment to handling manufacturing, retail, and fulfillment directly. This allows us to cut out the middleman and offer lower prices than our competitors. We also offer free shipping on every order, a 30-day trial, and a 15-year warranty on all of our products, in addition to bulk discounts and free desk accessories.

Additionally, we are a U.S. General Services Administration (GSA) contract holder and are proud to provide industry-leading ergonomic furniture and accessories to federal, state, and local government agencies and organizations in the United States. We have ergonomic solutions for any office, including those with ANSI/BIFMA standard requirements. You can refer to our products on [GSAAdvantage.gov](https://www.GSAAdvantage.gov).

We hope you consider UPLIFT Desk for your office furniture needs in the future. If you're ever in Austin, Texas, be sure to stop by and say, Howdy.

Sincerely,

Jon Paulsen
President, CEO

TABLE OF CONTENTS

| | |
|--------------------------------------|------------|
| Desktops + Table Tops..... | 05 |
| Desk + Table Frames..... | 18 |
| Adjustable Height Desk Frames..... | 19 |
| Side Table Frames..... | 28 |
| Frame Components..... | 34 |
| Standing Desk Converters..... | 41 |
| Accessories..... | 51 |
| Monitor Arms..... | 52 |
| Keyboard Trays..... | 57 |
| CPU Holders..... | 62 |
| Mats + Boards + Footrests..... | 64 |
| Desk Organization..... | 79 |
| Lighting..... | 90 |
| Power + Data..... | 95 |
| Wire Management..... | 102 |
| Mice + Keyboards..... | 109 |
| Seating..... | 114 |
| Office Chairs..... | 115 |
| Stools..... | 120 |
| Storage..... | 127 |
| File Cabinets..... | 128 |
| Desk Drawers + Cubbies..... | 133 |
| Space Division..... | 142 |
| UPLIFT Power and Data Rail..... | 143 |
| Power and Data Rail Components..... | 144 |
| Acoustics..... | 147 |
| Desk Acoustics..... | 148 |
| Wall Acoustics..... | 151 |
| Ceiling Acoustics..... | 162 |
| Office Acoustics..... | 167 |

**prices and products are subject to change*



DESKS + TABLES

Rectangular Desktop - 30" Deep

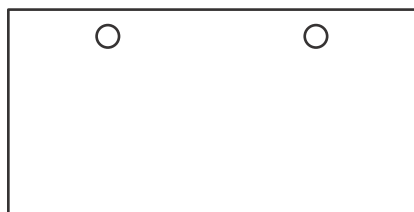

A GUIDE TO THE 30" Deep Rectangular Desktop SKU

Style SKU Size Grommets
TOP404-60x30-G

This example is for a 60x30 Black GREENGUARD Gold Laminate Desktop with grommets.

Laminate - Greenguard-Gold Certified

| Image | Thickness | Width | SKU | Weight | \$ Price |
|-------|-----------|-------|----------------|--------|----------|
| | 1" | 42" | TOPXXX-42x30-G | 29 lb | \$299 |
| | 1" | 48" | TOPXXX-48x30-G | 33 lb | \$349 |
| | 1" | 60" | TOPXXX-60x30-G | 41 lb | \$409 |
| | 1" | 72" | TOPXXX-72x30-G | 50 lb | \$509 |
| | 1" | 80" | TOPXXX-80x30-G | 55 lb | \$559 |
| | | | | | |
| | | | | | |

*TOPXXX represents all GREENGUARD Gold Laminate Desktops, which are all the same weight and price.

Custom Order Laminate

| | | | | | |
|--|----|-----|----------------|-------|--------|
| | 1" | 42" | TOPXXX-42x30-G | 35 lb | \$749 |
| | 1" | 44" | TOPXXX-44x30-G | 37 lb | \$764 |
| | 1" | 46" | TOPXXX-46x30-G | 38 lb | \$779 |
| | 1" | 48" | TOPXXX-48x30-G | 40 lb | \$794 |
| | 1" | 50" | TOPXXX-50x30-G | 42 lb | \$809 |
| | 1" | 52" | TOPXXX-52x30-G | 43 lb | \$824 |
| | 1" | 54" | TOPXXX-54x30-G | 45 lb | \$839 |
| | 1" | 56" | TOPXXX-56x30-G | 47 lb | \$854 |
| | 1" | 58" | TOPXXX-58x30-G | 48 lb | \$869 |
| | 1" | 60" | TOPXXX-60x30-G | 50 lb | \$884 |
| | 1" | 62" | TOPXXX-62x30-G | 52 lb | \$899 |
| | 1" | 64" | TOPXXX-64x30-G | 53 lb | \$914 |
| | 1" | 66" | TOPXXX-66x30-G | 55 lb | \$929 |
| | 1" | 68" | TOPXXX-68x30-G | 57 lb | \$944 |
| | 1" | 70" | TOPXXX-70x30-G | 58 lb | \$959 |
| | 1" | 72" | TOPXXX-72x30-G | 60 lb | \$974 |
| | 1" | 74" | TOPXXX-74x30-G | 61 lb | \$989 |
| | 1" | 76" | TOPXXX-76x30-G | 63 lb | \$1004 |
| | 1" | 78" | TOPXXX-78x30-G | 65 lb | \$1019 |
| | 1" | 80" | TOPXXX-80x30-G | 66 lb | \$1034 |
| | | | | | |
| | | | | | |
| | | | | | |
| | | | | | |
| | | | | | |
| | | | | | |
| | | | | | |
| | | | | | |

*TOPXXX represents all GREENGUARD Gold Laminate Desktops, which are all the same weight and price.







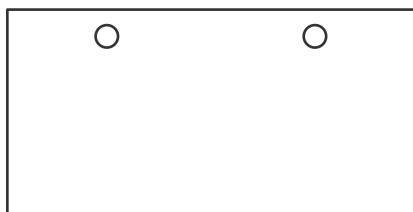

Rectangular Desktop - 30" Deep

A GUIDE TO THE 30" Deep Rectangular Desktop SKU

Style SKU Size Grommets
TOP371-60x30-G

This example is for a 60x30 Bamboo Desktop with grommets.



| Bamboo | | Thickness | Width | Depth | SKU | Weight | \$ Price |
|---|---------------------------------|-----------|-------|-------|----------------|--------|----------|
|  | Bamboo TOP371 | 1" | 42" | 30" | TOP371-42x30-G | 33 lb | \$349 |
| | | 1" | 48" | 30" | TOP371-48x30-G | 37 lb | \$359 |
|  | Dark Bamboo TOP372 | 1" | 60" | 30" | TOP371-60x30-G | 47 lb | \$584 |
| | | 1" | 72" | 30" | TOP371-72x30-G | 56 lb | \$611 |
| | | 1" | 80" | 30" | TOP371-80x30-G | 62 lb | \$634 |
| <i>TOP372 Dark Bamboo + \$49</i> | | | | | | | |
| <i>*80" width available with or without grommets.</i> | | | | | | | |
| Solid Wood | | | | | | | |
|  | Rubberwood TOP414 | 1.75" | 42" | 30" | TOP414-42x30 | 29 lb | \$369 |
| | | 1.75" | 48" | 30" | TOP414-48x30 | 33 lb | \$379 |
| | | 1.75" | 60" | 30" | TOP414-60x30 | 61 lb | \$549 |
| | | 1.75" | 72" | 30" | TOP414-72x30 | 50 lb | \$576 |
| | | 1.75" | 80" | 30" | TOP414-80x30 | 55 lb | \$599 |
|  | Dark Brown Rubberwood TOP418 | 1.75" | 42" | 30" | TOP418-42x30 | 29 lb | \$399 |
| | | 1.75" | 48" | 30" | TOP418-48x30 | 33 lb | \$409 |
| | | 1.75" | 60" | 30" | TOP418-60x30 | 61 lb | \$579 |
| | | 1.75" | 72" | 30" | TOP418-72x30 | 50 lb | \$606 |
| | | 1.75" | 80" | 30" | TOP418-80x30 | 55 lb | \$629 |
|  | Recalimed Fir TOP327 | 1.5" | 42" | 30" | TOP327-42x30 | 35 lb | \$729 |
| | | 1.5" | 48" | 30" | TOP327-48x30 | 40 lb | \$808 |
| | | 1.5" | 60" | 30" | TOP327-60x30 | 50 lb | \$967 |
| | | 1.5" | 72" | 30" | TOP327-72x30 | 60 lb | \$1125 |
| | | 1.5" | 80" | 30" | TOP327-80x30 | 67 lb | \$1231 |
|  | Phesantwood TOP313 | 1.75" | 42" | 30" | TOPXXX-42x30 | 66 lb | \$729 |
| | | 1.75" | 48" | 30" | TOPXXX-48x30 | 75 lb | \$808 |
| | | 1.75" | 60" | 30" | TOPXXX-60x30 | 93 lb | \$967 |
| | | 1.75" | 72" | 30" | TOPXXX-72x30 | 112 lb | \$1125 |
| | | 1.75" | 80" | 30" | TOPXXX-80x30 | 125 lb | \$1231 |
|  | Ash TOP318 | 1.75" | 42" | 30" | TOPXXX-42x30 | 66 lb | \$729 |
| | | 1.75" | 48" | 30" | TOPXXX-48x30 | 75 lb | \$808 |
| | | 1.75" | 60" | 30" | TOPXXX-60x30 | 93 lb | \$967 |
| | | 1.75" | 72" | 30" | TOPXXX-72x30 | 112 lb | \$1125 |
| | | 1.75" | 80" | 30" | TOPXXX-80x30 | 125 lb | \$1231 |
|  | African Mahogany TOP324 | 1.75" | 42" | 30" | TOPXXX-42x30 | 66 lb | \$729 |
| | | 1.75" | 48" | 30" | TOPXXX-48x30 | 75 lb | \$808 |
| | | 1.75" | 60" | 30" | TOPXXX-60x30 | 93 lb | \$967 |
| | | 1.75" | 72" | 30" | TOPXXX-72x30 | 112 lb | \$1125 |
| | | 1.75" | 80" | 30" | TOPXXX-80x30 | 125 lb | \$1231 |
|  | Walnut TOP316 | 1.75" | 42" | 30" | TOP316-42x30 | 56 lb | \$849 |
| | | 1.75" | 48" | 30" | TOP316-48x30 | 66 lb | \$928 |
| | | 1.75" | 60" | 30" | TOP316-60x30 | 83 lb | \$1087 |
| | | 1.75" | 72" | 30" | TOP316-72x30 | 99 lb | \$1245 |
| | | 1.75" | 80" | 30" | TOP316-80x30 | 110 lb | \$1351 |

This example is for a 60x30 Walnut Solid Wood Desktop with grommets.
*These desktops can be ordered in custom sizes and prices vary.
Contact us for a quote.

Rectangular Desktop - 30" Deep

A GUIDE TO THE 30" Deep Rectangular Desktop SKU

Style SKU Size Grommets
TOP251-60x30-G

This example is for a 60x30 Cherry Desktop with grommets.







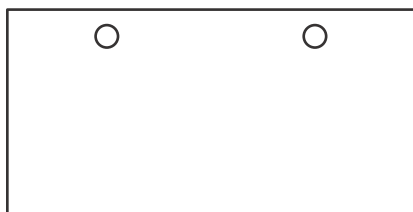



*Custom Solid Wood desktops take between 14-16 weeks to arrive.

*Custom sizes cut within a quarter inch of your specifications are available. Contact us for a quote.

*All sizes available with or without grommets.



Custom Order Solid Wood

| | Thickness | Width | Depth | SKU | Weight | \$ Price |
|--|-----------|-------|-------|--------------|--------|----------|
|  Maple TOP258 | 1.75" | 42" | 30" | TOP258-42x30 | Varies | \$1259 |
| | 1.75" | 48" | 30" | TOP258-48x30 | Varies | \$1338 |
| | 1.75" | 60" | 30" | TOP258-60x30 | Varies | \$1497 |
| | 1.75" | 72" | 30" | TOP258-72x30 | Varies | \$1655 |
| | 1.75" | 80" | 30" | TOP258-80x30 | Varies | \$1761 |
|   Dark Ash Ash TOP256 TOP255 | 1.75" | 42" | 30" | TOPXXX-42x30 | 53 lb | \$1299 |
| | 1.75" | 48" | 30" | TOPXXX-48x30 | 60 lb | \$1378 |
| | 1.75" | 60" | 30" | TOPXXX-60x30 | 76 lb | \$1537 |
| | 1.75" | 72" | 30" | TOPXXX-72x30 | 91 lb | \$1695 |
| | 1.75" | 80" | 30" | TOPXXX-80x30 | 101 lb | \$1801 |
|     Dark Pecan Pecan White Oak Cherry TOP262 TOP261 TOP263 TOP257 | 1.75" | 42" | 30" | TOPXXX-42x30 | Varies | \$1319 |
| | 1.75" | 48" | 30" | TOPXXX-48x30 | Varies | \$1398 |
| | 1.75" | 60" | 30" | TOPXXX-60x30 | Varies | \$1557 |
| | 1.75" | 72" | 30" | TOPXXX-72x30 | Varies | \$1715 |
| | 1.75" | 80" | 30" | TOPXXX-80x30 | Varies | \$1821 |
|   Sipo Mahogany Bamboo TOP264 TOP260 | 1.75" | 42" | 30" | TOPXXX-42x30 | Varies | \$1369 |
| | 1.75" | 48" | 30" | TOPXXX-48x30 | Varies | \$1448 |
| | 1.75" | 60" | 30" | TOPXXX-60x30 | Varies | \$1607 |
| | 1.75" | 72" | 30" | TOPXXX-72x30 | Varies | \$1765 |
| | 1.75" | 80" | 30" | TOPXXX-80x30 | Varies | \$1871 |
|  Walnut TOP259 | 1.75" | 42" | 30" | TOP259-42x30 | 58 lb | \$1549 |
| | 1.75" | 48" | 30" | TOP259-48x30 | 66 lb | \$1628 |
| | 1.75" | 60" | 30" | TOP259-60x30 | 83 lb | \$1787 |
| | 1.75" | 72" | 30" | TOP259-72x30 | 99 lb | \$1945 |
| | 1.75" | 80" | 30" | TOP259-80x30 | 110 lb | \$2051 |

Curved Desktop - 30" Deep

A GUIDE TO THE 30" Deep Curve Desktop Model SKU

Style SKU Size Curved Grommets
TOP371-60x30-E-G

This example is for a 60x30 Black Eco Curve Desktop with grommets.

*Not Available without grommets holes.

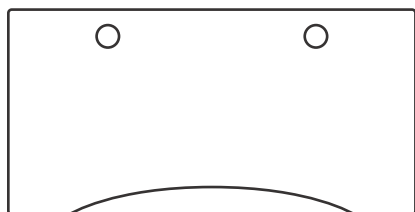

Eco Curve



Black
TOP506

White
TOP507

| Thickness | Width | SKU | Weight | \$ Price |
|-----------|-------|------------------|--------|----------|
| 1" | 42" | TOPXXX-42x30-E-G | 37 lb | \$344 |
| 1" | 48" | TOPXXX-48x30-E-G | 42 lb | \$348 |
| 1" | 60" | TOPXXX-60x30-E-G | 52 lb | \$511 |
| 1" | 72" | TOPXXX-72x30-E-G | 63 lb | \$531 |
| 1" | 80" | TOPXXX-80x30-E-G | 70 lb | \$547 |

Bamboo Curve



Bamboo
TOP371

DarkBamboo
TOP372

| | | | | |
|----|-----|------------------|-------|-------|
| 1" | 42" | TOPXXX-42x30-E-G | 30 lb | \$369 |
| 1" | 48" | TOPXXX-48x30-E-G | 34 lb | \$379 |
| 1" | 60" | TOPXXX-60x30-E-G | 44 lb | \$604 |
| 1" | 72" | TOPXXX-72x30-E-G | 53 lb | \$631 |
| 1" | 80" | TOPXXX-80x30-E-G | 59 lb | \$654 |

Rectangular Desktop - 24" Deep



A GUIDE TO THE 24" Deep Rectangular Desktop SKU

Style SKU Size Grommets
TOP404-60x24-G

This example is for a 60x24 Black GREENGAURD Gold Laminate Desktop with grommets.

Laminate - Greenguard-Gold Certified

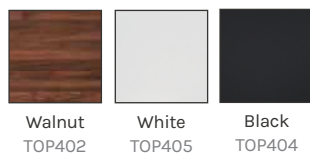

| Thickness | Width | SKU | Weight | \$ Price |
|-----------|-------|----------------|--------|----------|
| 1" | 42" | TOPXXX-42x24-G | 23 lb | \$299 |
| 1" | 48" | TOPXXX-48x24-G | 26 lb | \$349 |
| 1" | 60" | TOPXXX-60x24-G | 33 lb | \$409 |
| 1" | 72" | TOPXXX-72x24-G | 40 lb | \$509 |

*TOPXXX represents all GREENGAURD Gold Laminate Desktops, which are all the same weight and price.

Custom Order Laminate

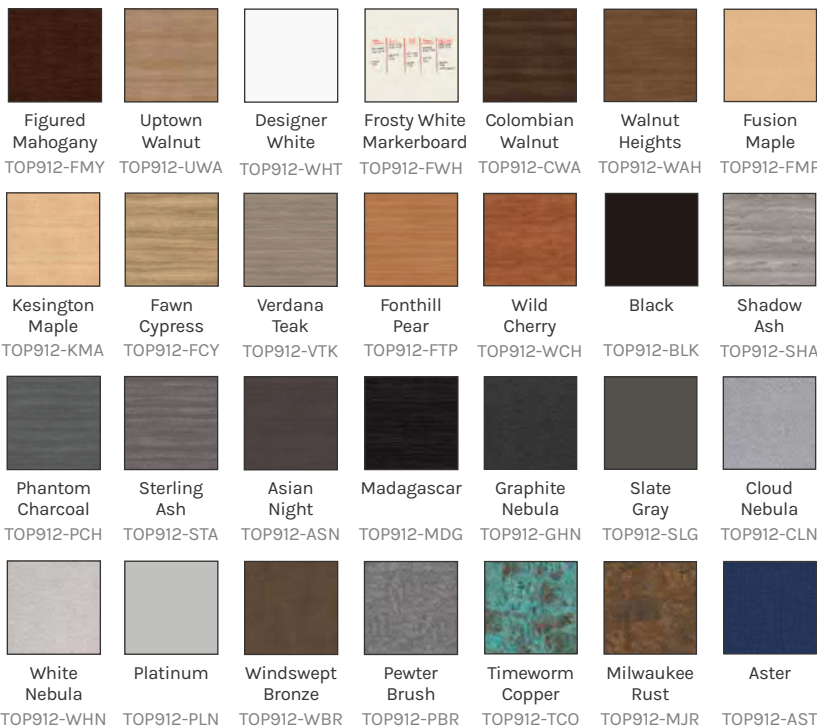

| | | | | |
|----|-----|----------------|-------|--------|
| 1" | 42" | TOPXXX-42x30-G | 35 lb | \$749 |
| 1" | 44" | TOPXXX-44x30-G | 37 lb | \$764 |
| 1" | 46" | TOPXXX-46x30-G | 38 lb | \$\$\$ |
| 1" | 48" | TOPXXX-48x30-G | 40 lb | \$794 |
| 1" | 50" | TOPXXX-50x30-G | 42 lb | \$809 |
| 1" | 52" | TOPXXX-52x30-G | 43 lb | \$824 |
| 1" | 54" | TOPXXX-54x30-G | 45 lb | \$839 |
| 1" | 56" | TOPXXX-56x30-G | 47 lb | \$854 |
| 1" | 58" | TOPXXX-58x30-G | 48 lb | \$869 |
| 1" | 60" | TOPXXX-60x30-G | 50 lb | \$884 |
| 1" | 62" | TOPXXX-62x30-G | 52 lb | \$899 |
| 1" | 64" | TOPXXX-64x30-G | 53 lb | \$914 |
| 1" | 66" | TOPXXX-66x30-G | 55 lb | \$929 |
| 1" | 68" | TOPXXX-68x30-G | 57 lb | \$944 |
| 1" | 70" | TOPXXX-70x30-G | 58 lb | \$959 |
| 1" | 72" | TOPXXX-72x30-G | 60 lb | \$974 |
| 1" | 74" | TOPXXX-74x30-G | 61 lb | \$989 |
| 1" | 76" | TOPXXX-76x30-G | 63 lb | \$1004 |
| 1" | 78" | TOPXXX-78x30-G | 65 lb | \$1019 |
| 1" | 80" | TOPXXX-80x30-G | 66 lb | \$1034 |

*TOPXXX represents all GREENGAURD Gold Laminate Desktops, which are all the same weight and price.







Rectangular Desktop - 24" Deep

A GUIDE TO THE 24" Deep Rectangular Desktop SKU

Style SKU Size Grommets
TOP371-60x24-G

This example is for a 60x24 Bamboo Desktop with grommets.
*Not Available without grommet holes.



| Bamboo | | Thickness | Width | Depth | SKU | Weight | \$ Price |
|--|--|-----------|-------|-------|----------------|--------|----------|
|  Bamboo TOP371 Dark Bamboo TOP372 | | 1" | 42" | 24" | TOPXXX-42x24-G | 26 lb | \$349 |
| | | 1" | 48" | 24" | TOPXXX-48x24-G | 30 lb | \$359 |
| | | 1" | 60" | 24" | TOPXXX-60x24-G | 37 lb | \$426 |
| | | 1" | 72" | 24" | TOPXXX-72x24-G | 45 lb | \$594 |
| Custom Order Solid Wood | | Thickness | Width | Depth | SKU | Weight | \$ Price |
|  Maple TOP258 | | 1.75" | 42" | 24" | TOP258-42x24 | Varies | \$1259 |
| | | 1.75" | 48" | 24" | TOP258-48x24 | Varies | \$1338 |
| | | 1.75" | 60" | 24" | TOP258-60x24 | Varies | \$1497 |
| | | 1.75" | 72" | 24" | TOP258-72x24 | Varies | \$1655 |
| | | 1.75" | 80" | 24" | TOP258-80x24 | Varies | \$1761 |
|  Dark Ash TOP256 Ash TOP255 | | 1.75" | 42" | 24" | TOPXXX-42x24 | 42 lb | \$1299 |
| | | 1.75" | 48" | 24" | TOPXXX-48x24 | 48 lb | \$1378 |
| | | 1.75" | 60" | 24" | TOPXXX-60x24 | 60 lb | \$1537 |
| | | 1.75" | 72" | 24" | TOPXXX-72x24 | 73 lb | \$1695 |
| | | 1.75" | 80" | 24" | TOPXXX-80x24 | 81 lb | \$1801 |
|  Dark Pecan TOP262 Pecan TOP261 White Oak TOP263 Cherry TOP257 | | 1.75" | 42" | 24" | TOPXXX-42x24 | Varies | \$1319 |
| | | 1.75" | 48" | 24" | TOPXXX-48x24 | Varies | \$1398 |
| | | 1.75" | 60" | 24" | TOPXXX-60x24 | Varies | \$1557 |
| | | 1.75" | 72" | 24" | TOPXXX-72x24 | Varies | \$1715 |
| | | 1.75" | 80" | 24" | TOPXXX-80x24 | Varies | \$1821 |
|  Sipo Mahogany TOP264 Bamboo TOP260 | | 1.75" | 42" | 24" | TOPXXX-42x24 | Varies | \$1369 |
| | | 1.75" | 48" | 24" | TOPXXX-48x24 | Varies | \$1448 |
| | | 1.75" | 60" | 24" | TOPXXX-60x24 | Varies | \$1607 |
| | | 1.75" | 72" | 24" | TOPXXX-72x24 | Varies | \$1765 |
| | | 1.75" | 80" | 24" | TOPXXX-80x24 | Varies | \$1871 |
|  Walnut TOP259 | | 1.75" | 42" | 24" | TOP259-42x24 | 46 lb | \$1549 |
| | | 1.75" | 48" | 24" | TOP259-48x24 | 53 lb | \$1628 |
| | | 1.75" | 60" | 24" | TOP259-60x24 | 66 lb | \$1787 |
| | | 1.75" | 72" | 24" | TOP259-72x24 | 79 lb | \$1945 |
| | | 1.75" | 80" | 24" | TOP259-80x24 | 88 lb | \$2051 |

Curved Corner Desktop - Left and Right Return

[See complete spec sheet here](#)



A GUIDE TO THE 47" Deep Curved Corner Desktop SKU

Style SKU Size Grommets
TOP511-60x47-G

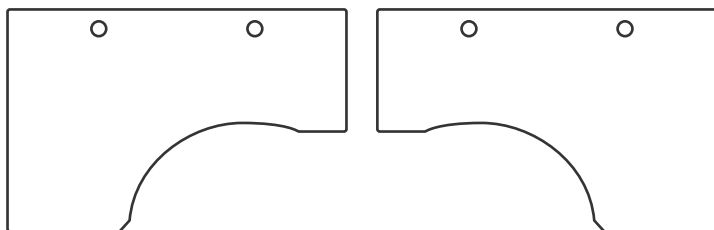

This example is for a 60x47 Black Eco Curve Laminate Desktop with grommets.

*Curved Corner desktops are available with right or left returns.



| Laminate | Color | Thickness | Width | Depth | SKU | Weight | \$ Price |
|---|-------|-----------|-------|-------|----------------|--------|----------|
|  | Black | 1" | 72" | 47" | TOP511-BLK-L-G | 78 lb | \$1129 |
|  | White | 1" | 72" | 47" | TOP511-WHT-L-G | 78 lb | \$1129 |

*Not currently sold separately.
*Available with grommets only.

| Bamboo | Thickness | Width | Depth | SKU | Weight | \$ Price |
|--|-----------|-------|-------|----------------------------|--------|----------|
|   | 1" | 72" | 47" | TOP271-72x47-LCORNER-LFT-G | 86 lb | \$1149 |

*Not currently sold separately.
*Available with grommets only.

| Solid Wood | Thickness | Width | Depth | SKU | Weight | \$ Price |
|--|-----------|-------|-------|----------------------------|--------|----------|
|  | 1" | 72" | 47" | TOP325-72x47-LCORNER-LFT-G | 80 lb | \$1179 |

*Not currently sold separately.
*Available with grommets only.

120 Degree Desktop

[See complete spec sheet here](#)

A GUIDE TO THE 38" 120 Degree Desktop SKU

Style SKU Size Grommets
TOP404-60x38-G

This example is for a 60x38 Black Laminate 120 Degree Desktop Laminate Desktop with grommets.

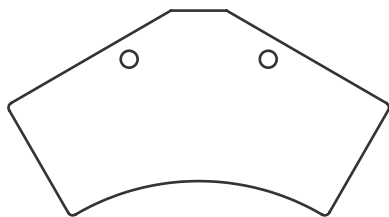

| Laminate | Thickness | Width | Depth | SKU | Weight | \$ Price |
|----------|-----------|-------|-------|-----|--------|----------|
|----------|-----------|-------|-------|-----|--------|----------|



Black White
 TOP404 TOP405

| | | | | | |
|----|-----|-----|--------------|---------|-------|
| 1" | 71" | 38" | TOPXXX-120-G | 40.5 lb | \$559 |
|----|-----|-----|--------------|---------|-------|

**Available with grommets only.*

Bamboo



Bamboo
 TOP271

| | | | | | |
|----|-----|-----|--------------|-------|-------|
| 1" | 71" | 38" | TOP271-120-G | 45 lb | \$599 |
|----|-----|-----|--------------|-------|-------|

**Available with grommets only.*

L-Shaped Desktop

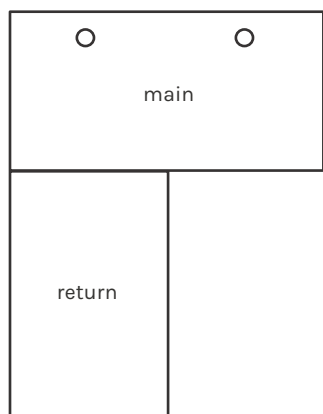

A GUIDE TO THE L-Shaped Desktop SKU

This SKU is broken up into two parts: Main Desktop SKU and Return Desktop SKU.

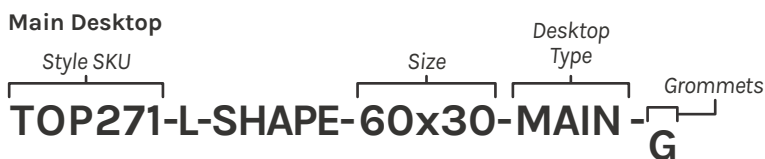

This example is for a bamboo L-Shaped Desk with a 60"x30" Main Desktop and a 48"x27" Return Desktop (60"x78"x30"x27").

Laminate - Greenguard-Gold Certified

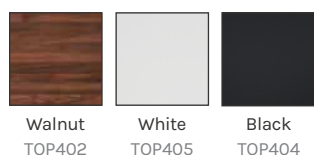

| Thickness | Desktop | SKU | Weight | \$ Price |
|-----------|-----------|----------------------|--------|----------------------|
| 1" | 60"Mx60"R | TOPXXX-L-SHAPE-60x60 | 79 lb | \$1249 (with return) |
| 1" | 60"Mx78"R | TOPXXX-L-SHAPE-66x78 | 91 lb | \$1399 (with return) |
| 1" | 72"Mx60"R | TOPXXX-L-SHAPE-72x72 | 88 lb | \$1349 (with return) |
| 1" | 72"Mx78"R | TOPXXX-L-SHAPE-72x78 | 99 lb | \$1499 (with return) |
| 1" | 80"Mx60"R | TOPXXX-L-SHAPE-80x60 | 93 lb | \$1414 (with return) |
| 1" | 80"Mx78"R | TOPXXX-L-SHAPE-80x78 | 105 lb | \$1564 (with return) |

*TOPXXX represents all GREENGAURD Gold Laminate Desks, which are all the same weight and price.

*GREENGUARD Gold Laminates also available in custom colors & sizes. Contact us for more information.

*Main desktops available with grommets only.

*Return desktops do not have grommets.

Bamboo

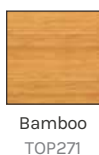

| | | | | |
|----|-----------|----------------------|--------|----------------------|
| 1" | 60"Mx60"R | TOP271-L-SHAPE-60x60 | 94 lb | \$1309 (with return) |
| 1" | 60"Mx78"R | TOP271-L-SHAPE-66x78 | 134 lb | \$1459 (with return) |
| 1" | 72"Mx60"R | TOP271-L-SHAPE-72x72 | 135 lb | \$1409 (with return) |
| 1" | 72"Mx78"R | TOP271-L-SHAPE-72x78 | 146 lb | \$1559 (with return) |
| 1" | 80"Mx60"R | TOP271-L-SHAPE-80x60 | 125 lb | \$1474 (with return) |
| 1" | 80"Mx78"R | TOP271-L-SHAPE-80x78 | 162 lb | \$1624 (with return) |

*Main desktops available with grommets only.

*Return desktops do not have grommets.

Solid Wood

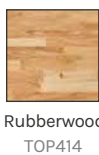

| | | | | |
|----|--------------|----------------------|--------|----------------------|
| 1" | 60"x60" main | TOP414-L-SHAPE-60x60 | 83 lb | \$1344 (with return) |
| 1" | 66"x78" main | TOP414-L-SHAPE-66x78 | 118 lb | \$1494 (with return) |
| 1" | 72"x72" main | TOP414-L-SHAPE-72x72 | 119 lb | \$1444 (with return) |
| 1" | 72"x78" main | TOP414-L-SHAPE-72x78 | 129 lb | \$1594 (with return) |
| 1" | 80"x60" main | TOP414-L-SHAPE-80x60 | 110 lb | \$1509 (with return) |
| 1" | | TOP414-L-SHAPE-80x78 | 144 lb | \$1659 (with return) |

*Main desktops available with grommets only.

*Return desktops do not have grommets.

L-Shaped Desktop

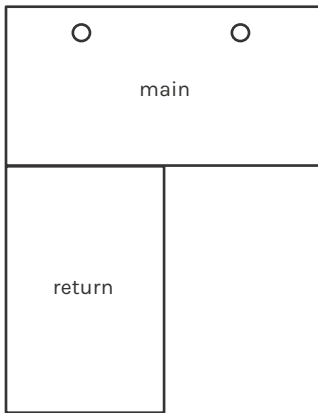

A GUIDE TO THE L-Shaped Desktop SKUs

This SKU is broken up into two parts: Main Desktop SKU and Return Desktop SKU.

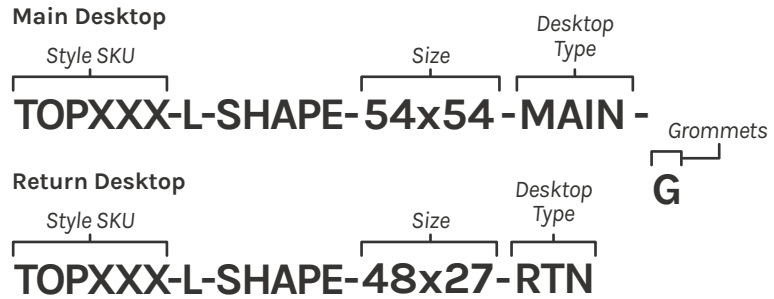

This example is for a Designer White L-Shaped Desk with a 60"x30" Main Desktop and a 48"x27" Return Desktop (60"x78"x30"x27").

Custom Order Laminate

| Custom Order Laminate | Thickness | Desktop | SKU | Weight | \$ Price |
|--|-----------|-----------|-----------------------------|--------|----------|
| Figured Mahogany TOP931-FMY | 1" | 54"Mx54"R | TOPXXX-L-SHAPE-54x54-L or R | 52 lb | \$1599 |
| Uptown Walnut TOP931-UWA | 1" | 54"Mx60"R | TOPXXX-L-SHAPE-54x60-L or R | 56 lb | \$1629 |
| Designer White TOP931-WHT | 1" | 54"Mx72"R | TOPXXX-L-SHAPE-54x72-L or R | 64 lb | \$1649 |
| Frosty White Markerboard TOP931-FWH | 1" | 54"Mx78"R | TOPXXX-L-SHAPE-54x78-L or R | 68 lb | \$1669 |
| Colombian Walnut TOP931-CWA | 1" | 54"Mx84"R | TOPXXX-L-SHAPE-54x84-L or R | 71 lb | \$1689 |
| Walnut Heights TOP931-WAH | 1" | 60"Mx54"R | TOPXXX-L-SHAPE-60x54-L or R | 57 lb | \$1639 |
| Fusion Maple TOP931-FMP | 1" | 60"Mx60"R | TOPXXX-L-SHAPE-60x60-L or R | 60 lb | \$1669 |
| Kesington Maple TOP931-KMA | 1" | 60"Mx72"R | TOPXXX-L-SHAPE-60x72-L or R | 68 lb | \$1689 |
| Fawn Cypress TOP931-FCY | 1" | 60"Mx78"R | TOPXXX-L-SHAPE-60x78-L or R | 72 lb | \$1709 |
| Veranda Teak TOP931-VTK | 1" | 60"Mx84"R | TOPXXX-L-SHAPE-60x84-L or R | 76 lb | \$1729 |
| Fonthill Pear TOP931-FTP | 1" | 66"Mx54"R | TOPXXX-L-SHAPE-66x54-L or R | 61 lb | \$1669 |
| Wild Cherry TOP931-WCH | 1" | 66"Mx60"R | TOPXXX-L-SHAPE-66x60-L or R | 65 lb | \$1699 |
| Black TOP931-BLK | 1" | 66"Mx72"R | TOPXXX-L-SHAPE-66x72-L or R | 72 lb | \$1719 |
| Shadow Ash TOP931-SHA | 1" | 66"Mx78"R | TOPXXX-L-SHAPE-66x78-L or R | 76 lb | \$1739 |
| Phantom Charcoal TOP931-PCH | 1" | 66"Mx84"R | TOPXXX-L-SHAPE-66x84-L or R | 80 lb | \$1759 |
| Sterling Ash TOP931-STA | 1" | 72"Mx54"R | TOPXXX-L-SHAPE-72x54-L or R | 65 lb | \$1699 |
| Asian Night TOP931-ASN | 1" | 72"Mx60"R | TOPXXX-L-SHAPE-72x60-L or R | 69 lb | \$1729 |
| Madagascar TOP931-MDG | 1" | 72"Mx72"R | TOPXXX-L-SHAPE-72x72-L or R | 76 lb | \$1749 |
| Graphite Nebula TOP931-GHN | 1" | 72"Mx78"R | TOPXXX-L-SHAPE-72x78-L or R | 80 lb | \$1769 |
| Slate Gray TOP931-SLG | 1" | 72"Mx84"R | TOPXXX-L-SHAPE-72x84-L or R | 84 lb | \$1789 |
| Cloud Nebula TOP931-CLN | 1" | 80"Mx54"R | TOPXXX-L-SHAPE-80x54-L or R | 70 lb | \$1739 |
| White Nebula TOP931-WHN | 1" | 80"Mx60"R | TOPXXX-L-SHAPE-80x60-L or R | 74 lb | \$1769 |
| Windswept Bronze TOP931-WBR | 1" | 80"Mx72"R | TOPXXX-L-SHAPE-80x72-L or R | 82 lb | \$1789 |
| Pewter Brush TOP931-PBR | 1" | 80"Mx78"R | TOPXXX-L-SHAPE-80x78-L or R | 86 lb | \$1809 |
| | 1" | 80"Mx84"R | TOPXXX-L-SHAPE-80x84-L or R | 89 lb | \$1829 |

*TOPXXX represents all GREENGAURD Gold Laminate Desktops, which are all the same weight and price.

*These desktops can be ordered in custom sizes and prices vary. Contact us for a quote.

*All sizes available with or without grommets.

L-Shaped Desktop

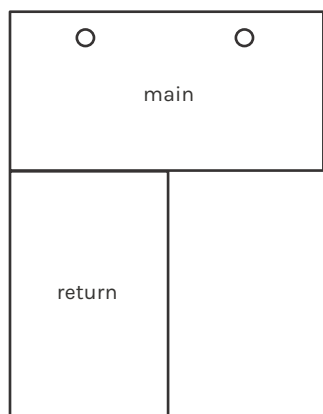

A GUIDE TO THE L-Shaped Desktop SKU

This SKU is broken up into two parts: Main Desktop SKU and Return Desktop SKU.

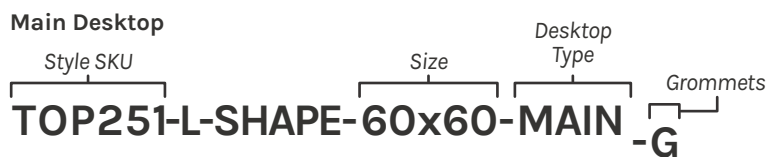











This example is for a Cherry L-Shaped Desk with a 60"x30" Main Desktop and a 48"x27" Return Desktop (60"x78"x30"x27")

*Custom Solid Wood desktops take between 14-16 weeks to arrive.

*Custom sizes cut within a quarter inch of your specifications are available.

Contact us for a quote.

| Custom Order Solid Wood | Thickness | Desktop | SKU | Weight | \$ Price |
|--|-----------|--------------|----------------------|--------|----------------------|
|  Maple TOP258 | 1.75" | 60"x60" main | TOP258-L-SHAPE-60x60 | Varies | \$3129 (with return) |
| | 1.75" | 66"x66" main | TOP258-L-SHAPE-66x66 | Varies | \$3256 (with return) |
| | 1.75" | 72"x72" main | TOP258-L-SHAPE-72x72 | Varies | \$3446 (with return) |
| | 1.75" | 78"x78" main | TOP258-L-SHAPE-78x78 | Varies | \$3573 (with return) |
| | 1.75" | 84"x84" main | TOP258-L-SHAPE-84x84 | Varies | \$3763 (with return) |
|   Dark Ash TOP256 | 1.75" | 60"x60" main | TOPXXX-L-SHAPE-60x60 | 151 lb | \$3179 (with return) |
| | 1.75" | 66"x66" main | TOPXXX-L-SHAPE-66x66 | 183 lb | \$3306 (with return) |
| | 1.75" | 72"x72" main | TOPXXX-L-SHAPE-72x72 | 218 lb | \$3496 (with return) |
| | 1.75" | 78"x78" main | TOPXXX-L-SHAPE-78x78 | 256 lb | \$3623 (with return) |
| | 1.75" | 84"x84" main | TOPXXX-L-SHAPE-84x84 | 296 lb | \$3813 (with return) |
|     Dark Pecan TOP262 | 1.75" | 60"x60" main | TOPXXX-L-SHAPE-60x60 | Varies | \$3219 (with return) |
| | 1.75" | 66"x66" main | TOPXXX-L-SHAPE-66x66 | Varies | \$3346 (with return) |
| | 1.75" | 72"x72" main | TOPXXX-L-SHAPE-72x72 | Varies | \$3536 (with return) |
| | 1.75" | 78"x78" main | TOPXXX-L-SHAPE-78x78 | Varies | \$3663 (with return) |
| | 1.75" | 84"x84" main | TOPXXX-L-SHAPE-84x84 | Varies | \$3853 (with return) |
|   Sipo Mahogany TOP264 | 1.75" | 60"x60" main | TOPXXX-L-SHAPE-60x60 | Varies | \$3319 (with return) |
| | 1.75" | 66"x66" main | TOPXXX-L-SHAPE-66x66 | Varies | \$3446 (with return) |
| | 1.75" | 72"x72" main | TOPXXX-L-SHAPE-72x72 | Varies | \$3636 (with return) |
| | 1.75" | 78"x78" main | TOPXXX-L-SHAPE-78x78 | Varies | \$3763 (with return) |
| | 1.75" | 84"x84" main | TOPXXX-L-SHAPE-84x84 | Varies | \$3953 (with return) |
|  Walnut TOP259 | 1.75" | 60"x60" main | TOP259-L-SHAPE-60x60 | 166 lb | \$3619 (with return) |
| | 1.75" | 66"x66" main | TOP259-L-SHAPE-66x66 | 200 lb | \$3746 (with return) |
| | 1.75" | 72"x72" main | TOP259-L-SHAPE-72x72 | 238 lb | \$3936 (with return) |
| | 1.75" | 78"x78" main | TOP259-L-SHAPE-78x78 | 258 lb | \$4063 (with return) |
| | 1.75" | 84"x84" main | TOP259-L-SHAPE-84x84 | 325 lb | \$4253 (with return) |

Conference Table Desktop

A GUIDE TO THE 42" Deep Rectangular Desktop SKU

Style SKU Size Grommets
TOP271-42x108-G

This example is for a 42x108 Bamboo Desktop without grommets.



| Bamboo | Thickness | Width | Depth | SKU | Weight | \$ Price |
|--------|-----------|-------|-------|-----|--------|----------|
|--------|-----------|-------|-------|-----|--------|----------|



Bamboo
TOP271

| | | | | | |
|----|----------|-----|-------------|--------|--------|
| 1" | 96"-108" | 42" | TOP271-CONF | 118 lb | \$1099 |
|----|----------|-----|-------------|--------|--------|

**can adjust from 96" or 108" wide depending on use of leaf.*

Conference Ping Pong Table Desktop

A GUIDE TO THE 60" Deep Rectangular Desktop SKU

Style SKU Size Grommets
TOP271-60x108-G

This example is for a 60x108 Bamboo Desktop without grommets.

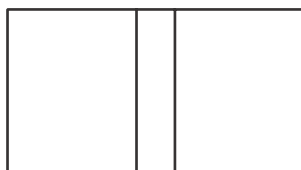

| Bamboo | Thickness | Width | Depth | SKU | Weight | \$ Price |
|--------|-----------|-------|-------|-----|--------|----------|
|--------|-----------|-------|-------|-----|--------|----------|



Bamboo
TOP271

| | | | | | |
|----|------|-----|-----------------|--------|--------|
| 1" | 108" | 60" | TOP271-PINGPONG | 168 lb | \$1499 |
|----|------|-----|-----------------|--------|--------|

Crafting Table Desktop

[See complete spec sheet here](#)

A GUIDE TO THE 60" Deep Rectangular Desktop SKU

Style SKU Size Grommets
TOP314-60x30-G

This example is for a 60x30 Rubberwood Desktop without grommets.

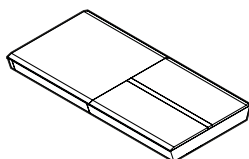

| Solid Wood | Thickness | Width | Depth | SKU | Weight | \$ Price |
|------------|-----------|-------|-------|-----|--------|----------|
|------------|-----------|-------|-------|-----|--------|----------|



Rubberwood
UPL314

| | | | | | |
|------|-----|-----|--------------|--------|-------|
| 4.6" | 60" | 30" | TOP314-60x30 | 117 lb | \$740 |
|------|-----|-----|--------------|--------|-------|



DESK + TABLE FRAMES

Product Comparison: Adjustable Height Desk Frames

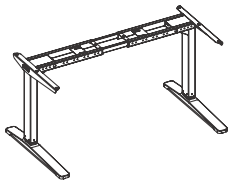
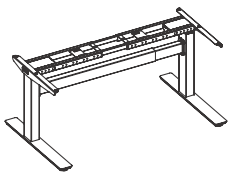
| | UPLIFT V2 Standing Desk Frame  | UPLIFT V2-Commercial Standing Desk Frame  |
|--|---|--|
| Price | \$439 | \$499 |
| Specifications | | |
| Height Range (without desktop) | 24.3"-49.9" | 21.6"-47.7" |
| Width Range | 41.3" min - 72.2" max | 41.3" min - 72.2" max |
| [Suggested] Desktop Width Range | 42" - 96" | 42" - 96" |
| [Suggested] Desktop Depth Range | 24" - 30" | 24" - 30" |
| Travel Speed | 1.57" per second | 1.57" per second |
| Weight Capacity | 355 lb | 355 lb |
| Control Box Input | 100-120Vac, 50/60Hz, 400W | 100-120Vac, 50/60Hz, 400W |
| 3-stage Lifting Columns | ✓ | ✓ |
| One-touch Control | ✓ | ✓ |
| Adjustable Width | ✓ | ✓ |
| C-Frame | ✓ | ✓ |
| T-Frame | ✓ | ✓ |
| 27" Feet Available | ✓ | ✓ |
| 24" Feet Available | ✓ | ✓ |
| Meets BIFMA X5.5-2014 Durability Standard | ✓ | ✓ |
| Meets BIFMA G1-2013 Height Standard | — | ✓ |
| Colors | Black, Gray, White, & Industrial Style | Black, Gray, White, & Industrial Style |

Product Comparison: Adjustable Height Desk Frames

| | UPLIFT V2 L-Shaped Standing Desk Frame  | UPLIFT V2-Commercial L-Shaped Standing Desk Frame  |
|--|--|---|
| Price | \$659 | \$749 |
| Specifications | | |
| Height Range (without desktop) | 24.3"-49.9" | 21.6"-47.7" |
| Width Range | 51.5" - 83" Left Side 43" - 74" Right Side | 51.5" - 83" Left Side 43" - 74" Right Side |
| [Suggested] Desktop Width Range | 60" - 96" Main desktop 48" - 60" Return desktop | 60" - 96" Main desktop 48" - 60" Return desktop |
| [Suggested] Desktop Depth Range | 24" - 30" | 24" - 30" |
| Travel Speed | 1.57" per second | 1.57" per second |
| Weight Capacity | 535 lb | 535 lb |
| Control Box Input | 100-120Vac, 50/60Hz, 500W | 100-120Vac, 50/60Hz, 500W |
| 3-stage Lifting Columns | ✓ | ✓ |
| One-touch Control | ✓ | ✓ |
| Adjustable Width | ✓ | ✓ |
| C-Frame | ✓ | ✓ |
| T-Frame | — | — |
| 27" Feet Available | ✓ | ✓ |
| 24" Feet Available | ✓ | ✓ |
| Meets BIFMA X5.5-2014 Durability Standard | ✓ | ✓ |
| Meets BIFMA G1-2013 Height Standard | — | ✓ |
| Colors | Black, Gray, White, & Industrial Style | Black, Gray, White, & Industrial Style |

Product Comparison: Adjustable Height Desk Frames

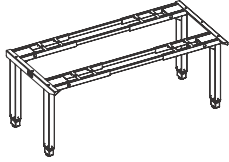
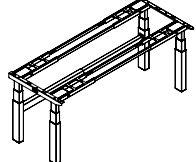
| | UPLIFT V2 4-Leg Standing Desk Frame  | UPLIFT V2-Commercial 4-Leg Standing Desk Frame  |
|--|---|--|
| Price | \$879 | \$999 |
| Specifications | | |
| Height Range (without desktop) | 24.3"-49.9" | 21.6"-47.7" |
| Width Range | 41.3" min - 72.2" max | 41.3" min - 72.2" max |
| [Suggested] Desktop Width Range | 48" - 108" | 48" - 108" |
| [Suggested] Desktop Depth Range | 24" - 60" | 24" - 60" |
| Travel Speed | 1.57" per second | 1.57" per second |
| Weight Capacity | 535 lb | 535 lb |
| Control Box Input | 100-120Vac, 50/60Hz, 600W | 100-120Vac, 50/60Hz, 600W |
| 3-stage Lifting Columns | ✓ | ✓ |
| One-touch Control | ✓ | ✓ |
| Adjustable Width | ✓ | ✓ |
| C-Frame | – | – |
| T-Frame | – | – |
| 27" Feet Available | – | – |
| 24" Feet Available | – | – |
| Meets BIFMA X5.5-2014 Durability Standard | ✓ | ✓ |
| Meets BIFMA G1-2013 Height Standard | – | ✓ |
| Colors | Black, Gray, White, & Industrial Style | Black, Gray, White, & Industrial Style |

UPLIFT V2 Standing Desk Frame

The [UPLIFT V2 Standing Desk Frame](#) boasts a carrying capacity of 355 lb, sturdy steel construction, and cast-aluminum feet. C-shaped and T-shaped feet are available for desks with desktops 30" and deeper, while shorter C-shaped feet are also available for desks with desktops 24" deep. C-shaped feet allow more room for accessories. This three-stage frame delivers 25.6" of height adjustment and is 33% faster to adjust than a two-stage frame

This frame features dual soft start/stop motors (one in each leg), an energy-efficient low-draw transformer, and a control box with collision detection for safety. A telescoping upper crossbar is positioned directly where the base meets the desktop. The frame adjusts to fit desktops from 42"-80" wide and 24"-30" deep. The patent-pending accessory mounting point system allows for quick and sturdy attachment of our exclusive desk accessories without the need to drill holes into your desktop.

Specifications

[See complete spec sheet here](#)

- Height Range: 24.5" - 50.1" H
- Travel Speed: 1.57" per second
- Noise Level: 50 decibels during motion
- Frame Width: 41.3" min - 72.2" max
- Weight Capacity: 355 lb
- Control Box Input: 100-120Vac, 50/60Hz, 400W

Colors

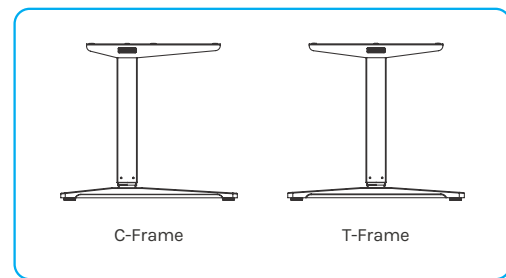
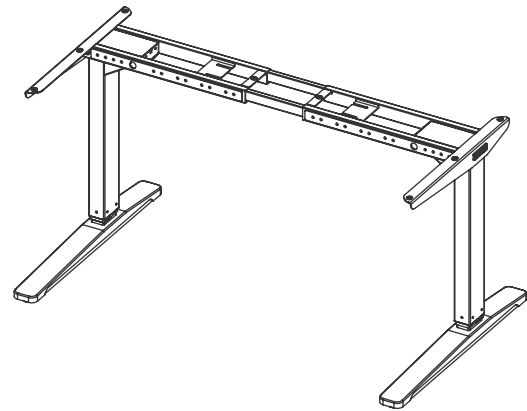
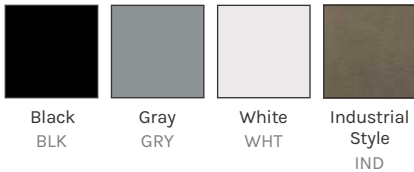

Pictured: C-Frame and T-Frame Frame Styles

Only C-Frames are available in 24" foot style

A GUIDE TO THE UPLIFT V2 Standing Desk Frame SKU

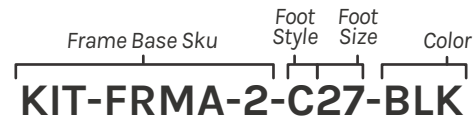

This example is for a black UPLIFT V2 Standing Desk C-Frame with 27" feet.

| | Additional Information | Foot Style & Size | SKU | Weight | \$ Price |
|--|---|-------------------|--------------------|-------------|----------|
| | • Meets BIFMA X5.5-2014 Durability Standard | C-Frame, 27" feet | KIT-FRMA-2-C27-XXX | 55 lb 10 oz | \$549 |
| | • Available in Black, White, Gray, and Industrial Style | C-Frame, 24" feet | KIT-FRMA-2-C24-XXX | 55 lb 10 oz | \$549 |
| | | T-Frame, 27" feet | KIT-FRMA-2-T27-XXX | 55 lb 10 oz | \$499 |

UPLIFT V2-Commercial Standing Desk Frame

The [UPLIFT V2-Commercial Standing Desk Frame](#) has a height range of 22.6" - 48.7" (with a 1" desktop installed) and a lifting capacity of 355 lb. C-shaped and T-shaped feet are available for desks with desktops 30" and deeper, while shorter C-shaped feet are also available for desks with desktops 24" deep. C-shaped feet allow more room for accessories.

This frame has a lower starting height, a lower max height, and a broader overall height-adjustment range, compared to the UPLIFT V2 Frame. We designed this frame to meet the ANSI/BIFMA G1-2013 height standard.

Because of its greater height adjustment range, we added a lower crossbar for increased stability. The UPLIFT V2-Commercial Frame supports ergonomic working postures in both seated and standing positions. The patent-pending accessory mounting point system allows for quick and sturdy attachment of our exclusive desk accessories without the need to drill holes into your desktop.

Specifications

[See complete spec sheet here](#)

- Height Range: 21.6" - 47.7" H
- Travel Speed: 1.57" per second
- Noise Level: 50 decibels during motion
- Frame Width: 41.3" min - 72.2" max
- Weight Capacity: 355 lb
- Control Box Input: 100-120Vac, 50/60Hz, 400W

Colors

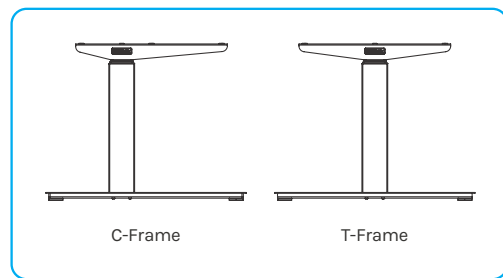
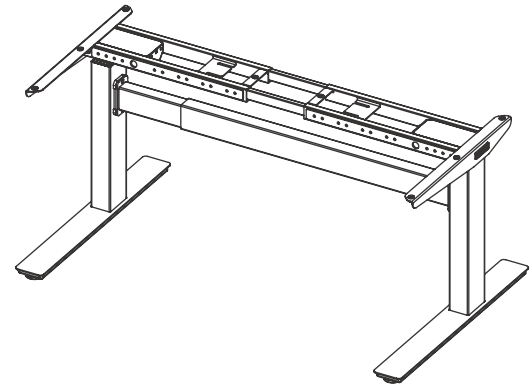

Pictured: C-Frame and T-Frame Frame Styles
Only C-Frames are available in 24" foot style

A GUIDE TO THE UPLIFT V2-Commercial Standing Desk Frame SKU

Frame Base SKU
Foot Style
Foot Size
Color
KIT-FRMA-2-COM-C27-BLK

This example is for a black UPLIFT V2-Commercial Standing Desk C-Frame with 27" feet.

| | Additional Information | Foot Style & Size | SKU | Weight | \$ Price |
|--|--|-------------------|------------------------|-------------|----------|
| | <ul style="list-style-type: none"> • Meets BIFMA G1-2013 Height Standard | C-Frame, 27" feet | KIT-FRMA-2-COM-C27-XXX | 55 lb 10 oz | \$569 |
| | | C-Frame, 24" feet | KIT-FRMA-2-COM-C24-XXX | 55 lb 10 oz | \$569 |
| | <ul style="list-style-type: none"> • Meets BIFMA X5.5-2014 Durability Standard • Available in Black, White, Gray, and Industrial Style | T-Frame, 27" feet | KIT-FRMA-2-COM-T27-XXX | 55 lb 10 oz | \$529 |

UPLIFT V2 L-Shaped Standing Desk Frame

The [UPLIFT V2 L-Shaped Standing Desk Frame](#) comes with two C-shaped feet and one upright support leg for a setup that can be configured based on the user's needs. The width-adjustable frame supports larger desktops and lets users build an L-shaped workstation. The electric three-stage frame is 33% faster than a two-stage frame, delivers 25.6" of height adjustment, and boasts a carrying capacity of over 535 lb.

The frame comes with a whisper-quiet, soft start/stop motor in each leg, an energy-efficient low-draw transformer, and a control box with collision detection for safety. The patent-pending accessory mounting point system allows for quick and sturdy attachment of our exclusive desk accessories without the need to drill holes into your desktop.

Specifications

[See complete spec sheet here](#)

- Height Range: 24.3" - 49.9" H
- Travel Speed: 1.57" per second
- Noise Level: 50 decibels during motion
- Frame Width: 51.5" - 83" Left Side
43" - 74" Right Side
- Weight Capacity: 535 lb
- Control Box Input: 100-120Vac, 50/60Hz, 500W

Colors

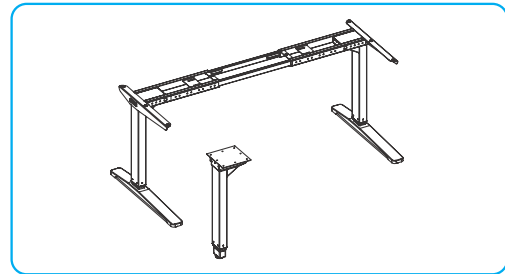
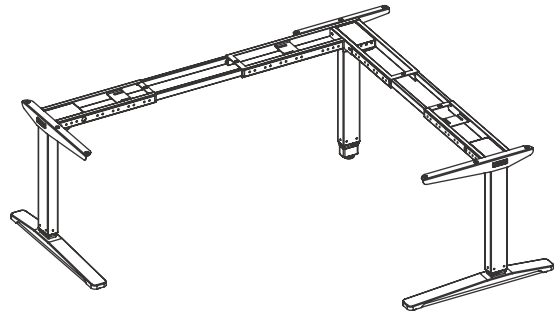

Pictured: Alternative 3-Leg Configuration

A GUIDE TO THE UPLIFT V2 L-Shaped Standing Desk Frame SKU

Frame Base Sku
Foot Style
Foot Size
Color
KIT-FRMA-3-C27-BLK

This example is for a black UPLIFT V2 L-Shaped Standing Desk C-Frame with 27" feet.

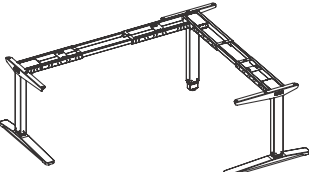
| | Additional Information | Foot Style & Size | SKU | Weight | \$ Price |
|---|---|-------------------|--------------------|---------|----------|
|  | • Meets BIFMA X5.5-2014 Durability Standard | C-Frame, 27" feet | KIT-FRMA-3-C27-XXX | 90.4 lb | \$819 |
| | • Available in Black, White, Gray, and Industrial Style | C-Frame, 24" feet | KIT-FRMA-3-C24-XXX | 90.4 lb | \$819 |

UPLIFT V2-Commercial L-Shaped Standing Desk Frame

The [UPLIFT V2-Commercial L-Shaped Standing Desk Frame](#) comes with two C-shaped feet and one upright support leg. It has a height range of 22.6" - 48.7" (with a 1" desktop installed) and a lifting capacity of 535 lb. This frame has a lower starting height, a lower max height, and a broader overall height-adjustment range, compared to the UPLIFT V2 Frame. We designed this frame to meet the ANSI/BIFMA G1-2013 height standard. Due to the mechanics of designing the frame with a greater height adjustment range, we added a lower crossbar for increased stability.

The UPLIFT V2-Commercial L-Shaped Standing Desk Frame supports ergonomic working postures in both seated and standing positions. The patent-pending accessory mounting point system allows for quick and sturdy attachment of our exclusive desk accessories without the need to drill holes into your desktop.

Specifications

[See complete spec sheet here](#)

- Height Range: 21.6" - 47.7" H
- Travel Speed: 1.57" per second
- Noise Level: 50 decibels during motion
- Frame Width: 51.5" - 83" Left Side
43" - 74" Right Side
- Weight Capacity: 535 lb
- Control Box Input: 100-120Vac, 50/60Hz, 500W

Colors

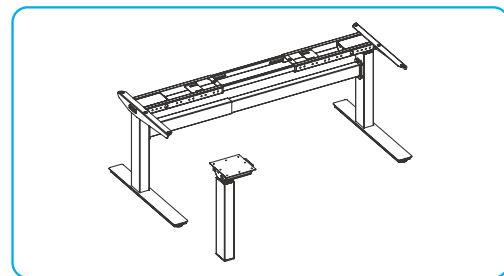
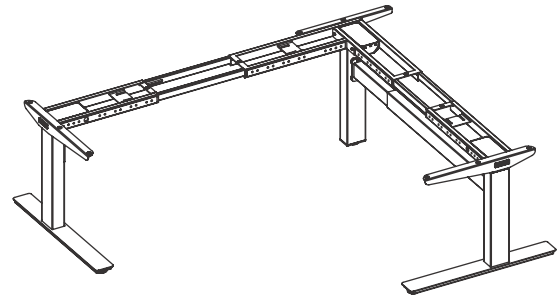
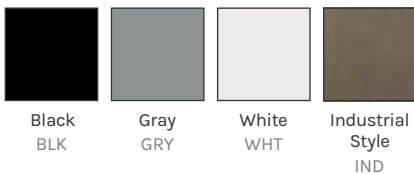

Pictured: Alternative 3-Leg Configuration

A GUIDE TO THE UPLIFT V2-Commercial L-Shaped Standing Desk Frame SKU

Frame Base SKU
Foot Style
Foot Size
Color
KIT-FRMA-3-COM-C27-BLK

This example is for a black UPLIFT V2-Commercial L-Shaped Standing Desk C-Frame with 27" feet.

| | Additional Information | Foot Style & Size | SKU | Weight | \$ Price |
|--|---|-------------------|------------------------|---------|----------|
| | • Meets BIFMA G1-2013 Height Standard | C-Frame, 27" feet | KIT-FRMA-3-COM-C27-XXX | 90.4 lb | \$918 |
| | • Meets BIFMA X5.5-2014 Durability Standard | C-Frame, 24" feet | KIT-FRMA-3-COM-C24-XXX | 90.4 lb | \$918 |
| | • Available in Black, White, Gray, and Industrial Style | | | | |

UPLIFT V2 4-Leg Standing Desk Frame

The [UPLIFT V2 4-Leg Standing Desk Frame](#) features 25.6" of height adjustment and boasts a 535 lb lifting capacity. A three-stage frame design provides an expanded height adjustment range and is 33% faster to adjust than two-stage frames. Frames come with a low-draw power transformer that uses little electricity, and a single control box includes collision detection functionality for safety.

A quad-leg design delivers optimal desk stability at any height and includes four upper crossbars to support more massive desk setups.

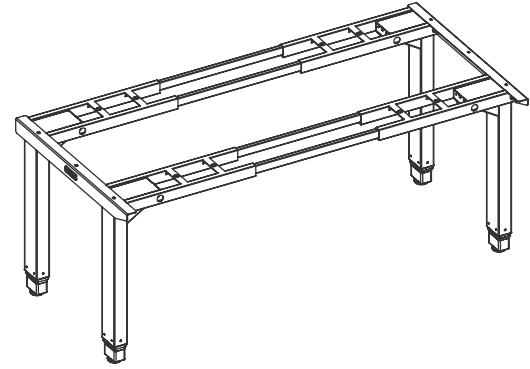

Specifications

[See complete spec sheet here](#)

- Height Range: 24.3" - 49.9" H
- Travel Speed: 1.57" per second
- Noise Level: 50 decibels during motion
- Frame Width: 41.3" min - 72.2" max
- Weight Capacity: 535 lb
- Control Box Input: 100-120Vac, 50/60Hz, 600W

Colors



A GUIDE TO THE

UPLIFT V2 4-Leg Standing Desk Frame SKU

Frame Base SKU
Color
KIT-FRMA-4-BLK

This example is for a black UPLIFT V2 4-Leg Standing Desk Frame.

Additional Information

SKU

Weight

\$ Price

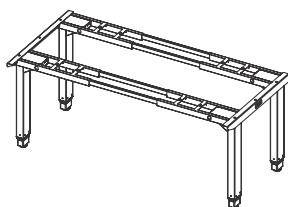

- Meets BIFMA X5.5-2014 Durability Standard
- Available in Black, White, Gray, and Industrial Style

KIT-FRMA-4-XXX

107.4 lb

\$1019

UPLIFT V2-Commercial 4-Leg Standing Desk Frame

The [UPLIFT V2-Commercial 4-Leg Standing Desk Frame](#) was created to provide a seated and standing height range that's ergonomically suitable for 95% of office workers. With a height range of 22.6" - 48.7" you have 26.1" of available adjustments. This frame (with a 1" thick desktop) meets the ANSI/BIFMA G1-2013 height standard requirements.

The legs have a 35% larger cross sectional area to improve stability, which is further reinforced by a single, lower crossbar. With a 535 lb lifting capacity, you'll have enough power to handle the toughest tasks.

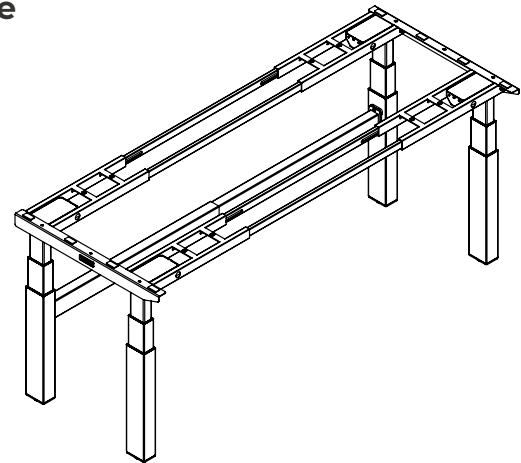

Specifications

[See complete spec sheet here](#)

- Height Range: 21.6" - 47.7" H
- Travel Speed: 1.57" per second
- Noise Level: 50 decibels during motion
- Frame Width: 41.3" min - 72.2" max
- Weight Capacity: 535 lb
- Control Box Input: 100-120Vac, 50/60Hz, 600W

Colors



A GUIDE TO THE UPLIFT V2-Commercial 4-Leg Standing Desk Frame SKU

Frame Base SKU
Color
KIT-FRMA-4-COM-BLK

This example is for a black UPLIFT V2-Commercial 4-Leg Standing Desk Frame.

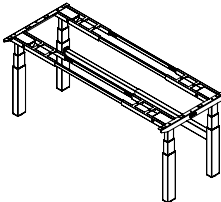
| | Additional Information | SKU | Weight | \$ Price |
|---|---|--------------------|----------|----------|
|  | <ul style="list-style-type: none"> • Meets BIFMA G1-2013 Height Standard • Meets BIFMA X5.5-2014 Durability Standard • Available in Black, White, Gray, and Industrial Style | KIT-FRMA-4-COM-XXX | 107.4 lb | \$1168 |

Product Comparison: Frames - Side Table Frames

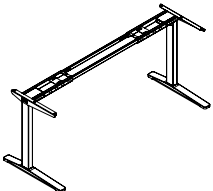
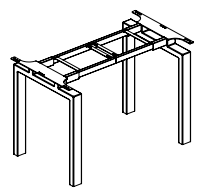
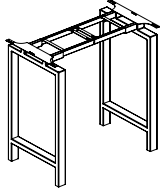
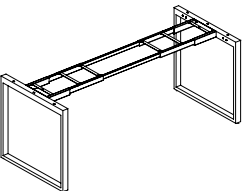
| | 2-Leg Seated Height Side Table Frame | 4-Leg Seated Height Side Table Frame | 4-Leg Standing Height Side Table Frame | O-Leg Seated Height Side Table Frame |
|---------------------------------|---|---|---|---|
| |  |  |  |  |
| Price | \$169 | \$169 | \$199 | \$169 |
| Specifications | | | | |
| Height Range (without desktop) | 28" H | 28" H | 41" H | 28" H |
| Width Range | 41.3" - 72.2" W | 40.9" - 72" W | 40.9" - 72" W | 42" - 80" W |
| [Suggested] Desktop Width Range | 42" - 80" | 42" - 80" | 42" - 80" | 42" - 80" |
| Weight Capacity | 355 lb | 355 lb | 355 lb | 355 lb |
| Adjustable Width | ✓ | ✓ | ✓ | ✓ |
| Colors | Black, Gray, White, & Industrial Style | Black, Gray, White, & Industrial Style | Black, Gray, White, & Industrial Style | Black, Gray, White, & Industrial Style |

2-Leg Seated Height Side Table Frame

The [2-Leg Seated Height Side Table Frame](#) can be used as a matching accent table to an UPLIFT Desk, or as a desk on its own. Frame comes with 28" of height to the underside of desktops and allows users extra room to store large or rarely used office supplies and decor and perform short duration tasks while seated.

The frame can pair with any UPLIFT Desktop to create a fixed-height desk, and comes in our standard frame colors to match UPLIFT Desks. The patent-pending accessory mounting point system allows for quick and sturdy attachment of our exclusive desk accessories without the need to drill holes into your desktop.

Specifications

[See complete spec sheet here](#)

- Width: 41.3" - 72.2" W
- Height: 29" H with 1" thick desktop
- Depth: 27.6" D
- Levelers: 0.375" adjustment
- Weight Capacity: 355 lb

Colors

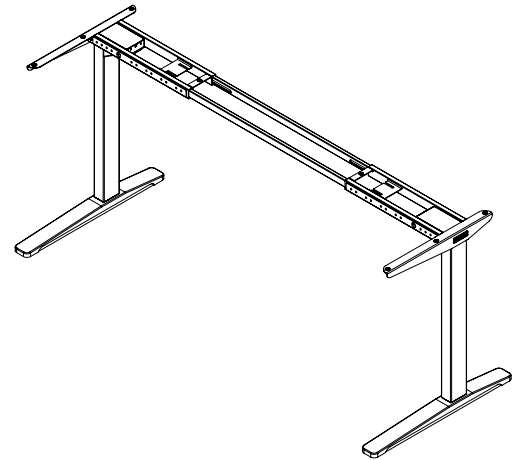

A GUIDE TO THE 2-Leg Seated Height Side Table Frame SKU

Frame Base SKU Color
FRMA-2-SRD-FIX-BLK

This example is for a black 2-Leg Seated Height Side Table Frame.

Additional Information

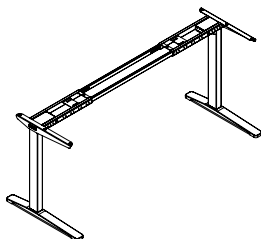

- Finish: Powder-coat paint
- Material: Steel
- Available in Black, White, Gray, and Industrial Style

SKU

FRMA-2-SRD-FIX

Weight

32.8 lb

\$ Price

\$169

4-Leg Seated Height Side Table Frame

The [4-Leg Seated Height Side Table Frame](#) allows users to build a matching fixed-height side table for their standing desk, giving them more room to store items like printers and personal items.

The frame can pair with any UPLIFT Desktop to create a fixed-height desk, and comes in our standard frame colors to match UPLIFT Desks.

Specifications

[See complete spec sheet here](#)

- Width: 40.9" - 72" W
- Height: 29" H with 1" thick desktop
- Levelers: 0.375" adjustment
- Weight Capacity: 355 lb

Colors

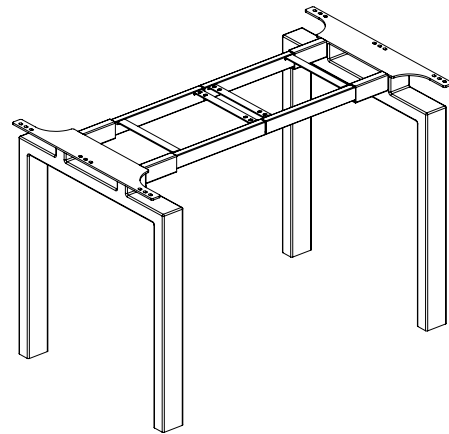

A GUIDE TO THE 4-Leg Seated Height Side Table Frame SKU

Frame Base SKU Color
FRM411-BLK

This example is for a black 4-Leg Seated Height Side Table Frame.

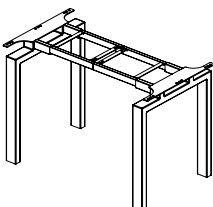
| | Additional Information | SKU | Weight | \$ Price |
|---|---|------------|--------|----------|
|  | <ul style="list-style-type: none"> • Finish: Powder-coat paint • Material: Steel • Available in Black, White, Gray, and Industrial Style | FRM411-XXX | 48 lb | \$169 |

4-Leg Standing Height Side Table Frame

The [4-Leg Standing Height Side Table Frame](#) lets users build a matching fixed-height side table to supplement desk space at sit-stand workstations. The frame rests at a comfortable standing height for most users at 42 inches tall; this provides plenty of extra space for housing devices and accessories that don't need to be stationed on the user's primary work area.

The frame can pair with any UPLIFT Desktop to create a fixed-height desk, and comes in our standard frame colors to match UPLIFT Desks.

Specifications

[See complete spec sheet here](#)

- Width: 40.9" - 72" W
- Height: 42" H with 1" thick desktop
- Levelers: 0.375" adjustment
- Weight Capacity: 355 lb

Colors

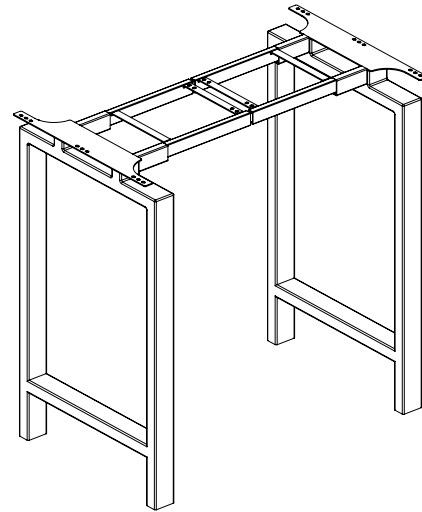

A GUIDE TO THE 4-Leg Seated Height Side Table Frame SKU

Frame Base SKU Color
FRM413-BLK

This example is for a black 4-Leg Standing Height Side Table Frame.

Additional Information

SKU

Weight

\$ Price

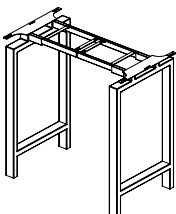

- Finish: Powder-coated paint
- Material: Steel
- Available in Black, White, Gray, and Industrial Style

FRM413-XXX

60 lb

\$199

O-Leg Seated Height Side Table Frame

Our [O-Leg Seated Height Side Table Frame](#) not only provides the perfect home for your favorite office accessories; it is also an ideal companion to our UPLIFT V2 Standing Desk, giving you options to match your frame and desktop.

Plus, with its fixed standing height boasting many of the same ergonomic health benefits as a height-adjustable desk, you can even use it as a personal standing desk for short periods of time.

Specifications

[See complete spec sheet here](#)

- Width: 42" - 80" W
- Height: 29" H with 1" thick desktop
- Levelers: 0.375" adjustment
- Weight Capacity: 355 lb

Colors

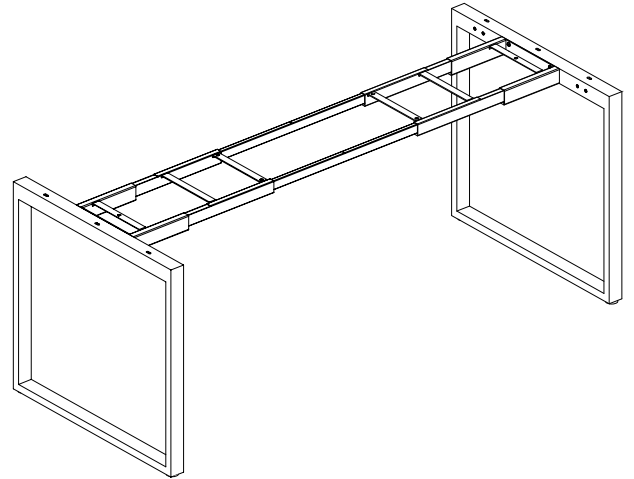

A GUIDE TO THE O-Leg Seated Height Table Frame SKU

Frame Base SKU Color
FRM405-BLK

This example is for a black 4-Leg Standing Height Side Table Frame.

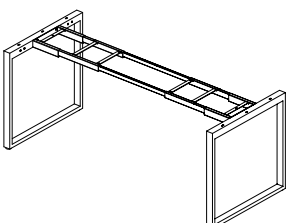
| | Additional Information | SKU | Weight | \$ Price |
|---|--|--------|---------|----------|
|  | <ul style="list-style-type: none"> • Material: Steel • Available in Black, White, Gray, and Industrial Style | FRM405 | 55.5 lb | \$ 169 |

UPLIFT Coffee Table Legs

Whether you're looking for a contemporary or a modern-meets-rustic look, the powder-coated [UPLIFT Coffee Table Legs](#) are endlessly versatile and work with any interior style, wood types, and colors.

These heavy duty, steel legs are ready to turn an old tabletop, reclaimed wood planks, or salvaged wood slab into the coffee table of your dreams.

Our Coffee Table Legs are compatible with all UPLIFT Desk rectangular 24" and 30" deep desktops. We also offer multiple lengths (42" through 80"), making it easy to build your coffee table to fit your space.

Specifications

[See complete spec sheet here](#)

- Dimension: 16.3" H x 22" W x 2.6" D (leg depth)
- Material: 6mm Q235 Steel
- Finish: Black Powder Coat

Colors



Black
BLK

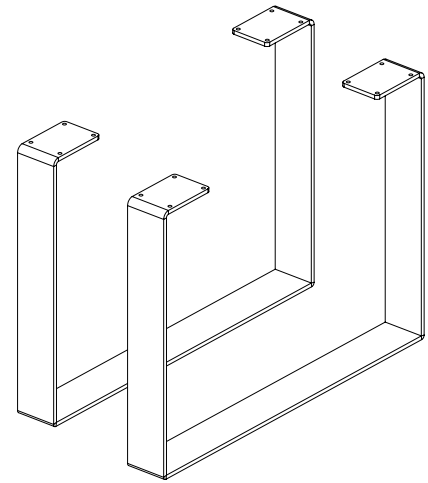

A GUIDE TO THE UPLIFT Coffee Table Legs SKU

Frame Base SKU Color
FRM404-BLK

This example is for a black Coffee Table Legs.

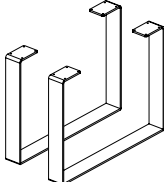
| | Additional Information | SKU | Weight | \$ Price |
|---|---|------------|--------|----------|
|  | <ul style="list-style-type: none"> • Add your own top • Easy to install • Steel legs • Available in Black | FRM404-BLK | 21 lb | \$109 |

Standing Desk Keypads

Basic Keypad



- Electric keypad with up/down settings
- Includes control box connecting wire
- For use with any UPLIFT Desk

SKU

\$ Price

FRM002

\$25

Advanced Memory Keypad

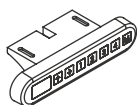

- Easily store up to 4 height presets
- Programmable for customization (see instructions)
- LED display shows desk height
- Toggle between one-touch and constant-touch settings
- Compatible with any UPLIFT Desk
- Includes control box connecting wire

FRM001

\$39

Advanced Comfort Keypad

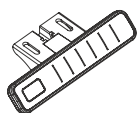

- Soft-touch face with raised dividers between buttons
- Easily store up to 4 height presets
- Programmable for customization (see instructions)
- LED display shows desk height
- Toggle between one-touch and constant-touch settings
- Compatible with any UPLIFT Desk
- Includes control box connecting wire

FRM066

\$49

Advanced Paddle Keypad

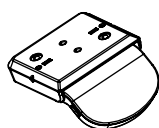

- Quick height adjustment without looking at keypad
- Movement reminder feature
- Programmable for customization
- Intuitive display and menu
- Compatible with any UPLIFT Desk
- Includes control box connecting wire
- Mounting adapter plate included

FRM055

\$79

Standing Desk Parts

UPLIFT V2 Standing Desk Frame Leg

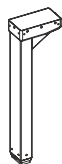

FRM058-R-3-650/560

\$250

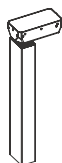

UPLIFT V2-Commercial Standing Desk Frame Leg



FRM058-S-3-667/530

\$250

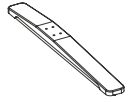
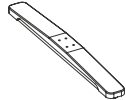
V2 Frame Parts

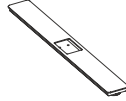
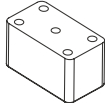
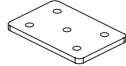
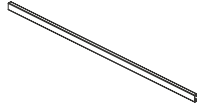
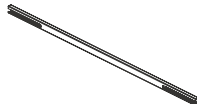
| UPLIFT V2 Standing Desk Frame C-Foot | Length | SKU | \$ Price |
|---|--------|----------|----------|
|  | 23.6" | PRT00001 | \$50 |
| | | PRT00002 | \$55 |
| UPLIFT V2 Standing Desk Frame T-Foot | | | |
|  | 27.6" | PRT00003 | \$55 |
| | | | |
| UPLIFT V2-Commercial Standing Desk Frame C-Foot | | | |
|  | 23.6" | PRT00004 | \$50 |
| | | PRT00005 | \$55 |
| UPLIFT V2-Commercial Standing Desk Frame T-Foot | | | |
|  | 27.6" | PRT00006 | \$55 |
| | | | |
| UPLIFT V2 Standing Desk Frame Peg Foot | | | |
|  | | PRT00007 | \$30 |
| | | | |
| UPLIFT V2-Commercial Standing Desk Frame Peg Foot | | | |
|  | | PRT00008 | \$30 |
| | | | |
| Upper Crossbar | | | |
|  | | PRT00010 | \$34 |
| | | | |
| Open End Upper Crossbar for L-Shaped UPLIFT Desks | | | |
|  | | PRT00011 | \$34 |
| | | | |

V2 Frame Parts

Lower Crossbar for UPLIFT V2-Commercial Standing Desks

SKU

\$ Price



PRT00022

\$89

Zero Crossbar Bracket

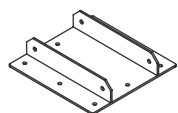

PRT00024

\$50

Crossbar End for 2-Leg & 3-Leg UPLIFT Desks

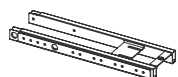

PRT00009

\$54

Short Corner Crossbar End for L-Shaped UPLIFT Desks

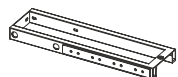

PRT00016

\$54

Long Corner Crossbar End for L-Shaped UPLIFT Desks

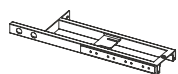

PRT00015

\$54

Crossbar End for 4-Leg UPLIFT Desks

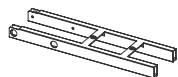

PRT00025

\$54

UPLIFT V2 Conference Table Support Bracket



PRT00036

\$30

V2 Frame Parts

| Side Bracket for C-Frame Desks | Side | SKU | \$ Price |
|---|-------|------------|----------|
|  | Left | PRT00018-L | \$38 |
| | Right | PRT00018-R | \$38 |

| Side Bracket for T-Frame Desks | SKU | \$ Price |
|---|----------|----------|
|  | PRT00014 | \$38 |

| Corner Side Bracket for L-Shaped UPLIFT Desks | SKU | \$ Price |
|---|----------|----------|
|  | PRT00028 | \$38 |

| Side Bracket for UPLIFT V2 4-Leg Standing Desk Frame | Side | SKU | \$ Price |
|---|-------|------------|----------|
|  | Left | PRT00012-L | \$48 |
| | Right | PRT00012-R | \$48 |

| Conference Table Side Bracket | SKU | \$ Price |
|---|----------|----------|
|  | PRT00027 | \$58 |

| Connector Cable | Length | SKU | \$ Price |
|---|------------|----------|----------|
|  | 1.3 m | PRT00111 | \$10 |
| | 2.5m | PRT00112 | \$10 |
| | 1.3 m, 90° | PRT00113 | \$10 |

| Power Cable | Prong Count | SKU | \$ Price |
|---|-------------|----------|----------|
|  | 3 | PRT00114 | \$10 |
| | 2 | PRT00115 | \$10 |

V2 Frame Parts

| Control Box for UPLIFT V2 Standing Desk Frame | Legs | SKU | \$ Price |
|---|------|----------|----------|
|  | 2 | FRM053-2 | \$90 |
| | 3 | FRM053-3 | \$120 |
| | 4 | FRM053-4 | \$130 |

Control Box for UPLIFT V2-Commercial Standing Desk Frame

| | | | |
|---|---|--------------|-------|
|  | 2 | FRM053-2-COM | \$90 |
| | 3 | FRM053-3-COM | \$120 |
| | 4 | FRM053-4-COM | \$130 |

Connect Dongle

| | | | |
|---|--|--------|------|
|  | | FRM025 | \$39 |
|---|--|--------|------|

Casters + Glides

Leveling Glide for UPLIFT V2 Standing Desk Frame

| | | | |
|---|--|----------|------|
|  | | PRT00046 | \$29 |
|---|--|----------|------|

Leveling Glide UPLIFT V2-Commercial Standing Desk Frame

| | | | |
|---|--|----------|------|
|  | | PRT00047 | \$29 |
|---|--|----------|------|

Desk Casters

| | | | |
|---|---|--------|------|
|  | 2 | ACC020 | \$59 |
| | 3 | ACC020 | \$79 |
| | 4 | ACC020 | \$59 |

Heavy Duty Locking Caster

| | | | |
|---|---|--------|-------|
|  | 2 | ACC035 | \$89 |
| | 3 | ACC035 | \$109 |
| | 4 | ACC035 | \$89 |

Soft Roll Desk Casters

| | | | |
|---|---|--------|------|
|  | 2 | ACC065 | \$79 |
| | 3 | ACC065 | \$99 |
| | 4 | ACC065 | \$79 |

Desk Benching System (For V2 Desks)

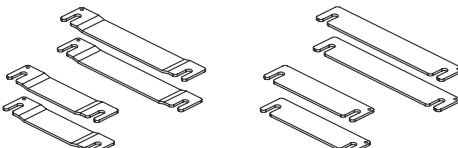
| End Bracket | Frame | Desktop Length | SKU | \$ Price |
|---|---------|----------------|----------|----------|
|  | v2 | 24" | PRT00117 | \$30 |
| | v2 | 30" | PRT00119 | \$30 |
| | v2-comm | 24" | PRT00116 | \$40 |
| | v2-comm | 30" | PRT00118 | \$45 |

*Pack of 2 Per Size.

Support Bracket

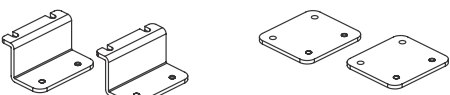
| | | | | |
|---|---------|--|----------|------|
|  | v2 | | PRT00125 | \$40 |
| | v2-comm | | PRT00124 | \$35 |

*Pack of 2 Per Size.

Single Row Main Bracket

| | | | | |
|---|----------------|--|----------|------|
|  | v2 and v2-comm | | PRT00123 | \$30 |
|---|----------------|--|----------|------|

Main Bracket

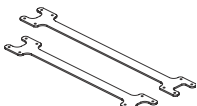
| | | | | |
|---|----------------|-----|----------|------|
|  | v2 and v2-comm | 24" | PRT00120 | \$60 |
| | v2 and v2-comm | 30" | PRT00121 | \$65 |

Main Bracket for 120 Degree Standing Desks

| | | | | |
|---|----|--|----------|------|
|  | v2 | | PRT00122 | \$65 |
|---|----|--|----------|------|

120 Degree Desk Kit

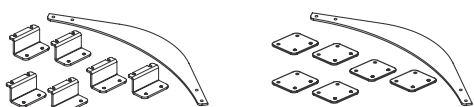
| | | | | |
|---|---------|--|------------------------------|------|
|  | v2 | | KIT-FRM028-COM-XXX-BTB-2DESK | \$99 |
| | v2-comm | | KIT-FRM028-COM-XXX-BTB-2DESK | \$99 |

3-Pack: 120 Degree Desks Kit

| | | | | |
|---|--|--|------------------|-------|
|  | | | KIT-FRM018-XXX-4 | \$198 |
|---|--|--|------------------|-------|

Desk Benching System (For V2 Desks)

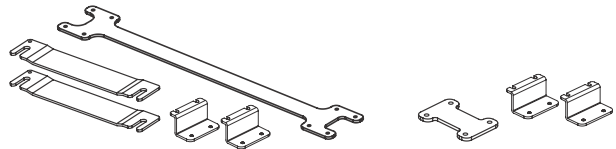
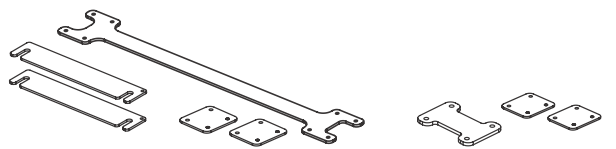
| UPLIFT V2-Standard - Benching Kit | Dual or Single | SKU | \$ Price |
|--|----------------|------------------------------|----------|
|  | Dual | KIT-FRM028-SRD-XXX-BTB-2DESK | \$99 |
| | Single | KIT-FRM028-SRD-XXX-SBS-2DESK | \$99 |
| UPLIFT V2-Commercial - Benching Kit | Dual | KIT-FRM028-COM-XXX-BTB-2DESK | \$99 |
|  | Single | KIT-FRM028-COM-XXX-SBS-2DESK | \$99 |



STANDING DESK CONVERTERS

Product Comparison: Standing Desk Converters

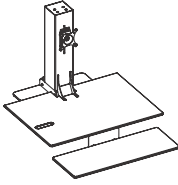
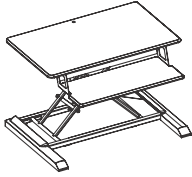
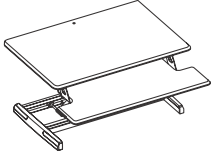
| | E7 Electric Standing Desk Converter  | ATX Standing Desk Converter  | Lady Bird Standing Desk Converter  |
|--|--|---|--|
| Price | \$399 | \$289 | \$199 |
| Type | Electric | Pneumatic | Pneumatic |
| Mounting Options | | | |
| Clamp Mount | ✓ | – | – |
| Bolt-thru Mount | – | – | – |
| Freestanding | ✓ | ✓ | ✓ |
| Standout Feature | Adjusts entire workspace electronically with push of a button | Arrives fully assembled and includes built-in wire management | Height is infinitely adjustable within converters range |
| Warranty | 15 years | 15 years | 15 years |
| SKU | UDA115 | UDA123 | UDA124 |
| Features | | | |
| Multiple Sizes | – | – | – |
| Weight Capacity | 110 lb | 39.6 lb | 33 lb |
| Height Adjustable Range | 21" | 18.3" | 12" |
| Worksurface Dimensions | 30" W x 21.5" D | 35.4" W x 20.8" D | 29.7" W x 19.7" D |
| Keyboard Tray | ✓ | ✓ | ✓ |
| Keyboard Tray Dimensions | 28" W x 10.5" D | 28.1" W x 11.25" D | 29.7" W x 12.4" D |
| Comes with monitor mount | Dual or Tripple Add-On Accessory | – | – |
| VESA Compatibility | 100 x 100 mm & 75 x 75 mm | | – |
| Keyboard Tray Adjusts Below Desk | ✓ | – | – |
| Meets ANSI/BIFMA X5.5-2014 Durability Standard Sections 5.3, 5.5, and 16. | Yes | Yes | Yes |
| Compatible w/ Monitor Arms | ✓ | ✓ | ✓ |
| Worksurface Color/Material | Bamboo, Rubberwood, Black Eco, White Eco | Black & White MDF | Black MDF |
| Base Finish | Black or White | Black or White | Black |

Product Comparison: Standing Desk Converters

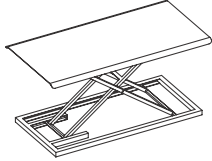
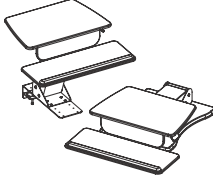
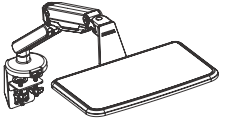
| | E3 Compact Stand Up Desk Converter  | Standing Desk Converter - Riser or Clamp  | UPLIFT Adapt Mobile Laptop Standing Converter  |
|--|---|--|--|
| Price | \$129 | \$219 | \$199 |
| Type | Pneumatic | Pneumatic | Pneumatic |
| Mounting Options | | | |
| Clamp Mount | ✓ | ✓ | ✓ |
| Bolt-thru Mount | – | – | ✓ |
| Freestand | ✓ | ✓ | – |
| Standout Feature | Brings ergonomics to places like kitchens and craft rooms | Clamp mount option lowers keyboard tray below desk level for ideal posture | Allows users to move and pose laptops like they would a monitor arm |
| Warranty | 15 years | 15 years | 15 years |
| SKU | UDA121 | UDA100 | UDA120 |
| Features | | | |
| Multiple Sizes | – | – | – |
| Weight Capacity | 11 lb | 28.6 lb | 15.4 lb |
| Height Adjustable Range | 15.8" | Riser: 16.7" Clamp: 17" | 16.25" |
| Worksurface Dimensions | 26.8" W x 13.4" D | 23.6" W x 15.7" D | 18.3" W x 11.5" D |
| Keyboard Tray | – | ✓ | |
| Keyboard Tray Dimensions | | 27" W x 10.5" D | |
| Comes with monitor mount | | | |
| VESA Compatibility | | | |
| Keyboard Tray Adjusts Below Desk | | ✓ | |
| Meets ANSI/BIFMA X5.5-2014 Durability Standard Sections 5.3, 5.5, and 16. | No | No | No |
| Compatible w/ Monitor Arms | | | |
| Worksurface Color/Material | Black & White Steel | Black MDF | Black, & Gray |
| Base Finish | Black & White | Black | Black, & Gray |

E7 Electric Standing Desk Converter

The [E7 Electric Standing Desk Converter](#) is an electric standing desk converter that adjusts with the push of a button. Choose from our selection of desktop styles and base colors to make it your own. You need the E7 Electric Standing Desk Converter, the smart electric standing desk converter that's delivering a sit-stand solution to fixed height workspaces everywhere.

Features

- One-touch adjustable control
- Built-in Memory Keypad allows for height presets
- Detachable, tiered keyboard tray holds both keyboard and mouse pad
- Fixed-height keyboard tray lowers below desk level
- Four desktop styles and two base colors to choose from
- Single monitor mount included. Dual mount sold separately

Specifications

[See complete spec sheet here](#)

- Desktop: 30" W x 21.5" D x 0.75" thick
- Keyboard Tray: 28" W x 10.5" D x 0.75" thick
- Height Range: 23" H (from desk level)
- Weight Capacity: 110 lb
- Dimensions: 26.8" W x 13.4" D
- VESA Mount: 100 x 100 mm & 75 x 75 mm
- Weight Capacity: 17.6 lb per mount

*For monitors 28" or smaller

Surface Style

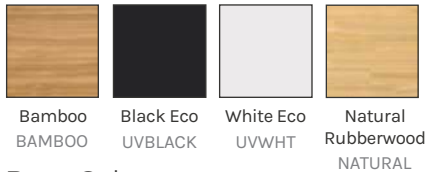

Base Color

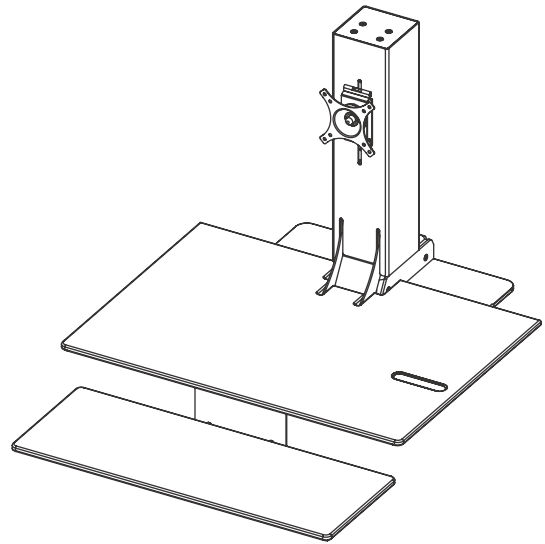

A GUIDE TO THE E7 Electric Standing Desk Converter SKU

Converter Base SKU Surface Style Frame Color
KIT-UDA115-BAMBOO-BLK

This example is for a bamboo E7 Electric Standing Desk Converter with a black frame.

| | Additional Information | SKU | Weight | \$ Price |
|--|---|--------|--------|----------|
| | <ul style="list-style-type: none"> • Quickly switch between seated and standing height • Monitor arms can rotate from portrait to landscape • Available in Black or White Eco, Bamboo, and Rubberwood Solid Wood | UDA115 | 92 lb | \$399 |

E7 Electric Standing Desk Converter

Monitor Mounts

| Dual Monitor Mount | Width | Height | Weight Capacity | Material | SKU | Weight | \$ Price |
|--------------------|-------|--------|-----------------|----------|-----|--------|----------|
|--------------------|-------|--------|-----------------|----------|-----|--------|----------|

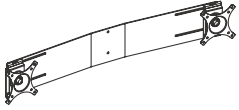

30.63" 4.75" 35.2 lb Powder-Coated Steel ACC115 6 lb 5 oz \$49

*Options Sold Separately

Triple Monitor Mount

| Triple Monitor Mount | Width | Height | Weight Capacity | Material | SKU | Weight | \$ Price |
|----------------------|-------|--------|-----------------|----------|-----|--------|----------|
|----------------------|-------|--------|-----------------|----------|-----|--------|----------|

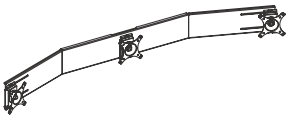

56.8" 5.3" 52.8 lb Powder-Coated Steel ACC116 13.4 lb \$79

*Options Sold Separately

ATX Standing Desk Converter

If you aren't ready to upgrade to a full UPLIFT V2 Standing Desk yet, transform your current desk with the ATX Standing Desk Converter. Arrives fully assembled and ready to use. The single-handed operation creates smooth and quiet adjustments without any predetermined height settings. Enjoy a competitive height range of 18.3" with a single handle operation. Compatible with users from 4' 10" to 6' 2" in height. Safely hold up to 39.6 lb of work equipment. Some users prefer monitor arms, which are options for those who would like to mount a monitor to their desk or converter. Monitor arms support the monitor without taking up additional space on your work surface.

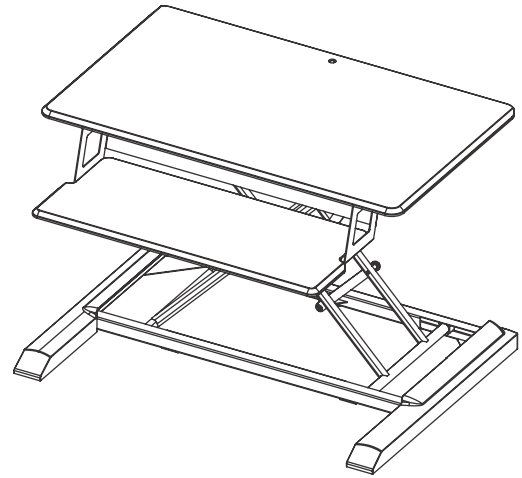

Features

- Heavy-duty lifting power, up to 39.6 lb
- Adjustable height range up to 18.3"
- Attached one or two monitor arms

Specifications

[See complete spec sheet here](#)

- Worksurface: 35.4" W x 21" D
- Keyboard Tray: 28.1" W x 11.25" D
- Height Range: 18.3"
- Weight Capacity: 39.6 lb

Colors

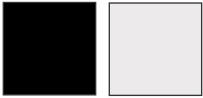

Black
BLK

White
WHT

Additional Information

- Pneumatic lift
- Available in Black and White

SKU

UDA123

Weight

41 lb 6 oz

\$ Price

\$289

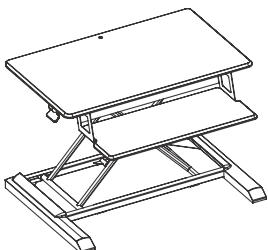

Lady Bird Standing Desk Converter

The [Lady Bird Standing Desk Converter](#) is a budget-friendly way to switch between sitting and standing while working. If upgrading to a full standing desk like our UPLIFT V2 Standing Desk isn't currently an option for you, a standing desk converter is the next best solution. The overall lifting capacity of 33 lb combined with a 12" adjustable height range is made to fit users between 4' 10" to 6' 1". The single-handle operation allows for smooth and quiet adjustments. Set to any height within the converter's range to fit your personalized needs.

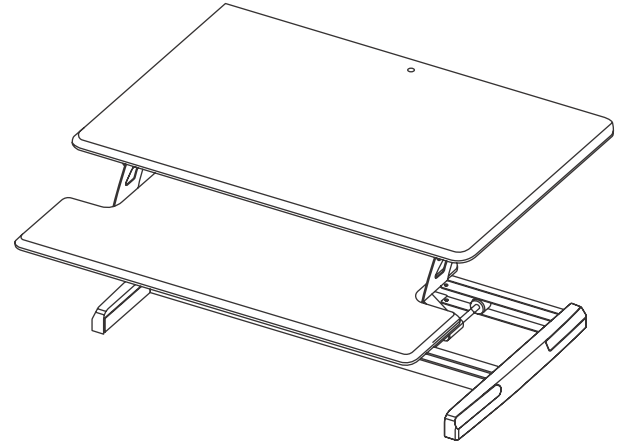

Features

- Lifting power up to 33 lb
- Adjustable height range up to 12"
- Attach one or two monitor arms

Specifications

[See complete spec sheet here](#)

- Worksurface: 29.7" W x 19.7" D
- Keyboard Tray: 29.7" W x 12.4" D
- Height Range: 12"
- Weight Capacity: 33 lb

Colors



Black
BLK

| | Additional Information | SKU | Weight | \$ Price |
|--|--|--------|-------------|----------|
| | <ul style="list-style-type: none"> • Pneumatic lift • Available in Black | UDA124 | 30 lb 10 oz | \$199 |

E3 Compact Standing Desk Converter

The [E3 Compact Stand Up Desk Converter](#) converts almost any space into a sit-stand workstation. The converter locks in place at the user's preferred standing heights with minimal manual adjustments. The slim platform saves space and features an 11 pound weight capacity. The E3 arrives fully assembled and comes in white and black color options. Whether you're headed into a meeting or working away from your desk, the E3 allows you the freedom to sit or stand wherever you choose.

Features

- System adjusts via gas cylinder
- Locks securely in place for stable standing
- Compact scissor lift design saves space when storing
- Less than 1 inch tall when closed
- Adjustable height setting

Specifications

- Worksurface: 26.8" W x 13.4" D
- Height Range: 15.7" H
- Weight Capacity: 11 lb

Colors

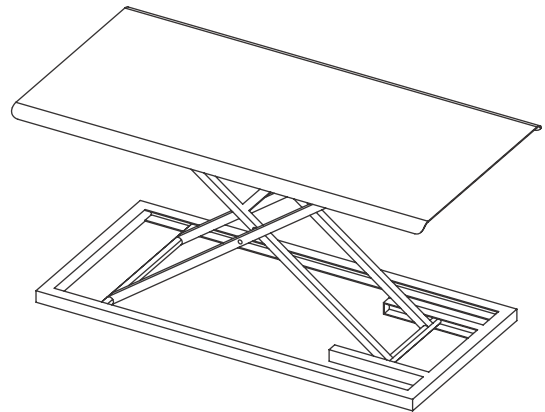

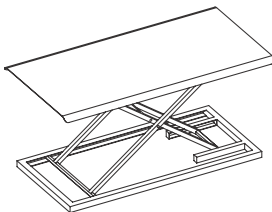
| | Additional Information | SKU | Weight | \$ Price |
|---|---|--------|--------|----------|
|  | <ul style="list-style-type: none"> • Pneumatic lift • Comes fully assembled • Available in Black and White | UDA121 | 11 lb | \$129 |

Riser or Clamp Standing Desk Converter

The [Standing Desk Converter - Riser or Clamp](#) converts fixed-height surfaces into adjustable height workstations. Easy controls, a large work surface, and an attached keyboard tray help users work in comfort. The converter adjusts for height via a gas cylinder so no electricity is necessary. Choose between freestanding (riser) or clamp mount models. Installing with the clamp mount allows the attached keyboard tray to lower below desk surface for ideal ergonomic typing position, while the freestanding mount allows more freedom and mobility.

Features

- Converts any surface into an adjustable height workstation
- Pneumatic adjustment does not require electrical outlet
- Counterbalances to support weight of equipment
- Clamp mount allows attached keyboard tray to lower below desk surface for ideal ergonomic typing postures
- Freestanding base also available

Specifications

[See complete Riser spec sheet here](#)
[See complete Clamp spec sheet here](#)

- Worksurface: 23.6" W x 15.75" D
- Keyboard Tray: 27" W x 10.5" D
- Height Range: 16.7" H
- Weight Capacity: 28.6 lb
- Desktop Requirements: Riser - 23.5" D and up
Clamp - 19" - 31.5" D

Colors



Black
BLK

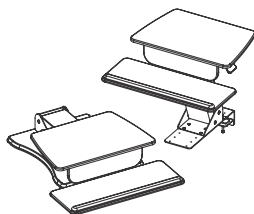
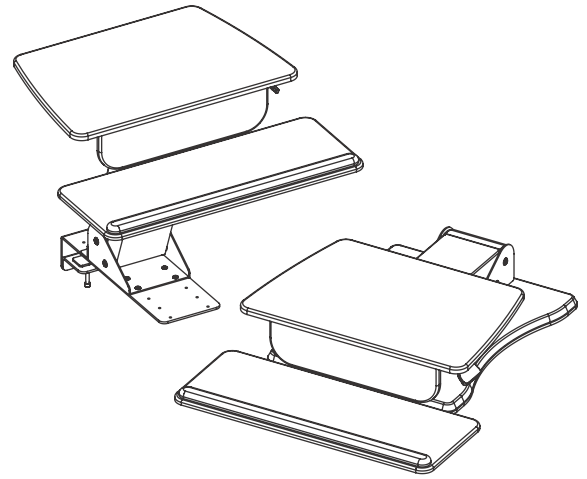

| Additional Information | Model | SKU | Weight | \$ Price |
|--|-------------|--------------|------------|----------|
| <ul style="list-style-type: none"> • Pneumatic lift • Available in Black | Riser Mount | UDA100-RISER | 60 lb 8 oz | \$219 |
| | Clamp Mount | UDA100-CLAMP | 52 lb 2 oz | \$219 |

Adapt Mobile Laptop Standing Desk Converter

The [Adapt Mobile Laptop Standing Converter](#) elevates laptops to comfortable viewing heights, is suitable for most sizes of laptops, and comes with a 15.4 pound weight capacity. The converter comes with dual USB 3.0 ports on the base for easy charging and powering of devices and is available in black and gray color options.

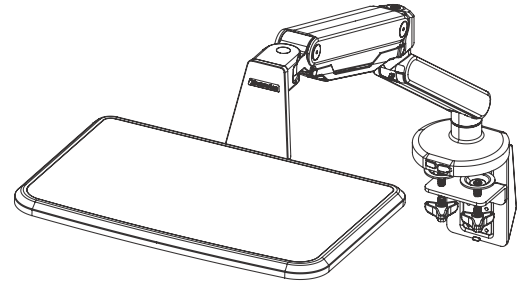

Features

- Raises laptop to comfortable height for working
- Offers enough space for any laptop computer
- Keeps workstation organized with integrated cable management
- Charges devices via the two USB ports in the mounting base
- Attaches to desks up to 4.7" thick using clamp mount
- Includes bolt-through mount for added stability

Specifications

[See complete spec sheet here](#)

- Worksurface: 19.7" W x 13" D
- Height Range: 16.2" H
- Rotation Range: 360°
- Weight Capacity: 15.4 lb

Colors

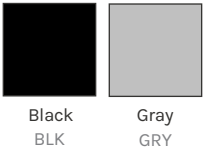

| | Additional Information | SKU | Weight | \$ Price |
|---|--|--------|------------|----------|
|  | <ul style="list-style-type: none"> • Uplifts your laptop • Includes clamp and bolt-through mounts • Available in Black and Gray | UDA120 | 16 lb 8 oz | \$199 |

ACCESSORIES

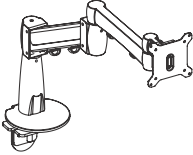
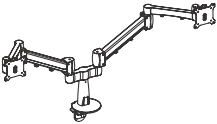
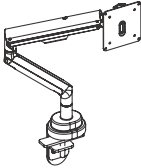
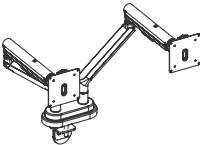

Product Comparison: Monitor Arms

| | Range Single Monitor Arm  | Range Dual Monitor Arm  | Zilker Single Monitor Arm  | Zilker Dual Monitor Arm  |
|------------------------------|---|---|--|--|
| Price | \$109 | \$169 | \$99 | \$159 |
| Specifications | | | | |
| Height Adjustment Range | 4.25" - 18.75" | 4.75" - 21" | 6.75" - 19" | 6.88" - 19.38" |
| Depth Adjustment Range | 27.5" D | 27.5" D | 20" D | 20" D |
| Monitor Weight Capacity | 4.5 - 17.5 lb | 4.5 - 17.5 lb (per arm) | 4.4 - 11 lb | 4.4 - 11 lb (per arm) |
| Display Rotation Range | 360° | 360° | 360° | 360° |
| Pan Rotation Range | 180° (+/-90°) | 180° (+/-90°) | 180° (+/-90°) | 180° (+/-90°) |
| Max Recommended Monitor Size | 27" Monitors | 27" Monitors | 27" Monitors | 27" Monitors |
| Material | Aluminum, Steel, & Plastic | Aluminum, Steel, & Plastic | Aluminum, Steel, & Plastic | Aluminum, Steel, & Plastic |
| Laptop Mount Compatible | ✓ | ✓ | ✓ | ✓ |
| 75 & 100mm VESA Compatible | ✓ | ✓ | ✓ | ✓ |
| Mounting Options | | | | |
| Clamp Mount | ✓ | ✓ | ✓ | ✓ |
| Bolt-thru Mount | ✓ | ✓ | ✓ | ✓ |
| Colors | Black, Gray, & White | Black, Gray, & White | Black, Gray, White, & Industrial Style | Black, Gray, White, & Industrial Style |

Range Single Monitor Arm

The [Range Single Monitor Arm](#) supports single monitors weighing between 4.5-17.5 pounds and its counterbalance system allows easy fingertip adjustment of height and depth. Built-in cable management allows users to route and hide monitor cords. Installs to desks via a stable clamp mount and fits desktops up from .75" - 3.75" thick. VESA compatible 75 mm and 100 mm.

Features

- Counterbalance system allows fingertip adjustment
- Built-in cable management
- Quick-release VESA mounts
- 180-degree stopping pin limits arm movement in space-constrained environments. Remove pin for 360 degrees of motion

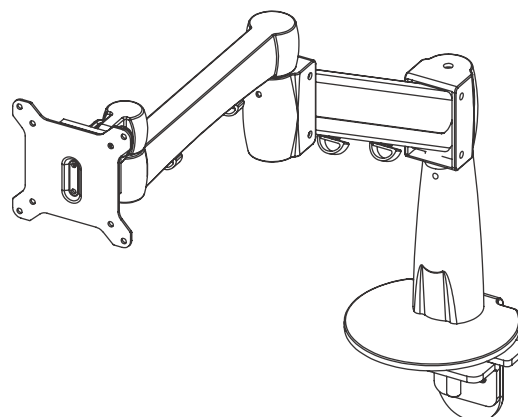

Specifications

[See complete spec sheet here](#)

- Height Adjustment Range: 4.25" - 18.75" H
- Depth Adjustment Range: 27.5" D
- Display Rotation Range: 360° rotation range
180° pan range
- VESA Mount: 100 x 100 mm & 75 x 75 mm
- Monitor Weight: 4.5 - 17.5 lb

**Use bolt thru mount for desktops .6" - 2.1" thick and clamp mount for desktops .75" - 3.75" thick*

Colors



Black
BLK

Gray
GRY

White
WHT

Options Sold Separately

View Laptop Mount

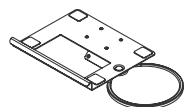

| Width | Length | Weight | SKU | \$ Price |
|------------------------|--------|-------------------------|-----------------------------|---------------|
| 11.8" | 9.67" | 4 lb | UPL023 | \$39 |
| Additional Information | | Weight with Clamp Mount | Weight with Bolt-Thru Mount | |
| | | 9 lb 14 oz | 8 lb 10 oz | MON0020 \$109 |

- 360° rotation
- Wire management
- Available in Black, Gray and White

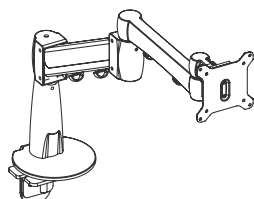

Range Dual Monitor Arm

The [Range Dual Monitor Arm](#) secures and elevates dual monitor setups for comfortable viewing via a stabilizing counterbalance system that offers fingertip height and depth adjustment. It's designed to hold screens between 4.5-17.5 pounds on each arm and comes with integrated cable management. The arm installs via a stable clamp mount that fits desktops from .75" - 3.75" thick. VESA compatible 75 mm and 100 mm.

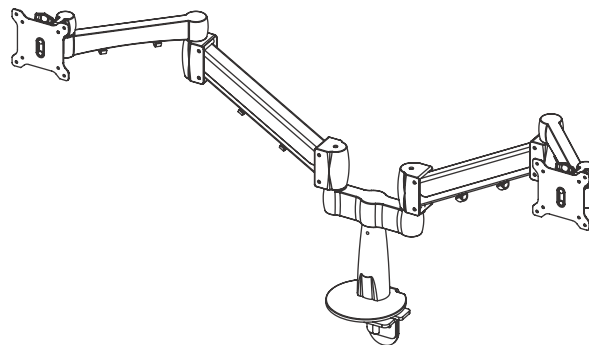

Features

- Counterbalance system allows fingertip adjustment
- Quick-release VESA mounts
- Built-in cable management
- 180-degree stopping pin limits arm movement in space-constrained environments. Remove pin for 360 degrees of motion

Specifications

[See complete spec sheet here](#)

- Height Adjustment Range: 4.75" - 21" H
- Depth Adjustment Range: 27.5" D
- Display Rotation Range: 360° rotation range
180° pan range
- VESA Mount: 100 x 100 mm & 75 x 75 mm
- Monitor Weight: 4.5 - 17.5 lb per arm

**Use bolt thru mount for desktops .6" - 2.1" thick and clamp mount for desktops .75" - 3.75" thick*

Colors



Black BLK Gray GRY White WHT

Options Sold Separately

View Laptop Mount

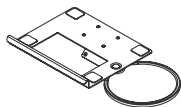
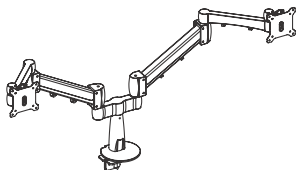
| | Width | Length | Weight | SKU | \$ Price |
|--|--------------------------------|------------------------------------|--------|---------|----------|
|  | 11.8" | 9.67" | 4 lb | UPL023 | \$39 |
| Additional Information | Weight with Clamp Mount | Weight with Bolt-Thru Mount | | | |
|  <ul style="list-style-type: none"> • 360° rotation • Wire management • Available in Black, Gray and White | 20 lb 8 oz | 17 lb 14 oz | | MON0021 | \$169 |

Zilker Single Monitor Arm

The dynamic [Zilker Single Monitor Arm](#) lets you position your screen at a comfortable and ergonomically correct working distance, height, and angle. The Zilker Single Monitor Arm supports monitors from 4.4 lb - 11 lb on a gas spring mechanism for smooth travel between 6.75" - 19" high (a 12.25" range from the center of the VESA plate to the desktop). A sturdy clamp mount installs quickly on desktops ranging from 0.75" - 3.75" thick; also includes an optional bolt-through mounting kit for holes 0.4" - 3.15" in diameter and desks ranging from 0.6" - 2.13" thick.

The rotation stop pin prevents the monitor arm from swiveling past the back edge of your desk, or remove the pin to let it rotate 360 degrees. Built-in cord management streamlines cables for a clutter-free workspace. Available in four colors so you can coordinate with your standing desk frame.

Features

- Rotate 360 degrees to share your screen with neighbors
- Stay organized with built-in cable management
- Ergonomic angle reduces neck strain
- Quick-release VESA mounts

[See complete spec sheet here](#)

Specifications

- Height Adjustment Range: 6.75" - 19" H
- Depth Adjustment Range: 20" D
- Display Rotation Range: 360°
- VESA Mount: 100 x 100 mm & 75 x 75 mm
- Monitor Weight: 4.4 - 11 lb

**Use bolt thru mount for desktops .6" - 2.1" thick and clamp mount for desktops .75" - 3.75" thick*

Colors

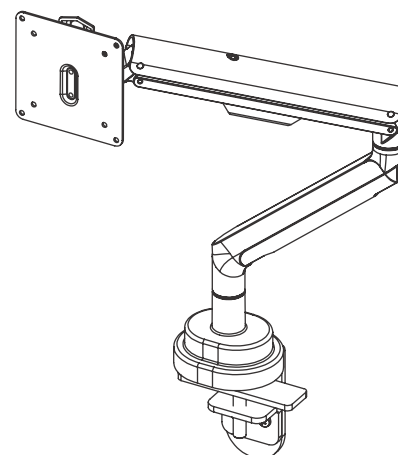
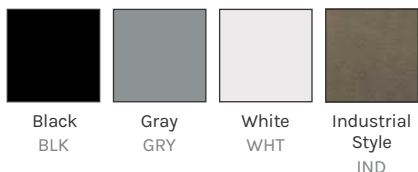

Options Sold Separately

View Laptop Mount

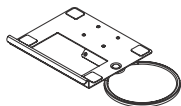
| | Width | Length | Weight | SKU | \$ Price |
|---|--|--------|--------------------------------|------------------------------------|----------|
|  | 11.8" | 9.67" | 4 lb | UPL023 | \$39 |
| | Additional Information | | Weight with Clamp Mount | Weight with Bolt-Thru Mount | |
|  | <ul style="list-style-type: none"> • 360° rotation • Wire management • Available in Black, Gray, White and Industrial | 6 lb | 4 lb 12 oz | MON001 | \$99 |

Zilker Dual Monitor Arm

With the [Zilker Dual Monitor Arm](#), control two screens while you work, changing monitor angles, heights, and distances with this sleek monitor arm. Or add a laptop mount to give your laptop a boost. Give monitors from 4.4 lb - 11 lb the ability to glide above your desk—as well as raise from 6.88" - 19.38" (as measured from the desktop to the center of the VESA mount). Installation is easy. The monitor arm securely clamps onto the back edge of desktops 0.75" - 3.75" thick—or can be bolt-mounted through holes 0.4" - 3.15" in diameter on 0.6" - 2.13" thick desktops.

Rotation stop feature also allows you to halt your arms at the back edge of the desk to avoid hitting objects. Remove the locking pin to rotate 360 degrees. Place all your cables into the integrated wire management clips for a clean, streamlined look.

Attach your monitors to the arm using the quick-release VESA mount.

Features

- Save desktop space by lifting two monitors off the desktop
- Control two screens and increase productivity
- Four colors available to coordinate with your space
- Quick-release VESA mounts

Specifications

[See complete spec sheet here](#)

- Height Adjustment Range: 6.88" - 19.38" H
- Depth Adjustment Range: 20" D
- Display Rotation Range: 360°
- VESA Mount: 100 x 100 mm & 75 x 75 mm
- Monitor Weight: 4.4 - 11 lb per arm

**Use bolt thru mount for desktops .6" - 2.1" thick and clamp mount for desktops .75" - 3.75" thick*

Colors

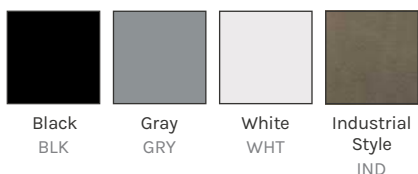

Options Sold Separately

View Laptop Mount

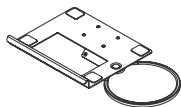
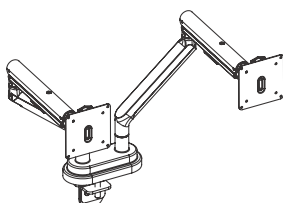
| | Width | Length | Weight | SKU | \$ Price |
|---|--------------------------------|------------------------------------|--------|--------|----------|
|  | 11.8" | 9.67" | 4 lb | UPL023 | \$39 |
| Additional Information | Weight with Clamp Mount | Weight with Bolt-Thru Mount | | | |
|  | 9 lb 13 oz | 8 lb 10 oz | | MON002 | \$159 |
| | | | | | |

- 360° rotation
- Wire management
- Available in Black, Gray, White and Industrial

Product Comparison: Keyboard Trays

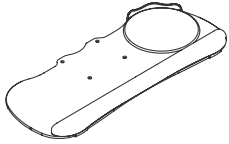
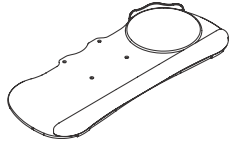
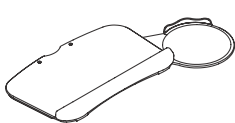
| | Big Standard Keyboard Tray System  | Big Ultra-Thin Keyboard Tray System  | Switch Ultra-Thin Keyboard Tray System  |
|------------------------------|--|---|---|
| Price | \$118 - \$138 (tray only) | \$128 (tray only) | \$148 (tray only) |
| Specifications | | | |
| Platform Dimensions | 27" W x 11" D | 27" W x 11" D | 19.75" W x 12.25" D |
| Platform Thickness | 3/8" | 0.25" | 0.25" |
| Mouse Pad Dimensions | 8" diameter | 8" diameter | 8" diameter |
| Track Length | 21" (standard) / 11" (limited depths) | 21" (standard) / 11" (limited depths) | 21" (standard) / 11" (limited depths) |
| Weight Limit | 10 lb | 10 lb | 10 lb |
| Material | MDF (Black and White) Bamboo (Bamboo) | Phenolic Resin | Phenolic Resin |
| Height Adjustment | Quick-Adjust Mech: 8" Economy Mech: 6" | Quick-Adjust Mech: 8" Economy Mech: 6" | Quick-Adjust Mech: 8" Economy Mech: 6" |
| Tilt Adjustment | Quick-Adjust Mech: -20° to +10° Economy Mech: -15° to +15° | Quick-Adjust Mech: -20° to +10° Economy Mech: -15° to +15° | Quick-Adjust Mech: -20° to +10° Economy Mech: -15° to +15° |
| Rotation Capability | Quick-Adjust Mech: 360° Economy Mech: 360° | Quick-Adjust Mech: 360° Economy Mech: 360° | Quick-Adjust Mech: 360° Economy Mech: 360° |
| Mechanism Options | | | |
| Quick-Adjust Mechanism | ✓ | ✓ | ✓ |
| Economy Mechanism | ✓ | ✓ | ✓ |
| Mounting Options | | | |
| Track Only | ✓ | ✓ | ✓ |
| Track with Track Spacer | ✓ | ✓ | ✓ |
| ANSI/BIFMA Compliance | ✓ | ✓ | ✓ |
| Colors | Black, White, and Bamboo | Black & White | Black |

Big Standard Keyboard Tray System

The [Big Standard Keyboard Tray System](#) positions your keyboard height, depth, and angle for optimal ergonomics, resulting in maximum comfort and productivity. A 27" keyboard platform is large enough to fit your mouse and keyboard side-by-side securely. Locating your keyboard and mouse closer to your lap height is better for ergonomics.

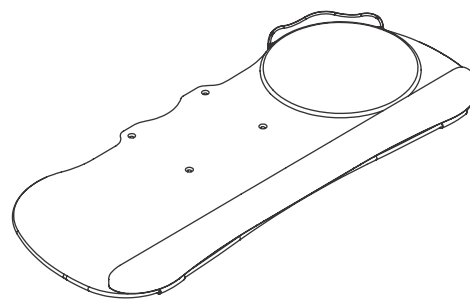

Features

- Includes two tracks: 21" (standard) & 11" (for limited depths)
- Choice of mechanism
- Positive and negative tilt adjustment
- Removeable wrist rest and mousepad

Specifications

[See complete spec sheet here](#)

- Material: MDF (Black & White)
Bamboo (Bamboo)
- Tray Dimensions: 27" W x 11.1" D
- Tray Thickness: 3/8"
- Mouse Pad: 8" diameter
- Height Adjustment: Quick-Adjust Mech: 8" (3" above/5" below)
Economy Mech: 6" (1.75" above/4.25" below)
- Track Lengths: 21" (standard) & 11" (for limited depths)
- Tilt Angles: Quick-Adjust Mech: -20° to +10°
Economy Mech: -15° to +15°
- Swivel: 360°

Colors



Black BLK White WHT Bamboo

A GUIDE TO THE

Big Standard Keyboard Tray System SKU



This example is for a black Big Standard Keyboard Tray System with an Economy Mechanism.

| | Additional Information | SKU | Weight | \$ Price |
|--|---|------------|---------|-------------------|
| | • Exceeds ANSI/BIFMA standards | KBT007-BLK | 3.5 lb | \$118 (tray only) |
| | • Available in Black, White, and Bamboo | KBT007-WHT | 3.5 lb | \$118 (tray only) |
| | | KBT007-BMB | 3.13 lb | \$138 (tray only) |

Big Ultra-Thin Keyboard Tray System

Big Ultra-Thin Keyboard Tray Systems helps you achieve your ideal ergonomic position. Customize the location of your keyboard's height, depth, and angle. Platform tilt angle was designed to move the keyboard away from your body to ensure an ergonomically correct typing posture. Our premium, ultra-thin .25" thick phenolic keyboard tray includes a 27" wide platform and is large enough to fit your mouse and keyboard on the same surface.

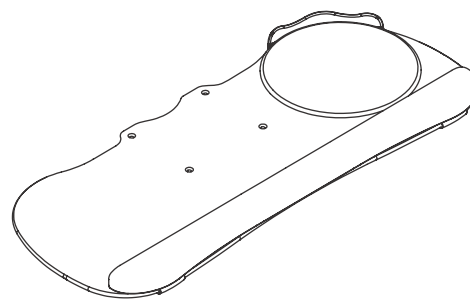

Features

- Includes two tracks: 21" (standard) & 11" (for limited depths)
- Choice of mechanism
- Positive and negative tilt adjustment
- Removeable wrist rest and mousepad

Specifications

[See complete spec sheet here](#)

- Tray Dimensions: 27" W x 11.1" D
- Tray Thickness: 0.25"
- Mouse Pad: 8" diameter
- Height Adjustment: Quick-Adjust Mech: 8" (3" above/5" below)
Economy Mech: 6" (1.75" above/4.25" below)
- Track Lengths: 21" (standard) & 11" (for limited depths)
- Tilt Angles: Quick-Adjust Mech: -20° to +10°
Economy Mech: -15° to +15°
- Swivel: 360°

Colors



Black
BLK

White
WHT

A GUIDE TO THE Big Ultra-Thin Keyboard Tray System SKU

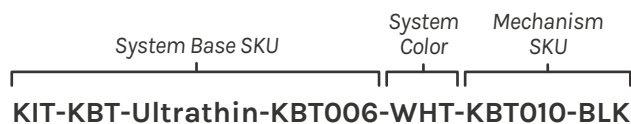

This example is for a black Big Ultra-Thin Keyboard Tray System with an Economy Mechanism.

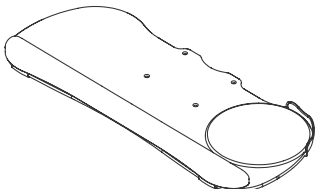
| Additional Information | SKU | Weight | \$ Price |
|--|--------|---------|-------------------|
|  <ul style="list-style-type: none"> • Exceeds ANSI/BIFMA standards • Available in Black and White | KBT006 | 4.25 lb | \$128 (tray only) |

Switch Ultra-Thin Keyboard Tray System

The dual platform [Switch Ultra-Thin Keyboard Tray System](#) keeps arms, hands, and wrists in comfortable positions for typing and mousing. Featuring an 8" height adjustment range, the tray allows for tilt adjustments from 10° positive to 20° negative. A detachable mouse platform can be moved to either side for ambidextrous mousing. The Switch has 360° of swivel for easy under-desk storage and comes with a removable wrist rest and mousepad for a complete ergonomic setup.

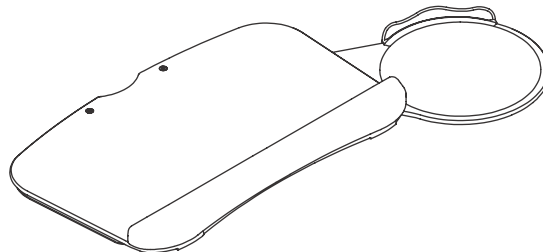

Features

- Includes two tracks: 21" (standard) & 11" (for limited depths)
- Choice of mechanism
- Positive and negative tilt adjustment
- Removeable wrist rest and mousepad

Specifications

[See complete spec sheet here](#)

- Material: Phenolic Resin
- Tray Dimensions: 19.75" W x 12.25" D
- Tray Thickness: 0.25"
- Mouse Pad: 8" diameter
- Height Adjustment: Quick-Adjust Mech: 8" (3" above/5" below)
Economy Mech: 6" (1.75" above/4.25" below)
- Track Lengths: 21" (standard) & 11" (for limited depths)
- Tilt Angles: Quick-Adjust Mech: -20° to +10°
Economy Mech: -15° to +15°
- Swivel: 360°

Colors



Black
BLK

A GUIDE TO THE

Switch Ultra-Thin Keyboard Tray System SKU

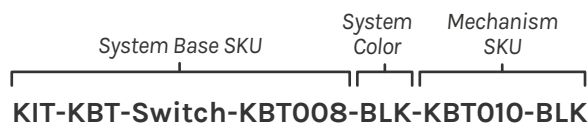

This example is for a black Switch Ultra-Thin Keyboard Tray System with an Economy Mechanism.

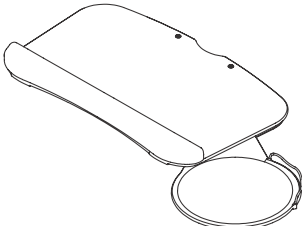
| | Additional Information | SKU | Weight | \$ Price |
|---|--|--------|---------|-------------------|
|  | <ul style="list-style-type: none"> • Exceeds ANSI/BIFMA standards • Available in Black | KBT008 | 7.63 lb | \$148 (tray only) |

Keyboard Tray Accessories

Available for all keyboard trays

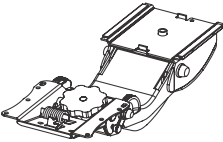
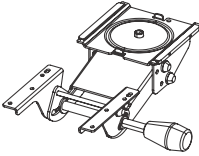
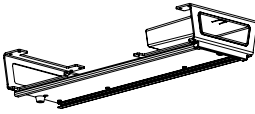
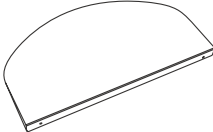
| Quick-Adjust Mechanism | Length | Tilt | Height Range | Weight Capacity | Material | SKU | Weight | \$ Price |
|---|---------------|--------------|--------------|-----------------|---------------------|---|---------|----------|
|  | 16" - 21.5" | -20° to +10° | 8" | 10 lb | Steel | KBT009 | 7.13 lb | \$129 |
| *Options Sold Separately | | | | | | | | |
| Economy Mechanism | | | | | | | | |
|  | 12.1" - 18.1" | -15° to +15° | 6" | 10 lb | Steel | KBT010 | 3.63 lb | \$79 |
| *Options Sold Separately | | | | | | | | |
| Track Spacer | Width | Height | | | | | | |
|  | 7.5" | 2.8" | | 50 lb | Steel, Plastic | ACC005 | 4 lb | \$69 |
| *Options Sold Separately | | | | | | | | |
| Corner Sleeve | | | Depth | | | | | |
|  | 19.5" | 1.14"-1.64" | 11" | | Powder-Coated Steel | UPL143~1-1.5 (desktops 1-1.5" thick) | | \$69 |
| | 19.5" | 1.64"-2.64" | 11" | | Powder-Coated Steel | UPL143~1.5-2.5 (desktops 1.5-2.5" thick) | | \$69 |
| *Options Sold Separately | | | | | | | | |

CPU Holder

The **CPU Holder** secures and elevates computer towers, getting them off the floor and out of the way and protecting them when raising and lowering sit-stand desks. A swivel mechanism offers 360° swivel for lightning-quick adjustments and access to ports. Constructed for versatility and durability, the holder boasts a 50 pound weight capacity and comes with a track spacer for easy mounting on desks with limited depth.

Features

- Mounts to underside of desk
- Swivels 360°
- Retracts along track for easy adjustment and access to ports

Specifications

[See complete spec sheet here](#)

- Width: 3.75" - 8.25" W
- Height: 12.25" - 20.5" H
- Track Length: 16" L
- Swivel: 360°
- Weight Capacity: 50 lb

Colors



Black
BLK

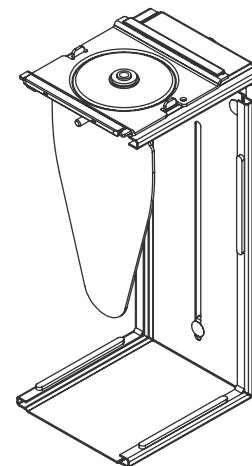

Accessories Included

| Track Spacer | Width | Height | Weight Capacity | Material | SKU | Weight | \$ Price |
|---|-------|--------|-----------------|----------------|--------|--------|----------|
|  | 7.5" | 2.8" | 50 lb | Steel, Plastic | ACC005 | 4 lb | \$25 |

Additional Information

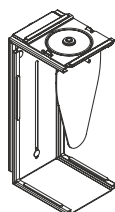

- Available in Black CPU128 9 lb \$110

UPLIFT Desk Extension

Combine the [UPLIFT Desk Extension](#) with the sturdy patent-pending mounting system on our UPLIFT V2 frame, and you can enjoy the benefits of more desk space in record time. Extend one or both sides of your desk by 12 inches. Each 12" W x 30" D extension provides 2.5 square feet of extra workspace.

A neoprene rubber pad top surface helps keep desktop items in place, reduces scratching, and minimizes noise. Pad is removable, or use the included adhesive backing to attach permanently

Place your large computer on top or underneath. The top makes a perfect place for a large computer. Or it's designed to work with our UPLIFT Desk CPU holder.

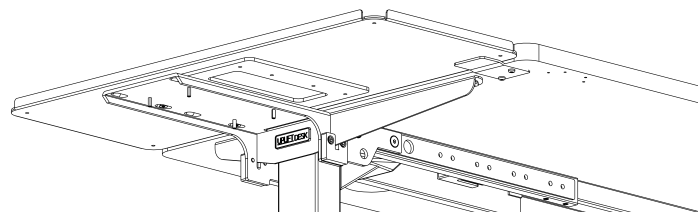

Features

- Holds up to 60 lb with included U-supports installed
- Holds up to 30 lb without included U-supports installed
- Perfect place for a large computer
- Only compatible with UPLIFT V2 frames
- Color choices to perfectly match your UPLIFT V2 desk frame

Specifications

- Tray Size: 12" W x 30" D
- Tray Material: Formed steel sheet
- Pad Material: 3mm black neoprene with adhesive backing
- Finish: Powder coat Paint
- Colors: Black, Gray, White, Industrial

Colors



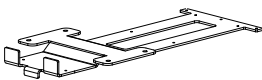
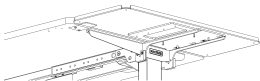

| CPU Adapter | Additional Information | SKU | Weight | \$ Price |
|---|--|--------|---------|----------|
|  | <ul style="list-style-type: none"> • Available in Black | CPU002 | 2.6 lb | \$29 |
|  | <ul style="list-style-type: none"> • Extend one or both sides • Holds up to 60 lbs with included U-supports (30 lb without included U-support) • Available in Black, Gray, White and Industrial | ACC036 | 32.1 lb | \$139 |

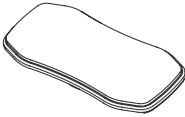
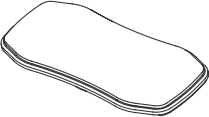
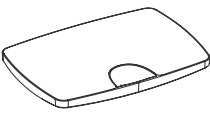
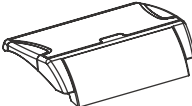

MATS + BOARDS +
+ FOOTRESTS

Product Comparison: Motion Boards

| | Bamboo Rocker-X Board | Bamboo Motion-X Board | Fit Motion Board | Adjustable Footrest E3 | Motion Board E3 |
|-----------------------|---|---|--|---|---|
| |  |  |  |  |  |
| Price | \$89 | \$89 | \$89 | \$89 | \$39 |
| Specifications | | | | | |
| Board Dimensions | 27" L x 12.5" W x 2.3" H | 27" L x 12.5" W x 2.3" H | 19.7" L x 13.8" W x 2.4" H | 15" L x 13.7" W x 3.2" H | 25.75" L x 10.1" W x 3.25" thick |
| Weight Capacity | 250 lb | 250 lb | 350 lb | N/A | 230 lb |
| Board Material | Genuine Bamboo | Genuine Bamboo | Plastic, Steel, Rubber, and Wool felt | Rubber grooved top surface | ABS plastic |
| Tilt angle | N/A | N/A | N/A | 16, 12, 16 and 25 degrees | N/A |
| Comfort Mat | Optional | Optional | N/A | N/A | N/A |
| 6-Pack Rack | Optional | Optional | N/A | N/A | N/A |
| Colors | N/A | N/A | Gray | Black with Gray details | Blue |

Bamboo Rocker-X Board

The [Bamboo Rocker-X Board](#) lets users get on their feet and rock from side to side, helping improve circulation and boost energy throughout the day.

The Rocker board is a gentler motion board alternative to our Motion-X Board, which provides a 360-degree range of motion and requires active heel/toe weight distribution. The Rocker-X simply rocks side-to-side, allowing you to get the benefits of added motion within a more stable range of movement.

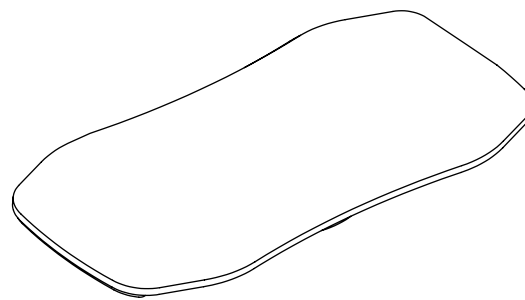

Features

- Allows more movement at standing desks
- Optional rubber bumpers for extra stability and bump protection
- Optional add-on comfort mat reduces fatigue

Specifications

[See complete spec sheet here](#)

- Dimensions: 12.5" W x 27" D x 2.3" H
- Weight Capacity: 250 lb

Colors



Bamboo

Options Sold Separately

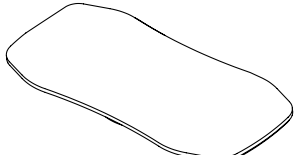
| Comfort Mat | Color | Thickness | Width | Material | SKU | \$ Price |
|---|--|-----------|-------|---------------|------------|----------|
|  | Black | .37" | 26" | TPE | ACC038-9MM | \$20 |
|  | Additional Information | | | Weight | | |
| | <ul style="list-style-type: none"> • Deck Material: Genuine Bamboo • Base Material: Plastic & Rubber | | | 5 lb | MVT012-BMB | \$89 |

Bamboo Motion-X Board

The [Bamboo Motion-X Board](#) lets users balance, tilt, and rock while standing in place at sit-stand desks, boosting energy and improving circulation. Featuring a low-profile design, the Motion X Board's deck is made from genuine and sustainable bamboo. A molded plastic base underneath allows for gentle rocking movements, while molded high durometer rubber bumpers protect against bumps. An anti-fatigue comfort mat can be added to the top of the board for additional support.

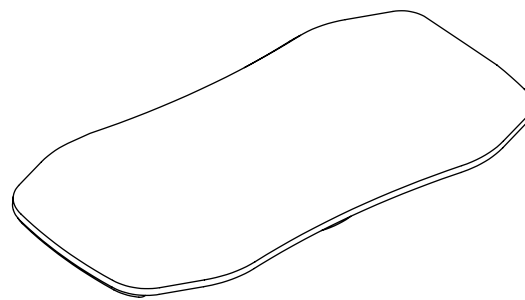

Features

- Allows more movement at standing desks
- Optional rubber bumpers for extra stability and bump protection
- Optional add-on comfort mat reduces fatigue

Specifications

[See complete spec sheet here](#)

- Dimensions: 12.5" W x 27" D x 2.3" H
- Weight Capacity: 250 lb

Colors



Bamboo

Options Sold Separately

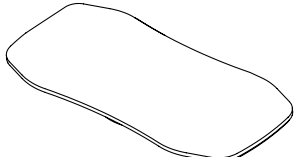
| Comfort Mat | Color | Thickness | Width | Material | SKU | \$ Price |
|---|--|-----------|-------|---------------|------------|----------|
|  | Black | .37" | 26" | TPE | ACC038-9MM | \$20 |
|  | Additional Information | | | Weight | | |
| | <ul style="list-style-type: none"> • Deck Material: Genuine Bamboo • Base Material: Plastic & Rubber | | | 5 lb | MVT005-BMB | \$89 |

6-Pack Rack for Motion-X and Rocker-X Boards

The [Motion-X 6-Pack Rack](#) stores and displays up to six bamboo Motion-X boards with this sleek and minimalistic design. Reduce the clutter in your office with a centrally located rack for your motion boards. Neoprene-covered brackets protect the Motion-X board bases from damage while keeping them secure.

Buy packs of 6 Bamboo Motion-X Boards to share with your team and keep them organized while they are not in use.

Features

- Solid 3/4" thick bamboo construction
- Conveniently portable for easy mobility and storage
- Elegant bamboo design with black accents match the boards design

Specifications

[See complete spec sheet here](#)

- Dimensions: 27.5" W x 15.75" D x 47.6" H
- Material: Bamboo & black powder coated hardware

Colors



Bamboo

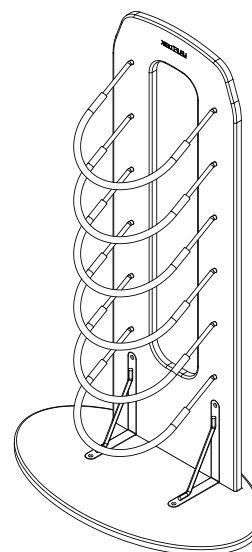

Options Sold Separately

| Bamboo Motion-X Board 6-Pack | Options | Color | Thickness | Width | Material | SKU | \$ Price |
|---|------------------|--------|-----------|-------|----------|--------|----------|
|  | No Comfort Mat | Bamboo | .37" | 26" | TPE | MVT005 | \$474 |
| | With Comfort Mat | Bamboo | .37" | 26" | TPE | MVT005 | \$594 |

Bamboo Rocker-X Board 6-Pack

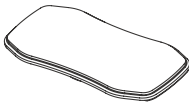
| | | | | | | | |
|---|------------------|--------|------|-----|-----|--------|-------|
|  | No Comfort Mat | Bamboo | .37" | 26" | TPE | MVT012 | \$474 |
| | With Comfort Mat | Bamboo | .37" | 26" | TPE | MVT012 | \$594 |

Additional Information

Weight

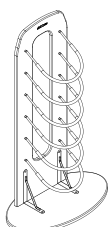

- Easy installation
- Store and display up to six Motion-X or Rocker-X Boards

26 lb ACC052 \$249

Fit Motion Board

Improve your health and focus with gentle, active motion with the [Fit Motion Board](#). The tilt angle is adjustable for greater control over the range of motion, and the heel grab option lets you reposition the board without bending and reaching. Gently work your leg muscles and engage your core at your desk.

The soft wool felt top adds traction and comfort, making it easy to keep your footing. The board is small in size, easily portable, and strong enough to hold up to 350 lb. culpa qui officia deserunt mollit anim id est laborum.

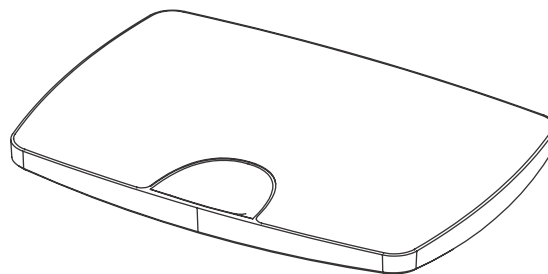

Features

- Allows more movement at standing desks
- Removeable bumpers provide adjustable tilt angle
- Soft wool felt top for traction

Specifications

[See complete spec sheet here](#)

- Dimensions: 19.7" L x 13.8" W x 2.4" H
- Tilt Angle: With Bumpers: 5°
Without Bumpers: 8°
- Weight Capacity: 350 lb

| | Additional Information | SKU | Weight | \$ Price |
|---|---|--------|--------|----------|
|  | • Material: plastic, steel, rubber, and wool felt | MVT007 | 6 lb | \$89 |

E3 Adjustable Footrest

The [E3 Adjustable Footrest](#) delivers support for the legs and feet to allow ideal circulation while seated. Adjustable legs let users set the footrest to their preferred height and angle, with four different positions from which to choose. A rubber grooved top surface grips shoes to keep feet stable and prevent them from slipping off the platform.

Features

- Adjusts to four different angled positions
- Grooved rubber top surface grips feet and shoes for support

Specifications

[See complete spec sheet here](#)

- Dimensions: 15.7" L x 13.7" D x Variable Height
- Four Possible Angles: 6°, 12°, 16°, & 25°

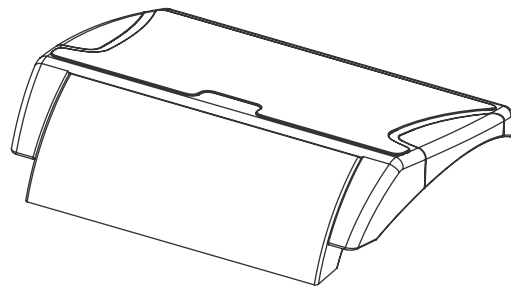

Additional Information

- Ships fully assembled

SKU

ACC019

Weight

3 lb

\$ Price

\$49

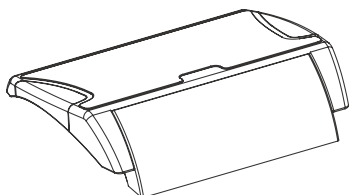

Motion Board E3

The [Motion Board E3](#) allows you to rock, tilt, swivel, or balance in place while you finish up your latest project. The board utilizes more muscle groups and burns more calories than simply standing in place, and can even boost your energy levels. Once you get the hang of it, work will feel more like surfing at your desk than working on your spreadsheets.

Features

- Curved surface lets you rock, tilt, and swivel at work
- Burns calories and engages more muscles
- Available in blue

Specifications

[See complete spec sheet here](#)

- Dimensions: 25.75" long x 10.1" wide x 3.25" thick
- weight: 3lb
- Materials: ABS Plastic
- Weight capacity: 230lb

Colors



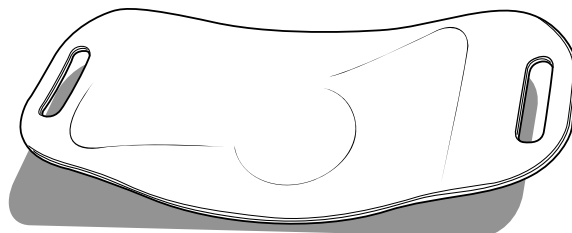

Blue

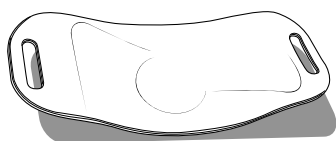

| Additional Information | SKU | Weight | \$ Price |
|---|------------|--------|----------|
| <ul style="list-style-type: none"> • Ships fully assembled | MVT001-BLU | 3 lb | \$39 |

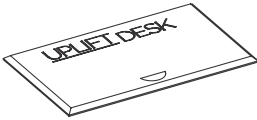
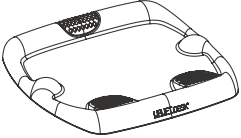

Product Comparison: Desk Mats

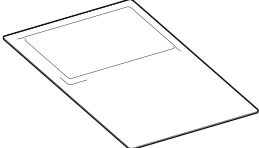
| | Standing Desk Mat with Heel Grab  | E7 Active Anti-Fatigue Mat  | E7 Small Active Anti-Fatigue Mat  | Chair Mat with Standing Cushion  |
|-----------------------|---|---|---|--|
| Price | \$59 | \$99 | \$69 | \$84 |
| Specifications | | | | |
| Dimensions | 30" W x 18" D x .75" H | 28.25" W x 27.78" D x 2.95" H | 25.1" W x 21.4" D x 3.1" H | 36" W x 54" D x .5" H |
| Weight Capacity | N/A | N/A | N/A | N/A |
| Material | Rubberized Gel Foam | Polyurethane | Polyurethane | cushion PVC with NBR |
| Heel Grab | ✓ | — | ✓ | — |
| Massage Mounds | — | ✓ | ✓ | — |
| Rest Bar | — | ✓ | ✓ | — |
| Power Wedges | — | ✓ | ✓ | — |
| Colors | Black | Black | Black | Black |

Standing Desk Mat with Heel Grab

Standing is comfortable with the [Standing Desk Mat with Heel Grab](#). Featuring a durable, rubberized gel foam interior and a textured surface with beveled edges that prevent tripping when stepping on or off, the mat provides standing support for the user's feet, legs, and back. Spill-resistant thanks to a closed-cell construction, the mat is 0.75" thick and fits underneath all UPLIFT Desks. The heel grab allows you to move it into place with ease.



Features

- Textured exterior prevents slips
- Rubberized gel foam provides comfort for standing by absorbing weight and pressure in legs and feet
- Heel grab helps you move mat around with ease
- Smooth beveled edges prevent tripping hazards
- Strong surface is abrasion- and tear-resistant, and is able to withstand the weathers of work
- Closed-cell construction makes mat resistant to spills and easy to clean

Specifications

[See complete spec sheet here](#)

- Dimensions: 18" D x 30" W x 0.75" thick

Colors

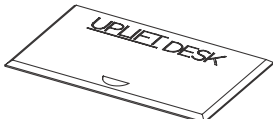

Black
BLK

| | Additional Information | SKU | Weight | \$ Price |
|---|---|--------|------------|----------|
|  | <ul style="list-style-type: none"> • Textured surface • Beveled edges • Available in Black | MAT145 | 1 lb 14 oz | \$59 |

E7 Active Anti-Fatigue Mat

The [E7 Active Anti-Fatigue Mat](#) gives users an active standing experience complete with anti-fatigue support. A rest bar with textured surface massages the feet and massage mounds let users stretch muscles. Power wedges on the back of the mat relieve calves while standing. The E7 lets users vary their standing postures even more than they can with a traditional standing mat.

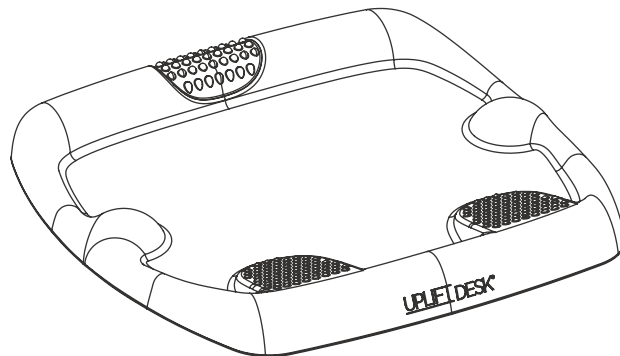

Features

- Several options for users to switch postures and stretch muscles.
- Spacious anti-fatigue mat area to relieve pressure on the legs and feet while standing.
- Massage mounds on outer sides for arches of feet
- Rest bar at front with textured surface for massaging feet and exercising ankles.
- Power wedges at back to relieve heels and stretch calves.

Specifications

[See complete spec sheet here](#)

- Dimensions: 28.25" D x 27.8" W x 3" thick

Colors



Black
BLK

| | Additional Information | SKU | Weight | \$ Price |
|--|--|--------|---------|----------|
| | <ul style="list-style-type: none"> • Material: Polyurethane • Available in Black | MAT010 | 7.12 lb | \$99 |

E7 Small Active Anti-Fatigue Mat

The [E7 Small Active Anti-Fatigue Mat](#) allows you to stand comfortably for longer periods, take a stretch break, and work in greater comfort at your cubicle or workstation.

Engage your core and stretch targeted muscle groups in the legs, ankles, and feet with this multidimensional floor mat. Massage mounds on the edges can give your feet some needed rest and relaxation throughout the day. An incline at the front of the mat provides a place to vary your posture and stretch, and the mat's heel grab allows you to shift its position on the floor without needing to bend over awkwardly.

Because we know you'll be using your anti-fatigue mat for hours per day, we've made it from high-density materials that will stand the test of time. With a smaller design than our full-sized E7, this mat fits in more places and suits a wide range of users, from children to adults.

Features

- Switch postures and stand comfortably at your workstation
- Smaller design is ideal for compact office spaces and kids
- Built-in heel grab means users can move the mat without bending down
- Rest bar with textured surface at the front lets you massage tired feet
- Massage mounds on the outer edges allow for targeted stretching
- Boasts a high-density core for long-lasting, steadfast support
- Fits most users, from kids to adults

Specifications

[See complete spec sheet here](#)

- Dimensions: 25.1" D x 21.4" W x 3.1" thick

Colors



Black
BLK

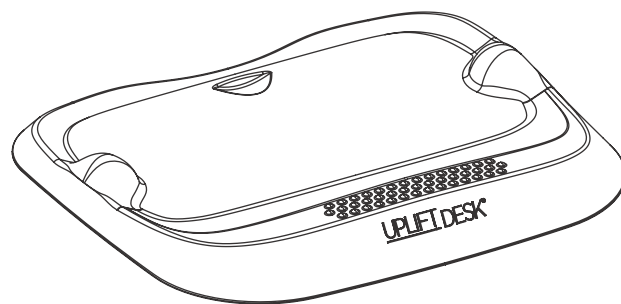

| | Additional Information | SKU | Weight | \$ Price |
|---|--|--------|--------|----------|
|  | <ul style="list-style-type: none"> • Material: Polyurethane • Available in Black | MAT013 | 5.3 lb | \$69 |

Chair Mat with Standing Cushion

The [Chair Mat with Standing Cushion](#) serves as the ultimate 2-in-1 for support and protection. It offers the perfect blend of protection, support, and comfort by providing a soft anti-fatigue surface for your feet when you're standing AND protecting the finish of your floor from your chair.

Dual-purpose mat made of strong faux-leather and engineered foam features a smooth surface on the back portion for your chair's casters. Sit, roll, and swivel without worrying about damaging your floor.

Stand up for your health at work while enjoying relief from foot, leg, and back fatigue.

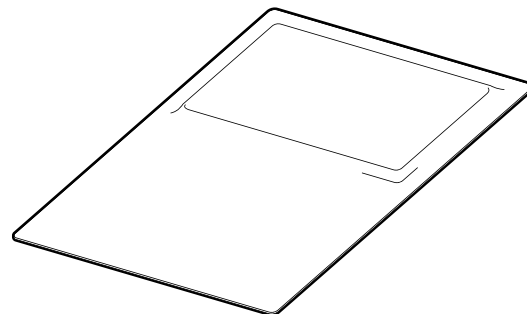

Features

- Sit and stand comfortably at your workstation
- Dual purpose anti-fatigue mat and back portion for chair
- Made of strong faux-leather and engineered foam
- Swivel without worry about damaging your floor

Specifications

[See complete spec sheet here](#)

- Dimensions: 36" W x 54" D x 0.08" thick (cushion area 0.5 thick)

Colors

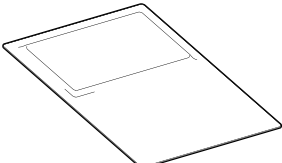

Black
BLK

| | Additional Information | SKU | Weight | \$ Price |
|---|---|--------|---------|----------|
|  | <ul style="list-style-type: none"> • Material: PVC with NBR foam cushion • Available in Black | MAT015 | 11.5 lb | \$84 |

Under Desk Hammock

Transform your UPLIFT V2 Standing Desk into a place where you can relax and recharge (or take a midday nap) with the [Under Desk Hammock](#). Clip the hammock onto the sturdy UPLIFT V2 Standing Desk Frame's mounting points using the included carabiners and remove it just as quickly. With the use of the Connect mobile app, you can change the height of your desk (and your hammock), making it easy to get in or out when you're ready to lie down or stand back up.

The hammock comes with a storage bag, which stays attached so it won't get lost. While you're kicking back under your desk, the bag doubles as a place to keep your phone, glasses, or bottled drink.

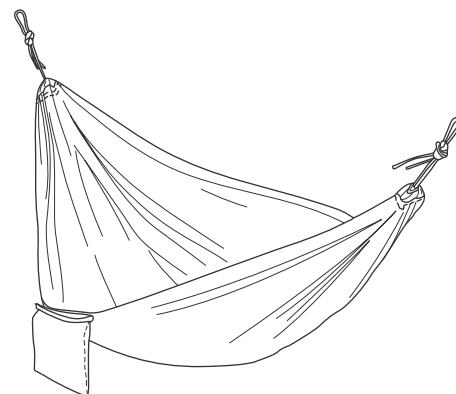

Features

- Transforms your desk into a relaxing hide-a-way
- A portable, on-the-go design ideal for camping trips
- Attached storage bag

Specifications

[See complete spec sheet here](#)

- Dimensions: 3.5' W 6' L
- Rope Length: 6.5' (for outdoor use)
- Weight Capacity: 400 lb
- Desk Size: 72" wide or wider
- Desk Type: UPLIFT V2 Frames

**Not compatible with UPLIFT V2-Commercial Frames*

Colors



Black
BLU

Gray
GRY

Additional Information

SKU

Weight

\$ Price

- Material: 210T Nylon
- Available in Blue and Gray

ACC042

12 oz

\$55

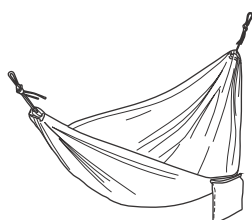

Foot Hammock

Elevate and Rest your feet while sitting at your desk with the use of the [Foot Hammock](#) by UPLIFT Desk.

You can remove the canvas and use the wood bars as footrests. This gives you the ability to swing your feet independently, resulting in a more active and healthy workday.

Easily mount to the patent-pending UPLIFT V2 Standing Desk Frame with its included anchor plates or anywhere on your desk using the eye plates, included with assembly materials. The carabiners give you the option to easily remove the hammock to make room for other accessories.

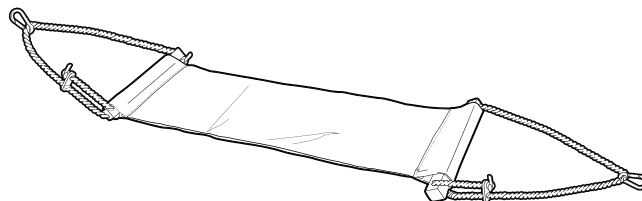

Features

- Easily mount to the patent-pending UPLIFT V2 Standing Desk Frame
- Use the variety of mounting points and adjustable length to raise or lower
- Use simultaneously with the Under Desk Hammock by UPLIFT Desk

Specifications

[See complete spec sheet here](#)

- Canvas Size: 25.25" W 6.5" L
- Overall Length: 47.25" to 72.25" (from end to end of rope)
- Weight Capacity: 50 lb when desktop mounted, 100 lb when frame mounted
- Wood Support Size: 0.75" W x 0.75" D x 8.25" H

**Not compatible with UPLIFT V2-Commercial Frames*

Colors



Black
BLU

Gray
GRY

Additional Information

- Material: Canvas
- Available in Blue and Gray

SKU

ACC047

Weight

.75 lb

\$ Price

\$29

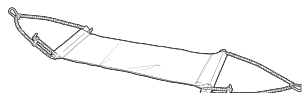



DESK ORGANIZATION

Product Comparison: Desk Organization

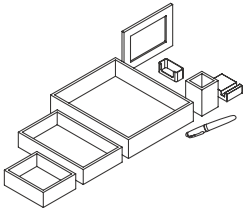
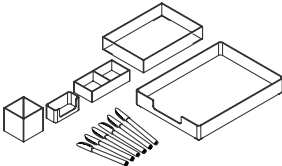
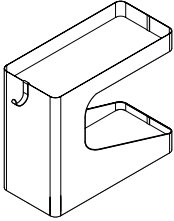
| | Bamboo Desk Organizer Set  | Desk Organizer Set  | Mobile Storage Caddy  |
|-----------------------------|---|---|--|
| Price | \$49 | \$49 | \$139 |
| Specifications | | | |
| Paper Tray | 12" W x 10" L x 2.5" D | 9.6" W x 13" L x 1.9" D | N/A |
| Medium Box | 6" W x 10" L x 2" D | 9.6" W x 6.75" L x 1.9" D | N/A |
| Small Box | 6" W x 5" L x 2" D | 6.25" W x 3" L x 1.6" D | N/A |
| Pen Holder | 2.5" W x 2.5" L x 3.5" D | 3.3" W x 3.3" L x 3.3" D | N/A |
| Business Card Holder | 4" W x 2" L x 2.3" D | 4" W x 1.75" L x 1.8" D | N/A |
| Phone Holder | 3.1" W x 3.4" L x 1" D | N/A | N/A |
| 4x6 Picture Frame | 5.5" W x 7.5" L x 2.1" D (w/ dowel) | N/A | N/A |
| Features | | | |
| Material | Genuine Bamboo, MDF | Plastic | Steel with felt lining |
| Included Accessories | | | |
| Included Writing Tools | 1 Bamboo Pen | 6 Gray Plastic Pens | Accessory Hook |
| Colors | N/A | Aqua, Blush, Blue, Gray, White, and Eucalyptus | Black, Gray, White, Industrial Style |

Bamboo Desk Organizer Set

The eco-friendly [Bamboo Desk Organizer Set](#) stores and displays a variety of items, from paper to pictures to tech devices. Users can put papers in the large box, store mail and notes in the medium box, and keep memos in the small box. The set also comes with a 4" x 6" picture frame, a business card holder, a phone holder, a pen holder, and a blue ballpoint pen to offer users a coordinated organizing desk set.

Features

- Organizes desktop accessories

Specifications

[See complete spec sheet here](#)

- Large Box: 12" W x 10" L x 2.5" D
- Medium Box: 6" W x 10" L x 2" D
- Small Box: 6" W x 5" L x 2" D
- Pen Holder: 2.5" W x 2.5" L x 3.5" D
- Business Card Holder: 4" W x 2" L x 2.3" D
- Phone Holder: 3.1" W x 3.4" D x 1" T
- 4" x 6" Picture Frame: 5.5" W x 7.5" L x 2.1" D (w/ dowel)

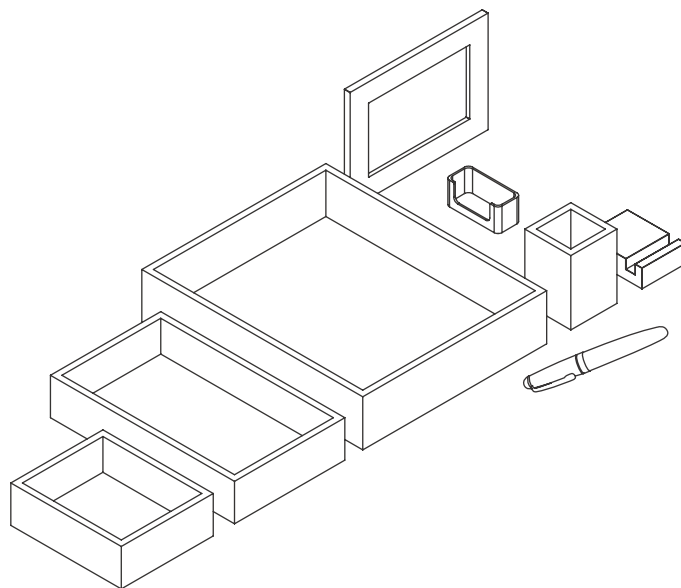

Colors



Bamboo

| Additional Information | SKU | Weight | \$ Price |
|------------------------|-----|--------|----------|
|------------------------|-----|--------|----------|

- Material: Bamboo, MDF (bottom of boxes)

STR010

2 lb 14 oz

\$49

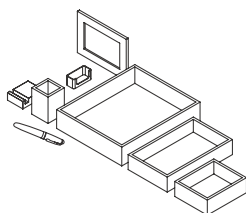

Desk Organizer Set

The [Desk Organizer Set](#) includes everything users need to organize their stray desktop items while adding a pop of color to their workspace. The set comes with a paper tray, medium accessory box, small accessory box, dual compartment pen holder, business card holder, and 6 pens with blue ink and comes in several color options.

Features

- Comes in a wide variety of fun colors
- Organizes desktop accessories
- Stackable boxes

Specifications

[See complete spec sheet here](#)

- Paper Tray: 9.6" W x 13" L x 1.9" D
- Medium Box: 9.6" W x 6.8" L x 1.9" D
- Small Box: 6.3" W x 3" L x 1.6" D
- Pen Holder: 3.3" W x 3.3" L x 3.3" D
- Business Card Holder: 4" W x 1.8" L x 1.8" D

Colors

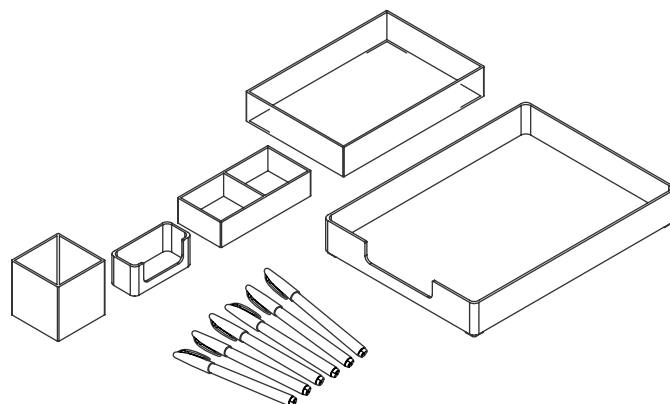
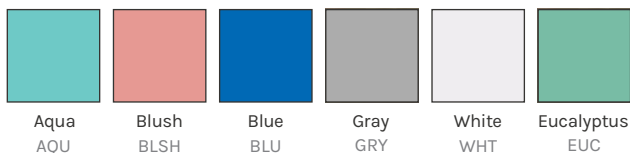

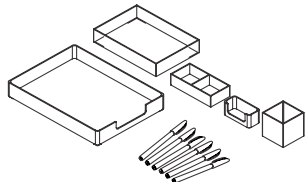
| | Additional Information | SKU | Weight | \$ Price |
|---|---|--------|------------|----------|
|  | <ul style="list-style-type: none"> • Material: Plastic • Available in Aqua, Blush, Blue, White, Gray and Eucalyptus | STR009 | 1 lb 12 oz | \$49 |

Mobile Storage Caddy

The [Mobile Storage Caddy](#) helps keep your desktop clean and organized by providing an easily accessible storage area for everyday items beneath or beside your desk. Store bags and other large items in the lower section and smaller personal items such as keys, phones, and drinks on the top shelf for quick access.

Features

- Arrives assembled
- Unidirectional casters
- Includes accessory hook

Specifications

[See complete spec sheet here](#)

- Material: Formed sheet metal with felt shelf pads
- Finish: Powder coat paint
- Weight Capacity: 20 lb upper shelf; 40 lb lower shelf (60 lb total)
- Shipping Dimensions: 25" W x 13.25" D x 14" H, 26 lb

Colors

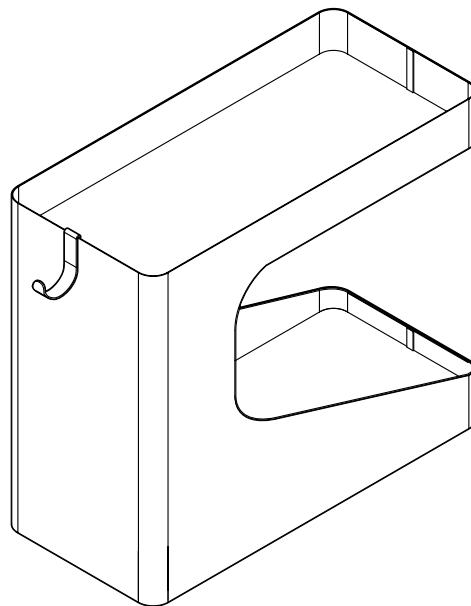
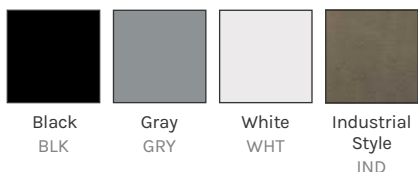

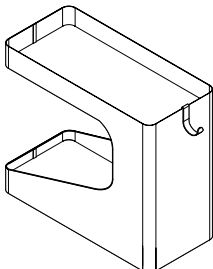
| | Additional Information | SKU | Weight | \$ Price |
|---|---|--------|----------|----------|
|  | <ul style="list-style-type: none"> • Material: Powder-coat paint • Available in Black, Gray, White and Industrial Style | STR027 | 18.63 lb | \$139 |

Storage Grommet

Turn your desktop's grommet hole into a built-in cup holder with the [Storage Grommet](#). You now can safely place your beverage within arms reach without the fear of knocking it over. You can also use the Storage Grommet for your pens, pencils, markers, keys, and any other small items.

Simply place the Storage Grommet into the grommet hole on your desktop and lock it into place by hand-tightening the locking ring on the underside of the desktop. It's a smart and simple way to keep your things nice and tidy!

Features

- Converts the grommet holes on UPLIFT Desk desktops to cup holders
- Create a place for your drinks, pens, and other small items
- Compatible with desktops between 3/4" and 1-3/4" thick
- Compatible with any 3.15" (80mm) diameter grommet hole

Specifications

- Dimensions: 3.75" W x 2.4" H
- Interior Cup Dimensions: 2.9" W x 2.3" H
- Material: Molded ABS Plastic
- Colors: Black, Gray, White

Colors

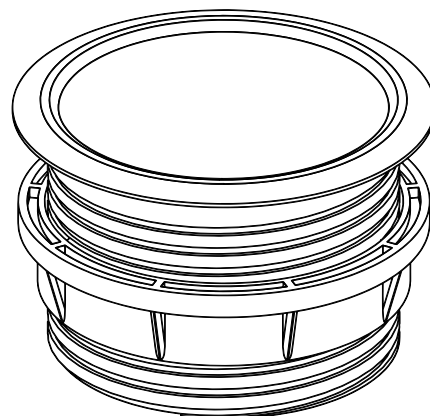

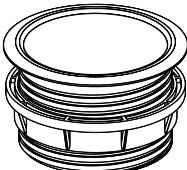
| | Additional Information | SKU | Weight | \$ Price |
|---|---|--------|--------|----------|
|  | <ul style="list-style-type: none"> • Converts the grommet holes to cup holders • Locks into place • Available in Black, Gray and White | ACC059 | 0.1 lb | \$19 |

Writing Desk Pad

The [Writing Desk Pad](#) protects your desk against indentations and accidental scratches while writing and improves your writing experience.

The Pad's smooth, easy-to-clean, polyurethane surface mimics the look fo real leather and is the perfect accessory for writng and mousing.

Features

- Preserves and protects your desktop surface from scratches and spills
- Serves as an integrated mouse pad with space for your keyboard
- Anti-slip surface protects any surface and keeps things in place
- Hides cords and removes clutter from the desktop

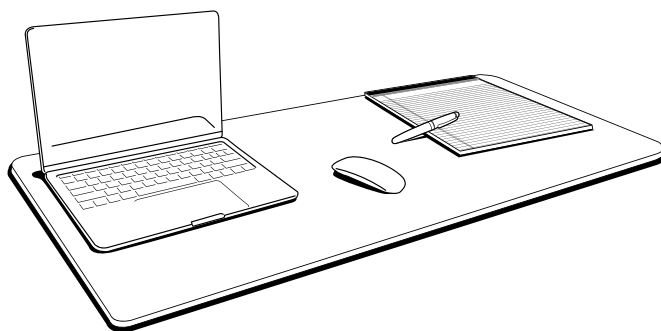

Specifications

- Dimensions: 36" W x 20" H x 0.1" D
- Material: Faux Leather (Polyurethane)

Colors

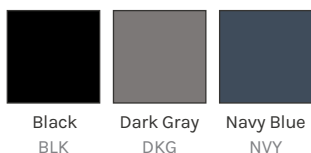

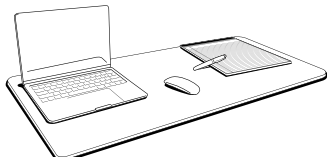
| | Additional Information | SKU | Weight | \$ Price |
|--|---|--------|--------|----------|
|  | <ul style="list-style-type: none"> • Ideal for wood desktops • Each side has grip properties • Available in Black, Gray and Navy | ACC045 | 1.5 lb | \$39 |

Glass Desk Blotter

Use the [Glass Desk Blotter](#) to protect your desk from scratches and provide a smooth writing surface without hiding the desktop's beauty.

Avoid the cost of a full glass desktop protector. Our budget-friendly clear glass pad protects the most-used area of your desk. The Optiwhite glass provides a clear finishes. The low iron content results in exceptional color neutrality and clarity.

Features

- Protect your desk without hiding the desktop's beauty
- Provides a smooth writing surface
- Pre-installed clear rubber bumpers keep the blotter in place
- Place photos, notes, calendars, or decor underneath for easy reference
- Write on top of the glass with dry-erase markers

Specifications

- Dimensions: 28" W x 18" H x .25" D
- Glass Type: Tempered Optiwhite (extra clear)
- Glass Edge: Beveled on top and bottom
- Bumpers: 6 clear rubber bumpers

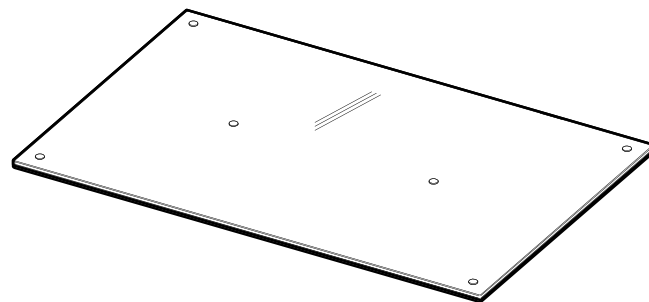

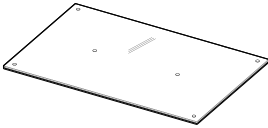
| | Additional Information | SKU | Weight | \$ Price |
|---|--|--------|----------|----------|
|  | <ul style="list-style-type: none"> • Glass protects desk from scratches • .24" thick tempered glass • Place photos, notes, calendars or decor under glass | ACC051 | 10.25 lb | \$95 |

Desktop Air Purifier

Use the [Desktop Air Purifier](#) to improve the air quality surrounding your desk by removing airborne particles from the air you breathe such as dust, allergens, and odors. Studies show that improved air quality increases productivity and performance.

True HEPA filter captures 99.7% of air particles that are 0.3 microns and larger while the activated carbon eliminates order and removes volatile organic compounds (VOCs), and other gaseous pollutants from the air.

Features

- Removes airborne particles from such as dust, allergens, and odors
- Portable, powerful and compact
- Made for personal spaces with ultra-quiet operation
- Automatic shut off mode after 8 hours of use
- Increases your productivity and performance

Specifications

- Power Type: 28" W x 18" H x .25" D
- Working Area: Tempered Optiwhite (extra clear)
- Filter Type: True HEPA & Active Carbon Filter
- Filter Life: 2-6 month intervals
- Size: 4.8" diameter x 7.5" H
- Color: White
- Working Voltage: 5V
- Power: 2W
- Negative Ion Output: 5 million/cm³
- Timer: 8 hours
- Noise: 28dB

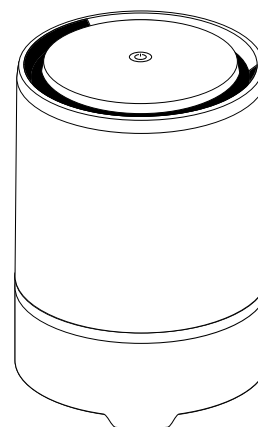

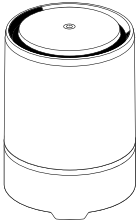
| | Additional Information | SKU | Weight | \$ Price |
|---|--|--------|--------|----------|
|  | <ul style="list-style-type: none"> • Improve air quality • Portable, powerful and compact • Includes one True HEPA filter | ACC061 | 1.1 lb | \$59 |

Desktop Air Purifier Replacement Filters

Use the [Desktop Air Purifier Replacement Filters](#) to keep you Desktop Air Purifier working at its maximum efficiency.

True HEPA and Activated Carbon Filter work seamlessly together to remove and neutralize allergens, dust, pet dander, odors, smoke, and bacteria. True HEPA filters are especially beneficial for those suffering from asthma or allergies.

Features

- Removes airborne particles from such as dust, allergens, and odors
- Removes up to 99.7% of air particles as small as 0.3 microns in size
- Covers an area of about 10 square meters (107.6 square feet)
- We recommend replacing your filter every 4-6 months

Specifications

- Filter Type: True HEPA & Active Carbon Filter
- Filter Life: 2-6 month intervals

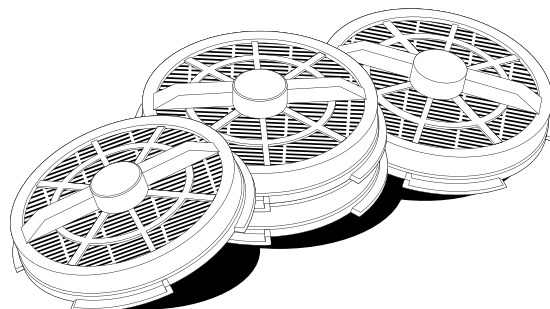

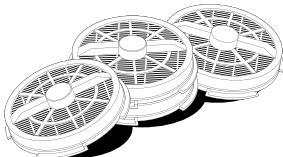
| | Additional Information | SKU | Weight | \$ Price |
|---|--|--------|--------|----------|
|  | <ul style="list-style-type: none"> • Removes 99.7% of air particles | ACC064 | 5.4 oz | \$39 |

Gel Pens

Use the [Gel Pens](#) for all your writing needs. They come with a soft grip coating that delivers a comfortable writing experience.

Easily coordinate your desk accessories by pairing with the matching gray Desk Organizer Set or any of our desk organizers.

Features

- Come in a pack of 6
- Blue gel ink
- 0.7 mm tip for precise note-taking
- Pocket clip feature to help you stay organized

Specifications

- Barrel Color: Gray
- Ink Color: Blue
- Tip Size: 0.7mm
- Quantity: 6 pack

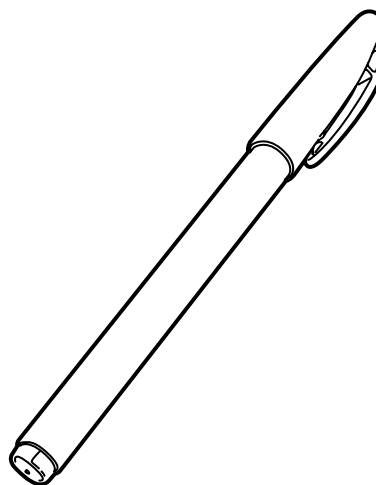

| | Additional Information | SKU | Weight | \$ Price |
|---|---|------------|--------|----------|
|  | <ul style="list-style-type: none"> • Soft grip • 0.7 mm tip | ACC117-GRY | 0.1 lb | \$12 |

LIGHTING

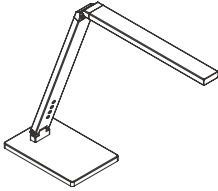
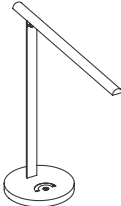
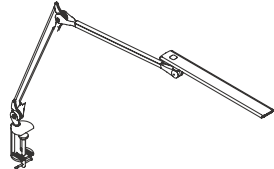

Product Comparison: Lighting

| | Illuminate LED Task Light  | E3 LED Desk Lamp  | E7 LED Desk Lamp with Clamp  |
|-----------------------|--|--|--|
| Price | \$75 | \$59 | \$79 |
| Specifications | | | |
| Stem Height | 15" H | 16" H | 15.5" H |
| Arm Length | N/A | N/A | 15" L |
| Desk Base Dimensions | 7.3" W x 4.9" D x .47" H | 5.8" D x .6" H | 7.9" diameter |
| Floor Base Dimensions | N/A | N/A | 13.6" diameter |
| Lamp Head Length | 13" L | 16.5" L | 13.6" L |
| Angle Adjustment | Lamp: 135° Chimney: 90° | 175° | Lamp head: 190° First joint: 110° Second joint: 210° |
| Max Wattage | 10 W | 12 W | 9 W |
| Light Temperature | Cool: 6000k Warm: 3000k Natural: 4500k | Cool: 6500K +/-10% Warm: 2700K +/-10% Natural: 4600K +/-10% | Cool: 6000K |
| Base Options | N/A | N/A | Clamp, Desk, & Floor Bases |
| Multiple Color Modes | ✓ | ✓ | — |
| Dimmer | ✓ | ✓ | ✓ |
| USB Connectivity | ✓ | — | — |
| Colors | Black & Silver | Black, Silver, & White | Lamp: Blue, Black, & White Bases: Black, Silver, & White |

Illuminate LED Task Light

The **Illuminate LED Task Light** lets users direct their light source via a swiveling lamp head with multiple modes of adjustability. Users can bend and pose the lamp thanks to rotating joints in the lamp and body. Three light setting modes (Cool, Warm, and Natural), with five levels of brightness for each, produce light for a variety of tasks and environments, while LED lights reduce energy consumption and last for years of work. The Illuminate comes with a USB port on the base.

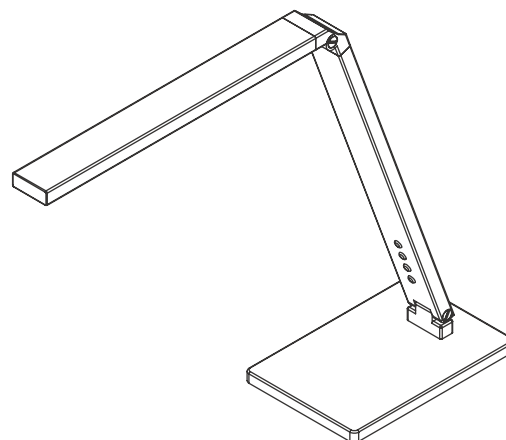

Features

- Upper arm swivels open upward, left, and right
- Collapsible upper arm
- 5 brightness levels
- Cool, warm, and natural light modes
- USB port

Specifications

[See complete spec sheet here](#)

- Stem Height: 15" H
- Desk Base Dimensions: 7.3" W x 4.9" D x .47" H
- Lamp Head Length: 13" L
- Angle Adjustment: Lamp: 135°
Chimney: 90°
- Max wattage: 10 W
- Light Temperature: Cool: 6000k, Warm: 3000k, Natural: 4500k

Colors



Black
BLK

Silver
SLV

Additional Information

- Compact design
- Available in Black and Silver

SKU

ACC024

Weight

2.2 lb

\$ Price

\$75

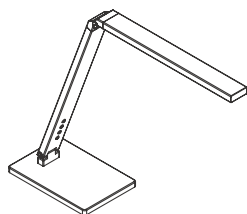

E3 LED Desk Lamp

Create your perfect lighting conditions for working, studying, or reading with our [E3 LED Desk Lamp](#) that features adjustable brightness and color temperature.

Press and hold the power button to cycle through light color temperatures - from a warm 2700K, to natural 4600K, to a cool 6500K, and anywhere in between. Slide your finger left or right for brightness adjustment, or tap the plus or minus to cycle through presets. Easily adjust the angle of the light and enjoy the benefits of long-lasting LED (rated for up to 30,000 hours).

Features

- Ideal for working, studying, or reading
- Rotate between warm, cool, and neutral light
- Thin, sleek design with discreet buttons

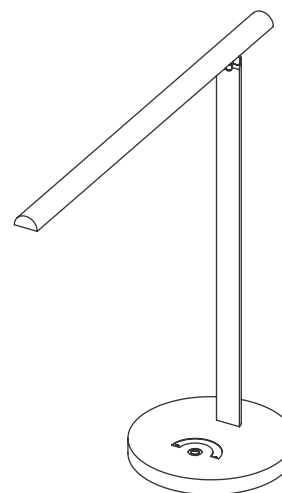

Specifications

[See complete spec sheet here](#)

- Stem Height: 16" H
- Base Dimensions: 5.8" D x .6" H
- Lamp Head Length: 16.5" L
- Angle Adjustment: 175°
- Max wattage: 12 W
- Max Lumens: 300
- Max Lux: 800
- Light Temperature: Cool: 6500K +/-10%
Warm: 2700K +/-10%
Natural: 4600K +/-10%

Colors

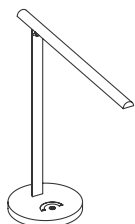

| | Additional Information | SKU | Weight | \$ Price |
|---|--|--------|------------|----------|
|  | <ul style="list-style-type: none"> • Material: Aluminum • UL Certification (Canada and U.S.) • Available in Black, Silver and White | LTG004 | 1 lb 10 oz | \$59 |

E7 LED Desk Lamp with Clamp

The [E7 LED Desk Lamp with Clamp](#) boasts a stepless dimming feature, allowing users to adjust to the perfect amount of light quickly and easily. Simply press and hold the power button to turn up or dim the light, and let go when the desired lighting is reached. A clamp mount allows the E7 to clamp onto desks up to 2.25" thick, and optional add-on desk and floor bases adapt the lamp to suit different users' lighting needs.

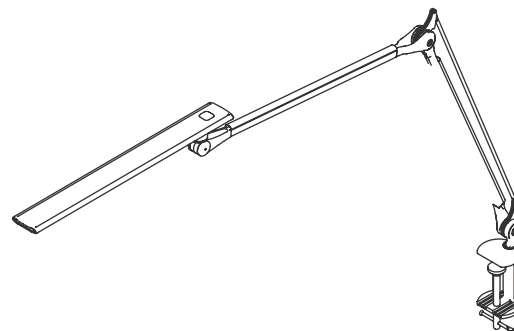

Specifications

[See complete spec sheet here](#)

- Stem Height: 15.5" H
- Arm Length: 15" L
- Desk Base Dimensions: 7.9" diameter
- Floor Base Dimensions: 13.6" diameter
- Lamp Head Length: 13.6" L
- Angle Adjustment: Lamp head: 190°
First joint: 90°
Second joint: 210°
- Max wattage: 9 W
- Light Temperature: Cool: 6000k

Colors



Black
BLK

Options Sold Separately

| Desk Base | Color | Diameter | Height | Material | SKU | Weight | \$ Price |
|-----------|-------|----------|--------|----------|-----|--------|----------|
|-----------|-------|----------|--------|----------|-----|--------|----------|

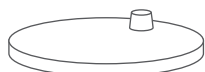

| | | | | | | |
|-----------------|------|------|-------|--------|-----------|------|
| Black or Silver | 7.9" | 1.6" | Steel | LTG002 | 5 lb 2 oz | \$20 |
|-----------------|------|------|-------|--------|-----------|------|

[See complete spec sheet here](#)

Floor Base



| | | | | | | |
|-----------------|------|-------|-------|--------|------|------|
| Black or Silver | 9.1" | 33.8" | Steel | LTG003 | 8 lb | \$25 |
|-----------------|------|-------|-------|--------|------|------|

[See complete spec sheet here](#)

Additional Information

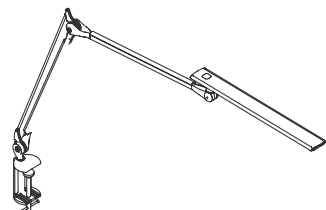



- Clamp Included
 - Material: High-grade aluminum alloy
 - Available in Black and White
- | | | |
|-------|-----------|------|
| LTG00 | 2 lb 2 oz | \$79 |
|-------|-----------|------|

POWER + DATA

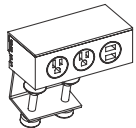

Product Comparison: Power + Data

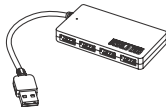
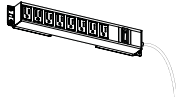
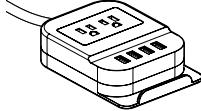
| | Clamp-On or Under-Mount Power with USB | Wireless Charging Power Hub | 4-Port USB 3.0 Hub | 8-Outlet Mountable Surge Protector | Power Hub with USB |
|-------------------------|---|---|--|---|---|
| |  |  |  |  |  |
| Price | \$45 | \$59 | \$20 | \$59 | \$39 |
| Specifications | | | | | |
| Dimensions | 5.5" W x 3.7" D x 6.1" H | 6.25" W x 6" D X 3" H | 3" W x 1.63" D x 0.45" H | 19" W x 1.75" D x 1.75" H | 5.75" W x 4" D x 1.5" H |
| Number of Outlets | 2 | 2 | 0 | 8 | 2 |
| Number of USB Ports | 2 | 3 | 4 | 0 | 4 |
| USB Capability | 5V/2.1 output | USB-A | 1.1, 2.0, and 3.0 | — | USB |
| A/C Rating | 120 volts, 12 amps | 120V AC (one per side) | N/A | N/A | 120 volts |
| Cord Length | 10' | 5' | 5.75" | 15' | 5' |
| Certifications | | | | | |
| ETL (Canada and U.S.) | ✓ | ✓ | N/A | ✓ | ✓ |
| Mounting Options | | | | | |
| Clamp | ✓ | — | — | — | — |
| Colors | Black and white | Black | Black | Black | White |

Clamp-On or Under-Mount Power with USB

With two power and two USB outlets within reach, the [Clamp-On or Under-Mount power with USB](#) allows you to charge your most essential devices within close range. Tool-free installation is designed with convenience in mind. Twist the bottom kobs to tighten the clamp. Once the power outlet is secured to your desk, plug into the wall using the attached 10' cord. Now you can begin charging your devices. The anti-slip neoprene pad located on the bottom of the power outlet will protect desktop surfaces from wear and tear. Use optional under desk mounting bracket to attach to the bottom of your desk.

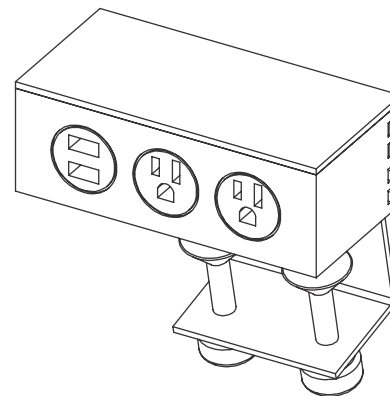

Features

- More powerful than most computer USB ports
- Anti-slip neoprene pad protects surfaces from scratches
- Tool-free installation - twist bottom knobs to tighten
- Includes 2 outlets and 2 USB ports

Specifications

[See complete spec sheet here](#)

- Number of Outlets: 2
- Number of USB Ports: 2
- USB Capability: 5V/2.1A Output, Shared
- A/C Rating: 120 Volts, 12 Amps
- Cord Length: 10' Long
- Certifications: ETL (Canada and U.S.)

*For desktops up to 1.75" thick

Colors

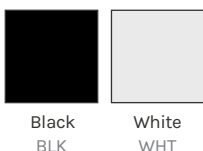

Additional Information

- Wide clamp range
- Two power outlets and USB ports
- Tool-free installation
- Available in Black and White

SKU

PDC003

Weight

1 lb 10 oz

\$ Price

\$45

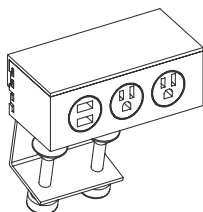

Wireless Charging Power Hub

Versatile and functional, the [Wireless Charging Power Hub](#) offers three ways to power your devices: two regular 120v power outlets, three USB outlets with a total output of 5v and 4.8 A; with 10 Watt wireless charging. If your phone is equipped with wireless charging capability, simply lean your phone against the charging area with your phone in the horizontal position.

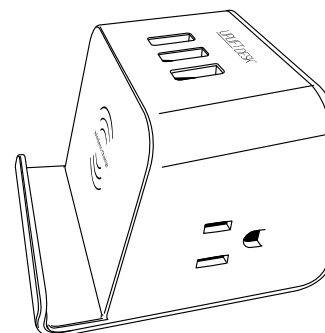

Features

- Two 120V power outlets
- Internal 300J surge protection ensures your devices are safe from voltage spikes
- Portable with 5-foot cord allows you to place unit within reach
- Blue LED indicator when powered

Specifications

[See complete spec sheet here](#)

- Wireless Charging: DC9V, 1.12A, 10W
- Ports & Outlets: 1875 Volts
- USB Port Output: 5VAC 4.8A total, 2.4A max per port
- ETL Certified: Yes
- Cord Wire Gauge: 14AWG
- Power Rating: 125V-, 15A, 1875W, 60Hz
- Power Surge Protection: 300 Joules
- Weight: 0.9 lb
- Color: Black

Colors

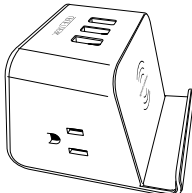

Black
BLK

| | Additional Information | SKU | Weight | \$ Price |
|---|---|--------|--------|----------|
|  | <ul style="list-style-type: none"> • 10 Watt wireless charging • Three USB-A ports • 5-foot cord • Available in Black | PDC010 | 0.9 lb | \$59 |

4-Port USB 3.0 Hub

Work better as you turn one USB port into four with the lightning-fast **4-Port USB 3.0 Hub**. Compact and portable to all your workplaces, this handy little USB hub will power and charge your devices in a flash. Transfer data on four USB 3.0 ports; rapid uploading and downloading speeds keep your work flowing and your mind on what matters—your work. Accepts a 120Vac input, 5Vdc (2A) power adapted (not provided) for faster device charging.

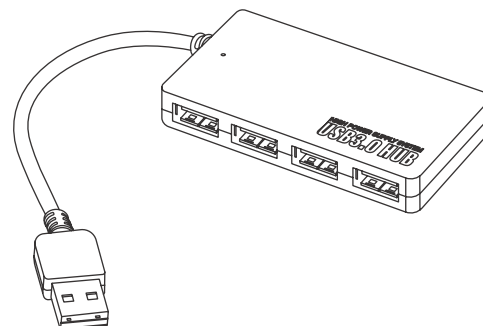

Features

- Connect up to 4 USB devices on a single hub
- Fast data transfer - up to 5 Gbps
- Compatible with USB 1.1, 2.0, and 3.0 devices
- Plug & play and hot swappable
- Easily portable to all your workspaces
- Includes type A ports

Specifications

- Number of USB Ports: 4
- USB Compatibility: 1.1, 2.0, and 3.0
- OS Compatibility: Windows 2000/XP/Vista/7/8
Linux
Mac OS 10.X or above

Colors

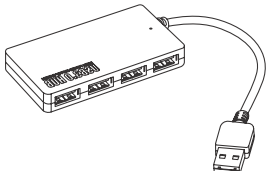

Black
BLK

| | Additional Information | SKU | Weight | \$ Price |
|---|--|--------|--------|----------|
|  | <ul style="list-style-type: none"> • Connect up to 4 USB devices • Easily portable • Fast data transfer • Available in Black | ACC013 | 1.1 oz | \$20 |

8-Outlet Mountable Surge Protector

The [8-Outlet Mountable Surge Protector](#) brings you a power source with surge protection and a slim profile that can mount under your desktop, keeping wires out of the way. Can mount under almost any desktop to face outlets down towards the floor. Or using the included brackets, mount to the front or back of the desk to face outlets towards or away from you. V2 mounting brackets allow surge protector to mount directly to our UPLIFT V2 frames.

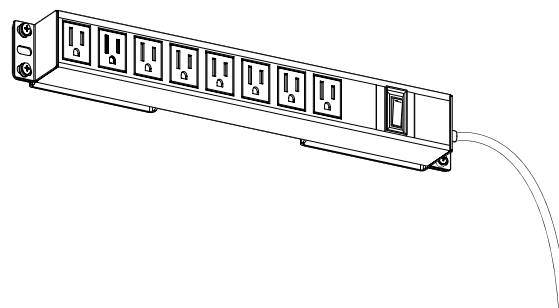

Features

- Keeps power outlets off the ground
- Can be attached so outlets face in the most optimal direction
- Includes 15' power cord and lighted on/off switch
- Hides cords and removes clutter from the desktop

Specifications

- Number of Outlets: 8
- Max Surge Voltage: 1875 Volts
- Cord Length: 15' Long
- Certifications: ETL (Canada and U.S.)

Colors



Black
BLK

Additional Information

SKU

Weight

\$ Price

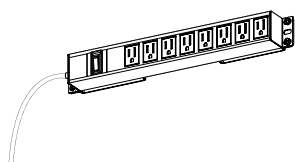

- Attaches in multiple ways
- Compatible with non-UPLIFT desks
- Available in Black

PDC006

4 lb

\$59

Power Hub with USB

The **Power Hub with USB** solves your search for outlets and charges all devices and accessories. Its rubber bumpers allow it to sit comfortably on any desk or table surface. It is easily moved for optimal convenience. Place the hub right on your desk or table—or easily mount to the wall with the provided screws.

Features

- keeps two outlets and four USB ports above-your-desktop and within reach
- Integrated front lip provides a convenient place to rest
- Sturdy five foot 16 AWG power cord with 3-prong grounded plug

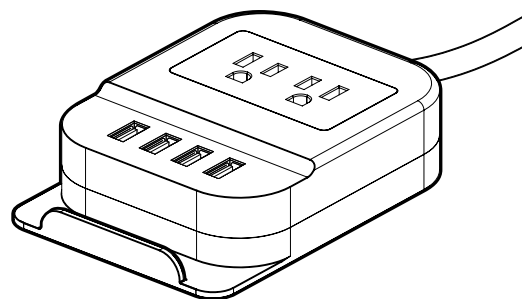

Specifications

- Number of Outlets: 2
- Max Surge Voltage: 120 Volts
- Cord Length: 5' Long
- Certifications: ETL (Canada and U.S.)

Colors



White
WHT

Additional Information

- Integrated front lip provides a convenient place to rest
- Two outlets and four USB ports
- Available in White

SKU

PDC007

Weight

4 lb

\$ Price

\$39

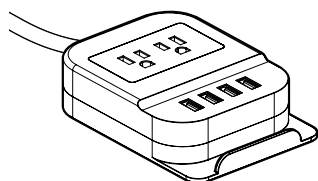

WIRE MANAGEMENT



Wire Management Accessories

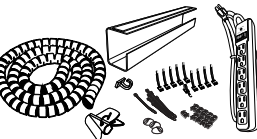
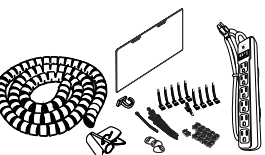

Wire Management Kits

| Basic Kit | | SKU | \$ Price |
|--|--|--------|----------|
|  <ul style="list-style-type: none"> • Kit comes with 12 screw-in cable mounts, 12 reusable cable ties, 10 adhesive cable mounts, 3 cable management clips, surge-protecting power strip, cable organizer, accessory hook, and hardware • Power strip offers 180J of surge protection for sit-stand desks • This accessory is also compatible with non-UPLIFT desks | | WMK001 | \$39 |
| Advanced Kit | | | |
|  <ul style="list-style-type: none"> • Cable Management Tray attaches easily to the underside of the desk, reroutes and shelters cords • 6-outlet Surge Protector outlet strip with a 15' heavy duty power cord • Cable Coil consolidates cords. Included wire funnel makes cable insertion and removal quick and easy • This accessory is also compatible with non-UPLIFT desks | | WMK002 | \$39 |
| Ultimate Kit | | | |
|  <ul style="list-style-type: none"> • Organizes cords and cables at your workstation • Comes with a 29" Modesty Panel with Wire Management, and everything included in the Basic Wire Management Kit - a 6-outlet surge protecting power strip, cord organizer, under-desk hook, cable management clips, screw-in cable mounts, reusable cable ties, and cable mounts • This accessory is also compatible with non-UPLIFT desks | | KIT011 | \$99 |

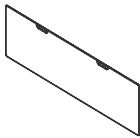
Wire Management Modesty Panels

| UPLIFT Modesty Panel with Wire Management | Width | | | |
|---|-------|---------------|-------|--|
|  <ul style="list-style-type: none"> • Able to conceal wide range of cables via velcro pouch • Added privacy feature for dual purpose use • Available in Black and White | 29.5" | WMK009-29-BLK | \$74 | |
| | 41.5" | WMK009-42-BLK | \$95 | |
| | 47.5" | WMK009-48-BLK | \$100 | |
| | 59.5" | WMK009-60-BLK | \$110 | |
| | 71.5" | WMK009-72-BLK | \$120 | |
| | 79.5" | WMK009-80-BLK | \$130 | |

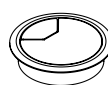
Grommets

| Grommet Cover | | | |
|---|-------|--------|------|
|  <ul style="list-style-type: none"> • Allows for through-desk cable routing • Rotating cover opens and closes • Available in Black, Gray and White | 3.75" | ACC011 | \$7 |
| Power Grommet | | | |
|  <ul style="list-style-type: none"> • Adds two extra UL-approved outlets to desktop • Screw-on Locking Ring keeps it secure and stable • Includes small hole to feed other cables through • Available in Black, Gray and White | 3.72" | PDC002 | \$69 |

Wire Management Accessories

Trays and Channels

| Wire Management Tray | SKU | \$ Price |
|---|--------|----------|
|  <ul style="list-style-type: none"> Protects your cords from stretching or pulling as desk is raised and lowered Accommodates surge protector devices and power adapters Available in Black | ACC002 | \$34 |

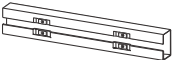
| Magnetic Cable Organizing Channel | Dimensions | SKU | \$ Price |
|--|-----------------------|--------|----------|
|  <ul style="list-style-type: none"> Secures and routes cables at desk for seamless height adjustment Hidden slot makes routing cords easy and discreet Available in Black, Gray, white and Industrial | 14.5" L x 2" W x 1" D | WMK007 | \$25 |

Clips, Ties, and Wraps

| Cable Management Clips | SKU | \$ Price |
|--|--------|----------|
|  <ul style="list-style-type: none"> Hold cords in place on desks Self-adhesive for semi-permanent placement Comes in a pack of six Available in Black | WMK003 | \$14 |

| Screw-In Cable Mounts | SKU | \$ Price |
|---|-----|---|
|  <ul style="list-style-type: none"> Pairs with reusable cable ties Helps keep cords securely mounted underneath your desk Not sold separately | | *Available in Wire Management Kits Only |

| Reusable Cable Ties | SKU | \$ Price |
|---|-----|---|
|  <ul style="list-style-type: none"> Pairs with screw-in cable mounts Organizes cords and keeps them securely mounted underneath desk Comes in a pack of 12 Not sold separately | | *Available in Wire Management Kits Only |

| Adhesive Readjustable Cable Tie Mounts | SKU | \$ Price |
|--|--------|----------|
|  <ul style="list-style-type: none"> Sticks to most smooth surfaces Clips can be opened and closed to add/remove cables Comes in a pack of 10 Available in Black | ACC014 | \$10 |

| Desk Cable Organizer | SKU | \$ Price |
|---|--------|----------|
|  <ul style="list-style-type: none"> Routes and shelters desk cords at workstation 5' long and 1" in diameter Available in Black | ACC015 | \$15.99 |

Wire Management Accessories

Zipped Cable Sleeve



- Allows you to simply and quickly add more cables
- Can hold up to 8-10 cables depending on size of cable
- Combine two or more sleeves
- Available in Black and Gray

Width

10"

SKU

WMK010-SHT

\$ Price

\$19

Magnetic Cable Clips

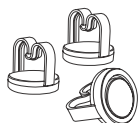

- Lets you stick cables directly to your desk frame
- Works by way of powerful neodymium magnets
- Comes in pack of 3
- Available in Black

WMK005

\$12.99

Hook and Loop Wire Wraps

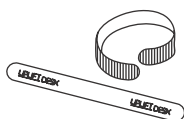

- Reusable wraps let you organize and secure your cords
- Adds additional wire management at sit-stand workstations
- Comes in pack of 2
- Available in Black

WMK006

\$4.99

Wire Management Modesty Panels

The [UPLIFT Modesty Panel with Wire Management](#) increases privacy underneath desks while providing more cable management. Users can bundle and hide cords within the discreet mesh panels, which protects them as they raise and lower their desks. Modesty Panels come in multiple size options and attach to desks via hanging clips.

Features

- Adds privacy under desk
- Includes pouch for wire management
- 15 year warranty

Specifications [See complete spec sheet here](#)

- Height: Side Panel: 15"
Back Panel: 15"
- Width: Side Panel: 29.5"
Back Panel: 41.5", 47.5", 59.5", 71.5", 79.5"
- Thickness: 1.25"

Colors



Black
BLK White
WHT

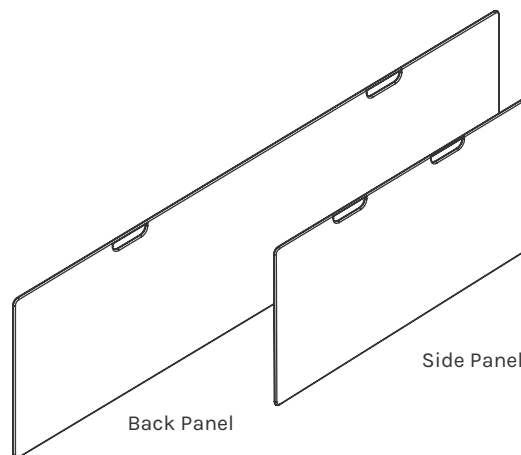

29.5" Side Panel

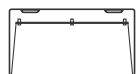

| Color | Width | Height | SKU | Weight | \$ Price |
|----------------|-------|--------|-----------|-----------|----------|
| Black or White | 29.5" | 15" | WMK009-29 | 1 lb 4 oz | \$74 |

**For side panel use, panel must be paired with spacer to fit frame (use SKU KIT009-29sa).*

Back Panel

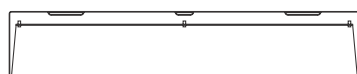

| | | | | | |
|----------------|-------|-----|-----------|------------|-------|
| Black or White | 41.5" | 15" | WMK009-42 | 1 lb 11 oz | \$95 |
| Black or White | 47.5" | 15" | WMK009-48 | 1 lb 14 oz | \$100 |
| Black or White | 59.5" | 15" | WMK009-60 | 2 lb 3 oz | \$110 |
| Black or White | 71.5" | 15" | WMK009-72 | 2 lb 11 oz | \$120 |
| Black or White | 79.5" | 15" | WMK009-80 | 2 lb 15 oz | \$130 |

Grommet Cover

Don't let subpar cable organization affect your productivity with [Grommet Cover](#). Enjoy work at a height adjustable desk without the mess with these handy desk grommets. These are installed at the back of your desk and feature a rotating cover that opens and closes when you need it.

Features

- Rotating cover opens and closes
- Sold individually
- Available in white, gray, and black
- This accessory is also compatible with non-UPLIFT desks

Specifications

- Dimensions: 3.15"
- Material: Molded ABS Plastic
- Colors: Black, Gray, White

Colors

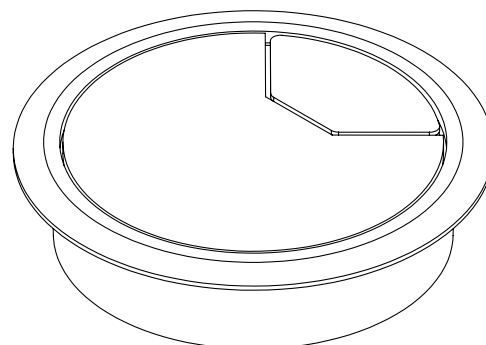
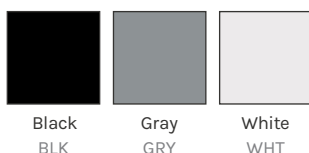

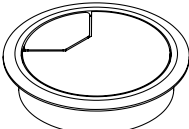
| | Additional Information | SKU | Weight | \$ Price |
|---|--|--------|--------|----------|
|  | <ul style="list-style-type: none"> • Rotating cover opens and closes • Sold individually • Available in Black, Gray and White | ACC011 | 0.1 lb | \$7 |

Power Grommet

Stop wasting time hunting down power outlets with UPLIFT Desk [Power Grommets](#).

Enjoy a more organized workstation and power everything right on your desktop. A slot in the grommet allows for threading of under-desk cables for less of a mess at your workstation. Now with three different color options to choose from, you can have the coordinated and power-full desk you've always wanted.

Features

- Comes with 2 outlets that consolidate into 1 cord (UL safety listed for the U.S. and Canada)
- Locks in place on desktops for seamless unplugging
- Available in black, gray, and white
- Sold individually

Specifications

- Dimensions: 3.72"
- Grommet Holes: 3.15" (80mm) diameter
- Material: Molded ABS Plastic
- Colors: Black, Gray, White

Colors

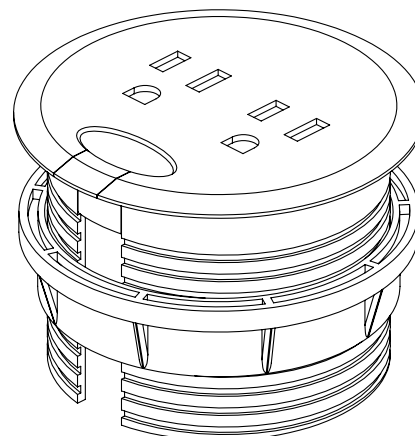

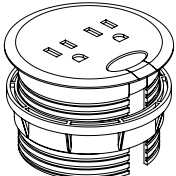

| | Additional Information | SKU | Weight | \$ Price |
|---|---|--------|--------|----------|
|  | <ul style="list-style-type: none"> • Locks in place on desktops for seamless unplugging • Sold individually • Available in Black, Gray and White | PDC002 | 0.1 lb | \$69 |

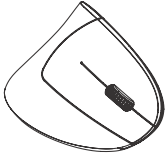
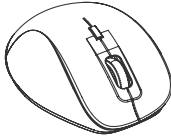

MICE + KEYBOARDS

Product Comparison: Ergonomic Mice

| | Wave Vertical Ergonomic Mouse (Right/Left, Wireless) | Whisper Click Mouse (Right, Wireless) | Swell Vertical Ergonomic Mouse (Right, Wireless) |
|------------------------------|---|--|---|
| |  |  |  |
| Price | \$25 | \$20 | \$30 |
| Specifications | | | |
| Dimensions | 4.9" L x 2.5" W x 3" H | 4.4" L x 3" W x 1.7" H | 4" L x 3.2" W x 3.4" H |
| Working Voltage | 3V | 3V | 5V |
| Working Current | 5 mA | 5 mA | 10 mA |
| Resolution | 800, 1200, 1600 DPI | 800, 1200, 1600 DPI | 1600 DPI |
| Battery Type | 2 AAA 1.5v batteries (not included) | 2 AAA 1.5v batteries (not included) | Rechargeable lithium battery |
| Supported Systems | Windows, Linux, Mac OSX | Windows, Linux, Mac OSX | Windows, Linux, Mac OSX |
| Wireless | ✓ | ✓ | ✓ |
| Left-hand Orientation Option | ✓ | – | – |
| Color | Black | Black | Black |

Wave Vertical Ergonomic Mouse

The comfortable and easy-to-use design of the Wave Vertical Ergonomic Mouse encourages healthy neutral wrist and arm positions for effortless movement with less wrist pressure and twisting. The DPI resolution can be adjusted from 800,1200, or 1600 for optimal tracking technology. The Wave mouse provides an excellent range of tracking sensitivity, on a broader range of surfaces than standard optical mice.

This product is also available in right or left-hand models, so it's perfect for anyone in the office. Ergonomically-Designed thumb rest and shape fit the contours of your palm for maximum comfort, which reduces pain and results in a happier work life. Additional mouse buttons can be used as next/previous buttons when browsing the web, action buttons for gamers, and can be utilized by other applications.

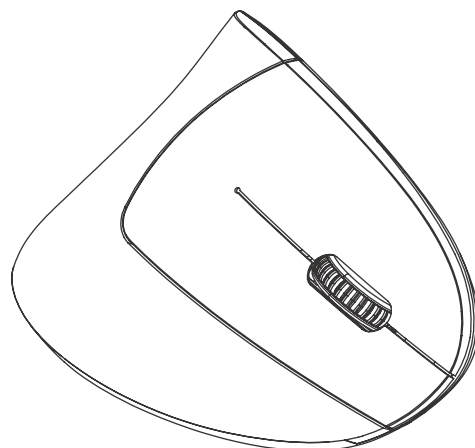

Features

- Ergonomic grip for comfortable movement
- Available in left and right-hand models
- Reduces pain with neutral wrist position
- Wirelessly connects via USB

Specifications

[See complete spec sheet here](#)

- Dimensions: 4.9" L x 2.5" W x 3" H
- Working Voltage: 3V
- Working Current: 5 mA
- Resolution: 800, 1200, 1600 DPI
- Supported Systems: Windows
Linux
Mac OSX

Colors



Black
BLK

| | Additional Information | Orientation | SKU | Weight | \$ Price |
|--|--|-------------|----------|--------|----------|
| | <ul style="list-style-type: none"> • Requires 2 AAA 1.5v batteries (not included) | Left | ACC050-L | 3 oz | \$25 |
| | | Right | ACC050-R | 3 oz | \$25 |

Whisper Click Mouse

The Whisper Click Mouse boasts comfortable contours that support your hand and fingers. The ergonomically-designed thumb rest and grips fit the shape of your palm for maximum comfort. Prevent future wrist pain while on the job. DPI of 800, 1200, or 1600 resolution can be adjusted for optical tracking technology to provide you with an excellent range of tracking sensitivity. Work on a broader range of surfaces than standard optical mice. Additional mouse buttons can be used as next and previous features in your internet browser, and action buttons for gamers are also available for set up.

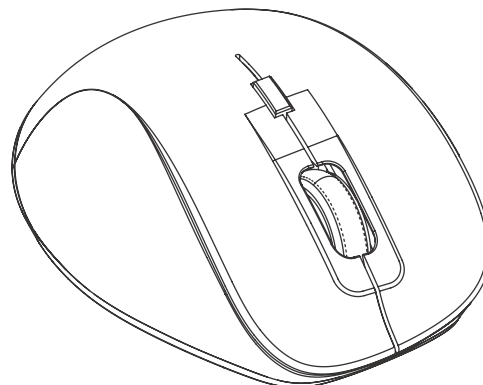

Features

- Comfortable contours support hand and fingers
- Prevent pain with ergonomically-designed thumb rest
- Whisper soft mouse clicks
- Wirelessly connects via USB

Specifications

[See complete spec sheet here](#)

- Dimensions: 4.4" L x 3" W x 1.7" H
- Working Voltage: 3V
- Working Current: 5 mA
- Resolution: 800, 1200, 1600 DPI
- Supported Systems: Windows
Linux
Mac OSX

Colors



Black
BLK

| | Additional Information | Orientation | SKU | Weight | \$ Price |
|---|--|-------------|----------|--------|----------|
|  | • Requires 2 AAA 1.5v batteries (not included) | Right | ACC053-R | 2.4 oz | \$20 |

Swell Vertical Ergonomic Mouse

The comfortable and easy-to-use design encourages healthy neutral wrist and arm positions for smoother movement and less strain and twisting. It's also ergonomically designed for smaller hands. The rechargeable battery is eco-friendly by eliminating the need for disposable batteries. The battery lasts for weeks on a single charge, but we recommend charging every 2-4 weeks for optimal use. Don't worry about draining the energy of your mouse when you're away from your desk. It automatically enters power saving mode after 15 minutes of idleness.

Additional buttons can also be used to return to previous pages when browsing the internet. The default DPI is set to 1600, but you have the option to adjust using computer settings.

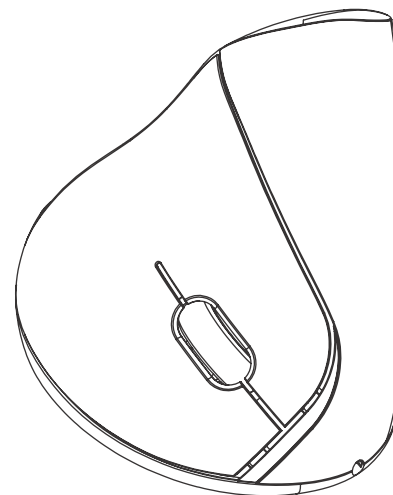

Features

- Ergonomic grip for comfortable movement
- Rechargeable battery
- Reduces pain with neutral wrist position
- Wirelessly connects via USB

Specifications

[See complete spec sheet here](#)

- Dimensions: 4" L x 3.2" W x 3.4" H
- Working Voltage: 5V
- Working Current: 10 mA
- Resolution: 1600 DPI
- Supported Systems: Windows
Linux
Mac OSX

Colors





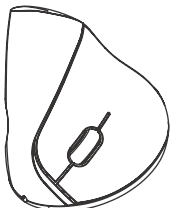

Black
BLK

| | Additional Information | Orientation | SKU | Weight | \$ Price |
|---|---|-------------|----------|--------|----------|
|  | <ul style="list-style-type: none"> • Built-in rechargeable lithium battery • Charging cord included | Right | ACC054-R | 3.4 oz | \$30 |

SEATING



Product Comparison: Seating - Chairs

| | Vert Ergonomic Office Chair  | Pursuit Ergonomic Chair  | J3 Ergonomic Chair  | Facet Ergonomic Chair  |
|------------------------------|--|--|---|--|
| Price | \$359 | \$329 | \$319 | \$249 |
| Specifications | | | | |
| Max User Weight | 250 lb | 250 lb | 250 lb | 250 lb |
| Seat Height Range | 15.7" - 19.7" | 17" - 21" | 18.7" - 22.3" | 17.9" - 21.9" |
| Adjustment Seat Depth | ✓ | – | ✓ | ✓ |
| Seat Depth | 17.3" - 19.7" | 19.3" | 17.3" - 19.3" | 17.3" - 18.9" |
| Seat Width | 19.7" | 18.5" | 19.3" | 19.3" |
| Seat Material | Fabric | Fabric | Leather | Fabric |
| Adjustable Arms | ✓ | ✓ | ✓ | ✓ |
| Adjustable Back Height | – | ✓ | ✓ | ✓ |
| Adjustable Back Tilt | ✓ | ✓ | ✓ | ✓ |
| Forward Tilt | – | – | – | – |
| Syncro-Tilt | ✓ | ✓ | – | ✓ |
| Back Tilt Lock | ✓ | ✓ | ✓ | ✓ |
| Back Tilt Tension Adjustment | Auto-weight Adjusts | ✓ | ✓ | Auto-weight Adjusts |
| Back Dimensions | 17" W x 22" H | 18" W x 22.4 - 25.2" H | 16.5" W x 22" - 24" H | 18.25" W x 19.7-23.8" H |
| Adjustable Lumbar Support | ✓ | ✓ | – | ✓ |
| Back Material | Mesh | Mesh | Mesh | Mesh |
| Headrest Height Adjust | – | ✓ | ✓ | ✓ |
| Headrest Tilt Adjust | – | – | ✓ | ✓ |
| Headrest Material | Mesh | Mesh | Mesh | Fabric |
| Warranty | 15 years | 15 years | 15 years | 15 years |
| Colors | White Frame / Gray Seat Black Frame / Black Seat | White Frame / Gray Seat Black Frame / Black Seat | Black Frame / Black Seat | Black Frame / Black Seat |

Vert Ergonomic Office Chair

With a back designed to mimic the spine, the [Vert Ergonomic Office Chair](#) provides ideal seated support via a collection of ergonomic adjustment features. The Vert's rib design works together with an elastomer spine system to increase flexibility along the entire back while soft-touch armrests can be raised and lowered to suit different users and tasks. The plush seat offers height and depth adjustment while the chair's mesh back blends support and breathability for the user. Available in black or white.

Features

- Back mimics human vertebrae to deliver more support
- Rib design and elastomer spine system for flexibility
- Mesh back improves airflow
- Plush seat buttresses lower half
- Armrest height adjustment
- Seat height and depth adjustment
- Lumbar support adjustment
- Syncro-tilt mechanism
- Back tilt lock with weight-sensing mechanism

Specifications

[See complete spec sheet here](#)

- Overall w/ Headrest: 27.5" W x 17.3" - 19.7" D x 46.4" - 50.4" H
- Seat Dimensions: 19.7" W x 17.3" - 19.7" D
- Seat Depth: 17.3" - 19.7" D
- Seat Height: 15.7" - 19.7" H
- Back Height: 17" W x 22" H
- Weight Capacity: 250 lb

Colors



Black
BLK

White
WHT

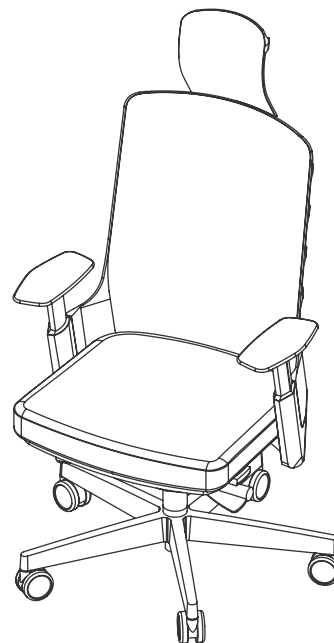

| | Additional Information | SKU | Weight | \$ Price |
|---|---|--------|------------|----------|
|  | <ul style="list-style-type: none"> • Made of materials 62% recyclable at the end of their life cycle • Available in Black and White | CHR458 | 34 lb 4 oz | \$359 |

Pursuit Ergonomic Chair

The [Pursuit Ergonomic Chair](#) combines ideal support and customizable adjustments to suit one user or many for use at shared workstations. Intuitive support via a synchro-tilt mechanism lets the seat and back angle adjust automatically and provides continuous support as users change from upright to reclining postures. The chair has a height-adjustable back, arms, and headrest. A soft cushion fabric seat and mesh back blend comfort and breathability, while a waterfall seat edge decreases pressure behind legs for better circulation.

Features

- Fabric seat with mesh back
- Armrest height adjustment
- Back adjustment
- Headrest adjustment
- Synchro-tilt mechanism
- Waterfall seat
- Back angle adjustment with tension control

Specifications

[See complete spec sheet here](#)

- Overall: 27.25" W x 27" D x 46 - 49.5" H
- Seat Depth: 18.5" W x 21" D
- Back Height: 22.5" W x 25" H
- Seat Height: 17.75" - 21"
- Weight Capacity: 250 lb

Colors

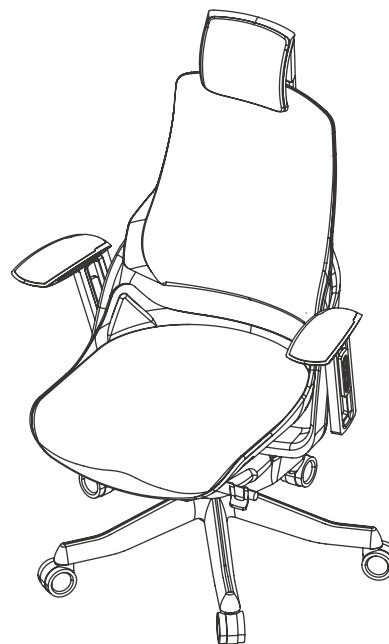

| | Additional Information | SKU | Weight | \$ Price |
|---|---|--------|-------------|----------|
|  | <ul style="list-style-type: none"> • Fabric seat • Height adjustable arms • Waterfall seat • Available in Black and White | CHR455 | 39 lb 12 oz | \$329 |

J3 Ergonomic Chair

The **J3 Ergonomic Chair** features an advanced design that suits most body types. Users have control over the chair's height, seat depth, armrests, and headrest position. A wider leather seat with a waterfall edge increases comfort while a mesh back improves airflow to the back. The responsive and intuitive lumbar support provides comfort and support without the need for manual readjustments.

Features

- Height adjustment
- Seat depth adjustment
- Armrest height adjustment
- Back height adjustment
- Back tilt adjustment
- Headrest adjustment
- Mesh back
- Wide seating area
- Slightly contoured leather seat
- Supportive lumbar support

Specifications

[See complete spec sheet here](#)

- Overall: 25.6" W x 23.6" - 25.2" D x 44.1" - 52.4" H
- Seat Depth: 19.3" W x 19.5" D
- Back Height: 19.5" W x 22" - 24" H
- Seat Height: 18.7" - 22.3"
- Weight Capacity: 250 lb

Colors



Black
BLK



Additional Information

- Available in Black

SKU

CHR456

Weight

46 lb 8 oz

\$ Price

\$319

Facet Ergonomic Chair

The Facet Ergonomic Chair is a budget-friendly option with advanced adjustable features to ensure a perfect fit. The breathable mesh fabric allows for airflow, so you stay cool while seated, and the soft seat cushion delivers extra support. Synchro-tilt is an adjustable mechanism for back and seat resistance. This ensures that the backrest reclines when you lean backward and allows your feet to stay on the floor. Optional height and tilt-adjustable headrest support both your back and neck so you can focus on more critical tasks.

Features

- Height adjustment
- Seat depth adjustment
- Armrest height adjustment
- Back height adjustment
- Syncro-tilt mechanism
- Back tilt lock with weight-sensing adjustment
- Headrest height and angle adjustment
- Mesh back
- Adjustable lumbar support

Specifications

[See complete spec sheet here](#)

- Overall: 27.6" W x 27.6" D x 43.7-50.4" H
- Seat Depth: 17.3" W x 18.9" D
- Back Height: 19.7-23.8" H
- Back Width: 18" W
- Seat Height: 17.9" - 21.9"
- Seat Width: 19.3"
- Weight Capacity: 250 lb

Colors





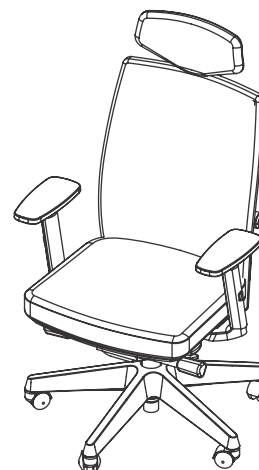

Black
BLK

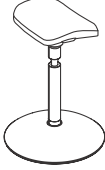
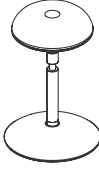

| | Additional Information | SKU | Weight | \$ Price |
|---|--|--------|---------|----------|
|  | <ul style="list-style-type: none"> • Complies with ANSI/BIFMA X5.1-2017 standards • Available in Black | CHR466 | 39.6 lb | \$249 |

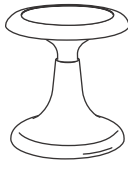
Product Comparison: Stools

| | Starling Stool | Crescent Saddle Stool | Donut Stool | Motion Stool | Kids Active Stool | Ergonomic Kneeling Chair |
|-----------------------|---|---|---|--|---|---|
| |  |  |  |  |  |  |
| Price | \$149 | \$59 | \$89 | \$89 | \$61 | \$99 |
| Specifications | | | | | | |
| Seat Height Range | 23.6" - 33.2" | 23.8" - 29.7" | 24.2" - 30.1" | 23.5" - 33.5" | 15" or 17" options (not adjustable) | N/A |
| Usable Seat Depth | 14.2" D | 10.5" | 13.88" | 13" D | 12" D | 12" D |
| Usable Seat Width | 14.9" W | 15.75" | 13.88" | 13" W | 12" W | 16" W |
| Max User Weight | 297.6 lb | 220 lb | 220 lb | 300 lb | 250 lb | 200 lb |
| Seat Material | Fabric | Fabric | Fabric | Fabric | Rubber | Fabric |
| Seat Pivot | 360° | 360° | 360° | 360° | — | N/A |
| Colors | Myrtle Green, Blue, Orange, Gray, & Brown | Orange, Turquoise, & Green | Red & Black | Blk Frame / Blue Seat Blk Frame / Black Seat | Blue | Gray & Blue |

Starling Stool

The **Starling Stool** tilts to relieve pressure off your feet, aligning your spine into a neutral position and combating fatigue that comes from sitting or standing all day. With 360 degrees of rotation and 10 degrees of tilt, this ergonomic stool lets you rotate and move from side to side for more stimulating work. Its waterfall seat edge and tilting motion allow the Starling Stool to relieve pressure on the rear of your legs and engage your core muscles for a healthier workday.

Features

- Waterfall edge on seat reduces pressure points
- Sturdy and lightweight frame for easy carrying
- Sit, stand, and perch to promote an active workday

Specifications

[See complete spec sheet here](#)

- Seat Dimensions: 14.9" W x 14.2" D
- Height Adjustment: 24.5" - 34.1" H
- Weight Capacity: 297.6 lb
- Seat Pivot: 360°

Colors

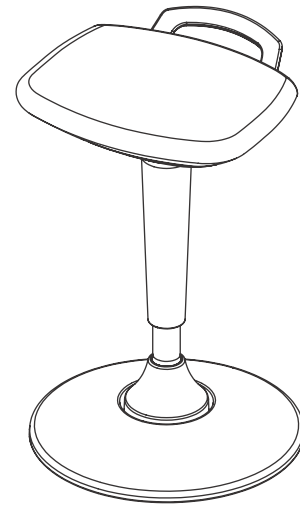
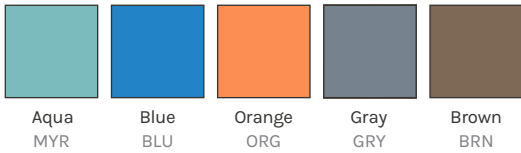

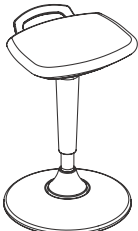
| | Additional Information | SKU | Weight | \$ Price |
|---|--|--------|------------|----------|
|  | <ul style="list-style-type: none"> • Height adjustable • 360 degrees of rotation and 10 degrees of tilt • Available in Myrtle Green, Blue, Orange, Gray and Brown | CHR464 | 11 lb 6 oz | \$149 |

Crescent Saddle Stool

The **Crescent Saddle Stool** offers a dynamic range of motion that encourages activity. An excellent ergonomic setup prompts you to switch between sitting and standing throughout your workday. Sway and tilt comfortably on the 360-degree swivel seat. This height-adjustable stool features breathable, textured mesh that increases friction to help you stay on your seat. Mix things up and take the pressure off your feet and legs as you work and perch atop the stool.

Features

- The dynamic range of motion encourages activity
- Sit in traditional or straddled postures
- Sway and tilt comfortably on the 360-degree swivel seat

Specifications

[See complete spec sheet here](#)

- Seat Dimensions: 15.75" W x 10.5" D
- Base Dimensions: 16.3" Diameter
- Height Adjustment: 23.8" - 29.7" H
- Weight Capacity: 220 lb
- Seat Pivot: 360°

Colors

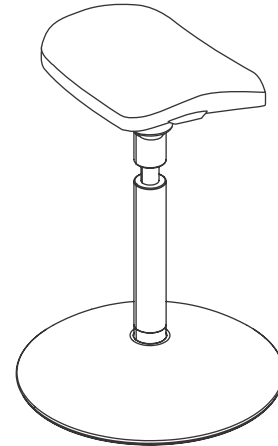
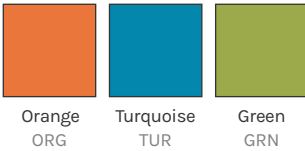

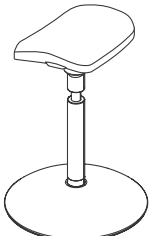
| | Additional Information | SKU | Weight | \$ Price |
|---|--|--------|-------------|----------|
|  | <ul style="list-style-type: none"> • Fire safety: CA117 • Available in Orange, Turquoise and Green | CHR459 | 11 lb 10 oz | \$89 |

Donut Stool

We designed the [Donut Stool](#) to let you lean, stretch, and shift while at your desk. The unique cushion shape includes a soft dip that can reduce pressure on your tailbone or glutes, reposition as needed. Soothe your back, boost your circulation, and protect against injuries that result from sedentary office work.

Features

- Stay active with the dynamic range of motion
- Breathable and textured mesh fabric
- Lightweight design for easy mobility

Specifications

[See complete spec sheet here](#)

- Seat Dimensions: 13.88" Diameter
- Base Dimensions: 15.16" Diameter
- Height Adjustment: 24.2" - 30.1" H
- Weight Capacity: 220 lb
- Seat Pivot: 360°

Colors



Red
RED

Gray
GRY

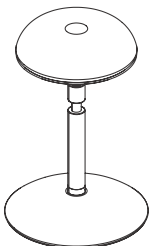
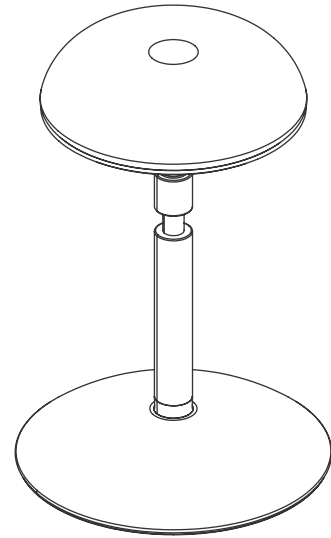

Additional Information

- Fire safety: CA117
- Available in Red and Gray

SKU

CHR460

Weight

10 lb 12 oz

\$ Price

\$89

Motion Stool

Plush and supportive, the **Motion Stool** supports users in postures that offer more movement than traditional office chairs. The stool provides 10" of height adjustment and a convex base allows the stool to pivot a complete 360°. A treaded grip with a semi-soft elastomer on the base grips the floor for stability while a weighted base keeps the stool stable and upright throughout a full range of motion.

Features

- Easy-to-reach buttons deliver 10" of height adjustment
- Stable Base throughout full range of motion
- Circular seat cushion with waterfall edges
- 360° rotation
- Semi-soft elastomer on base grips floors

Specifications

[See complete spec sheet here](#)

- Seat Width: 13" W
- Height Adjustment: 23.5" - 33.5" H
- Weight Capacity: 300 lb
- Leg Pivot: 360°

**For users 5'2" and taller*

Colors



Black
BLK

Blue
BLU

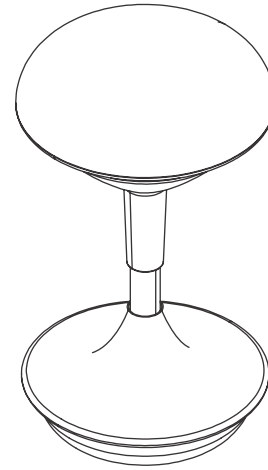

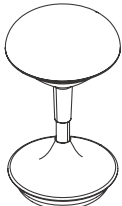
| | Additional Information | SKU | Weight | \$ Price |
|---|---|--------|-------------|----------|
|  | <ul style="list-style-type: none"> • Fire safety: TB117-2013 compliant • Gas spring covered with silver epoxy powder coat finish • Black shell body is molded polypropylene • Available in Black and Blue | CHR454 | 20 lb 12 oz | \$98 |

Kids Active Stool

Let kids wobble, fidget, and perch for a more dynamic seating experience with the [Kids Active Stool](#). Growing bodies need to stay active to learn and stay healthy. The convex and comfortable seating is made of rubber for a better grip while seated. The slip-resistant base is ideal for kids on the move.

Features

- Fixed height wobble stool for kids Pre-K to 5th grade
- Wiggle, fidget and perch for more dynamic seating
- Doubles as a side seat with height-adjustable desks

Specifications

[See complete spec sheet here](#)

- Seat Dimensions: 12" Diameter
- Base Dimensions: 11.2" Diameter
- Stool Height: 15" or 17"
- Weight Capacity: 250 lb

Colors

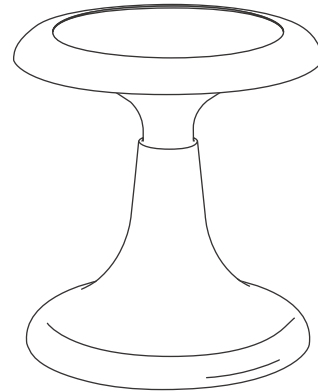

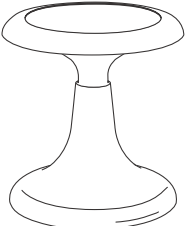
| | Additional Information | Height | SKU | Weight | \$ Price |
|---|-------------------------|--------|--------|------------|----------|
|  | • Convex and comfy seat | 15" | CHR461 | 6 lb 6 oz | \$61 |
| | • No assembly required | 17" | CHR462 | 6 lb 10 oz | \$61 |
| | • Available in Blue | | | | |

Ergonomic Kneeling Chair

The [Ergonomic Kneeling Chair](#) properly aligns your back, shoulders, and neck, and engages your core, so you stay healthy and comfortable. Enjoy lower back pain relief, improved circulation, and more energy with an active sitting solution that encourages proper posture and strengthens muscles. A kneeling position allows you to shift your weight to accommodate a variety of situations.

Features

- Thicker knee padding for stability and comfort
- Combats poor posture by keeping you from slumping
- Sit in a more upright position with an open hip angle

Specifications

[See complete spec sheet here](#)

- Seat Dimensions: 16" W x 12" D
- Kneepad Dimensions: 6" W x 10.25" D
- Weight Capacity: 200 lb

Colors

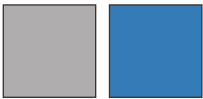

Gray
GRN

Blue
BLU

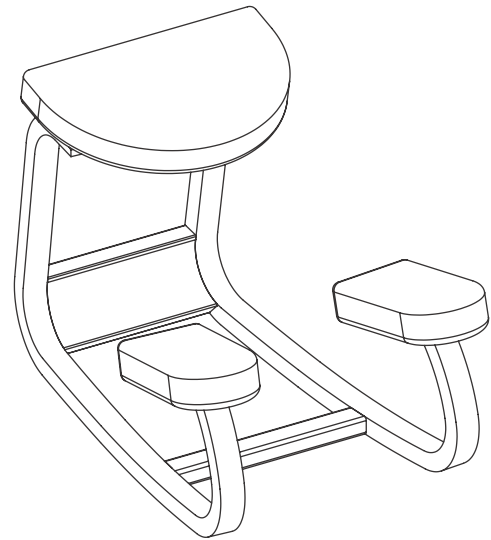

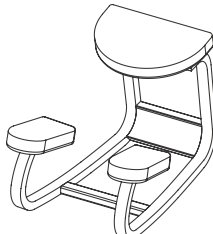

| | Additional Information | SKU | Weight | \$ Price |
|---|--|--------|------------|----------|
|  | <ul style="list-style-type: none"> • Material: Bent birch wood frame, fabric cushions • Available in Gray and Blue | CHR463 | 10 lb 6 oz | \$99 |

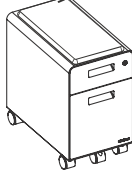

STORAGE

Product Comparison: File Cabinets

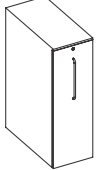
| | 2-Drawer File Cabinet with Seat, Rolling  | Narrow 2-Drawer File Cabinet with Seat, Rolling  | 3-Drawer File Cabinet, Rolling  | Slide Out Office Storage Cabinet  |
|------------------------------|---|--|---|---|
| Price | \$249 | \$239 | \$259 | \$999 |
| Specifications | | | | |
| Cabinet Dimensions | 15.75" W x 19.7" D x 19.75" H (w/ casters) | 11.8" W x 19.7" D x 19.75" H (w/ casters) | 15.75" W x 19.75" D x 24.5" H (w/ casters) | 15.1" W x 31.4" D x 45.4" H |
| Weight Capacity | 225 lb | 225 lb | 225 lb | N/A |
| Top Seat | Optional | Optional | | |
| Portable (w/ casters) | ✓ | ✓ | ✓ | |
| Privacy Lock | ✓ | ✓ | ✓ | ✓ |
| Soft Close Drawer | ✓ | ✓ | ✓ | |
| Grommet | | | | ✓ |
| ANSI/BIFMA Compliance | ✓ | ✓ | | |
| Colors | Black, Gray, White, and Industrial Style | Black, Gray, White, and Industrial Style | Black, Gray, White, and Industrial Style | Black & White |

2-Drawer File Cabinet with Seat, Rolling

The [2-Drawer File Cabinet with Seat, Rolling](#) combines storage and seating to provide users a multifunctional mobile storage solution. A soft cushion on top makes it suitable for short-term seating while two locking drawers secure personal items, from paper to purses. The large bottom drawer holds letter and legal sized paper, and the soft-close top drawer comes with a removable accessory tray that helps organize smaller items.

Features

- Drawers lock for security
- Bottom drawer adapts to hold paper and folders
- Removable tray in top drawer organizes smaller items
- Adhesive padded seat cushion for comfortable sitting
- Top drawer comes with a soft-close function

Specifications

[See complete spec sheet here](#)

- Dimensions: 15.75" W x 19.7" D x 19.75" H (w/ casters)
- Weight Capacity: 225 lb

Colors

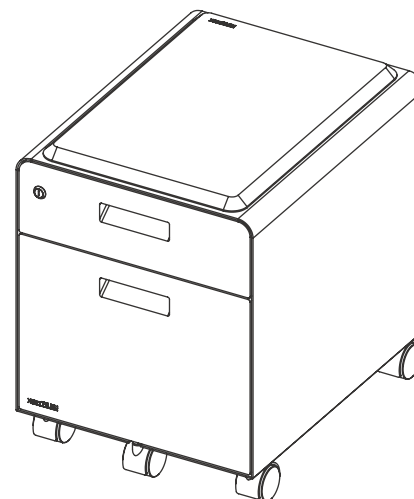
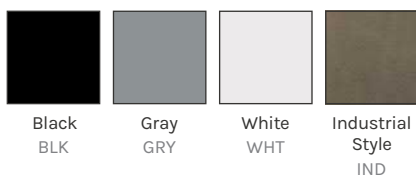

Additional Information

SKU

Weight

\$ Price

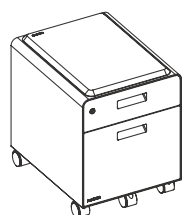

- Privacy Lock
- Finish: Powder-coat paint
- Material: Steel
- Available in Black, Gray, White and Industrial

STR002

40 lb 10 oz

\$249

Narrow 2-Drawer File Cabinet with Seat, Rolling

The [Narrow 2-Drawer File Cabinet with Seat, Rolling](#) adds more storage to compact spaces and lets users clean up clutter by organizing personal things within its two roomy locking drawers. This multifunctional seating/storage solution fits neatly underneath UPLIFT Desks to provide ample storage at sit-stand workstations. A smaller top drawer features a soft-close function and comes with removable accessory tray, and its spacious bottom drawer can be adapted with a hanging bar to hold letter and legal sized paper. The cabinet also comes with a removable anti-fatigue cushion with reusable adhesive for short-term seating.

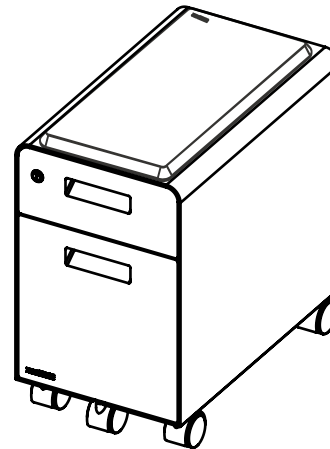

Features

- Drawers lock for security
- Narrow design fits in compact spaces
- Bottom drawer adapts to hold paper and folders
- Removable tray in top drawer organizes smaller items
- Adhesive padded seat cushion for comfortable sitting
- Top drawer comes with a soft-close function

Specifications

[See complete spec sheet here](#)

- Dimensions: 11.8" W x 19.7" D x 19.75" H (w/ casters)
- Weight Capacity: 225 lb

Colors



| | Additional Information | SKU | Weight | \$ Price |
|---|--|--------|------------|----------|
|  | <ul style="list-style-type: none"> • Privacy Lock • Finish: Powder-coat paint • Material: Steel • Available in Black, Gray, White and Industrial | STR006 | 35 lb 8 oz | \$239 |

3-Drawer File Cabinet, Rolling

The mobile, secure [3-Drawer File Cabinet, Rolling](#) blends the best in storage and security to offer users a portable three drawer cabinet that locks. The bottom drawer holds letter and legal sized paper, while the top drawers are roomy enough for office odds and ends, from notepads to snacks. A soft-close function on the top drawer eliminates drawer slams, and the cabinet comes with a removable accessory tray that fits in the two top drawers. All drawers lock via a single lock and key.

Features

- Drawers lock for security
- Top two drawers hold a removable pencil tray
- Bottom drawer adapts to hold paper and folders
- Top drawer comes with a soft-close function

Specifications

[See complete spec sheet here](#)

- Dimensions: 15.75" W x 19.75" D x 24.5" H (w/ casters)

Colors



| | Additional Information | SKU | Weight | \$ Price |
|---|--|--------|--------|----------|
|  | <ul style="list-style-type: none"> • Privacy Lock • Finish: Powder-coat paint • Material: Steel • Available in Black, Gray, White and Industrial | STR003 | 51 lb | \$259 |

Slide Out Office Storage Cabinet

The [Slide Out Office Storage Cabinet's](#) drawer has two large internal compartments to sort, store, and shelter larger items, while a smaller top shelf is perfect for organizing smaller objects. The spacious drawer locks for additional security.

Features

- Tower locks for more security
- Two internal compartments sort, store, and shelter items
- Grommet on backside for easy routing of cords

Specifications

[See complete spec sheet here](#)

- Overall: 15.25" W x 31.5" D x 45.125" H
- Inner Compartments: 11.2" W x 25.5" D x 17" H
- Upper Shelf: 11.2" W x 25.5" D x 6.3" H

Colors

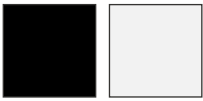

Black
BLK

White
WHT

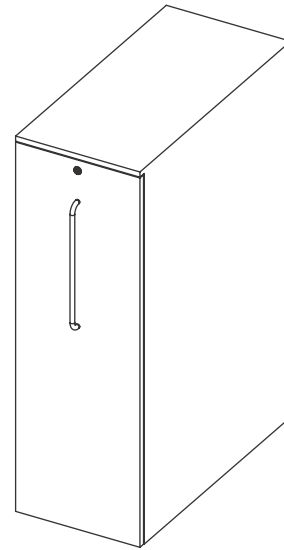

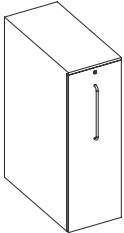
| | Additional Information | Color | Placement | SKU | Weight | \$ Price |
|---|---|----------------|---------------|----------|--------|----------|
|  | • Available in Black and White | Black or White | Right of Desk | STR012-R | 126 lb | \$999 |
| | • Available in left of desk and right of desk options | Black or White | Left of Desk | STR012-L | 126 lb | \$999 |



DESK DRAWERS +CUBBIES

Product Comparison: Desk Drawers + Cubbies

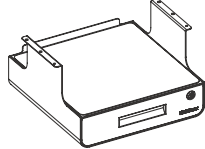
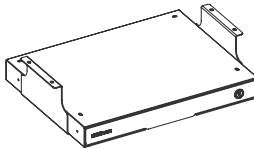
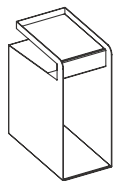
| | Locking Under Desk Drawer with Shelf  | Slim Under Desk Storage Drawer  | Hanging Storage Cubby  |
|-----------------------|---|--|--|
| Price | \$149 | \$99 | \$99 |
| Specifications | | | |
| Drawer Dimensions | 13.2" W x 13.5" L x 7.5" H | 17.2" W x 13.5" D x 2" H (4.3" H w/ brackets) | 7.3" W x 14" D x 17.75" H |
| Storage Dimensions | 12" W x 12" D x 3.25" H | 16" W x 13" D x 2" H | 7.9" W x 7.5" D x 1.2" H |
| Shelf Dimensions | 13" W x 13" D x 3.75" H | 18.8" W x 13" D x 2.3 H (w/brackets only) | 7.3" W x 13.75" D |
| Min Desktop Thickness | 3/4" | 3/4" | N/A |
| Max Desktop Thickness | N/A | N/A | 1.75" |
| 360° Rotation | – | – | – |
| Security Lock | ✓ | ✓ | – |
| Top Shelf | ✓ | Optional | ✓ |
| Accessories | | | |
| Hanging Brackets | ✓ | ✓ | – |
| Mounting | | | |
| Hardware Needed | ✓ | ✓ | N/A |
| Colors | Black, Gray, White, and Industrial Style | Black, Gray, White, and Industrial Style | Black, Gray, and White |

Product Comparison: Desk Drawers + Cubbies

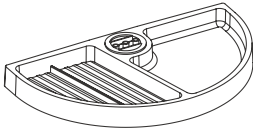
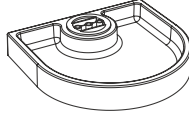
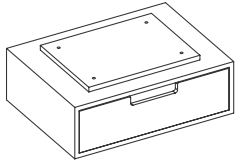
| | Large Half Circle Desk Drawer  | Small Half Circle Desk Drawer  | Bamboo Desk Drawer  |
|-----------------------|--|---|---|
| Price | \$49 | \$39 | \$119 |
| Specifications | | | |
| Outer Dimensions | N/A | N/A | 9.9" D x 4.4" H x 13.4" W |
| Inner Dimensions | 13.8" W x 8.4" D x 1.25" H | 7.9" W x 7.5" D x 1.2" H | 8.9" D x 2.9" H x 12.3" W |
| Shelf Dimensions | N/A | N/A | N/A |
| Min Desktop Thickness | 3/4" | 3/4" | 3/4" |
| Max Desktop Thickness | N/A | N/A | N/A |
| 360° Rotation | ✓ | ✓ | – |
| Security Lock | – | – | – |
| Top Shelf | – | – | ✓ |
| Accessories | | | |
| Hanging Brackets | – | – | – |
| Mounting | | | |
| Hardware Needed | ✓ | ✓ | ✓ |
| Colors | Black, Gray, and White | Black, Gray, and White | Bamboo |

Locking Under Desk Drawer with Shelf

The [Locking Under Desk Drawer with Shelf](#) blends security and storage for desks that are lacking adequate drawer space. Featuring a 12" by 12" drawer that locks and a 13" by 13" shelf on top for easy storage of flat items like laptops, the drawer is easy to install underneath desks for a quick way to increase storage space.

Features

- Sliding drawer locks for security
- Shelf above drawer holds items like tablets and laptops
- Guard stop near back of shelf ensures items don't fall

Specifications

[See complete spec sheet here](#)

- Outer Drawer: 13.2" W x 13.6" D x 7.5" H
- Inner Drawer: 12" x 12"
- Shelf: 13" x 13"

*Desktops must be at least 1" thick

Colors

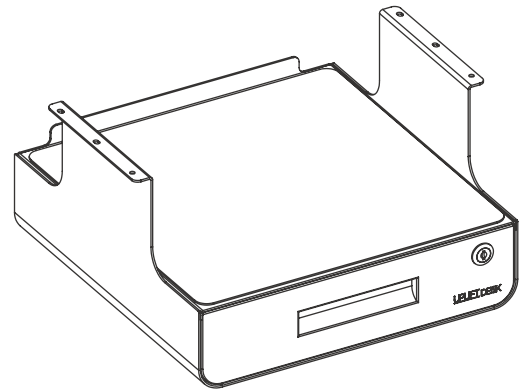

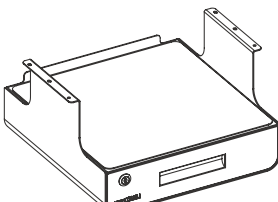
| | Additional Information | SKU | Weight | \$ Price |
|---|---|--------|-------------|----------|
|  | <ul style="list-style-type: none"> • Privacy Lock • Top Shelf • Available in Black, Gray, White and Industrial | STR001 | 17 lb 14 oz | \$149 |

Slim Under Desk Storage Drawer

Users get close-by desk storage with the [Slim Under Desk Storage Drawer](#) mounted to the underside of their desks. The slim, yet spacious, drawer holds a variety of items, including laptops up to 15" wide, and locks for extra security. Optional add-on brackets should be used if working at a desk with a depth of 24" or less.

Features

- Sliding drawer locks for security
- Storage brackets included for optional upper shelf

Specifications

[See complete spec sheet here](#)

- Dimensions w/o Brackets: 17.2" W x 13.5" D x 2" H
- Dimensions w/ Brackets 17.2" W x 13.5" D x 4.3" H

Colors

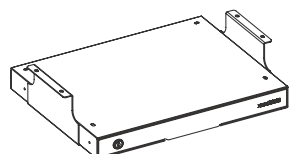
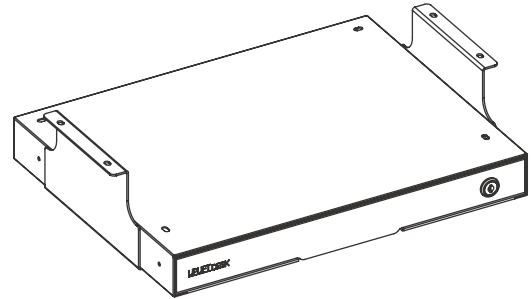

| Additional Information | SKU | Weight | \$ Price |
|--|--------|-------------|----------|
| <ul style="list-style-type: none"> • Privacy Lock • Available in Black, Gray, White and Industrial | STR008 | 12 lb 10 oz | \$99 |

Hanging Storage Cubby

Users have a ready-to-use storage option with the [Hanging Storage Cubby](#). The 7.3" wide x 17.5" tall x 14" deep storage compartment holds a variety of items at height adjustable workstations, including 3-ring binders, laptops, purses, and small briefcases. Made from steel, the top and bottom are softly padded to prevent scratches and the cubby slides securely onto desks up to 1.75" thick, no tools necessary.

Features

- Stores items at desks
- Easily moves
- No assembly

Specifications

[See complete spec sheet here](#)

- Overall: 7.3" W x 17.5" H x 14" D
- Storage: 7.1" W x 13.75" H x 14" D
- Weight Capacity: 50 lb

**For desktops up to 1.75" thick*

Colors

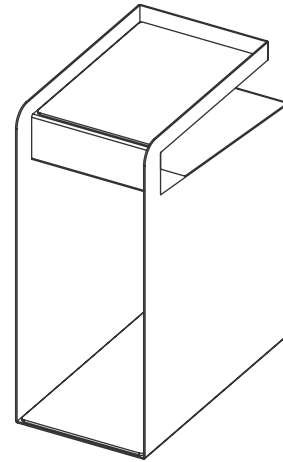
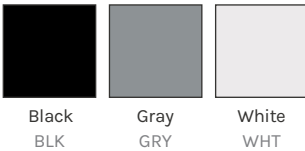

Additional Information

SKU

Weight

\$ Price

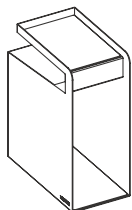

- Material: Steel
- No assembly required
- Available in Black, Gray and White

STR004

10.6 lb

\$99

Large Half Circle Desk Drawer

Minimalist and effective, the [Large Half Circle Desk Drawer](#) is an easy way to add storage space to desks. The swiveling drawer comes with two separated compartments and holds items ranging from pens to glasses. A central mounting design allows for 360° of rotation, so users can swivel the drawer open and closed smoothly and seamlessly.

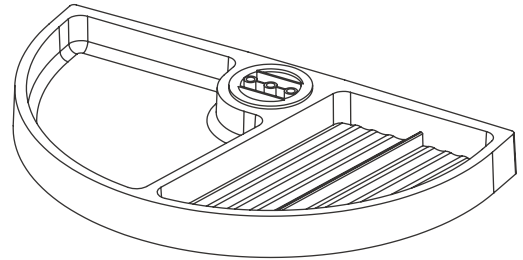

Features

- Integral storage compartments offer space for pens, pencils, sticky notes, and other small items
- Low profile minimizes under-desk footprint and allows drawer to be hidden when not in use
- 360° of rotation allows for tray to be opened or closed by pushing on either side

Specifications

[See complete spec sheet here](#)

- Dimensions: 13.8" W x 8.4" D x 1.3" H
- Minimum Desk Thickness: 3/4" thick

Colors

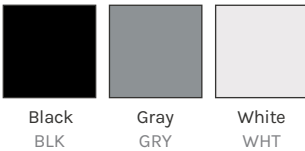

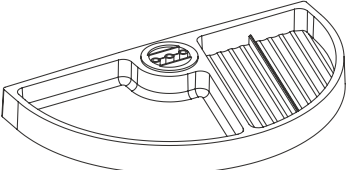
| | Additional Information | SKU | Weight | \$ Price |
|--|---|--------|--------|----------|
|  | <ul style="list-style-type: none"> • 360° rotation • Available in Black, Gray and White | STR007 | 6 oz | \$49 |

Small Half Circle Desk Drawer

The low profile [Small Half Circle Desk Drawer](#) features a compact, yet effective, U-shaped compartment that holds small spare desktop items like notes, keys, and sunglasses.

The drawer mounts and swivels from a central point; this design allows users 360° of rotation for seamless opening and closing by simply pushing on either side.

Features

- Holds small to medium size items
- Low profile minimizes under-desk footprint and allows drawer to be hidden when not in use
- 360° of rotation allows for tray to be opened or closed by pushing on either side

Specifications

[See complete spec sheet here](#)

- Dimensions: 7.9" W x 7.5" D x 1.2" H
- Minimum Desk Thickness: 3/4" thick

Colors

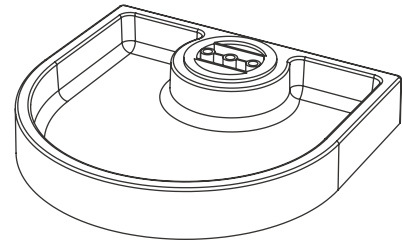
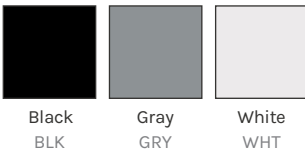

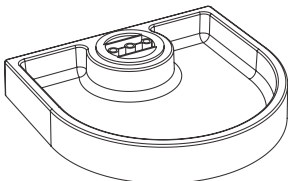
| | Additional Information | SKU | Weight | \$ Price |
|---|---|--------|--------|----------|
|  | <ul style="list-style-type: none"> • 360° rotation • Low profile design • Available in Black, Gray and White | STR005 | 4 oz | \$39 |

Bamboo Desk Drawer

The [Bamboo Desk Drawer](#), made of beautiful Moso bamboo, is sustainably sourced and designed with a natural finish. Store office supplies like laptops, notebooks, and pens for a tidy desk surface. The drawer's taller profile helps prevent it from hanging down or falling out when it's opened. This simple design gives extra support and keeps the drawer and its contents secure. Use the optional stop bar to prevent the drawer from pulling out.

The easy installation of the Bamboo Desk Drawer can be completed in minutes. Pair your bamboo drawer with a bamboo desktop, bamboo desk organizer set, and bamboo keyboard tray for a coordinated look – or contrast it with other desktop styles and materials.

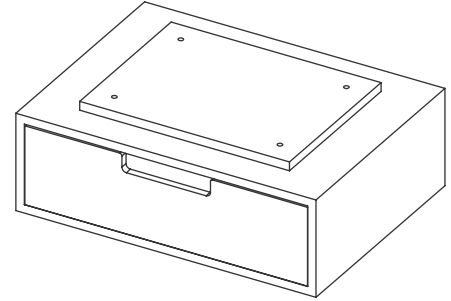

Features

- Sustainably sourced
- Installs in minutes
- Beautiful, natural finish
- Great for laptops, notebooks, and pens

Specifications

[See complete spec sheet here](#)

- Outer Dimensions: 9.9" D x 4.4" H x 13.4" W
- Inner Dimensions: 8.9" D x 2.9"H x 12.3" W
- Minimum Desk Thickness: 3/4" thick

Colors

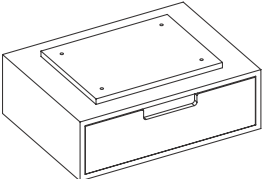

Bamboo

| | Additional Information | SKU | Weight | \$ Price |
|---|--|--------|--------|----------|
|  | <ul style="list-style-type: none"> • Easy installation • Made from Moso Bamboo | STR018 | 5.5 lb | \$119 |



SPACE DIVISION

UPLIFT Power and Data Rail

The [UPLIFT Power and Data Rail](#) is comprised of customizable features you won't find on any other power rail solution, our patent-pending power and data rail is the most capable and flexible solution for open office environments.

Power all your devices in areas where access to outlets is limited, service up to 16 desks per power infeed, eliminate unsightly cable clutter on floors, organize electrical drops from ceilings (if you require them), and maintain consistent spacing between desks to keep your workspace attractive and organized.

As your office layout changes (and it always does), the Power and Data Rail can grow and transition right along with it. Its telescoping post height and rail width enable it to fit workspaces of various shapes and sizes.

Specifications

- 2 power covers with holes for Byrne receptacles
- 2 power covers with holes for Dekko receptacles
- 2 power covers with no holes for receptacles
- 2 data covers with no holes

Colors

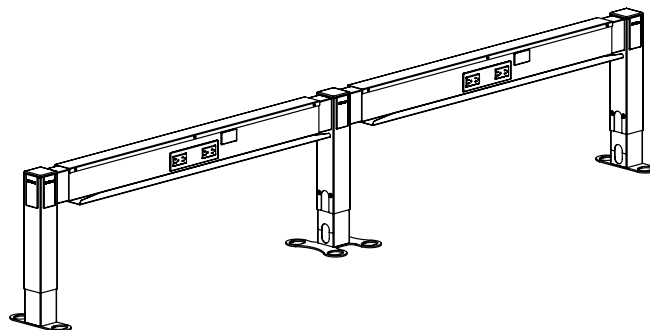
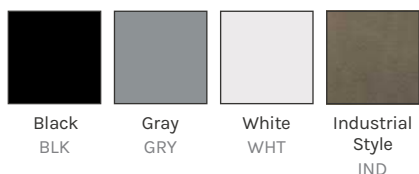

A GUIDE TO THE UPLIFT Power and Data Rail



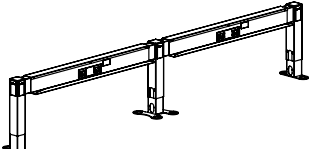

Frame Base SKU Color
PDC005-BLK

This example is for a black Power and Data Rail.

| | Additional Information | SKU | Weight | \$ Price |
|---|---|------------|--------|----------|
|  | <ul style="list-style-type: none"> • Finish: Powder-coat paint • Material: Steel • Available in Black, White, Gray, and Industrial Style | PDC005-XXX | Vaires | Varies |

UPLIFT Power and Data Rail Components

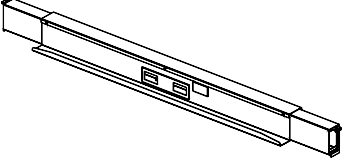
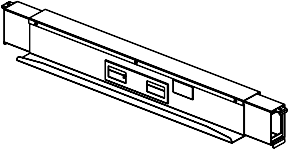
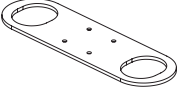
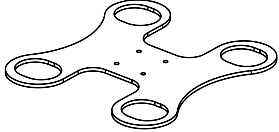
Individual Parts and Accessories

| Post - Square | SKU | \$ Price |
|---|-----------------|----------|
|  | PDC005-POST-SQ | \$49 |
| Post - 120-Degree | | |
|  | PDC005-POST-120 | \$79 |
| Rail - Long | | |
|  | PDC005-RAIL-LNG | \$149 |
| Rail - Short | | |
|  | PDC005-RAIL-SHT | \$99 |
| Foot - Square Post, Double Row, End | | |
|  | PDC005-FOOT-DE | \$19 |
| Foot - Square Post, Double Row, Center | | |
|  | PDC005-FOOT-DC | \$29 |
| Foot - Square Post, Single Row, End | | |
|  | PDC005-FOOT-SE | \$19 |

UPLIFT Power and Data Rail Components

Individual Parts and Accessories

Foot - Square Post, Single Row, Center

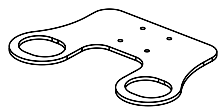

SKU

\$ Price

PDC005-FOOT-SC

\$24

Wire Tray - Long



PDC005-TRAY-LNG

\$39

Wire Tray - Short

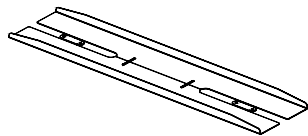

PDC005-TRAY-SHT

\$29

Privacy Panel Brackets

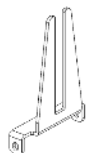

PDC005-PRV

\$24

Power Pole



PDC005-PWR-PL

\$149

Electrical Components

Rail Junction Block - Byrne, Double, 3+1

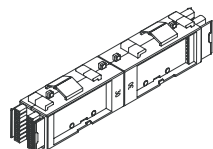

PDC005-BYR-BLOCK

\$49

UPLIFT Power and Data Rail Components

Individual Parts and Accessories

Rail Receptacle - Byrne, Duplex, 3+1, 15A, Circuits 1-4

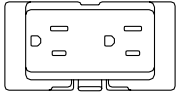

| SKU | \$ Price |
|------------------------|----------|
| PDC005-BYR-DPLX-15A-C1 | \$9 |
| PDC005-BYR-DPLX-15A-C2 | \$9 |
| PDC005-BYR-DPLX-15A-C3 | \$9 |
| PDC005-BYR-DPLX-15A-C4 | \$9 |

UPLIFT Power and Data Rail Jumper - Byrne, 3+1



| Desk Range | Width | SKU | \$ Price |
|--------------|-------|--------------------|----------|
| 42" to 42" | 36" | PDC005-BYR-JMPR-36 | \$49 |
| 48" to 48" | 42" | PDC005-BYR-JMPR-42 | \$54 |
| 60" to 60" | 54" | PDC005-BYR-JMPR-54 | \$59 |
| 72" to 72" | 66" | PDC005-BYR-JMPR-66 | \$74 |
| 120" to 120" | 34" | PDC005-BYR-JMPR-34 | \$49 |
| 120" to 60" | 45" | PDC005-BYR-JMPR-45 | \$54 |
| 120" to 72" | 51" | PDC005-BYR-JMPR-51 | \$59 |

UPLIFT Power and Data Rail Power Infeed - Byrne, Hardware, Flex Conduit, 72"



| | | |
|------|-----------------------|-------|
| 72" | PDC005-BYR-INFHDW-72 | \$74 |
| 216" | PDC005-BYR-INFHDW-216 | \$134 |

UPLIFT Power and Data Rail Power infeed - Byrne, Plug, 20A, 72", Straight

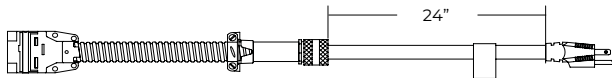

| Sides | Length | SKU | \$ Price |
|----------|--------|-------------------------|----------|
| Straight | 72" | PDC005-BYR-INFDPG-ST-72 | \$99 |
| Right | 72" | PDC005-BYR-INFDPG-RT-72 | \$99 |

UPLIFT Power and Data Rail Data Plate

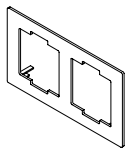

| | |
|-------------------------|-----|
| PDC005-BYR-DATA-PLT-BLK | \$2 |
|-------------------------|-----|

UPLIFT Power and Data Rail Data Plate - Adapter Kit

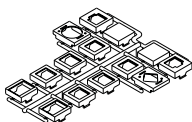

| | |
|-------------------------|-----|
| PDC005-BYR-DATA-KIT-BLK | \$2 |
|-------------------------|-----|



ACOUSTICS

Acoustic Privacy Panel

Acoustic Privacy Panels absorb noise and distractions at work via dense polyester fiberboard panels that can be installed on nearly any height adjustable or fixed-height desk. Tackable panels come in multiple sizes, colors, and mounting options to suit all office decor and styles.

Features

- Absorbs office noise
- Provides extra privacy
- Can second as bulletin board
- Works with most desks

Specifications

[See complete spec sheet here](#)

- Height: Side Panel: 15.5"
Back Panel: 22"
- Width: Side Panel: 22"
Back Panel: 40", 52", 64", 72"
- Thickness: 0.6"
- Noise Reduction: 0.85
Coefficient (NRC):
- Fire Rating: Euro Class B and ASTM E84-08

Colors

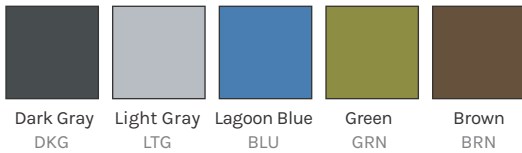

Side Panel

Back Panel

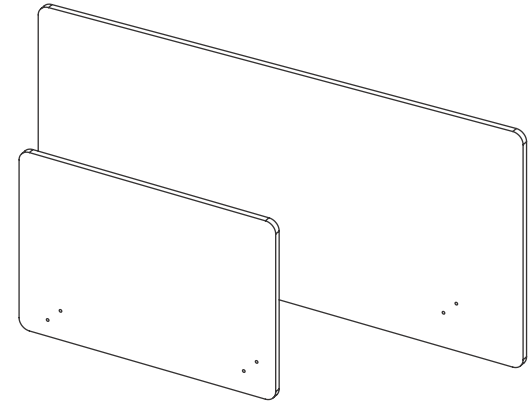

Side Panel

Back Panel

A GUIDE TO THE Acoustic Privacy Panel SKU

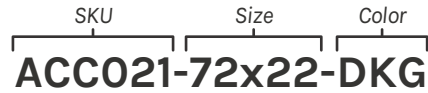

This example is for a 72x22" Dark Gray Acoustic Privacy Panel.

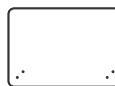
| Side Panel | Width | Height | SKU | Weight | \$ Price |
|--|-------|--------|----------------|--------|----------|
|  | 22" | 15.5" | ACC021-22x15.5 | 1.6 lb | \$79 |

| Back Panel | Width | Height | SKU | Weight | \$ Price |
|--|-------|--------|--------------|--------|----------|
|  | 40" | 22" | ACC021-40x22 | 3.2 lb | \$119 |
| | 52" | 22" | ACC021-52x22 | 4.2 lb | \$129 |
| | 64" | 22" | ACC021-64x22 | 5.2 lb | \$139 |
| | 72" | 22" | ACC021-72x22 | 5.8 lb | \$149 |

Additional Information

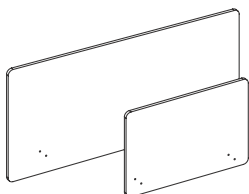

- Blocks noise at work
- Lightweight
- Clamp-on installation
- Available in Dark Gray, Light Gray, Lagoon Blue, Green, and Brown

Acoustic Privacy Panel Options & Accessories

Options Sold Separately

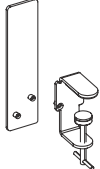
| Acoustic Privacy Panel Mounting Hardware | Dimensions | Material | SKU | Weight | \$ Price |
|---|------------|----------|--------|--|----------|
|  <ul style="list-style-type: none"> Includes 2 clamp brackets and 2 support brackets Reusable hardware can easily be adjusted or reinstalled Available in Black, Gray, White and Industrial Style | | Steel | ACC040 | 1.13 lb | \$49 |
| | | | | *Fits on desktops up to 1.75" thick. *Weight per bracket. | |

Desktop Acoustic Privacy Panel Holder

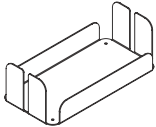
| | | | | | |
|--|---------------------|-------|--------|------------|------|
|  <ul style="list-style-type: none"> Holds acoustic privacy panels without mounting Includes storage space on both sides of holder Available in Black, Gray, White and Industrial | 12" L x 6" w x 4" H | Steel | ACC026 | 3 lb 10 oz | \$49 |
|--|---------------------|-------|--------|------------|------|

Acoustic Panel Ceiling Hanging Kit

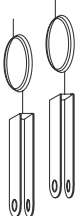
| | | | | | |
|--|--|---------------------------|--------|----------------------------|------|
|  <ul style="list-style-type: none"> Includes 2 brackets that attach to panels Hang panels from your ceiling at different lengths | | Unpainted Stainless Steel | ACU001 | 8 oz | \$49 |
| | | | | *Only for use with ACU021. | |

3-Panel Acoustic Room Divider Hardware Kit

| | | | | | |
|--|--|--|--------|------------|------|
|  <ul style="list-style-type: none"> Create private spaces and reduce ambient office noise and distraction Add color to your workspace decor Absorb up to 86% of ambient sound Available in Black, White and Industrial | | | ACU002 | 11 lb 2 oz | \$99 |
|--|--|--|--------|------------|------|

3-Panel Acoustic Room Divider

Create private spaces and reduce ambient noise and distractions with the **3-Panel Acoustic Room Divider**. Add more dividers to build a partition so that you can set up temporary rooms, walls, or workgroups. These panels absorb 86% of the soundwaves that come into contact with them, making this an excellent solution for taking calls and holding meetings without disrupting the office.

Features

- Create private spaces to block sound and distractions
- Available in Dark Gray, Light Gray, Lagoon Blue, Green and Brown
- Absorb up to 86% of ambient sound

Specifications

[See complete spec sheet here](#)

- Compatible Panel Sizes: 40", 52", 64", 72"
- Height (w/ hardware): 0.75", 52.75", 64.75", 72.75" W
- Width: 65.5" (each corner at 20°)
- Panel Thickness: 0.6"
- Noise Reduction Coefficient (NRC): > 0.86
- Material: Pressed Polyester Fiberboard
- Fire Rating: Euro Class B and ASTM E84-08

Colors

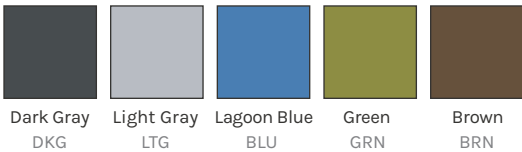

Hardware Colors

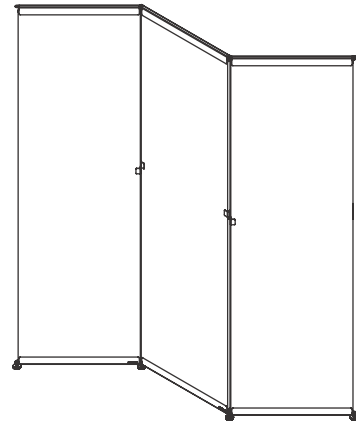
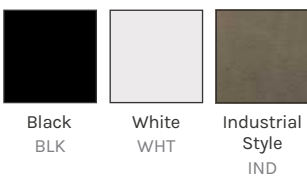

A GUIDE TO THE 3-Panel Acoustic Divider SKU

*This product is broken out into 2 separate SKUs

Panel SKU

Panel Base SKU | Panel Size | Panel Color | Panel Qty

KIT-ACC021-40x22-DKG-3

Hardware SKU

Hardware Base SKU | Hardware Color

BUNDLE-ACU002-BLK

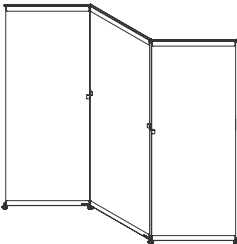

This example is for a 3-Panel Acoustic Divider with 3 40x22 dark gray panels with black hardware.

| | Width | Height | Panel SKU | Hardware SKU | Weight | \$ Price |
|---|-------|--------|-------------------------|-------------------|----------|----------|
|  | 65.5" | 40.75" | KIT-ACC021-40x22-DKG-x3 | BUNDLE-ACU002-XXX | 20.7 lb | \$349 |
| | 65.5" | 52.75" | KIT-ACC021-52x22-DKG-x3 | BUNDLE-ACU002-XXX | 23.75 lb | \$379 |
| | 65.5" | 64.75" | KIT-ACC021-64x22-DKG-x3 | BUNDLE-ACU002-XXX | 26.73 lb | \$409 |
| | 65.5" | 72" | KIT-ACC021-72x22-DKG-x3 | BUNDLE-ACU002-XXX | 28.53 lb | \$449 |

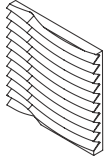
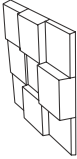
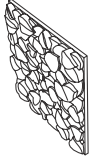
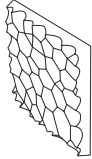
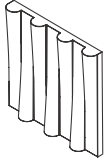
Product Comparison: Wall Acoustics

| | 3D Wave Acoustic Wall Panel  | 3D Cubes Acoustic Wall Panel  | 3D Pebbles Acoustic Wall Panel  | 3D Cellular Acoustic Wall Panel  | 3D Tube Acoustic Wall Panel  |
|-----------------------------------|--|---|---|--|---|
| Price | \$39 | \$39 | \$39 | \$39 | \$39 |
| Specifications | | | | | |
| Width | 23.75" W | 23.75" W | 23.75" W | 23.75" W | 19.75" W |
| Height | 23.75" H | 23.7" H | 23.75" H | 23.75" H | 19.75" H |
| Depth | 2.75" D | 3.13" D | 2.88" D | 3" D | 2.5" D |
| Material Thickness | 4.5 mm | 4.5 mm | 4.5 mm | 4.5 mm | 2.5 mm |
| Noise Reduction Coefficient (NRC) | 0.8 | 0.8 | 0.8 | 0.8 | 0.8 |
| Panel Material | Pressed Polyester Fiberboard | Pressed Polyester Fiberboard | Pressed Polyester Fiberboard | Pressed Polyester Fiberboard | Pressed Polyester Fiberboard |
| Panel Colors | Dark Gray, Lagoon Blue, Red Rock | Plum | Dark Gray | Lagoon Blue & White | Dark Gray & White |

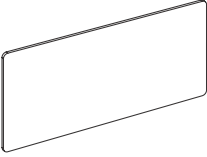
Product Comparison: Wall Acoustics

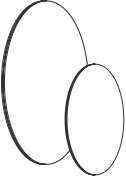
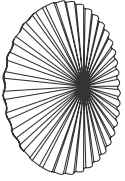
| | Rectangular Acoustic Wall Panel | Acoustic Phone Booth | Circular Acoustic Wall Panel | 3D Fan Acoustic Wall Panel |
|-----------------------------------|---|---|---|---|
| |  |  |  |  |
| Price | \$69 - \$139 | \$399 | \$119 - \$219 | \$189 |
| Specifications | | | | |
| Width | 15.5", 40", 52", 64", 72" W | 33.75" W | Small: 23.5" Large: 47.5" | 35.5" W |
| Height | 22" H | 35.5" H | Small: 2.5" Large: 47.5" | 35.5" H |
| Depth | N/A | 27.9" D | N/A | N/A |
| Panel Thickness | 0.475" (12 mm) | 0.75" thick | 0.94" (24 mm) | 1" |
| Noise Reduction Coefficient (NRC) | 0.4 (with no air gap) | 0.86 | 0.4 (with no air gap) 0.86 with air gap | 0.8 |
| Panel Material | Pressed Polyester Fiberboard | Pressed Polyester Fiberboard | Pressed Polyester Fiberboard | Pressed Polyester Fiberboard |
| Panel Colors | Dark Gray, Light Gray, Lagoon Blue, Green, & Brown | Outside Gray/Inside Green Outside Charcoal/Inside Gray | Lagoon Blue & White | Red Rock & Light Gray |

3D Wave Acoustic Wall Panel

3D Wave Acoustic Wall Panels allow individuals and businesses to build a sound-sheltered space that improves concentration at work. The thin, yet effective, panels can be installed on almost any flat wall and features a Noise Reduction Coefficient of .8, so 80% of noise that comes into contact with panels is absorbed. Made out of Polyester fiberboard, a single panel or multiple panels can be installed to dampen office noise. Lagoon Blue, Dark Gray, and Red Rock color options available.

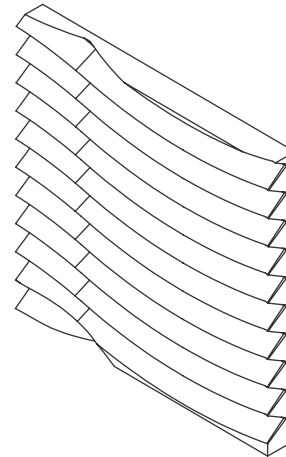

Features

- Reduces ambient noise
- Adds texture to blank walls
- Wide range of patterns possible

Specifications

[See complete spec sheet here](#)

- Dimensions: 23.75" W x 23.75" H x 2.75" D
- Thickness: 4.5 mm
- Material: Pressed Polyester Fiberboard
- Noise Reduction Coefficient (NRC): 0.8
- Fire Rating: Euro Class B and ASTM E84-08

Colors



Lagoon Blue BLU Dark Gray DKG Red Rock RRK

| | Additional Information | SKU | Weight | \$ Price |
|--|--|-----------------------|--------|----------|
| | <ul style="list-style-type: none"> • Made from 50% recycled plastic bottles • Permanent and temporary installation • Available in Lagoon Blue, Dark Gray and Red Rock | KIT-ACC028-XXX-ACC057 | 2 lb | \$39 |

3D Cubes Acoustic Wall Panel

The 3D cube design on the [3D Cubes Acoustic Wall Panels](#) creates more surface area for sound to be absorbed and enhances the look of plain walls. Sound-dampening panels lower ambient noise levels in office spaces and provide decoration for walls. Each 2' x 2' panel has a 0.80 noise reduction coefficient (NRC) —which means that 80% of the sound energy that hits the panel will be absorbed.

Our panels are made from 50% recycled plastic bottles, reducing their environmental impact, and reusing resources wisely.

Features

- Add texture to walls
- Add color to your workspace decor
- Absorb up to 80% of ambient sound

Specifications

- Dimensions: 23.7" W x 23.7" H x 3.13" D
- Material Thickness: 4.5 mm
- Material: Pressed Polyester Fiberboard
- Noise Reduction Coefficient (NRC): 0.8
- Fire Rating: Euro Class B and ASTM E84-08

Colors



Plum
PLM

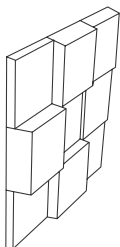
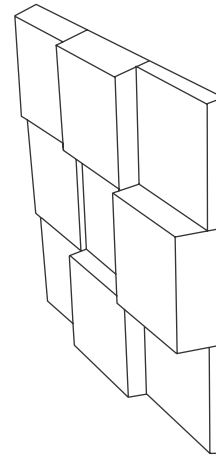

Additional Information

- 3D-cube design
- ASTM E84-08 tested with a Euro Class B fire rating
- Simple installation
- Available in Plum

SKU

KIT-ACU006-PLM-ACC057

Weight

2 lb 6 oz

\$ Price

\$39

3D Pebbles Acoustic Wall Panel

Lower the overall noise level in your office while adding aesthetic appeal to your walls with the [3D Pebbles Acoustic Wall Panel](#). Improve sound dampening capabilities by increasing the acoustic square footage of your wall while bringing flat surfaces to life. Each panel is effective at eliminating sound reflection, boasting an 80% absorption rate (NRC 0.80). Add as many panels as will fit on your wall to create a modular noise solution for small and large wall surfaces.

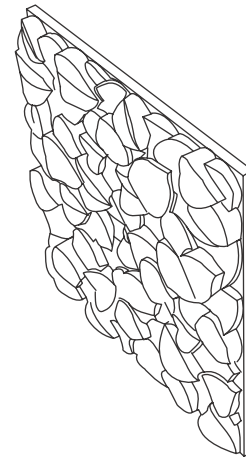

Features

- Add aesthetic appeal to walls
- Add texture to your workspace decor
- Absorb up to 80% of ambient sound

Specifications

- Dimensions: 23.75" W x 23.75" H x 2.88" D
- Thickness: 4.5 mm thick
- Material: Pressed Polyester Fiberboard
- Noise Reduction Coefficient (NRC): 0.8
- Fire Rating: Euro Class B and ASTM E84-08

Colors



Dark Gray
DKG

Additional Information

- Lower overall noise level
- 3D pebble-like texture
- Modular
- Available in Dark Gray

SKU

KIT-ACU004-DKG-ACC057

Weight

2 lb

\$ Price

\$39

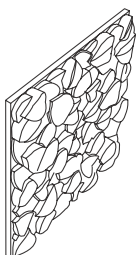

3D Cellular Acoustic Wall Panel

Absorb office noise and make it easier for employees to concentrate, while adding unique design textures to your walls with the [3D Cellular Acoustic Wall Panel](#). The textured surface absorbs more sound than most flat panels due to their increased surface area. Convert entire walls into decorative, sound-dampening surfaces. Engineered to an NRC (noise reduction coefficient) rating of 0.8, these panels absorb 80% of sound that reaches them.

Our panels are made from 50% recycled post-consumer material such as plastic bottles, giving you an eco-friendly acoustic solution.

Features

- Attach panels to the wall for improved room acoustics
- Add color to your workspace decor
- Absorb up to 80% of ambient sound

Specifications

- Dimensions: 23.75" W x 23.75" H x 3" D
- Thickness: 4.5 mm thick
- Material: Pressed Polyester Fiberboard
- Noise Reduction Coefficient (NRC): 0.8
- Fire Rating: Euro Class B and ASTM E84-08

Colors



Lagoon Blue
BLU

White
WHT

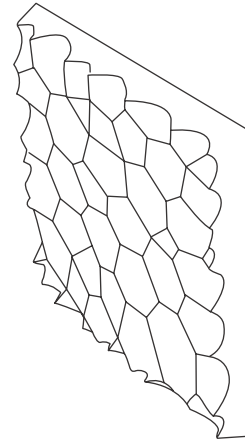

Additional Information

SKU

Weight

\$ Price

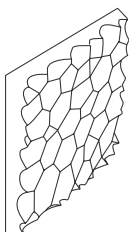

- Absorb office noise
- Made from 50% recycled post-consumer material
- Easy installation
- Available in Lagoon Blue and White

KIT-ACU003-XXX-ACC057

1 lb 10 oz

\$39

3D Tube Acoustic Wall Panel

3D Tube Acoustic Wall Panels allow businesses and individuals to create a sound-sheltered room that improves focus at work. The dense, yet thin, panels are easily installed on flat walls and feature a Noise Reduction Coefficient of .8, so 80% of noise that comes into contact with the panels is absorbed.

Made out of Polyester fiberboard, a single panel or multiple panels can be installed to provide users a space that reduces outside noise while adding visual interest. White and Dark Gray color options available.

Features

- Reduces ambient noise
- Adds texture to blank walls
- Wide range of patterns possible

Specifications

[See complete spec sheet here](#)

- Dimensions: 19.75" W x 19.75" H x 2.5" D
- Thickness: 2.5 mm thick
- Material: Pressed Polyester Fiberboard
- Noise Reduction Coefficient (NRC): 0.8
- Fire Rating: Euro Class B and ASTM E84-08

Colors

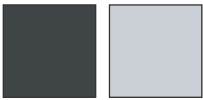

Dark Gray
DKG

White
WHT

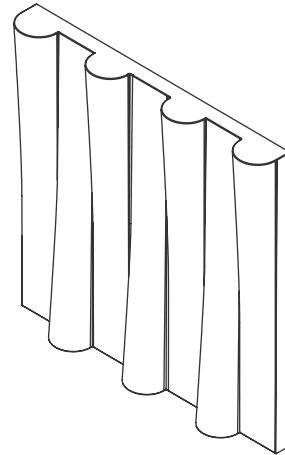

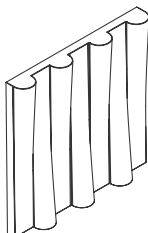
| | Additional Information | SKU | Weight | \$ Price |
|---|---|-----------------------|--------|----------|
|  | <ul style="list-style-type: none"> • Made from 50% recycled plastic bottles • Easy installation • Dense, yet thin design • Available in Dark Gray and White | KIT-ACC027-XXX-ACC057 | 1 lb | \$39 |

Rectangular Acoustic Wall Panel

The [Rectangular Acoustic Wall Panels](#) allow you to decrease noise levels while adding subtle aesthetic interest to your walls. Our acoustic panels are lightweight, mount to walls easily, and ecologically sound. Increase focus in open areas by reducing the amount of distraction caused by the sound of coworkers.

Features

- Attach to the wall for texture and acoustics
- can be used and matched with your existing UPLIFT Desk panels and room dividers
- Absorb up to 86% of ambient sound

Specifications

- Height: 22"
- Width: 15.5", 40", 52", 64", 72"
- Thickness: 0.475" (12 mm)
- Material: Pressed Polyester Fiberboard
- Noise Reduction Coefficient (NRC): 0.8
- Fire Rating: Euro Class B and ASTM E84-08

Colors

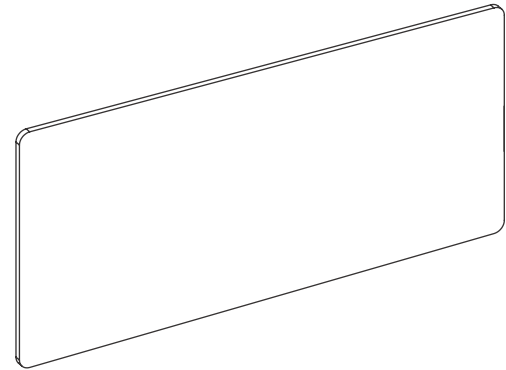
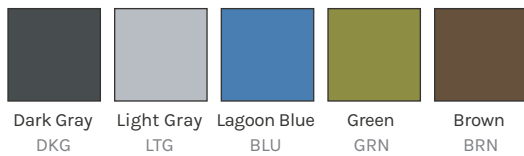

A GUIDE TO THE Rectangular Acoustic Wall Panel SKU



This example is for a 64x22 Dark Gray Rectangular Acoustic Wall Panel.

| | Additional Information | Width | Height | SKU | Weight | \$ Price |
|--|---|-------|--------|-------------------------|--------|----------|
|  | • These dual-purpose panels also serve as bulletin boards | 22" | 15.5" | KIT-ACU021-WALL-22x15.5 | 1.6 lb | \$69 |
| | | 40" | 22" | KIT-ACU021-WALL-40x22 | 3.2 lb | \$109 |
| | | 52" | 22" | KIT-ACU021-WALL-52x22 | 4.2 lb | \$119 |
| | • Available in Dark Gray, Light Gray, Lagoon Blue, Green, and Brown | 64" | 22" | KIT-ACU021-WALL-64x22 | 5.2 lb | \$129 |
| | | 72" | 22" | KIT-ACU021-WALL-72x22 | 5.8 lb | \$139 |

Acoustic Phone Booth

Is a space with too much background noise optimal for phone calls? In short, the answer is no. However, the [Acoustic Phone Booth](#) may be the right solution for your office. Privacy is another benefit of the Acoustic Phone Booth by UPLIFT Desk. This sound-absorbing and the echo-eliminating enclosure offers up to 86% of noise reduction. The booth includes a small shelf inside for a notepad or a cup of coffee.

Features

- Create a private space for calls
- Add color to your workspace decor
- Absorb up to 86% of ambient sound

Specifications

[See complete spec sheet here](#)

- Dimensions: 33.75" W x 35.5" H x 27.9" D
- Panel Thickness: 0.75"
- Material: Pressed Polyester Fiberboard
- Noise Reduction Coefficient (NRC): 0.86
- Fire Rating: Euro Class B

Colors

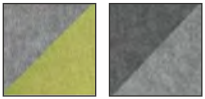

Gray/Green Charcoal/Gray
 GRYGRN CHRGRY

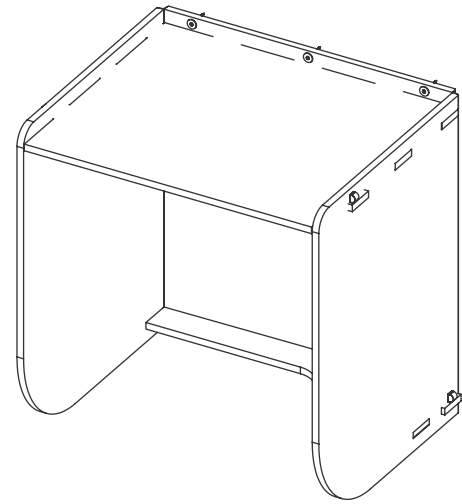

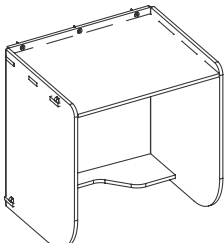
| | Additional Information | SKU | Weight | \$ Price |
|---|---|--------|------------|----------|
|  | <ul style="list-style-type: none"> • Includes drywall anchors and hardware • Available in Gray/Green, and Charcoal/Gray | ACU011 | 18 lb 2 oz | \$399 |

Circular Acoustic Wall Panel

Lower the noise levels in your workspace by adding functional design elements to your walls. The [Circular Acoustic Wall Panels](#) are 1"-thick, sturdy, yet lightweight, and made of eco-conscious polyester fiberboard, which comes from 50% recycled material. Our panels are made to reduce noise effectively by absorbing 40% of all sound they come into contact with when flush-mounted against the wall. Leave an air gap by mounting panels to the wall with a spacer to increase this absorption up to 86%.

The panels come in 2' and 4' diameters so that you can put together the best arrangement for your space. Mounting the panels is quick and easy, and there are multiple options such as nails or Loctite® Construction Adhesive. For an additional level of functionality, panels can also be used as bulletin boards. Pin notes and reminders to the panels while dampening office noise.

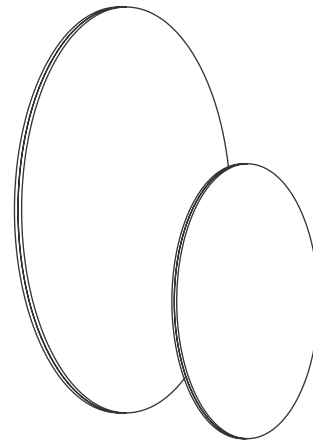

Large Panel

Small Panel

Features

- Add texture to walls
- Add color to your workspace decor
- Absorb up to 86% of ambient sound

Specifications

- Dimensions: Small: 23.5" Diameter
Large: 47.5" Diameter
- Panel Thickness: 0.95" (24 mm)
- Material: Pressed Polyester Fiberboard
- Noise Reduction Coefficient (NRC): 0.4 (with no air gap)
0.86 (with air gap)
- Fire Rating: Euro Class B and ASTM E84-08

Colors

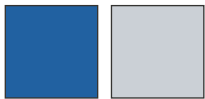

Lagoon Blue
BLU

White
WHT

| | Additional Information | Size | SKU | Weight | \$ Price |
|--|---|-------|---------------------|------------|----------|
| | <ul style="list-style-type: none"> • Reduce echo • Comes in 2' and 4' diameters • Mounting is quick and easy • Available in Lagoon Blue and White | Small | KIT-ACU009-WALL-SML | 3 lb | \$119 |
| | | Large | KIT-ACU009-WALL-LRG | 13 lb 2 oz | \$219 |

3D Fan Acoustic Wall Panel

Add a dual-purpose design element to your office with the [3D Fan Acoustic Wall Panel](#). The circular panel's fan shape provides a colorful, 3D acoustic wall treatment, decreasing noise and echos while increasing aesthetic wall interest. The fan ridges gather and deflect noise and vibrations by providing more sound-absorbing surface area compared to most flat panels.

These panels are rated to absorb 80% of all the sound that reaches them (NRC 0.8). Mitigating workday phone call volume, conversations, and keyboard clacking result in a quieter work environment ideal for concentration. If you're looking for an eco-friendly option, these are perfect for you. The 3D Fan Acoustic Wall Panels are made from polyester fiberboard, which includes 50% recycled plastic bottles.

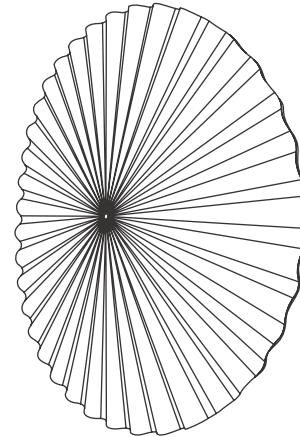

Features

- Add texture to walls
- Add color to your workspace decor
- Absorb up to 80% of ambient sound

Specifications

- Dimensions: 35.5" Diameter
- Thickness: 1"
- Material: Pressed Polyester Fiberboard
- Noise Reduction Coefficient (NRC): 0.8
- Fire Rating: Euro Class B and ASTM E84-08

Colors

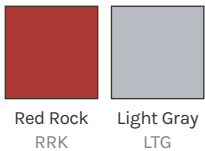

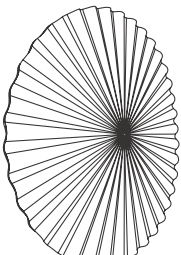
| | Additional Information | SKU | Weight | \$ Price |
|---|--|-----------------------|-----------|----------|
|  | <ul style="list-style-type: none"> • Dual-purpose design • Quick and easy installation • Made from 50% recycled plastic bottles • Available in Red Rock and Light Gray | KIT-ACU017-ACU008-LRG | 2 lb 4 oz | \$189 |

Product Comparison: Ceiling Acoustics

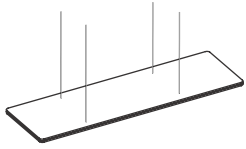
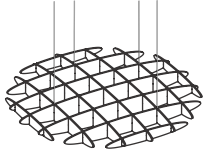
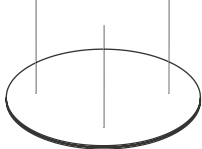
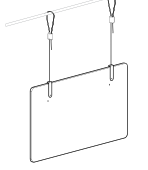
| | Rectangular Acoustic Ceiling Cloud | 3D Ceiling Acoustic Waffle Cloud | Circular Acoustic Ceiling Cloud | Acoustic Hanging Kit with Panel and Hardware |
|-----------------------------------|---|---|---|---|
| |  |  |  |  |
| Price | \$79 - \$149 | \$249 | \$119 - \$219 | \$79 - \$149 |
| Specifications | | | | |
| Width | 22" W | 47.5" W | Small: 23.5" Large: 47.5" | 22" W |
| Length | 15.5", 40", 52", 64", 72" D | 47.5" D | small: 23.5" large: 47.5" | 15.5", 40", 52", 64", 72" D |
| Height | 1.2" H | 5.5 H | 0.945" (24 mm) | 1.2" H |
| Panel Thickness | 1.2" (30mm) | 0.475" (12 mm) | 0.945" (24 mm) | 1.2" (30mm) |
| Noise Reduction Coefficient (NRC) | > 0.86 | 0.8 | > 0.86 | > 0.86 |
| Panel Material | Pressed Polyester Fiberboard | Pressed Polyester Fiberboard | Pressed Polyester Fiberboard | Pressed Polyester Fiberboard |
| Panel Colors | Dark Gray, Light Gray, Lagoon Blue, Green, & Brown | Lagoon Blue & Dark Gray | Lagoon Blue & White | Dark Gray, Light Gray, Lagoon Blue, Green, & Brown |

Rectangular Acoustic Ceiling Cloud

Decrease sound in the office with the [Rectangular Acoustic Ceiling Cloud](#). Hang from the ceiling in clusters to form creative configurations and acoustic centerpieces. The panels absorb noise on all six sides. More than 86% of sound entering the panels gets absorbed. Installation is simple. Hang them at your desired length.

Features

- Hang from the ceiling for a unique design
- Available in Dark Gray, Light Gray, Lagoon Blue, Green and Brown
- Absorb up to 86% of ambient sound

Specifications

- Length: 22"
- Width: 22"
- Panel Thickness: 1.2" (30mm)
- Material: Pressed Polyester Fiberboard
- Noise Reduction Coefficient (NRC): > 0.86
- Fire Rating: Euro Class B and ASTM E84-08

Colors

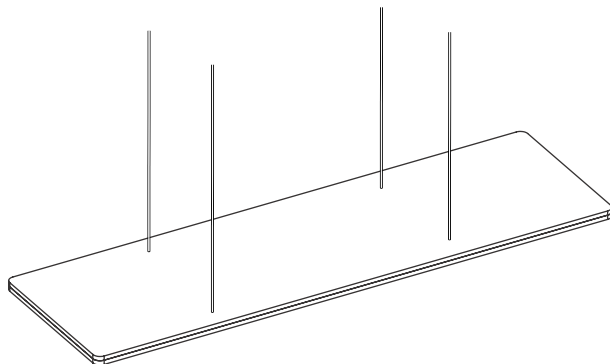
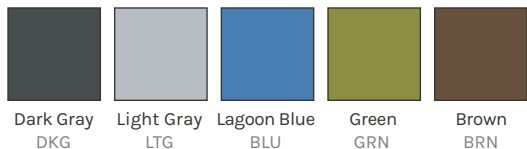

A GUIDE TO THE Rectangular Acoustic Ceiling Cloud SKU



This example is for a 64x22 Dark Gray Rectangular Acoustic Ceiling Cloud.

| Additional Information | Width | Depth | SKU | Weight | \$ Price |
|--|-------|-------|--------------------------|---------|----------|
| <ul style="list-style-type: none"> • Fire rating: Euro Class B and ASTM E84-08 Class A • Available in Dark Gray, Light Gray, Lagoon Blue, Green, and Brown | 22" | 15.5" | KIT-ACU021-CLOUD-22x15.5 | 3.2 lb | \$79 |
| | 22" | 40" | KIT-ACU021-CLOUD-40x22 | 6.4 lb | \$119 |
| | 22" | 52" | KIT-ACU021-CLOUD-52x22 | 8.4 lb | \$129 |
| | 22" | 64" | KIT-ACU021-CLOUD-64x22 | 10.4 lb | \$139 |
| | 22" | 72" | KIT-ACU021-CLOUD-72x22 | 11.6 lb | \$149 |

3D Acoustic Ceiling Waffle Cloud, Large

The [3D Acoustic Ceiling Waffle Cloud](#) reduces ambient noise in users' work areas via dense sound-absorbing Polyester fiberboard panels. Once assembled, the cloud works to reduce sound while adding interesting visual detail to bland office spaces. The cloud hangs from the ceiling to deliver a beautiful centerpiece that is as functional as it is eye-catching. Available in lagoon blue and dark gray color options.

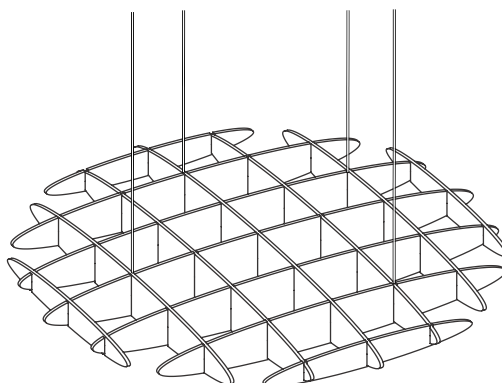

Features

- Reduces ambient noise
- Adds visually stimulating decor to any space

Specifications

[See complete spec sheet here](#)

- Dimensions: 47.5" W x 47.5" D x 5.5" H
- Panel Thickness: 0.475" (12 mm)
- Material: Pressed Polyester Fiberboard
- Noise Reduction Coefficient (NRC): 0.8
- Fire Rating: Euro Class B and ASTM E84-08

Colors



Lagoon Blue BLU Dark Gray DKG

Additional Information

- Material: Polyester Fiberboard
- Available in Lagoon Blue and Dark Gray

SKU

ACC032-LRG-XXX

Weight

5 lb

\$ Price

\$249

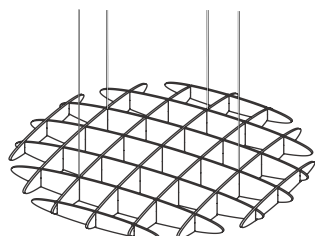

Circular Acoustic Ceiling Cloud

The [Circular Acoustic Ceiling Cloud](#) provides sound absorption and eliminates echo in open-space environments. Add a unique design element to your space with circular sound panels that hang from the ceiling. They absorb sound on all sides, for increased effectiveness. Sound panels have an NRC of 0.86 or higher, which means they absorb 86% of the sound that comes into contact with them. Installation is quick and easy.

Panels hang from steel aircraft cables attached to adjustable clips so that you can alter their height. Tailor your panel configuration for your design and sound-reduction needs.

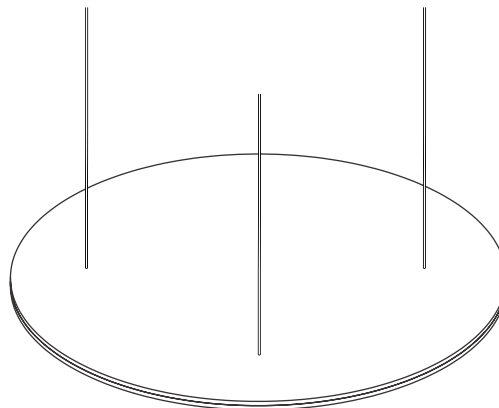

Features

- Hang from the ceiling for a unique design
- Add color to your workspace decor
- Absorb up to 86% of ambient sound

Specifications

- Dimensions: Small: 23.5" Diameter
Large: 47.5" Diameter
- Panel Thickness: 0.95" (24 mm)
- Material: Pressed Polyester Fiberboard
- Noise Reduction Coefficient (NRC): > 0.86
- Fire Rating: Euro Class B and ASTM E84-08

Colors



Lagoon Blue
BLU

White
WHT

| | Additional Information | Size | SKU | Weight | \$ Price |
|--|--------------------------------------|-------|--------------------------|------------|----------|
| | • Easy installation | Small | KIT-ACU009-CLOUD-SML-BLU | 3 lb | \$119 |
| | • Provides sound absorption | Small | KIT-ACU009-CLOUD-SML-WHT | 3 lb | \$119 |
| | • Available in Lagoon Blue and White | Large | KIT-ACU009-CLOUD-LRG-BLU | 13 lb 2 oz | \$219 |
| | | Large | KIT-ACU009-CLOUD-LRG-WHT | 13 lb 2 oz | \$219 |

Acoustic Panel Hanging Kit with Panel and Hardware

Decrease sound in the office with the [Acoustic Panel Hanging Kit with Panel and Hardware](#). The panels absorb noise on all six sides. More than 86% of sound entering the panels gets absorbed. Improve the aesthetics of your workplace with a visually appealing design. Installation is simple. Hang them at your desired length.

Features

- Hang from the ceiling for a unique design
- Available in Dark Gray, Light Gray, Lagoon Blue, Green and Brown
- Absorb up to 86% of ambient sound

Specifications

- Length: 22"
- Width: 22"
- Panel Thickness: 1.2" (30mm)
- Material: Pressed Polyester Fiberboard
- Noise Reduction Coefficient (NRC): > 0.86
- Fire Rating: Euro Class B and ASTM E84-08

Colors



Dark Gray DKG Light Gray LTG Lagoon Blue BLU Green GRN Brown BRN

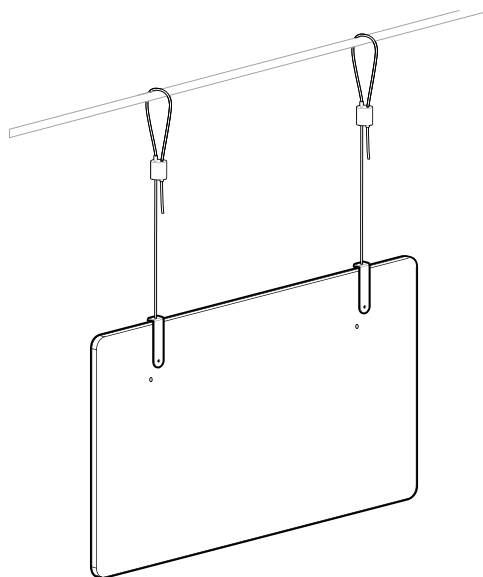

| | Additional Information | Width | Depth | SKU | Weight | \$ Price |
|--|---|---|-------|-------------------------------|---------|----------|
|  | • Customizable | 22" | 15.5" | KIT-ACU001-ACU021-22x15.5-XXX | 3.2 lb | \$79 |
| | • polyester fiberboard and contain 50% recycled water bottles | 22" | 40" | KIT-ACU001-ACU021-40x22-XXX | 6.4 lb | \$119 |
| | | 22" | 52" | KIT-ACU001-ACU021-52x22-XXX | 8.4 lb | \$129 |
| | • capture 85% of the sound waves | 22" | 64" | KIT-ACU001-ACU021-64x22-XXX | 10.4 lb | \$139 |
| | | 22" | 72" | KIT-ACU001-ACU021-72x22-XXX | 11.6 lb | \$149 |
| | | • Available in Dark Gray, Light Gray, Lagoon Blue, Green, and Brown | | | | |

OneWall Mobile Acoustic Office Partition

Add privacy while reducing noise with this 6' tall acoustic [OneWall Acoustic Office Mobile Partition](#). Wall can change sizes as your needs change thanks to the expandable, telescoping frame.

Gain more privacy and sense of ownership in select areas while you improve the soundscape. 86% of sound that hits our panels is absorbed and doesn't reflect back into the workspace.

Features

- Use multiple units side-by-side to create your own layout
- Available in Dark Gray, Light Gray, Lagoon Blue, Green and Brown
- Absorb up to 86% of ambient sound

Specifications

[See complete spec sheet here](#)

- Compatible Panel Sizes: 40", 52", 64", 72"
- Wall Height w/ Casters: 6' H
- Width: 40", 52", 64", 72"
- Panel Thickness: 0.6"
- Noise Reduction Coefficient (NRC): > 0.86
- Material: Pressed Polyester Fiberboard
- Fire Rating: Euro Class B and ASTM E84-08

Colors

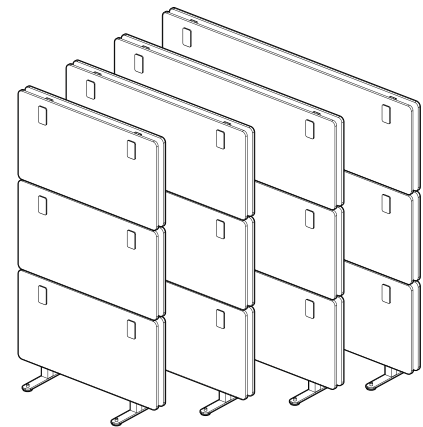
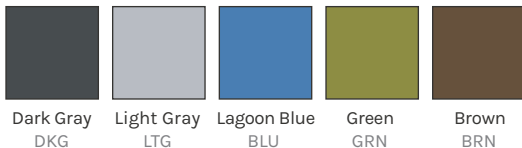

A GUIDE TO THE OneWall Mobile Acoustic Office Partition SKU



| | Additional Information | Width | Height | Panel SKU | Weight | \$ Price |
|--|---|-------|--------|-------------------------|----------|----------|
| | • Customizable | 40" | 6' | ACU013-MOBILE-40X22-XXX | 20.7 lb | \$389 |
| | • Coordinates with our OneWall and existing line of acoustic panels | 52" | 6' | ACU013-MOBILE-52X22-XXX | 23.75 lb | \$429 |
| | | 64" | 6' | ACU013-MOBILE-64X22-XXX | 26.73 lb | \$469 |
| | • Dampen sound in open areas | 72" | 6' | ACU013-MOBILE-72X22-XXX | 28.53 lb | \$499 |
| | • Available in Dark Gray, Light Gray, Lagoon Blue, Green, and Brown | | | | | |

OneWall Cubicle Acoustic Office Partition

Configure your space into layouts that best fit the flow of your room, business, and/or employees with the [OneWall Cubicle Acoustic Office Partition](#). The telescoping frame allows flexibility as your needs change. Dampen sound in open areas while adding privacy to create a sense of ownership in functional workspaces and it's customizable, so you can design and redesign your space as your needs change.

Features

- Create private spaces to block sound and distractions
- Available in Dark Gray, Light Gray, Lagoon Blue, Green and Brown
- Absorb up to 86% of ambient sound

Specifications

[See complete spec sheet here](#)

- Compatible Panel Sizes: 40", 52", 64", 72"
- Height (w/ hardware): 0.75", 52.75", 64.75", 72.75" W
- Width: 65.5" (each corner at 20°)
- Panel Thickness: 0.6"
- Noise Reduction Coefficient (NRC): > 0.86
- Material: Pressed Polyester Fiberboard
- Fire Rating: Euro Class B and ASTM E84-08

Colors



Dark Gray
DKG

Light Gray
LTG

Lagoon Blue
BLU

Green
GRN

Brown
BRN

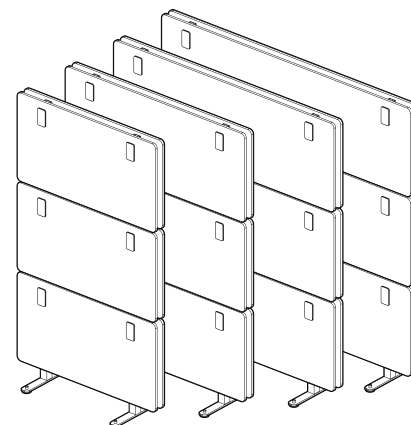

A GUIDE TO THE OneWall Cubicle Acoustic Office Partition SKU

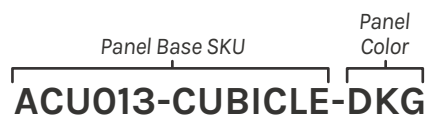



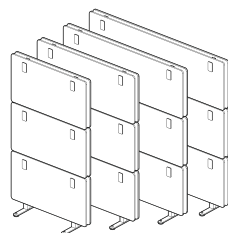

Additional Information

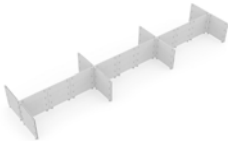

- Customizable
- Coordinates with our OneWall and existing line of acoustic panels
- Dampen sound in open areas
- Available in Dark Gray, Light Gray, Lagoon Blue, Green, and Brown

OneWall Cubicle Acoustic Office Partition Configurations

| Configuration 1 - Six Cubicle Workstations | Cubicle Width | Cubicle Height | Panel SKU | Weight | \$ Price |
|---|---------------|----------------|--------------------|----------|----------|
|  | 72" | 52" | ACU013-CUBICLE-XXX | 20.7 lb | \$4795 |
| Configuration 2 - Six Cubicle Workstations | | | | | |
|  | 72" | 72" | ACU013-CUBICLE-XXX | 23.75 lb | \$5435 |
| Configuration 3 - Four Cubicle Workstations | | | | | |
|  | 104" | 72" | ACU013-CUBICLE-XXX | 26.73 lb | \$5975 |
| Configuration 4 - Six Cubicle Workstations | | | | | |
|  | 208" | 72" | ACU013-CUBICLE-XXX | 28.53 lb | \$8393 |
| Configuration 5 - Six Cubicle Workstations | | | | | |
|  | 92" | 92" | ACU013-CUBICLE-XXX | 26.73 lb | \$8713 |
| Configuration 6 - Six Cubicle Workstations | | | | | |
|  | 92" | 80" | ACU013-CUBICLE-XXX | 28.53 lb | \$9851 |



UPLIFT DESK®

[upliftdesk.com](https://www.upliftdesk.com) | 800-349-3839