

The Earth Observer. November - December 2011. Volume 23, Issue 6.

Editor's Corner

Steve Platnick

EOS Senior Project Scientist

Beginning in the late 1990s, NASA launched the Earth Observing System (EOS) satellites. The EOS sensors have given us an unprecedented view of our home planet and produced data that have led to striking new insights about the Earth's clouds, oceans, vegetation, ice, and atmosphere, and how these systems collectively regulate Earth's climate. The venerable fleet is now aging, and a new generation of satellites is needed to continue those observations.

Such a new sensor suite began its journey on October 28, 2011 at 5:48 AM. A beautiful arc of light illuminated the clear predawn sky [see image below] as a Delta-II 7920-10 rocket roared into space from Vandenberg Air Force Base in California carrying the National Polar-orbiting Operational Environmental Satellite System (NPOESS) Preparatory Project [NPP]. NPP is a joint venture between NASA and the National Oceanic and Atmospheric Administration (NOAA) designed as a "bridge" mission to the Joint Polar Satellite System¹ (JPSS), whose first launch (JPSS-1) is tentatively planned for 2016. Once NPP's systems have been tested on orbit, NOAA will assume day-to-day operations.

The satellite's state-of-the-art instruments will provide critical information for NOAA's operational weather forecasting and other applications, and will continue many of the EOS-era climate and Earth science data records (or those obtained prior to EOS in some cases). The NPP instrument suite includes the Advanced Technology Microwave Sounder (ATMS); Cross-track Infrared Sounder (CrIS); Ozone Mapping and Profiler Suite (OMPS); Visible Infrared Imaging Radiometer Suite (VIIRS); and Clouds and the Earth's Radiant Energy System (CERES)².

¹**Note on Nomenclature:** Prior to February 2010, an Integrated Program Office managed a three-agency partnership between NASA, NOAA, and Department of Defense called the National Polar-orbiting Operational Environmental Satellite System (NPOESS). In February 2010, the NPOESS partnership was dissolved and a new partnership between NASA and NOAA was created, known as the Joint Polar Satellite System (JPSS). The "bridge" mission between EOS and JPSS kept the name NPP, however. ² To learn more about NPP please visit: jointmission.gsfc.nasa.gov/index.html. *The Earth Observer* plans a more detailed "Introduction to NPP" in an upcoming issue.

continued on page 2

An arc of light illuminates the pre-dawn sky at Vandenberg Air Force Base, as a Delta II rocket launches with the NPOESS Preparatory Project (NPP) payload on Friday, October 28, 2011. NPP carries five science instruments, including four new state-of-the-art sensors, which will provide critical data to help scientists understand the dynamics of long-term climate patterns and help meteorologists improve short-term weather forecasts. **Image credit:** NASA/Bill Ingalls



the earth observer

eos.nasa.gov

In This Issue

Editor's Corner Front Cover

Feature Articles

- Chronicling the Landsat Legacy 4
 The DEVELOP National Program
 Works With the Group on Earth
 Observations on Air Quality, Public
 Health, and Water Quality: An
 International Collaboration Between
 the U.S. and Mexico 11

Meeting/Workshop Summaries

- The State of Research and Questions
 About Future Changes in the Boreal
 and Arctic Zones 16
 Aura Science Team Meeting Summary 21
 Ozone Monitoring Instrument
 Science Team Meeting Summary 23
 The Soil Moisture Active Passive (SMAP)
 Applications Program and the 2011
 SMAP Applications Workshop 24
 Landsat Science Team Meeting
 Summary 26
 CERES Science Team Meeting 32
 SORCE Science Team Meeting Summary 35

In The News

- NASA Launches Multi-Talented
 Earth-Observing Satellite 48
 Watching the Birth of an Iceberg 49
 NASA-NOAA Data Show Significant
 Antarctic Ozone Hole Remains 50

Regular Features

- NASA Earth Science in the News 52
 NASA Science Mission Directorate –
 Science Education and Public
 Outreach Update 54
 Science Calendars 55

Reminder: To view newsletter images in color, visit: eospsa.gsfc.nasa.gov/eos_homepage/for_scientists/earth_observer.php

Every two years, the Earth Science Division conducts a *Senior Review* of the missions currently in (or entering) extended operations. This year, 12 missions were reviewed: Aqua, Aura, CALIPSO, CloudSat, EO-1, GRACE, Jason-1³, OSTM, QuikSCAT, SORCE, Terra, and TRMM. In March 2011, each team submitted continuation proposals, and budgets for both FY'12-13 and FY'14-15. Reviewers considered scientific value, national interest, technical performance, and proposed cost of extending each mission. The review process involved three panels: a Science Panel, to review the mission's scientific merit; and two panels focusing respectively on Technical & Cost and National Interests.

The results of the review, released in late September, concluded that continuing all 12 missions is critical to enable NASA to meet its science objectives⁴. Eleven of the missions were recommended to receive baseline (in-guide) or augmented support. Aura was recommended for a reduction—but only because the High Resolution Dynamics Limb Sounder (HIRDLS) instrument failed in 2008 and is now winding down its operations. Unfortunately, budgetary constraints will reduce funding below the panel recommendations for all/some years depending on the mission. While the direction from HQ gave specific budget reductions, exact allocations are dependent on Congressional budget action.

The Senior Review process involves a significant effort for the mission teams and project scientists (in particular, for multiinstrument/multicenter missions), panel members, and chairs. On behalf of the broad domestic and international user communities, we thank all those who contributed their time to this process. The full 2011 Senior Review panel report is available at science.nasa.gov/earth-science/missions/operating/.

There is wonderful news about CloudSat. On October 12, for the first time since April's battery anomaly, the CloudSat Cloud Profiling Radar (CPR) was activated after many weeks of managing satellite power on the daylight portion of the orbit in order to reach a stable *Standby Mode*⁵. By late October, the CPR transmit time had increased from a few minutes to 46–52 minutes per orbit. As of November 2, the CloudSat flight team reported that a spacecraft attitude configuration successfully adjusted the CPR boresight from nadir, and that

³ On December 7, 2011, the Jason-1 satellite celebrates the tenth anniversary of its launch. Please read the accompanying sidebar on page 3 of this issue to learn more.

⁴ Based on the findings of the 2009 Senior Review and the assumption that the Glory Total Irradiance Monitor would be operational, the ACRIMSAT mission had planned to phase out operations in 2011. However, following the Glory launch failure, ACRIMSAT was extended for another two years, at which point it will re-enter the Senior Review process with the other Earth Science missions.

⁵ During the anomaly, CloudSat's orbit was lowered from the A-Train. The choice of a new orbit is still being discussed from among the options discussed in our September–October 2011 issue [Volume 23, Issue 5, p. 3].

The NPP launch represents the culmination of many years of work. Congratulations to everyone who has been part of making NPP a reality, including a special tip of the hat to the NPP Project Scientist **Jim Gleason** and Deputy Project Scientists **Jim Butler** and **Christina Hsu**.

Solid State Recorder operations and data downlinks were all nominal. CloudSat is now fully operational in Daylight-Only Operations mode. Congratulations to the flight team for this remarkable achievement!

Inevitably, the harsh environment of deep space takes its toll on instruments: moving parts wear out and bearings fail, and that appears to have been the case with the Advanced Microwave Scanning Radiometer—EOS (AMSR-E) on Aqua, whose antenna stopped spinning at 0726 GMT on October 4, 2011—most likely due to aging lubricant in the mechanism. AMSR-E is currently not producing any science data. The Aqua spacecraft accommodated the spin-down from 40 revolutions per minute (RPM) over a period of about 25 minutes, and continues to operate normally, with all other instruments functioning in science mode. NASA is working with the Japan Aerospace Exploration Agency (JAXA) to understand AMSR-E's condition. Steps under consideration include spinning the instrument back up to a relatively slow rotation rate and evaluating the science that can thereby be accomplished. The Japanese Global Change Observations Mission 1st – Water (GCOM-W1) will be launched early next year carrying AMSR2, a follow-on to AMSR-E. The satellite will fly in front of Aqua in the A-Train, allowing intercomparison of the two radiometers should AMSR-E be functional.

Finally, the annual American Geophysical Union (AGU) Fall Meeting takes place December 5-9. We encourage attendees to visit the NASA exhibit, which will showcase a breadth of NASA-related activities, including those in Earth Science. There will be a wide variety of science presentations, demonstrations, and tutorials on data tools and services—including presentations using NASA's nine-screen *hyperwall*. A daily agenda will be posted in late November on the Earth Observing System Project Science Office website at eos.nasa.gov.

Also at AGU this year, *Aqua@10* will recognize the upcoming tenth anniversary of the May 4, 2002 launch of Aqua. An oral Union Session has been scheduled for 1:40 p.m. on Thursday, December 8, to include invited and contributed presentations that highlight important scientific findings made possible by the multi-year Aqua data. A poster session is scheduled for that morning. We hope to see you in San Francisco!

Another year is rapidly drawing to a close. This year, the NASA Earth science community lost the Glory mission but also celebrated successful launches of Aquarius and NPP. On behalf of *The Earth Observer* staff, I would like to thank all of you for your efforts to advance our understanding of planet Earth and for continuing to support our publication. My best wishes to everyone for the year 2012. ■

Jason-1 Celebrates Ten Years in Orbit and Still Going Strong!

Margaret Srinivasan, NASA/Jet Propulsion Laboratory, margaret.srinivasan@jpl.nasa.gov

This month the Jason-1 mission completes its tenth year, measuring the surface height of the global ocean. Launched December 7, 2001, Jason-1 continues an extended mission, collecting detailed sea-surface topography data.

A joint NASA–French Centre Nationale d'Etudes Spatiale (CNES) endeavor, Jason-1 is the successful follow-on to the pioneering Topex/Poseidon mission, which revolutionized our understanding of the dynamics of ocean circulation and global climate. The sea-surface height measurements begun by Topex/Poseidon in 1992, continued by Jason-1, and then by the Ocean Surface Topography Mission/Jason-2 satellite launched in 2008, provide an unprecedented 19-year record of consistent, continuous global observations of Earth's ocean.

The Jason missions do not collect their observations in isolation, however a National Oceanic and Atmospheric Administration (NOAA)-led ocean profiling float project called *Argo*⁶ was created to collect *in situ* observations of the ocean surface and complement those obtained by the Jason missions. More recently, data from the Gravity Recovery and Climate Experiment (GRACE) mission have been combined with the altimetry data from Jason and Argo to give scientists an unprecedented picture of Earth's changing ocean. The combination of data from these three sources has provided an important global observing system for sea-level and ocean-circulation studies.

Early calibration phases of the missions allowed Topex/Poseidon and Jason-1, and now Jason-1 and Jason-2, to fly over identical ground tracks, providing new opportunities to cross-calibrate the spacecraft instruments to remove systematic errors. The resulting data streams have provided seamless coverage between the three missions, allowing scientists to observe and study both short-lived events (such as hurricanes) and interannual climate phenomena (such as El Niño, La Niña, and the Pacific Decadal Oscillation). It also provides the capability to closely monitor changes in global mean sea level, one of the most important indicators of human caused climate change. Other significant science results from the mission include studies of ocean circulation, the ties between the ocean and the atmosphere, and improved global climate forecasts and predictions.

The Ocean Surface Topography Science Team looks forward to the launches of the operational Jason-series satellites. The first of these launches, Jason-3, is projected for 2014 with NOAA and Eumetsat leading the efforts, along with partners NASA and CNES. Concepts for Jason Continuity of Service (Jason-CS) and the Surface Water and Ocean Topography (SWOT) missions are also underway.

⁶ The name *Argo* was specifically chosen to denote the close connection between these two missions. The Greek mythological hero *Jason* embarked on his epic quest for the Golden Fleece on a ship called the *Argo*; his companions on the adventure were members of the crew—called *Argonauts*.

Chronicling the Landsat Legacy

Laura Rocchio, SSAI, Laura.Rocchio@nasa.gov

In an era when receipt of images and data from low-Earth-orbiting satellites is more or less “routine,” it’s hard to remember that a few short decades ago this was not the case. As the first land-observing satellite program, Landsat laid foundations for modern space-based Earth observation. Today, Landsat offers the longest near-continuous data record of Earth’s land surface.

Since the project’s inception in 1966, Landsat has stood at the forefront of space-based Earth observation, and has been the trailblazer for land remote sensing as it is known today. Despite the program’s prominence in Earth observation by a civilian program, the forty-five year history of Landsat has been organizationally tumultuous. Three government agencies and a private company have operated the Landsat satellites at various times over the course of four decades and eight Landsat missions. As a result, program records have become widely dispersed, risking the loss of historical details and the proliferation of misconceptions.

Birth of the Landsat Legacy Project

In 2004, an effort to accurately document Landsat’s evolution began with the advent of the *Landsat Legacy* project. Since that time, NASA, together with the U.S. Geological Survey (USGS), has gathered over 800 pictures and documents related to the project. The library at NASA’s Goddard Space Flight Center (GSFC) has assembled a digital archive to house these materials, focusing on technical papers and a series of 21 Landsat Legacy interviews conducted with 50 Landsat veterans. In 2007—with additional support from the NASA History Office—the Landsat Legacy team began writing a book-length history using these materials¹.

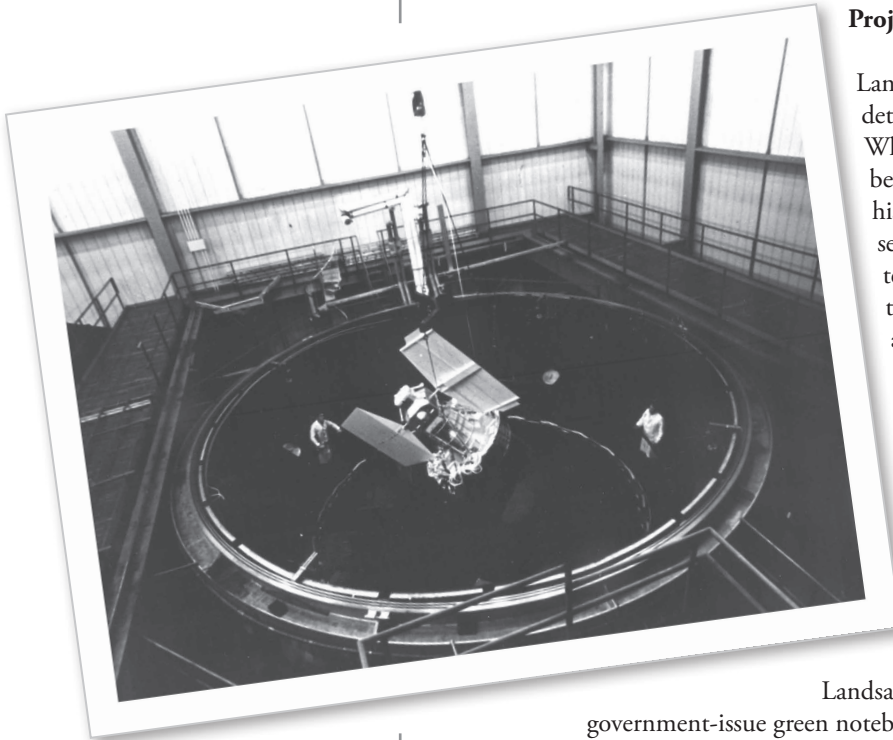

A mock-up of Landsat 1 at GE’s Space Division in Valley Forge, PA. The mock-up (a Nimbus structural model) was brought to the GSFC High-capacity Centrifuge for testing. During the spin-up the satellite was completely destroyed due to improper structural strengthening.

Project Revelations

Landsat Legacy research has uncovered lost details about the storied Landsat project. While untangling a web of long-held beliefs and objective reality, a fascinating history has emerged. The complex intersections of personalities, agency cultures, technological advances, and policy have touched everything from the conceptualization of Landsat’s first multispectral sensor to the recent emancipation of the Landsat data archive. Some relevant stories are summarized here.

Breakneck Speed

During an early oral history interview, Landsat 1² Spacecraft Manager, **Gil Branchflower** reminisced about the astounding pace of the

Landsat 1 development. He brought along his government-issue green notebooks, the content of which revealed that the first meeting between GSFC representatives and the spacecraft contractor, General Electric (GE), took place on July 20, 1970. Just two years later, on July 23, 1972, the spacecraft was launched carrying two sensors—a Return Beam Vidicon (RBV) and the Multispectral Scanner System (MSS). This remarkably short time from blueprint to orbit was achieved despite major mission complexities, integration problems with both instruments, and the complete destruction of the spacecraft structural model in GSFC’s High-capacity Centrifuge.

¹ The book is expected to be published in 2013.

² Landsat was initially called the Earth Resources Technology Satellite (ERTS) until it was changed to Landsat after the launch of the second satellite in 1975. For simplicity’s sake, the name Landsat is used throughout this article.

MSS Heritage

The MSS concept came as an unsolicited proposal from Hughes Aerospace Corporation engineer **Virginia Norwood**. The MSS was flown on Landsat 1 as an experimental instrument. However, it immediately eclipsed the relatively noisy and short-lived RBV camera system due to its better radiometric and geometric fidelity. The MSS was limited to ~60 lbs because the majority of the budgeted mass was designated for the RBV cameras that were expected to have the higher geometric fidelity essential to the mapping community, but the MSS geometry turned out to be remarkably good for its time. Well-known USGS cartographer, **Alden Colvocoresses**, had been highly cynical about the MSS's ability to collect cartographically accurate data with "a little mirror in space," but upon seeing the first MSS image he turned to his colleagues and exclaimed "Gentlemen, that's a map." He later wrote to Norwood and told her "it has become obvious to me and others, that the MSS is a real mapping instrument."



John DeNoyer and MSS Lead Engineer **Virginia Norwood** reflect on the history of Landsat.

Many longtime Landsat associates have always assumed that technology for the MSS came out of the defense world, but the converse is the reality. The MSS digital scanning technology and spectral detectors were brand new and were later adopted by military missions. The only military-to-civilian sensor technology used by Landsat was the thermal band mercury-cadmium-telluride (HgCdTe) detectors on Landsats 3–7.

Rocking the Spacecraft—The Demise of RBV

After the launch of Landsat 1 there was an on-orbit checkout period when various modules were turned on sequentially. On August 3, 1972, a power surge caused by an improperly functioning tape recorder forced ground controllers to turn the recorder off. Then, on August 6, 1972, a second massive power surge associated with the RBV instrument occurred. According to the Landsat 1 project and spacecraft managers, this huge second electrical transient physically rocked the spacecraft, causing it to lose attitude control and point away from Earth. Ground controllers quickly turned off the RBV. The spacecraft recovered, and the MSS instrument operation resumed. After a few months³ of working together, NASA and RCA engineers confirmed—by using a bench-test model—that a faulty inductor in the power-switching unit that fed the RBV was to blame for the major electrical short. The recognized superiority of the MSS data made it unnecessary to turn the RBV back on, and caused interest in RBV data to wane on succeeding missions⁴.

The Massive Landsat Science Team

Prior to 1972, the idea of using satellite data for land monitoring, mapping, or exploration was a foreign concept. For Landsat 1, scientists from a wide array of

³ Some readers may note this is imprecise; these details were supplied via oral histories—as opposed to precise timelines. According to spacecraft manager **Gil Branchflower**, "I think it took three or four months" to conduct the bench test that figured out the problem.

⁴ There is one noteworthy exception. A cadre of USGS glaciologists found the 38-meter resolution of the Landsat 3 RBV essential for distinguishing individual large crevasses in Antarctica where MSS resolution and band saturation caused problems.



Stan Freden with a Landsat 1 model in 1972.

disciplines and organizations were invited to submit proposals to become Landsat principal investigators (PIs). NASA hoped that exposure to this new Earth-observation technology would erase uncertainty about Landsat and entice scientists to examine how its data could be applied in their respective research fields. The Landsat PI request for proposals (RFP) went out in the 1970–'71 timeframe and; over 600 proposals were received in response. This was an unprecedented number of proposals to an RFP (the typical number at the time was closer to 25), and it demonstrates how Landsat democratized the scope of who could propose to and receive funding from NASA. Over a grueling two-week period, NASA reviewers whittled the 600 proposals down to 300 from universities, federal and state agencies, private industry, and approximately 100 foreign organizations representing 38 countries. The proposals that were selected and funded typically got \$150,000—a sizable sum in the early 1970s.

Stan Freden at GSFC was responsible for coordinating the research. Freden conducted four symposia to document and distribute the PI results. Landsat had quickly changed the view of

Earth's land surface—a traditionally myopic view that had instantaneously become synoptic. As an early Landsat researcher remarked, it took the Landsat MSS instrument 28.5 seconds to collect an image; it took 2.5 days flying around in a Cessna to photograph that same area.

How Landsat 3 Almost Never Came to Be

The original Landsat program included two satellites. Later, plans were adopted for a more-advanced sensor—the Thematic Mapper (TM)—to fly on two additional satellites (ultimately, Landsats 4 and 5). While work was well underway for the TM, Landsat 2 exceeded its design lifetime. “We had a growing user community, and there was concern that if we stopped data, the whole program would end,” Freden explained. An intermediary was needed, but NASA—an R&D agency—thought that a third, unplanned copy satellite was too operational. As a salve, improvements were included in the Landsat 3 design: a thermal band was added to the MSS and the RBV spatial resolution was increased. With these improvements, NASA got behind Landsat 3 as an incremental technology-expanding satellite, but the Office of Management and Budget (OMB) did not support the concept. Fortunately, **Robert Allnutt**, the NASA Assistant Administrator for Legislative Affairs, thought the public good that would derive from continuing Landsat was indispensable. When the NASA budget came to the Hill with no Landsat 3 funding, Allnutt recommended that authorization for funding be reinstated. “I recommended both in 1973 and 1974, that we add back authorization for new satellites in the series—and the Committee did so, the Senate passed the bill, and we prevailed in conference with the House (which really did not fight us on the issue),” Allnutt explained. With funding authorized, the Appropriations Committees followed suit and added funds for Landsat 3 to the NASA appropriations for two years, allowing Landsat 3 to be built and then launched in March 1978⁵.

⁵ Unfortunately, the Landsat 3 MSS was largely built using spare parts from the Landsat 1 and 2 MSS instruments. The instrument experienced problems after launch, including line-start issues that caused the loss of 30% of each image. This problem began six months after launch and plagued the sensor intermittently throughout its lifetime. Additionally, there were troubles with the thermal band and satellite tape recorders.

Thematic Mapper Challenges

In the late 1970s the TM was considered "...the most complex and pioneering Earth-viewing instrument ever proposed for a NASA program."⁶ The optical technology of the sensor was innovative, and its cold-focal-plane technology presented many fabrication problems. Additionally, GE, the contractor for the flight and ground segments, was dealing with many new communication requirements, including a Tracking and Data Relay Satellite System (TDRSS) antenna, a global positioning system (GPS), and high-data-rate download capability for TM data. In 1980, GE reported that TM integration was "pushing minicomputer state of the art," and had been more of a system driver for their segments than anyone had anticipated. To add to the complexity, Landsats 4 and 5 were mandated to be Space Shuttle retrievable, resulting in additional requirements on the satellite's structure, safety, fuel load, and performance. All these challenges caused the cost of the TM to more than double.

Commercialization

Mired in an economic stagflation, the Carter Administration commissioned studies to assess which elements of government programs could be successfully spun off into private industry.

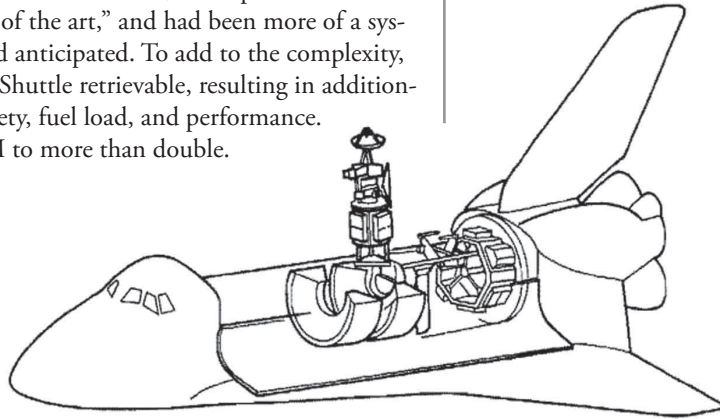

A drawing of a proposed Space Shuttle - Landsat rendezvous. While shuttle launches to polar orbit were actively pursued during the early- and mid-1980s, in the end no such rendezvous ever occurred.

After extensive studies in 1978 and 1979, the November 1979 Presidential Directive NSC-54, *Civil Operational Remote Sensing*, directed the National Oceanic and Atmospheric Administration (NOAA) to take over operations of the Landsat program and to investigate how to increase private-sector involvement in the program. President Reagan's campaign promises of smaller government left his team of advisors looking for ways to tighten the government's belt after his 1980 election. They converged on Landsat. The push to commercialize Landsat accelerated so that government funding could end as soon as possible. By 1981, NOAA was ordered to recover full operating cost from the sale of data. New prices went into effect in October 1982 and climbed to a staggering \$4400 per scene over the next three years causing data sales to drop precipitously. By January 1984, NOAA had solicited bids for commercialization. Of the seven bids offered, five were rejected for technical shortcomings, leaving only Kodak and EOSAT in the running. Kodak later withdrew its bid due to imprecise OMB financial terms. In a stinging commentary, a *Science* editorial opined that "...in the name of economy, the Administration has managed to narrow the free and open competition for Landsat down to a single bidder by changing the rules in mid-game." A decade and a half of unsustainably high data prices ensued.

Understanding Earth as a System

The notion of Earth as a connected system of environmental cycles that could influence human wellbeing (via storms, drought, famine, etc.) garnered strong scientific attention during the 1980s. The concept of using space-based remote sensing to study Earth as a system had been around since the 1960s; NASA developed a number of Earth-observing satellites through the '60s and '70s—including Landsat—with this systems approach in mind. By the latter half of the 1980s Landsat's contribution to Earth system science studies and to the mitigation of environmental stressors was developing considerable appreciation, but under the commercialization requirements the Landsat historical data archive suffered, and data prices and copyright restrictions kept its data out of many researchers' hands.

During the same period, Landsat's use by the Pentagon grew because its broad spectral range proved a strategic asset during the first Gulf War. While other satellite data of-

⁶ Quote taken from a job description put out by NASA GSFC for a System Engineer to oversee Hughes SBRC TM/MSS sensor design.

Today the 27-year old Landsat 5 satellite continues to collect data. The serendipitous surfeit of fuel from the unrealized Shuttle-retrievable plans has enabled the massively extended life of the mission, but hydrazine fuel alone has not kept the satellite alive: Landsat 5 operations engineers have overcome myriad age-related challenges.

ferred better spatial resolution, the TM's seven spectral bands enabled military analysts to tease more information out of the data by evaluating ground reflectances from the blue wavelengths through the thermal. With military and government-funded researchers as major Landsat data users, Congress—and the public, via a spate of newspaper articles—realized it was “paying twice” for Landsat data, in that tax dollars had built the satellites and then by paying a government-subsidized company for its data. As a result, after many Congressional hearings the decade-long commercialization experiment was ended, and the Landsat program returned to the government fold.

Nearly Flawless: Landsat 7 Triumphs and Tribulations

On April 15, 1999, fifteen years after Landsat 5's launch and six years after EOSAT's failed Landsat 6 launch, the government-owned Landsat 7 was orbited. Once on orbit, the excellent data quality, the consistent global archiving scheme, and reduced pricing (then \$600 per scene) led to a large increase in data users—many of them migrating back from low-cost coarse-resolution data obtained from other resources.

A new image collection method called the *long-term acquisition plan* (LTAP) was established to enable the realization of Landsat's mission—to provide systematic, seasonal, global coverage.

LTAP is a preplanned imaging scheme that enables systematic worldwide coverage. Using vegetation greenness as measured by the *normalized distribution vegetation index* (NDVI), cloud cover climatology, and cloud predictions, the optimal acquisition times for land and coastal waters of interest are dynamically determined during the daily scheduling process. More scenes are collected during vegetation green-up and senescence than during peak greenness and dormancy. Extensive modeling was used to evaluate the efficacy of the scheduling process. Earth is on average 63% cloud-covered each day, but LTAP has reduced the average cloud cover across all archived Landsat 7 scenes to 32.5%—nearly half of the global average. Applying the LTAP to the Landsat 7 scheduling system has resulted in robust worldwide coverage; inclusion of a similar plan is in the specifications for the next Landsat, planned for launch by the end of 2012 as the Landsat Data Continuity Mission (LDCM).

With the triumph of LTAP and highly accurate data calibration, the Landsat 7 mission went flawlessly until May 2003, when a hardware component failure left wedge-shaped gaps of missing data on either side of Landsat 7's images. Six weeks after suffering the loss of its scan line corrector (SLC), Landsat 7's Enhanced Thematic Mapper-plus (ETM+) instrument resumed its global land survey mission resulting in only a short hiatus in its imagery acquisition for the U.S. archive. However, the malfunction impacted the imagery of Landsat 7, essentially cutting out 22% of each scene. Fortunately for the Landsat community, the venerable Landsat 5 is still collecting data in concert with the handicapped Landsat 7.

A Marvel of Engineering: Landsat 5 Lives On

Today, the 27-year old Landsat 5 satellite continues to collect data. The serendipitous surfeit of fuel from the unrealized Shuttle-retrievable plans⁷ has enabled the massively extended life of the mission, but hydrazine fuel alone has not kept the satellite alive: Landsat 5 operations engineers have overcome myriad age-related challenges.

As an example, as Landsat 5 approached its 100,000th orbit on December 19, 2002, engineers had to find a way to incorporate a six-digit orbit number into the flight control and data processing software because the original software allowed for only a

⁷ NASA came very close to implementing these plans for shuttle launches into polar orbit. To learn more see “The Earth Observing Legacy of the Space Shuttle Program” in the September–October 2011 issue of *The Earth Observer* [Volume 23, Issue 5, pp. 4–17].

five-digit orbit number, as no one imagined that the satellite would still be flying 18 years—and 99,999 orbits—after its launch. And absolutely no one imagined that after extensive software updates to address perceived problems that could have been caused by the turn of a new century (“Y2K”) that more than a ten-year extension of the star catalog would be needed, but it was.

On January 1, 2010, the star map for January 1, 1910 was inadvertently uploaded, making Landsat 5's attitude stray as it attempted to locate stars where they had been 100 years ago; fortunately, the satellite easily recovered.

Over the years, serious anomalies have struck the Landsat 5 solar array, batteries, communications system, and attitude system, and virtually none of the redundant systems are still available. Despite this, the flight operations team has successfully dealt with all of these anomalies by adapting ground control procedures, modifying orbital operations, and—in some cases—resurrecting onboard equipment previously thought to be unrecoverable. Their efforts to recover the satellite from these potentially mission-ending anomalies were recognized by the American Institute of Aeronautics and Astronautics in 2006 with receipt of the *International SpaceOps 2006 Award for Outstanding Achievement*.

Free Data—A World of Influence

In April 2008, the USGS (with a strong push from then-Associate Director of Geography, **Barb Ryan**) announced that all archived Landsat data would be made available for free.

USGS Director **Mark Myers** explained that by opening the Landsat archive for free electronic access, the USGS sought to promote “...a common global understanding of land conditions—historical and contemporary—for users worldwide.” The USGS made Landsat data available for no cost starting in October 2008 (with free Landsat 7 data); in January 2009, Landsat 1–5 data were also made available at no cost. Since then, the USGS has experienced a 60-fold increase in daily data downloads. In August 2009, the millionth free scene was downloaded; the following August downloads hit three million; and in August 2011, free downloads surpassed six million. The success of the new Landsat data policy is encouraging other international projects to follow suit. Free Landsat data, paired with today's powerful computer processing capabilities, have enabled large-scale, global-change studies that in the past were too costly to be conducted by all but a few institutions. These policies have heralded what some are calling a “democratization of satellite mapping.”

Continuing the Legacy

The eighth Landsat satellite—the LDCM—is currently under development and scheduled to launch in December 2012⁸. Plans for an operational Landsat program run by the Department of the Interior (and starting with Landsat 9) have been developed, but face congressional vetting before being funded. LDCM and an operational Landsat program will continue the legacy of Landsat's rich, global, medium-resolution data archive.

Understanding the Historical Archive

The benefit of the Landsat archive is its depth. Looking back into the archive many coverage “holes” are found prior to the implementation of LTAP. Many areas of missing data were perplexing, but the Legacy project has cast light on this. Early collection priorities for the original 300 principal investigators, large-scale projects with the U.S. Department of Agriculture, work with **Jacques Cousteau**, and a coastal bathymetry campaign coupled with downlink limitations, frequent onboard recorder failures, and no prompt way to visually inventory the spatial coverage of the global data archive have been found to be the main reasons behind the strange global coverage patterns that appear in the early archive.

⁸ LDCM will be renamed Landsat 8 when it reaches orbit.

Free Landsat data, paired with today's powerful computer processing capabilities, have enabled large-scale, global-change studies that in the past were too costly to be conducted by all but a few institutions. These policies have heralded what some are calling a “democratization of satellite mapping.”

Filming of a Landsat Legacy oral history, November 2008 Pecora Conference in Denver, CO, featuring **John DeNoyer** and **Virginia Norwood**.

Strong Personalities Behind Landsat

Throughout the Landsat history, a number of spirited personalities have emerged to shape the project. A few notable names among the early Landsat pioneers were Secretary of the Interior **Stewart Udall**, USGS Director **William Pecora**, NASA scientist **Bill Nordberg**, MSS engineer **Virginia Norwood**, USGS cartographer **Alden Colvocoresses**, Berkeley professor **Robert Colwell**, and Purdue professor **David Landgrebe**. Some had magnetic personalities, some imposing, but all were



influential on the Landsat program. Much as Pecora replied to a congressional review prior to Landsat 1's launch when asked if he preferred the RBV or the MSS, "Well, it's like beer. There's good beer and there's better beer, but there's no bad beer."

Acknowledgment: The Landsat Legacy Team members are: **Terry Arvidson** [Lockheed Martin]; **Sam Goward** [University of Maryland, College Park]; **Jim Irons** [GSFC—LDCM Project Scientist]; **Shaída Johnston** [Global Science & Technology, Inc.], **Laura Rocchio** [GSFC/Science Systems and Applications, Inc.]; and **Darrel Williams**. [GST].

Additional Resources

Landsat Resources
landsat.gsfc.nasa.gov
landsat.usgs.gov

Landsat Legacy Project
library.gsfc.nasa.gov/landsat

The DEVELOP National Program Works With the Group on Earth Observations on Air Quality, Public Health, and Water Quality: An International Collaboration Between the U.S. and Mexico

Yanina G Colón, Wise DEVELOP Program, ycolon@wisedevelop.com

Giovanni Colberg, Wise DEVELOP Program, gcolberg@wisedevelop.com

Semiha Caliskan, Wise DEVELOP Program, scaliskan@wisedevelop.com

Pedro Rodríguez, Wise DEVELOP Program, pedro@wisedevelop.com

Kaitlyn Collins, Wise DEVELOP Program, kaitlyn@wisedevelop.com

Jiaxun Chai, Wise DEVELOP Program, jchai@wisedevelop.com

Lindsey Honaker, Wise DEVELOP Program, lhonaker@wisedevelop.com

Apsara Aryal, Wise DEVELOP Program, aaryal@wisedevelop.com

Rebecca Tate, Wise DEVELOP Program, rebecca@wisedevelop.com

Delores Hayes, Wise DEVELOP Program, dhayes@wisedevelop.com

Introduction

The DEVELOP National Program, a NASA Applied Sciences training and development program for students and young professionals, bridges the gap between science and its applications to societal needs. Projects conducted by DEVELOP interns emphasize the use of satellite remote-sensing technology and geographic information science (GIS) for use in hands-on environmental research that provides end users with beneficial decision-making tools. Outcomes and deliverables are presented to policy makers with the purpose of enhancing environmental policies.

DEVELOP began at NASA's Langley Research Center (LaRC) in 1998. The Wise County, VA location was the first node to join DEVELOP in 2001. The office was established as a result of a partnership between DEVELOP and the Wise County Circuit Court Clerk's Office. Currently, there are eleven DEVELOP offices in North America.

Six of the eleven offices are at NASA Centers: Ames Research Center (ARC), Goddard Space Flight Center (GSFC), Jet Propulsion Laboratory (JPL), LaRC, Marshall Space Flight Center (MSFC), and Stennis Space Center (SSC). Four are at regional locations; the Great Lakes and St. Lawrence Cities Initiative (Chicago, IL), Mobile County Health Department (Mobile, AL), St. Louis University (St. Louis, MO), and the Wise County Clerk of Court's Office (Wise, VA). In addition, there is one international location, in Monterrey, Mexico at the Tecnológico de Monterrey. Historically, DEVELOP has focused on environmental concerns associated with community issues within the U.S. However, Wise DEVELOP participants have been given the opportunity to broaden the program's impact, allowing them to conduct projects through international collaboration.

Wise DEVELOP distinguishes itself through its diverse, international student body. In addition to local students—from Virginia, Kentucky, Tennessee, and West Virginia—the team has hosted international student interns from Mexico, Spain, China, Romania, India, Nepal, Kenya, and Turkey. International students are engaged in



The Wise County DEVELOP Summer 2011 team pictured after a presentation at LaRC on August 8.



Wise County DEVELOP Fall 2011 team members—[left to right] Giovanni Colberg, Yanina Colon, Apsara Aryal, Pedro Rodriguez, Kaitlyn Collins, and Jiaxun Chai.

The new methodologies, established using Earth-observing satellite data, have led to improvements in disease surveillance and life-saving measures that can be implemented by agencies responsible for the health and well-being of Mexico's population.

opportunities that afford them the chance to gain real-world experience in applying the science of space-based Earth-observing data, providing perspectives on global-environmental issues, public outreach, and management training, while simultaneously being immersed in Southern U.S. culture.

After submitting a proposal to the U.S. Group on Earth Observations (USGEO), the Wise DEVELOP team was chosen to conduct research projects that target environmental issues in Mexico. The team addressed water-quality issues near the Lerma River; air-quality concerns associated with particulate matter in Monterrey,

Mexico; and the impacts of dengue-fever outbreaks on public health across Mexico. Currently, three Wise DEVELOP-GEO projects are being conducted through collaboration with a team of students in Monterrey. Having advisors and students working together in Mexico and the U.S. has been critical to project success. Participants in Monterrey have provided continuous support to project end users. They have also had the opportunity to appear on local news stations and in multiple newspaper articles, raising awareness about DEVELOP in the community.

Research Projects

Satellite remote sensing has increasingly become a preferred tool in studying Earth as a system. It has provided a clearer perspective of our planet than other methods, and has made humans more intimately aware of the environmental issues we face. To address some of the specific environmental issues taking place in Mexico, students and young professionals at Wise DEVELOP partnered with organizations such as the Instituto Tecnológico y de Estudios Superiores de Monterrey and Comisión Nacional del Agua (CONAGUA) to develop and conduct three projects. The results from the projects highlight the capabilities of Earth-observing-satellite data and provide decision-support tools to international users.

Mexico Public Health Project (Dengue Fever)

The Mexico public health project used NASA Earth Observing System capabilities to investigate important environmental factors that lead to the spread of dengue fever across nine states in Mexico.

Dengue fever is a virus-based disease primarily transmitted by the female mosquito, *Aedes aegypti*, when they bite mammals for blood, which is their food source. The virus is a leading cause of illness and death in humans in the tropics and subtropics. Typical symptoms include headache, skin rash, and muscle and joint pain. Currently, there is no cure for the disease and no vaccine is available; however, measures that reduce the carrier's habitat and limit the exposure potential for at-risk human populations are used to decrease the virus' incidence.

Using Earth-observing satellite data acquired by NASA's Tropical Rainfall Measuring Mission (TRMM) and Aqua satellites, the team collected and analyzed rainfall, relative humidity, and surface temperature measurements. They also generated *normalized difference vegetation index* (NDVI) and *enhanced vegetation index* (EVI) maps. This allowed them to isolate environmental factors statistically correlated with the incidence of

dengue fever (derived from other sources) throughout a range of variable weather conditions. These results help Mexican government agencies locate ideal breeding grounds, as well as identify optimal conditions that could accelerate the spread of disease.

The project also focused on the development of a mathematical model to be used in forecasting future dengue fever outbreaks, using these environmental data as indicators. The new methodologies, established using Earth-observing satellite data, have led to improvements in disease surveillance and life-saving measures that can be implemented by agencies responsible for the health and well-being of Mexico's population.

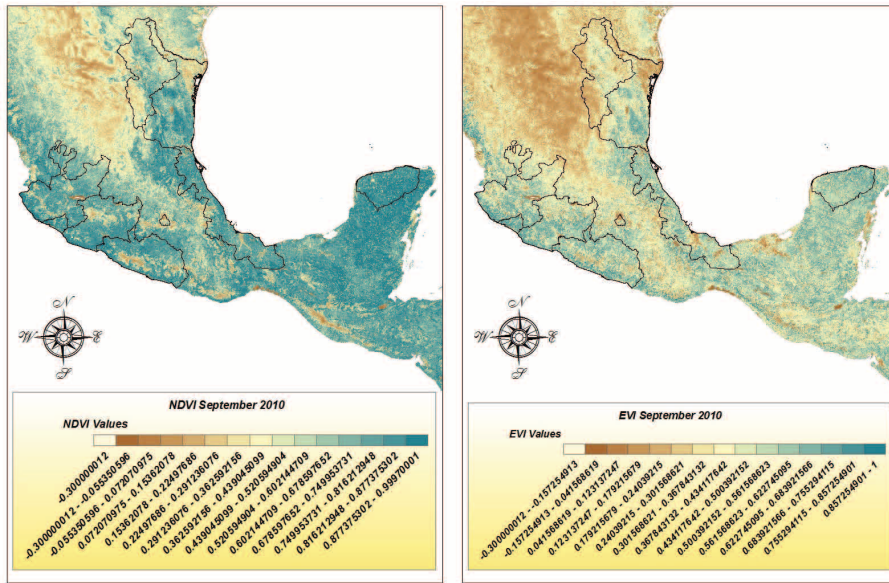

These NDVI [left] and EVI [right] maps were created using data from Aqua's Atmospheric Infra-red Sounder (AIRS) for the study area in Mexico for September 2010. Lighter shades represent arid areas, while darker shades represent high amounts of vegetation.

Monterrey Air Quality Project

Monterrey is the capital city of Nuevo León, a state located in Northeastern Mexico, bordering the U.S. The city accounts for approximately 95% of the state's gross domestic production (GDP), and is known for its large steel industry. The Monterrey metropolitan area (MMA) is one of the most industrialized regions in Mexico, and currently faces air-pollution problems caused by industrial practices, increases in population, high *per capita* automobile mileage, and poor vehicle-emission standards.

This study, based on health records, remotely sensed Earth-observing satellite data, *in situ* data, and environmental modeling, sought to explore a potential relationship between concentrations of particulate matter (PM) and environmental and social factors as well as respiratory disease rates in the MMA. The major focus of the project was on measuring PM₁₀—particulate matter less than 10 μm in diameter. TRMM's

Land cover distribution in the Monterrey metropolitan area.

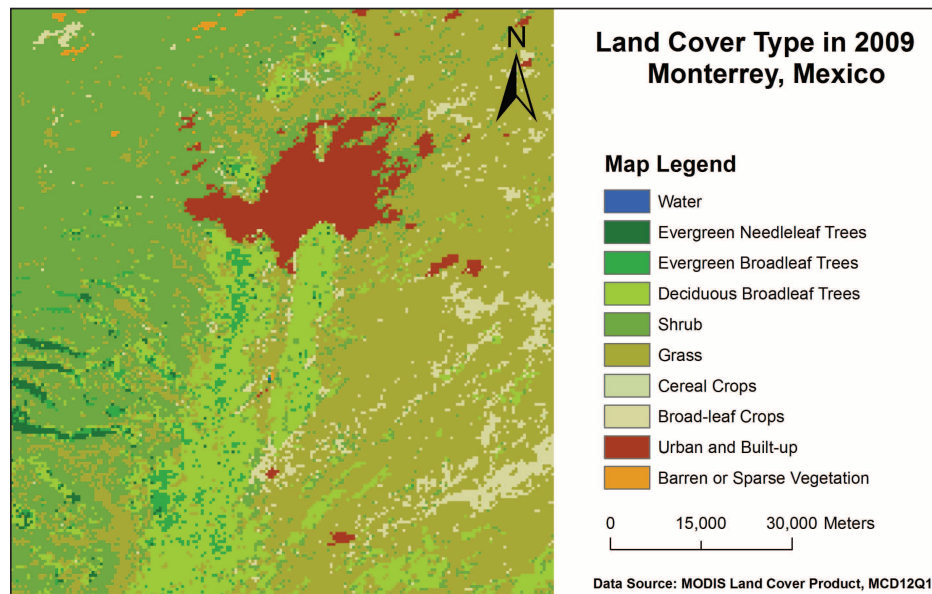

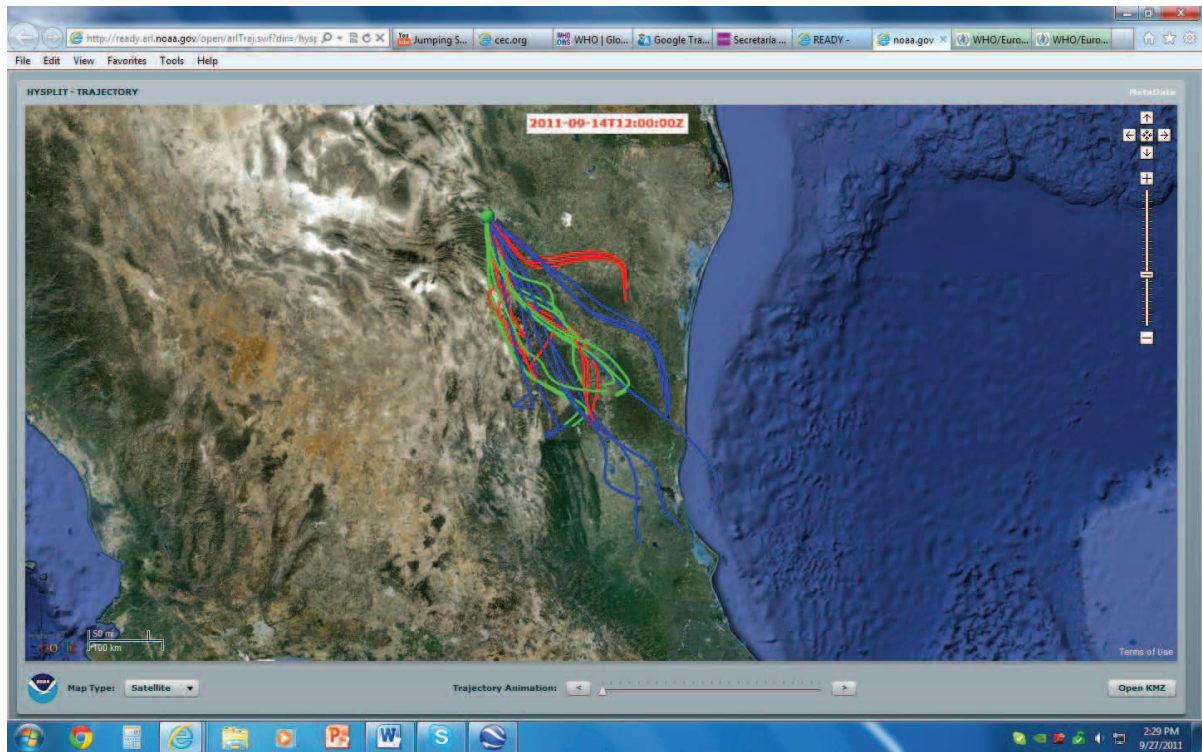

HYSPLIT 24-hour backward trajectory simulation of the Monterrey metropolitan area from September 14, 2011. Team members use these trajectories to help them track the movement of air pollution. **Data source:** Air and Resource Laboratory.

Precipitation Radar (PR) and Aqua's Moderate Resolution Imaging Spectroradiometer (MODIS) instrument, along with the Hybrid Single Particle Lagrangian Integrated Trajectory (HYSPLIT) model were used to provide observations and particulate trajectories. Statistically significant relationships were found between increasing PM_{10} levels and the expansion of industrial sectors and the variability of atmospheric parameters around the metropolitan area. Analysis of the HYSPLIT trajectories revealed that topography also plays a part in forcing wind patterns such that particulate matter is often transported to the MMA.

Although large amounts of air-quality data exist, they generally are not provided in a readable, user-friendly format. Having access to user-friendly data will give government officials the ability to take more effective action and to raise awareness among the MMA population, further supporting abatement measures. It would also provide more organized data for future research and allow the government and other collaborators—such as project partners like the Sistema Integral de Monitoreo Ambiental de Monterrey (SIMA) and Índice Metropolitano de la Calidad del Aire (IMECA)—to continue processing multiple datasets of emissions and other pollutants for future MMA air-quality studies.

Lerma River Water Quality Project

The Lerma River study addresses public health and water-quality concerns related to agricultural practices in the basin formed by Mexico's Lerma River watershed and Lake Chapala—Mexico's largest freshwater lake. Water quality is important to local residents, who could be negatively impacted by water contaminants such as irrigation runoff. Many diseases—such as typhoid fever, ascariasis, amoebiasis, viral hepatitis, and certain types of cancer—can be caused or worsened by the presence of agrochemicals in the environment.

According to the project's statistical analysis, using data from Mexico's National Institute of Statistics and Geography (abbreviated *INEGI*, from its Spanish name), there has been an increase of such diseases in the states of Guanajuato, Michoacán, and México from 1998-2009. It is important to identify factors contributing to the occurrence of these diseases so that they can be effectively controlled and reduced.

Spatiotemporal analysis and satellite remote-sensing data provide a means to monitor and correlate disease occurrence, land-use changes, and agriculture trends that could prove dangerous to the area. With data acquired by Landsat 5's Thematic Mapper (TM) and the MODIS instrument on the Terra and Aqua satellites, students used GIS to study surface trends in rate and cause of mortality, size of population, socio-economic patterns, changes in landscape and agricultural practices, as well as point and nonpoint pollution sources that contribute to disease occurrence and poor water quality in the study area. The team did analyses that compared these with factors such as anthropogenic land-cover change, agricultural growth, and NDVI values. These results and methods will benefit one of the project's partners, CONAGUA, by augmenting decision making related to best-management practices for the watershed, and improving water quality and the quality of life, overall.

Conclusion

Based on their work, the Wise DEVELOP team has participated in numerous conferences, with recent presentations at the 2011 Esri International User Conference in San Diego, CA; the Meta-Leadership Summit of Preparedness in Blacksburg, VA; the Council of States Governments Annual Conference; and the Southwestern Virginia Technology Council 11th Annual Awards Banquet.

Students participating at the Wise and Mexico DEVELOP locations have gained invaluable experience in conducting scientific research, and learned the importance of international collaboration. They recognize the global impacts of their research and understand that these projects benefit partner organizations by aiding in the decision-making process. The reward to students and young professionals is tremendous as they work to pass along those benefits and expand the network of organizations and individuals using Earth-observing satellite data.

Future directions for the Wise DEVELOP team will focus on expanding research in Mexico, and forming partnerships in other countries.

For more information about the DEVELOP National Program, visit: develop.larc.nasa.gov.

This map shows population change in five Mexican states from 1998–2009. A natural break classification method was used to visualize and compare the population change. Darker shades signify more dramatic population changes. The bar charts represent the total disease count associated with agriculture. **Data source:** CONAGUA

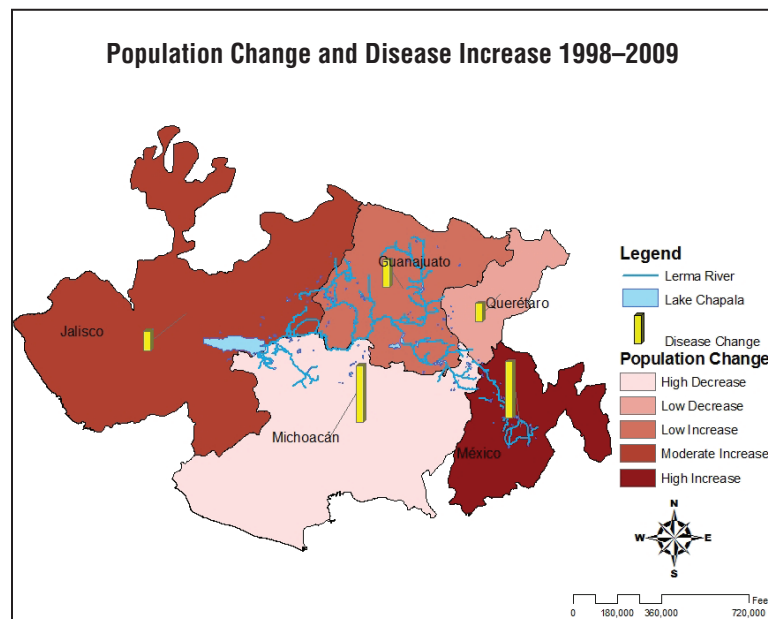

Students participating at the Wise and Mexico DEVELOP locations have gained invaluable experience in conducting scientific research, and learned the importance of international collaboration. They recognize the global impacts of their research and understand that these projects benefit partner organizations by aiding in the decision-making process.

The State of Research and Questions About Future Changes in the Boreal and Arctic Zones

Heather Hyre, NASA's Goddard Space Flight Center/Wyle Information Systems, heather.r.hyre@nasa.gov

Arctic Workshop—Future Changes in the Boreal and Arctic Zones

During the morning hours of Thursday, September 22, 2011, scientists from NASA's Goddard Space Flight Center (GSFC), the University of Maryland (UMD), and the Houston Advanced Research Center (HARC) gathered for a workshop to summarize a collective understanding of the state of research and questions about future changes in boreal and Arctic zones. The group addressed current progress, modeling efforts, and experimental data gathering in this region and identified important questions and “grand challenges,” with a particular emphasis on NASA's unique technological and scientific capabilities to respond to these questions and challenges.

Scientists—including **Marc Imhoff**, **Piers Sellers**, **Forest Hall**, **Jon Ranson**, **Compton Tucker**, **Lahouari Bounoua**, **Robert Harriss**, **Thorsten Markus**, **Richard Cullather**, and **Josefino Comiso**—presented their research, concerns, interests, and understanding on changes across areas above 50°N latitude.

By the end of the workshop, the “big picture” was clear: **The scientific community is now dealing with a large, nonlinear, interactive, coupled system, one that demands cross-discipline attention and linkages across scales. The impacts of climate change on the boreal and Arctic regions will all have profound political, economic, and social ramifications that demand attention.**

At close, the group proposed the idea of forming a working group to develop strategies to address current issues and to predict new ones.

Welcome and Overview

To begin the workshop, **Marc Imhoff** [GSFC] provided an overview of the workshop's goals, and welcomed **Robert Harriss** [HARC], a former NASA Earth scientist. Harriss' trip to GSFC sparked interest in having NASA and its partners come together to discuss the state and impending changes in the Arctic and boreal zones. Imhoff presented a polar view of the nighttime Earth, highlighting the extensive urban (i.e., well-lit) areas located near boreal zones to establish a perspective on how large of an area is at stake and the potential geopolitical and environmental importance of the changes that are occurring.

“If we're going to get any nasty surprises in terms of carbon releases, physical climate system changes, drift in biomes...it's going to happen here,” said **Piers Sellers** [GSFC—*Deputy Director of the Sciences and Exploration Directorate*] before reminding the group he and other scientists at GSFC are “agnostic” about where to go and what should be considered first. This comment enabled a diverse discussion about the state of current and future research.

What Did BOREAS Tell Us?

Boreal ecosystems typically begin around 50 °N latitude and expand northward, covering large portions of Rus-

sia and Canada. This circumpolar region is home to many of the accelerating effects caused by our changing climate. The Boreal Ecosystems Atmosphere Study (BOREAS) was a large-scale (1000 x 1000 km area), joint U.S. and Canadian investigation of the boreal region and its interactions with the lower atmosphere. To study these interactions, satellite, *in situ* aircraft and tower measurements, and model outputs were used to better understand exchanges of radiation, heat, water, carbon dioxide, and other trace gases between the boreal forest and the atmosphere. There were five field campaigns in 1994 and four in 1996, covering most of Saskatchewan and Manitoba, Canada.

Forrest Hall [GSFC] explained to the audience that it was through BOREAS and its multiplatform capabilities that the group was able to make major contributions to NASA's 21st Century Decadal Survey. Hall provided a retrospective view of global climate models and their predictions, pointing out that predictions made 20 years ago have now become a reality in boreal zones. Airborne measurements—like those taken during BOREAS—have strengthened models by allowing calibration between ground-site observations and satellite remote-sensing techniques. “We've provided the foundation for the Earth Observing System (EOS) data-product algorithms and decadal-survey-mission concepts using the helicopter spectrometer scatterometer measurements,” said Hall. “We've validated a lot of

the optical and radar techniques; we flew lidar, we flew the Moderate Resolution Imaging Spectroradiometer (MODIS) simulator, we flew multifrequency radar, Airborne Visible/Infrared Imaging Spectrometer (AVIRIS) hyperspectral [instruments] on a couple of aircraft, and I think we showed that you can infer vegetation three-dimensional properties using these mobile sensors.”

BOREAS and other early field campaigns helped validate energy, water cycle, and even weather prediction models. While BOREAS (and other strictly Canadian programs) unveiled a number of findings that led to improvements for studying the Arctic and boreal zones, there still remains a great deal to be determined—especially in a region where changes occur so rapidly. That is exactly what Hall suggested when he concluded that we need to develop and validate space-based capabilities to measure: Biomass; photosynthetic rate; carbon dioxide and methane; soil moisture; and precipitation.

Noticing Changes in Biomass: Ready for the ‘Big Burp?’

“Can we detect biomass?” asked **Jon Ranson** [GSFC] as he took the floor. The simple answer is yes, but the lengthy answer is that there is no single measurement that tells us exactly what we need to know about biomass in the northern forests. Taking advantage of fieldwork and access to satellite data, Ranson’s research group was able to develop a classification for mapping biomass. This allowed them to document changes in species type and vertical canopy structure in Siberia¹.

Ranson said that the changes are “...slow now, but when you add them up over a large area, conceivably it is an important problem.” He added that now is the time to act, especially with the looming threat of melting permafrost. Larches for example, make up approximately 40% of Russian forests, and 70% of that total are located on permafrost. “We have to get ready for the ‘big burp,’” Ranson joked, trying to make light of the potential for huge amounts of methane being released into our atmosphere.

The real challenge is in the complexity of the region as the changes are heterogeneous and are taking place rapidly. Data from a single sensor will not suffice; rather, it is only by combining data collected by numerous instruments that we will attain a better understanding of the changes we are seeing in the boreal and Arctic zones.

¹ In the September-October 2007 issue of *The Earth Observer* [Volume 19, Issue 5, pp. 13-21], **Jon Ranson**, **Slava Kharuk** [Sukachev Forest Institute], and **Joanne Howl** described their expedition to Siberia. Later, in the January-February 2009 issue of *The Earth Observer* [Volume 21, Issue 1, pp. 9-20], the same three authors wrote about a return trip to Siberia.

A 30-year Vegetation Index Reveals Changes in the Tundra

Compton Tucker [GSFC] and many other scientists at GSFC and the University of Alaska have contributed to an intercalibrated 30-year *normalized difference vegetation index* (NDVI) dataset. The value of the dataset lies within its high degree of intercalibration among satellite instrument and ground-site observation data over a 30-year period; this allows trends within the data to be identified.

“What we find for the total increase in an Arctic biomass is about a 20% increase from 1982–2010,” Tucker stated, “[This is] about a 20% increase in aggregate for the tundra area.” He pointed out that it is not surprising given that there is a high degree of correlation between vegetation productivity, temperature, sea ice, and snow cover.

Tucker finished by telling the group that the tundra area is close enough to the Arctic Ocean that it will increasingly become more of a maritime climate. With a slight increase in temperature, some areas will become more humid, producing more snow. When snow melts and warms up it opens the door for more primary production. Tucker concluded by mentioned that working on the ground and collecting samples out in the field is vital for satellite calibration and validation.

Understanding the Physical Climate System

Lahouari Bounoua [GSFC] began his presentation pointing out the importance of *scale* (i.e., areal extent) when considering the physical climate system of the boreal and Arctic zones. Understanding the Arctic (i.e., ocean) and boreal region (i.e., land) as one entity is key.

Satellite data have certainly played a key role in revealing the scale of the Arctic, providing an overview of the region, and in particular bringing the issue of sea-ice loss to the forefront. The changes in sea-ice extent as seen by satellite imagery in the 1980s fueled early discussion about climate change, later resulting in the development of working groups to support the Intergovernmental Panel on Climate Change (IPCC) in 1988.

“The idea is that the poles are warming faster [than the rest of the globe],” said Bounoua, “and the North Pole is warming even faster than the South Pole. Average Arctic temperatures have increased at almost twice the global average rate in the past 100 years [IPCC, Fourth Assessment Report, 2007]. The question is: Why?” The IPCC states that it is very likely due to an increase in *anthropogenic* (i.e., originating from the activities of humans) greenhouse gas emissions in the Northern Hemisphere.

Several characteristics of the Arctic environment amplify changes caused by warming. Bounoua pointed out that the differences in the ice-albedo feedback, the depth of cold air, the stable-temperature structure, the reduction in sea ice, and the changes in atmospheric and ocean circulations in the Arctic all play significant roles. Understanding these characteristics and what they might mean for positive and negative climate feedbacks will help us gain a better understanding of the effects of climate change in the Arctic and boreal zones. Bounoua concluded his remarks by saying that in order to study these characteristics in greater detail, "...we need to have more observations, and observations that are allotted to the scale of the phenomena of the problem we want to solve."

A Year of Review in the Arctic

After spending a year reviewing scientific literature about Arctic geomorphology, **Robert Harriss** became extremely interested in permafrost, a region that is currently in the "early stages of profound change in its land structures."

Permafrost covers 24% of the land surface in the Northern Hemisphere, including portions of Russia, Canada, China, the U.S., Mongolia, and Greenland. The permafrost in these regions is beginning to warm and melt (particularly along coastlines), and shifting inland. There has been acceleration in "the hydrologic

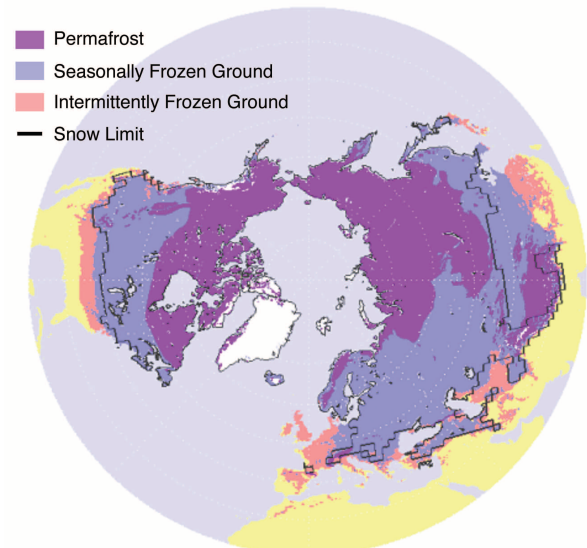

This image reveals the extent of frozen ground in the Northern Hemisphere. Permafrost covers 24% of the land surface. **Image credit:** Zhang et al., 2003: 8th International Conference on Permafrost.

cycle through the development of a number of features," said Harriss. Some of the first features to develop as a result of melting permafrost are lakes. Over time, these lakes drain into rivers, ultimately reaching the ocean. Harriss mentioned that, "All of the major rivers draining into the Arctic have shown an increase flux over time for the last decade." Increases in freshwater input into the ocean may have significant effects on ocean circulation patterns.

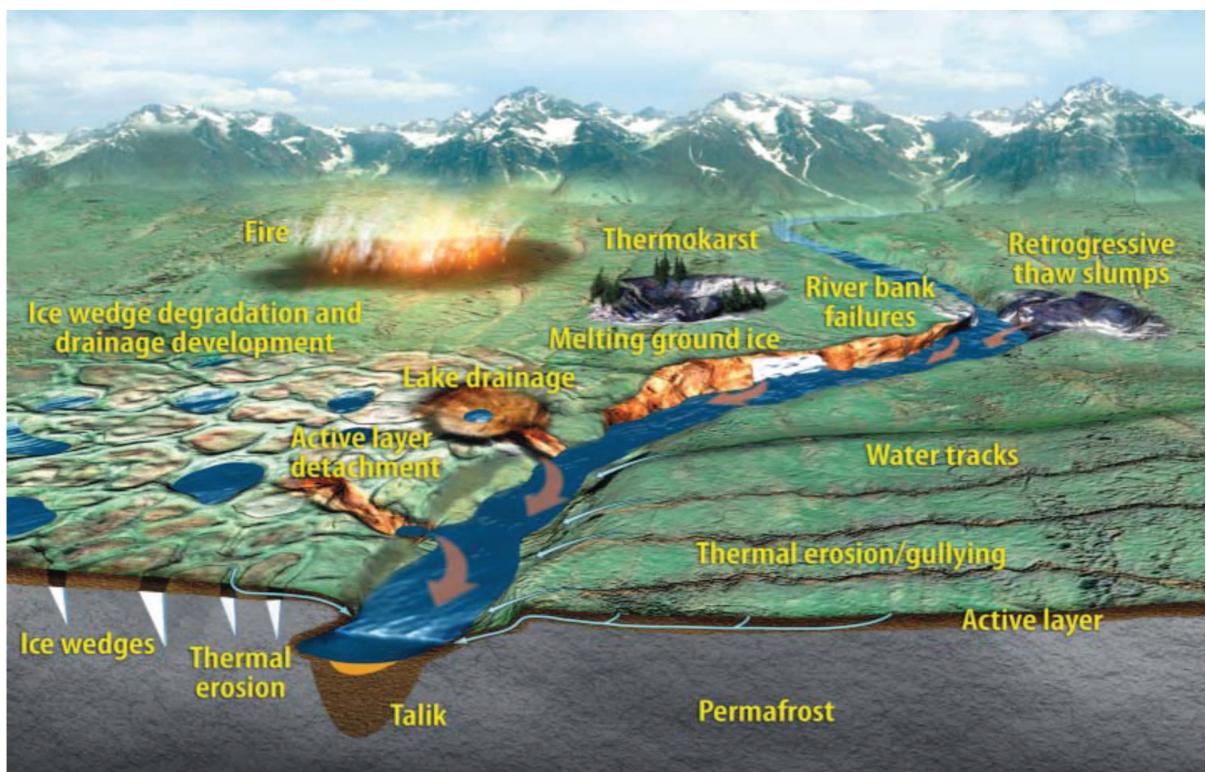

Robert Harriss showed this conceptual depiction of the Arctic landscape highlighting observed changes in response to thermal alterations of permafrost and melting of ground ice.



Retrogressive thaw slump (>400 m) activity has taken place on Herschel Island, in Yukon, Canada. **Image credit:** Robert Harriss [HARC]

Harriss showed images portraying the effects of melting permafrost in the Arctic, from the tops of mountains to their valleys. There has been an increase in the number of mudslides occurring on south-facing slopes, gullies, collapsing pingos, and thaw lakes throughout the region. An image of a thaw lake ~19 mi (30 km) from the ocean showed how vegetation has begun to separate, exposing large areas of dark soil, which decreases surface albedo.

Switching gears, Harriss spent time reviewing changes in coastal erosion in the Arctic. He stated that, the incredible acceleration of coastal erosion due to the shrinking of the summer sea ice is surprising to many studying the Arctic. Permafrost cliffs in Russia ~66 ft (20 m) high are receding at ~36 ft/yr (11 m/yr), mainly due to an increase in summer storm intensity. Harriss stated that, “Right now, there is a very large question mark on this particular process of coastal erosion and how much carbon gets transported and essentially put away in the bottom of the Arctic Ocean.” He later showed a graph that showed more sediment from the Lena Delta in Russia being transported into the ocean from coastal erosion than from rivers. Mass wasting of this magnitude could have profound effects on carbon sink and source regions that need to be better understood. Harriss encouraged the use of satellite remote-sensing data to help quantify these regional changes, to come up with a more comprehensive dataset.

Arctic Sea Ice

Thirty years of passive-microwave satellite data have allowed us to observe changes in the extent of Arctic sea ice, began **Thorsten Markus** [GSFC]. Over the last decade, there has been a general decline in minimum sea-ice extent. This year (2011) has had the second smallest extent since 1979. (The lowest sea-ice minimum occurred in 2007.) The Arctic is a highly dynamic system where ocean circulations play a key role. “It looks alive, doesn’t it?” asked Markus as he showed a fascinating time-lapse video of Arctic sea ice, using brightness-temperature data derived from the Advanced Microwave Scanning Radiometer for EOS (AMSR-E).

“Where do we need to focus our science?” asked Markus. He advised that focus should be given to the changes we are seeing in sea-ice dynamics to ensure better parameterization of small-scale processes in the models. Markus concluded by saying we need more widespread, small-scale datasets with higher temporal and spatial resolutions to study changes in the Arctic.

Modeling the Arctic

Richard Cullather [GSFC] began his presentation on Arctic modeling uncertainties by saying that, “Modeling and data assimilation are significant challenges for the Arctic.” Because there is little human presence

in the Arctic, surface data are generally sparse in this region. Physical properties (e.g., multiphase cloud and precipitation properties) associated with higher latitudes therefore are not fully understood. Cullather said that the lack of data, and thus understanding of physical processes, have lead to incorrect physical-property parameterizations in model and reanalysis data over the Arctic.

In an effort to overcome the frequent lack of observational data, the Global Modeling and Assimilation Office (GMAO) at GSFC conducts research aimed at maximizing the impact of satellite observations in climate, weather, and atmospheric-composition prediction. Cullather pointed out that the GMAO has a significant commitment to understanding these difficult Arctic processes, and provides relevant modeling and assimilation. In particular, the GMAO uses the Modern Era Retrospective-analysis for Research and Applications (MERRA). MERRA is a NASA reanalysis that extends over the past 15 years, blending numerical model outputs with the real-world constraints of observational data.

Cullather noted that, in association with the decline in sea ice, recent changes show an anomalous high-pressure system centered over the Arctic. This high-pressure system will help concentrate sea ice into a much smaller area, and will also produce sunnier skies that will melt the sea ice. Results from MERRA reanalysis suggest similar patterns in the Arctic, and agree with other reanalysis data.

Cullather closed by pointing out the high level of uncertainty in understanding Arctic physical processes that go into these models. “Nevertheless, GMAO assimilation products can tell you useful information on budgets and climate assessment; and they can be useful for process studies if they are treated with caution.”

A Connection Between Sea Ice and Phytoplankton

Josefino Comiso [GSFC] explained that when sea ice melts in the spring, it produces a layer of fresh water that has a lower density and is relatively stable. The Arctic becomes a breeding ground for phytoplankton blooms as the new nutrient-rich water is exposed to abundant sunshine. He noted that each spring, phytoplankton blooms fill the area, and the North Pacific Ocean and Bering Sea become some of the most productive areas in the world.

The Sea-viewing Wide Field-of-view Sensor (SeaWiFS) provided quantitative data on global ocean bio-optical properties by monitoring changes in ocean color. “SeaWiFS is really the first system that enabled us to look at the spatial distribution of plankton in the Arctic,” said Comiso. In terms of phytoplankton, there has been a rising trend in recent years, he continued. This may influence the amount of carbon dioxide being released into the atmosphere in the Arctic. Comiso pointed out that fewer changes have been found in the amount of phytoplankton in the North Pole region, however, and that this is most likely due to cooler ocean temperatures and, thus, the lack of available nutrients.

Comiso concluded by saying, “The only way to monitor productivity in the Arctic is really through satellite systems.” Instruments such as MODIS and the Advanced Land Imager (on the Earth Observing-1 satellite) can also be used to detect ocean color from space.

Closing Remarks

“It’s all changing and it’s all connected,” announced Piers Sellers. His remarks indicate that it is clear that the research community needs better observations that will strengthen the models, but they also need to integrate their efforts so that they can identify where these crossdisciplinary areas are to be able to develop strategies to address specific issues.

Marc Imhoff raised the possibility of connecting with agencies outside of NASA to integrate ground data to improve satellite products. “If we could get access and get involved with some of these other field experiments, we could leverage that to improve global products,” said Imhoff. Robert Harriss agreed, pointing out that the areas where these changes are taking place most rapidly are Russia and Canada. He suggested that a meeting be organized to allow NASA’s scientists to reconnect with colleagues.

“So, are we proposing that we take the next step?” questioned Forest Hall. The group agreed that it would be a good idea to combine all of the knowledge currently understood about the Arctic and boreal zones in order to determine “what’s missing” from current research.

A follow-up meeting has been suggested, but no further details have been determined. ■

Aura Science Team Meeting Summary

Anne Douglass, NASA's Goddard Space Flight Center, anne.r.douglass@nasa.gov

The annual Aura Science Team Meeting took place September 13-15, 2011, at the Finnish Meteorological Institute in Helsinki, Finland. The Finnish branch of the Ozone Monitoring Instrument (OMI) science team hosted the meeting. More than 100 abstracts were submitted, demonstrating that Aura data continue to be used broadly for atmospheric research related to stratospheric and tropospheric composition and climate. There was a large poster session and a full agenda of plenary science presentations.

This year's presentations covered a broad range of topics based on observations from the four Aura instruments [High-Resolution Dynamics Limb Sounder (HIRDLS), Microwave Limb Sounder (MLS), Ozone Monitoring Instrument (OMI), and Tropospheric Emission Spectrometer (TES)]. The Aura science team has celebrated seven years of observations; ongoing validation of Aura products expands the possible quantitative uses of Aura measurements. Some of the latest achievements include the following:

- Ground-based measurements of nitrogen dioxide (NO₂) and bromine oxide (BrO) columns are contributing to improved understanding of OMI column data, including the effects of variability on smaller spatial scales than OMI's pixels, and quantifying stratospheric contributions.
- New data products have joined the suite of historical Aura measurements, including methyl chloride (CH₃Cl) measurements from MLS, and measurements of ammonia (NH₃), formic acid (HCO₂H), methanol (CH₃OH) and peroxyacetyl nitrate (PAN; C₂H₃O₅N) from TES.
- Atmospheric profiles derived by combining data from TES, OMI, and MLS show promise for obtaining more detailed information about the vertical distribution of ozone (O₃) and carbon monoxide (CO) in the lower atmosphere than can be achieved from any of these sensors separately—including near surface information for tropospheric O₃.
- Skill at correcting for blockage in the HIRDLS field of view has continued to improve. The most recent release of HIRDLS data includes new Level 3 data production, including daily zonal means for daytime and nighttime NO₂, daily zonal means for nighttime dinitrogen pentoxide (N₂O₅), daily grids for stratospheric columns of daytime NO₂, and monthly mean cirrus ice water content (obtained jointly with MLS).

This year's meeting also included several invited presentations concerning air quality, climate, and the unusually long-lasting north polar vortex that led to Antarctic-like ozone depletion during spring 2011.

David Noone [University of Colorado] spoke about a “collision” between Aura data and process models, emphasizing the importance of using observations from Aura instruments along with data from other platforms to understand the hydrological cycle, its representation in models, and reasons for high humidity biases that affect the model's climate sensitivity. Noone showed that the combined measurements produced better results than simply relying on monthly zonal mean “postage stamp” comparisons. This raised issues about the most informative ways to use models in conjunction with observations, and set the stages for some of the meeting's other presentations that discussed stratospheric water and climate, the processes that control the composition of the lowermost stratosphere and upper troposphere (thereby affecting ozone radiative forcing), and effects of aerosols and clouds.

Markku Kumala [University of Helsinki] then discussed estimating global concentrations of aerosol particles from satellite measurements. **Peter van Velthoven** [Koninklijk Nederlands Meteorologisch Instituut (KNMI)—Royal Dutch Meteorological Institute] followed, and spoke about the use of satellite data for air-quality modeling and forecasting in Europe. These two presentations provided context for subsequent presentations that discussed how OMI data are applied to study a variety of phenomena related to air quality. For example, OMI data were used to monitor changes in pollutant emissions in Europe associated with the economic contraction of 2008, to track ship pollution plumes, and to estimate biogenic emissions over Africa.

The final session of the meeting included invited presentations by **Michelle Santee** [NASA/Jet Propulsion Laboratory] and **Markus Rex** [Alfred Wegener Institute for Polar and Marine Research—Germany], discussing aspects of the unusually strong and long-lasting northern polar vortex in 2010, and the ways in which evolution of constituents including nitric acid (HNO₃), hydrochloric acid (HCl), chlorine monoxide (ClO), and O₃ more closely followed the behavior normally observed over the Antarctic than the Arctic—see **Figure 1**. The long record of total O₃ observations shows that strong chemical O₃ loss can occur depending on the temperature and stability of the northern vortex, which is far more variable than the southern vortex. The observed behavior of northern vortices and chemical O₃ loss differs from that produced by general circulation models

with interactive photochemistry (obtained from chemistry–climate models) that are used to project future O_3 levels. This suggests an incomplete representation of processes that control the variability of the northern vortex, and underscores the utility of and need for continued detailed observations of both reactive and long-lived gases, such as are presently being obtained from Aura MLS.

The next Aura science team meeting is being planned for October 1-3, 2012, in Pasadena, CA. Details about that meeting will be posted on the Aura web site as they become available.

Most of the presentations from the meeting can be found at the following URL: avdc.gsfc.nasa.gov/index.php?site=1072744097 ■

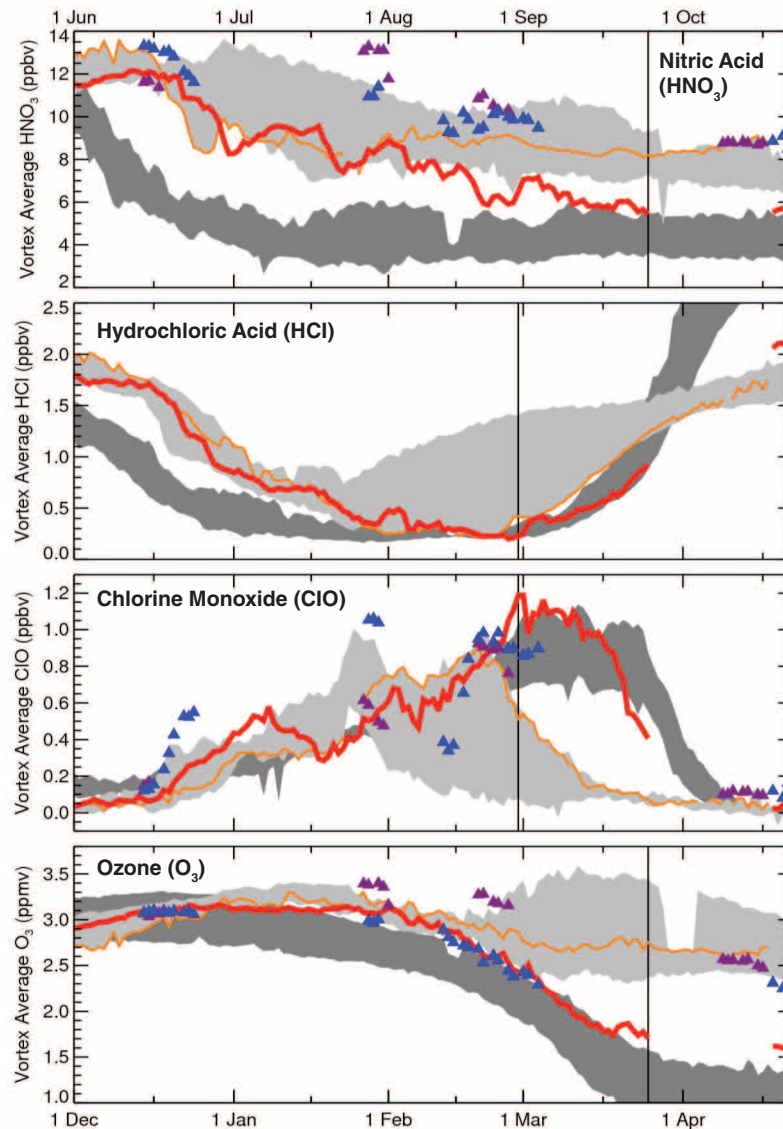

Figure 1: These MLS measurements show the unusual evolution of O_3 , ClO, HCl, and HNO_3 during Arctic spring of 2011.

In all of these panels, the light shaded bands show the range of values from previous Arctic winter/spring as seen by Aura MLS. The dark shaded bands show Antarctic winter/spring (time shifted by six months). The thick lines from Arctic Spring 2011 fall at the edge of the envelope of Antarctic springs. The triangles and the thin line show previous cold northern winters seen by UARS MLS (triangles) and Aura MLS (thin line). There is significant chlorine catalyzed ozone destruction those years but only 2011 appears ‘Antarctic like’ for all four constituents. Results were recently published (Manney, G. M., *et al.*, Unprecedented Arctic ozone loss in 2011, *Nature*, doi:1039/nature10556, 2011).

Ozone Monitoring Instrument Science Team Meeting Summary

Joanna Joiner, NASA's Goddard Space Flight Center, joanna.joiner-1@nasa.gov

Just prior to the Aura Science Team Meeting, the 16th Ozone Monitoring Instrument (OMI) Science Team Meeting took place on September 12, 2011, at the Finnish Meteorological Institute (FMI). OMI is a contribution from the Netherlands and Finland to NASA's Aura mission. The OMI Principal Investigator is **Pieter Levelt** [Koninklijk Nederlands Meteorologisch Instituut (KNMI)]; the science team consists of members from KNMI, FMI, NASA, and several other institutions.

The OMI instrument continues to perform well, with greater than 99% data capture. The instrument status and optical stability are excellent. Seven years after launch, the rate of deterioration of the instrument is still extremely slow, so OMI continues to produce high-quality Level 1 (L1) and L2 data. The instrument has one instrument anomaly, the so-called *row anomaly* that affects about half of OMI's cross-track positions, or rows, and is likely caused by an obstruction external to the instrument. Ground pixels affected by the row anomaly are currently being monitored and flagged in the L1 data and in an increasing number of L2 products. Members of the Dutch and U.S. teams reported on their correction algorithms to compensate for the anomaly in the affected rows. The row-anomaly-corrected data will be useful for hazard monitoring, such as the detection of ash plumes from volcanic eruptions and smoke plumes from large fires—but will not be of sufficient quality for science investigations. Note, however, that the L1 and L2 OMI data from the other viewing directions (i.e., outside the row anomaly) are of optimal quality and can be used productively for science investigations¹. Global coverage from unaffected rows is attained by OMI in two days.

Some of the presentations focused on the status of improvements to and continued evaluation of current L2 products. Most L2 product developers are improving their algorithms. The team expects to reprocess all L2 products in the next six months using the improved algorithms. Of note, NASA team members will release their greatly improved “NextGen” nitrogen dioxide (NO₂) standard product soon. Also, the successful near-real-time Dutch OMI NO₂ (DOMINO) product, available within three hours after measurement and used amongst other applications, for air-quality forecasts, has been further improved—see www.temis.nl for details. The latest versions of the two NO₂ products now agree better with each other than did the previous versions. Several products, including volcanic sulfur dioxide (SO₂) and the absorbing aerosol index, used for aircraft rerouting, were added recently to OMI's Very Fast Delivery service (VFD; omivfd.fmi.fi) that is operated by FMI in Sodankyla, Finland. The VFD service provides data within 15 minutes of overpass for a large area that encompasses much of Europe and extends well eastward.

Other presentations highlighted recent research results from OMI observations, including the monitoring of SO₂ emissions from tar-sands mining in Alberta, Canada, and the correlation between NO₂ and population and economic output in Europe. There was also discussion of the contribution of OMI O₃ data to the analyses of the unusually large Arctic ozone hole that occurred in Spring 2011—see **Figure 1** on page 22—and more closely followed the behavior normally observed over the Antarctic than the Arctic. The OMI research highlights were also presented at the Aura Science Team Meeting, held later in the week.

¹ For more information on the impacts of the row anomaly on OMI data please visit: www.knmi.nl/omi/research/product and disc.sci.gsfc.nasa.gov/Aura/data-holdings/OMI/

The Soil Moisture Active Passive (SMAP) Applications Program and the 2011 SMAP Applications Workshop

Vanessa Escobar, *Sigma Space/NASA's Goddard Space Flight Center, vanessa.m.escobar@nasa.gov*

Molly Brown, *NASA's Goddard Space Flight Center, molly.e.brown@nasa.gov*

Susan Moran, *U.S. Department of Agriculture/ARS Southwest Watershed Research Center, susan.moran@ars.usda.gov*

NASA's Soil Moisture Active Passive (SMAP) Mission will provide global measurements of soil moisture and freeze/thaw state with unprecedented accuracy, resolution, and coverage. Data products from the SMAP Mission have the potential to enable a diverse range of applications including drought and flood guidance, agricultural productivity estimation, weather forecasting, climate prediction, and improving human health and security.

With a target launch date of 2014 the

SMAP mission is implementing a strategy that promotes prelaunch applications research and engages a broad range of users (also known as the *community of practice*) through the SMAP Applications Program. This program is redefining how to engage the community of practice through a variety of prelaunch applications activities and research. A goal for the SMAP Applications Program is to familiarize the community with SMAP capabilities and products, and to promote interest in applications research with SMAP-like products prior to mission launch.

SMAP Early Adopter Program

As a part of the SMAP Applications Plan, the SMAP Early Adopter program supports applications research to provide a fundamental understanding of how SMAP data products can be scaled and integrated into organizations' policy, business, and management activities to improve decision-making efforts. SMAP Early Adopters are defined as those groups and individuals who have a direct or clearly defined need for SMAP-like soil moisture or freeze/thaw data, and who are planning to apply their own resources to demonstrate the utility of SMAP data for their particular system or model. In early 2011 a competitive process was used to select the seven SMAP Early Adopters, who come from Environ-

ment Canada, the European Centre for Medium-Range Weather Forecasts (ECMWF); the National Oceanic and Atmospheric Administration (NOAA); the United Arab Emirates' Masdar Institute of Science and Technology; the U.S. Department of Agriculture (USDA)

National Agriculture Statistics Services (NASS); International Research Institute for Climate and Society (IRI; based at Columbia University in NY); and Agriculture and Agri-Food Canada (AAFC). The SMAP Applications

Team encourages additional proposals, and will select a second round of Early Adopters in February 2012. By facilitating this feedback between SMAP community of practice users and the SMAP Science Definition Team (SDT), the use of post-launch mission data products will be accelerated.

Second SMAP Applications Workshop

On October 12-13, 2011, the SMAP Mission held its second SMAP Applications Workshop at the USDA South Building in Washington, DC, with 120 participants from dozens of agencies, universities, and private companies. The workshop's goal was to engage SMAP thematic users who have applications in water resource management, agriculture, disasters, climate studies, weather prediction, ecosystems forecasting, and public health to improve interactions with the SMAP Mission. The meeting included a welcome from **Ann Mills** [USDA—*Deputy Undersecretary for Natural Resources and Environment*]. She described her enthusiasm for the work of the SMAP Early Adopters, and emphasized the need for continued research related to USDA applications. **Brad Doorn** [NASA Headquarters (HQ)] and **Jared Entin** [HQ], representing the SMAP Mission, introduced the planned SMAP data products and highlighted potential SMAP applications.

"A fundamental challenge for the coming decade is to ensure that established societal needs help to guide scientific priorities more effectively and that emerging scientific knowledge is actively applied to obtain societal benefits."

—National Research Council Decadal Survey Report

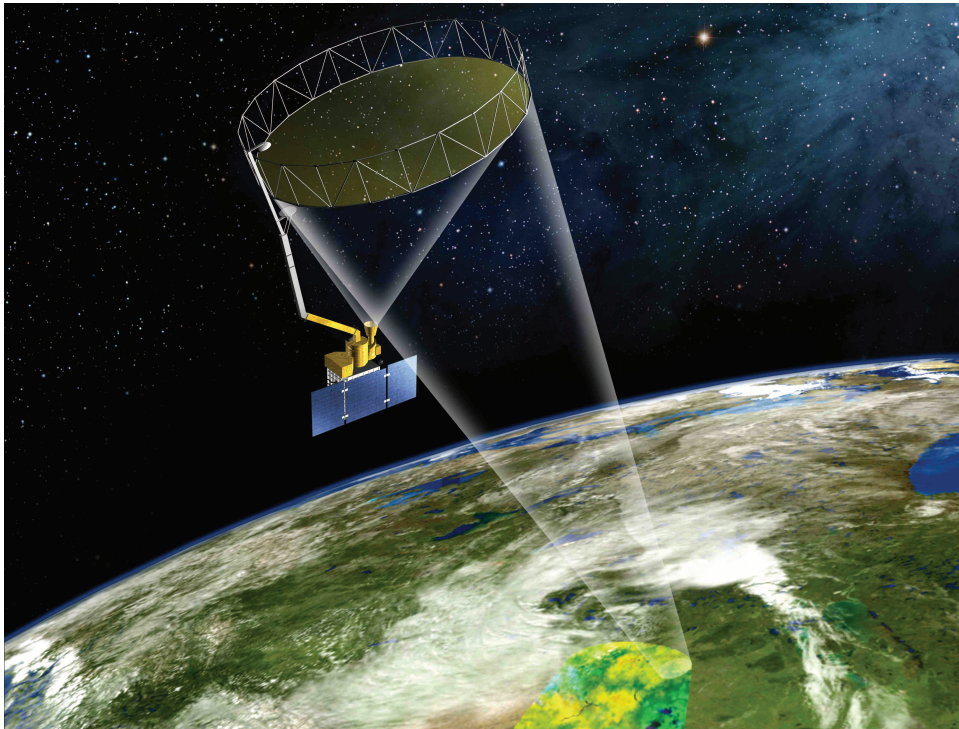

The Soil Moisture Active Passive Satellite (SMAP) set to launch in November 2014, will provide high-resolution, frequent-revisit global mapping of soil moisture and freeze/thaw state to enable applications of national significance that range from agriculture to public health.

The first day of the SMAP Applications Workshop featured presentations on pre-launch research from Early Adopters to enable integrating SMAP data into users' applications. For more information on SMAP applications and how to become a SMAP Early Adopter, please visit: smap.jpl.nasa.gov/applications/.

The workshop also offered a day of breakout sessions and discussions focused on addressing *how* SMAP data could be used in different scientific disciplines, and identifying *what* the technical challenges are for integrating SMAP data into models and processes. A plenary panel comprised of representatives from each thematic area provided an overview of each breakout group's perspectives, which will feed back to the SMAP SDT. The conclusions from the second day included the need to:

- Identify better data accessibility and usability for diverse user communities;
- define data formats and latency that will apply to science and societal communities; and
- increase the focus on freeze/thaw products for next year's applications activities.

A complete report on the 2011 SMAP Applications Workshop will be available soon at smap.jpl.nasa.gov/applications/.

Resources:

SMAP Website
smap.jpl.nasa.gov/

Brown, M.E., Moran, M.S., Escobar, V.M., Entekhabi, D., O'Neill, P.E., Njoku, E.G., Doorn, B., and Entin, J. (2011). Opportunities to Engage with NASA's Soil Moisture Active Passive (SMAP) Mission Applications. *Bulletin of the American Meteorological Society, in review, 2011*

Entekhabi, D.; Njoku, E.G.; O'Neill, P.E.; Kellogg, K.H.; Crow, W.T.; Edelstein, W.N.; Entin, J.K.; Goodman, S.D.; Jackson, T.J.; Johnson, J.; Kimball, J.; Piepmeier, J.R.; Koster, R.D.; Martin, N.; McDonald, K.C.; Moghaddam, M.; Moran, S.; Reichle, R.; Shi, J.C.; Spencer, M.W.; Thurman, S.W.; Leung Tsang; and Van Zyl, J.; "The Soil Moisture Active Passive (SMAP) Mission," *Proceedings of the IEEE*, vol.98, no.5, pp.704-716, May 2010 doi: 10.1109/JPROC.2010.2043918 ieeexplore.ieee.org/stamp/stamp.jsp?tp=&arnumber=5460980&isnumber=5461016 ■

Landsat Science Team Meeting Summary

Thomas Loveland, U.S. Geological Survey Earth Resources Observation and Science Center, loveland@usgs.gov

Thomas Maiersperger, SGT, Inc./USGS Earth Resources Observation and Science Center, tmaiersperger@usgs.gov

James Irons, NASA's Goddard Space Flight Center, james.r.iron@nasa.gov

Curtis Woodcock, Department of Geography and Environment, Boston University, curtis@bu.edu

The Landsat Science Team (LST), sponsored by the U.S. Geological Survey (USGS) and NASA met at the USGS Earth Resources Observation and Science (EROS) Center on August 16-18, 2011. The LST, consisting of 18 scientists and engineers representing academia, private industry, federal agencies, and international organizations, was selected in 2006 to serve a five-year term. Since 2006 the LST has held two meetings per year (winter and summer) that focused on all aspects of the Landsat program, including the upcoming Landsat Data Continuity Mission (LDCM), Landsat 5 and 7 status, the Landsat archive, future Landsat requirements, and synergy with other space-based remote-sensing missions. The EROS meeting marked the tenth and final meeting of the group. All meeting presentations and summaries are available through the USGS EROS LST website at landsat.usgs.gov/science_LST_Team_Meetings.php.

Headquarters Updates

Matt Larsen [USGS—Associate Director for Climate and Land Use] and **Dave Jarrett** [NASA Headquarters (HQ)—Landsat Executive] provided a summary of high-level Landsat activities. Larsen stressed USGS's commitment to Landsat. He commented that the USGS 2011 Landsat appropriation did not include

funds needed to meet the LDCM ground system development schedule, but that USGS and the Department of the Interior met LDCM financial needs through other sources. Ground system funding appears to be solid in 2012. Larsen also talked about USGS support for the president's plans to establish a National Land Imaging Program, and to authorize development of Landsat 9.

Jarrett discussed the upcoming LDCM launch. He said that NASA is moving at "full speed" toward a December 2012 launch. He commented that the recent Operational Land Imager pre-shipment review was quite favorable, and that development for the Thermal Infrared Sensor (TIRS) was progressing well, despite its tight schedule. Jarrett concluded that NASA's Earth Science Division remains committed to Landsat, and is pleased with the advocacy and guidance provided by the LST.

Bruce Quirk [USGS—Land Remote Sensing Program Coordinator] provided additional information on planning for future Landsat missions. The USGS and NASA are meeting regularly to define agreements and plans needed for long-term Landsat collaboration. The current focus is on developing Landsat 9 Level 1 requirements. The LST suggested trade studies to address the daily acquisition rate, extending the TIRS design

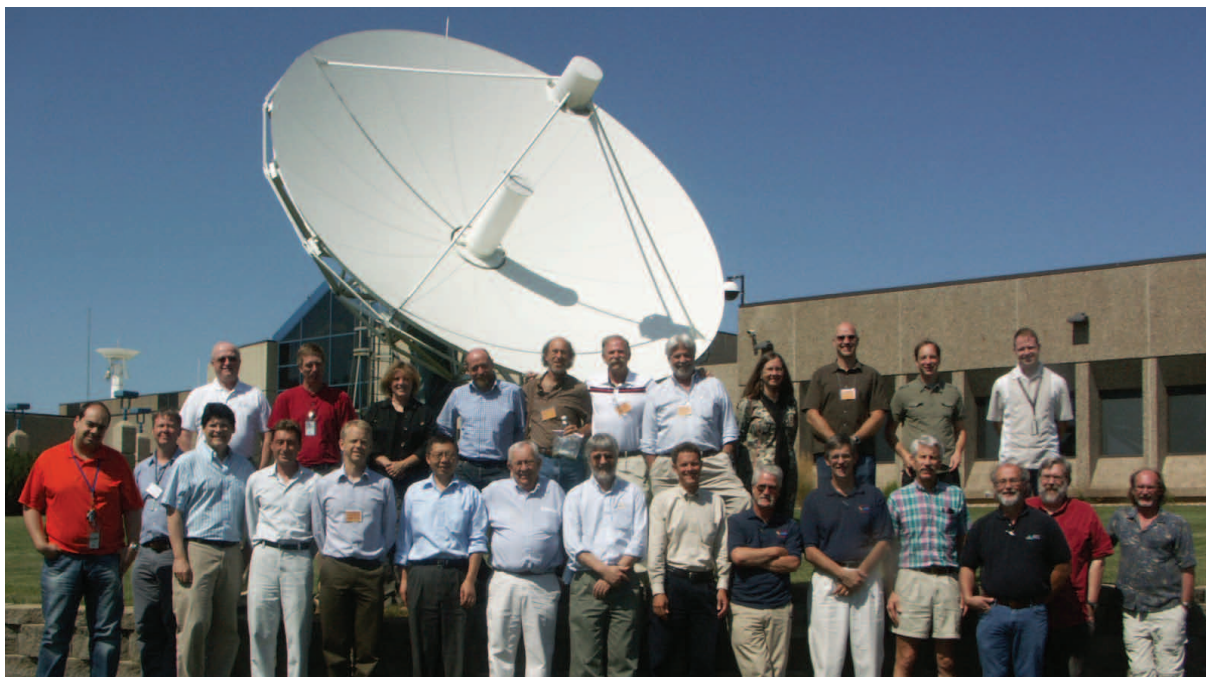

Landsat Science Team Meeting participants.

life from three to five years, and improving the spatial resolution of visible red and near-infrared observations. A goal for Landsat 10 and beyond should be to increase the frequency of observations.

Current Landsat Mission Status

Kristi Kline [USGS—*Landsat Project Manager*] provided an update to the LST on Landsat 5 and 7, and on overall archive and data processing topics. The 27-year-old Landsat 5 mission continues to collect data, but the mission is threatened by the rising traveling wave tube amplifier (TWTA) current. If the current continues to rise the TWTA will likely fail, and Landsat 5 will no longer be able to transmit data to ground stations. The Landsat 5 Flight Operations Team is working on approaches to stabilize the TWTA current, but if the team is not successful the mission will end. **Gene Fosnight** [USGS—*Landsat Data Acquisition Manager*] added to the discussion by describing how the Long-Term Acquisition Plan used for Landsat 7 and planned for LDCM was being implemented for Landsat 5 in order to optimize both acquisitions and provide TWTA management options.

Landsat 7 is now 12 years post-launch. While the 2003 scan-line corrector failure causes the loss of approximately 22% of the data in each Enhanced Thematic Mapper Plus scene, all other systems are functioning well, and high-quality science data are being acquired. Because of the health of Landsat 7, the number of daily acquisitions has been increased to 350 scenes per day.

Regarding Landsat archive activities, Kline reported that demand for Landsat data continues to rise, and that 2011 download rates could exceed 3 million scenes. All new acquisitions are now automatically processed into Level 1 Terrain-corrected product (L1T)¹ or 1G² products³. To improve on-demand processing throughput efficiency, all archived Landsat data are being migrated to online disk storage.

Kline described the recent initiation of Landsat 5 forward stream network delivery directly from Argentina, Brazil, Canada, and China (Kashi) International Cooperator (IC) ground stations, with similar delivery of Landsat 5 data from South African and Australian ICs expected to begin soon. This development is adding significant amounts of new Landsat 5 acquisitions to

the USGS EROS archive. Finally, Kline reported that the Landsat Global Archive Consolidation initiative is progressing, and that over 600,000 historical Landsat scenes held by IC ground stations were recently added to the USGS EROS archive. Acquisition of data from additional stations is planned.

Jeff Masek [NASA's Goddard Space Flight Center (GSFC)—*Landsat Project Scientist*] concluded the current Landsat session with an update on the Global Land Survey (GLS). The GLS provides consistently processed global, cloud-free, orthorectified Landsat datasets centered on 1975, 1990, 2000, 2005, and 2010. Over 200,000 Landsat 5 and 7 scenes acquired between 2009 and 2011 are the basis for the 2010 collection.

Landsat Data Continuity Mission Status

Phil Sabelhaus [NASA HQ—*LDCM Project Manager*] reported that the LDCM spacecraft is in the final stage of development, and that instrument integration is expected to start this fall. At this point, the development of all mission systems and instruments is on schedule. The next major hurdle is the Key Decision Point-D (KDP-D) review, which is set for October 2011.

Sabelhaus reported that the Operational Land Imager (OLI) instrument calibration is complete, and performance is excellent. Functional testing of all environmental, electromagnetic interference (EMI)/electromagnetic compatibility (EMC), vibration, and thermal vacuum systems was successfully completed. The shipment of OLI from Ball Aerospace in Boulder, CO, to Orbital Systems in Gilbert, AZ, was planned for July 20, 2011, but had to be delayed due to a heater circuit anomaly. Plans are still in place to integrate the OLI with the spacecraft this fall. Significant progress has been made on the TIRS, which is being built at GSFC. Environmental testing is planned for this fall, prior to the instrument being shipped to Orbital Systems.

The LDCM data window is December 1-30, 2012, with a launch readiness date of December 1, 2012. A contract is in place with United Launch Alliance for launch services; the spacecraft will be launched on an Atlas V 401 selected by the NASA's Kennedy Space Center. Sabelhaus stressed the need to maintain the December 1, 2012 date at all costs, as the Atlas V manifest is very crowded and the only slot currently open after that at Vandenberg Air Force Base is in October 2013. **Therefore, if a December 2012 launch cannot take place, there is a strong possibility of at least a 10-month delay.** Meeting the December 2012 window is, therefore, of key importance to a timely mission.

¹ Standard Terrain Correction (Level 1T) provides systematic radiometric and geometric accuracy by incorporating ground control points while employing a Digital Elevation Model (DEM) for topographic accuracy.

² Systematic Correction (Level 1G) provides systematic radiometric and geometric accuracy, which is derived from data collected by the sensor and spacecraft.

³ Previously, only images with less than 30% cloud cover were automatically processed.

Jim Nelson [USGS—LDCM Ground System Manager] gave an update on the status of the LDCM ground system. He said that all aspects of the ground system development are on track, and that ground system readiness testing is ongoing. Technical performance results involving spacecraft contact time, data ingest and processing, distribution capacity, and latency are all outperforming margins. The emphasis is now turning to mission data testing, where end-to-end image assessments will be performed using a combination of tests with flight hardware and simulators.

Future Landsat-Related Capabilities

LST members, **Darrel Williams** [Global Science & Technology, Inc.] and **Sam Goward** [University of Maryland, College Park (UMCP)] summarized their *Earth Venture-2* concept for the Terrestrial Ecosystem Dynamics (TerEDyn) Mission. TerEDyn is a Landsat-class mission that is designed to improve the understanding of the current state and dynamics of land photosynthetic capacity. The mission is designed to study vegetation dynamics at 30-m spatial resolution using visible, near-infrared, and shortwave infrared imagery acquired globally every eight days. TerEDyn introduces evolving smallsat technology that will permit the collection of these datasets at a substantially lower cost than current missions.

One of the initiatives of the LST has been the development of priorities and technical strategies to generate additional Landsat science datasets. **Curtis Woodcock** provided a summary of the LST's work over the past two years. The LST has identified radiometric calibration, orthorectification, and cloud detection as foundational elements for all Landsat science products. Surface reflectance and temperature are also high-priority derived products.

Eric Vermote [UMCP] summarized progress toward a surface reflectance product. Vermote concluded that the surface reflectance algorithms used in the Landsat Ecosystem Disturbance Adaptive Processing System (LEDAPS) are mature and can be used to translate Landsat 1 through LDCM data into surface reflectance products. He said that the implementation of LDCM surface reflectance should be done gradually, since the instrument is a new one.

John Schott [Rochester Institute of Technology (RIT)] outlined progress toward a surface temperature product strategy that can be applied across the entire archive. Several approaches are being tested, and the influence of different emissivity inputs is being evaluated. Initial results show mean land-surface temperature differences over diverse regions (e.g., the Sierra Nevadas) of 0.24 ± 0.51 K, with maximum differences of ~ 2 K. Shrublands and barren areas tend to have the largest errors (>1 K).

Landsat Science Team Member Presentations

The majority of the meeting focused on the Landsat engineering, science, and applications accomplishments of the LST members.

Robert Binschadler [GSFC] reflected upon the accomplishments and future of monitoring Earth's ice from Landsat. From early uses of ERTS-1 (a.k.a., Landsat 1) to improve coastal mapping of Antarctica, to the recent completion of the Landsat Image Mosaic of Antarctica (LIMA), Landsat-scale imagery has been of great value for land-ice monitoring and research. Increased radiometric resolution, a larger field of view, and more frequent coverage are improvements that would help make future Landsat instruments more useful for ice monitoring.

John Schott spoke about Landsat's new potential to monitor fresh and coastal waters. The OLI exhibits the potential to be an improved tool for monitoring water quality due to enhanced spectral coverage, lower noise, and improved quantization compared with the Enhanced Thematic Mapper Plus (ETM+) instrument. Two over-water atmospheric correction algorithms have been developed for the OLI instrument, and successfully applied to both synthetic data and Airborne Visible InfraRed Imaging Spectrometer (AVIRIS) data. Significant improvements in OLI over ETM+ for estimating levels of dissolved organic matter, chlorophyll, and suspended materials bode well for a new era of water-quality monitoring from LDCM.

Prasad Thenkabail [USGS] surveyed research gains and gaps after 40 years of hyperspectral remote sensing of vegetation. When compared with broadband data, hyperspectral data can significantly improve vegetation discrimination, increase classification accuracy, enable targeting of specific biophysical properties, and explain greater variability in vegetation models. About 33 narrow bands from 400–2500 nm provide optimal information for vegetation studies. Hyperspectral indices formed from these bands have potential for advanced study of vegetation biochemical and physiological properties.

Dennis Helder [South Dakota State University (SDSU)] described calibration activities for the Landsat archive and LDCM. Calibration for Landsat 4 TM and the Landsat 1–5 MSS sensors has been completed, bringing consistency to the entire archival record. OLI and TIRS will be substantially better than any previous Landsat sensor with respect to radiometric performance. End users were encouraged to examine where Landsat calibration meets needs or falls short in their applications.

Eric Vermote returned to summarize activities on a surface reflectance product for Landsat. The atmospheric correction is consistent with the Moderate-Resolution Imaging Spectroradiometer (MODIS), Advanced Very High Resolution Radiometer (AVHRR), and National Polar-orbiting Operational Environmental Satellite System (NPOESS) Preparatory Project [NPP]'s Visible/Infrared Imager/Radiometer Suite (VIIRS) approaches, ensuring consistent reflectance data across resolutions, based on rigorous radiative transfer models. Several Landsat and MODIS validation studies demonstrated that the surface reflectance algorithm is generic, mature, and intercomparable across multiple sensors.

David Roy [SDSU] gave a Web-enabled Landsat Data (WELD) project update, and offered lessons learned from bulk Landsat data processing. The number of users registering to use WELD *version 1.5* products continues to grow. *Version 2.0* is planned for spring 2012. The new algorithm utilizes advances in atmospheric correction and reflective wavelength radiometric normalization to improve the seamlessness of Landsat 7 surface reflectance composites. The *version 2.0* product will also contain a percent tree, bare ground, vegetation, and water classification. Lessons learned included early and frequent community engagement and the need for continuous quality assessment.

Feng Gao [U.S. Department of Agriculture, Agricultural Research Service (USDA ARS)] spoke about developing consistent time series Landsat data products. Activities since 2006 are summarized as follows:

1. The Automated Registration and Orthorectification Package (AROP) has been used for orthorectification and registration of Landsat (MSS, TM and ETM+), Advanced Spaceborne Thermal Emission and Reflectance Radiometer (ASTER), Advanced Wide Field Sensor (AWiFS), China-Brazil Earth Resources Satellite (CBERS) and Hai Yang (HY-1) data⁴.
2. The Spatial and Temporal Adaptive Reflectance Fusion Model (STARFM) approach has been extended and applied to build and simulate dense Landsat time series for various applications.
3. A normalization approach has been used to combine multiple-sensor data for change detection and phenology detection.
4. A consistent impervious extension mapping approach has been tested and applied to Landsat MSS, TM, ETM+, and CBERS data.

⁴ AWiFS flies on Resourcesat-1, which was launched by the Indian Space Research Organization; HY-1 is a Chinese land imaging instrument.

5. An empirical reference-based approach has been tested to generate compatible Landsat data products from MODIS data products.

Sam Goward examined the role of clouds in moderate-resolution land observations using results from a study in the Western U.S. Using MODIS data, obtaining a clear image using an eight-day rolling window was not always possible, even for generally clear sites. Compositing, however, was always successful using an eight-day rolling window. The number of clear views captured by Landsat TM or ETM+ was highly variable, even for clearer sites. Goward concluded that land observations must be collected daily to circumvent most difficulties with cloud-obscured views.

Lazaros Oreopoulos [GSFC] presented an overview of cloud masking and other research for Landsat and LDCM. The Landsat Long Term Acquisition Plan (LTAP) could be simplified to always acquire data over land, regardless of cloud climatologies and forecasts. Thermal capabilities are important, and should be included in future missions. Cloud masking will never be perfect (i.e., 85–90% accuracy is achievable), but a standard product should be provided. Shadow detection is much harder (especially with automation attempts), and its importance should be emphasized.

Jennifer Dungan [NASA's Ames Research Center] talked about developing biophysical products for Landsat, particularly Leaf Area Index (LAI). The Landsat LAI approach was adapted from the physically based MODIS LAI method. A provisional dataset has been produced for California, with plans to expand to the conterminous U.S. A technical paper has been submitted for peer review, and validation and verification efforts continue.

Martha Anderson [USDA ARS] presented work on daily evapotranspiration (ET) data at Landsat scales using multi sensor data fusion. Thermal remote sensing data were found to have great utility for multi scale ET mapping, drought monitoring, and soil moisture mapping. A Landsat revisit time of eight days or less would improve seasonal ET estimation.

Rick Allen [University of Idaho] described the evolution, successes, and future challenges for operational ET data from Landsat-based energy balance data. Primary accomplishments were advances and refinements in components of the Mapping EvapoTranspiration with high Resolution and Internalized Calibration (METRIC) approach; improved handling of Landsat imagery; and support for TIRS on future Landsat missions. Challenges included dealing with cloudy periods, missing precipitation events between image acquisitions, and fusion of energy balance estimates with gridded weather data during observational gaps. Data fusion with

MODIS and a higher frequency of Landsat observations could mitigate these challenges.

Eileen Helmer [USDA Forest Service (FS)] summarized a variety of mapping efforts in tropical forest habitats. Landsat time-series data were used in combination with other data sources for mapping forest regrowth in Amazonia, forest vertical structure and disturbance in Bahamian forests, tree species distributions and stand variables in Puerto Rico, and tree species associations in Trinidad and Tobago.

Jim Vogelmann [USGS EROS] reflected on recent results using Landsat time-series data to monitor ecological trends. Landsat data have been a foundational element for the Landscape Fire and Resource Management Planning Tools (LANDFIRE) and Monitoring Trends in Burn Severity (MTBS) projects. Several factors have increased the utility of Landsat data for studying larger areas and longer timeframes. These include the switch to a free and open data policy, well-characterized geometry and radiometry, better algorithms for automatic trend detection, and movement towards a standard atmospheric correction.

Randy Wynne [Virginia Polytechnic Institute and State University] spoke about the use of multispectral Landsat data for forest science applications. No-cost Landsat data offer enticing opportunities for basic and applied ecosystem science at detailed spatial scales. Wynne showed examples where Landsat data have been used for mapping, change detection, and phenology studies, including multi sensor data fusion to address challenges in Landsat temporal coverage. He concluded by asserting that managed ecosystems are the norm, and that Landsat has become essential to management for production of both commodities and ecosystem services.

Mike Wulder [Canadian Forest Service] examined Landsat opportunities and directions for large-area land cover and dynamics. Increasingly complex questions require more frequent and spatially exhaustive data. Landsat has promoted consistency and compatibility across national program outcomes. Opportunities abound for building around remote sensing for policy and reporting, especially in terms of continuity, cross-sensor integration, and modeling.

Alan Belward [European Commission Joint Research Centre] summarized contributions to the United Nations Food and Agriculture Organization's (FAO) Forest Resource Assessment 2010 remote sensing survey and beyond. While 39 satellites carrying optical imagers with better than 100-m resolution are currently flying, only one provides free and open access to a global archive:

Landsat. The Landsat GLS and L1T have proven robust, reliable, and immensely valuable. The openness of the U.S. Landsat archive policy and data acquisition program have had profound effects on influencing European Union data policy discussions, enabling internationally mandated forest monitoring and governance programs, and helping build knowledge bases in developing countries.

Warren Cohen [USDA FS] talked about success stories within the FS as the agency continued to embrace Landsat. During the last five years, FS inventory and research units have rapidly gravitated toward Landsat retrievals as a fundamental dataset. The FS is now committed to complimenting traditional plot-based measurements with critical and consistent Landsat-derived forest-change information. Common ingredients for programmatic success include free Landsat data, a vision for monitoring, and strong partnerships between scientific research and large-scale production efforts.

Robert Kennedy [Oregon State University] described new insights into terrestrial processes as facilitated by the open Landsat archive. Researchers can now follow the life history of pixels and objects, and match change over time to drivers, follow long-term trends, and better describe conditions now knowing what went before. Landsat data have given rise independently to similar use strategies—for example, the use of many images in time series to exploit maximum information content. Numerous opportunities exist to improve information extraction, attribution, and integration in the areas of disturbance, land cover, and trends.

Curtis Woodcock concluded the science presentations with a discourse on the prospects of continuous monitoring of the land surface using all available Landsat imagery. Topics of study over the years have included cloud and shadow screening, continuous monitoring of forest change using Landsat, and MODIS/Landsat fusion for near-real-time change detection. Woodcock concluded that the utility of new observations can be improved by leveraging the geographic and temporal context of previous observations; all available Landsat measurements may be used constructively; and after 40 years, new and improved uses of Landsat continue to emerge—primarily as a result of improved access to the data.

Next Steps

The five-year term for the LST ended in September 2011. The USGS is now working toward the competitive selection of a new LST that will serve for another five years. The new LST will be convened in early 2012.



Looking Back at the Landsat Science Team's Five-Year Mission

Tom Loveland [USGS—*LST Co-chair*] opened the meeting with a review of the contributions and impacts the LST has had on Landsat, USGS, and NASA. While the LST made many noteworthy contributions that advanced LDCM and the Landsat program, Loveland focused on five major impacts:

- *Web-Enabled Landsat Data*: The LST strongly supported the decision to distribute Landsat data for free. This was the single most profound Landsat-related event that occurred during the LST's tenure. The LST advocated this in the first year, and supported all aspects of USGS efforts to open the Landsat archive.
- *LDCM Thermal Infrared Sensor (TIRS)*: The LST's proactive advocacy contributed to NASA's decision to restore LDCM thermal imaging capabilities. The LST consistently stressed that "...failing to continue the 28-year history of Landsat-scale thermal surveillance will have negative consequences in terms of safeguarding the future economy, environment, health, and natural resources of the U.S. and our ability to address water supply crises abroad."
- *Landsat Global Archive Consolidation*: The LST initially suggested making repatriation and consolidation of international Landsat holdings a priority, and called on the USGS to "...bring copies of foreign holdings into the U.S. archive. The sooner work begins on this front the better, as delays will result in more images being lost." The LST's continued encouragement and input on priorities resulted in a major expansion of Landsat archive holdings.
- *Supporting the National Land Imaging (NLI) Program and Future Landsats*: The LST collectively and individually advocated for NLI and an operational Landsat program throughout their term, and contributed to the development of mission concepts for Landsats 9 and 10.
- *Research and Development*: The LST's science, applications, and engineering accomplishments had significant impacts on Landsat, remote sensing, and environmental science. Through more than 400 peer-reviewed scientific publications, the team reported on a wide array of research topics, including approaches for using large volumes of Landsat data for long-term and broad-area studies. The LST established the foundation for generating higher-level Landsat science products.

In addition, the LST was frequently called on to evaluate specific issues facing the Landsat program. For example, they addressed issues such as Landsat pixel dimension standards; Landsat program priorities for release of Web-enabled Landsat data; recovery of old Multispectral Scanner System (MSS) data; LDCM requirements, including provision of Level 0R products; and launch delay impacts. **In almost every case, the relevance and clarity of the LST's input resulted in USGS and NASA accepting and following the LST's recommendations.**

Loveland concluded that the USGS-NASA LST has had a tremendous impact on the Landsat program over the past five years, playing an instrumental role as a catalyst for major advances in data quality and quantity, and in the science and applications of Landsat data. The members of the LST provided relevant and practical input that demonstrated their clear commitment to the needs of the diverse Landsat science and applications user communities, and a clear understanding of the operational challenges facing USGS, NASA, and Landsat.

On behalf of the LST, **Curtis Woodcock** [Boston University—*LST Leader*] thanked USGS and NASA for seeking and considering their input. He suggested that the LST's strength has been its focus on the entire Landsat program, rather than on individual agencies, projects, and missions.

CERES Science Team Meeting

Jim Closs, Science Systems and Applications, Inc./NASA's Langley Research Center, james.w.closs@nasa.gov

The Fall 2011 Clouds and the Earth's Radiant Energy System (CERES) science team meeting was held on October 4-6, 2011, at the Lawrence Livermore National Laboratory (LLNL) in Livermore, CA. **Steve Klein** [LLNL], and **Norman Loeb** [NASA's Langley Research Center (LaRC)—*CERES Principal Investigator*] conducted the meeting.

Major objectives of the meeting included providing review and status of CERES instruments and data products, CERES-specific science reports, and invited presentations. The meeting's goal was to enhance the ties between the climate modeling/diagnostic and observational communities.

In addition to CERES-specific science reports presented by science team members, **Peter Gleckler**, **Steve Klein**, and **Ben Santer** [LLNL], as well as **Veerabhadran Ramanathan** [Scripps Institute of Oceanography] gave invited presentations.

Norman Loeb presented an overview and status of NASA, CERES, the Earth Observing System (EOS), 2011 Earth Science Senior Review, the NASA-Program for Climate Model Diagnosis and Intercomparison (PCMDI) effort, the National Polar-orbiting Operational Environmental Satellite System (NPOESS) Preparatory Project [NPP], and the Joint Polar Satellite System (JPSS). He summarized the CERES project structure and data products, and discussed plans for CERES on NPP and JPSS. In addition, he reviewed the CERES organization and working group leads, and gave an update on CERES funding status resulting from recent NASA Senior Review. Loeb also discussed some science highlights involving CERES that have received extensive media coverage recently.

Peter Gleckler gave a presentation on climate modeling research in the era of Model Intercomparison Projects (MIPs) and PCMDI. He explained the LLNL/PCMDI's dual mission in climate research, and how this work enables and facilitates research performed by others in the Earth science community. Gleckler presented a history of MIPs, and pointed out that nearly all of the new, model-based conclusions in the Intergovernmental Panel on Climate Change (IPCC) Fourth Assessment Report (AR4) rely upon analyses of the third Coupled Model Intercomparison Project (CMIP3). He described the ongoing CMIP5, explaining climate model performance metrics, and concluded with a summary describing the expanding use of NASA products for climate model evaluation.

The next series of presentations provided updates on various CERES subsystem activities.

- **Kory Priestley** [LaRC] gave an instrument status report for CERES flight models (FM)1-FM6;
- **Patrick Minnis** [LaRC] reported the first results from CERES Edition 4 cloud algorithms;
- **Wenyng Su** [Science Systems and Application Incorporated (SSAI)/LaRC] reported on improved CERES angular distribution models;
- **Dave Kratz** [LaRC] gave a report on the Surface-only Flux Algorithm;
- **Seiji Kato** [LaRC] provided an update on the Surface and Atmosphere Radiation Budget working group;
- **David Doelling** [LaRC] gave an update on CERES Time-space Averaging;
- **Jonathan Gleason** [LaRC] reported on the activities of the CERES Data Management Team;
- **Sue Sorlie** [SSAI/LaRC] gave an update on the Atmospheric Science Data Center; and
- **Sarah Crecelius** [SSAI/LaRC] made a presentation on behalf of **Lin Chambers** [LaRC] on CERES education and outreach activities.

Day two began with working-group break-out sessions, led by Su, on Angular Modeling; Kato, on Surface to Top-of-Atmosphere (TOA) Fluxes; and Minnis, on Clouds.

After the breakouts, came a series of invited presentations highlighting exciting new science, as described below.

Steve Klein gave the first presentation, titled *Using Satellite Simulators to Diagnose Clouds in Climate Models*. Klein described what a satellite simulator is and why is it needed, the Cloud Feedback Model Intercomparison Project Observation Simulator Package (COSIP) and its status, what is now possible with simulators, and some examples of science enabled by simulators. He concluded with a summary of and future plans for climate simulators.

Ben Santer's presentation addressed *Muted Troposphere Warming After 1998: 'Evidence of Absence' of a Human Effect on Global Climate Change*. He pointed out that a climate simulation in a world facing "business as usual" increases in greenhouse gases still shows many periods of cool fluctuations. Santer contends that the fundamental issue is one of signal-to-noise ratios, and that ten-year trends are strongly influenced by interannual noise. He concluded that lower tropospheric temperature records must be at least 17 years long in order to discriminate between internal climate "noise" and the "signal" of human-caused changes in atmospheric composition.

Veerabhadran Ramanathan gave a presentation titled *Resolution of Outstanding Issues in Climate Research*

with Earth Radiation Budget Data: Past and Future. He outlined the history of his climate change research and the radiation budget sensor systems he has worked with. Later, Ramanathan addressed cloud-radiative forcings, the greenhouse effect, and atmospheric solar absorption. He concluded with some outstanding issues that can be looked at using CERES data, including the water vapor continuum/feedback, the spatial structure of clouds, and planetary albedo.

Following the invited presentations, there were a series of co-investigator reports with updates on new data products and science results. The topics discussed are summarized in the table below.

Table. Summary of Poster Presentations.

Topic	Speaker	Institution
Heating of Earth's Climate System Continues Despite Slowing of Surface Warming in Past Decade	Norman Loeb	Langley Research Center (LaRC)
Model Evaluation of Ice/Liquid Water Content, Radiation and Energy Budget for 20 th Century IPCC AR4 and AR5 Simulations	Jui-Lin Li	Jet Propulsion Laboratory
Evaluation of NASA Goddard Institute for Space Science AR5 Simulated Global Clouds and TOA Radiation Budgets Using CERES-Moderate Resolution Imaging Spectroradiometer (MODIS) Observations	Xiquan Dong	University of North Dakota
Representation of Cloud and TOA Radiative Flux Diurnal Cycles in the Canadian Centre for Climate Modeling and Analysis Canadian Atmospheric Model version 4 (CanAM4)	Patrick Taylor	LaRC
Preliminary Comparisons of TOA Radiation Budget between CERES Observations and Modern Era Retrospective-Analysis For Research and Applications (MERRA) Reanalysis Data	Takmeng Wong	LaRC
A Method for Comparing Annual and Seasonal Cycles of TOA Fluxes: A Test Case Using CERES Energy Balanced and Filled (EBAF) and the GSFC Goddard Earth Observing System Model, Version 5 (GEOS-5)	Jerry Potter	Goddard Space Flight Center (GSFC)
Is the Hemispheric Symmetry of Planetary Albedo a Coincidence?	A. Voigt	Max-Planck-Institut für Meteorologie
Variations of Radiation Fields with Environmental Conditions Observed by 10 Years of CERES Observations	Bing Lin	LaRC
The Observed Sensitivity of High Clouds to Mean Surface Temperature Anomalies in the Tropics	Mark Zelinka	Lawrence Livermore National Laboratory (LLNL)
Using TOA Fluxes by Cloud Type to Evaluate the CanAM4	Jason Cole	Canadian Centre for Climate Modeling and Analysis
Time-Invariance of Low-Cloud Albedo Feedbacks in CMIP3	Neil Gordon	LLNL

Topic	Speaker	Institution
High-Resolution Multiscale Modeling Framework Simulation of Low Clouds	Kuan-Man Xu	LaRC
The Effect of Sastrugi on TOA Albedos from CERES	Joseph Corbett	SSAI/LaRC
Scanner for Radiation Budget (SCARAB) on the Megha-Tropiques Mission Status	Patrick Raberanto	Centre Nationale d'Études Spatiales
Geostationary Earth Radiation Budget (GERB) Satellite Application Facility on Climate Modeling (CMSAF) Status Report	Stign Nevens	Royal Meteorological Institute of Belgium
Ageing Models for Meteosat First Generation Visible Band and the Normalization to Meteosat-7	Ilse Decoster	Royal Meteorological Institute of Belgium
A Strategy for Comparison CERES Sensors on Aqua (FM3) and NPP (FM5)	Peter Szewczyk	SSAI/LaRC
Surface Longwave Radiative Fluxes Comparisons Between Surface Radiative Budget and the Cloud-Aerosol Lidar and Infrared Pathfinder Satellite Observations (CALIPSO)-CloudSat-CERES-MODIS (CCCM or C3M) During 2006-2007	A. Vuidez-Mora	LaRC

Loeb led a final discussion that included a review of action items that arose during the meeting, highlights of which included:

- NPP instrument characterization;
- CERES *Edition 4* and EBAF surface delivery;
- performing Visible/Infrared Imager/Radiometer Suite (VIIRS) calibration and generating look-up tables;
- activities of angular modeling, surface only, and surface-to-TOA working groups; and
- CERES Data Management Team data flow and processing.

Full presentations are available on the CERES website at science.larc.nasa.gov/ceres. The next CERES science team meeting will be held on May 1-3, 2012, at the Oyster Point City Center Marriott hotel in Newport News, VA. ■

SORCE Science Team Meeting Summary

Greg Kopp, Laboratory for Atmospheric and Space Physics, University of Colorado, greg.kopp@lasp.colorado.edu

Judith Lean, Naval Research Laboratory, Washington, DC, judith.lean@nrl.navy.mil

Tom Woods, Laboratory for Atmospheric and Space Physics, University of Colorado, tom.woods@lasp.colorado.edu

Vanessa George, Laboratory for Atmospheric and Space Physics, University of Colorado, vanessa.george@lasp.colorado.edu

The ninth Solar Radiation and Climate Experiment (SORCE) Science Team Meeting, to address *Decadal Cycles in the Sun, Sun-like Stars, and Earth's Climate System*, took place September 13-16, 2011, in Sedona, AZ. The meeting was well attended, with 74 scientists participating, and covered a wide range of Solar and Earth science research activities, with enthusiastic discussions that were in harmony with the natural energy vortices of the area.

A summary of the meeting, including PDF versions of the presentations, is available at lasp.colorado.edu/sorce/news/2011ScienceMeeting/index.html.

Meeting Overview

The 2011 NASA SORCE Science Team Meeting was jointly sponsored for the first time, by the newly established Sun Climate Research Center (SCRC), a collaborative effort between NASA's Goddard Space Flight Center (GSFC), and the University of Colorado (CU)'s Laboratory for Atmospheric and Space Physics (LASP). Since its launch in 2003 SORCE has been measuring total solar irradiance (TSI) and solar spectral irradiance (SSI), which are among NASA's Earth Observing System's 24 key observables. Using these measurements, SORCE and SCRC scientists share a common goal in their desire to understand solar variability and the Sun's influence on climate and global change.

The specific objective of this meeting was to gain a deeper understanding of solar cycle variations, Sun-like star variability, solar influences on climate change, and decadal climate variations. The meeting was especially timely, as the science community anticipates that the upcoming solar cycle will likely differ significantly from the past three cycles.

Welcome and Introduction

Tom Woods [LASP—SORCE Principal Investigator (PI)] kicked off this year's meeting by welcoming everyone, and then presenting an overview of the SORCE mission and its observations of the TSI and SSI. The SORCE mission has long passed its five-year mission goal, and was once again extended for another two years after the 2011 NASA Earth Science Senior Review (ESSR) process. While the instruments continue to operate extremely well, the health of the spacecraft battery and reaction wheels used for attitude control are a concern that could possibly limit the SORCE mission lifetime.



Key science questions addressed during the meeting included the following:

1. What can we learn about decadal climate response and climate sensitivity, using the solar cycle as a well-specified external radiative forcing?
2. What is the current understanding of the amplitude of solar spectral variability and the response of the Earth's atmosphere and climate system?
3. How does TSI vary over the solar cycle, and what are the implications for climate modeling to recent refinements in its magnitude?
4. How do comparisons with Sun-like stars improve our understanding of solar variability?
5. How can solar and climate models be advanced to better reproduce decadal variability and improve forecast capabilities?

Since this meeting was jointly sponsored with the newly formed SCRC, **Robert Cahalan** [GSFC—SCRC Co-director] presented an SCRC overview. The planned collaborations involve addressing the issues concerning climate change modeling, Earth's energy balance, solar influence on climate change, and calibration of TSI and SSI observations from SORCE and other missions.

Ramesh Kakar [NASA Headquarters (HQ)] presented an overview of the NASA Earth Science Division's programs, with emphasis on their missions. He shared the good news from the 2011 ESSR that all of the older missions are being extended. New Earth science missions currently in development include the National Polar-orbiting Operational Environmental Satellite System (NPOESS) Preparatory Project [NPP]; Landsat Data Continuity Mission (LDCM); Ice, Cloud, and land Elevation Satellite (ICESat-2); Soil Moisture Active-Passive (SMAP); Global Precipitation Measurement (GPM); Orbiting Carbon Observatory (OCO-2); and an opportunity for a flight of the Total Solar Irradiance Sensor (TSIS).

Session 1: Solar Irradiance Cycles

The meeting's first session began with several speakers discussing measurements of solar irradiances and their application to climate models. **Figure 1** displays calibrated TSI measurements from a variety of past and present instruments as well as the a plot of *sunspot number*, which ebbs and flows with the solar cycle and is an indicator of solar activity, as described elsewhere in this section.

Yvonne Unruh [Imperial College—London] started the session with a keynote talk on the Spectral And Total Irradiance REconstructions (SATIRE) four-component solar model, showing good fits of that model to TSI. SATIRE agrees well with the *SORCE/Spectral Irradiance Monitor* (SIM) over short solar-rotation time scales, but the model does not show that the SIM's reported visible irradiances are out of phase with the solar cycle, nor the large magnitude of the ultraviolet (UV) trend during the declining phase of Solar Cycle 23 that SIM reports.

Matt DeLand [GSFC/Science Systems and Applications, Inc. (SSAI)] followed with a talk on similar solar UV variability measurements, discussing their influences on Earth's atmospheric absorption. DeLand stated that the SIM UV decrease with the solar cycle is larger than that shown by other data or models, and pointed out that such a decrease—if real—would have a significant impact on Earth's ozone throughout the solar cycle. He also indicated that the *SORCE SOLAR STellar Irradiance Comparison Experiment* (SOLSTICE) UV decreases are larger than those from the *Upper Atmosphere Research Satellite* (UARS)/*Solar Ultraviolet Spectral Irradiance Monitor* (SUSIM) or the *Naval Research Laboratory* (NRL)'s solar model, concluding that *SORCE* UV irra-

diance data should be validated against external measurements before extensive use in climate models.

Jerry Harder [LASP] addressed the state of the *SORCE/SIM* degradation corrections and SIM's results for solar-cycle variations. He and Juan Fontenla also model the solar spectral irradiance (SSI) using seven solar-activity indices derived from solar images. Harder also presented some results from working with atmospheric modelers to estimate the effects the SSI has on Earth's atmosphere.

Greg Kopp [LASP] analyzed the current status of the TSI climate data record, deriving the climate-

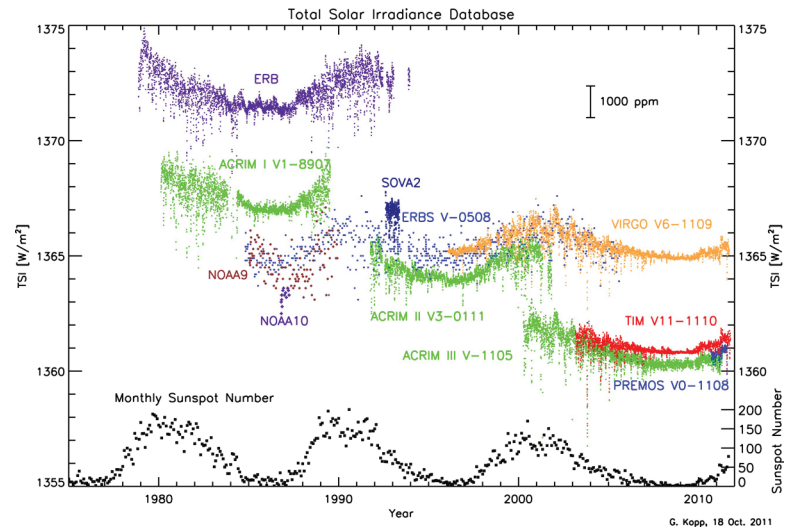

Figure 1: Recent calibration efforts by the Active Cavity Radiometer Irradiance Monitor (ACRIM), PREcision Monitoring Sensor (PREMOS), and Total Irradiance Monitor (TIM) teams have improved understanding of the offsets between Total Solar Irradiance (TSI) instruments. After corrections that are largely due to internal instrument scatter, the latest on-orbit TSI values agree well, **Dick Willson** (ACRIM3), **Werner Schmutz** (PREMOS), and **Greg Kopp** (TIM), all discussed these calibration efforts during **Session I**.

driving requirements for TSI accuracy and stability. He described LASP's TSI Radiometer Facility (TRF), a ground-based calibration facility intended to help achieve needed instrument accuracy levels. The diagnostic capabilities at this facility for testing TSI instruments have helped explain the causes of on-orbit instrument differences, and has resulted in improved agreement. Kopp evaluated the residual stabilities and noise levels in the current TSI instrument measurements.

Richard "Dick" Willson [Coronado, CA—*Active Cavity Radiometer Irradiance Monitor (ACRIM) PI*] discussed the recent improvements to his ACRIM3 TSI data. Ground-based instrument diagnostics with the TRF indicate instrument scatter as the primary cause of the difference in measurements between the ACRIM3 and the *SORCE/Total Irradiance Monitor* (TIM). He has applied corrections for both scatter and a thermal effect that previously caused an annual cycle in the data, making the latest ACRIM3 data much more stable and

consistent to <0.05% with the TIM on an absolute scale. Willson has updated his TSI composite to match these new ACRIM3 data.

Erik Richard [LASP] discussed the SSI requirements for the Joint Polar Satellite System (JPSS)/Total Solar Irradiance Sensor (TSIS), which is comprised of the Total Irradiance Monitor (TIM) and the Spectral Irradiance Monitor (SIM). He noted that improvements being made to this instrument will provide a nearly tenfold increase in accuracy and stability over the current SORCE/SIM performance. Richard's team is using National Institute of Standards and Technology (NIST)'s Spectral Irradiance and Radiance Responsivity

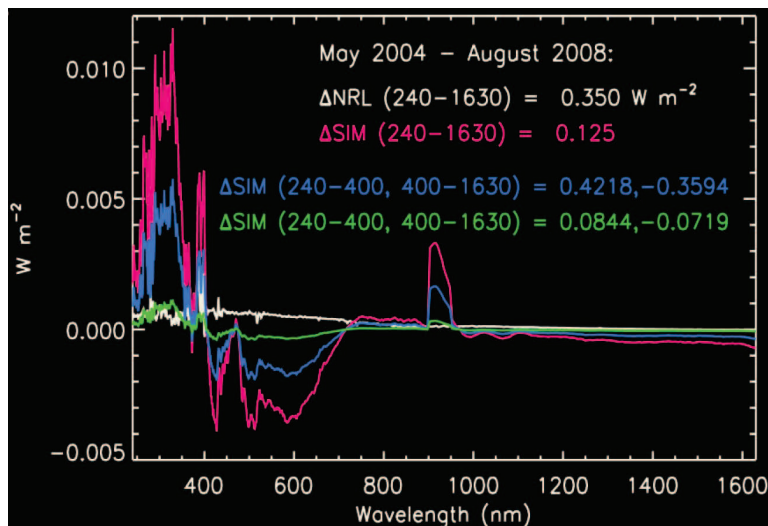

Figure 2: Several speakers addressed differences between the SIM spectral irradiances and UV measurements or solar models. **Judith Lean** discussed the expected impacts of the SIM-reported irradiances—if correct—on climate and atmospheric temperatures, and showed large differences between the SIM data and the NRL solar model from times of an active to quiet Sun.

Calibrations using Uniform Sources (SIRCUS) to help achieve the needed spectral irradiance calibrations.

Werner Schmutz [Physikalisch-Meteorologisches Observatorium Davos (PMOD)—Switzerland] showed the first results from the PREcision MONitoring Sensor (PREMOS) instrument's orbit TSI measurements. Launched in June 2010, PREMOS is the first radiometer in space with calibrations traceable to both the National Physical Laboratory (NPL) and the TRF, and, like the recent ACRIM data, shows good agreement with the SORCE/TIM TSI values. Schmutz reported that the World Radiometric Reference (WRR) gives values that are high when compared to their recent calibrations at these international facilities. A TSI composite based on his group's latest calibrations shows no trend between the last two solar minima.

Steven Dewitte [Royal Meteorological Institute of Belgium (RMIB)] presented the first results of the Solar VARIability Experiment (SOVA) TSI instrument

on the PICARD satellite¹. After some delay caused by a problem with a closed shutter on one of the two instrument channels, they did manage to open the shutter permanently. Dewitte pointed out that a benefit of this unintended operational mode allows measurements of solar *p-modes*. His TSI composite, similar to the results described above, shows no significant trend between the last two solar minima. Dewitte's group is still working on the absolute value of the SOVA TSI measurements, which are currently scaled to the Variability of solar Irradiance and Gravity Oscillations (VIRGO) TSI instrument on the SOLar and Heliospheric Observatory (SOHO) spacecraft.

Claus Fröhlich [PMOD] described the VIRGO-based TSI composite, which indicates a 25% decrease in solar cycle amplitude between the last two solar minima. He extrapolates a four-component solar model that explains 85% of the TSI variability observed from 1978 to present. He is using proxy measurements of solar activity based on the 10.7-cm solar radio flux at (F10.7), magnesium II core-to-wing ratio (Mg II), and calcium-K (CaK) emission to create an historical TSI record that extends back to 1913.

Judith Lean [NRL] addressed a fundamental question brought up by many of the session's speakers, that of tackling whether solar irradiance decadal trends are real or due to instrument instability—see **Figure 2**. She believes that no long-term (i.e., greater than one solar cycle) trend has been definitively measured in TSI. Using her NRL solar model, Lean finds results similar to those Yvonne Unruh described (see above) when comparing to reported SORCE/SIM SSI data. Specifically, she finds good agreement over solar rotational time scales, but does not interpret the long-term SIM results as showing the visible portion of the spectrum varying out of phase with TSI over the solar cycle.

Thierry Dudok de Wit [Centre National de la Recherche Scientifique (CNRS)—France] discussed coherency techniques and blind-source separation. He uses independent-component analysis applied to solar irradiances to help determine good solar proxies for SSI, favoring the Mg II and Lyman-Alpha (Ly- α) lines, and TSI. Even with these, Dudok de Wit finds no good proxies for observations in the 250–400 nm spectral region.

¹ PICARD is named after the 17th century French astronomer who made the first accurate measurements of the Sun's diameter.

Dora Preminger [San Fernando Observatory (SFO), California State University] studied 22 years of SFO images and resulting photometric sums to model solar variability. She reported that their *red and blue sums* give good short-term variability, while CaK provides a long-term proxy. The SFO model has a multiple regression correlation coefficient (R) as high as 0.95 when fitted to SORCE/TIM TSI measurements.

Matthieu Kretzschmar [RMIB and CNRS] shared the January 2010 *first light* results from PProject for OnBoard Autonomy (PROBA2)/Lyman Alpha Radiometer (LYRA), which acquires SSI measurements at Ly- α wavelengths, as well as at 200–220 nm, 17–80 nm, and 6–20 nm. He observes rapid oscillations during the impulsive phase of flares at these wavelengths. Kretzschmar reported that the instrument is degrading quickly (50% in the first month in the Ly- α) due to contamination on the filters.

Jeff Morrill [NRL] compared a Mg II and CaK proxy-based solar model developed by comparing SUSIM data to SORCE data, and assessing long- and short-term variability. He finds good agreement between the SUSIM data and the NRL solar model (see the summary of Judith Lean's presentation, above), but poorer agreement to the SORCE/SIM for long-term variability.

Gary Rottman [LASP—*Original SORCE PI*], concluded the first session, reviewing the solar variability measured by the Solar Mesosphere Explorer (SME) during its 1981–1989 mission. In his retirement, he is working on improving the reference spectrum from this small, inexpensive CU mission.

Session 2: Climate System Decadal Variability

Decadal fluctuations are well-recognized components of climate system variability, but the contribution of the Sun's decadal (11-year) cycle to this variability historically has been dismissed. Based on climate model simulations, responses to the decadal solar cycle are generally assumed to be too small and too slow to be detectable from inherent climate system “noise.”

However, **Vikram Mehta** [Center for Research on the Changing Earth System (CRCES)] summarized hundreds of years of research that have uncovered multiple climate parameters—including temperature, rainfall, and internal oscillation patterns—apparently related to solar variability on decadal time scales (in the 8–25 year range). Until recently (the past few decades), most studies correlated climate parameters with sunspot numbers; although correlation coefficients are typically small ($R=0.3$), and the correlations apparent during some epochs but not others, Mehta suggested that the sheer number of results indicating a solar influence on

decadal climate point to a real effect. The two primary concepts for Sun-generated climate drivers are the solar *bottom-up* (surface heating) and *top-down* (solar UV heating in the stratosphere), each with different characteristic signatures.

Alexander Ruzmaikin [NASA/Jet Propulsion Laboratory (JPL)] then showed how the nonlinear, noisy atmosphere-ocean system naturally generates spatial patterns that appear to alter external forcings on climate. While some previous research indicates that high solar activity produces a La Niña-like response in the tropical Pacific Ocean, other research suggests the opposite—that is, the response is more El Niño-like. He separated the 11-year solar cycle epoch into a four-year rise and seven-year fall for the El Niño–Southern Oscillation (ENSO) data from 1871–2010. The result was a clear relationship in the declining phase of the solar cycle, but no clear relationship for the rise phase. Physical causes were identified as changes in Hadley Circulation caused by both bottom-up and top-down solar influences.

For proper specification of decadal climate variability a reliable observational database is crucial. Since solar influences persist throughout the Earth's atmosphere, the database must extend from the surface to above ~62.1 mi (100 km), so that it can properly identify and separate the bottom-up and top-down mechanisms. **John McCormack** [NRL] described a new emerging capability for future Sun-climate research based on the Navy Operational Global Atmospheric Prediction System (NOGAPS)–Advanced Level Physics and High Altitude (ALPHA) model that provides a robust framework for assimilating data from 0–62.1 mi (0–100 km). He showed that, in particular, wind, temperature, and constituent analyses from NOGAPS-ALPHA can provide important diagnostics to describe middle-atmospheric circulation to help quantify response pathways to solar decadal forcing.

Mark Serreze [National Snow and Ice Data Center (NSIDC), Cooperative Institute for Research in Environmental Sciences (CIRES), CU] summarized the observational evidence that Arctic sea ice is decreasing faster than climate models forecast (with September minima), and indicated that global warming and albedo change are key causes of this decrease—see **Figure 3**. However, the reasons have not yet been properly identified. Complicating understanding is the fact that water in the Arctic is stratified more by salinity than by temperature. There are many “wild cards” in understanding why Arctic sea ice is changing, including black carbon aerosols, changes in spring cloudiness, Atlantic inflow pulses, and atmospheric circulation patterns (e.g., stronger warm southern winds, and warmer autumns). There are many feedbacks and interrelated processes, and there is no clear solar-related decadal variation.

Changing sea ice extent is expected to affect climate circulation patterns.

Stergios Misios [Max-Planck-Institute for Meteorology—Germany] returned the meeting focus to lower latitudes. He first noted that the detection of a solar-related topical signature is difficult because of the strong ENSO pattern, leading to different conclusions. By combining ensemble runs using the ECHAM5^{2/} Max-Planck-Institute Ocean Model (MPIOM) and analysis of data, Misios reported evidence

that ENSO hides a basin-wide solar-related warming/cooling that is strongest in the Pacific Ocean, with the temperature signal enhanced by a dynamical response of the ocean. Weakening of the Walker Circulation surface easterlies and the eastward displacement are also apparent, and simulated independently of the ocean coupling.

Following the mid-morning break, attendees heard a keynote presentation by **Karin Labitzke** [Freie Universität Berlin—Germany] based on her groundbreaking work over many decades, identifying the role of the Quasi-Biennial Oscillation (QBO) in modulating the Earth's atmospheric response to solar variability. During Northern Hemisphere summer and the east QBO phase there is a strong correlation of atmospheric temperature with the solar cycle. During Northern Hemisphere winter and the west QBO phase there is a medium-strength correlation of temperature and the solar cycle—see **Figure 4**.

Decadal climate variability is known to be associated with the North Atlantic Oscillation (NAO)—the Atlantic expression of the Northern Annular Mode (NAM). Positive NAO causes warmer and wetter winters in Northern Europe; negative NAO causes colder winters and more snow for the Eastern U.S. **Hua Lu** [British Antarctic Survey—U.K.] is investigating a possible association of the NAO with geomagnetic activity. A positive NAO-like pattern is associated with high geomagnetic activity (represented by the *aa* index),

with stronger correlation during even solar cycles and declining phases. It was noted that the significant positive *aa*-NAO relationship during the last 30 years of the twentieth century coincides with a significant increase of recurrent solar wind streams. A suggested mechanism is

changes in polar nitrous oxide (NO) that affect ozone levels and, hence, atmospheric circulation.

Influences such as volcanic and tropospheric aerosols act simultaneously with other sources of decadal climate variability, including the solar cycle, to alter climate, both directly and indirectly.

Therefore, specifying the solar-related component necessitates reliable understanding and specification of all other sources of decadal climate variability. Recently, it has been suggested that the lack of global warming in the past decade is associated with the behavior of stratospheric aerosols. **Pat Hamill** [San Jose State University] believes stratospheric aerosols (mostly sulfuric acid droplets produced by volcanic eruptions) become trapped by the cold tropopause at altitudes from 15–30 km. These aerosols warm the stratosphere and cool the troposphere and surface, and change the gaseous makeup of the stratosphere through ozone destruction.

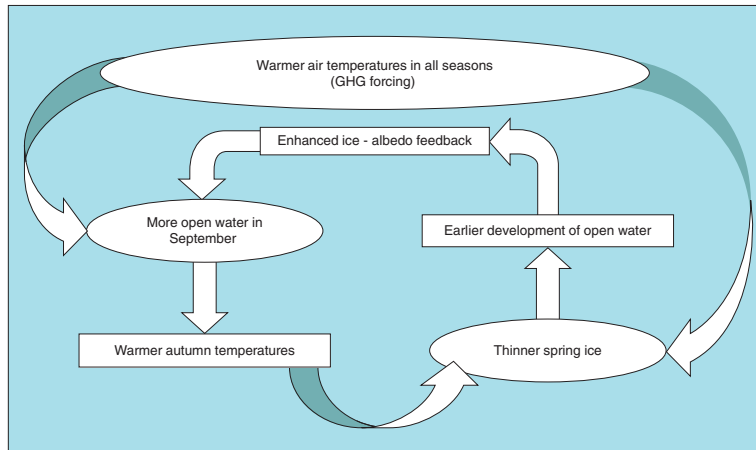

Figure 3: A complex set of interconnected processes lead to the Arctic's rapidly shrinking sea ice cover, according to **Mark Serreze** [NSIDC, CIRES]. Image adapted from Stroeve *et al.*, 2011.

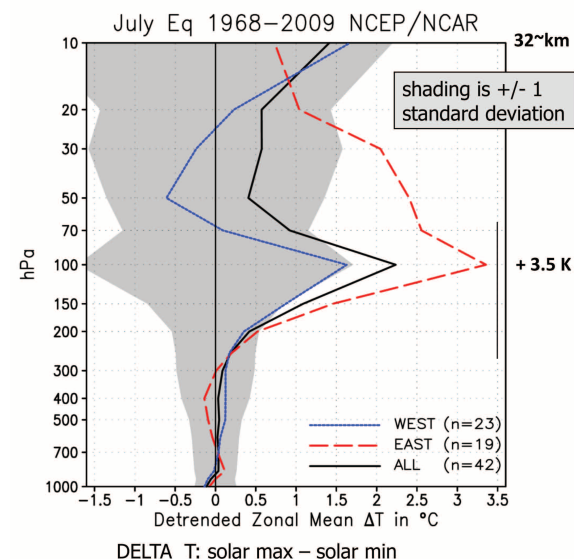

Figure 4: The solar-QBO relationship is shown as a function of altitude. The QBO East has a stronger solar signature according to **Karin Labitzke** [Freie Univ. Berlin]

² EC is shorthand for the European Centre for Medium-Range Weather Forecasts, and HAM is an abbreviation for Hamburg, where the model was developed, and refers to the Hamburg parameterization package.

They also change mean stratospheric winds and, consequently, tropospheric storm tracks; they may also alter the meridional overturning circulation in the Atlantic Ocean. However, current understanding suggests that the volcanic-produced aerosol layer gradually decays, so there is not enough sulfur dioxide (SO₂) nor enough carbonyl sulfide (OCS) to maintain the layer during times of volcanic inactivity.

A crucial aspect of the climate and atmospheric response to solar decadal forcing appears to engage dynamical circulation patterns that respond to the initial radiative forcing. **Lon Hood** [Lunar and Planetary Laboratory, University of Arizona–Tucson], a long-time proponent of this mechanism, reported his latest results. Equatorial ozone is correlated with the solar cycle, but observational evidence from the second Stratospheric Aerosol and Gas Experiment (SAGE II) suggests a stronger-than-expected response in the lower stratosphere. This may be associated with dynamical processes such as a solar-induced weakening of the mean meridional (i.e., Brewer–Dobson) circulation near solar maxima. Such processes are not fully simulated by current models [e.g., Whole Atmosphere Community Climate Model (WACCM)] and likely involve bottom-up processes in addition to the more obvious top-down process. In support of the bottom-up mechanism, Hood showed observational evidence for a solar cycle influence on both sea-level pressure and temperature that may affect the Brewer–Dobson circulation.

Internal variability in the middle atmosphere needs to be fully understood in order to address Sun-climate interactions. **Jae Lee** [JPL] identified a significant anticorrelation between the mesospheric and stratospheric carbon monoxide NAM indices during the winters of 2005–2010, supporting the hypothesis of mesosphere–stratosphere coupling through planetary–gravity wave interactions. Lee used geopotential height (GPH), carbon monoxide (CO), and water vapor (H₂O) data from Aura’s Microwave Limb Sounder (MLS) in her analysis.

While many talks at the meeting focused on solar forcing by electromagnetic radiation, it is not the only mechanism purported to cause decadal climate variability. Identifying the relative roles of the radiative and nonradiative influences is a long-term challenge in Sun-climate research. **Hiroko Miyahara** [University of Tokyo] discussed about how solar field polarity (22-year cycle) and tilt angle have a large impact on galactic cosmic rays (GCRs) that can penetrate deep into the Earth’s atmosphere, especially during times of low solar activity. Positive polarity Solar Cycle 23 has a flatter GCR peak during solar cycle minima, whereas negative polarity cycles have a sharper GCR peak during solar minima. Twenty-seven-day rotational associations are also apparent—topic discussed further in **Session Five**.

The suggestion from the SORCE/SIM observations that the change in solar UV irradiance during the solar cycle may be much larger than suggested by prior observations and models has motivated performing a number of atmospheric simulations to discern the impact of the alleged large UV irradiance changes on the Earth’s atmosphere. **King-Fai Li** (speaking for Shuhui Wang) [JPL] investigated this in his discussion of MLS atmospheric measurements. These hydroxyl (OH) observations at 45 km show a strong seasonal and solar cycle variation. The WACCM model cannot simulate the large observed OH changes using the Lean model of UV irradiance variations; three times more variability is needed. This is consistent with the SIM results. However, the results do present ambiguities, because mesospheric OH changes are controlled by variations in solar Ly- α irradiance, where the SORCE results and the Lean model agree.

Session 3: Comparative Sun-Star Cycles

Comparing the Sun to solar-like stars makes perfect sense in the context of this meeting—after all, it’s practically a requirement that a meeting this close to Lowell Observatory in Flagstaff have such a session! **Richard Radick** [Air Force Research Laboratory, National Solar Observatory] began the session with a keynote talk giving a good overview of stellar photometry measurements for non-astronomers (e.g., solar researchers). Based on observations of numerous Sun-like stars, he reported that solar-type stars show visible-light variability in phase with stellar CaK (chromosphere) activity, consistent with TSI on the Sun, but in contrast to SORCE/SIM results.

Following up, **Wes Lockwood** [Lowell Observatory] gave a humorous history of Lowell Observatory’s stellar photometry and variability measurement program. Lockwood’s group has acquired 18 years of data with their automated photometry program that he is currently analyzing. Similar to Radick’s results, Lockwood’s measurements indicate that the SORCE/SIM anticorrelated visible measurements are not typical of other stars.

Ben Brown [University of Wisconsin, Madison (UWM)] gave a talk on stellar modeling, with a beautifully animated overview of stellar structures and dynamos. His Anelastic Spherical Harmonic simulations capture three-dimensional magnetohydrodynamic (3D MHD) convection very realistically, reproducing how differential rotation drives the dynamo in the convective zone. This model can even restart a dynamo after stopping, helping explain the Sun’s behavior during the Maunder Minimum

Travis Metcalfe [High Altitude Observatory/National Center for Atmospheric Research (HAO/NCAR)]

explained their project of using small ground-based telescopes to perform asteroseismology studies. These data show similar shifts in low-frequency p-modes through stellar activity cycles to those seen in the Sun, obtained by helioseismology. A plot of stellar activity cycle period vs. rotational period using Mt. Wilson data shows bimodal linear correlations, with an active branch representing stars having surface dynamos, and a shallow branch representing those with deep dynamos. Metcalfe pointed out the Sun is directly between these two branches and, therefore, could behave very differently from stellar dynamos.

Tom Ayres [Center for Astrophysics and Space Astronomy, CU] concluded the session with a talk on solar-like stars. He entertainingly summarized that the Sun is not atypical. Using observations of Alpha Centaurus from the Chandra X-Ray Observatory, he demonstrated the importance of good spatial and spectral resolution and broad spectral coverage for understanding stellar variability.

Poster Session

Marty Snow [LASP] introduced a special poster reception by giving an overview of the poster topics. Attendees then had an opportunity to peruse the contributed posters. The table below summarizes the posters that were presented.



Hari Om Vats [Physical Research Laboratory, India] discusses his poster, *Asymmetric Distribution of Solar X-ray Flares*, with **Yvonne Unruh** [Imperial College, UK].

Table. Summary of Poster Presentations.

Topic	Speaker	Institution
Mind the Gap: How Well can SFO Ground-based Photometry Construct Future Missing TSI Measurements?	Angie Cookson	San Fernando Observatory, California State University—Northridge
How Different Did the Solar UV Irradiance Evolve during the Last Solar Cycle?	Thierry Dudok de Wit	CNRS, University of Orléans—France
Online Nowcast and Forecast of the Solar Spectral Irradiance	Thierry Dudok de Wit and Matthie Kretzschmar	CNRS, University of Orléans—France
The TIM-to-WRR Comparison	Wolfgang Finsterle (presented by Werner Schmutz)	Physikalisch-Meteorologisches Observatorium (PMO)/WRC
Solar Spectral Irradiance during Solar Cycle 23 from SPM/VIRGO Observations: An Update	Claus Fröhlich	PMO/WRC
Small Flares Contributing to Total Solar Irradiance Variations	Matthieu Kretzschmar	Royal Observatory of Belgium/CNRS, UO
SORCE Solar Irradiance Data Products and the LASP Interactive Solar Irradiance Data Center (LISIRD)	Doug Lindholm	Laboratory for Atmospheric and Space Physics LASP
Are Solar Irradiance Cycles Linked to the Planetary Oscillations?	Nicola Scafetta	Duke University
Asymmetric Distribution of Solar X-Ray Flares	Hari Om Vats	Physical Research Laboratory—India
Application of a Coupled Ocean-Atmosphere Radiative-Convective Model to Study the Temperature Response in Spectral Solar Variability on Decadal and Centennial Time Scales	Guoyong Wen	GSFC/Morgan State University

Topic	Speaker	Institution
Comparing Irradiance Reconstructions from HMI/SDO Magnetograms with SORCE Observations	Kok Leng Yeo	Max-Planck-Institut für Sonnen-systemforschung—Germany

Session 4: Climate Sensitivity and Global Energy Imbalance

Climate sensitivity—which is generally defined as how much the temperature changes in response to a forcing parameter—is an important part of understanding climate change, and is also key to forecasting future changes. This session included presentations about climate sensitivity, primarily as related to doubling the greenhouse gas, CO₂, as well as presentations about the satellite observations of the top-of-atmosphere energy imbalance, as this imbalance can challenge our understanding of the climate system, and can lead to improved accuracy for climate sensitivity values.

Gerald North [Texas A&M University (TAMU)] kicked off the session with a very educational keynote presentation about climate sensitivity and the history of research on this topic over the past 32 years. Concerning the relationship between climate sensitivity and solar irradiance, he reported that the sensitivity in some energy balance models is about 0.03 °C per 0.1% TSI solar cycle change, and that this has about an 18-month lag. North had a much more detailed discussion about the climate sensitivity to doubling CO₂, starting with the 1979 Charney report that concluded a sensitivity of 1 °C per W/m² with no feedbacks in the analysis, but perhaps up to 4 °C if feedbacks were included. The CO₂ absorption band between 550–750 cm⁻¹ is mainly responsible for the observed 4 W/m² increase in radiative forcing that corresponds to the no-feedback 1 °C per W/m² sensitivity. The more recent results from the Intergovernmental Panel on Climate Change, 4th Assessment Report (IPCC AR4) is that the climate sensitivity is between 1.2–2.7 °C per W/m² from doubling CO₂, which is interestingly consistent with the earlier 1979 Charney report results.

Brian Soden [University of Miami] continued along the same lines as North as he discussed the climate sensitivity to doubling CO₂ with a focus more on the radiative feedback mechanisms. The major feedbacks are temperature, water vapor, cloud, and surface albedo. He noted that the water vapor feedback is mostly at the tropical tropopause, and therefore less sensitive to cloud effects. Cloud feedback can be both positive (high clouds) and negative (low clouds), but globally, clouds provide a small positive feedback.

Andrew Dessler [TAMU] also discussed the effects of radiative feedbacks on climate sensitivity. He used

Clouds and the Earth's Radiant Energy System (CERES) all-sky downward fluxes and *Soden kernels* to examine the linear feedback mechanisms. Dessler pointed out how the temperature is a major negative feedback that stabilizes our atmosphere, and how water vapor provides strong positive feedback. As mentioned in Soden's presentation, clouds and albedo provide small positive feedback; Dessler also noted that the ENSO is a major driver for cloud coverage.

The session discussion then changed pace to focus on a review of the Earth's energy imbalance with an enlightening keynote talk from **Kevin Trenberth** [NCAR]. After an interesting overview of the Climategate issues in which he was involved, Trenberth discussed El Niño and its predictability, ocean heat content, and the 0.9 W/m² energy imbalance at the Earth's surface. While the large El Niño in 1997 had caused a large global temperature increase, the large La Niña in 2008 caused noticeable global cooling. His expectation for this recent cooling and the "missing energy" is related to reductions in ocean energy content since 2005. Trenberth also showed some model runs that would occasionally have extended periods of cooling (like the recent La Niña pattern), but the trend of all of these models still indicates a long-term global warming.

The final two presentations in this session addressed short wave (SW) and long wave (LW) radiation measurements from CERES, given by **Seiji Kato** [NASA Langley Research Center], and the spectral properties and effects of inhomogeneous clouds and aerosols, given by **Peter Pilewskie** [LASP]. Both of these revealed how important clouds and aerosols are in Earth's energy budget.

Session 5: Solar Rotational Variability

Although the focus of this meeting was on the 11-year solar cycle variability, there were several presentations about the 27-day solar rotational variability. In general, rotational variability is smaller than solar cycle variability; however, rotational variability is usually easier to measure more accurately, as any instrumental effects (e.g., long-term degradation) are less important over the shorter time period.

Marty Snow [LASP] started this session by discussing the 27-day solar rotational variability as measured in the UV range from 120–300 nm—see **Figure 5**. He presented results on how the rotational variability is

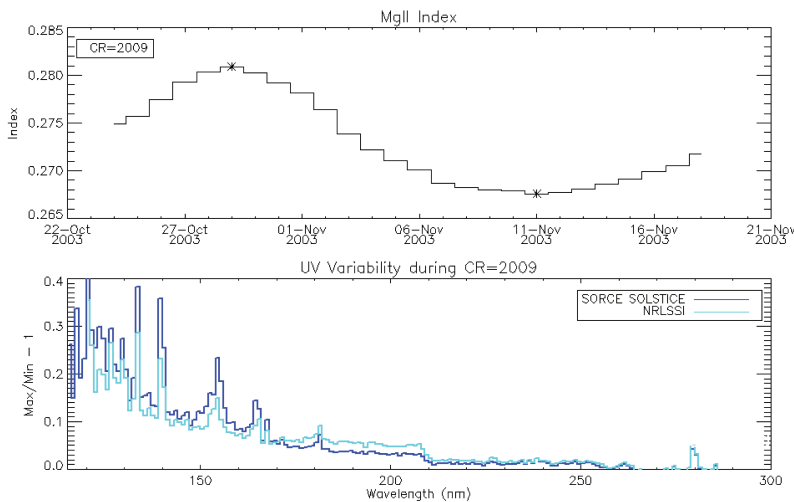

Figure 5: The solar spectral variability is shown for one 27-day solar rotation. Marty Snow [LASP].

larger during times of greater solar activity (i.e., solar cycle maximum) as seen in observations from both the *SORCE* and *UARS* missions. Snow also showed how the Mg II core-to-wing index (near 280 nm) has very consistent solar rotational results over the past two solar cycles.

Matthieu Kretzschmar extended the discussion of solar rotational variability into the visible and near infrared (NIR). He studied the four solar rotations that took place from November 2006–February 2007, using observations from the Scanning Imaging Absorption Spectrometer for Atmospheric CHartography (SCIAMACHY) instrument for his analysis. During the first three solar rotations in this period, sunspot dimming was very dominant in the visible and NIR, but the fourth rotation was dominated by faculae brightening.

Bill Peterson [LASP] then took the discussion to the other end of the spectrum—literally—and discussed the extreme ultraviolet (EUV) variations for September–December 2006. His study focuses on the photoelectrons measured by the Fast Auroral Snapshot Explorer (FAST) satellite. These photoelectrons are generated by the solar EUV, thus providing validation of the various ionospheric models and solar EUV irradiance models. Peterson finds that Phil Chamberlin's Flare Irradiance Spectral Model (FISM) and Stan Solomon's GLOW ionospheric electron transport-energy deposition model compare the best to the FAST photoelectron observations during this period of a few solar rotations.

Hari Om Vats [Physical Research Laboratory—Ahmedabad, India] closed the session, discussing the *differential rotation* of the Sun, i.e., its equator rotates faster than its poles. Vats noted that the differential rotation is not obvious for some years, and that there is also, at times, a north-south asymmetry in the differential rotation.

Session 6: Modeling and Forecasting Solar Cycles and Climate Impacts

Kyle Swanson [UWM] began the final session of the *SORCE* Meeting with a keynote talk on *Climate Regime Shifts*. The global surface temperature record includes episodes of both warming and cooling that can persist for decades. Mathematical tools were used to quantify different climate regimes—see Figure 6—that may shift as a result of, for example, forcings by solar, volcanic and greenhouse gas changes, or from the release of internal stored heat. Multiple forcings can produce somewhat random jumps and shifts in time series.

In addressing the question, *Is the lack of significant climate warming since 2000 a sign of another regime shift?* Swanson explained that part of the difficulty in identifying the causes of climate regime shifts are drifts in the Earth radiation data. CERES SW and LW radiation time series, for example, appear to have biases for the 2000 time frame that make it difficult to evaluate the energy imbalance. SW reflection appears to have a cooling effect, while clear-sky LW emission appears to provide heating (i.e., from a positive feedback, probably caused by increased water vapor). Whatever its causes, the current lull in global surface warming represents an unprecedented opportunity to understand the climate system.

Robert Cahalan [GSFC] showed how using solar cycle changes, as measured by SIM solar spectral irradiance data, produce larger temperature changes in the stratosphere and smaller changes at the Earth's surface and in the ocean. Simulations with a radiative convective

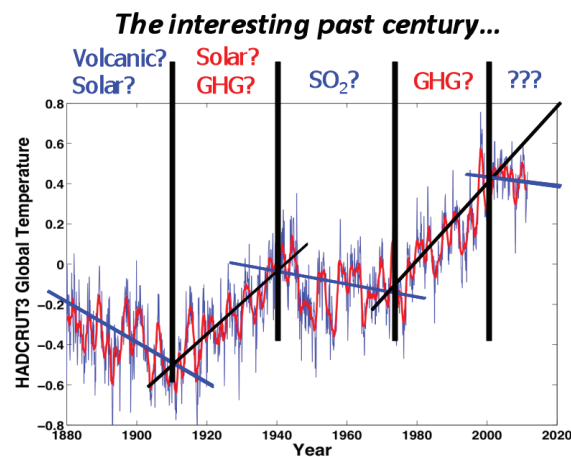

Figure 6: The past century has had some interesting trends in the global surface temperature record. Multi-component forcing can produce trend shifts, some up and some down, as different forcings appear to dominate. Currently, there is an unusually calm period in global surface warming change according to Kyle Swanson [UWM].

climate model indicate that the SIM spectral irradiance changes (which have out of phase variations in the visible spectrum) produce surface warming during solar cycle maxima, but of smaller magnitude than obtained when the visible spectrum varies in phase with the solar cycle. There is an initial fast response in the atmosphere, followed by a much slower ocean response. Variations in atmospheric stability may invoke cloud feedbacks. Future simulations are planned, using the SIM spectral irradiance changes in the Goddard Institute for Space Studies (GISS)/Global Climate-Middle Atmosphere Model (GCMAM).

Bill Swartz [Johns Hopkins University, Applied Physics Laboratory] continued by addressing the responses of atmospheric temperature and ozone levels to the reported SIM solar spectral irradiance variations. He compared results from simulations made using the GSFC Goddard Earth Observing System (GEOS) climate model of atmospheric responses to solar cycle spectral irradiance changes reported by SIM and from the NRL's SSI-based (NRLSSI) model developed by Lean (see earlier summary)—see **Figure 7**. The state-of-the-art GEOS chemistry-climate model accounts for changes in the competing effects of direct solar heating (via ozone absorption of solar middle-UV radiation) and in solar photolysis (via oxygen absorption of solar far-UV radiation and subsequent ozone production). Modeled results for the ozone profile changes are somewhat more consistent with SAGE observations using the NRLSSI model. In general, stratospheric changes in ozone and temperature during the solar cycle lie between the NRLSSI and SIM/SSI model simulations. According to these simulations, the ozone response is fairly linear with solar irradiance scaling.

King-Fai Li [JPL] also reported the results of model simulations using different spectral irradiance scenarios.

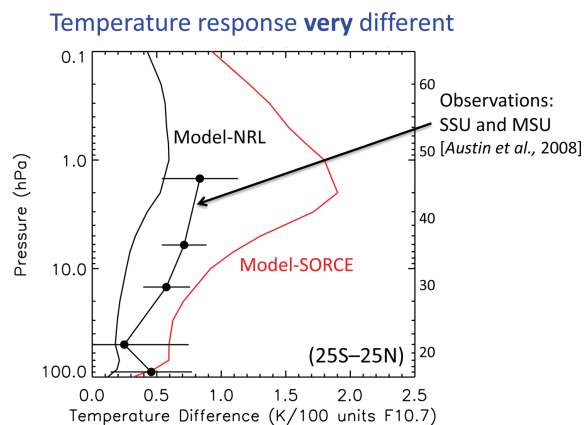

Figure 7: Shown above are solar cycle spectral irradiance changes reported by SORCE/SIM and from the NRLSSI (Judith Lean) model. According to these simulations, the ozone response is fairly linear with solar irradiance scaling while the temperature response is very different according to **Bill Swartz** [JHU/APL].

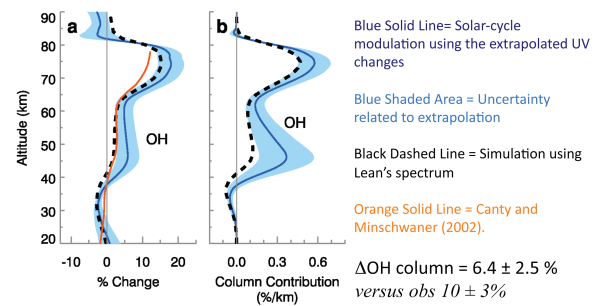

Figure 8: Model simulations using different spectral irradiance scenarios. The solar cycle change in the OH abundance measured by the Aura's Microwave Limb Sounder (MLS) instrument is in agreement with simulations using SORCE/SIM SSI variability per **King-Fai Li** [JPL].

The solar cycle change in the column OH abundance measured by the MLS instrument on the Aura spacecraft is in agreement with simulations that used the SORCE/SIM solar spectral irradiance variability, but is a factor of three larger than is simulated using the NRLSSI model—see **Figure 8**. A caveat for these results is that the observed OH data only cover about half a solar cycle.

Gary Chapman [SFO, CSU] described modeling TSI variations from SORCE/TIM using photometric indices from the SFO, assuming a constant quiet Sun. The indices are obtained as the disk-sums of emissions in ground-based images made at ultraviolet (392-nm) and infrared (672-nm) wavelengths, both having 10-nm passbands. The SFO model is able to reproduce with high fidelity the TSI changes that SORCE/TIM observes ($R=0.970$). According to the SFO model, TSI changed minimally from the 1996 to the 2008 solar minima. The residuals of the SFO TSI model (which extends back to 1988) from TSI observations can provide limits on purported changes in the quiet Sun on longer time scales. The model can also identify and help correct short-term upsets in spacecraft solar irradiance data, and help bridge the different native scales across datasets obtained from different spacecraft.

Nicola Scafetta [Duke University] identified an approximately 60-year oscillation of heating and cooling in Earth's temperature. As Kyle Swanson also pointed out, the observed global surface temperature record has distinct episodes of cooling and warming, the details of which are not captured by climate model simulations, especially before about 1960 and after 2000. Ice cores also show temperature oscillations with a period of 55–76 years and a magnitude of 0.3 °C; a 60-year cycle is also evident in sunspot numbers. Scafetta suggested that the 60-year cycle is due to the Sun's velocity variation relative to the center of mass of the solar system. If less than 90% of the observed surface warming is due to anthropogenic influences (as IPCC assumes), and due instead to natural processes and oscillations, then

Scafetta argued that the IPCC projections for future changes may be unreliable. He further suggested that global surface temperature will not warm significantly, and may even cool slightly, in the twenty-first century.

Judith Lean discussed forecasting climate and ozone changes on multidecadal time scales. She described empirical representations used to reproduce observed variations in climate, atmospheric temperature, and ozone in terms of their known sources of variability. Included in the multiple regression models are solar and volcanic activity, internal oscillations (e.g., ENSO, QBO) and anthropogenic gases (e.g., greenhouse gases and tropospheric aerosols), with the relative influences differing for different atmospheric layers and for ozone and temperature. Assuming that the linear associations captured by these general linear models persist into the near future, Lean presented forecasts for global surface temperature, atmospheric temperature from the surface to the lower stratosphere, and total ozone. The forecasts assume that solar activity would continue its 11-year cycle, with amplitudes similar to those of recent cycles; that anthropogenic greenhouse gases would continue to increase linearly; and that stratospheric chlorine levels would decline. As solar activity increases from 2011–2014, global surface temperature will increase more rapidly than expected from greenhouse gases alone. Should there be a new Maunder Minimum, it would not cause a new Little Ice Age. Even taking into account some recent estimates that during the Maunder Minimum the total irradiance was lower by as much as five times the solar cycle change, the global surface temperature forecast for 2020 would be at levels typical

of the 1980s, not of the Little Ice Age. Global total ozone was predicted to recover to 1980 levels by as early as 2025, after which it would continue to increase, reaching historically high levels by 2100.

Madhulika Guhathakurta [NASA HQ—*Lead Program Scientist for NASA's Living with a Star (LWS) Program*], provided the meeting with a comprehensive update on Heliophysics Research in Living With a Star (LWS), in which she described the current and future fleet of NASA heliophysics missions and ongoing research programs. One of the four LWS strategic goals is to "...deliver the understanding of how and to what degree variations in the solar radiative and particulate output contribute to changes in global and regional climate over a wide range of time scales" and is diagrammed in **Figure 9**. The LWS program supports ongoing Sun-climate research, having recently selected seven new proposals in this area for funding in 2011. At the request of the NASA LWS program, the National Research Council (NRC) convened a panel to evaluate Sun-climate relationships, and held a workshop just prior to this *SORCE* Meeting.

Ken Tapping [Herzberg Institute of Astrophysics—British Columbia] described the next generation in solar radio monitoring. This is a subject of great interest to the meeting attendees because the solar 10.7-cm flux is a crucial index of solar activity, widely used for data analysis and modeling of solar-terrestrial connections. This index has been measured continuously since the late 1940s, is readily available in real-time, and is arguably the most precise and reliable of all available



Figure 9: The NASA Living With a Star program includes this strategic plan to study Sun-climate relationships.

long-term records. All were delighted to learn that a next generation of advanced solar flux monitoring will come online at the Dominion Radio Astrophysical Observatory (DRAO) in Penticton, Canada, in 2013. Observations will be made at a sufficient number of wavelengths for the spectrum of the short- and long-term components to be properly characterized, so as to produce an index of solar activity that is even more relevant for terrestrial applications. The new measurements will preserve or increase the already high precision of the long-term record. The existing F10.7 measurements will continue uninterrupted.

Dominating many discussions by meeting participants at this *SORCE* Science Team meeting was the reality (or not) of the large UV irradiance changes that the *SORCE/SIM* and *SORCE/SOLSTICE* instruments have reported. Motivated by the crucial need of the science community for *SIM* validation, **Peter Pilewskie** [LASP] showed some preliminary results from analyzing *SIM* data for principal components. He identified these components as being the mean value, variability that is unambiguously solar-related, an annual cycle, and significant linear degradation. Noting that a number of talks in the meeting had inferred conclusions about the *SIM* spectral irradiance changes by association of model changes with certain atmospheric time series, Pilewskie emphasized that the *SIM* data must be validated independently of atmospheric models and data. Work is in progress to better understand the principal components of *SIM* variability and to isolate the solar-related signal. Issues of SSI validation during the *SORCE* mission are the topic of a special *SORCE* workshop planned for 2012.

The final talk of the *SORCE* Meeting was, appropriately, about the solar irradiance variations expected during Solar Cycle 24, which has just commenced. In his presentation **Tom Woods** noted the long, low activity minimum between Solar Cycles 23 and 24, and showed that the Sun's polar fields were 40% lower in 2008 than the prior minimum in 1996. Based on observations and models, he concluded that it is possible that TSI was perhaps 200 ppm (0.02%) lower in 2008 than in 1996, but acknowledged the large uncertainty of this result. Since polar magnetic fields during solar minimum are considered to contain the "seeds" of the following activity maximum, this suggests that Solar Cycle 24 will have low-to-moderate activity and a possible peak in 2013.

Meeting Conclusion/Discussion

To conclude the 2011 *SORCE* Science Meeting, Tom Woods came full circle by addressing the key questions that the attendees had hoped to tackle during the previous three-and-a-half days. The meeting explored

and raised several intriguing questions that we hope to answer with the onset of a new solar cycle (SC), with unprecedented new measurement capabilities. These questions, and relevant comments and findings are described below:

1. What can we learn about decadal climate response and climate sensitivity using the SC as a well-specified external radiative forcing?

- Quasi-two-year periods in ocean and atmosphere oscillations (e.g., ENSO, NAO, and QBO) may have a link to solar variations, but in complicated and nonlinear ways. The effects appear more clearly during solar maxima and declining phases of the cycle.
- Both bottom-up (surface/ocean heating) and top-down (UV atmosphere heating) mechanisms contribute to the solar influence on climate.

2. What is the current understanding of the amplitude of solar spectral variability and the response of the Earth's atmosphere and climate system?

- Short-term (27-day rotation) SSI variability is understood well, however there is much to do towards resolving differences between measurements and models regarding long-term variability. There is a SSI Validation Workshop in the planning stages for 2012.

3. How does TSI vary over the SC, and what are the implications for climate modeling from recent refinements in its magnitude?

- There has been great progress in resolving TSI level differences. With the new instrument characterizations at LASP's TRF, the accepted value for the TSI is now the lower TSI value from *SORCE* TIM observations.
- TSI variations clearly include sunspot-darkening and faculae-brightening components, and perhaps a longer-term component.

4. How do comparisons with Sun-like stars improve our understanding of solar variability?

- The Sun appears to be much like other older G-class stars in some ways, and yet it appears unique in many other respects.
- Stellar dynamo modeling is in a new phase of providing dazzling results from high-end computing; yet solar dynamo and solar cycle predictions are elusive.

5. How can solar and climate models be advanced to better reproduce decadal variability and improve forecast capabilities?

- A better understanding of the complex climate system is expected to lead to improved forecast accuracy.
- Some of the challenges are related to the large uncertainties in the roles and effects of clouds and aerosols, and energy imbalances and the so-called “missing energy.”
- The recent solar cycle minimum in 2008-2009 challenges Maunder Minimum results.

Lowell Observatory – SORCE Science Dinner and Field Trip

The SORCE Science Dinner was held at the Lowell Observatory in nearby Flagstaff, AZ. After a ride up beautiful Oak Creek Canyon, attendees toured the Lowell Observatory and learned about the research contributions of one of the major astronomical research facilities in the U.S. Using ground-based, airborne, and space-based telescopes, Lowell Observatory plays in an important role in the advancement of astronomy and our knowledge of the solar system and beyond. Following a wonderful dinner, the group was fortunate to have clear evening skies to do some stargazing with Lowell’s historic Clark Telescope.



SORCE attendees enjoyed a field trip and special dinner at the Lowell Observatory in Flagstaff, AZ. Everyone was invited to use the Clark Telescope, shown in the background, after dark when the skies cleared up for perfect viewing.

The SORCE team extends a warm thanks to all participants for making this meeting another success. Future plans are to meet again in Fall 2013 to examine the Solar Cycle 24 maximum—was it as low as predicted and how did the climate respond? As new meeting information becomes available, it will be posted to the SORCE Science Meetings website: lasp.colorado.edu/sorce/meetings.html. ■



NASA Launches Multi-Talented Earth-Observing Satellite

Steve Cole, NASA Headquarters, stephen.e.cole@nasa.gov

David Weaver, NASA Headquarters, david.s.weaver@nasa.gov

George H. Diller, NASA's Kennedy Space Center, george.h.diller@nasa.gov

Cynthia O'Carroll, NASA's Goddard Space Flight Center, cynthia.m.ocarroll@nasa.gov

On October 28, 2011, NASA's newest Earth-observing satellite soared into space aboard a Delta II rocket after liftoff at 5:48 a.m. EDT from Space Launch Complex 2 at Vandenberg Air Force Base.

NASA's National Polar-orbiting Operational Environmental Satellite System Preparatory Project (NPP) successfully separated from the Delta II 58 minutes after launch, and the first signal was acquired on schedule by the Tracking and Data Relay Satellite System. NPP's solar array deployed 67 minutes after launch to provide the satellite with electrical power. NPP is on course to reach its sun-synchronous polar orbit 512 mi (824 km) above Earth.

"NPP is critical to our understanding of Earth's processes and changes," said NASA Deputy Administrator **Lori Garver**. "Its impact will be global and builds on 40 years of work to understand our complex planet from space. NPP is part of an extremely strong slate of current and future innovative NASA science missions that will help us win the future as we make new discoveries."

NPP carries five science instruments, including four new state-of-the-art sensors that will provide critical data to help scientists understand the dynamics of long-term climate patterns and help meteorologists improve short-

term weather forecasts. The mission will extend more than 30 key long-term datasets NASA has been tracking, including measurements of the ozone layer, land cover, and ice cover.

NPP serves as a bridge mission between NASA's Earth Observing System (EOS) of satellites and the next-generation Joint Polar Satellite System, a National Oceanic and Atmospheric Administration (NOAA) program that will also collect weather and climate data.

Scientists will use NPP data to extend and improve upon EOS data records. These satellites have provided critical insights into the dynamics of the entire Earth system, including clouds, oceans, vegetation, ice, solid Earth, and atmosphere. NPP will allow scientists to extend the continuous satellite record needed to detect and quantify global environmental changes.

"The measurements from NPP will benefit science and society for many years to come," said **Michael Freilich**, Director of NASA's Earth Science Division. "NPP will help improve weather forecasts, enable unique scientific insights, and allow more accurate global environmental predictions. I'm confident that the strong partnerships forged in the NPP program between NASA and NOAA, industry, and the research and applications communities will ensure the success of the mission."



As the Sun peaks over the horizon at Vandenberg Air Force Base, the Delta II rocket with its NPOESS Preparatory Project (NPP) spacecraft payload stands ready for launch. This photo was taken shortly after the service structure was rolled back on Thursday, October 27, 2011. NPP is the first NASA satellite mission to address the challenge of acquiring a wide range of land, ocean, and atmospheric measurements for Earth system science while simultaneously preparing to address operational requirements for weather forecasting. **Image credit:** NASA/Bill Ingalls

Watching the Birth of an Iceberg

Patrick Lynch, NASA Goddard Space Flight Center, patrick.lynch@nasa.gov

After discovering an emerging crack that cuts across the floating ice shelf of Pine Island Glacier in Antarctica, NASA's Operation IceBridge has flown a follow-up mission and made the first-ever detailed airborne measurements of a major iceberg calving in progress.

NASA's Operation IceBridge, the largest airborne survey of Earth's polar ice ever flown, is in the midst of its third field campaign from Punta Arenas, Chile. The six-year mission will yield an unprecedented three-dimensional view of Arctic and Antarctic ice sheets, ice shelves and sea ice.

Pine Island Glacier last calved a significant iceberg in 2001, and some scientists have speculated recently that it was primed to calve again. But until an October 14, 2011 IceBridge flight of NASA's DC-8, no one had seen any evidence of the ice shelf beginning to break apart. Since then, a more detailed look back at satellite imagery seems to show the first signs of the crack in early October.

While Pine Island has scientists' attention because it is both big and unstable—scientists call it the largest source of uncertainty in global sea level rise projections—the calving underway now is part of a natural process for a glacier that terminates in open water. Gravity pulls the ice in the glacier westward along Antarctica's Hudson Mountains toward the Amundsen Sea. A floating tongue of ice reaches out 30 mi (48.3 km) into the Amundsen beyond the grounding line, the below-sea-level point where the ice shelf locks onto the continental bedrock. As ice pushes toward the sea from the interior, inevitably the ice shelf will crack and send a large iceberg free.

"We are actually now witnessing how it happens and it's very exciting for us," said IceBridge project scientist **Michael Studinger**, Goddard Space Flight Center (GSFC). "It's part of a natural process but it's pretty exciting to be here and actually observe it while it happens. To my knowledge, no one has flown a lidar instrument over an actively developing rift such as this."

A primary goal of Operation IceBridge is to put the same instruments over the exact same flight lines and

satellite tracks, year after year, to gather meaningful and accurate data of how ice sheets and glaciers are changing over time. But discovering a developing rift in one of the most significant science targets in the world of glaciology offered a brief change in agenda for the October 26 flight, if only for a 30-minute diversion from the day's prescribed flight lines.

The IceBridge team observed the rift running across the ice shelf for about 18 mi (29 km). The lidar instrument on the DC-8, the Airborne Topographic Mapper, measured the rift's shoulders about 820 ft (250 m) apart at its widest, although the rift stretched about 260 ft wide along most of the crack. The deepest points from the ice

shelf surface ranged 165–195 ft (50–60 km). When the iceberg breaks free it will cover about 340 mi² (880 km²) of surface area. Radar measurements suggested the ice shelf in the region of the rift is about 1,640 ft (500 m) thick, with only about 160 ft (48.8 m) of that floating above water and the rest submerged. It is likely that once the iceberg floats away, the leading edge of the ice shelf will

have receded farther than at any time since its location was first recorded in the 1940s.

Veteran DC-8 pilot **Bill Brockett** first flew the day's designed mission, crisscrossing the flow of the glacier near the grounding line to gather data on its elevation, topography and thickness. When it came time to investigate the crack, Brockett flew across it before turning to fly along the rift by sight. The ATM makes its precision topography maps with a laser that scans 360° 20 times per second, while firing 3,000 laser pulses per second. When flying at an altitude of 3000 ft (914.4 m), as during this flight, it measures a swath of the surface about 1500 ft (457.2 m) wide. As the crack measured at more than 800 ft (243.8 m) wide in places, it was important for Brockett to hold tight over the crevasse.

"The pilots did a really nice job of keeping the aircraft and our ATM scan swath pretty much centered over the rift as you flew from one end to the other," said **Jim Yungel**, who leads the ATM team out of NASA's

continued on page 51



A crack runs across the floating ice shelf of Pine Island Glacier in Antarctica, seen from NASA's DC-8 on October 14, 2011. Image credit: Michael Studinger/NASA

NASA–NOAA Data Show Significant Antarctic Ozone Hole Remains

Steve Cole, NASA Headquarters, stephen.e.cole@nasa.gov

Patrick Lynch, NASA's Goddard Space Flight Center, patrick.lynch@nasa.gov

The Antarctic ozone hole, which yawns wide every Southern Hemisphere spring, reached its annual peak on September 12. It stretched to 10.05 million mi² (26.03 million km²), the ninth largest ozone hole on record. Above the South Pole, the ozone hole reached its deepest point of the season on October 9, tying this year for the tenth lowest in this 26-year record.

NASA and the National Oceanic and Atmospheric Administration (NOAA) use balloon-borne instruments, ground-based instruments and satellites to monitor the annual Antarctic ozone hole, global levels of ozone in the stratosphere, and the manmade chemicals that contribute to ozone depletion.

“The colder-than-average temperatures in the stratosphere this year caused a larger-than-average ozone hole,” said **Paul Newman**, chief scientist for atmospheres at NASA's Goddard Space Flight Center. “Even though it was relatively large, the area of this year's ozone hole was within the range we'd expect given the levels of manmade ozone-depleting chemicals that continue to persist in the atmosphere.”

The ozone layer helps protect the planet's surface from harmful ultraviolet radiation. Ozone depletion results in more incoming radiation that can hit the surface, elevating the risk of skin cancer and other harmful effects.

“The manmade chemicals known to destroy ozone are slowly declining because of international action, but there are still large amounts of these chemicals doing damage,” said **James Butler**, director of NOAA's Global Monitoring Division.

In the Antarctic spring (August and September) the sun begins rising again after several months of darkness and

polar-circling winds keep cold air trapped above the continent. Sunlight-sparked reactions involving ice clouds and manmade chemicals begin eating away at the ozone. Most years, the conditions for ozone depletion ease before early December when the seasonal hole closes.

Levels of most ozone-depleting chemicals in the atmosphere have been gradually declining as the result of the 1987 Montreal Protocol, an international treaty to protect the ozone layer. That international treaty caused the phase-out of ozone-depleting chemicals, which had been used widely in refrigeration, as solvents and in aerosol spray cans.

However, most of those chemicals remain in the atmosphere for decades. Global atmospheric computer models predict that stratospheric ozone could recover by midcentury, but the ozone hole in the Antarctic will likely persist one to two decades longer, according to the latest analysis in the 2010 Quadrennial Ozone Assessment issued by the World Meteorological Organization and United Nations Environment Programme, with co-authors from NASA and NOAA.

NASA currently measures ozone in the stratosphere with the Dutch-Finnish Ozone Monitoring Instrument, or OMI, aboard the Aura satellite. OMI continues a NASA legacy of monitoring the ozone layer from space that dates back to 1972 with launch of the Nimbus-4 satellite. The instrument measured the 2011 ozone hole at its deepest at 95 Dobson units on October 8 this year. This differs slightly from NOAA's balloon-borne ozone observations from the South Pole (102 Dobson units) because OMI measures ozone across the entire Antarctic region.

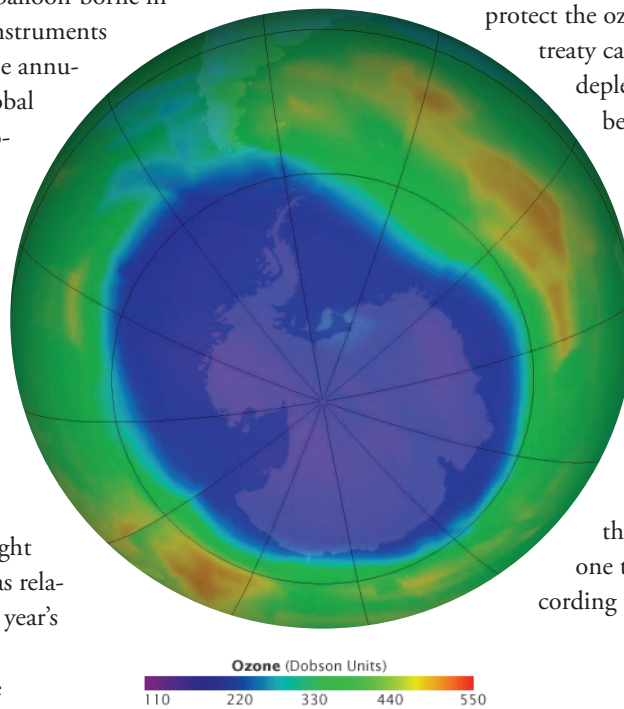

This image shows the extent, or geographic area, of the ozone hole at its widest on September 12, 2011, when it stretched 10.05 million mi² (26.03 million km²). The lowest concentration of ozone in the southern stratosphere—that is, the deepest “hole”—occurred on October 9, 2011, when levels descended to 95 Dobson units. **Image credit:** NASA Ozone Watch

That satellite-monitoring legacy will continue with the launch of NASA's National Polar-orbiting Operational Environmental Satellite System Preparatory Project, known as NPP, on October 28. The satellite will carry a new ozone-monitoring instrument, the Ozone Mapping and Profiler Suite. The instruments will provide more detailed daily, global ozone measurements than ever before to continue observing the ozone layer's gradual recovery.

It will take a few years of averaging yearly lows in Antarctic ozone to discern evidence of recovery in ozone

levels because seasonal cycles and other variable natural factors—from the temperature of the atmosphere to the stability of atmospheric layers—can make ozone levels dip and soar from day to day and year to year.

NOAA has been tracking ozone depletion around the globe, including the South Pole, from several perspectives. NOAA researchers have used balloons to loft instruments 18 mi (~29 km) into the atmosphere for more than 24 years to collect detailed profiles of ozone levels from the surface up. NOAA also tracks ozone with ground-based instruments and from space. ■

NASA Launches Multi-Talented Earth-Observing Satellite

Continued from page 48

The satellite will be operated from the NOAA Satellite Operations Facility in Suitland, MD. NASA will operate NPP for the first three months after launch while the satellite and instrument are checked out. NPP operations will then be turned over to NOAA and the JPSS program for the remainder of the mission.

NPP data will be transmitted once every orbit to a ground station in Svalbard, Norway, and to direct broadcast receivers around the world. The data will be sent back to the U.S. via fiber optic cable to the NOAA Suitland facility. NPP data are then processed into data records that NASA and NOAA will make available through various data archives.

The Delta II launch vehicle that delivered NPP into orbit also deployed auxiliary payloads within 98 minutes after launch. The five small "CubeSat" research payloads are the third in a series of NASA Educational Launch of Nanosatellite (ELaNa) missions.

The NPP mission is managed by NASA's Goddard Space Flight Center, for the Earth Science Division of the Science Mission Directorate at NASA Headquarters. The JPSS program provides the NPP ground system. NOAA will provide operational support for the mission. Launch management is the responsibility of the NASA Launch Services Program at the Kennedy Space Center.

For more information about NPP, visit: www.nasa.gov/npp

For more information about the ELaNa III mission, visit: go.nasa.gov/tgbuVn ■

Watching the Birth of an Iceberg

Continued from page 49

Wallops Island Flight Facility in Virginia. "It was a real challenge to be told...we're going to attempt to fly along it and let's see if your lidar systems can map that crack and can map the bottom of the crack.

"And it was a lot of fun on a personal level to see if something that you built over the years can actually do a job like that. So, yeah, I enjoyed it. I really enjoyed seeing the results being produced."

While the ATM provided the most detailed measurements of the topography of the rift, other instruments

onboard the DC-8 also captured unique aspects. The Digital Mapping System, a nadir-view camera, gathered high-definition close-ups of the craggy split. On the flight perpendicular to the crack, the McCORDS radar also measured its depth and the thickness of the ice shelf in that region.

Catching the rift in action required a bit of luck, but is also testimony to the science benefit of consistent, repeated trips and the flexibility of a manned mission in the field.

"A lot of times when you're in science, you don't get a chance to catch the big stories as they happen because you're not there at the right place at the right time," said **John Sonntag**, Instrument Team Lead for Operation IceBridge, based at GSFC. "But this time we were." ■

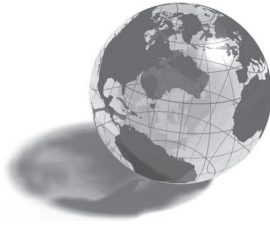

NASA Earth Science in the News

Patrick Lynch, NASA's Earth Science News Team, patrick.lynch@nasa.gov

Russian Wildfires and Pakistan Floods Were Caused By The Same Weather Event Even Though They Are 1,500 Miles Apart, says NASA, September 2; *The Daily Mail*. The rampant wildfires in Russia and torrential flooding in Pakistan in the summer of 2010 were caused by the same, persistent omega-shaped blocking high, according to new research by **William Lau** [NASA's Goddard Space Flight Center (GSFC)].

Aquarius Satellite Comes of Age, September 23; *BBC News*. NASA's Jet Propulsion Laboratory (JPL) and GSFC have released the first global map of ocean surface salinity acquired by the Aquarius/Satellite de Aplicaciones Cientificas-D (SAC-D) satellite, launched in June this year. Knowing the saltiness of seawater will improve scientists' understanding of some key climatic processes.

Climate Change Eradicating Arctic's Oldest Ice, October 5; *The Vancouver Sun*. NASA and the National Snow and Ice Data Center (NSIDC) announced that the September 2011 Arctic sea ice minimum was the second lowest on record. "The sea ice is not only declining, the pace of the decline is becoming

more drastic," said **Joey Comiso** [GSFC]. "The older, thicker ice is declining faster than the rest, making for a more vulnerable perennial ice cover."

***Arctic Ozone Layer Fell to an Unprecedented Low in 2011**, October 5; *Los Angeles Times*. NASA scientists published a study reporting that the ozone layer over the Arctic fell to unprecedentedly low levels over the winter and spring of 2011. Of course, back in the '80s, the concern was about the ozone hole over Antarctica, but still...we all stopped using that CFC-spewing hairspray decades ago. Shouldn't this be over by now? According to atmospheric scientists **Michelle Santee** [JPL] and **Nathaniel Livesey** [JPL], two of the co-authors of the new study, the answer is no.

***New NASA Satellite to Monitor Earth's Weather & Climate**, October 12; *Space.com*; NASA's National Polar-orbiting Operational Environmental Satellite System Preparatory Project (NPP) is designed to collect critical data to improve weather forecasts in the short-term and increase our understanding of long-term climate change. "NPP's observations of a wide range of interconnected Earth properties and processes will

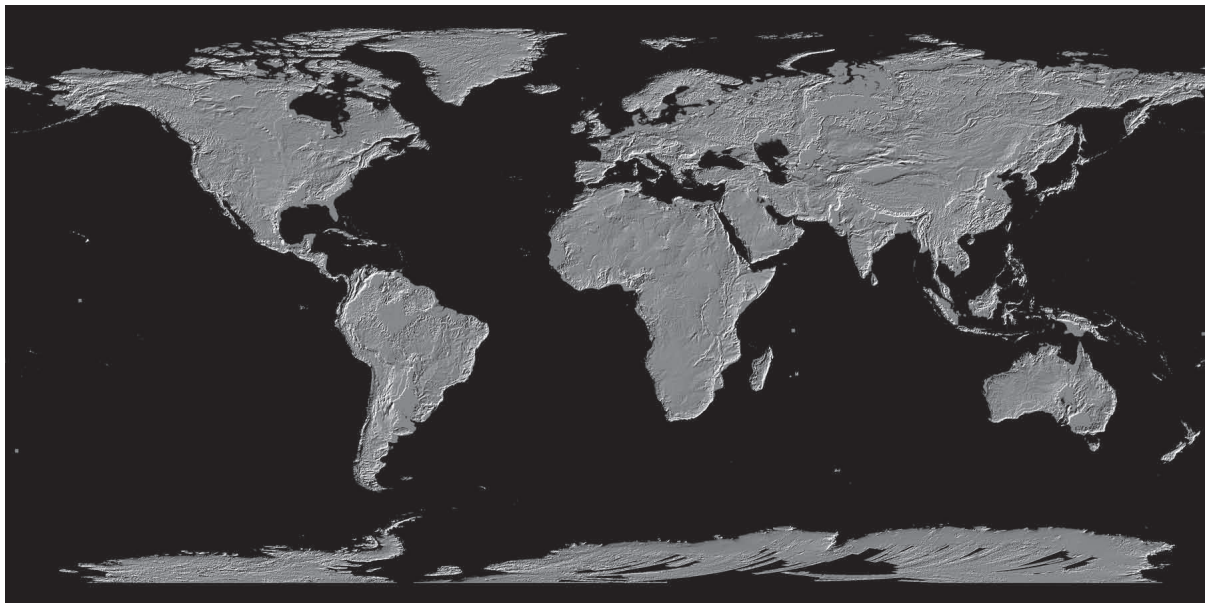

NASA releases the most complete topographic map ever! Data from the Advanced Spaceborne Thermal Emission and Reflection Radiometer (ASTER) Global Digital Elevation Model.

give us the big picture of how our planet changes,” said **Jim Gleason** [GSFC—*NPP Project Scientist*]. NPP was launched on October 28.

***NASA Continues Critical Survey of Antarctica’s Changing Ice**, October 13; *Physorg.com*; NASA’s Operation IceBridge mission comprises the largest airborne research campaign ever flown over Earth’s polar region. The mission is designed to continue critical ice sheet measurements in a period between active satellite missions and to help scientists understand how much the major ice sheets of Greenland and Antarctica could contribute to sea-level rise. “With a third year of data-gathering underway, we are starting to build our own record of change,” said **Michael Studinger** [GSFC—*IceBridge Project Scientist*].

Best-Ever Topographic Map of Earth Released, October 17; *MSNBC.com*. NASA has released the most complete digital topographic map ever made of

the Earth—map shown on page 52. Known as a global digital elevation model, the map was created from images collected by the Japanese Advanced Spaceborne Thermal Emission and Reflection Radiometer, or ASTER, instrument aboard NASA’s Terra satellite. “These data can be used for a broad range of applications, from planning highways and protecting lands with cultural or environmental significance, to searching for natural resources,” said **Mike Abrams** [JPL—*ASTER Science Team Leader*].

* See news story in this issue for more details.

*Interested in getting your research out to the general public, educators, and the scientific community? Please contact **Patrick Lynch** on NASA’s Earth Science News Team at patrick.lynch@nasa.gov and let him know of your upcoming journal articles, new satellite images, or conference presentations that you think the average person would be interested in learning about. ■*

Immerse Yourself in NASA Science at the 2011 Fall AGU Meeting

Please plan to visit the NASA booth (# 1637) during this year’s American Geophysical Union (AGU) Fall Meeting! Throughout the week we will be showing a variety of our NASA Science data images in vibrant, high-definition color on the *hyperwall*—a dynamic, nine-screen display that will serve as the centerpiece of our exhibit.

The hyperwall will also be used in a variety of individual presentations to help illustrate phenomena, ideas, and examples of world change. There will also be a wide range of other science presentations, demonstrations, printed material, and tutorials on various data tools and services at the booth.

This year’s exhibit hall will open on Tuesday, December 6, and will continue through Friday, December 9. There are several different programs and missions scheduled to participate; representatives from Dryden, Ames, Jet Propulsion Laboratory, Goddard, Langley, and Wallops are expected.

Presentations will cover a diverse range of research topics, science disciplines, and programs within NASA’s Science Mission Directorate. Learn about new and upcoming missions like Aquarius, NPOESS Preparatory Project (NPP), Global Precipitation Measurement (GPM), the Gravity Recovery and Interior Laboratory (GRAIL), Juno, Mars Science Laboratory Curiosity Rover, and others.

A daily agenda will be posted on the Earth Observing System Project Science Office website—eos.nasa.gov—in late November.

We hope to see you in San Francisco!

announcement

NASA earth science in the news

NASA Science Mission Directorate – Science Education and Public Outreach Update

Theresa Schwerin, *Institute of Global Environment and Society (IGES)*, theresa_schwerin@strategies.org

Morgan Woroner, *Institute of Global Environment and Society (IGES)*, morgan_woroner@strategies.org

NASA Earth and Space Science Fellowship Program for Graduate Students

Deadline for new applicants—February 1; for renewal applicants—March 15.

NASA announces a call for graduate fellowship proposals to the NASA Earth and Space Science Fellowship (NESSF) program for the 2012-2013 academic year. The purpose of the NESSF is to ensure continued training of a highly qualified workforce in disciplines needed to achieve NASA's scientific goals. Awards resulting from the competitive selection will be made in the form of training grants to the respective universities. This call for fellowship proposals solicits applications from accredited U.S. universities on behalf of individuals pursuing Master of Science or Doctoral degrees in Earth and space science, or related disciplines.

The NESSF call for proposals and submission instructions are located at the NESSF 12 solicitation index page at nspires.nasaprs.com/. Click on "Solicitations," then select "Open Solicitation." Select "NESSF 12" announcement. Please also refer to "Proposal Submission Instructions" and "Frequently Asked Questions," listed under "Other Documents" on the NESSF 12 solicitation index page.

Please note that the advisor has an active role in the submission of the fellowship proposal, and all proposals must be submitted in electronic format only through the NASA NSPIRES system. To use the system, the advisor, the student, and the university must all register. Extended instructions on how to submit an electronic proposal package are posted on the NESSF 12 solicitation index page listed above. You can register in NSPIRES at nspires.nasaprs.com.

GLOBE Scientists' Blog

Read the Scientists' Blog to keep informed of timely topics in Earth Systems Science. Updated weekly, the blog is an online journal where the GLOBE scientists post their thoughts, comments, and philosophies about a variety of science topics. The blog provides students the opportunity to share comments and discuss topics with each other. Comments are moderated, so no anonymous comments are allowed. To read the blog, visit: blog.globe.gov/sciblog/.

Applications Being Accepted for Einstein Fellowship Program for K-12 STEM Educators

Applications due January 5

Applications are now being accepted for the 2012 Albert Einstein Distinguished Educator Fellowship program. The goal of the Einstein Fellowship program is to provide an opportunity for teachers to inform national policy and improve communication between the K-12 STEM education community and national leaders. If selected, Einstein Fellows spend a school year in Washington, DC, sharing their expertise as a fellow in one of several government agency offices, such as the Department of Energy, NASA, the National Science Foundation, the National Oceanic and Atmospheric Administration, or in the office of a member of Congress.

Selection is based on exemplary experience in K-12 STEM teaching; demonstrated leadership in the community; an understanding of national, state, and local education policy; and communication and interpersonal skills. During the Fellowship, each Einstein Fellow receives a monthly stipend of \$6000, plus a \$1000 cost of living allowance. In addition, there is a moving/relocation allowance, as well as a professional travel allowance. To learn more about the program and to apply, visit: www.trianglecoalition.org/einstein-fellows.

Workshop: Understanding K-12 Science Learning Goals

November 30–December 2; Washington, DC

Participants will work with a variety of tools—from strand maps in the *Atlas of Science Literacy* to state standards and the new conceptual framework for science education recently released by the National Research Council—to explore the knowledge and skills students are expected to have at each grade level and to try out new strategies for aligning classroom instruction, curriculum materials, and assessment with science learning goals. The workshop is suited for K-12 science and mathematics educators, administrators and curriculum specialists; informal science educators; teacher education faculty; education researchers; and curriculum and assessment developers. Workshop participants will receive a Certificate of Completion from AAAS Project 2061. For teams, the registration fee is \$400/person. Individuals may register for \$450. For more information and to register, visit: www.project2061.org/events/workshops/LearningGoalsWorkshop.htm. ■

EOS Science Calendar | Global Change Calendar

May 1–3, 2012

CERES Science Team Meeting, Newport News, VA.
URL: science.larc.nasa.gov/ceres

September 17–21, 2012

GRACE Science Team Meeting, Potsdam, Germany.
URL: www.csr.utexas.edu/grace/GSTM/

October 1–3, 2012

Aura Science Team Meeting, Pasadena, CA

October 16–18, 2012

HyspIRI Workshop, Pasadena CA.
URL: hyspiri.jpl.nasa.gov/events/2012-hyspiri-workshop

December 5–9, 2011

American Geophysical Union Fall Meeting, San Francisco, CA. URL: www.agu.org/meetings/

January 22–26, 2012

American Meteorological Society 92nd Annual Meeting, New Orleans, LA. URL: annual.ametsoc.org/2012/

February 16–20, 2012

AAAS Annual Meeting, Vancouver, Canada.
URL: www.aaas.org/meetings/2012/

February 20–24, 2012

2012 Ocean Sciences Meeting, Salt Lake City, UT.
URL: www.sgmeet.com/osm2012/

March 19–23, 2012

ASPRS 2012 Annual Conference, Imaging and Geospatial Technologies—Into the Future, Sacramento, CA.
URL: www.asprs.org/Annual-Conferences/Sacramento-2012/

March 26–29, 2012

Planet Under Pressure 2012, London, England.
URL: www.planetunderpressure2012.net/location.asp

May 7–11, 2012

The 44th International Liège Colloquium on Ocean Dynamics, Liège, Belgium. URL: modb.oce.ulg.ac.be/colloquium/

August 6–10, 2012

2012 International Radiation Symposium: Current Problems in Atmospheric Radiation, Berlin, Germany.
URL: www.irs2012.org

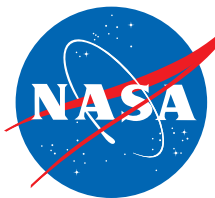

Code 610
National Aeronautics and Space Administration

Goddard Space Flight Center
Greenbelt, MD 20771

PRSRT STD
Postage and Fees Paid
National Aeronautics and Space Administration
Permit 396

Official Business
Penalty for Private Use: \$300

(affix mailing label here)

eos.nasa.gov

The Earth Observer

The Earth Observer is published by the EOS Project Science Office, Code 610, NASA Goddard Space Flight Center, Greenbelt, Maryland 20771, telephone (301) 614-5561, FAX (301) 614-6530, and is available in color on the World Wide Web at eos.gsfc.nasa.gov/eos_homepage/for_scientists/earth_observer.php. Black and white hard copies can be obtained by writing to the above address. Articles, contributions to the meeting calendar, and suggestions are welcomed. Contributions to the calendars should contain location, person to contact, telephone number, and e-mail address.

To subscribe to *The Earth Observer*, or to change your mailing address, please call Steve Graham at (301) 614-5561, or send a message to Steve.Graham@nasa.gov, or write to the address above. If you would like to stop receiving a hard copy and be notified via email when future issues of *The Earth Observer* are available for download as a PDF, please send an email with the subject **"Go Green"** to Steve.Graham@nasa.gov. Your name and email address will then be added to an electronic distribution list and you will receive a bi-monthly email indicating that the next issue is available for download. If you change your mind, the email notification will provide an option for returning to the printed version.

The Earth Observer Staff

Executive Editor: Alan Ward (alan.b.ward@nasa.gov)
Assistant Editors: Heather Hyre (heather.r.hyre@nasa.gov)
Mitchell K. Hobish (mkh@sciential.com)
Technical Editor: Tim Suttles (4suttles@bellsouth.net)
Design, Production: Deborah McLean (deborah.f.mclean@nasa.gov)



Printed on Recycled Paper